

# *Tekelec EAGLE<sup>®</sup> 5*

## *Integrated Signaling System*

---

Release 41.1

### Commands Manual

910-5772-001 Rev B

December 2009



# TEKELEC

Copyright 2009 Tekelec. All Rights Reserved. Printed in USA.

Legal Information can be accessed from the Main Menu of the optical disc or on the Tekelec Customer Support web site in the *Legal Information* folder of the *Product Support* tab.

# Table of Contents

## Chapter 1. Introduction

Overview.....	1-1
Where to Find Information in This Manual.....	1-2
Scope and Audience.....	1-3
Related Publications.....	1-3
Customer Care Center.....	1-3
Documentation Packaging, Delivery, and Updates.....	1-5
Documentation Admonishments.....	1-6
Locate Product Documentation on the Customer Support Site on the Customer Support Site.....	1-6

## Chapter 2. Alphabetical List of Commands

## Chapter 3. Commands Listed by Class

## Chapter 4. Using Commands

Introduction.....	4-1
Maintenance and Administration Subsystem.....	4-1
Legacy Control Cards.....	4-1
General Purpose Service Module II (GPSM-II) Card.....	4-2
Terminal Disk Module (TDM) Card.....	4-2
Maintenance Disk and Alarm (MDAL) Card.....	4-2
E5-based Control Cards.....	4-2
Maintenance Communication Application Processor (E5- MCAP) Card .....	4-2
Terminal Disk Module (E5-TDM) Card.....	4-3
Maintenance Disk and Alarm (E5-MDAL) Card.....	4-3
Input/Output Devices .....	4-3
Terminals and Printers.....	4-3
Terminal and Printer Connections.....	4-5
KSR Function on VT320 Terminal Devices.....	4-5
KSR Configuration.....	4-5
Changing the Mode Of Operation.....	4-5
Requirements.....	4-6
Telnet Terminals.....	4-6
SEAS Terminals.....	4-8
Element Management System Alarm Monitor Terminals.....	4-8
About Commands.....	4-9
Entering Commands.....	4-9
Action Commands.....	4-9
Command Keywords and Parameters .....	4-10
Keyboard Functions.....	4-11
Arrow Key Operation.....	4-13

Up Arrow Key.....	4-13
Down Arrow Key.....	4-14
Right Arrow Key.....	4-14
Left Arrow Key.....	4-14
Command Output and Messages.....	4-15
Command Output Banners.....	4-16
System Security.....	4-17
Rules for User ID and Password Administration.....	4-17
Command Classes.....	4-18
Login Security Checks.....	4-18
Intrusion Alert.....	4-18
Login Procedure.....	4-19
Login Error Messages.....	4-22
Logout Procedure .....	4-23

## **Chapter 5. Commands**

## **Chapter 6. Debug Commands**

## **Chapter 7. Pass-Through Commands**

Introduction.....	7-1
Command Conventions.....	7-1

## **Appendix A. Reference Information**

Summary of Range Values for :link Parameter.....	A-1
Possible Values for PST/SST/AST.....	A-3
PST.....	A-3
SST.....	A-3
AST.....	A-4
Point Code Formats and Conversion.....	A-5
ANSI Point Codes.....	A-5
ITU International Point Codes.....	A-7
ITU National Point Codes.....	A-7
Converting ITU National Point Code Formats.....	A-8
Introduction.....	A-8
Converting Single Number ITU National Point Codes.....	A-8
Converting Multiple-Part ITU National Point Codes.....	A-9
24-bit ITU-National Point Codes.....	A-10
Spare and Private Point Code Subtype Prefixes.....	A-10
Valid CIC Ranges for SI and MSU Types in Routing Key Static Entries.....	A-13
NAIV/NAI Mapping.....	A-13
NPV/NP Mapping.....	A-14
Cards that use the ent-card Command.....	A-15
Summary of Loopback Testing Commands and Functions.....	A-18

## **Appendix B. Acronyms and Abbreviations**

# List of Figures

<b>Figure 4-1.</b> System Terminal User Display.....	4-4
<b>Figure 4-2.</b> Telnet Terminal Selection and Login.....	4-7
<b>Figure 4-3.</b> Output Banner Format.....	4-16
<b>Figure 5-1.</b> Eagle Input and Internal Clocks with TDM-GTI.....	5-87
<b>Figure 5-2.</b> The chg-db:action=backup:dest=fixed Command.....	5-104
<b>Figure 5-3.</b> The chg-db:action=restore:src=fixed Command.....	5-105
<b>Figure 5-4.</b> The chg-db:action=backup:dest=remove Command.....	5-106
<b>Figure 5-5.</b> Remote Backup or Restore.....	5-106
<b>Figure 5-6.</b> The chg-db:action=repair Command.....	5-106
<b>Figure 5-7.</b> The chg-db:action=restore:src=remove Command.....	5-107
<b>Figure 5-8.</b> Prefix Table References.....	5-366
<b>Figure A-1.</b> ATM Loopback Tests.....	A-24

# List of Tables

<b>Table 1-1.</b> Manual Organization.....	1-2
<b>Table 4-1.</b> Action Commands and Their Associated System Entity .....	4-10
<b>Table 4-2.</b> Keyboard Functions.....	4-11
<b>Table 5-1.</b> Parameters That Must Be Provisioned Prior to Updating OAP for SEAS .....	5-23
<b>Table 5-2.</b> Other Data Required for Updating the OAP Configuration.....	5-24
<b>Table 5-3.</b> Performance Impact of act-oap-config parameters .....	5-25
<b>Table 5-4.</b> Commands for which canc-cmd Halts Processing and Output.....	5-47
<b>Table 5-5.</b> Valid Parameter Combinations for Routing Key Types using the chg-appl-rtkey command. ....	5-67
<b>Table 5-6.</b> IP Signaling Capacities.....	5-74
<b>Table 5-7.</b> Validation Rules for Association Establishment .....	5-76
<b>Table 5-8.</b> Alias Combination Matrix.....	5-118
<b>Table 5-9.</b> Link Alignment Performance.....	5-137
<b>Table 5-10.</b> EIR Response Type (eirrsptype) Values.....	5-154
<b>Table 5-11.</b> Valid Parameter Combinations for the chg-gtt Routing Parameters .....	5-201
<b>Table 5-12.</b> Gateway Screening Stop Action Definitions.....	5-210
<b>Table 5-13.</b> DRANAIV/DRANAI Mapping.....	5-219
<b>Table 5-14.</b> DRANPV/DRANP Mapping.....	5-219
<b>Table 5-15.</b> Valid Subnet Mask Values.....	5-223
<b>Table 5-16.</b> Valid Subnet Mask Values.....	5-227
<b>Table 5-17.</b> Default Subnet Mask Values.....	5-227
<b>Table 5-18.</b> Incoming SLS Bit Rotation for ITU.....	5-275
<b>Table 5-19.</b> Incoming SLS Bit Rotation for ANSI.....	5-276
<b>Table 5-20.</b> SLS Bit Rotation .....	5-281
<b>Table 5-21.</b> Link Alignment Performance.....	5-290
<b>Table 5-22.</b> Incoming SLS Bit Rotation for ANSI Linksets.....	5-294
<b>Table 5-23.</b> Maximum limit of True PC entries.....	5-306
<b>Table 5-24.</b> Allowed PC and Alternate RI Mate PC Combinations.....	5-307
<b>Table 5-25.</b> Impacts on Data Collection of Turning On the 15 Minute Measurements Option .....	5-319
<b>Table 5-26.</b> Allowed PC and Alternate RI Mate PC Combinations.....	5-331
<b>Table 5-27.</b> Valid PVN Subnet Mask Values.....	5-337
<b>Table 5-28.</b> Acceptable nsfi and si parameter combinations (chg-scr-sio)....	5-442
<b>Table 5-29.</b> Valid combinations for the h0/h1 andnh0/nh1 parameters (chg-scr-sio).....	5-442
<b>Table 5-30.</b> Additional Valid chg-scr-sio Parameter Combinations.....	5-443
<b>Table 5-31.</b> NAIV/NAI Mapping.....	5-474
<b>Table 5-32.</b> NP/NPV Mapping.....	5-475
<b>Table 5-33.</b> NPCFMTI Parameter - ITU National Point Code Values.....	5-486
<b>Table 5-34.</b> Point Code Format Examples.....	5-487

<b>Table 5-35.</b> Valid and Default UAPS Parameter Values .....	5-528
<b>Table 5-36.</b> DRANAIV/DRANAI Mapping.....	5-538
<b>Table 5-37.</b> DRANPV/DRANP Mapping.....	5-538
<b>Table 5-38.</b> Performance for the copy-meas command.....	5-560
<b>Table 5-39.</b> Commands For Which dact-cmd Aborts Processing and Output.....	5-563
<b>Table 5-40.</b> Valid Combinations for the h0/h1 and nh0/nh1 Parameters (chg-scr-sio).....	5-684
<b>Table 5-41.</b> SE-HSL SLK Capacity Feature Quantities.....	5-713
<b>Table 5-42.</b> Minimum Hardware Required for LNP Quantity Features .....	5-713
<b>Table 5-43.</b> Proxy Point Codes Feature Quantities.....	5-715
<b>Table 5-44.</b> TPS Capacities.....	5-716
<b>Table 5-45.</b> ST-HSL-A SLK Capacity Feature Quantities .....	5-718
<b>Table 5-46.</b> Maximum Sockets/Associations per Card.....	5-729
<b>Table 5-47.</b> TRIGTYPE Hexadecimal Codes.....	5-743
<b>Table 5-48.</b> Valid ent-gtt Routing Parameter Combinations.....	5-810
<b>Table 5-49.</b> Valid Subnet Mask Values.....	5-828
<b>Table 5-50.</b> Incoming SLS Bit Rotation for ITU .....	5-838
<b>Table 5-51.</b> Incoming SLS Bit Rotation for ANSI.....	5-839
<b>Table 5-52.</b> SLS Bit Rotation.....	5-843
<b>Table 5-53.</b> Link Alignment Performance.....	5-850
<b>Table 5-54.</b> Here below is the maximum limit of True PCs entries.....	5-860
<b>Table 5-55.</b> Valid Combinations for the h0/h1 Parameters (ent-scr-sio).....	5-936
<b>Table 5-56.</b> Valid ent-scr-sionsfi and si Parameter Combinations.....	5-936
<b>Table 5-57.</b> Additional Valid ent-scr-sio Parameter Combinations.....	5-937
<b>Table 5-58.</b> Transmission Rate for the bps Parameter.....	5-952
<b>Table 5-59.</b> Valid L2 Timer Ranges.....	5-956
<b>Table 5-60.</b> LSL link thresholds.....	5-957
<b>Table 5-61.</b> Unchannelized T1 link thresholds.....	5-957
<b>Table 5-62.</b> DMS.CFG File Location for format-disk Command.....	5-994
<b>Table 5-63.</b> Disk Format Capacity .....	5-994
<b>Table 5-64.</b> Parameter Combinations for the inh-alm command .....	5-1001
<b>Table 5-65.</b> Route Set Test When LNP is Offline.....	5-1007
<b>Table 5-66.</b> Receiving Messages when LNP is Offline .....	5-1008
<b>Table 5-67.</b> rept-ftp-meas Valid and Invalid Parameter Combinations.....	5-1038
<b>Table 5-68.</b> Explanation of rept-imt-info:report=hmuxerr Statistics .....	5-1043
<b>Table 5-69.</b> Explanation of rept-imt-info:report=hiprerr Statistics .....	5-1049
<b>Table 5-70.</b> HIPR2 Statistics.....	5-1052
<b>Table 5-71.</b> HIPR2 Advanced Statistics.....	5-1053
<b>Table 5-72.</b> Hexadecimal/Decimal Values for s and e parameters .....	5-1066
<b>Table 5-73.</b> rept-imt-lvl1 Statistics Explanation .....	5-1074
<b>Table 5-74.</b> Valid Parameter Combinations for the type Parameter .....	5-1090
<b>Table 5-75.</b> Auto-Inhibit Hardware Verification Codes.....	5-1124
<b>Table 5-76.</b> Summary of DPC Parameter Syntaxes .....	5-1169
<b>Table 5-77.</b> IMT Bus States .....	5-1198
<b>Table 5-78.</b> Summary of DPC Parameter Syntaxes .....	5-1242
<b>Table 5-79.</b> Serial Number Formats.....	5-1352
<b>Table 5-80.</b> Summary of DPC Parameter Syntaxes .....	5-1396
<b>Table 5-81.</b> Retrieve Commands for Additional Table Information .....	5-1810

<b>Table 5-82.</b> Time Zones Set by the set-time command .....	5-1866
<b>Table 5-83.</b> Test Disk Execution Times .....	5-1871
<b>Table 5-84.</b> Valid PROT and FEAT Combinations.....	5-1880
<b>Table 5-85.</b> Parameter Combinations for the unhb-alm command .....	5-1917
<b>Table 6-1.</b> Actions with Corresponding Upgrade Phase.....	6-3
<b>Table 6-2.</b> Subrange Parameters for cmd Keywords.....	6-8
<b>Table 6-3.</b> Parameter/Card Type Filters for MSUs.....	6-50
<b>Table A-1.</b> Summary of Ranges for link Parameter.....	A-1
<b>Table A-2.</b> Commands that support the Spare Point Code Prefix.....	A-11
<b>Table A-3.</b> Commands that support the Private Point Code Prefix.....	A-12
<b>Table A-4.</b> Valid CIC Ranges for SI and MSU Types.....	A-13
<b>Table A-5.</b> NAIV/NAI Mapping.....	A-13
<b>Table A-6.</b> NPV/NP Mapping.....	A-14
<b>Table A-7.</b> Valid ent-card Applications (appl) and Card Types (type).....	A-15
<b>Table A-8.</b> Loopback Testing Commands and Functions.....	A-19





## Introduction

Overview.....	1-1
Where to Find Information in This Manual.....	1-2
Scope and Audience.....	1-3
Related Publications.....	1-3
Customer Care Center.....	1-3
Documentation Packaging, Delivery, and Updates.....	1-5
Documentation Admonishments.....	1-6
Locate Product Documentation on the Customer Support Site on the Customer Support Site.....	1-6

### Overview

The *Commands Manual* provides a description of all commands used in the EAGLE 5 Integrated Signaling System (ISS) and LNP. The EAGLE 5 ISS includes the IP<sup>7</sup> Secure Gateway and the IP<sup>7</sup> Front End. The use of the term “the system” indicates that the information is common to all of the functions of the EAGLE 5 ISS. Differences are indicated for the specific product, as appropriate.

**NOTE: The IP<sup>7</sup> Front End configuration is a stand-alone single-shelf IP<sup>7</sup> Secure Gateway. When using this manual, consider IP<sup>7</sup> Front End and IP<sup>7</sup> Secure Gateway as functional equivalents with the IP<sup>7</sup> Front End limited to a single shelf configuration.**

Commands are entered at a terminal to perform system operations such as displaying the system status, administering system security, and maintaining the database. Error messages are displayed to provide information about problems encountered when a command is entered.

## Where to Find Information in This Manual

Table 1-1 shows how this manual is organized.

**NOTE:** Throughout this manual, reference to the OAP (Operation System Support Application Processor) applies also to the EOAP (Enhanced Operation System Support Application Process).

**Table 1-1.** Manual Organization

Chapter Number and Title	Description
Chapter 1, "Introduction"	The organization of this manual The audience References to other Tekelec documentation Customer assistance Documentation packaging, delivery, and updates Safety admonishments
Chapter 2, "Alphabetical List of Commands"	An alphabetical list of the system commands and the corresponding page number for each command description in this manual
Chapter 3, "Commands Listed by Class"	List of the system commands arranged by command class
Chapter 4, "Using Commands"	Descriptions of system terminals, printers, MASP cards, and MDAL cards Keyboard functions Command class administration Definitions of types of command output and messages Procedures for logging into and logging out of the system
Chapter 5, "Commands"	Descriptions of the commands used in the system
Chapter 6, "Debug Commands"	Descriptions of debug commands used in troubleshooting and debugging the system
Chapter 7, "Pass-Through Commands"	Descriptions of the command strings used within the <b>pass</b> command to gather card- and application-specific information
Appendix A, "Reference Information"	Information that is referred to in more than one command description (including signaling link ports, point code formats)

Table 1-1. Manual Organization

Chapter Number and Title	Description
	<p>and usage rules, device status, loopback testing, and ISUP Normalization Variants)</p> <p>How to convert an ITU national point code from the format specified by the <b>chg-stpopts:npcfnti</b> parameter into a single number so that it can be used by gateway screening.</p> <p>Summary of loopback testing functions</p>
Appendix B, "Acronyms and Abbreviations"	List of acronyms and abbreviations used in the document

## Scope and Audience

This manual is intended for those who maintain and do database administration on the Tekelec Signaling Products and LNP. It is assumed that the user is familiar with the SS7 network and its associated protocols. The manual describes commands used in the system, and it contains a special section on debug commands and their descriptions.

Debug commands are a special group of commands used in troubleshooting and debugging the system. These commands are intended for Tekelec Technical Services personnel and authorized engineering personnel in the operating companies. The use of these commands is restricted to those personnel who have access to the "Debug" command class.

## Related Publications

The *Commands Manual* is part of and refers to several of the manuals in the EAGLE 5 ISS documentation set. The manuals are listed and described in the *Related Publications* manual, which is included in the *Release Documentation* on the DVD and is published separately on the Customer Support web site:

## Customer Care Center

The Tekelec Customer Care Center is your initial point of contact for all product support needs. A representative takes your call or email, creates a Customer Service Request (CSR) and directs your requests to the Tekelec Technical Assistance Center (TAC). Each CSR includes an individual tracking number. Together with TAC Engineers, the representative will help you resolve your request.

The Customer Care Center is available 24 hours a day, 7 days a week, 365 days a year, and is linked to TAC Engineers around the globe.

Tekelec TAC Engineers are available to provide solutions to your technical questions and issues 7 days a week, 24 hours a day. After a CSR is issued, the TAC Engineer determines the classification of the trouble. If a critical problem exists, emergency procedures are initiated. If the problem is not critical, normal support procedures apply. A primary Technical Engineer is assigned to work on the CSR and provide a solution to the problem. The CSR is closed when the problem is resolved.

Tekelec Technical Assistance Centers are located around the globe in the following locations:

**Tekelec - Global**

Email (All Regions): support@tekelec.com

- USA and Canada

Phone:

1-888-FOR-TKLC or 1-888-367-8552 (toll-free, within continental USA and Canada)

1-919-460-2150 (outside continental USA and Canada)

TAC Regional Support Office Hours:

8:00 a.m. through 5:00 p.m. (GMT minus 5 hours), Monday through Friday, excluding holidays

- Central and Latin America (CALA)

Phone:

USA access code +1-800-658-5454, then 1-888-FOR-TKLC or 1-888-367-8552 (toll-free)

TAC Regional Support Office Hours (except Brazil):

10:00 a.m. through 7:00 p.m. (GMT minus 6 hours), Monday through Friday, excluding holidays

- Argentina

Phone:

0-800-555-5246 (toll-free)

- Brazil

Phone:

0-800-891-4341 (toll-free)

TAC Regional Support Office Hours:

8:30 a.m. through 6:30 p.m. (GMT minus 3 hours), Monday through Friday, excluding holidays

- Chile

Phone:

1230-020-555-5468

- Columbia

Phone:

01-800-912-0537

- Dominican Republic

Phone:

1-888-367-8552

- Mexico

Phone:

001-888-367-8552

- Peru

Phone:

0800-53-087

- Puerto Rico

Phone:

1-888-367-8552 (1-888-FOR-TKLC)

Venezuela

Phone:

0800-176-6497

- Europe, Middle East, and Africa
  - Signaling  
Phone:  
+44 1784 467 804 (within UK)  
TAC Regional Support Office Hours:  
8:00 a.m. through 7:00 p.m. (GMT), Monday through Friday, excluding holidays
  - Software Solutions  
Phone:  
+33 3 89 33 54 00  
TAC Regional Support Office Hours:  
8:00 a.m. through 7:00 p.m. (GMT), Monday through Friday, excluding holidays
- Asia
  - India  
Phone:  
+91 124 436 8552 or +91 124 436 8553  
TAC Regional Support Office Hours:  
10:00 a.m. through 7:00 p.m. (GMT plus 5 1/2 hours), Monday through Saturday,  
excluding holidays
  - Singapore  
Phone:  
+65 6796 2288  
TAC Regional Support Office Hours:  
9:00 a.m. through 6:00 p.m. (GMT plus 8 hours), Monday through Friday, excluding  
holidays

## **Documentation Packaging, Delivery, and Updates**

Customer documentation is provided with each system in accordance with the contract agreements. It is updated whenever significant changes that affect system operation or configuration are made. Updates may be issued as an addendum, or a reissue of the affected documentation.

The document part number appears on the title page along with the current revision of the document and the date of publication. The bottom of each page contains the document part number and date of publication.

Two types of releases are major software releases and maintenance releases. Maintenance releases are issued as addenda with a title page and change bars. On the changed pages, the date and document part number are changed. On any unchanged pages that accompany the changed pages, the date and document part number is unchanged.

When the software release has a minimum effect on documentation, we provide an addendum. The addendum provides an instruction page, a new title page, a change history page, and replacement chapters with the date of publication, the document part number, and change bars.

If a new release has a major impact on documentation, such as a new feature, the entire documentation set is reissued with a new part number and a new release number.

## Documentation Admonishments

Admonishments are icons and text that may appear in this and other Tekelec manuals. Admonishments alert the reader to assure personal safety, to minimize possible service interruptions, and to warn of the potential for equipment damage.

The following admonishments, listed in descending order of priority, are used in Tekelec manuals.



**TOPPLE:** This icon and text indicate the possibility of equipment damage and personal injury from toppling.



**DANGER:** This icon and text indicate the possibility of *personal injury*.



**WARNING:** This icon and text indicate the possibility of *equipment damage*.



**CAUTION:** This icon and text indicate the possibility of *service interruption*.

## Locate Product Documentation on the Customer Support Site on the Customer Support Site

Access to Tekelec's Customer Support site is restricted to current Tekelec customers only. This section describes how to log into Tekelec's Customer Support site and locate a document. Viewing the document requires Adobe Acrobat Reader, which can be downloaded at [www.adobe.com](http://www.adobe.com).

1. Log into Tekelec's new Customer Support site at [support.tekelec.com](http://support.tekelec.com). NOTE: If you have not registered for this new site, click the Register Here link. Have your customer number available. The response time for registration requests is 24 to 48 hours.
2. Click the Product Support tab.
3. Use the Search field to locate a document by its part number, release number, document name, or document type. The Search field accepts both full and partial entries.
4. Click a subject folder to browse through a list of related files.
5. To download a file to your location, right-click the file name and select Save Target As.

**NOTE:** Customers may print a reasonable number of each manual for their own use.

# Alphabetical List of Commands

## Introduction

This chapter contains an alphabetical list of the Tekelec Signaling Products (Eagle STP, IP<sup>7</sup> Secure Gateway, and IP<sup>7</sup> Front End) commands and the page number where each command is described in this manual.

## Commands

act-alm-trns.....	5-1	chg-acg-noc.....	5-56
act-cdl.....	5-2	chg-ainpopts.....	5-58
act-dlk.....	5-3	chg-appl-rtkey.....	5-62
act-echo.....	5-4	chg-as.....	5-69
act-file-trns.....	5-5	chg-assoc.....	5-70
act-flash.....	5-8	chg-atinpopts.....	5-78
act-ftp-trns.....	5-11	chg-atm-lps.....	5-82
act-gpl.....	5-12	chg-attr-seculog.....	5-85
act-lbp.....	5-15	chg-clkopts.....	5-86
act-lpo.....	5-21	chg-cmd.....	5-88
act-oap-config.....	5-23	chg-cmdclass.....	5-90
act-slk.....	5-26	chg-csl.....	5-91
act-user.....	5-28	chg-ctrl-feat.....	5-96
alw-card.....	5-29	chg-db.....	5-103
alw-imt.....	5-32	chg-dstn.....	5-109
alw-map-ss.....	5-33	chg-el.....	5-126
alw-slk.....	5-34	chg-eisopts.....	5-129
alw-trm.....	5-35	chg-feat.....	5-130
aud-data.....	5-36	chg-frn-pwr.....	5-138
blk-slk.....	5-45	chg-ftp-serv.....	5-140
canc-alm-trns.....	5-47	chg-gpl.....	5-141
canc-cmd.....	5-47	chg-gsm-msg.....	5-145
canc-dlk.....	5-50	chg-gsmmap-scrn.....	5-147
canc-echo.....	5-50	chg-gsmopts.....	5-153
canc-lpo.....	5-51	chg-gsms-opcode.....	5-161
canc-slk.....	5-53	chg-gsmsmsopts.....	5-165
canc-user.....	5-54	chg-gta.....	5-174
chg-acg-mic.....	5-55	chg-gtcnv.....	5-191
		chg-gtt.....	5-194
		chg-gttset.....	5-204
			5-209

## Commands

## Alphabetical List of Commands

chg-gtw-stp.....	5-210	chg-sid.....	5-462
chg-gws-actset.....	5-210	chg-slt.....	5-472
chg-gws-redirect.....	5-214	chg-srvsel.....	5-473
chg-inopts.....	5-217	chg-ss-appl.....	5-478
chg-ip-card.....	5-222	chg-ss7opts.....	5-479
chg-ip-lnk.....	5-225	chg-stpopts.....	5-481
chg-is41-msg.....	5-228	chg-t1.....	5-494
chg-is41opts.....	5-231	chg-tatr-msg.....	5-497
chg-is41smsopts.....	5-236	chg-tatropts.....	5-499
chg-isup-msg.....	5-243	chg-th-alm.....	5-501
chg-l2t.....	5-245	chg-tifopts.....	5-503
chg-l3t.....	5-248	chg-tinopts.....	5-508
chg-lbp.....	5-255	chg-trm.....	5-511
chg-lnp-serv.....	5-257	chg-ttmap.....	5-520
chg-lnp-ttmap.....	5-259	chg-ttr-msg.....	5-521
chg-lnopts.....	5-260	chg-ttropts.....	5-523
chg-loopset.....	5-264	chg-uaps.....	5-527
chg-ls.....	5-272	chg-user.....	5-531
chg-lsopts.....	5-292	chg-vflx-cd.....	5-536
chg-m2pa-tset.....	5-295	chg-vflx-opts.....	5-537
chg-map.....	5-297	chg-vflx-rn.....	5-540
chg-meas.....	5-309	chg-vflx-vmsid.....	5-541
chg-measopts.....	5-311	chg-x25-dstn.....	5-543
chg-mrn.....	5-320	chg-x25-rte.....	5-544
chg-mtc-measopts.....	5-333	chg-x25-slk.....	5-546
chg-netopts.....	5-336	chk-unref-ent.....	5-548
chg-npp-as.....	5-338	clr-imt-stats.....	5-550
chg-npp-serv.....	5-347	conn-imt.....	5-552
chg-npp-srs.....	5-352	copy-disk.....	5-553
chg-oap-config.....	5-355	copy-fta.....	5-555
chg-pid.....	5-358	copy-gpl.....	5-557
chg-ppsopts.....	5-359	copy-meas.....	5-559
chg-prefix.....	5-364	copy-seculog.....	5-560
chg-rte.....	5-367	dact-alm-trns.....	5-562
chg-rtx.....	5-370	dact-cdl.....	5-562
chg-sccp-msg.....	5-375	dact-cmd.....	5-563
chg-sccp-serv.....	5-381	dact-echo.....	5-565
chg-sccpopts.....	5-388	dact-lbp.....	5-566
chg-scr-aftpc.....	5-392	dact-rstst.....	5-568
chg-scr-blkdpc.....	5-397	dact-slk.....	5-569
chg-scr-blkopc.....	5-404	dact-user.....	5-571
chg-scr-cdpa.....	5-410	disc-imt.....	5-571
chg-scr-cgpa.....	5-416	disp-fta-dir.....	5-572
chg-scr-destfld.....	5-422	dlt-acg-mic.....	5-573
chg-scr-dpc.....	5-427	dlt-acg-noc.....	5-574
chg-scr-isup.....	5-432	dlt-appl-rtkey.....	5-574
chg-scr-opc.....	5-434	dlt-as.....	5-579
chg-scr-sio.....	5-439	dlt-assoc.....	5-580
chg-scr-tt.....	5-444	dlt-card.....	5-580
chg-scrset.....	5-446	dlt-csl.....	5-581
chg-seas-config.....	5-448	dlt-cspc.....	5-585
chg-secu-dflt.....	5-450	dlt-dlk.....	5-588
chg-secu-trm.....	5-455	dlt-dstn.....	5-588
chg-sg-opts.....	5-459	dlt-e1.....	5-593



dlt-firm-pwr.....	5-595	dlt-user.....	5-698
dlt-fta.....	5-595	dlt-vendid.....	5-699
dlt-ftp-serv.....	5-596	dlt-vflx-cd.....	5-699
dlt-gserv-data.....	5-597	dlt-vflx-rn.....	5-700
dlt-gsmmap-scrn.....	5-599	dlt-vflx-vmsid.....	5-701
dlt-gsms-opcode.....	5-600	dlt-x25-dstn.....	5-701
dlt-gsmssn-scrn.....	5-601	dlt-x25-rte.....	5-702
dlt-gta.....	5-602	enable-ctrl-feat.....	5-702
dlt-gtcnv.....	5-608	ent-acg-mic.....	5-720
dlt-gtt.....	5-610	ent-acg-noc.....	5-721
dlt-gttsel.....	5-612	ent-appl-rtkey.....	5-723
dlt-gttset.....	5-615	ent-as.....	5-728
dlt-gws-redirect.....	5-616	ent-assoc.....	5-729
dlt-home-smsc.....	5-616	ent-card.....	5-732
dlt-homern.....	5-617	ent-csl.....	5-738
dlt-ip-host.....	5-618	ent-cspc.....	5-744
dlt-ip-node.....	5-618	ent-dlk.....	5-747
dlt-ip-rte.....	5-620	ent-dstn.....	5-749
dlt-lbp.....	5-622	ent-e1.....	5-763
dlt-lnp-serv.....	5-623	ent-firm-pwr.....	5-767
dlt-loopset.....	5-624	ent-ftp-serv.....	5-768
dlt-ls.....	5-626	ent-gserv-data.....	5-770
dlt-map.....	5-627	ent-gsmmap-scrn.....	5-772
dlt-mrn.....	5-631	ent-gsms-opcode.....	5-778
dlt-na.....	5-638	ent-gsmssn-scrn.....	5-783
dlt-npp-as.....	5-639	ent-gta.....	5-784
dlt-npp-srs.....	5-640	ent-gtcnv.....	5-801
dlt-prefix.....	5-641	ent-gtt.....	5-804
dlt-rmt-appl.....	5-642	ent-gttsel.....	5-813
dlt-rte.....	5-644	ent-gttset.....	5-817
dlt-rtx.....	5-649	ent-gws-redirect.....	5-819
dlt-sccp-serv.....	5-652	ent-home-smsc.....	5-822
dlt-scr-aftpc.....	5-657	ent-homern.....	5-822
dlt-scr-blkdpc.....	5-660	ent-ip-host.....	5-823
dlt-scr-blkopc.....	5-663	ent-ip-node.....	5-824
dlt-scr-cdpa.....	5-667	ent-ip-rte.....	5-827
dlt-scr-cgpa.....	5-670	ent-lbp.....	5-829
dlt-scr-destfld.....	5-673	ent-lnp-serv.....	5-831
dlt-scr-dpc.....	5-676	ent-loopset.....	5-833
dlt-scr-isup.....	5-679	ent-ls.....	5-835
dlt-scr-opc.....	5-680	ent-map.....	5-851
dlt-scr-sio.....	5-683	ent-mrn.....	5-862
dlt-scr-tt.....	5-685	ent-na.....	5-875
dlt-scrset.....	5-686	ent-npp-as.....	5-876
dlt-shlf.....	5-687	ent-npp-srs.....	5-885
dlt-slk.....	5-687	ent-rmt-appl.....	5-889
dlt-spc.....	5-690	ent-rte.....	5-891
dlt-srvsel.....	5-691	ent-rtx.....	5-895
dlt-ss-appl.....	5-693	ent-scr-aftpc.....	5-899
dlt-subnetid.....	5-694	ent-scr-blkdpc.....	5-903
dlt-t1.....	5-694	ent-scr-blkopc.....	5-908
dlt-tt.....	5-695	ent-scr-cdpa.....	5-912
dlt-ttmap.....	5-697	ent-scr-cgpa.....	5-916
dlt-uim-acthresh.....	5-698	ent-scr-destfld.....	5-921

ent-scr-dpc.....	5-924	rept-stat-cdt.....	5-1130
ent-scr-isup.....	5-928	rept-stat-clk.....	5-1131
ent-scr-opc.....	5-930	rept-stat-cluster.....	5-1138
ent-scr-sio.....	5-934	rept-stat-db.....	5-1144
ent-scr-tt.....	5-938	rept-stat-ddb.....	5-1160
ent-scrset.....	5-940	rept-stat-dlk.....	5-1165
ent-serial-num.....	5-942	rept-stat-dstn.....	5-1166
ent-shlf.....	5-943	rept-stat-el.....	5-1179
ent-sid.....	5-944	rept-stat-enet.....	5-1182
ent-slk.....	5-946	rept-stat-eroute.....	5-1183
ent-spc.....	5-960	rept-stat-gpl.....	5-1188
ent-srvsel.....	5-962	rept-stat-imt.....	5-1196
ent-ss-appl.....	5-965	rept-stat-iptps.....	5-1199
ent-subnetid.....	5-967	rept-stat-lfs.....	5-1203
ent-t1.....	5-968	rept-stat-lnp.....	5-1204
ent-tt.....	5-972	rept-stat-ls.....	5-1212
ent-ttmap.....	5-973	rept-stat-meas.....	5-1218
ent-user.....	5-974	rept-stat-mon.....	5-1221
ent-vendid.....	5-978	rept-stat-mps.....	5-1227
ent-vflx-cd.....	5-980	rept-stat-mux.....	5-1234
ent-vflx-rn.....	5-981	rept-stat-rtd.....	5-1235
ent-vflx-vmsid.....	5-982	rept-stat-rte.....	5-1240
ent-x25-dstn.....	5-984	rept-stat-rtkey.....	5-1250
ent-x25-rte.....	5-985	rept-stat-rtx.....	5-1251
flash-card.....	5-988	rept-stat-sccp.....	5-1257
format-disk.....	5-991	rept-stat-seas.....	5-1272
inh-alm.....	5-996	rept-stat-seculog.....	5-1275
inh-card.....	5-1004	rept-stat-slan.....	5-1277
inh-imt.....	5-1006	rept-stat-slk.....	5-1280
inh-map-ss.....	5-1007	rept-stat-sys.....	5-1288
inh-slk.....	5-1009	rept-stat-t1.....	5-1292
inh-trm.....	5-1010	rept-stat-trbl.....	5-1295
init-card.....	5-1011	rept-stat-trm.....	5-1300
init-flash.....	5-1017	rept-stat-tstslk.....	5-1302
init-imt-gpl.....	5-1021	rept-stat-user.....	5-1304
init-mux.....	5-1022	rept-stat-xlist.....	5-1304
init-network.....	5-1023	rept-x25-meas.....	5-1305
init-oap.....	5-1026	rls-alm.....	5-1308
init-sys.....	5-1028	rmv-card.....	5-1309
lock.....	5-1031	rmv-imt.....	5-1310
login.....	5-1031	rmv-trm.....	5-1311
logout.....	5-1032	rst-card.....	5-1312
pass.....	5-1033	rst-dstn.....	5-1313
rept-ftp-meas.....	5-1035	rst-imt.....	5-1315
rept-imt-info.....	5-1039	rst-trm.....	5-1316
rept-imt-lvl1.....	5-1065	rtrv-acg-mic.....	5-1317
rept-imt-lvl2.....	5-1079	rtrv-acg-noc.....	5-1319
rept-meas.....	5-1083	rtrv-ainpopts.....	5-1320
rept-stat-alm.....	5-1092	rtrv-appl-rtkey.....	5-1322
rept-stat-applsock.....	5-1098	rtrv-as.....	5-1328
rept-stat-as.....	5-1100	rtrv-assoc.....	5-1329
rept-stat-assoc.....	5-1101	rtrv-atinpopts.....	5-1339
rept-stat-card.....	5-1104	rtrv-atm-lps.....	5-1340
rept-stat-cdl.....	5-1129	rtrv-atm-prm.....	5-1345

rtrv-attr-seculog.....	5-1346	rtrv-ls.....	5-1559
rtrv-bip.....	5-1347	rtrv-m2pa-tset.....	5-1580
rtrv-card.....	5-1352	rtrv-map.....	5-1583
rtrv-clkopts.....	5-1358	rtrv-meas-sched.....	5-1593
rtrv-cmd.....	5-1359	rtrv-measopts.....	5-1596
rtrv-cmdclass.....	5-1361	rtrv-mrn.....	5-1598
rtrv-csl.....	5-1362	rtrv-mtc-measopts.....	5-1604
rtrv-cspc.....	5-1369	rtrv-na.....	5-1606
rtrv-ctrl-feat.....	5-1371	rtrv-netopts.....	5-1607
rtrv-data-rtdb.....	5-1376	rtrv-npp-as.....	5-1608
rtrv-dlk.....	5-1384	rtrv-npp-serv.....	5-1609
rtrv-dstn.....	5-1387	rtrv-npp-srs.....	5-1613
rtrv-e1.....	5-1419	rtrv-oap-config.....	5-1615
rtrv-eisopts.....	5-1422	rtrv-obit.....	5-1616
rtrv-feat.....	5-1423	rtrv-ppsopts.....	5-1631
rtrv-frm-pwr.....	5-1425	rtrv-prefix.....	5-1635
rtrv-ftp-serv.....	5-1426	rtrv-rmt-appl.....	5-1636
rtrv-gpl.....	5-1430	rtrv-rte.....	5-1637
rtrv-gserv-data.....	5-1436	rtrv-rtx.....	5-1666
rtrv-gsm-msg.....	5-1438	rtrv-sccp-msg.....	5-1675
rtrv-gsmmap-scrn.....	5-1439	rtrv-sccp-serv.....	5-1677
rtrv-gsmopts.....	5-1448	rtrv-sccpopts.....	5-1680
rtrv-gsms-opcode.....	5-1449	rtrv-scr-aftpc.....	5-1683
rtrv-gsmsmsopts.....	5-1454	rtrv-scr-blkdpc.....	5-1688
rtrv-gsmssn-scrn.....	5-1454	rtrv-scr-blkopc.....	5-1694
rtrv-gta.....	5-1456	rtrv-scr-cdpa.....	5-1699
rtrv-gtcnv.....	5-1480	rtrv-scr-cgpa.....	5-1705
rtrv-gtt.....	5-1481	rtrv-scr-destfld.....	5-1711
rtrv-gttset.....	5-1497	rtrv-scr-dpc.....	5-1717
rtrv-gtw-stp.....	5-1508	rtrv-scr-isup.....	5-1723
rtrv-gtwy-acthresh.....	5-1508	rtrv-scr-opc.....	5-1726
rtrv-gtwy-prmtrs.....	5-1509	rtrv-scr-sio.....	5-1732
rtrv-gws-actset.....	5-1510	rtrv-scr-tt.....	5-1736
rtrv-gws-redirect.....	5-1511	rtrv-scrset.....	5-1739
rtrv-home-smsc.....	5-1512	rtrv-seas-config.....	5-1743
rtrv-homern.....	5-1513	rtrv-secu-dflt.....	5-1744
rtrv-inopts.....	5-1514	rtrv-secu-trm.....	5-1746
rtrv-ip-card.....	5-1517	rtrv-secu-user.....	5-1748
rtrv-ip-host.....	5-1519	rtrv-seculog.....	5-1751
rtrv-ip-lnk.....	5-1523	rtrv-serial-num.....	5-1758
rtrv-ip-node.....	5-1524	rtrv-sg-opts.....	5-1758
rtrv-ip-rte.....	5-1528	rtrv-shlf.....	5-1759
rtrv-is41-msg.....	5-1529	rtrv-sid.....	5-1761
rtrv-is41opts.....	5-1530	rtrv-slk.....	5-1768
rtrv-is41smsopts.....	5-1531	rtrv-slt.....	5-1775
rtrv-isup-msg.....	5-1532	rtrv-spc.....	5-1777
rtrv-l2t.....	5-1534	rtrv-srvsel.....	5-1781
rtrv-l3t.....	5-1537	rtrv-ss-appl.....	5-1787
rtrv-lbp.....	5-1539	rtrv-ss7opts.....	5-1788
rtrv-lnp-serv.....	5-1542	rtrv-stp.....	5-1789
rtrv-lnpopts.....	5-1544	rtrv-stpopts.....	5-1800
rtrv-log.....	5-1545	rtrv-subnetid.....	5-1804
rtrv-loopset.....	5-1556	rtrv-t1.....	5-1806
		rtrv-tatr-msg.....	5-1808

## Debug Commands

rtrv-tatropts.....	5-1809
rtrv-tbl-capacity.....	5-1810
rtrv-th-alm.....	5-1813
rtrv-tifopts.....	5-1814
rtrv-tinpopts.....	5-1815
rtrv-trbl.....	5-1816
rtrv-trbltx.....	5-1817
rtrv-trm.....	5-1822
rtrv-tt.....	5-1833
rtrv-ttmap.....	5-1836
rtrv-ttr-msg.....	5-1839
rtrv-ttropts.....	5-1840
rtrv-uaps.....	5-1841
rtrv-uim-acthresh.....	5-1843
rtrv-user.....	5-1843
rtrv-vendid.....	5-1846
rtrv-vflx-cd.....	5-1847
rtrv-vflx-opts.....	5-1850
rtrv-vflx-rn.....	5-1851
rtrv-vflx-vmssid.....	5-1854
rtrv-x25-dstn.....	5-1856
rtrv-x25-rte.....	5-1857
rtrv-x25-slk.....	5-1861
set-date.....	5-1862
set-gtwy-acthresh.....	5-1863
set-scrrej-prmtrs.....	5-1864
set-time.....	5-1865
set-uim-acthresh.....	5-1867
tst-bip.....	5-1868
tst-disk.....	5-1869
tst-dlk.....	5-1873
tst-e1.....	5-1874
tst-imt.....	5-1876
tst-msg.....	5-1878
tst-npp-msg.....	5-1900
tst-slk.....	5-1903
tst-t1.....	5-1908
ublk-slk.....	5-1910
unhb-alm.....	5-1912
unhb-slk.....	5-1918
unlock.....	5-1920

## Debug Commands

act-upgrade.....	6-1
cdu.....	6-6
chg-bip-fld.....	6-13
chg-bip-rec.....	6-14
chg-tbl.....	6-16
chg-upgrade-config.....	6-18
clr-disk-stats.....	6-19
copy-tbl.....	6-19
dbg-ddb.....	6-21
disp-bip.....	6-28

## Alphabetical List of Commands

disp-bp.....	6-30
disp-disk-dir.....	6-32
disp-disk-stats.....	6-37
disp-lba.....	6-38
disp-mem.....	6-40
disp-trace.....	6-42
dlt-bp.....	6-43
dlt-trace.....	6-44
ent-bp.....	6-45
ent-trace.....	6-50
rtrv-upgrade-config.....	6-66
send-msg.....	6-66
set-mem.....	6-69

## Pass-Through Commands

arp.....	7-2
aslog.....	7-5
asplog.....	7-6
assocrtt.....	7-12
connmgr.....	7-14
ftptest.....	7-22
linkinfo.....	7-24
msucount.....	7-35
msuroute.....	7-65
msutrace.....	7-71
netstat.....	7-92
nslookup.....	7-127
ping.....	7-130
sctp.....	7-134
sockrtt.....	7-144
soipdata.....	7-147
soiplog.....	7-149
traceroute.....	7-151
ualog.....	7-161

# Commands Listed by Class

## Introduction

This chapter provides lists of the available non-configurable command classes and an alphabetical list of the commands allowed in each class. The command class Basic is automatically given to all users and terminals as a default.

### Basic

act-echo.....	5-4
act-user.....	5-28
canc-echo.....	5-50
canc-user.....	5-54
chg-pid.....	5-358
dact-cmd.....	5-563
dact-echo.....	5-565
dact-user.....	5-571
dlt-sccp-serv.....	5-652
lock.....	5-1031
login.....	5-1031
logout.....	5-1032
rept-stat-user.....	5-1304
rtrv-cmd.....	5-1359
rtrv-cmdclass.....	5-1361
rtrv-sccp-serv.....	5-1677
rtrv-user.....	5-1843
unlock.....	5-1920

### Database Administration

act-ftp-trns.....	5-11
act-lbp.....	5-15
act-oap-config.....	5-23
chg-acg-mic.....	5-55
chg-acg-noc.....	5-56
chg-ainpopts.....	5-58
chg-appl-rtkey.....	5-62

chg-as.....	5-69
chg-assoc.....	5-70
chg-atinpopts.....	5-78
chg-atm-lps.....	5-82
chg-clkopts.....	5-86
chg-csl.....	5-91
chg-ctrl-feat.....	5-96
chg-dstn.....	5-109
chg-el.....	5-126
chg-frm-pwr.....	5-138
chg-ftp-serv.....	5-140
chg-gsm-msg.....	5-145
chg-gsmmap-scrn.....	5-147
chg-gsmopts.....	5-153
chg-gsms-opcode.....	5-161
chg-gsmssopts.....	5-165
chg-gta.....	5-174
chg-gtcnv.....	5-191
chg-gtt.....	5-194
chg-gttset.....	5-204
chg-gttset.....	5-209
chg-gtw-stp.....	5-210
chg-gws-actset.....	5-210
chg-gws-redirect.....	5-214
chg-inpopts.....	5-217
chg-ip-card.....	5-222
chg-ip-lnk.....	5-225
chg-is41-msg.....	5-228
chg-is41opts.....	5-231
chg-is41smsg.....	5-236
chg-isup-msg.....	5-243

chg-l2t.....	5-245	chg-vflx-opts.....	5-537
chg-l3t.....	5-248	chg-vflx-rn.....	5-540
chg-lbp.....	5-255	chg-vflx-vmsid.....	5-541
chg-lnp-serv.....	5-257	chg-x25-dstn.....	5-543
chg-lnpopts.....	5-260	chg-x25-rte.....	5-544
chg-loopset.....	5-264	chg-x25-slk.....	5-546
chg-ls.....	5-272	chk-unref-ent.....	5-548
chg-lsopts.....	5-292	dlt-acg-mic.....	5-573
chg-m2pa-tset.....	5-295	dlt-acg-noc.....	5-574
chg-map.....	5-297	dlt-appl-rtkey.....	5-574
chg-mrn.....	5-320	dlt-as.....	5-579
chg-netopts.....	5-336	dlt-assoc.....	5-580
chg-npp-as.....	5-338	dlt-card.....	5-580
chg-npp-serv.....	5-347	dlt-csl.....	5-581
chg-npp-srs.....	5-352	dlt-cspc.....	5-585
chg-oap-config.....	5-355	dlt-dlk.....	5-588
chg-ppsopts.....	5-359	dlt-dstn.....	5-588
chg-prefix.....	5-364	dlt-e1.....	5-593
chg-rte.....	5-367	dlt-frm-pwr.....	5-595
chg-rtx.....	5-370	dlt-ftp-serv.....	5-596
chg-sccp-msg.....	5-375	dlt-gserv-data.....	5-597
chg-sccp-serv.....	5-381	dlt-gsmmap-scrn.....	5-599
chg-sccpopts.....	5-388	dlt-gsms-opcode.....	5-600
chg-scr-aftpc.....	5-392	dlt-gsmssn-scrn.....	5-601
chg-scr-blkdpc.....	5-397	dlt-gta.....	5-602
chg-scr-blkopc.....	5-404	dlt-gtenv.....	5-608
chg-scr-cdpa.....	5-410	dlt-gtt.....	5-610
chg-scr-cgpa.....	5-416	dlt-gttset.....	5-612
chg-scr-destfld.....	5-422	dlt-gttset.....	5-615
chg-scr-dpc.....	5-427	dlt-gws-redirect.....	5-616
chg-scr-isup.....	5-432	dlt-home-smsc.....	5-616
chg-scr-opc.....	5-434	dlt-homern.....	5-617
chg-scr-sio.....	5-439	dlt-ip-host.....	5-618
chg-scr-tt.....	5-444	dlt-ip-node.....	5-618
chg-scrset.....	5-446	dlt-ip-rte.....	5-620
chg-sg-opts.....	5-459	dlt-lbp.....	5-622
chg-sid.....	5-462	dlt-lnp-serv.....	5-623
chg-slt.....	5-472	dlt-loopset.....	5-624
chg-srvsel.....	5-473	dlt-ls.....	5-626
chg-ss-appl.....	5-478	dlt-map.....	5-627
chg-ss7opts.....	5-479	dlt-mrn.....	5-631
chg-stpopts.....	5-481	dlt-na.....	5-638
chg-t1.....	5-494	dlt-npp-as.....	5-639
chg-tatr-msg.....	5-497	dlt-npp-srs.....	5-640
chg-tatropts.....	5-499	dlt-prefix.....	5-641
chg-th-alm.....	5-501	dlt-rmt-appl.....	5-642
chg-tifopts.....	5-503	dlt-rte.....	5-644
chg-tinpopts.....	5-508	dlt-rtx.....	5-649
chg-trm.....	5-511	dlt-scr-aftpc.....	5-657
chg-ttmap.....	5-520	dlt-scr-blkdpc.....	5-660
chg-ttr-msg.....	5-521	dlt-scr-blkopc.....	5-663
chg-ttropts.....	5-523	dlt-scr-cdpa.....	5-667
chg-uaps.....	5-527	dlt-scr-cgpa.....	5-670
chg-vflx-cd.....	5-536	dlt-scr-destfld.....	5-673

dlt-scr-dpc.....	5-676	ent-ls.....	5-835
dlt-scr-isup.....	5-679	ent-map.....	5-851
dlt-scr-opc.....	5-680	ent-mrn.....	5-862
dlt-scr-sio.....	5-683	ent-na.....	5-875
dlt-scr-tt.....	5-685	ent-npp-as.....	5-876
dlt-scrset.....	5-686	ent-npp-srs.....	5-885
dlt-shlf.....	5-687	ent-rmt-appl.....	5-889
dlt-slk.....	5-687	ent-rte.....	5-891
dlt-spc.....	5-690	ent-rtx.....	5-895
dlt-srvsel.....	5-691	ent-scr-aftpc.....	5-899
dlt-ss-appl.....	5-693	ent-scr-blkdpc.....	5-903
dlt-subnetid.....	5-694	ent-scr-blkopc.....	5-908
dlt-t1.....	5-694	ent-scr-cdpa.....	5-912
dlt-tt.....	5-695	ent-scr-cgpa.....	5-916
dlt-ttmap.....	5-697	ent-scr-destfld.....	5-921
dlt-uim-acthresh.....	5-698	ent-scr-dpc.....	5-924
dlt-vendid.....	5-699	ent-scr-isup.....	5-928
dlt-vflx-cd.....	5-699	ent-scr-opc.....	5-930
dlt-vflx-rn.....	5-700	ent-scr-sio.....	5-934
dlt-vflx-vmsid.....	5-701	ent-scr-tt.....	5-938
dlt-x25-dstn.....	5-701	ent-scrset.....	5-940
dlt-x25-rte.....	5-702	ent-serial-num.....	5-942
enable-ctrl-feat.....	5-702	ent-shlf.....	5-943
ent-acg-mic.....	5-720	ent-sid.....	5-944
ent-acg-noc.....	5-721	ent-slk.....	5-946
ent-appl-rtkey.....	5-723	ent-spc.....	5-960
ent-as.....	5-728	ent-srvsel.....	5-962
ent-assoc.....	5-729	ent-ss-appl.....	5-965
ent-card.....	5-732	ent-subnetid.....	5-967
ent-csl.....	5-738	ent-t1.....	5-968
ent-cspc.....	5-744	ent-tt.....	5-972
ent-dlk.....	5-747	ent-ttmap.....	5-973
ent-dstn.....	5-749	ent-vendid.....	5-978
ent-e1.....	5-763	ent-vflx-cd.....	5-980
ent-frm-pwr.....	5-767	ent-vflx-rn.....	5-981
ent-ftp-serv.....	5-768	ent-vflx-vmsid.....	5-982
ent-gserv-data.....	5-770	ent-x25-dstn.....	5-984
ent-gsmmap-scrn.....	5-772	ent-x25-rte.....	5-985
ent-gsms-opcode.....	5-778	rept-stat-db.....	5-1144
ent-gsmssn-scrn.....	5-783	rtrv-acg-mic.....	5-1317
ent-gta.....	5-784	rtrv-acg-noc.....	5-1319
ent-gtcnv.....	5-801	rtrv-ainpopts.....	5-1320
ent-gtt.....	5-804	rtrv-appl-rtkey.....	5-1322
ent-gttset.....	5-813	rtrv-as.....	5-1328
ent-gttset.....	5-817	rtrv-assoc.....	5-1329
ent-gws-redirect.....	5-819	rtrv-atinpopts.....	5-1339
ent-home-smsc.....	5-822	rtrv-atm-lps.....	5-1340
ent-homern.....	5-822	rtrv-atm-prm.....	5-1345
ent-ip-host.....	5-823	rtrv-card.....	5-1352
ent-ip-node.....	5-824	rtrv-clkopts.....	5-1358
ent-ip-rte.....	5-827	rtrv-csl.....	5-1362
ent-lbp.....	5-829	rtrv-cspc.....	5-1369
ent-lnp-serv.....	5-831	rtrv-ctrl-feat.....	5-1371
ent-loopset.....	5-833	rtrv-data-rtdb.....	5-1376

rtrv-dlk.....	5-1384	rtrv-rtx.....	5-1666
rtrv-dstn.....	5-1387	rtrv-sccp-msg.....	5-1675
rtrv-el.....	5-1419	rtrv-sccpopts.....	5-1680
rtrv-frm-pwr.....	5-1425	rtrv-scr-aftpc.....	5-1683
rtrv-ftp-serv.....	5-1426	rtrv-scr-blkdpc.....	5-1688
rtrv-gserv-data.....	5-1436	rtrv-scr-blkopc.....	5-1694
rtrv-gsm-msg.....	5-1438	rtrv-scr-cdpa.....	5-1699
rtrv-gsmmap-scrn.....	5-1439	rtrv-scr-cgpa.....	5-1705
rtrv-gsmopts.....	5-1448	rtrv-scr-destfld.....	5-1711
rtrv-gsms-opcode.....	5-1449	rtrv-scr-dpc.....	5-1717
rtrv-gsmsmsopts.....	5-1454	rtrv-scr-isup.....	5-1723
rtrv-gsmssn-scrn.....	5-1454	rtrv-scr-opc.....	5-1726
rtrv-gta.....	5-1456	rtrv-scr-sio.....	5-1732
rtrv-gtcnv.....	5-1480	rtrv-scr-tt.....	5-1736
rtrv-gtt.....	5-1481	rtrv-scrset.....	5-1739
rtrv-gttset.....	5-1497	rtrv-seas-config.....	5-1743
rtrv-gttset.....	5-1504	rtrv-serial-num.....	5-1758
rtrv-gtw-stp.....	5-1508	rtrv-sg-opts.....	5-1758
rtrv-gtwy-acthresh.....	5-1508	rtrv-shlf.....	5-1759
rtrv-gtwy-prmtrs.....	5-1509	rtrv-slk.....	5-1768
rtrv-gws-actset.....	5-1510	rtrv-slt.....	5-1775
rtrv-gws-redirect.....	5-1511	rtrv-spc.....	5-1777
rtrv-home-smsc.....	5-1512	rtrv-srvsel.....	5-1781
rtrv-homern.....	5-1513	rtrv-ss-appl.....	5-1787
rtrv-inpopts.....	5-1514	rtrv-ss7opts.....	5-1788
rtrv-ip-card.....	5-1517	rtrv-stp.....	5-1789
rtrv-ip-host.....	5-1519	rtrv-stpopts.....	5-1800
rtrv-ip-lnk.....	5-1523	rtrv-subnetid.....	5-1804
rtrv-ip-node.....	5-1524	rtrv-t1.....	5-1806
rtrv-ip-rte.....	5-1528	rtrv-tatr-msg.....	5-1808
rtrv-is41-msg.....	5-1529	rtrv-tatropts.....	5-1809
rtrv-is41opts.....	5-1530	rtrv-tbl-capacity.....	5-1810
rtrv-is41smsopts.....	5-1531	rtrv-th-alm.....	5-1813
rtrv-isup-msg.....	5-1532	rtrv-tifopts.....	5-1814
rtrv-l2t.....	5-1534	rtrv-tinpopts.....	5-1815
rtrv-l3t.....	5-1537	rtrv-trbltx.....	5-1817
rtrv-lbp.....	5-1539	rtrv-trm.....	5-1822
rtrv-lnp-serv.....	5-1542	rtrv-tt.....	5-1833
rtrv-lnpopts.....	5-1544	rtrv-ttmap.....	5-1836
rtrv-loopset.....	5-1556	rtrv-ttr-msg.....	5-1839
rtrv-ls.....	5-1559	rtrv-ttropts.....	5-1840
rtrv-m2pa-tset.....	5-1580	rtrv-uaps.....	5-1841
rtrv-map.....	5-1583	rtrv-uim-acthresh.....	5-1843
rtrv-mrn.....	5-1598	rtrv-vendid.....	5-1846
rtrv-na.....	5-1606	rtrv-vflx-cd.....	5-1847
rtrv-netopts.....	5-1607	rtrv-vflx-opts.....	5-1850
rtrv-npp-as.....	5-1608	rtrv-vflx-rn.....	5-1851
rtrv-npp-serv.....	5-1609	rtrv-vflx-vmsid.....	5-1854
rtrv-npp-srs.....	5-1613	rtrv-x25-dstn.....	5-1856
rtrv-oap-config.....	5-1615	rtrv-x25-rte.....	5-1857
rtrv-ppsopts.....	5-1631	rtrv-x25-slk.....	5-1861
rtrv-prefix.....	5-1635	set-gtwy-acthresh.....	5-1863
rtrv-rmt-appl.....	5-1636	set-scrrej-prmtrs.....	5-1864
rtrv-rte.....	5-1637	set-uim-acthresh.....	5-1867



tst-msg.....	5-1878
tst-npp-msg.....	5-1900

**System Maintenance**

act-alm-trns.....	5-1
act-file-trns.....	5-5
act-flash.....	5-8
alw-card.....	5-29
alw-imt.....	5-32
alw-map-ss.....	5-33
alw-trm.....	5-35
aud-data.....	5-36
canc-alm-trns.....	5-47
chg-db.....	5-103
chg-seas-config.....	5-448
clr-imt-stats.....	5-550
conn-imt.....	5-552
copy-disk.....	5-553
copy-fta.....	5-555
copy-gpl.....	5-557
copy-meas.....	5-559
dact-alm-trns.....	5-562
dact-rstst.....	5-568
disc-imt.....	5-571
disp-fta-dir.....	5-572
dlt-fta.....	5-595
flash-card.....	5-988
format-disk.....	5-991
inh-alm.....	5-996
inh-card.....	5-1004
inh-imt.....	5-1006
inh-map-ss.....	5-1007
inh-trm.....	5-1010
init-card.....	5-1011
init-flash.....	5-1017
init-imt-gpl.....	5-1021
init-mux.....	5-1022
init-network.....	5-1023
init-oap.....	5-1026
init-sys.....	5-1028
pass.....	5-1033
rept-imt-info.....	5-1039
rept-imt-lvl1.....	5-1065
rept-imt-lvl2.....	5-1079
rept-stat-alm.....	5-1092
rept-stat-applsock.....	5-1098
rept-stat-as.....	5-1100
rept-stat-assoc.....	5-1101
rept-stat-card.....	5-1104
rept-stat-cdt.....	5-1130
rept-stat-clk.....	5-1131
rept-stat-cluster.....	5-1138
rept-stat-ddb.....	5-1160

rept-stat-dlk.....	5-1165
rept-stat-dstn.....	5-1166
rept-stat-e1.....	5-1179
rept-stat-enet.....	5-1182
rept-stat-eroute.....	5-1183
rept-stat-imt.....	5-1196
rept-stat-iptps.....	5-1199
rept-stat-lnp.....	5-1204
rept-stat-ls.....	5-1212
rept-stat-meas.....	5-1218
rept-stat-mon.....	5-1221
rept-stat-mps.....	5-1227
rept-stat-mux.....	5-1234
rept-stat-rtd.....	5-1235
rept-stat-rte.....	5-1240
rept-stat-rtkey.....	5-1250
rept-stat-rtx.....	5-1251
rept-stat-sccp.....	5-1257
rept-stat-seas.....	5-1272
rept-stat-slan.....	5-1277
rept-stat-slk.....	5-1280
rept-stat-sys.....	5-1288
rept-stat-t1.....	5-1292
rept-stat-trbl.....	5-1295
rept-stat-trm.....	5-1300
rept-stat-xlist.....	5-1304
rls-alm.....	5-1308
rmv-card.....	5-1309
rmv-imt.....	5-1310
rmv-trm.....	5-1311
rst-card.....	5-1312
rst-dstn.....	5-1313
rst-imt.....	5-1315
rst-trm.....	5-1316
rtrv-bip.....	5-1347
rtrv-log.....	5-1545
rtrv-obit.....	5-1616
rtrv-trbl.....	5-1816
tst-bip.....	5-1868
tst-disk.....	5-1869
tst-e1.....	5-1874
tst-imt.....	5-1876
tst-t1.....	5-1908
unhb-alm.....	5-1912

**Link Maintenance**

act-cdl.....	5-2
act-dlk.....	5-3
act-lpo.....	5-21
act-slk.....	5-26
alw-slk.....	5-34
blk-slk.....	5-45
canc-dlk.....	5-50

canc-lpo..... 5-51  
 canc-slk..... 5-53  
 chg-meas..... 5-309  
 chg-measopts..... 5-311  
 chg-mtc-measopts..... 5-333  
 dact-cdl..... 5-562  
 dact-lbp..... 5-566  
 dact-slk..... 5-569  
 inh-slk..... 5-1009  
 rept-ftp-meas..... 5-1035  
 rept-meas..... 5-1083  
 rept-stat-cdl..... 5-1129  
 rept-stat-lfs..... 5-1203  
 rept-stat-tstslk..... 5-1302  
 rept-x25-meas..... 5-1305  
 rtrv-meas-sched..... 5-1593  
 rtrv-measopts..... 5-1596  
 rtrv-mtc-measopts..... 5-1604  
 tst-dlk..... 5-1873  
 tst-slk..... 5-1903  
 ublk-slk..... 5-1910  
 unhb-slk..... 5-1918

**Program Update**

act-gpl..... 5-12  
 chg-feat..... 5-130  
 chg-gpl..... 5-141  
 rept-stat-gpl..... 5-1188  
 rtrv-feat..... 5-1423  
 rtrv-gpl..... 5-1430

**Security Administration**

canc-cmd..... 5-47  
 chg-attr-seculog..... 5-85  
 chg-cmd..... 5-88  
 chg-cmdclass..... 5-90  
 chg-eisopts..... 5-129  
 chg-secu-dflt..... 5-450  
 chg-secu-trm..... 5-455  
 chg-user..... 5-531  
 copy-seculog..... 5-560  
 dlt-user..... 5-698  
 ent-user..... 5-974  
 rept-stat-seculog..... 5-1275  
 rtrv-attr-seculog..... 5-1346  
 rtrv-eisopts..... 5-1422  
 rtrv-secu-dflt..... 5-1744  
 rtrv-secu-trm..... 5-1746  
 rtrv-secu-user..... 5-1748  
 rtrv-seculog..... 5-1751  
 rtrv-sid..... 5-1761  
 set-date..... 5-1862

set-time..... 5-1865

**LNP Basic**

**LNP Database**

chg-lnp-ttmap..... 5-259

**LNP Subscription**

**Debug**

act-upgrade..... 6-1  
 edu..... 6-6  
 chg-bip-flt..... 6-13  
 chg-bip-rec..... 6-14  
 chg-tbl..... 6-16  
 chg-upgrade-config..... 6-18  
 clr-disk-stats..... 6-19  
 copy-tbl..... 6-19  
 dbg-ddb..... 6-21  
 disp-bip..... 6-28  
 disp-bp..... 6-30  
 disp-disk-dir..... 6-32  
 disp-disk-stats..... 6-37  
 disp-lba..... 6-38  
 disp-mem..... 6-40  
 disp-trace..... 6-42  
 dlt-bp..... 6-43  
 dlt-trace..... 6-44  
 ent-bp..... 6-45  
 ent-trace..... 6-50  
 rtrv-upgrade-config..... 6-66  
 send-msg..... 6-66  
 set-mem..... 6-69

**Pass-Through**

arp..... 7-2  
 aslog..... 7-5  
 asplog..... 7-6  
 assocrtt..... 7-12  
 connmgr..... 7-14  
 ftptest..... 7-22  
 linkinfo..... 7-24  
 msucount..... 7-35  
 msuroute..... 7-65  
 msutrace..... 7-71  
 netstat..... 7-92  
 nslookup..... 7-127  
 ping..... 7-130  
 sctp..... 7-134

sockrtt.....	7-144
soipdata.....	7-147
soiplog.....	7-149
traceroute.....	7-151
ualog.....	7-161



# Using Commands

## Introduction

This chapter provides the following information:

- A description of the system's Maintenance and Administration Subsystem
- A description of the system's input and output devices
- A description of how to enter commands
- The procedures for logging into and out of the system

This chapter is intended to assist personnel responsible for the system.

## Maintenance and Administration Subsystem

The Maintenance and Administration Subsystem (MAS) is the central management point for the EAGLE 5 ISS. The MAS provides user interface, maintenance communication, peripheral services, alarm processing, system disk interface, and measurements. Management and redundancy is provided by use of two separate subsystem processors.

The MAS resides on two separate sets of Maintenance and Administration Subsystem Processor (MASP) cards and a Maintenance Disk and Alarm card (collectively referred to as control cards). The control cards are located in slots 1113 through 1118 of the EAGLE 5 ISS Control Shelf. The control cards can be either E5-based cards or legacy cards.

**NOTE: During normal operation, the E5-based control cards and legacy control cards cannot be mixed in one EAGLE 5 ISS control shelf.**

## Legacy Control Cards

The legacy set of EAGLE 5 ISS control cards consists of the following cards:

- Two MASP card sets; each set contains two cards:
  - A General Purpose Service Module II card
  - A Terminal Disk Module card

- One Maintenance Disk and Alarm (MDAL) card

### **General Purpose Service Module II (GPSM-II) Card**

Each GPSM-II card contains the Communications Processor and the Applications Processor and provides connections to the IMT bus. The card controls the maintenance and database administration activity and performs both application and communication processing. GPSM-II cards are located in slots 1113 and 1115 of the control shelf.

### **Terminal Disk Module (TDM) Card**

Each TDM card provides the Terminal Processor for the 16 I/O ports, and interfaces to the Maintenance Disk and Alarm (MDAL) card. The TDM card also distributes Composite Clocks and High Speed Master clocks throughout the EAGLE 5 ISS, and distributes Shelf ID to the EAGLE 5 ISS. Each TDM card contains one fixed drive that is used to store primary and backup system databases, measurements, and Generic Program Loads (GPLs). The TDM cards are located in slots 1114 and 1116 of the control shelf.

### **Maintenance Disk and Alarm (MDAL) Card**

The MDAL card processes alarm requests and provides fan control. There is only one MDAL card in a control card set. Critical, major, and minor system alarms are provided for up to 6 individual frames. In addition to the 3 system alarms, the E5-MDAL card provides the system audible alarm. The E5-MDAL card provides control of fans on a per-frame basis and allows for each fan relay to be set individually. The MDAL card contains a removable cartridge drive; the cartridge is used for installing new software; backing up the system software, the application software, and the database; and for downloading data for off-line processing. The MDAL card is located in slots 1117 and 1118 of the control shelf.

## **E5-based Control Cards**

The E5-based set of EAGLE 5 ISS control cards consists of the following cards:

- Two Maintenance and Administration Subsystem Processor cards (E5-MASP cards). Each dual-slot E5-MASP card is made up of two modules:
  - Maintenance Communication Application Processor (E5-MCAP) card
  - Terminal Disk Module (E5-TDM) card
- One Maintenance Disk and Alarm card (E5-MDAL card)

### **Maintenance Communication Application Processor (E5-MCAP) Card**

The E5-MCAP card contains the Communications Processor and Applications Processor and provides connections to the IMT bus. The card controls the maintenance and database administration activity and performs both application and communication processing. E5-MCAP cards are located in slots 1113 and 1115 of the control shelf.

Each E5-MCAP card contains one latched USB port for use with removable flash media (“thumb drive”), and one flush-mounted USB port for use with a plug-in “credit card” flash drive. The removable media drive is used to install and back up customer data. The credit card drive is used for upgrade and could be used for disaster recovery.

### Terminal Disk Module (E5-TDM) Card

The E5-TDM card provides the Terminal Processor for the 16 I/O ports, and interfaces to the Maintenance Disk and Alarm (E5-MDAL) card and fixed disk storage. The E5-TDM card also distributes Composite Clocks and High Speed Master clocks throughout the EAGLE 5 ISS, and distributes Shelf ID to the EAGLE 5 ISS. Each E5-TDM card contains one fixed SATA drive that is used to store primary and backup system databases, measurements, and Generic Program Loads (GPLs). E5-TDM cards are located in slots 1114 and 1116 of the control shelf.

### Maintenance Disk and Alarm (E5-MDAL) Card

The E5-MDAL card processes alarm requests and provides fan control. There is only one E5-MDAL card in a control card set. Critical, major, and minor system alarms are provided for up to 6 individual frames. In addition to the 3 system alarms, the E5-MDAL card provides the system audible alarm. The E5-MDAL card provides control of fans on a per-frame basis, and allows for each fan relay to be set individually. The E5-MDAL card does not contain a removable cartridge drive; drives for removable media are located on the E5-MCAP card. The E5-MDAL card is located in slots 1117 and 1118 of the control shelf.

## Input/Output Devices

There are two types of Input/Output (I/O) devices: terminals and printers. All I/O devices are connected to the system through the control shelf backplane. Each I/O device is described in terms of its function and its connection to the system. Refer to the *Installation Manual - EAGLE 5 ISS* for backplane connection information.

### Terminals and Printers

The EAGLE 5 ISS uses VT320 terminals for maintenance and database administration. The EAGLE 5 ISS also can be configured to communicate with the SEAS interface (OAP). The terminals enable you to enter information into or receive information from the system. The system is capable of communicating with terminals at data rates from 2400 to 19,200 baud, using the ASCII character set.

You must configure terminals to operate with the system. You also must set printers (and modems) for hardware flow control. To do this, enable Data Terminal Ready (DTR) through your terminal's configuration menu. A modem also must have DCD set on "high." If your terminal has the auto-wrap feature, ensure that it is disabled before using your terminal on the system.

For information on the setup values for printers and terminals on the system, see the **chg-trm** command.

Terminals provide the following capabilities:

- Command input and output
- Continuous alarm states
- Event/Error messages

You enter commands at the terminal to perform system operations such as displaying the system status, administering system security, and maintaining the database.

An example of a terminal screen is shown in Figure 4-1. Note that the alarm status area is labeled either Total Alarm Status or Active Alarm Status depending on how the VT320 terminal is configured. See the **chg-stpopts** command description for configuration information.

Alarms are displayed in the alarm status area of the terminal screen. The alarm levels are as follows:

- Critical – Indicates a severe, service-affecting condition has occurred and that immediate corrective action is needed, regardless of the time of day or the day of the week.
- Major – Indicates a serious disruption of service or the failure of important circuits is taking place. These troubles require attention and response to restore or maintain system capability.
- Minor – Indicates a trouble, but one that does not have a serious affect on service.
- Inhibited – Indicates a device in the system with an inhibited alarm. A temporarily or permanently inhibited alarm does not generate unsolicited output or cause alarm indicators to be turned on. See the **inh-alm** command description for information on inhibited alarms.

Figure 4-1. System Terminal User Display

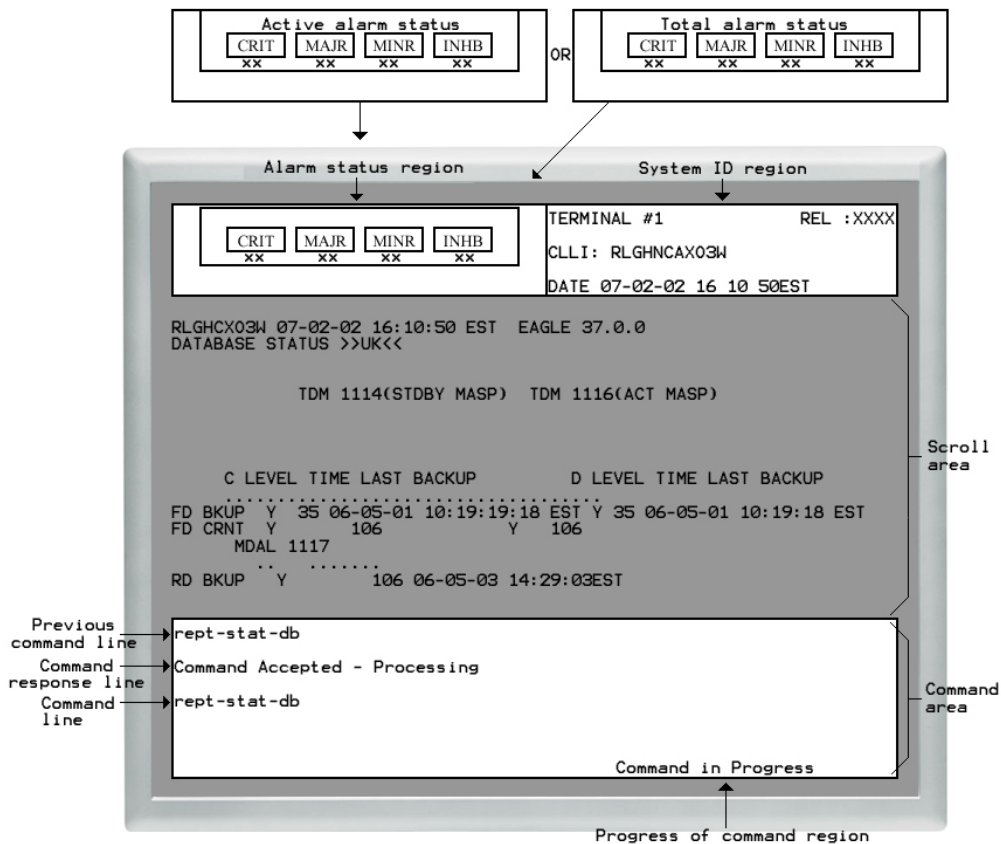

Event/Error messages also are issued to terminals to report system conditions or events. If the condition or event affects service, an alarm is issued along with an Event/Error message. Event/Error messages are displayed in the scroll area of the terminal screen.

Use the command line region of the terminal display ( ) to enter commands. The command line region consists of two lines. Each of these lines can hold up to 80 characters. If you enter a command of more than 80 characters in length, the command appears on both lines. When you press the Enter



key, only the first 80 characters are displayed in the previous command line, followed by a message on the command response line showing the status of the command. The remaining characters have not been rejected; they are not displayed due to line length limitations. If you recall the command by pressing the Up arrow key or Down arrow key, all the characters in the command are displayed. For a description of the arrow key functions, see Table 4-2.

## Terminal and Printer Connections

Terminals and printers are connected to the Terminal Disk Module (TDM), using the control shelf backplane. The TDM also provides Keyboard Send and Receive (KSR) function. See "KSR Function on VT320 Terminal Devices" on page 4-5 for more information on the KSR function. A description of the TDM can be found in the *Installation Manual - EAGLE 5 ISS*.

## KSR Function on VT320 Terminal Devices

The terminals can use the keyboard send and receive (KSR) mode of operation. KSR refers to a device or mode of operation that prints or displays all received data. The KSR mode of operation typically supports a teletype printer, but in the system, it also supports a video display unit and keyboard.

The KSR feature enables you to attach a dumb terminal device or teletype printer to the system's I/O ports or emulate KSR mode of operation on a VT320. KSR enhances the system's dial-up administration functions by allowing faster throughput, because the screen formatting characters associated with the VT320 mode of operation need not be transmitted.

## KSR Configuration

This feature allows you to configure the operational characteristics of system's I/O serial ports to support KSR terminal devices. See Table 4-2 for a list of the keyboard functions used by the KSR feature. For information on configuring a serial I/O port for KSR operation, see the *Database Administration Manual - SS7*.

## Changing the Mode Of Operation

Before you attempt to change the mode of operation of the terminal, you *must* follow the "Changing the Terminal Characteristics" procedure found in the *Database Administration Manual - SS7*. You must perform this procedure from another terminal.

You can change the mode of operation of the terminal by pressing the **F11** key. The **F11** key instructs the system to mimic a KSR. Command line editing operates exactly like the VT320.

The KSR emulation resembles a printer when in operation. The entire screen is used for output. Before you enter a command, press <Ctrl-A>. The command prompt (>) is displayed. Enter a carriage return to signify the end of command entry.

While in the KSR mode, all output to the video display unit is buffered. When any character is entered from the terminal, a one-minute timer is started and data reception from the system is stopped. The system responds to the command with the appropriate response, then resumes sending data where it left off.

If a carriage return is not received during command entry, a time-out occurs and the system resumes sending data to the terminal.

## Requirements

The KSR function operates on any combination of terminal type assignments for the 16 available terminal ports.

## Telnet Terminals

Telnet is a user command using the underlying TCP/IP protocol for accessing remote computers. Telnet provides a connection from a remote (client) to a host (server) computer; the client keyboard and monitor (or window) act as if physically attached to the host computer. Remote users log on as if they were local users with whatever privileges may have been granted to the specific applications and data on the remote computer. Remote users, after they log in, can use the same services as a local user.

The IP User Interface feature permits any standard telnet client to act as an EAGLE 5 ISS terminal. This IP-based access provides a standard interface through which EAGLE 5 ISS commands are entered from a telnet session to the EAGLE 5 ISS. The EAGLE 5 ISS then provides command responses back to the remote telnet terminal.

Up to 3 IPSM cards in the EAGLE 5 ISS, with IP connectivity, enable telnet clients to connect from anywhere on the customer's IP LAN. The EAGLE 5 ISS must be on the customer's LAN or WAN. Each IPSM card provides 8 telnet terminal ports (IDs 17-24 for the first card installed, 25-32 for the second card installed, and 33-40 for the third card installed), which are automatically made available when the card is installed and provisioned. See the **chg-trm** command description in this manual for more information about configuring telnet terminals. Refer to the "Adding an IPSM" procedure in the Database Administration Manual for information on configuring the IPSM.

From the telnet client, the remote user connect to any one of the equipped IPSM cards available by entering the command **telnet** *<IP address>*. For example,

```
telnet 192.168.1.100
```

The remote user then selects a terminal number from a list of available terminals. If an incorrect terminal number (one not listed in the prompt) is selected, the prompt appears again. (After three incorrect tries, the session is closed.) After the session is accepted, an EAGLE 5 ISS welcome message appears. At this point, broadcast messages (if provisioned) will begin to appear. See Figure 4-2.

Figure 4-2. Telnet Terminal Selection and Login

```

Telnet - [None]
Connect Edit Terminal Help
telnet 192.169.1.100
Connected..
Welcome to Eagle.

Select a terminal from the list below:
(17, 18, 19, 22, 24)
> 21
21 is not a valid selection.

Select a terminal from the list below:
(17, 18, 19, 22, 24)
> 17
Connection established as terminal 17.

      eagle10110 01-10-15 09:56:00 GMT Rel 29.0.0-40.27.0
      7630.0046   TERMINAL    17           Terminal enabled
;

> login:uid=eagle

Enter Password :

Command Accepted - Processing

      eagle10110 01-10-15 10:00:16 GMT Rel 29.0.0-40.27.0
      login:uid=eagle
      Command entered at terminal #17.
;

      eagle10110 01-10-15 10:00:18 GMT Rel 29.0.0-40.27.0
      User logged in on terminal 17.
;

      eagle10110 01-10-15 10:00:18 GMT Rel 29.0.0-40.27.0
      NOTICE: This is a private computer system.
      Unauthorized access or use may lead to prosecution.
      0 LOGIN failures since last successful LOGIN
      Last successful LOGIN was on port 3 on 01-10-15 @ 09:59:51

```

After a connection is made, the remote user can log in using a pre-provisioned user ID and password. (The user ID and password must be provisioned from an existing serial terminal.) The **login** command can be typed directly, without typing <Ctrl-A> first.

An EAGLE 5 ISS serial terminal emulating a Keyboard Send/Receive (KSR) device is normally in *display mode* (where outgoing messages are displayed). In order to enter a command, the user must interrupt the display by holding down the Ctrl key and typing an “a” (the ATTENTION or Ctrl-A key sequence). When the terminal controller receives an ATTENTION, it enters a *command entry mode*. The output text is temporarily halted, and the prompt symbol “>” appears.

The telnet terminal enters *command entry mode* when any key is pressed; <Ctrl-A> is not needed.

After the login is accepted and the user presses a key to receive the standard EAGLE 5 ISS command line prompt, all EAGLE 5 ISS commands assigned to that user ID are now accessible.

The display of broadcast messages can be interrupted with any keystroke, and will resume after a command is entered or a set timeout expires. When in command entry mode, the telnet server holds any outgoing messages in a buffer while a command is entered. A command entry is completed by pressing the Enter key.

The telnet server waits up to 60 seconds between keystrokes for the command text to be completed, before timing out and resuming the broadcast display. If the command entry times out, and output resumes, the incomplete command text might scroll off the screen. Even though the incomplete command was not executed, it is saved as an entry in the command buffer. This incomplete command will be displayed again when any key is pressed. The command string can be finished by continuing the typing where it was interrupted. Pressing the Enter key submits this command as usual.

Broadcast messages are held in a buffer from the time a key is pressed, until the command is complete (timed out, aborted, cancelled, or rejected). This is to allow command responses to be completely displayed. After the command completes, broadcast messages (if provisioned) will resume. The IPSM card buffer will hold up to 30 minutes of broadcast output before discarding the oldest messages.

When the user enters the **logout** command to end the telnet session, the user is logged off of the EAGLE 5 ISS, but the port remains assigned to the EAGLE 5 ISS telnet terminal. If the active port connection is lost for a reason such as hardware fault or system interruption, the telnet server resets affected ports, the session is closed, and the user ID is logged off.

The OA&M IP Security Enhancement feature provides secure connections to the EAGLE 5 ISS. Refer to Appendix B of the Database Administration Manual - System Management for information on using the PuTTY client to make a secure telnet connection.

## SEAS Terminals

The SEAS Over IP feature introduces a TCP/IP-based interface for SEAS. The SEAS interface constitutes the path between the EAGLE 5 ISS and a Common Channel Signaling Message Router (CCS MR). The EAGLE 5 ISS uses the IP User Interface feature and E5-IPSM cards instead of EOAP to provide the paths for each SEAS TCP/IP link.

The E5-IPSM card allows one of the eight IP terminals to function as a SEAS terminal and provide connectivity between the CCS MR and the EAGLE 5 ISS. The E5-IPSM card also continues to provide the EAGLE 5 ISS with generic IP-based services, such as Telnet and FTP on the remaining seven IP terminals.

A maximum of 2 SEAS terminals can be configured in the EAGLE 5 ISS.

The **chg-trm:type=seas** command can be entered for terminals 17 - 40 when all conditions for a terminal to be set as a SEAS terminal are met.

The SEAS output group cannot be turned off for a SEAS terminal.

## Element Management System Alarm Monitor Terminals

Element Management System Alarm Monitor (EMSALM) terminals display UAM alarm set and clear messages and the UIM 1083 “system alive” messages only. No other messages (including reports and other UIMs) are displayed. EMSALM terminals are designed to display alarm messages only. EMSALM terminals are not restricted in any other way. They can accept login, and commands; however these operations may interfere with alarm monitoring and should be performed on an alternate terminal.

Serial port terminal IDs 1-16 can be assigned as EMSALM terminals. These EMSALM terminals are a refinement of the KSR terminal, and contain all the KSR terminal communication parameters.

Telnet terminal IDs 17-40 can be assigned as EMSALM terminals when the IP User Interface feature is enabled and turned on and up to 3 IPSM cards are equipped in the system (see "Telnet Terminals" on page 4-6). These EMSALM terminals have all of the functions of a telnet type terminal.

When the **chg-trm** command is entered to change a terminal to the EMSALM type, all output group parameter values for that terminal default to YES, even if they were set to NO before the change. Even though an output group is set to YES for an EMSALM terminal, no reports or UIMS other than UIM 1083 will appear for that output group. Individual output group values can be changed to NO by entering another **chg-trm** command for an EMSALM terminal (do this only with caution; it can cause loss of UAM alarm messages at the EMSALM terminal).

When the **chg-trm** command is entered to change a terminal from type EMSALM to another type, the output group values remain unchanged. A **chg-trm** command can be entered to change output group settings.

## About Commands

Commands allow you to interact with the system to perform specific functions. Commands are available to perform the following functions:

- Obtain system status and operational status
- Modify system configuration
- Obtain measurement reports

The following sections describe how to enter commands through a system terminal. Command correction, keywords, parameters, and syntax are described.

## Entering Commands

All commands are entered at the command prompt (>), located in the bottom window of the terminal display. After entering a command, you must press the **Enter** key. When the command has executed (an output message appears in the display to indicate execution), you can enter another command. The **F9** function key allows you to interrupt a running command; however, you cannot enter another command until the running command completes its operation.

Commands are not case sensitive; therefore, either uppercase or lowercase characters can be used. Intermixing (using both upper and lower case) characters does not create an error message, but you must use the correct command syntax.

## Action Commands

Throughout this manual, the term "action command" is used in the description of some dependencies, as in the sentence "No other action command can be in progress when this command is entered."

Action commands are used to effect changes to the state of entities within the system, such as cards and signaling links. For example, you use the **inh-card** command to change the state of the card to Out-of-Service - Maintenance Disabled (OOS-MT-DSBLD).

Table 4-1 lists the action commands and shows which type of system entity they are associated with.

**Table 4-1.** Action Commands and Their Associated System Entity

Action Commands	System Entity
<b>act-slk, alw-slk, canc-slk, dact-slk, inh-slk, unhb-slk, blk-slk, ublk-slk, tst-slk</b>	Link Commands
<b>act-alm-trns, canc-alm-trns, rls-alm</b>	Alarm Commands
<b>alw-trm, inh-trm</b>	Terminal Commands
<b>alw-card, inh-card, rmv-card, rst-card</b>	Card Commands

### Command Keywords and Parameters

Commands consist of two parts: keywords and parameters. Keywords identify the principal action to be performed by the system, and consist of one to three words. Most commands also require parameters to further define the command operation.

Parameters are entered after the keyword. Each parameter must be separated from the keyword or the previous parameter with a colon. If a parameter has multiple values, the values entered are discrete and must be separated with a hyphen or comma. The parameters can be entered in any order.

Some command parameters have built-in default values that are used if a value is not specified. To accept a default value, press **Enter** after the desired keyword and parameters have been entered.

Use the following delimiters when entering commands:

- : —separates parameters
- or , —separates multiple values within a parameter block
- = —use as delimiter between the parameter and input value

The following is an example of a command entry:

```
> dact-slk:loc=1101:port=a
```

The keyword in the above example is **dact-slk** (Deactivate Signaling Link). The first parameter for this command is **loc=1101** (the actual card location in the system for the link being cancelled, based on equipment location). The second parameter is **port=a**. This parameter signifies which signaling link port on the card in the designated location has the link that is to be cancelled.

If an error is made while typing commands, use the **Delete** key to make corrections, one character at a time.

**NOTE: If the same parameter is entered more than once in a command, the system accepts the last parameter value that was entered. Any values for the parameter that were entered earlier in the command are ignored.**

## Keyboard Functions

Some keyboard functions used with commands are described in the previous section. Keyboard functions available for use with commands are listed in Table 4-2. Arrow key functions are further described following the table.

**Table 4-2.** Keyboard Functions

VT320 Key Sequence	KSR Key Sequence	Description
↑	↑	The Up arrow key recalls the previous commands entered at the prompt, one command at a time. The Up arrow key scrolls backwards through up to 10 commands for a KSR, VT320, or SCCS terminal, and up to 20 commands for an IP UI telnet terminal. See page 4-13 for a description of the Up arrow key functions.
←	←	The Left arrow key backspaces the underline cursor without erasing.
↓	↓	The Down arrow key recalls the previous command entered at the prompt, one parameter at a time. If the Up arrow key is pressed and more than one command has been entered in the session, pressing the Down arrow key displays one previously entered command at a time. The Down arrow key scrolls forward through up to 10 commands for KSR, VT320, and SCCS terminals and up to 20 commands for IP UI telnet terminals. See page 4-14 for a description of the down arrow key functions.
→	→	The Right arrow key recalls the last command entered at the prompt, one character at a time.
<b>F6</b>	<b>F6</b>	The <b>F6</b> Function key refreshes the terminal screen, including any characters already input on the command line and the command response line.
<b>F7</b>	<b>F7</b>	The <b>F7</b> Function key clears the scroll buffer. This enables a user to stop useless information from passing to the scroll region of the system terminal.
<b>F8</b>	<b>F8</b>	The <b>F8</b> function key enables you to stop and restart the scrolling of information on the terminal screen.

Table 4-2. Keyboard Functions

VT320 Key Sequence	KSR Key Sequence	Description
<b>F9</b>	<b>F9</b>	The <b>F9</b> Function key allows you to interrupt a running command so that you can enter another command. Output and processing of the interrupted command continue. Pressing <b>F9</b> is the same as issuing the <b>canc-cmd</b> command with no parameters. The commands that can be interrupted by pressing <b>F9</b> are listed in the description of the <b>canc-cmd</b> command.  If the terminal is running one of the listed commands and you press <b>F9</b> , output and processing are cancelled. This function works only on the same terminal that is running the command you want to cancel. To cancel a command from another terminal, use the <b>canc-cmd:trm=</b> command (see the <b>canc-cmd</b> command description).
<b>F10</b>	<b>F10</b>	The <b>F10</b> Function key displays help information for the last command that was entered, including parameters, parameter formats, and the command class.
<b>F11</b>	<b>F11</b>	The <b>F11</b> Function key allows you to toggle the terminal's mode of operation from VT320 to KSR and from KSR to VT320. This function key has no effect on IP UI telnet terminals.
Not Available	Control-A	Control-A allows you to enter a command in the KSR mode.
Control-S	Control-S	Used with the <i>sw</i> or <i>both</i> flow control (see the <b>chg-trm</b> command description for more information), this key sequence sends the XOFF character to temporarily stop sending data.
Control-Q	Control-Q	Used with the <i>sw</i> or <i>both</i> flow control (see the <b>chg-trm</b> command description for more information), this key sequence sends the XON character to resume sending data.
Ins	Ins	When Insert is toggled on, typed characters are inserted into the command line, moving existing characters to the right. When toggled off, typed characters overwrite existing characters.



Table 4-2. Keyboard Functions

VT320 Key Sequence	KSR Key Sequence	Description
Del	Del	Deletes one character at a time from the right; the cursor stays in position.
Backspace	Backspace	Deletes a character and moves the cursor one space to the left.

## Arrow Key Operation

The arrow keys are used to move the cursor to a different position in a command, and to display part or all of a command that was previously entered.

On KSR, VT320, and SCCS terminals, you can scroll through the last 10 commands that were entered at the terminal during the session. On IP UI telnet terminals, you can scroll through the last 20 commands that were entered at the terminal during the session. Part or all of one command at a time is displayed. When you have scrolled through the complete list of up to 10 or 20 commands, the scrolling wraps back to the beginning of the list.

The list of previously entered commands is cleared when a terminal is inhibited and allowed (**inh-trm:trm=xx** and **alw-trm:trm=xx**) and when a file transfer is initialized with the **act-file-trns** command.

There are two modes of command recall for Up and Down arrow keys:

- **Edit Mode**  
Edit Mode includes any key operation that changes the command at the prompt, such as the Delete key, the Back Space key, or an alphanumeric key. Pressing one of these keys to enter or change a command puts the terminal into Edit Mode. Pressing the Enter key (or carriage return) takes the terminal out of Edit Mode.
- **Non-edit Mode**  
Pressing the Enter key (or carriage return) puts the terminal into Non-edit Mode. A terminal remains in Non-edit Mode when you press an arrow key, a Function key, or the Insert key, which do not change the command at the prompt. When you press a key that changes the command, the terminal goes into Edit Mode until you press the Enter key again.

## Up Arrow Key

The Up arrow key is used to recall up to the last 10 commands (KSR, VT320, and SCCS terminals) or the last 20 commands (IP UI telnet terminals) entered at the prompt during the session.

### In Edit Mode

- You enter 3 characters of a command at the prompt and press the Up arrow key. If the previous command was 6 characters long, then the last 3 characters of the previous command are recalled and displayed after the 3 characters that you entered at the prompt.
- You enter 10 characters of a command at the prompt and press the Up arrow key. If the previous command was 6 characters long, none of the previous command is displayed. The command that you entered remains as you entered it at the prompt.

- Entering part or all of a command at the prompt puts the terminal into Edit Mode. In Edit Mode, the last (or previous) command is recalled only if the command length of the last command is greater than the command at the prompt. For example,;

#### In Non-edit Mode

- When you have pressed the Enter key and there is no command at the prompt, or you have pressed the Insert key or a Function key, the terminal is in Non-edit Mode.
- When you press the Up arrow key in Non-edit Mode, and you have entered at least one previous command, the last command that you entered is displayed at the prompt. Pressing the Up arrow key again clears the command at the prompt (if any) and displays the next previous command that you entered (if any). By continuing to press the Up arrow key, you can scroll backwards through the last 10 commands (KSR, VT320, and SCCS terminals) or the last 20 commands (IP UI telnet terminals) that you entered at the terminal. The display wraps back to the most recent of the entered commands when all of the available commands have been recalled. The terminal remains in Non-edit Mode until you press a key that changes the displayed command.

### Down Arrow Key

In Edit Mode, the Down arrow key recalls the last command that was entered at the terminal, one parameter at a time. The recalled parameter is displayed at the end of the entry that currently appears at the prompt.

In Non-edit Mode:

- If the Up arrow has not been pressed just before pressing the Down arrow key, the Down arrow key recalls the last command that was entered at the terminal, one parameter at a time.
- If the Up arrow key is the last key that was pressed before the Down arrow key is pressed, the Down arrow key scrolls forward through the last 10 commands (KSR, VT320, and SCCS terminals) or last 20 commands (IP UI telnet terminals), displaying one complete command each time the key is pressed. The scrolling wraps to the beginning of the list when all of the available commands have been displayed.

### Right Arrow Key

Each time the Right arrow key is pressed, one character of the last command is recalled and the cursor moves one position to the right. When the last command is completely displayed, pressing the Right arrow key does not cause any cursor movement or character display.

### Left Arrow Key

The Left arrow key moves the underline cursor one position to the left without erasing the character. The underline cursor can be moved until it reaches the first character at the left of the command. If

the Left arrow key is pressed again after the cursor reaches the first character of the command, the bell sounds.

## Command Output and Messages

Reports and outputs generated through retrieve or report status commands are followed by a semi-colon (;) to signify the end of the output (this is in compliance with TL1 standards).

The following types of output messages are used on the system:

- **Command Accepted—Processing:** The command has been accepted by the application's command handler as syntactically correct. This message is displayed in the command area of the terminal display.
- **Command Completed—**The command has been entered, and the system has completed processing. This message is displayed in the scroll area of the terminal display.
- **Command Executed—**The command has been entered, and the system has completed processing. This message is displayed in the command area of the terminal display.
- **Command Failed—**The command was executed but failed due to an external reason, such as the link is not equipped or a disk drive is unable to communicate. The reason for the failure is included in this message.
- **Command Rejected—**The command syntax could be incorrect, or a parameter value is incorrect (semantic error). This message is displayed in the command area of the terminal display. The reason for rejecting the command (command syntax or incorrect parameter value) is included in this message.
- **Command Aborted—**The command syntax and the parameter values are ok, but for some reason the command was aborted (for example, a disk drive is inaccessible). This message is displayed in the scroll area of the terminal display.
- **Command Response Messages—**A command is entered at the terminal, and the response to that command is echoed on that same terminal. These messages are displayed in the scroll area of the terminal display.
- **Unsolicited Messages—**An example of unsolicited messages are the messages delivered in response to alarm conditions. These messages are displayed in the scroll area of the terminal display.

The unsolicited messages can be directed to a specific terminal or printer by using the **chg-trm** command to assign one or more of the following groups of unsolicited output messages to the specified terminal or printer.

Application Server	Application Subsystem
Card	Clock
Debug	Global Title Translation
Gateway Screening	Measurements Maintenance
Monitor	MPS
SEAS Maintenance	SLAN Maintenance
System Maintenance	Security Administration

Traffic Measurements	Database Administration
Link Maintenance	Program Update
LNP Database Administration	LNP Subscription

To configure a terminal to receive unsolicited LNP database administration and LNP subscription messages, the LNP feature must be turned on (see the **enable-ctrl-feat** command).

### Command Output Banners

When a command is executed in the system, one or more banner lines appear in the output that is displayed for the command.

page 4-16 shows the general format of an output banner.

**Figure 4-3.** Output Banner Format

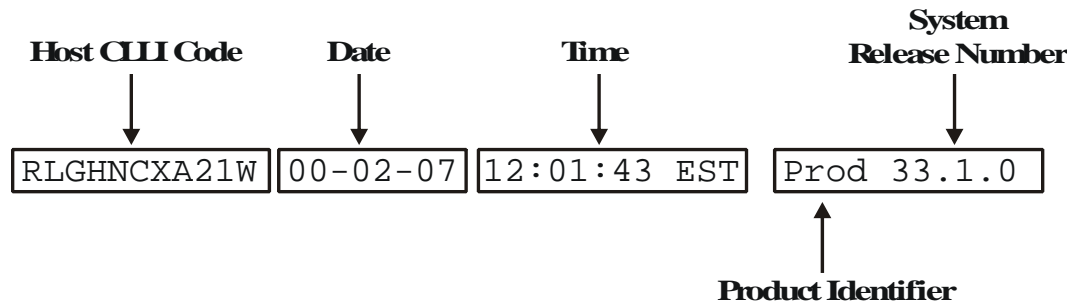

The following fields appear in each output banner:

- **Host CLI code**—a maximum of one alphabetic character and ten alphanumeric characters. The CLI code uniquely identifies the system in terms of its physical location. The CLI code must be unique among all elements in the system. The CLI code contains the following information:
  - City—4 characters
  - State— 2 characters
  - Building— 2 characters
  - Equipment type —3 characters
- Date—year-month-day
- Time—hour: minute: second time zone
- System Release Number— contains a product identifier and the version ID number. The product identifier, which is shown as ‘Prod’ in Figure 4-3 and the output examples in this manual, can appear as “EAGLE” or “EAGLE5” depending on which product key is turned on in the system (see the **rtrv-ctrl-feat** output example). If one or more “EAGLE 5” features are enabled in the system, the EAGLE5 product key must also be turned on and EAGLE5 will appear in the banner. If there are no “EAGLE 5” features enabled in the system, the EAGLE product key will be turned on and EAGLE will appear in the banner. (If both the EAGLE5 and EAGLE product keys are enabled, the EAGLE5 product key should be turned on and appear in the banner).

The version ID number identifies the GPL set that is specific to the software release that is expected to be installed on the system as approved loads. The format of the version ID number is *maj.min.maint*, defined as follows:

- *maj*—the major release ID
- *min*—the minor release ID
- *maint*—the maintenance release ID

## System Security

User IDs and passwords protect the system from unauthorized entry into the system and enhance system security. To enter the system through a terminal, a user must enter a valid user ID and password at the system prompt, and the user ID and password must be authorized for use together. A user ID identifies a user to the system.

To maintain the security of the system, passwords should be changed periodically and user IDs should be deleted whenever there is a personnel change.

When prompted to enter a new password, a different password should be provided. This is the responsibility of the user, and is not enforced by the EAGLE 5 ISS.

### Rules for User ID and Password Administration

The rules for administering User IDs and passwords are:

- The maximum number of user ID-password combinations is 100.
- The maximum length of the user ID is 16 characters.
- The maximum length of the password is 12 characters; the minimum length is site provisionable using the **chg-secu-dflt** command, and it can be from 1 – 12 characters long.
- User IDs and passwords may contain any printable characters except the characters used as command delimiters: colon (:), comma (,), hyphen (-), or equal sign (=).
- Each user ID must begin with an alpha character.
- A password must contain:
  - At least as many characters as specified on the **minlen** parameter of the **chg-secu-dflt** command
  - At least as many alphabetic characters as specified on the **alpha** parameter of the **chg-secu-dflt** command
  - At least as many numeric characters as specified on the **num** parameter of the **chg-secu-dflt** command
  - At least as many punctuation characters as specified on the **punc** parameter of the **chg-secu-dflt** command
- A password must not contain the associated user ID.

## Command Classes

Each user ID and password combination is assigned to one or more command classes to control the set of commands that a user may enter.

There are 8 unique non-configurable command classes: Basic, Database Administration, Debug, Link Maintenance, Program Update, Security Administration, System Maintenance, and LNP Basic. (The Basic command class is assigned to all users as a default.)

There are 32 available configurable command classes. See the **chg-cmd** command description and the **chg-cmdclass** command description for information about naming and assigning commands to configurable command classes.

See the **chg-user** command description or the **ent-user** command description for more information on configuring user IDs and passwords and assigning command classes.

## Login Security Checks

To aid in system security, the system maintains a record of when a password was last changed and requires a user to change the password when it is older than the site-specified maximum password age. The system also keeps track of the elapsed time between successful logins. If the time between successful logins exceeds the site-specified maximum, a user is not allowed access to the system. The site systems administrator also has the ability to revoke a user ID.

When a user first logs into the system, the default unauthorized user warning is displayed as follows

```
NOTICE: This is a private computer system.
```

```
Unauthorized access or use may lead to prosecution.
```

Additional security is available for the system in that multiple logins using the same user ID are prohibited.

## Intrusion Alert

To alert the system administrator to a possible attempt by an unauthorized person trying to log into the system, the system issues a scroll area message. When 5 or more consecutive attempts to log into the system have failed, the following scroll area message is sent to all terminal ports that can receive unsolicited Security Administration messages:

```
Info: xxxxxxxxxx successive LOGIN failures on port pp
```

Where:

*xxxxxxx* is the number of consecutive login failures on the port (1 – 4,294,967,295)

*pp* is the terminal port (1 – 40) on which the login attempts were made

When the attempt to log into the system is successful after a series of failed consecutive login attempts, or if the active MASP reboots, the count of failed consecutive login attempts for that port is reset to 0.

Attempts to log into the system that are not completed normally, are not considered login attempts and are not included in the count of failed consecutive login attempts. For example, while prompting

for a password you might use the **F9** key to abort the command, or errors might occur when the system is looking up a user ID or password.

## Login Procedure

The commands described in this manual are entered at a terminal connected to the system. Before you can enter most of the commands, you must enter the **login** command to log into the system and open a user session. You must enter the login command with a valid user ID and password combination. When the system accepts your user ID and password as valid, you can enter commands at the terminal in the user session.

The first procedure in this section explains how to log into the system using the **login** command.

The procedures that follow the login procedure explain how to handle common situations that can arise when you log into the system.

- You must change the password the first time that you log in with a new user ID and password.
- The user ID and password that you enter are not accepted as valid.
- Your password has expired and must be changed.
- Someone else has already logged on with your user ID and password; the system does not allow the same ID and password to be used on two terminals at the same time.

**NOTE:** You can enter the **act-user** command instead of the **login** command.

### Procedure - Log into the System for a User Session

---

**1** At the system prompt (>), enter the **login** command with your user ID.

---

**2** Press the **Enter** key.  
The following message appears:

```
Enter Password:
```

---

**3** At the system prompt, type your password.  
For security reasons, the password is not displayed on the terminal screen.

---

**4** Press the **Enter** key.  
Follow the remaining steps to complete this procedure or to go to another procedure, depending on the system response to validation of your user ID and password.

---

**5** If your user ID and password combination are accepted and the following messages appear in the terminal input/command response region, the terminal is available for a user session.

```
Command Accepted-Processing  
Command Executed
```

This procedure is complete.

---

**6** If your user ID and password combination are not accepted and the following message appears, go to ""Procedure - Your User ID and Password were not Accepted" on page 4-18.

---

```
E2757 Cmd Rej: Invalid UserID/Password Combination
```

---

- 7 If you entered a new user ID and password combination for the first time, the following message appears, go to page 4-20 .

```
Enter new password (password must be changed) :
```

---

- 8 If you entered your user ID and password combination and your password has expired, the following message appears, go to page 4-21 .

```
Enter new password (password has expired and must be changed) :
```

---

- 9 If you entered your user ID and password combination and they are already being used at another terminal, the following message appears. Go to page 4-22 .

```
E2750 Cmd Rej: UserID already logged on (or is logging on) another port
```

---

### **Procedure - Your User ID and Password were not Accepted**

---

- 1 This procedure outlines the steps to follow when you attempt to log into the system and your user ID and password combination are not accepted.  
When you entered the **login** command with your user ID and entered your password at the system prompt, the following message appeared:

```
E2757 Cmd Rej: Invalid UserID/Password Combination
```

When this message is displayed, the terminal also presents a message describing the login attempt and the time and date the attempt occurred.

---

- 2 Verify that you have the correct user ID and password.  
Return to the login procedure, and log in again with the correct user ID and password.  
If the problem occurs again, contact your System Administrator.
- 

### **Procedure - You Must Change Your Password**

---

- 1 This situation can occur when you first log in after the system administrator uses the **ent-user** command to enter a new user ID and password combination, or when you first log in after the **chg-user:pid=yes** command has been entered.  
When you entered the **login** command with your user ID and entered your password at the system prompt, the following message appeared:

```
Enter new password (password must be changed) :
```

Type a new password, following your site guidelines.

For security reasons, the password is not displayed on the terminal screen.

---

- 2 Press the **Enter** key.



The system checks the password to ensure that it meets your site's password complexity requirements.

- 
- 3 If your password does not meet your site's password complexity requirements, the system displays a message based on the password violation (see page 4-22 for a list of possible messages).

The login process ends.

Decide on a new password, and start the login procedure again.

- 
- 4 If your password meets the complexity requirements, the following message appears:

Verify Password:

Type the exact password again that you entered in Step 1

For security reasons, the password is not displayed on the terminal screen.

- 
- 5 Press the **Enter** key.

- 
- 6 If the user ID and password combination are accepted and the following messages appear in the terminal input/command response region, the terminal is available for a user session

Command Accepted-Processing  
Command Executed

- 
- 7 Record your new password in a secure location.
- 

### **Procedure - Your Password has Expired**

---

- 1 When you entered the **login** command with your user ID and entered your password at the system prompt, the following message appeared:

Enter new password (password has expired and must be changed) :

Type a new password, following your site guidelines.

For security reasons, the password is not displayed on the terminal screen.

- 
- 2 Press the **Enter** key.  
The system checks the password to ensure that it adheres to your site's password complexity requirements.

- 
- 3 If your password does not meet your site's password complexity requirements, the system displays a message based on the password violation (see page 4-22 for a list of possible messages).

The login process ends.

Decide on a new password, and start the login procedure again.

- 
- 4 If your password meets the complexity requirements, the following message appears:

Verify Password:

Type the exact password again that you entered in Step 1

For security reasons, the password is not displayed on the terminal screen.

---

**5** Press the **Enter** key.

---

**6** If the user ID and password combination are accepted and the following messages appear in the terminal input/command response region, the terminal is available for a user session

```
Command Accepted-Processing
Command Executed
```

---

**7** Record your new password in a secure location.

---

### **Procedure - Your User ID is Already Being Used**

---

**1** When you entered the **login** command with your user ID and entered your password at the system prompt, the following message appeared:

```
E2750 Cmd Rej: UserID already logged on (or is logging on) another port
```

The following information is displayed in the scroll area:

```
Info: UID is currently logged on (or is logging on) to port yy.
```

where yy is in the range of 1 - 40.

---

**2** Find the terminal at port yy, and log off your user ID at that workstation.  
See page 4-23 .

---

**3** Return to your terminal and log into the system again.

---

### **Login Error Messages**

- E2262 Cmd Rej: Password too long, 12 maximum
- E2263 Cmd Rej: Password does not contain enough characters
- E2264 Cmd Rej: Password verification failed
- E2750 Cmd Rej: UserID already logged on (or is logging on) another port
- E2751 Cmd Rej: UserID has been revoked
- E2752 Cmd Rej: UserID has become obsolete and cannot be used
- E2753 Cmd Rej: Password does not contain enough alphabetic characters
- E2754 Cmd Rej: Password does not contain enough numeric characters
- E2755 Cmd Rej: Password does not contain enough punctuation characters
- E2756 Cmd Rej: Failed reading the password table

- E2757 Cmd Rej: Invalid userID/password combination
- E2758 Cmd Rej: ALPHA+NUM+PUNC must not be greater than 12
- E2759 Cmd Rej: Revocation of security admin userID not allowed
- E2760 Cmd Rej: Failed reading the security defaults table
- E2761 Cmd Rej: Password cannot contain userID

See the **chg-secu-dflt** command description for information on different options the system administrator has for configuring the system for password requirements.

The following is an example of the information that might be displayed in the scroll area, depending on your site's configuration:

New password must contain

- from 8 to 12 characters
- at least 1 alphabetic character(s) (a – z)
- at least 1 numeric character(s) (0 – 9)
- at least 1 punctuation character(s) (for example, \$%@#)

## Logout Procedure

When a terminal session is completed, you perform the following logout procedure to log out of the system. The terminal returns to an input idle state.

**NOTE: You can use the `dact-user` command instead of the `logout` command.**

### Procedure - Log Out Of the System

---

- 1 At the system prompt (>), enter the **logout** command.
- 2 Press the **Enter** key.  
The following messages appear on the terminal screen to confirm command completion:

```
Command Accepted-Processing
Command Executed
```

---



# Commands

## Introduction

This chapter contains commands that are not pass-through or debug commands. The commands are listed in alphabetical order starting on page 5-1 .

For each command listed in this chapter, the following information is given:

- A description of the command
- The command syntax
- A list of related commands
- The command class to which the command belongs
- A description of the command parameters
- An example of the command usage
- Rules, dependencies, and notes relevant to the command
- Sample command output

## **act-alm-trns**

### **Activate Alarm Transfer**

Use this command to transfer all alarm indications from the local office to the remote maintenance center.

**Keyword:** `act-alm-trns`

**Related Commands:** `dact-alm-trns`, `rept-stat-clk`, `rept-stat-trbl`, `rtrv-obit`, `rtrv-trbl`

**Command Class:** System Maintenance

### **Parameters**

This command has no parameters.

### **Example**

```
act-alm-trns
```

### **Dependencies**

No other action command can be in progress when this command is entered.

**Notes**

After this command is entered, use the **rept-stat-alm** command to verify the **act-alm-trns** action.

New alarms cause the local maintenance center audible alarms to sound for a short period.

**Output**

```
act-alm-trns
rlghncxa03w 04-01-09:50:17 EST EAGLE 31.3.0
Alarms transferred to Remote Maintenance Center
Command Completed.
;
```

**act-cdl****Activate Command Driven Loopback**

Use this command to initiate a command driven loopback for testing a signaling link.

Command Driven Loopback is the ability to locally drive a signaling link into a manual line loopback. The data received on the signaling link is echoed (transmitted) back. This is effectively the reverse of the **tst-slk:loopback=lxvr**, which loops the transmitted data back to the receiver.

**Keyword:** act-cdl

**Related Commands:** act-lbp, dact-cdl, dact-lbp, rept-stat-cdl, tst-slk

**Command Class:** Link Maintenance

**Parameters**

**:link=** (mandatory)

SS7 signaling links. The SS7 signaling link to be tested.

**Synonym:** port

**Range:** a, b, a1-a31, b1-b31

Not all card types support all **link** parameter values.

See Table A-1 for valid link parameter range values for each type of card that can have assigned signaling links.

**:loc=** (mandatory)

The card location as stenciled on the shelf of the system.

**Range:** 1101-1108, 1111-1112, 1201-1208, 1211-1218, 1301-1308, 1311-1318, 2101-2108, 2111-2118, 2201-2208, 2211-2218, 2301-2308, 2311-2318, 3101-3108, 3111-3118, 3201-3208, 3211-3218, 3301-3308, 3311-3318, 4101-4108, 4111-4118, 4201-4208, 4211-4218, 4301-4308, 4311-4318, 5101-5108, 5111-5118, 5201-5208, 5211-5218, 5301-5308, 5311-5318, 6101-6108, 6111-6118

**:loopback=** (optional)

Loopback test type.

**Range:** line, payload

The **payload** value is valid only on LIM-ATM and E1-ATM cards.

**Default:** line

**Example**

```
act-cdl:loc=1205:link=b
```

**Dependencies**

The card location specified in the **loc** parameter must be equipped.

The signaling link specified in the **link** parameter must be equipped.

LFS must not be running on the specified signaling link when this command is entered. The LFS processing must be stopped or must be allowed to complete before this command can be entered.

The **loopback=payload** parameter is valid only for LIM-ATM and E1-ATM cards.

Command Driven Loopback testing is not available during upgrade.

A Command Driven Loopback test cannot be in progress on the specified link when this command is entered.

A **tst-slk** command cannot be in progress on the specified link when this command is entered. The **tst-slk** processing must be stopped or must be allowed to complete before this command can be entered.

The card location specified in the **loc** parameter must be in the In-Service-Normal (IS-NR) state.

The card location specified in the **loc** parameter must support Command Driven Loopback testing.

The signaling link specified in the **link** parameter must not be active.

The card location specified in the **loc** parameter cannot be reserved by the system.

## Notes

None

## Output

```
act-cdl:loc=1205:link=b
tekelecstp 05-01-21 17:00:36 EST EAGLE5 33.0.0
Command Accepted: Command Driven Loopback message is sent.
;

tekelecstp 05-01-21 17:00:36 EST EAGLE5 33.0.0
Command Completed.
;
```

## act-dlk

### Activate Data Link

Use this command to activate a TCP/IP data link and put that data link into service. The state of the TCP/IP data link is changed from out of service maintenance disabled (OOS-MT-DSBLD) to in service normal (IS-NR).

**Keyword:** act-dlk

**Related Commands:** canc-dlk, dlt-dlk, ent-dlk, rept-stat-dlk, rtrv-dlk, tst-dlk

**Command Class:** Link Maintenance

## Parameters

**:loc=** (mandatory)

The card location as stenciled on the shelf of the system.

**Range:** 1101-1108, 1111-1112, 1201-1208, 1211-1218, 1301-1308, 1311-1318, 2101-2108, 2111-2118, 2201-2208, 2211-2218, 2301-2308, 2311-2318, 3101-3108, 3111-3118, 3201-3208, 3211-3218, 3301-3308, 3311-3318, 4101-4108, 4111-4118, 4201-4208, 4211-4218, 4301-4308, 4311-4318, 5101-5108, 5111-5118, 5201-5208, 5211-5218, 5301-5308, 5311-5318, 6101-6108, 6111-6118

## Example

```
act-dlk:loc=1308
```

## Dependencies

No other action command can be in progress when this command is entered.

The shelf and card must be equipped.

The card location must contain a card that is running the **stplan** application.  
 The card location, frame, shelf, or slot must be within the allowed range.  
 The signaling link must be equipped in the database.  
 A card location that is valid and defined in the database must be specified.  
 The card in the specified card location (**loc** parameter) must be in service.  
 The **ipaddr** parameter must specify a valid IP address.

### Notes

None

### Output

```
act-dlk:loc=1308
  rlgncxa03w 04-01-17:00:36 EST EAGLE 31.3.0
  Activate Link message sent to card.
  Command Completed.
;
```

## act-echo

## Activate Echo

Use this command to force responses from the scroll area of a terminal to be printed to a specified terminal or printer. The command supports one terminal echoing to many terminals or many terminals echoing to one terminal.



CAUTION

**CAUTION: Exercise restraint in using this command, because excessive echoing can cause a loss of output at the receiving terminal.**

**Keyword:** act-echo

**Related Commands:** chg-trm, dact-echo, rept-stat-trm, rmv-trm, rst-trm, rtrv-trm

**Command Class:** Basic

### Parameters

**:trm=** (mandatory)  
 Serial port number.  
**Range:** 1-16

### Example

```
act-echo:trm=3
```

### Dependencies

If a terminal is already echoing to a specified terminal, the **act-echo** command cannot be entered to echo the terminal's output to that same terminal.

Echo is not allowed to the terminal from which the command is issued.

Echo is not allowed to or from IP User Interface telnet ports (terminals 17-40).

Echo is not allowed to an OAP port.

Terminal output cannot be echoed to a terminal that is inhibited.

Terminal parameter must be specified.



**Notes**

This command can be used to echo only command output responses to a terminal. For alarm and network messages to be sent to a terminal, the **chg-trm** command must be used.

To echo output to a destination port, a user must be logged in at the destination port. The following warning message appears in the scroll area of the issuing terminal if echo is attempted to a terminal that has no user logged in:

No user logged in at Terminal X. No echo will occur until a user logs in.  
where X is the **trm** parameter value specified in the **act-echo** command.

**Output****act-echo:trm=2**

```
rlghncxa03w 04-01-07 11:11:28 EST EAGLE 31.3.0
act-echo:trm=2
Command entered at terminal #1.
```

```
rlghncxa03w 04-01-07 11:11:28 EST EAGLE 31.3.0
Scroll Area Output is echoed to terminal 2.
```

Caution: Loss of output may occur if too many terminals are echoed.

;

**act-echo:trm=3**

```
rlghncxa03w 04-01-07 11:11:28 EST EAGLE 31.3.0
act-echo:trm=3
Command entered at terminal #1.
```

```
rlghncxa03w 04-01-07 11:11:28 EST EAGLE 31.3.0
Scroll Area Output is echoed to terminal 2.
Scroll Area Output is echoed to terminal 3.
```

Caution: Loss of output may occur if too many terminals are echoed.

;

**act-file-trns****Activate File Transfer**

This command starts a file transfer between the system and a remote computer.

**Keyword:** act-file-trns

**Related Commands:** copy-fts, disp-fts-dir, dlt-fts

**Command Class:** System Maintenance

**Parameters**

**:loc=** (optional)

The location of the fixed disk to or from which the file is to be uploaded or downloaded.

**Range:** 1114, 1116

Active and standby TDM locations

**Default:** The active TDM location

**:retries=** (optional)

The number of times the system retries a packet before giving up.

**Range:** 1-20

**Default:** 10

**:timeout=** (optional)

The number of seconds the system waits for a packet before sending a negative acknowledgment or retransmitting the previous packet. This parameter also specifies the number of seconds to wait for a transfer initiation message from the remote computer.

**Range:** 1-120

**Default:** 30

### Example

```
act-file-trns:loc=1113
```

### Dependencies

The **loc** parameter must specify a TDM card.

Only one file transfer can be active at a time.

This command cannot be entered on a telnet terminal (IDs 17-40).

### Notes

Output messages indicating transfer initiated and transfer terminated (whether successful or not) are sent to the output devices in the Security Administration output group.

#### LNP Measurements

When used to output LNP measurements, the **rept-meas** command sends data to the FTA. Extracting LNP measurements from the FTA requires:

- A computer with a VT320 or KSR connection to the system
- A communication program that both emulates VT terminals and supports Kermit file transfer
- A spreadsheet program that can import Comma Separated Value (CSV) text files

A PC running ProComm© for Windows and Microsoft Excel© can be used.

Use the following procedure to collect LNP measurements.

### Procedure - Extracting LNP Measurements from the FTA

- 1 Enter the following command to display the contents of the FTA:

```
disp-fta-dir:loc=xxxx
```

Where **xxxx** = the active TDM (**1114** or **1116**)

- 2 Enter the following command to delete any existing files from the FTA:

```
dlt-fta:loc=xxxx:all=yes
```

Where **xxxx** = the active TDM (**1114** or **1116**)

- 3 Enter the command to send LNP daily measurements to the FTA. For example:

```
rept-meas:enttype=lnp:type=mtcd
```

- 4 Enter the following command to activate the file transfer:

```
act-file-trns:loc=xxxx
```

Where **xxxx** = the active TDM (**1114** or **1116**)

- 5 Enter the following command to display a list of the files transferred to the FTA in step 4:

**disp-fta-dir:loc=xxxx**

Where **xxxx** = the active TDM (**1114** or **1116**)

---

- 6 Use the **get** command from within the communications program configured to run Kermit in ASCII mode to transfer the desired files (with the .csv suffixes) to the PC. For example:

> **get mday\_lnp.csv**

> **get mday\_ssp.csv**

> **get mday\_lrn.csv**

> **get mday\_npa.csv**

> **finish**

---

- 7 Run a spreadsheet program and open each of the collected files to view the LNP measurement data.
- 

- 8 After all files are successfully transferred and confirmed, enter the following command to remove the files from the FTA:

**dlt-fta:loc=xxxx:all=yes**

Where **xxxx** = the active TDM (**1114** or **1116**)

---

**Output**

Normal session output to non-Security Administration user's terminal.

```
act-file-trns:loc=1114:timeout=20:retries=2
rlghncxa03w 04-01-05 14:37:05 EST EAGLE 31.3.0
act-file-trns:loc=1114:timeout=20:retries=2
Command entered at terminal #1.
;
rlghncxa03w 04-01-05 14:37:05 EST EAGLE 31.3.0
Awaiting File Transfer with remote.
Please initiate binary Kermit session on local computer
;
rlghncxa03w 04-01-05 14:38:33 EST EAGLE 31.3.0
File Transfer : 0 file(s) DOWNLOADED from location 1114 successfully
File Transfer : 1 file(s) UPLOADED to location 1114 successfully
File Transfer : Kermit Session terminated NORMALLY
```

Normal session output to Security Administration group terminals.

```
act-file-trns:loc=1114:timeout=20:retries=2
rlghncxa03w 04-01-05 14:40:42 EST EAGLE 31.3.0
File Transfer : INITIATED on terminal #1
;
rlghncxa03w 04-01-05 14:41:07 EST EAGLE 31.3.0
File Transfer: 511_byte.bin UPLOADED to location 1114 successfully.
;
rlghncxa03w 04-01-05 14:41:44 EST EAGLE 31.3.0
File Transfer : terminated NORMALLY on terminal #1
```

Normal session output to Security Administration user's terminal.

```
act-file-trns:loc=1114:timeout=20:retries=2
rlghncxa03w 04-01-05 14:42:51 EST EAGLE 31.3.0
act-file-trns:loc=1114:timeout=20:retries=2
Command entered at terminal #1.
;
rlghncxa03w 04-01-05 14:43:29 EST EAGLE 31.3.0
File Transfer : INITIATED on terminal #1
;
rlghncxa03w 04-01-05 14:43:53 EST EAGLE 31.3.0
Awaiting File Transfer with remote.
Please initiate binary Kermit session on local computer

rlghncxa03w 04-01-05 14:44:19 EST EAGLE 31.3.0
File Transfer: 511_byte.bin UPLOADED to location 1114 successfully.
;
rlghncxa03w 04-01-05 14:44:52 EST EAGLE 31.3.0
File Transfer : 0 file(s) DOWNLOADED from location 1114 successfully
File Transfer : 1 file(s) UPLOADED to location 1114 successfully
File Transfer : Kermit Session terminated NORMALLY
;
rlghncxa03w 04-01-05 14:45:31 EST EAGLE 31.3.0
File Transfer : terminated NORMALLY on terminal #1
;
```

**act-flash****Activate Flash**

Use this command to activate the trial FLASH GPL that is currently running on one target card or on a range of cards.

**Keyword:** act-flash

**Related Commands:** clr-imt-stats, flash-card, init-flash, init-imt-gpl, rept-imt-info, rept-imt-lvl1, rept-imt-lvl2, tst-imt

**Command Class:** System Maintenance

## Parameters

**:eloc=** (optional)

End location. This parameter specifies the location of the last card of a range of cards to be activated.

**Range:** 1101-1113, 1115, 1201-1218, 1301-1318, 2101-2118, 2201-2218, 2301-2318, 3101-3118, 3201-3218, 3301-3318, 4101-4118, 4201-4218, 4301-4318, 5101-5118, 5201-5218, 5301-5318, 6101-6118

**:gpl=** (optional)

Generic program load. This parameter specifies the flash GPL type that is running on the cards in the specified range of cards.

This parameter must be specified for cards that have more than one flash image (GPL).

**Range:** ayyyyyy

1 alphabetic character followed by up to 6 alphanumeric characters.

Valid GPLs are: **blbios**, **blbepm**, **blbsmg**, **blcpld**, **bldiag6**, **blmcap**, **blrom1**, **blvxw6**, **bpdcn**, **bpdcn2**, **bphcap**, **bphcapt**, **bphmux**, **bpmpl**, **bpmp1t**, **hipr**, **hipr2**, **imtpci**, and **p1dpmc1**.

**:loc=** (optional)

Location. This parameter specifies the location of a single target card.

**Range:** 1101-1113, 1115, 1201-1218, 1301-1318, 2101-2118, 2201-2218, 2301-2318, 3101-3118, 3201-3218, 3301-3318, 4101-4118, 4201-4218, 4301-4318, 5101-5118, 5201-5218, 5301-5318, 6101-6118

**:sloc=** (optional)

Start location. This parameter specifies the location of the first card of a range of cards to be activated.

**Range:** 1101-1113, 1115, 1201-1218, 1301-1318, 2101-2118, 2201-2218, 2301-2318, 3101-3118, 3201-3218, 3301-3318, 4101-4118, 4201-4218, 4301-4318, 5101-5118, 5201-5218, 5301-5318, 6101-6118

## Example

```
act-flash:loc=1105
```

```
act-flash:sloc=1101:eloc=1112:gpl=bpmp1
```

## Dependencies

The card, or cards, in the specified location or range of locations for this command must be actively running a flash GPL in *trial* mode.

The allowed cards are HCAP, HCAP-T, DCM, E1/T1 MIM, E5-ENET, HC-MIM, E5-E1T1, E5-TSM, E5-IPSM, E5-MCAP, GPSM-II, MPL, or Service Module. Card locations *xy09* and *xy10* (*x* is the frame, *y* is the shelf) can be specified only for HMUX, HIPR, or HIPR2 cards.

Each specified card does not have to be defined in the database, but it does have to be aligned on the IMT bus.

If the target card is an HMUX, HIPR, or HIPR2 card, then both card locations specified in the **sloc** and **eloc** parameters must contain HMUX, HIPR, or HIPR2 cards on the same IMT bus. For these cards, the bus is implicit based on the specified location. Location *xy09* specifies an HMUX, HIPR, or HIPR2 A Bus, and location *xy10* specifies an HMUX, HIPR, or HIPR2 B Bus (*x* is the frame and *y* is the shelf). For example, **sloc=1109:eloc=6109** specifies all HMUX, HIPR, or HIPR2 cards on the A Bus only; **sloc=1110:eloc=6110** specifies all HMUX, HIPR, or HIPR2 cards on the B Bus only. HMUX, HIPR, or HIPR2 cards from both the A bus and B bus cannot be flash downloaded simultaneously.

The card must be running an inactive flash GPL when this command is executed.

The provisioning subsystem mode (simple, duplex) must be established prior to executing the command.

The **loc** parameter cannot be specified with the **eloc** and **sloc** parameters.

Either the **loc** parameter or the **eloc** and **sloc** parameters must be specified.

The **eloc** and **sloc** parameters must be specified together in the command; one parameter cannot be specified without the other parameter.

The **sloc** parameter value cannot be greater than the **eloc** parameter value.

The cards in the specified **sloc** and **eloc** card locations must be present and able to communicate over the IMT. The cards do not have to be provisioned in the database.

The **gpl** parameter must be specified if the **eloc** and **sloc** parameters are specified.

The **gpl** parameter must be specified for cards that have more than one flash image (GPL).

The cards in the locations specified in the **sloc** and **eloc** parameters must be running the specified general program load (**gpl**). Other cards in the range of card locations can be running other GPLs, but will not be activated. Only the cards within the range that are running the specified GPL will be activated.

A card that is the active MASP cannot be specified for the **loc**, **sloc**, or **eloc** parameter.

No other action command can be in progress when this command is entered.

A card location that is valid and defined in the database must be specified.

The cards specified in the **sloc** and **eloc** location parameters must be running the specified general program load (gpl).

## Notes

None

## Output

### **act-flash:loc=1105**

```
rlghncxa03w 04-01-04 13:05:05 EST EAGLE 31.3.0
FLASH Memory Activation for card 1105 Started.
```

;

```
rlghncxa03w 04-01-04 13:05:05 EST EAGLE 31.3.0
FLASH Memory Activation for card 1105 Completed.
```

;

```
rlghncxa03w 04-01-04 13:05:05 EST EAGLE 31.3.0
Command Completed.
```

;

### **act-flash:sloc=1101:eloc=1112:gpl=bpmp1**

```
rlghncxa03w 05-01-04 13:05:05 EST EAGLE 33.0.0
FLASH Memory Activation for cards 1101 - 1112 Started.
```

;

```
rlghncxa03w 05-01-04 13:05:05 EST EAGLE 33.0.0
FLASH Activation for cards 1101 - 1112 Completed.
```

```
LOC 1101 : PASSED
```

```
LOC 1102 : PASSED
```

```
LOC 1112 : PASSED
```

```
ALL CARD RESULTS PASSED
```

;

```
rlghncxa03w 05-01-04 13:05:05 EST EAGLE 33.0.0
Command Completed.
```

;

**act-ftp-trns****Activate FTP Transfer**

Use this command to activate an FTP transfer to send database tables from the system to the customer's FTP server.

**NOTE: This command is not for customer use. It is for Tekelec use only.**

**Keyword:** act-ftp-trns

**Related Commands:**

**Command Class:** Database Administration

**Parameters**

**:action=** (mandatory)

This parameter specifies the operation that the command is to perform.

**Range:** put

**:filetype=** (mandatory)

This parameter specifies the EAGLE 5 ISS table type to be transferred.

**Range:** mtp, gtt, gws, vflex, ip, all

**mtp**—Transfer all Message Transfer Part tables

**gtt**—Transfer all Global Title Translation tables

**gws**—Transfer all Gateway Screening tables

**vflex**—Transfer all V-Flex tables

**ip**—Transfer all IP tables

**all**—Transfer all of the types of tables

**Example**

```
act-ftp-trns:action=put:filetype=gtt
```

```
act-ftp-trns:action=put:filetype=ip
```

**Dependencies**

An **act-ftp-trns** command cannot be entered if another file transfer is already in progress.

Both the **action** and **filetype** parameters must be specified in the command.

The FTP Server table must be accessible.

The FTP Server table must contain at least one FTP server entry that specifies the **user** application

An IPSM card must be in service before this command can be entered.

**Notes**

This command communicates with the **user** application, defined in the FTP Server table. The IP address and server details necessary for an FTP transfer are also stored in the FTP Server table. One such **user** application is the FTP-based Table Retrieve Application (FTRA). Refer to the *FTP-Based Table Retrieve Application (FTRA) User Guide* for the **user** application to configure an FTP Server table entry.

**Output**

```

act-ftp-trns:action=put:filetype=ip
tekelecstp 09-05-06 06:41:17 EST  EAGLE 41.0.0
FTP command sent to IPSM card - Processing
;

tekelecstp 09-05-06 06:41:17 EST  EAGLE 41.0.0
Copy-table started - tablexxx.tbl
Copy-table COMPLETE.
;

tekelecstp 09-05-06 06:41:17 EST  EAGLE 41.0.0
FTP file transfer started - tablexxx.tbl
FTP file transfer SUCCESSFUL.
;

tekelecstp 09-05-06 06:41:17 EST  EAGLE 41.0.0
FTP transfer COMPLETE.
;

```

**act-gpl****Activate Generic Program Load**

Use this command to change the status of the trial GPL from “trial” to “approved.” The status of the previously approved GPL is changed to “trial.”

**Keyword:** act-gpl

**Related Commands:** chg-gpl, copy-gpl, rept-stat-gpl, rtrv-gpl

**Command Class:** Program Update

**Parameters**

**:gpl=** (mandatory)

Generic program load. This parameter specifies the name of the GPL identifier to be moved from "trial" to "approved" status on the disk.

**Range:** xxxxxxxx

1 alphabetic character followed by up to 7 alphanumeric characters. Valid GPLs are:

**atmansi**—Used by the LIM cards to support the high-speed ATM signaling link feature

**atmhc**—Supports functionality for the E5-ATM card. The E5-ATM card runs either the ATMANSI or ATMITU application. The GPL allows the card to support up to 2 signaling links.

**atmitu**—Used by E1 ATM cards to support the high-speed E1 ATM signaling link feature

**blbepm**—Flash GPL containing the BIOS ROM image on E5-E1T1 and E5-ENET cards

**blbios**—Flash GPL containing the BIOS ROM image on HC-MIM cards that are used for E1 or T1 signaling links

**blbsmg**—Flash GPL containing the BIOS ROM image on E5-SM4G cards

**blepld**—Flash GPL containing the bit files for the CPLD on HC-MIM, E5-E1T1, and E5-ENET cards that are used for E1 or T1 signaling links.

**bldiag6**—Flash GPL containing the diagnostic code on E5-E1T1 cards, HC-MIM cards, and E5-ENET cards

**blmcap**—Flash GPL containing a tar image with all code required on E5-MCAP cards

**blvxw6**—Flash GPL containing the VxWorks operating system on E5-E1T1 cards, HC-MIM cards, and E5-ENET cards



**blrom1**—Flash GPL containing the bootloader code for VxWorks operating system on HC-MIM cards

**bpdcn**—Used to support the flash memory Board PROM for DCM, DSM, and GPSM boards, original design

**bpdcn2**—Used to support the flash memory Board PROM for DCM and GPSM boards, revised design

**bphcap**—Used to support Board PROM for HCAP flash memory

**bphcapt**—Supports Board PROM for HCAP-T flash memory

**bphmux**—Supports Board PROM for HMUX flash memory

**bpmpl**—Supports Board PROM for MPL flash memory

**bpmp1t**—Supports Board PROM for E1/T1 flash memory

**cd**—Used in the card manufacturing process.

**eoam**—Used by the GPSM-II card for enhanced OAM functions

**eroute**—Used by the STC card for EAGLE 5 Integrated Monitoring Support functions

**erthc**—Used by the E5-ENET card when the card acts as an STC card (E5-STC card) for EAGLE 5 Integrated Monitoring Support functions

**gls**—Used by TSM cards to download gateway screening to LIM cards

**glshe**—Used by E5-TSM cards to download gateway screening to LIM and SCCP cards

**hipr**—Communication software used on the High Speed IMT Packet Router (HIPR) card

**hipr2**—Communication software used on the High Speed IMT Packet Router (HIPR2) card

**imt**—Communication processor on the logical processing element (LPE)

**imtpci**—Communication software that operates the IMT bus on HC-MIM, E5-E1T1, and E5-ENET cards

**ipghc**—Used by E5-ENET cards to support TCP/IP point-to-multipoint connectivity for both ANSI and ITU point codes

**ipgwi**—Used by SSEDCCM cards for TCP/IP point-to-point connectivity for ITU point codes

**iplhc**—Used by E5-ENET cards for TCP/IP point-to-point connectivity for both ANSI and ITU point codes

**iplim**—Used by SSEDCCM cards for TCP/IP point-to-point connectivity for ANSI point codes

**iplimi**—Used by SSEDCCM cards for TCP/IP point-to-point connectivity for ITU point codes

**ips**—Used by IPSM cards for the IP User Interface feature

**ipsg**—Used by E5-ENET cards to support the combined functionality of IPLIMx M2PA and IPGWx M3UA

**ipshe**—Used by E5-IPSM cards to support the IPS application

**mcp**—Used by MCPM cards for the Measurements Platform feature

**oamhc**—Used by E5-MCAP cards for enhanced OAM functions

**pldpme1**—Flash GPL used on HC-MIM and E5-E1T1 cards for E1 and T1 signaling links

**sccphe**—Used by E5-SM4G cards to support the EPAP-based features and the LNP ELAP Configuration feature. If no EPAP-based or LNP ELAP Configuration feature

is turned on, and if an E5-SM4G card when the card acts as an STC card (E5-STC card) for EAGLE 5 Integrated Monitoring Support functions.

**ss7hc**—Supports the functionality for HC-MIM or E5-E1T1 cards. The HC-MIM and E5-E1T1 cards run the SS7ANSI or CCS7ITU application; the GPL allows the card to support up to 64 signaling links for E1 and T1 functions.

**ss7ipgw**—Used by SSEDCCM cards to support TCP/IP point-to-multipoint connectivity

**ss7ml**—Support functionality for MPL and the E1/T1 MIM cards. MPL cards run the SS7ANSI application on a LIMDS0 card (as in the command **ent-card:type=limds0:appl=ss7ansi**); the GPL allows the card to support 8 signaling links rather than the usual 2 links for LIM cards. MPL cards support only the DS0 interface. E1/T1 MIM card runs either the SS7ANSI or CCS7ITU application; the GPL allows the card to support 8 signaling links for E1 and T1 functions.

**utility**—Used by the factory for testing, and when directed by the Customer Care Center

**vcd**—Used in the card manufacturing process

**vsccp**—Used by Service Module cards to support the EPAP-based and the LNP ELAP Configuration features. If no EPAP-based or LNP ELAP Configuration feature is turned on, and if a Service Module card is present, then the GPL processes normal GTT traffic.

**vxwslan**—Used by SSEDCCM cards to support the STP LAN application

**:ver=** (mandatory)

Version. This parameter specifies the version number of the GPL to be activated, with subfields the format of *major-minor-fix* separated by dashes.

**Range:** *major-minor-fix*

Specify a value in the range **0–255** for each subfield of the GPL version number (*major-minor-fix*).

### Example

```
act-gpl:gpl=ss7hc:ver=125-1-0
act-gpl:gpl=slanhc:ver=128-2-0
act-gpl:gpl=erthc:ver=128-2-0
act-gpl:gpl=ipshc:ver=128-1-0
act-gpl:gpl=sccphc:ver=128-1-0
act-gpl:gpl=hipr2:ver=128-23-1
act-gpl:gpl=ipsg:ver=129-1-0
act-gpl:gpl=atmhc:ver=125-1-0
```

### Dependencies

No other activate, change, copy, or retrieve GPL commands, nor a GPL audit, can be in progress when this command is entered.

The value specified for the **gpl** parameter must be supported. See the **gpl** definition for a list of supported GPLs.

### Notes

Test the trial GPL by loading to a card before activating the GPL. Activating the GPL changes it from *trial* to *approved*.

The generic program load is committed on the active system and on the standby system.

Trial GPLs are downloaded to cards manually. Only approved GPLs can be downloaded to cards by the system.

Use the **rtrv-gpl** command to determine the version of the GPL.

## Output

The output indicates that the specified GPL is activated on each TDM card.

### **act-gpl:gpl=ss7hc:ver=125-1-0**

```
tekelecstp 05-01-03 16:53:23 EST EAGLE5 33.0.0
SS7HC activate to 1114 completed
SS7HC activate to 1116 completed
```

;

The number of "cards of x complete" represents the total number of cards that can communicate on the IMT at the instant that this information is displayed.

### **act-gpl:appl=imt:ver=21-2-0**

```
tekelecstp 05-04-24 06:54:39 EST EAGLE 34.0.0
IMT activate on 1114 completed
IMT activate on 1116 completed
```

;

```
tekelecstp 05-04-24 06:54:41 EST EAGLE 34.0.0
5402. 1105 SYSTEM INFO REPT-EVT:IMT GPL reloading.
1 card(s) of 25 complete.
Report Date: 05-04-24 Time: 06:54:41
```

;

```
tekelecstp 05-04-24 06:55:11 EST EAGLE 34.0.0
5403. 1106 SYSTEM INFO REPT-COND:IMT GPL reloading.
11 card(s) of 25 complete.
Report Date: 05-04-24 Time: 06:55:11
```

;

## act-lbp

### Activate Loopback Point Test

Use this command to activate one or more loopback point tests for testing data signaling link elements in an SS7 transmission path. Use this command to:

- Activate a test for a specified loopback point that is defined in the LFS database table
- Activate a test for one loopback point that is not defined in the LFS database table
- Activate tests for all loopback points that have been defined in the LFS database table. See "Summary of Loopback Testing Commands and Functions" for information about loopback testing commands and functions.

The **ent-lbp** command can be used to define a maximum of 32 loopback points in the LFS database table.

**Keyword:** act-lbp

**Related Commands:** chg-lbp, dact-lbp, dlt-lbp, rept-stat-lfs, rtrv-lbp

**Command Class:** Database Administration

## Parameters

To activate a test for a single loopback point that is defined in the LFS database table, specify the loopback point number in the **lbp** parameter and do not specify any of the **lfst**, **rle**, **rep**, and **cli**

parameters in the command. Information from the LFS database is used to activate the test for the specified loopback point.

To activate a test for a single loopback point that is not defined in the LFS database table, specify one or more of the **lfst**, **rle**, **rep**, and **cli** parameters in the command. (If the **cli** parameter is not specified, the **cli** value is blank, a null string. If the **rep** parameter is not specified, the default value is 0.)

To activate tests for all loopback points that are defined in the LFS database, do not specify any of the **lbp**, **lfst**, **rle**, **rep**, and **cli** parameters in the command. Information from the LFS database table is used to activate tests for all defined loopback points.

**:link=** (mandatory)

SS7 signaling link. This parameter specifies the SS7 signaling link to be tested.

**Synonym:** port

**Range:** a, b, a1-a31, b1-b31

Not all card types support all **link** parameter values.

See Table A-1 for valid **link** parameter range values for each type of card that can have assigned signaling link ports.

**:loc=** (mandatory)

Location. This parameter specifies the unique identifier of the card containing the signaling link to use for loopback point testing.

**Range:** 1101-1108, 1111-1112, 1201-1208, 1211-1218, 1301-1308, 1311-1318, 2101-2108, 2111-2118, 2201-2208, 2211-2218, 2301-2308, 2311-2318, 3101-3108, 3111-3118, 3201-3208, 3211-3218, 3301-3308, 3311-3318, 4101-4108, 4111-4118, 4201-4208, 4211-4218, 4301-4308, 4311-4318, 5101-5108, 5111-5118, 5201-5208, 5211-5218, 5301-5308, 5311-5318, 6101-6108, 6111-6118

**:cli=** (optional)

Common language location identifier. This parameter specifies the CILLI code or other mnemonic identifier, used to refer to the given loopback point.

**Range:** ayyyyyyyyyy

1 alphabetic character followed by up to 10 alphanumeric characters

**Default:** If the **rle**, **lfst**, or **rep** parameter is specified—null string (blank)

If the **rle**, **lfst**, or **rep** parameter is not specified—the value in the LFS database

**:data=** (optional)

This parameter specifies the data used with the *octet* or *alternate* patterns.

**Range:** 1-255

**Default:** 255

**:force=** (optional)

The **force=yes** parameter must be specified to start a test when there are 256 or more tests already running.

**Range:** yes, no

**Default:** no

**:lbp=** (optional)

Loopback point ID. This parameter specifies a far-end loopback point that lies along an SS7 signaling link path between the STP and the target device (up to *and including* the target device).

**Range:** 1-32

**Default:** If the **rle**, **cli**, **rep**, or **lfst** parameter is specified, the default is 1.

If the **rle**, **cli**, **rep**, and **lfst** parameters are not specified, the default is all loopback points found in the LFS database (up to 32 loopback points), as shown in the **rtrv-lbp** command output.

**:lfst=** (optional)

Link fault sectionalization test. This parameter specifies the type of link fault sectionalization loopback test to be performed.

This parameter is mandatory if the **rle**, **cli**, or **rep** parameter is specified.

**Range:** **LLT, MLT, NLT**

**LLT**— latching loopback test; a software latch is set at the test point to reverse everything that is received and return it to the sender until the test is complete

**MLT**— manual latch loopback test; an external hardware latch has been set to reverse everything that is received and return it to the sender until the test is complete (for equipment that cannot set a software latch for the test)

**NLT**— nonlatching loopback test; no permanent latch is set. Loopback codes are alternated with test data until the test is complete.

**Default:** The value in the LFS database, as shown in the **rtrv-lbp** command output

**:maxerr=** (optional)

The bit error threshold. This parameter specifies the actual number of errors allowed for a specific time period during which loopback testing is being performed. If this threshold is exceeded, the *TEST STATUS* field in the output report indicates an error.

**Range:** **0-4838400**

**Default:** **56**

**:pattern=** (optional)

This parameter specifies the type of test pattern used to perform the LFS test.

**Range:** **b2047, b511, octet, alternate**

**b2047**— 047-bit Bert pattern sent until it is stopped by software

**b511**— 511-bit Bert pattern sent until it is stopped by software

**octet**— Data (from the **data** parameter) sent continuously until it is stopped by software

**alternate**— Alternately, a count of 100 octets of the specified data (from the **data** parameter) followed by 100 octets of **0**, sent until it is stopped by the software

The **octet** and **alternate** values are valid only when **lfst=llt** is specified.

**Default:** **b2047**

**:rep=** (optional)

Repetition count. This parameter specifies the number of link elements of the same type (not including the target device) that lie between the STP and the link element to be tested.

**Range:** **0-31**

**Default:** If the **rle**, **cli**, **rep**, or **lfst** parameter is specified, the default is **0**.

If the **rle**, **cli**, **rep**, or **lfst** parameter is not specified, the default is the value in the LFS database, as shown in the **rtrv-lbp** command output.

**:rle=** (optional)

Remote link element. This parameter specifies the link element to be looped back for testing.

This parameter is mandatory if the **lfst**, **cli**, or **rep** parameter is specified.

**Range:** **ds0, ocu, csu, dsu, nei**

**Default:** The value from the LFS database, as shown in the **rtrv-lbp** command output

**:time=** (optional)

This parameter specifies the length of time the test must be run in order to determine success or failure. If the number of errors that actually occur during this time exceeds the threshold set by the **maxerr** parameter, the loopback test is identified as a failure.

**Range:** **1-240000**

*hhmmss*—*hh*=hours (**00-24**), *mm*=minutes (**00-59**), *ss*=seconds (**00-59**)

For example, **time=1** or **time=000001** is one second; **time=240000** is 24 hours;

**time=200** or **time=000200** is 2 minutes

**Default:** **1** second

### Example

Activate tests for all loopback points that are defined in the LFS database table:

```
act-lbp:loc=1205:link=b:pattern=alternate:maxerr=10:time=000200
```

Activate a test for a single loopback point that is not defined in the LFS database table:

```
act-lbp:loc=1205:link=b:lbp=1:rle=ds0:lfst=llt:clli=rlghncxa05w
```

```
act-
```

```
lbp:loc=1205:link=b:lbp=1:rle=ds0:lfst=llt:clli=rlghncxa05w:patte  
rn=octet:data=h'ff
```

```
act-
```

```
lbp:loc=1205:link=b:lbp=1:rle=ds0:lfst=llt:clli=rlghncxa05w:maxerr  
r=40:time=12000
```

Activate a test for a single loopback point that is defined in the LFS database table:

```
act-
```

```
lbp:loc=1205:link=b:lbp=3:pattern=alternate:maxerr=10:time=000200
```

### Dependencies

The Link Fault Sectionalization (LFS) feature must be on before this command can be entered.

If the **rle=nei** parameter is specified, the **rep=0** parameter must be specified.

The **rep** parameter can be specified only if the **lfst=llt** parameter is specified.

The **rle=ds0** or the **rle=nei** parameter cannot be specified if the **lfst=nl** parameter is specified. The DS0 and Network Element Interface (NEI) link elements do not support non-latching loopbacks.

If one or more of the **rle**, **rep**, **lfst**, or **clli** parameters are specified, the database is not used to look up their values; therefore, the **lfst** and **rle** parameters must be specified when the **rep** or **clli** parameter is specified.

The **data** parameter can be specified only if the **pattern=octet** parameter or **pattern=alternate** parameter is specified.

The **pattern=octet** and **pattern=alternate** parameters cannot be specified for non-latching tests (**rle=nl**).

The card location (**loc** parameter) must contain a provisioned and equipped **limds0**, **limt1**, or **limch** (associated with a **limt1**) card configured with either an **ss7ansi** or **ccs7itu** application.

The card in the **loc** parameter location must be in the In-Service-Normal state.

The signaling link that is used for LFS testing must be equipped, and must be deactivated before this command is entered.

The loopback points (LBPs) must have been previously defined in the database.

Only one LFS test can be active on a signaling link at a time.

This command cannot be entered for a signaling link LFS test when the maximum number of LFS tests are active for the card. At least one LFS test must complete before this command can be entered again.

On LIM-AINF, LIM-ILA, LIM-EILA, and MPL cards (type LIMDS0 cards), only one LFS test can be active on a card at a time.

On the following cards, up to 8 LFS tests can be active on a card at a time:

- E1/T1 MIM cards or HC-MIM cards used as T1 cards
- E1/T1 MIM cards used as LIMCH cards associated with a T1 card

- MPL-T cards (type LIMDS0)

This command cannot be entered when the maximum combined total number of LFS and link tests (1024) are in progress in the system. At least one test must complete before this command can be entered again.

The **force=yes** parameter must be specified to activate a test when there are 256 or more tests already running in the system.

The specified signaling link must not be running a **tst-slk** test when this command is entered. The **tst-slk** test must be stopped or allowed to complete before this command can be entered for the link.

The specified signaling link must not be in Command Driven Loopback (CDL) when this command is entered. The link must be removed from CDL before this command can be entered for the link.

This command cannot be entered for a link that is already blocked by another link diagnostic test. The test must be canceled or allowed to complete before this command can be entered for the link.

LFS testing is not available during upgrade.

The maximum number of loopback point entries allowed in the LFS table is 32.

## Notes

The **act-lbp** command is not supported for **limatm** cards.

If an LFS test is aborted by a card reset, it can leave the remote far-end loopback condition active. Use the **dact-lbp** command to cancel LFS tests.

The E1/T1 MIM card and the HC-MIM card support this command on up to 8 T1 channels at a time; the command is not supported for E1.

The test can terminate with the status "ERROR, bit error exceeded threshold" for two reasons.

- The number of cumulative bit errors exceeds the specified **maxerr** parameter value.
- The number of bit errors for one second reaches or exceeds 255, without considering the **maxerr** parameter value.

## Output

The LFS report is displayed when the LFS test completes.

The following example shows how the test failed because the bit error rate exceeded the threshold. Here the **maxerr=10** parameter is used for a test time of 2 minutes. Because more than 10 errors occurred within 2 minutes, the test is considered a failure and the **TEST STATUS** field displays the cause. The parameter values are applied to each loopback point. The **maxerr** value is per test, not cumulative for all tests.

```
act-lbp:loc=1205:link=b:pattern=alternate:maxerr=10:time=002000
tekelecstp 05-01-21 17:00:36 EST EAGLE5 33.0.0
LOC = 1205 Link = B LSN = ls11345678 Start time = 11:10:34

PATTERN = ALTERNATE DATA= FF MAXERR = 10 TIME = 00:02:00

TEST STATUS = ERROR, bit error exceeded threshold.

LBP  CLLI          RLE  REP  LFST  BIT_ERROR  ERRORED_SEC  DURATION
2    rlghncxa05w  DS0  0    LLT   0          0            00:02:00
3    -----      OCU  0    NLT   8          2            00:02:00
5    -----      NEI  0    LLT  15         1            00:01:20
;
```

In the following example, the test failed because the loopback could not be established.

```
act-lbp:loc=1205:link=b:pattern=alternate:maxerr=10:time=000200
tekelecstp 05-01-21 17:00:36 EST EAGLE5 33.0.0
LOC = 1205 Link = B LSN = ----- Start time = 11:10:34

PATTERN = ALTERNATE DATA= FF MAXERR = 10 TIME = 00:02:00

TEST STATUS = ERROR, loopback was not established.

LBP  CLLI          RLE  REP  LFST  BIT_ERROR  ERRORED_SEC  DURATION
1    rlghncxa05w  DS0  0    LLT   0          0            00:00:00
;
```

## Legend

**LOC**—Card location that contains the signaling being tested.

**LINK**—Signaling link that is being tested on the card.

**LSN**—Name of the linkset that contains the link being tested.

**START TIME**—Time that the test started.

**PATTERN**—Type of test pattern used to perform the LFS test.

**DATA**—Data used with the **octet** or **alternate** patterns.

**MAXERR**—Bit error threshold; actual number of errors allowed for the specific time period during which loopback testing is being performed. If this threshold is exceeded in the specified time period, the **TEST STATUS** field in the output report indicates an error.

**TIME**—Specified length of time to run the test in order to determine success or failure. If the number of errors that actually occur during this time exceeds the threshold set by the **maxerr** parameter, the loopback test is identified as a failure.

**TEST STATUS**—Any one of the following **TEST STATUS** values can appear:

- PASS
- ERROR, LFS HARDWARE is not available.
- ERROR, loopback could not be established.



- ERROR, bit error exceeded threshold.
- ERROR, LFS test aborted.
- ERROR, LFS hardware failed.

**LBP**—Loopback point used to perform the LFS test.

**CLLI**—Common Language Location Identifier (CLLI) code, or other mnemonic identifier, used to refer to the given loopback point.

**RLE**—Remote link element to be looped back for testing.

**REP**—Repetition count. The number of link elements of the same type (not including the target device) that lie between the STP and the link element to be tested.

**LFST**—Type of link fault sectionalization loopback test to be performed.

**BIT\_ERROR**—The number of bit errors observed during the test.

**ERRORED\_SEC**—The number of seconds that contained bit errors during the test. (Bit errors are sampled once per second; each sample that contains bit errors adds one second to this count.)

**DURATION**—Length of time that the test actually ran for the loopback point. For successful test, the TIME and the DURATION should be the same. If a test ran for less than the specified amount of time, the DURATION will be less than the TIME.

## act-lpo

### Activate Local Processor Outage

Use this command to force a processor outage on the specified link. The system begins sending link status signal units (LSSUs) with a status of SIPO to the adjacent signaling point. Level 2 status remains in service, except when the link is an ATM high-speed signaling link.

**NOTE: The signaling link's blocked status is not preserved across a LIM reboot.**

**Keyword:** act-lpo

**Related Commands:** blk-slk, canc-lpo, rept-stat-slk, ublk-slk

**Command Class:** Link Maintenance

### Parameters

**:link=** (mandatory)

The signaling link on the card specified in the **loc** parameter. The links can be specified in any sequence or pattern.

**Synonym:** port

**Range:** a, b, a1-a31, b1-b31

Not all card types support all **link** parameter values.

See Table A-1 for valid **link** parameter range values for each type of card that can have assigned signaling links.

**:loc=** (mandatory)

The card location as stenciled on the shelf of the system.

**Range:** 1101-1108, 1111-1112, 1201-1208, 1211-1218, 1301-1308, 1311-1318, 2101-2108, 2111-2118, 2201-2208, 2211-2218, 2301-2308, 2311-2318, 3101-3108, 3111-3118, 3201-3208, 3211-3218, 3301-3308, 3311-3318, 4101-4108, 4111-4118, 4201-4208, 4211-4218, 4301-4308, 4311-4318, 5101-5108, 5111-5118, 5201-5208, 5211-5218, 5301-5308, 5311-5318, 6101-6108, 6111-6118

### Example

```
act-lpo:loc=1101:link=a
```

## Dependencies

A card location that is valid and defined in the database must be specified.

No other action command can be in progress when this command is entered.

This command can be entered for IPLIMx signaling links only when they have an **ipliml2** parameter setting of **m2pa**.

This command is not valid for SSEDCCM cards or E5-ENET cards with SS7IPGW or IPGWI TCP/IP links.

The card must contain signaling links.

The signaling link must be equipped in the database.

The **link** parameter values **a1**, **b1**, **a2**, **b2**, **a3**, and **b3** can be specified only for the following cards:

- A multi-port LIM
- An E1/T1 MIM
- An HC MIM

This command is not valid for links belonging to proxy linksets.

The card must be equipped and must be one of the following cards:

- An E1-ATM card running the **atmitu** application
- An E1/T1 MIM, E5-E1T1, or HC-MIM card running the **ss7ansi** or **ccs7itu** application
- An E5-ATM card running the **atmansi** or **atmitu** application
- An E5-ENET card running the **ipsg** application
- An E5-ENET card or SSEDCCM card running the **iplim** or **iplimi** application with links having **ipliml2=m2pa**
- A LIM card running the **ss7ansi** or **ccs7itu** application
- A LIM-ATM card running the **atmansi** application

## Notes

The function of this command is the same as the **blk-slk** command.

This command generates an alarm.

If the **act-lpo** command is followed by the **init-card** command, the local processor outage is not preserved after the **init-card** command completes.

The *Installation Manual - EAGLE 5 ISS* provides an illustration of card locations.

If the **blk-slk** or **act-lpo** command is issued for an IPSPG signaling link, then one of the following events occurs:

- IPSPG-M2PA signaling link—MTP3 local processor outage is initiated.
- IPSPG-M3UA signaling link—The link is prohibited from entering service by rejecting received AS-ACTIVE messages.

**Output**

```
act-lpo:loc=1101:link=a
tekelecstp 05-01-21 17:00:36 EST EAGLE5 33.0.0
Local processor outage being set.

tekelecstp 05-01-21 17:00:36 EST EAGLE5 33.0.0
* 0014.0208 * SLK 1101,A nc00027 slk local blocked
```

**act-oap-config****Activate OAP Configuration**

Use this command to update the OAPs with the configuration data entered into the EAGLE 5 ISS database with the **chg-oap-config** command.

The **act-oap-config** command also sends the EAGLE 5 ISS Site ID to the OAPs. See the **chg-sid**, **ent-lnp-serv**, and **chg-lnp-serv** commands for more information.



**CAUTION:** Before the **act-oap-config** command can be entered, the EAGLE 5 ISS database must be provisioned with required data for the SEAS feature, depending on which of those features are turned on. If this information is left blank or incorrectly provisioned, and the **act-oap-config** command is entered, the OAP may lose SEAS connectivity. The requirements are discussed in the Dependencies section for this command.

**Keyword:** act-oap-config

**Related Commands:** chg-lnp-serv, chg-oap-config, chg-sid, dlt-lnp-serv, ent-lnp-serv, rtrv-lnp-serv, rtrv-oap-config, rtrv-sid

**Command Class:** Database Administration

**Parameters**

**:force=** (optional)

Force the EAGLE 5 ISS to provision only one OAP in a dual OAP configuration.

**Range:** yes, no

**Default:** no

**:oap=** (optional)

The OAP being updated.

**Range:** a, b, all

**Default:** all

**Example**

```
act-oap-config:oap=a:force=yes
```

**Dependencies**

Table 5-1 shows the fields of the **rtrv-oap-config** command output that must be configured depending on which feature is on. Table 5-1 also shows the parameters of the **chg-oap-config** command that are used to configure the OAP configuration data.

If the required information for a feature has already been configured in the EAGLE 5 ISS database, you do not have to re-enter all the parameters for that feature when you make a change. It is mandatory, however, that the configuration data in the EAGLE 5 ISS and the OAP database match.

**Table 5-1.** Parameters That Must Be Provisioned Prior to Updating OAP for SEAS

Feature	Fields Displayed	Required Entry before Configuration can be sent to the OAP	chg-oap-config Parameter
SEAS	SEAC CLI	An entry is required if the SEAS feature is on.	<b>seaccli</b>
	X25 Packet Size	An entry is required if the SEAS feature is on.	<b>x25ps</b>
	X25 Mode	An entry is required if the SEAS feature is on.	<b>x25mode</b>
	Hostname	An entry is required.	<b>aname</b> and <b>bname</b>
	IP Netmask	An entry may be required depending on the network configuration.	<b>anmask</b> and <b>bnmask</b>
	Default Router	An entry may be required depending on the network configuration.	<b>arouter</b> and <b>brouter</b>
	Config	An entry is required.	<b>cfg</b>

Table 5-2 shows other data not shown in the **rtrv-oap-config** command output that must be provisioned in the database before the OAP configuration can be updated.

**Table 5-2.** Other Data Required for Updating the OAP Configuration

Feature	Data Required Before an OAP can be Updated
SEAS	EAGLE 5 ISS CLI - configured with the <b>cli</b> parameter of the <b>chg-sid</b> command

To keep OAP parameters in sync with the EAGLE 5 ISS, a checksum is created using all of the OAP configuration data stored on the EAGLE 5 ISS (shown in Table 5-1 and Table 5-2). The OAP also calculates this checksum based on the data it has. The OAP returns this checksum every 5 seconds. The EAGLE 5 ISS compares the checksums and generates the following alarm within 10 seconds of any mismatch.

```
rlghncxa03w 04-01-07 11:11:28 EST EAGLE 31.3.0
```

```
* nnnn.0364 * OAP A Configuration data checksum mismatch
```

The alarm is cleared when a maintenance poll returns a checksum that matches the EAGLE 5 ISS' checksum, indicating that the databases are back in sync. The EAGLE 5 ISS clears the alarm within five seconds. The following UAM clears the alarm:

```
rlghncxa03w 04-01-07 11:11:28 EST EAGLE 31.3.0
```

```
nnnn.0365 OAP A Configuration data checksum alarm cleared
```

If the **oap=a**, **oap=b**, or **oap=all** parameter is specified with the **act-oap-config** command, then the link from the EAGLE 5 ISS to the specified OAP must be in service.

If the **oap=a** or **oap=b** parameter is specified, the **force=yes** parameter must be specified.

The SEAS Over IP feature must be turned off before this command can be entered.

**Notes**

To configure the OAP from the EAGLE 5 ISS, the procedure "Configuring the OAP from the EAGLE 5 ISS STP Terminal" in the *System Manual – EOAP* is recommended.

It is recommended that only one OAP be updated at a time. Although the **act-oap-config** command completes immediately on the EAGLE 5 ISS, processing on the OAP may take over 10 minutes depending on which parameters changed and which OAP hardware is installed. Also, whenever some parameters are changed, the OAP reboots to use the new data. The reboot interrupts the connection between that OAP and the SEAC. By updating only one OAP at a time, the EAGLE 5 ISS and the SEAC will not be isolated, as one OAP is always connected to the SEAC.

Table 5-3 shows the fields of the **rtrv-oap-config** command output that must be configured depending on which feature is on. Table 5-3 also shows the parameters of the **chg-oap-config** command that are used to configure the OAP configuration data.

**Table 5-3.** Performance Impact of **act-oap-config** parameters

Configured Parameter Group	OAP Action					Total Time Required (in seconds)
	Restart Q3 Links	Restart Q3 and SEAS Links	Bring Down, Rebuild, Bring Up Q3 and SEAS Links:	Bring Down Q3 and SEAS Links; Reboot OAP	Bring Down and Rebuild Q3 and SEAS Links; Reboot OAP	
Group A serv	X					≤ 65
Group B x25ps, x25mode		X				≤ 260
Group C celli, seacelli			X			≤ 320
Group D aname/bname aipaddr/bipaddr anmask, bnmask arouter/brouter				X		≤ 560
Group A and B		X				≤ 260
Group A and C			X			≤ 320
Group A and D				X		≤ 560
Group A, B, and C			X			≤ 320
Group A, B, and D				X		≤ 560

Table 5-3. Performance Impact of **act-oap-config** parameters

Configured Parameter Group	OAP Action					
	Restart Q3 Links	Restart Q3 and SEAS Links	Bring Down, Rebuild, Bring Up Q3 and SEAS Links:	Bring Down Q3 and SEAS Links; Reboot OAP	Bring Down and Rebuild Q3 and SEAS Links; Reboot OAP	Total Time Required (in seconds)
Group A, C, and D			X	X		≤ 620
Group B and C			X			≤ 320
Group B and D			X	X		≤ 620
Group B, C, and D			X	X		≤ 620
Group C and D					X	≤ 620

The OAP is named and addressed according to the terminal port number on the EAGLE 5 ISS control shelf backplane that the OAP is connected to. The terminal ports are numbered from MMI 0 to MMI 15. OAP A is connected to the lower numbered terminal port and OAP B is connected to the higher numbered terminal port. If the terminal port connections for the OAPs change, the names for OAPs A and B could be reversed. For example, OAP A is connected to MMI 3 and OAP B is connected to MMI 9. At some later time, OAP A is moved from MMI 3 to MMI 12. Because of this move, OAP A is now OAP B, and what was OAP B is now OAP A.

### Output

```
act-oap-config:oap=a:force=yes
  rlgncxa03w 04-01-07 11:11:28 EST EAGLE 31.3.0
  ACT-OAP-CONFIG: MASP A - COMPLTD
;
```

### act-slk

#### Activate Signaling Link

Use this command to change the link from OOS-MT-DSBLD (Out-of-Service-Maintenance-Disabled) to IS-NR (In-Service-Normal).

**NOTE: The signaling link's activated status is preserved across a card reboot.**

**Keyword:** act-slk

**Related Commands:** blk-slk, dact-slk, dlt-slk, ent-slk, inh-slk, rept-stat-slk, rtrv-slk, tst-slk, ublk-slk, unhb-slk

**Command Class:** Link Maintenance

### Parameters

**:link=** (mandatory)

The signaling link on the card specified in the **loc** parameter. The links can be specified in any sequence or pattern.

**Synonym:** port

**Range:** a, b, a1-a31, b-b31

Not all card types support all **link** parameter values.

See Table A-1 for valid **link** parameter range values for each type of card that can have a location specified in the **loc** parameter.

**:loc=** (mandatory)

The card location as stenciled on the shelf of the system.

**Range:** 1101-1108, 1111-1112, 1201-1208, 1211-1218, 1301-1308, 1311-1318, 2101-2108, 2111-2118, 2201-2208, 2211-2218, 2301-2308, 2311-2318, 3101-3108, 3111-3118, 3201-3208, 3211-3218, 3301-3308, 3311-3318, 4101-4108, 4111-4118, 4201-4208, 4211-4218, 4301-4308, 4311-4318, 5101-5108, 5111-5118, 5201-5208, 5211-5218, 5301-5308, 5311-5318, 6101-6108, 6111-6118

### Example

```
act-slk:loc=1301:link=a
```

### Dependencies

The card must be equipped and must be one of the following cards:

- An E1-ATM card running the **atmitu** application
- An E1/T1 MIM, E5-E1T1, or HC-MIM card running the **ss7ansi** or **ccs7itu** application
- An E5-ATM card running the **atmansi** or **atmitu** application
- An E5-ENET card running the **ipsg** application
- An E5-ENET card or SSEDCCM card running the **iplim** or **iplimi** application with links having **ipliml2=m2pa**
- A LIM card running the **ss7ansi** or **ccs7itu** application
- A LIM-ATM card running the **atmansi** application

This command cannot be entered while the **tst-slk** command is in progress.

A card location that is defined in the database must be specified.

The card must contain signaling links.

No other action command can be in progress when this command is entered.

The specified signaling link must be provisioned in the database.

The following **link** parameter values can be specified for the following cards that support more than 2 links per card:

- **a1-a3, b1-b3**—Multi-port LIM (MPL), SSEDCCM card running the **iplim** or **iplimi** application with links having **ipliml2=m2pa**, E1/T1 MIM card
- **a1-a31, b1-b31**—HC-MIM card
- **a1-a15, b1-b15**—E5-E1T1 card
- **a1-a7, b1-b7**—E5-ENET card running the **iplim** or **iplimi** application that supports 16 links
- **a1-a15, b1-b15**—E5-ENET card running the **ipsg** application

The specified card location must be equipped in the database.

### Notes

The *Installation Manual - EAGLE 5 ISS* provides an illustration of card locations.

**Output**

```
act-slk:loc=1301:link=a
tekelecstp 05-01-21 17:00:36 EST EAGLE5 33.0.0
Activate Link message sent to card
;
```

**act-user****Activate User**

This command is an alternate to the **login** command. Use this command to log into the system. After this command is entered, the system requests a password. For security reasons the password is not echoed to the terminal.

**Keyword:** act-user

**Related Commands:** chg-pid, chg-user, dact-user, dlt-user, ent-user, login, logout, rept-stat-user, rtrv-secu-user, rtrv-user

**Command Class:** Basic

**Parameters**

**:uid=** (mandatory)

User ID. The system prompts you for a valid password after this ID is entered.

**Range:** azzzzzzzzzzzzzzzzzzzz

1 alphabetic character followed by up to 15 alphanumeric characters; the first character must be a letter.

**Example**

```
act-user:uid=john
```

**Dependencies**

The first character of the user ID must be a letter.

**Notes**

**CAUTION:** If the OA&P IP Security Enhancements feature is not turned on, a serial terminal (terminals 1-16) must be used to log in with a new Userid and password for the first time or to change an expired password. The OA&M IP Security Enhancements feature must be turned on before you can change the password at the prompt from an IP User Interface telnet terminal (IDs 17-40) when:

- It is the first time the user is logging in with the assigned Userid and password.
- The password has expired because of aging out.

The **login** command can be used instead of **act-user**. The command **act-user** has been provided in accordance with OTGR standards.

When a new system is shipped, the user ID and password are set to the system. Change these immediately to ensure system security.

The OAP is named and addressed according to the terminal port number on the EAGLE 5 ISS control shelf backplane that the OAP is connected to. The terminal ports are numbered from MMI 0 to MMI 15. OAP A is connected to the lower numbered terminal port and OAP B is connected to the higher numbered terminal port. If the terminal port connections for the OAPs change, the names for OAPs A and B could be reversed. For example, OAP A is connected to MMI 3 and OAP B is connected to MMI 9. At some later time, OAP A is moved from MMI 3 to MMI 12. Because of this move, OAP A is now OAP B, and what was OAP B is now OAP A.



**Output**

Not applicable.

**alw-card****Allow Card**

Use this command to change the card from OOS-MT-DSBLD (Out-of-Service-Maintenance-Disabled) to IS-NR (In-Service-Normal) if the loading is successful.

**Keyword:** alw-card

**Related Commands:** dlt-card, ent-card, inh-card, init-card, rept-stat-card, rmv-card, rst-card, rtrv-card

**Command Class:** System Maintenance

**Parameters**

**:loc=** (mandatory)

Location. This parameter specifies the card location as stenciled on the shelf of the system.

**Range:** 1101-1108, 1111-1113, 1115, 1201-1208, 1211-1218, 1301-1308, 1311-1318, 2101-2108, 2111-2118, 2201-2208, 2211-2218, 2301-2308, 2311-2318, 3101-3108, 3111-3118, 3201-3208, 3211-3218, 3301-3308, 3311-3318, 4101-4108, 4111-4118, 4201-4208, 4211-4218, 4301-4308, 4311-4318, 5101-5108, 5111-5118, 5201-5208, 5211-5218, 5301-5308, 5311-5318, 6101-6108, 6111-6118

**:code=** (optional)

This parameter specifies the GPL type to be loaded.



**CAUTION:** Do not enter the **pktgen**, **utility**, or **inactiveprtn** values for this parameter unless instructed to do so by Tekelec personnel.

**Range:** **appr**, **pktgen**, **trial**, **utility**, **inactiveprtn**

**appr** — Downloads the approved GPL

**pktgen** — Downloads the **pktgen** GPL for the appropriate hardware type. This GPL is to be used only for engineering test purposes and must not be used in customer installations without engineering oversight.

**trial** — Downloads the trial GPL

**utility** — Downloads the CDU or VCDU GPL for the appropriate hardware type. This GPL is used primarily by the factory for testing purposes.

**inactiveprtn** — Downloads the MASP with associated GPL from the inactive partition of the TDM. This value should be specified only during a software upgrade.

After the **pktgen** GPL is initially downloaded to a card by the **alw-card** command, the **pktgen** GPL will continue to be downloaded to the card until another **alw-card** command is issued.

**Default:** **appr**

**:data=** (optional)

High memory refresh. This parameter causes data to be reloaded to the specified card. This parameter is used to reload data if the G-Flex, G-Port, INP, or V-Flex feature is turned on or the ATINP feature is enabled (see the **enable-ctrl-feat** and **chg-ctrl-feat** commands). This parameter is applicable only to network cards containing the MPS database (VSCCP).

**NOTE:** Various conditions in the system may prevent the persistence of the data on the cards.

**Range:** **refresh**, **persist**

**refresh** — Causes data to be reloaded to the specified card.

**persist**— Indicates that the database is not to be reloaded to the card. This parameter is used to request that the EAGLE 5 ISS perform a warm restart of the requested cards. The EAGLE 5 ISS performs various checks to ensure that all conditions necessary to initiate the warm restart are in place. During the card initialization and loading sequence, a warm restart is performed if the card meets the warm restart conditions, as described in the Notes section of this command.

**Default:** refresh

### Example

```
alw-card:loc=2301:code=trial
```

```
alw-card:loc=1101:data=persist
```

### Dependencies

The active and standby TDM card locations and the card location that is running the active OAM cannot be specified in the **loc** parameter.

The shelf and card must be equipped.

No other action command can be in progress when this command is entered.

The G-Flex, G-Port, INP, LNP, or V-Flex feature must be turned on, or the ATINP feature must be enabled before the **data** parameter can be specified.

The **data** parameter is valid only for SCCP card locations or GPLs, or MPS database (VSCCP) card locations or GPLs.

A card that is the active MASP cannot be specified for the **loc** parameter.

A card location that is valid and defined in the database must be specified.

If an OAM card is installed in the location specified by the **loc** parameter, then only a value of **inactiveprtn** is supported for the **code** parameter.

### Notes

The function of this command is the same as the **rst-card** command.

The *Installation Manual - EAGLE 5 ISS* provides an illustration of card locations.

The system previously supported the **data** parameter for reloading GTT data. The system does not support persistent GTT data loading, and the **data** parameter is now used in support of a warm restart feature.

A number of reasons exist for not being able to warm restart. If none of these conditions exists, a warm restart is possible and will be attempted following a Service Module card reset.

- The following conditions require a full data reload:
  - **AUDIT FAILED**—The checksum comparisons of the LNP database failed during card initialization. Data on the card is determined to be corrupted after the reset (was not yet detected by normal auditing).
  - **AUDIT TIMEOUT**—The LNP initialization audit timed out (software failure).
  - **DB LEVEL**—The database level is not supported, or the difference exceeds incremental loading capability. This condition is caused by the reset of OAMs or if the number of updates exceeds the incremental loading capability.
  - **DB STATUS**—The database status of the card is incoherent at the time of a reset. This condition can be caused by a failed network card update or a reset during a database update to the card.

- **DB VERSION**—The LNP Database version has changed from the previous version. An import, or bulk downloads (**chg-db**), or changes from release to release may alter the database version.
  - **HW ERROR**—The hardware error bit checks on the card failed during card initialization.
  - **NO AUDIT**—Unable to perform an LNP audit. The LNP audit is not on (for example, LNP options has **audit=off**). This condition can occur if the rate of LNP updates exceeds the ability of the LNP audit to compute checksums (excessive unknown checksums). This condition is more likely on a small database where there are fewer checksums. The percentage of known checksums must be 99% or more. The percentage is based on the number of checksums in use, which is smaller for small databases (such as two million TNs or fewer).
  - **POWER ON**—A power on reset (the card is pulled and reinserted).
  - **UNKNOWN/OTHER**—An unknown or other type of software failure.
  - **USER REQUEST**—A user-initiated **init-card** or **init-sys** command **reload type=cold**. The default restart type for these commands is a cold or full LNP data reload. The user must specify **data=persist** for a warm restart on command.
  - **XILINX VERSION**—The M256 Xilinx program version has changed from the previous version.
- The following conditions require an MPCM card cold restart:
    - **DB STATUS**—The database status of the card is incoherent at the time of a reset. This condition can be caused by a failed network card update or a reset during a database update to the card.
    - **MEAS DB**—A measurements database Init failure or corruption.
    - **POWER ON**—A power on reset (card is pulled and reinserted).
    - **UNKNOWN/OTHER**—An unknown or other type of software failure.
    - **XILINX VERSION**—The D1G Xilinx program version has changed from previous version.



**CAUTION CAUTION: This command can be used to enable Measurements Platform measurements collection after the collection function has been disabled with the inh-card command for ALL MPCM cards in the system. To enable collection, at least 1 MPCM card must be allowed in the system. Disabling collection by inhibiting all MPCM cards CAN RESULT IN LOSING ALL PAST MEASUREMENT DATA ON THE CARDS.**

When the OA&M IP Security feature is turned on, and an IPSM card is inserted and initialized for the first time or is removed, inserted, and initialized again, the "SSH Host Keys Regenerated" UIM is displayed. The UIM shows the generated SSH Host Key fingerprint that must be provided at the secure client in order for secure information transfer to occur. The SSH Host Key fingerprint is changed whenever power is lost and restored to an IPSM card.

```
rlghncxa03 03-07-11 07:05:00 EST EAGLE 30.2.0
```

```
0021.1493 CARD 1111 INFO SSH Host Keys Regenerated
```

```
84 7c 92 8b c 7c ds 19 1c 6 4b de 5c 8f c5 4d
```

```
Report Date:03-07-11 Time:22:27:36
```

When the OA&M IP Security feature is turned on, and an IPSM card is restarted with this command, the "SSH Host Keys Loaded" UIM is displayed. The UIM shows the current SSH Host Key fingerprint. The SSH Host Key fingerprint is not changed if the IPSM card does not lose power.

```
rlghncxa03 03-07-11 07:05:00 EST EAGLE 30.2.0
```

```
0021.1493 CARD 1111 INFO SSH Host Keys Regenerated
```

```
DSA Server Host Key FTRA-formatted Fingerprint=
```

```
84 7c 92 8b c 7c ds 19 1c 6 4b de 5c 8f c5 4d
```

```
Report Date:03-07-11 Time:22:27:36
```

If a location for an E1/T1 MIM card (type **lime1**, **limt1**, or **limch**), HC-MIM card (type **lime1** or **limt1**), E5-E1T1 card (type **lime1** or **limt1**), or E5-ATM card (type **limatm** or **lime1atm**) is specified, then at least one signaling link must be provisioned for that card before it can be allowed.

## Output

```
alw-card:loc=2301:code=trial
```

```
rlghncxa03w 06-06-01 11:11:28 EST EAGLE 35.0.0
```

```
Card has been allowed.
```

```
;
```

## alw-imt

## Allow IMT

Use this command to change the state of the specified Interprocessor Message Transport (IMT) bus from OOS-MT-DSBLD (Out-of-Service-Maintenance-Disabled) to IS-NR (In-Service-Normal), if the command is successful. If the command fails, the status is IS-ANR (In-Service-Abnormal). The IMT bus is comprised of two 125 Mbps counter-rotating serial busses. If one bus fails, the other immediately assumes control of all messages.

**Keyword:** **alw-imt**

**Related Commands:** **clr-imt-stats**, **conn-imt**, **disc-imt**, **inh-imt**, **rept-imt-lvl1**, **rept-imt-lvl2**, **rept-stat-imt**, **rmv-imt**, **rst-imt**, **tst-imt**

**Command Class:** System Maintenance

## Parameters

**:bus=** (mandatory)

This parameter specifies the IMT bus whose status you want to change.

**Range:** a, b

## Example

```
alw-imt:bus=a
```

## Dependencies

This command cannot be entered during an IMT Fault Isolation Test.

This command cannot be entered if an IMT Rate Change sequence is in progress.

## Notes

This command returns an inhibited IMT bus to service.

The function of this command is the same as the **rst-imt** command.

See the **tst-imt** command to determine the location of faults on a failed or abnormal IMT bus.

**Output**

```

alw-imt:bus=a
rlghncxa03w 04-01-07 11:11:28 EST EAGLE 31.3.0
Allow IMT Bus A command issued.

rlghncxa03w 04-01-07 11:11:28 EST EAGLE 31.3.0
0100.0097 IMT BUS A Imt allowed
;

```

**alw-map-ss****Allow Mated Application Subsystem**

Use this command to activate a subsystem and bring it online. Currently, the ATINPQ, EIR, INP, INPQS, LNP, LNPQS, and V-Flex subsystems can be allowed and inhibited.

**Keyword:** **alw-map-ss**

**Related Commands:** **inh-map-ss, rept-stat-lnp, rept-stat-sccp**

**Command Class:** System Maintenance

**Parameters**

**:ssn=** (mandatory)

Subsystem number. This parameter specifies the ATINPQ, EIR, INP, LNP, or V-Flex subsystem number.

**Range:** **2-255**

**Example**

```
alw-map-ss:ssn=10
```

**Dependencies**

No other action command can be in progress when this command is entered.

The EAGLE 5 ISS must be configured with at least one Service Module card running the **vsccp** application.

The ATINP, EIR, INP, LNP, or V-Flex feature must be turned on before this command can be entered.

The value specified for the **ssn** parameter must be the ATINPQ, EIR, INP, LNP, or V-Flex subsystem number.

The LNPQ subsystem must be online in the database before this command can be entered.

The V-Flex subsystem must be online in the database before this command can be entered.

The ATINPQ subsystem must be online in the database before this command can be entered.

The INP subsystem must be online in the database before this command can be entered.

The EIR subsystem must be online in the database before this command can be entered.

**Notes**

None

**Output**

```

alw-map-ss:ssn=11
integrat40 00-05-24 10:37:22 EST EAGLE5 31.0.0
Allow map subsystem command sent to all SCCP cards.
Command Completed.
;

```

**alw-slk****Allow Signaling Link**

Use this command to return an inhibited signaling link to service. If the link was aligned when it was inhibited, a changeover occurred. This command causes a changeback on the specified link. MSUs are transmitted on the link after the changeback is issued.

**NOTE: The signaling link's inhibited status is not preserved across a card reboot.**

**Keyword:** alw-slk

**Related Commands:** act-slk, blk-slk, canc-slk, dact-slk, dlt-slk, ent-slk, inh-slk, rept-stat-slk, rtrv-slk, tst-slk, ublk-slk, unhb-slk

**Command Class:** Link Maintenance

**Parameters**

**:link=** (mandatory)

This parameter specifies the signaling link defined on the card specified in the **loc** parameter. The links can be specified in any sequence or pattern.

**Synonym:** port

**Range:** a, b, a1-a31, b1-b31

Not all card types support all **link** parameter values.

See Table A-1 for valid **link** parameter range values for each type of card that can have a location specified in the **loc** parameter.

**:loc=** (mandatory)

Location. This parameter specifies the card location as stenciled on the shelf of the system.

**Range:** 1101-1108, 1111-1112, 1201-1208, 1211-1218, 1301-1308, 1311-1318, 2101-2108, 2111-2118, 2201-2208, 2211-2218, 2301-2308, 2311-2318, 3101-3108, 3111-3118, 3201-3208, 3211-3218, 3301-3308, 3311-3318, 4101-4108, 4111-4118, 4201-4208, 4211-4218, 4301-4308, 4311-4318, 5101-5108, 5111-5118, 5201-5208, 5211-5218, 5301-5308, 5311-5318, 6101-6108, 6111-6118

**Example**

```
alw-slk:loc=1301:link=b
```

**Dependencies**

A card location that is valid and defined in the database must be specified.

No other action command can be in progress when this command is entered.

The card must contain signaling links.

The signaling link must be equipped in the database.

The following **link** parameter values can be specified for the following cards that support more than 2 links per card:

- **a1-a3, b1-b3**—Multi-port LIM (MPL), SSEDCCM card running the **iplim** or **iplimi** application with links having **ipliml2=m2pa**, E1/T1 MIM card
- **a1-a31, b1-b31**—HC-MIM card
- **a1-a15, b1-b15**—E5-E1T1 card
- **a1-a7, b1-b7**—E5-ENET card running the **iplim** or **iplimi** application that supports 16 links.
- **a1-a15, b1-b15**—E5-ENET card running the **ipsg** application

This command is not valid on TCP/IP point to multipoint links (SSEDCCM cards or E5-ENET cards equipped as IPGWI or SS7IPGW links).

The card that contains the specified signaling link must be equipped in the specified card location.  
 The card in the specified card location cannot be a TDM card, an MDAL card, an HMUX or HIPR card, or the cards running the OAM application.  
 If IPSPG-M3UA signaling links are used, then this command cannot be entered.

### Notes

The function of this command is the same as the **unhb-slk** command.  
 Not every card location represents a signaling link. Be sure to address a signaling link in this command.  
 The *Installation Manual - EAGLE 5 ISS* provides an illustration of card locations.

### Output

```
alw-slk:loc=1301:link=b
tekelecstp 05-01-21 17:00:36 EST EAGLE5 33.0.0
Allow Link message sent to card
;
```

## alw-trm

### Allow Terminal

Use this command to return the specified serial port to the state IS-NR (in-service normal) from the state OOS-MT-DSBLD (out-of-service maintenance-disabled) if the command is successful. If the command is not successful, the terminal's state is OOS-MT (out-of-service maintenance).

**Keyword:** alw-trm

**Related Commands:** act-echo, canc-echo, chg-trm, dact-echo, inh-trm, rept-stat-trm, rmv-trm, rst-trm, rtrv-trm

**Command Class:** System Maintenance

### Parameters

**:trm=** (mandatory)

This parameter specifies the ID of the serial or telnet port to be put into service.

**Range:** 1-40

### Example

```
alw-trm:trm=5
alw-trm:trm=23
```

### Dependencies

No other action command can be in progress when this command is entered.

The IP User Interface feature must be enabled before terminal ports 17 through 40 can be specified in the **trm** parameter.

The terminal specified by the **trm** parameter must be equipped.

If a SEAS terminal is configured, then the IP address for the associated E5-IPSM card must be specified before this command can be entered.

The SEAS Over IP feature must be turned on before a SEAS terminal can be specified.

The specified SEAS terminal cannot be auto-inhibited.

If a critical thermal alarm is raised against the E5-IPSM card hosting the terminal, then the specified Telnet terminal cannot be returned to the IS-NR state.

**Notes**

The function of this command is the same as the **rst-trm** command.

When you attempt to return to service a terminal that is already in service, a warning message is echoed to the scroll area but no action is taken.

If a SEAS terminal is configured, then the corresponding card must be an E5-IPSM card, and the SEAS Over IP feature must be turned on before the SEAS terminal is allowed. The SEAS terminal is auto-inhibited if the IP Address for the corresponding E5-IPSM card is invalid.

**Output**

```
alw-trm:trm=12
rlghncxa03w 04-01-07 11:11:28 EST  EAGLE 31.3.0
Allow message sent to terminal

rlghncxa03w 04-01-07 11:11:28 EST  EAGLE 31.3.0
1062.0046      TERMINAL      12      Terminal Enabled
;
```

**aud-data****Audit Data**

Use this command to perform a data audit, which is used to determine the integrity of the static and dynamic databases. This command can also be used to perform a separate GPL audit.

**Keyword:** aud-data

**Related Commands:** chg-gpl, rept-stat-db, rept-stat-ddb, rtrv-gpl

**Command Class:** System Maintenance

**Parameters**

**:ddbqp=** (optional)

DDB quiet period. This parameter specifies the minimum DDB idle time, in milliseconds, during which no DDB updates are applied. After the quiet period, it is assumed that all DDB updates in the system have been processed, and no outstanding in-flight multi-cast updates exist.

If the idle period that is reported by the network card is less than the quiet period, then additional network responses are discarded, and the DDB audit process restarts. Up to three retries of the DDB audit process are performed by system. If all of the retry efforts fail, then the system status of the DDB audit report is marked as ABORTED.

**Range:** 0-5000

**Default:** 500

**:display=** (optional)

This parameter specifies whether a brief or full display is provided for the audit.

This parameter applies to static and dynamic STP databases.

**Range:** all, brief, except

**all**— For the static database, displays the checksum values, in hexadecimal, and details for each GPL and each subset of the current and backup database. For the dynamic database, displays the checksum values, in hexadecimal, for each dynamic database table on MTP cards.

**brief**— For the static database, displays the data collections for the current database, the backup database on the fixed disk, and the approved and trial GPLs. For the dynamic database, displays the system status with number of cards responded with or without checksum, the list of inconsistent cards, list of non-responding cards, number of cards not meeting quiet period requirement, number of cards responded with "DDB update in progress", and active MTP cards in system.



**except**— For GPLs or database subsets with problems, displays the same information as **display=all**

**Default:** **brief**

**:gplqp=** (optional)

GPL data audit quiet period. This parameter specifies the number of audit cycles between audits of GPL data.

**NOTE: Data audits are always performed on GPLs at the first audit cycle after the EOAM or E5-OAM card recovers from a boot.**

**Range:** **0-20**

**0**—a GPL data audit is performed for every audit cycle

**Default:** No change from the current value

**System**

**Default:** **20**

**:tblid=** (optional)

DMS Table ID. This parameter specifies the table where the checksum is performed.

**Range:** **0-1022**

**:type=** (optional)

This parameter specifies the database to be audited.

**Range:** **fixed, ddb**

**fixed**— static database

**ddb**— dynamic database

**Default:** **fixed**

## Example

```
aud-data:type=ddb:display=brief
```

```
aud-data:type=ddb:ddbqp=1000
```

```
aud-data:display=except
```

```
aud-data:tblid=127
```

```
aud-data:gplqp=3
```

## Dependencies

Only one **aud-data** command can be in progress at a time.

If the **type=ddb** parameter is specified, then the **except** parameter cannot be specified.

If the **ddbqp** parameter is specified, then the **type=ddb** parameter must be specified.

If the **gplqp** parameter is specified, then the **tblid**, **ddbqp**, and **type=ddb** parameters cannot be specified. The **display** and **tblid** parameters cannot be specified together in the command.

The DMS table specified by the **tblid** parameter must already exist.

If the system is in upgrade mode, then this command cannot be entered.

## Notes

### *Static Audit*

The standby OAM must be available when the **aud-data** command for audit begins so that the standby OAM can receive the signal to begin auditing. If the standby OAM is not available when **aud-data** is issued, then the following messages are issued:

```
Extended Processing Time Required
```

```
Standby MASP is (or was) not available at audit start.
```

The above messages may also appear if the standby OAM is not available when the hourly periodic audit, which uses the **aud-data** command, automatically starts. The standby OAM is not performing any data auditing, so no audit results for the standby OAM are displayed in the audit report. Instead, the standby's audit results are as follows:

```
No information currently available
```

If an auditing cycle completes on either the active or standby OAM and does not produce the full set of expected results (checksums), the following message appears:

```
Audit results may be incomplete
```

The audit results may be missing some of the checksums that would normally be displayed (**display=all** or **display=except**). The results may also contain summary status information (**display=brief**) that might have been calculated differently had some of the missing checksums been available. This condition can be caused if the audit results for the backup database are missing, probably because a backup database has not been created.

If the "Audit results may be incomplete" message appears in the audit report, perform the following procedure:

### Audit Data

---

- 1 Ensure that the standby OAM is online and ready.

---

- 2 Ensure that a backup database has been created. Use **rept-stat-db** command to check whether a backup database has been created. If no backup has ever been created, the output of **rept-stat-db** command shows the fixed disk backup (FD BKUP) database at level 1. There will be no information under the heading "Time Last Backup."

---

- 3 If necessary, create a backup on the fixed disk by entering the following command: **chg-db:action=backup:dest=fixed**

---

- 4 Re-enter the **aud-data** command.

---

If the standby OAM does not run an audit cycle and no audit information is available, the following message appears:

```
Audit results are not available
```

This condition is probably caused by the standby OAM rebooting while an audit cycle is underway. If this message appears, ensure that the standby OAM is available and re-enter the **aud-data** command. Ensure that the standby OAM remains up (is not rebooted) for the duration of the audit cycle.

### Dynamic Audit

The **aud-data** command is enhanced to allow a Dynamic data audit to be triggered manually.

If a dynamic background audit is already running, and the **aud-data** command is issued for a dynamic audit, then the following message appears.

```
Periodic dynamic database audit is running with default quiet period.
Results will be displayed on completion.
```

The Standby OAM is not required for a dynamic audit.

Output

The following example shows a full display of a fixed database audit.

**aud-data:display=all**

```
rlghncxa03w 09-07-07 10:39:04 EST EAGLE 41.1.0
DATA AUDIT COMPLETE (GPL AUD Quiet Period set to 3)
```

CARD	LOC	DATA	STATUS	NEW CS	OLD CS	REF CS
TDM-ACTV	1114	CRNT MTP	SUBSET OK	H'ffaf	H'ffaf	H'ffaf
		CRNT GTT	SUBSET OK	H'5864	H'5864	H'5864
		CRNT GWS	SUBSET OK	H'd089	H'd089	H'd089
		CRNT MISC	SUBSET OK	H'2735	H'2735	H'2735
		CRNT DBMM	SUBSET OK	H'1001	H'1001	H'1001
		BKUP MTP	SUBSET OK	H'2b85	H'2b85	H'2b85
		BKUP GTT	SUBSET OK	H'5864	H'5864	H'5864
		BKUP GWS	SUBSET OK	H'd089	H'd089	H'd089
		BKUP MISC	SUBSET OK	H'5af1	H'5af1	H'5af1
		BKUP DBMM	SUBSET OK	H'1001	H'1001	H'1001
		APPR ATMANSI	GPL OK	H'1372	H'1372	H'1372
		TRI ATMANSI	GPL OK	H'1372	H'1372	H'1372
		APPR VSCCP	GPL OK	H'9251	H'9251	H'9251
		TRI VSCCP	GPL OK	H'9251	H'9251	H'9251
		APPR GLS	GPL OK	H'8887	H'8887	H'8887
		TRI GLS	GPL OK	H'8887	H'8887	H'8887
		APPR UTILITY	GPL OK	H'18de	H'18de	H'18de
		TRI UTILITY	GPL OK	H'18de	H'18de	H'18de
		APPR	OK	H'b6c6	H'b6c6	H'b6c6
		TRI	OK	H'b6c6	H'b6c6	H'b6c6

```
rlghncxa03w 09-07-07 10:39:04 EST EAGLE 41.1.0
DATA AUDIT COMPLETE (GPL AUD Quiet Period set to 3)
```

CARD	LOC	DATA	STATUS	NEW CS	OLD CS	REF CS
TDM-STDBY	1116	CRNT MTP	SUBSET OK	H'ffaf	H'ffaf	H'ffaf
		CRNT GTT	SUBSET OK	H'5864	H'5864	H'5864
		CRNT GWS	SUBSET OK	H'd089	H'd089	H'd089
		CRNT MISC	SUBSET OK	H'2735	H'2735	H'2735
		CRNT DBMM	SUBSET OK	H'1001	H'1001	H'1001
		BKUP MTP	SUBSET OK	H'2b85	H'2b85	H'2b85
		BKUP GTT	SUBSET OK	H'5864	H'5864	H'5864
		BKUP GWS	SUBSET OK	H'd089	H'd089	H'd089
		BKUP MISC	SUBSET OK	H'5af1	H'5af1	H'5af1
		BKUP DBMM	SUBSET OK	H'1001	H'1001	H'1001
		APPR ATMANSI	GPL OK	H'1372	H'1372	H'1372
		TRI ATMANSI	GPL OK	H'1372	H'1372	H'1372
		APPR VSCCP	GPL OK	H'9251	H'9251	H'9251
		TRI VSCCP	GPL OK	H'9251	H'9251	H'9251
		APPR GLS	GPL OK	H'8887	H'8887	H'8887
		TRI GLS	GPL OK	H'8887	H'8887	H'8887
		APPR UTILITY	GPL OK	H'18de	H'18de	H'18de
		TRI UTILITY	GPL OK	H'18de	H'18de	H'18de
		APPR	OK	H'b6c6	H'b6c6	H'b6c6
		TRI	OK	H'b6c6	H'b6c6	H'b6c6

;

**aud-data:display=except**

```
rlghncxa03w 09-07-07 10:39:04 EST EAGLE 41.1.0
Extended Processing Time Required
Results will be displayed on completion
```

```
rlghncxa03w 09-07-07 10:39:04 EST EAGLE 41.1.0
DATA AUDIT COMPLETE (GPL AUD Quiet Period set to 3):
```

CARD	LOC	DATA	STATUS	NEW CS	OLD CS	REF CS
TDM-ACTV	1116	CRNT MTP	SUBSET DIFFERENT	H'aaaa	H'aaaa	H'cccc
		CRNT GTT	SUBSET CORRUPTED	H'aaaa	H'bbbb	H'aaaa

```

        APPR MCM      GPL      CORRUPTED  H'4321 H'3456 H'4321
        APPR GLS      GPL      CORRUPTED  H'4321 H'3456 H'4321
        APPR VSCCP    GPL      CORRUPTED  H'4321 H'3456 H'4321
    
```

```

rlghncxa03w 09-07-07 10:39:01 EST  EAGLE 41.1.0
Extended Processing Time Required
Results will be displayed on completion
    
```

```

rlghncxa03w 09-07-07 10:39:04 EST  EAGLE 41.1.0
DATA AUDIT COMPLETE (GPL AUD Quiet Period set to 3):
CARD      LOC      DATA      STATUS      NEW CS OLD CS REF CS
TDM-STDBY 1114  CRNT MTP    SUBSET DIFFERENT  H'aaaa H'aaaa H'cccc
          CRNT GTT    SUBSET CORRUPTED  H'aaaa H'bbbb H'aaaa
          APPR MCM    GPL    CORRUPTED  H'4321 H'3456 H'4321
          APPR GLS    GPL    CORRUPTED  H'4321 H'3456 H'4321
          APPR VSCCP  GPL    CORRUPTED  H'4321 H'3456 H'4321
    
```

The following example shows a brief display of a fixed database audit.

**aud-data or aud-data:display=brief**

```

rlghncxa03w 09-07-07 10:39:04 EST  EAGLE 41.1.0
DATA AUDIT COMPLETE (GPL AUD Quiet Period set to 3):
CARD      LOC      DATA      STATUS
TDM-ACTV  1114  CRNT DB    OK
          BKUP DB    OK
          GPLS      OK
    
```

```

rlghncxa03w 09-07-07 10:39:04 EST  EAGLE 41.1.0
DATA AUDIT COMPLETE (GPL AUD Quiet Period set to 3):
CARD      LOC      DATA      STATUS
TDM-STDBY 1116  CRNT DB    OK
          BKUP DB    OK
          GPLS      OK
    
```

The following example shows a full dynamic database audit.

**aud-data:type=ddb:display=all**

```

tekelecstp 09/07/21 17:04:47 GMT  EAGLE 41.1.0
DDB AUDIT REPORT
SYSTEM STATUS      : INCONSISTENT
ACTIVE MTP CARDS   : 21
NON RESPONDING CARDS : 7: 1207 1208 1211 1212 2108 2111 2112
RESPONDING CARDS   : 14
CARDS WITH NO DATA : 2
CARDS WITH DATA   : 12
CARDS FAILING QUIET PRD : 0
CARDS WITH DDB UPD IN PRG : 3
CARDS CONSIDERED FOR CKSM : 9
INCONSISTENT CARDS : 2: 1203 2103
CONSISTENT CARDS   : 7
AUDIT START TIME   : 21/07/2009 17:04:46
QUIET PERIOD       : 600 ms

RTE      LINK SET  LINK      CM CARD  CM CLSTR  MATED APPL MTP GLOBLs
LOC      STATUS   CAUSE     IDLE     DDB UPD   ADDN'L STATUS
H'000003e8 H'000003e8 H'000003e8 H'000003e8 H'000003e8 H'000003e8 H'000003e8
1201 CONSISTENT 700 1000
H'000003e8 H'000003e8 H'000003e8 H'000003e8 H'000003e8 H'000003e8 H'000003e8
1202 CONSISTENT 700 1000
H'000007d0 H'000007d0 H'000007d0 H'000007d0 H'000007d0 H'000007d0 H'000007d0
1203 INCONSISTENT 700 1000
-----
1204 NODATA (DDB INIT) -----
H'00000bb8 H'00000bb8 H'00000bb8 H'00000bb8 H'00000bb8 H'00000bb8 H'00000bb8
    
```

```

1205 IN UPDATE 1 (TSRC,DDB) 700 1000 (IGNORED)
H'000003e8 H'000003e8 H'000003e8 H'000003e8 H'000003e8 H'000003e8 H'000003e8
1206 CONSISTENT 700 1000
-----
1207 NORESP -----
-----
1208 NORESP -----
-----
1211 NORESP -----
-----
1212 NORESP -----
H'000003e8 H'000003e8 H'000003e8 H'000003e8 H'000003e8 H'000003e8 H'000003e8
1213 CONSISTENT 700 1000
H'000003e8 H'000003e8 H'000003e8 H'000003e8 H'000003e8 ----- H'000003e8
2101 CONSISTENT 700 1000
H'000003e8 H'000003e8 H'000003e8 H'000003e8 H'000003e8 ----- H'000003e8
2102 CONSISTENT 700 1000
H'000007d0 H'000007d0 H'000007d0 H'000007d0 H'000007d0 ----- H'000007d0
2103 INCONSISTENT 700 1000 (WWA UPD=2)
-----
2104 NODATA (DDL XLOAD) -----
H'00000bb8 H'00000bb8 H'00000bb8 H'00000bb8 H'00000bb8 ----- H'00000bb8
2105 IN UPDATE 2 (DDB) 700 1000 (IGNORED)
H'00000bb8 H'00000bb8 H'00000bb8 H'00000bb8 H'00000bb8 ----- H'00000bb8
2106 IN UPDATE 2 (TSRC,DDB) 700 1000 (IGNORED)
H'000003e8 H'000003e8 H'000003e8 H'000003e8 H'000003e8 ----- H'000003e8
2107 CONSISTENT 700 1000
-----
2108 NORESP -----
-----
2111 NORESP -----
-----
2112 NORESP -----

```

;

The following example shows a brief dynamic database audit.

**aud-data:type=ddb:display=brief**

```

tekelecstp 09-07-15 07:34:13 GMT EAGLE 41.1.0
DDB AUDIT REPORT
SYSTEM STATUS : OK
ACTIVE MTP CARDS : 10
NON RESPONDING CARDS : 0
RESPONDING CARDS : 10
CARDS WITH NO DATA : 0
CARDS WITH DATA : 10
CARDS FAILING QUIET PRD : 0
CARDS WITH DDB UPD IN PRG : 0
CARDS CONSIDERED FOR CKSM : 10
INCONSISTENT CARDS : 0
CONSISTENT CARDS : 0
AUDIT START TIME : 15/07/2009 07:34:12
QUIET PERIOD : 20 ms

```

;

**aud-data:tblid=127**

```

audit 09-08-12 15:49:28 EST EAGLE 41.1.0
Extended processing time required.
Results will be displayed on completion.

```

;

```

audit 09-08-12 15:50:08 EST EAGLE 41.1.0

```

```

CARD LOC TABLE ID STATUS NEW CS OLD CS REF CS
TDM-ACTV 1114 127 OK H'cb03 H'cb03 H'cb03

```

;

TABLE mtt.tbl AUDIT COMPLETE:

CARD	LOC	TABLE ID	STATUS	NEW CS	OLD CS	REF CS
TDM-STDBY	1116	127	OK	H'cb03	H'cb03	H'cb03

The following example shows a full DDB audit when the status is ABORTED. Cards marked ("?") reported correct replies but their status was not evaluated.

**aud-data:type=ddb:display=all:ddbqp=600**

tekelecstp 09-07-21 21:07:57 GMT EAGLE 41.1.0

DDB AUDIT REPORT

```

SYSTEM STATUS           : ABORTED
ACTIVE MTP CARDS       : 21
NON RESPONDING CARDS   : 18: 1207 1208 1211 1212 2108 2111 2112 2113
RESPONDING CARDS       : 3
CARDS WITH NO DATA    : 0
CARDS WITH DATA       : 3
CARDS FAILING QUIET PRD : 1
CARDS WITH DDB UPD IN PRG : 1
CARDS CONSIDERED FOR CKSM : 0
INCONSISTENT CARDS     : 0
CONSISTENT CARDS       : 0
AUDIT START TIME       : 21/07/2009 21:07:54
QUIET PERIOD           : 600 ms
    
```

RTE	LINK SET	LINK	CM CARD	CM CLSTR	MATED APPL	MTP GLOBS
LOC	STATUS	CAUSE	IDLE	DDB UPD	ADDN'L	STATUS
H'000003e8	H'000003e8	H'000003e8	H'000003e8	H'000003e8	H'000003e8	H'000003e8
1201	NQUIET		100	1000		
H'000003e8	H'000003e8	H'000003e8	H'000003e8	H'000003e8	H'000003e8	H'000003e8
1202	IN UPDATE 1	(DDB)	700	1000		
H'000003e8	H'000003e8	H'000003e8	H'000003e8	H'000003e8	H'000003e8	H'000003e8
1203	?		700	1000		
-----						
1204	NORESP					
-----						
1205	NORESP					
-----						
1206	NORESP					
-----						
1207	NORESP					
-----						
1208	NORESP					
-----						
1211	NORESP					
-----						
1212	NORESP					
-----						
1213	NORESP					
-----						
2101	NORESP					
-----						
2102	NORESP					
-----						
2103	NORESP					
-----						
2104	NORESP					
-----						
2105	NORESP					
-----						
2106	NORESP					
-----						
2107	NORESP					

```

-----
2108 NORESP -----
-----
2111 NORESP -----
-----
2112 NORESP -----

```

;

**Legend**

Fixed Audit

- **CARD**—Card type
- **LOC**—Card location
- **DATA**—Type of data being audited:
  - **APPR**—Approved GPL
  - **BKUP**—Database in the backup partition
  - **CRNT**—Database in the current partition
  - **DBMM**—Database management mechanism database
  - **GLS**—GLS GPL
  - **GTT**—Global title translation database
  - **GWS**—Gateway screening database
  - **MISC**—Miscellaneous system configuration database
  - **MTP**—Message transfer part database (links, linksets, routing tables)
  - **VSCCP**—VSCCP GPL
  - **ATMANSI**—ATMANSI GPL
  - **SUBSET** or **GPL**—Indicates whether the data is a part of the database or a generic program load.
  - **TRI**—Trial GPL
- **STATUS**—Status of the database or GPL:
  - **CORRUPTED**—The database or GPL has been changed by some abnormal process. The GPL cannot be used.
  - **DIFFERENT**—The database or GPL contains information that is not consistent with the reference database or GPL
  - **OK**—The database or GPL is not corrupted and contains the same information as the reference database or GPL
- **NEW CS**—New checksum value calculated by this command
- **OLD CS**—Checksum value stored in the database or GPL
- **REF CS**—Reference checksum value stored on the active MASP

Dynamic DDB Audit

- **SYSTEM STATUS:**

- **OK**—DDB is consistent on all active MTP cards or no active MTP card is present in system
  - **INCONSISTENT**—DDB is inconsistent
  - **UNKNOWN**—"All active MTP cards in the system responded without the checksum of DDB table" or "No active MTP card in the system responded to audit request"
  - **ABORTED**—"Checksums collected failed to meet the quiet period requirement" or "Number of cards responded with "DDB update in progress" greater than 25% number of cards responded with data"
- **ACTIVE MTP CARDS**—Number of active MTP cards
  - **NON RESPONDING CARDS**—Number of non-responding cards
  - **RESPONDING CARDS**—Number of responding cards
  - **CARDS WITH NO DATA**—Cards sending replies without the checksum of dynamic tables, due to incomplete DDL crossload or DDB initialization
  - **CARDS WITH DATA**—Cards sending replies with checksums
  - **CARDS FAILING QUIET PRD**—Cards failing quiet time requirement
  - **CARDS WITH DDB UPD IN PRG**—Cards sending replies marked as "DDB update in progress" due to DDB checksum not evaluated completely or TSRC task is incomplete
  - **CARDS CONSIDERED FOR CKSM**—Cards sending correct replies. Replies are not marked with "DDB update in progress" or "Reply with no data".
  - **INCONSISTENT CARDS**—Cards that are inconsistent
  - **CONSISTENT CARDS**—Cards that are consistent
  - **AUDIT START TIME**—Time that the audit started (*DD/MM/YYYY hh:ms:ss* format)
  - **QUIET PERIOD**—Minimum DDB idle time, in milliseconds, during which no DDB updates are applied
  - **RTE**—Checksum of RTE Table
  - **LINK SET**—Checksum of Link Set Table
  - **LINK**—Checksum of Link Table
  - **CM CARD**—Checksum of CM Card
  - **CM CLSTR**—Checksum of CM Cluster
  - **MATED APPL**—Checksum of Mated Application
  - **MTP GLOBS**—Checksum of MTP Globals Table
  - **IDLE (PERIOD)**—Time elapsed, in milliseconds, since the last DDB update was received by this card
  - **DDB UPD**—Total DDB updates received on the card
  - **ADDN'L STATUS**—Display more information for the card, including WWA updates or whether card is considered for audit calculations
  - **CAUSE**—Display the reason for sending replies of type "reply with no data " or "DDB update in progress". This value can be DDL (crossload not completed), DDB (dynamic database is not initialised) , (TSRC, DDB) (TSRC task is not completed) or DDB (checksums still needs to apply on tables).



- **?**—Card status is not evaluated (inconsistent/consistent) if the system status is marked as "ABORTED"
- **IGNORED**—Card responded with "DDB update in progress" and is not considered for calculating system status
- **WWA UPD**—Number of entries that were updated by the WWA

**blk-slk****Block Signaling Link**

Use this command to force a local processor outage (LPO) on the specified link. The system begins sending link status signal units (LSSU) with status of processor outage (SIPO) to the adjacent signaling point.



**CAUTION:** Maintenance personnel should use this command only to block MSUs from being sent to the system. Level 2 status remains in service, except when the link is an ATM high-speed signaling link.

**NOTE:** The signaling link's blocked status is not preserved across a card reboot.

**Keyword:** blk-slk

**Related Commands:** blk-slk, canc-lpo, rept-stat-slk, ublk-slk

**Command Class:** Link Maintenance

**Parameters**

**:link=** (mandatory)

This parameter specifies the signaling link defined on the card specified in the **loc** parameter. The links can be specified in any sequence or pattern.

**Synonym:** port

**Range:** a, b, a1-a31, b1-b31

Not all card types support all **link** parameter values.

See Table A-1 for valid **link** parameter range values for each type of card that can have a location specified in the **loc** parameter.

**:loc=** (mandatory)

Location. This parameter specifies the card location as stenciled on the shelf of the system.

**Range:** 1101-1108, 1111-1112, 1201-1208, 1211-1218, 1301-1308, 1311-1318, 2101-2108, 2111-2118, 2201-2208, 2211-2218, 2301-2308, 2311-2318, 3101-3108, 3111-3118, 3201-3208, 3211-3218, 3301-3308, 3311-3318, 4101-4108, 4111-4118, 4201-4208, 4211-4218, 4301-4308, 4311-4318, 5101-5108, 5111-5118, 5201-5208, 5211-5218, 5301-5308, 5311-5318, 6101-6108, 6111-6118

**Example**

```
blk-slk:loc=2311:link=a
```

```
blk-slk:loc=2312:link=a
```

**Dependencies**

A card location that is valid and defined in the database must be specified.

No other action command can be in progress when this command is entered.

The card must contain signaling links.

The signaling link must be equipped in the database.

The following **link** parameter values can be specified for the following cards that support more than 2 links per card:

- **a1-a3, b1-b3**—Multi-port LIM (MPL) or SSEDCCM card running the **iplim** or **iplimi** application with links having **ipliml2=m2pa**, E1/T1 MIM card
- **a1-a31, b1-b31**—HC-MIM card
- **a1-a15, b1-b15**—E5-E1T1 card
- **a1-a7, b1-b7**—E5-ENET card running the **iplim** or **iplimi** application that supports 16 links.
- **a1-a15, b1-b15**—E5-ENET card running the **ipsg** application

The card that contains the specified signaling link must be equipped in the specified card location. The card in the specified card location cannot be a TDM card, an MDAL card, an HMUX or HIPR card, or the cards running the OAM application.

If the card in the specified card location is an SSEDCCM card running the **iplim** application, the specified link must have an **ipliml2** parameter value of **m2pa** (see the **ent-slk** command).

This command is not valid for links belonging to proxy linksets.

This command is not valid for SSEDCCM cards or E5-ENET cards with SS7IPGW or IPGWI TCP/IP links.

## Notes

The function of this command is the same as the **act-lpo** command.

This command generates a minor alarm. Refer to the *Maintenance Manual* for information on MRNs 0201 and 0208.

If the **blk-slk** command is followed by the **init-card** command, the signaling link blockage is not preserved after the **init-card** command completes.

The *Installation Manual - EAGLE 5 ISS* provides an illustration of card locations.

If the **blk-slk** or **act-lpo** command is issued for an IPSG signaling link, then one of the following events occurs:

- IPGS-M2PA signaling link—MTP3 local processor outage is initiated.
- IPGS-M3UA signaling link—The link is prohibited from entering service by rejecting received AS-ACTIVE messages.

**Output**

```

blk-slk:loc=2311:link=a
  tekelecstp 05-01-21 17:00:36 EST  EAGLE5 33.0.0
  Local processor outage being set.
;

```

In the following example, no signaling link has been defined for link a.

```

blk-slk:loc=2312:link=a
  tekelecstp 05-01-21 17:00:36 EST  EAGLE5 33.0.0
  Link is UNEQUIPPED in the database.
  Local processor outage being set.
;

```

In the following example, slot 55 in the card location is not valid.

```

blk-slk:loc=2355:link=a
  tekelecstp 05-01-21 17:00:36 EST  EAGLE5 33.0.0
  Command Rejected: Slot ID out of range
;

```

**canc-alm-trns****Cancel Alarm Transfer**

Use this command to return all audible alarm indications to the local office.

**Keyword:** **canc-alm-trns**

**Related Commands:** **act-alm-trns**, **dact-alm-trns**, **rept-stat-cdt**, **rept-stat-clk**, **rept-stat-trbl**, **rls-alm**, **rtrv-obit**, **rtrv-trbl**

**Command Class:** System Maintenance

**Parameters**

This command has no parameters.

**Example**

```

canc-alm-trns

```

**Dependencies**

No other action commands can be in progress when this command is entered.

**Notes**

No other action command can be in progress when this command is entered.

The function of this command is the same as the **dact-alm-trns** command.

After the **canc-alm-trns** command is entered, the **rept-stat-alm** command can be entered to verify the status of the alarms.

**Output**

```

canc-alm-trns
  rlghncxa03w 04-01-07 11:11:28 EST  EAGLE 31.3.0
  Alarms returned to Local Maintenance Center
  Command Completed.
;

```

**canc-cmd****Cancel Command**

This command halts processing and output of the commands listed in Table 5-4.

**Table 5-4.** Commands for which **canc-cmd** Halts Processing and Output

Commands		
<b>rept-imt-info</b>	<b>rtrv-as</b>	<b>rtrv-obit</b> (active OAM)
<b>rept-stat-applsock</b>	<b>rtrv-assoc</b>	<b>rtrv-rte</b>
<b>rept-stat-as</b>	<b>rtrv-cmd</b>	<b>rtrv-seculog</b>
<b>rept-stat-assoc</b>	<b>rtrv-dcmps</b>	<b>rtrv-secu-user</b>
<b>rept-stat-card</b>	<b>rtrv-dstn</b>	<b>rtrv-slk</b>
<b>rept-stat-clk</b>	<b>rtrv-gta</b>	<b>rtrv-tbl-capacity</b>
<b>rept-stat-dstn</b>	<b>rtrv-gtt</b>	<b>rtrv-trbltx</b>
<b>rept-stat-ls</b>	<b>rtrv-lbp</b>	<b>rtrv-uaps</b>
<b>rept-stat-rte</b>	<b>rtrv-log</b>	<b>rtrv-vflx-cd</b>
<b>rept-stat-slk</b>	<b>rtrv-ls</b>	<b>rtrv-vflx-rn</b>
<b>rept-stat-trbl</b>	<b>rtrv-map</b>	<b>rtrv-vflx-vmsid</b>
<b>rtrv-appl-rtkey</b>	<b>rtrv-mrn</b>	

When using the **canc-cmd** command without the **trm** parameter, enter the command on the same terminal that is currently running the command you want to cancel.

When using the **canc-cmd** command with the **trm** parameter, enter the command on a terminal other than the one that is currently running the command you want to cancel.

**NOTE:** The Basic command class allows use of this command without the **trm** parameter (**dact-cmd**); the Security Administration command class is required for use of this command when the **trm** parameter is specified (**dact-cmd:trm=x**).

**Keyword:** **canc-cmd**

**Related Commands:** **rept-imt-info**,, **rept-stat-assoc**, **rept-stat-card**, **rept-stat-dstn**, **rept-stat-ls**, **rept-stat-rte**, **rept-stat-slk**, **rtrv-appl-rtkey**,, **rtrv-assoc**,, **rtrv-dstn**, **rtrv-gta**, **rtrv-gtt**, **rtrv-log**, **rtrv-ls**, **rtrv-map**,, **rtrv-rte**, **rtrv-seculog**, **rtrv-slk**, **rtrv-trbltx**, **rtrv-uaps**, **rtrv-vflx-cd**, **rtrv-vflx-rn**, **rtrv-vflx-vmsid**

**Command Class:** Security Administration

### Parameters

**:trm=** (optional)

The terminal on which the command is to be canceled.

**Range:** 1-40

### Example

```
canc-cmd
```

```
canc-cmd:trm=3
```

### Dependencies

The **trm** parameter cannot be specified in a **canc-cmd** command that is entered on the same terminal that is running the command that is to be cancelled. The terminal will return an error: system is busy.

The **canc-cmd:trm=** command requires the Security Administration command class for the terminal and for the user.

The **canc-cmd:trm** command requires a Security Administration command class for the terminal.

## Notes

The **canc-cmd** command (without the **trm** parameter) must be entered on the same terminal that is running the command to be cancelled.

If the **canc-cmd** command is entered on a terminal that is not running a command, the **canc-cmd** command completes successfully without returning an error. Likewise, if the **canc-cmd:trm=** command is entered and there is no command running on the specified terminal, the **canc-cmd:trm=** command completes successfully without returning an error.

When the **canc-cmd** with no parameter is entered, a scroll area message appears to indicate that the command has been cancelled. For example:

```
Command aborted on terminal 2.
```

Some output can still appear after the above abort message if output accumulated in the output queue before the **canc-cmd** command was entered. When a command is cancelled, the cancellation should take no longer than 25 seconds to take effect.

The **F9** function key provides the same function as the **canc-cmd** command (without the **trm** parameter). On a terminal in KSR mode, pressing **<CTRL>I** also provides the same function.

The **canc-cmd** and the **F9** function key cannot be used for pure SEAS commands.

If **canc-cmd** is entered to cancel a command other than ones listed in Table 5-4, the terminal will accept another command, but output and processing of the current command continue.

When **canc-cmd** is entered, a command status code of **AB** (command aborted) is logged in the security log as follows:

- When the **canc-cmd** (without the **trm** parameter) is entered, no entry is logged.
- When the **canc-cmd:trm=** command is entered, an entry is logged.
- When the **canc-cmd** command (without the **trm** parameter) is entered as a SEAS flow-thru command, an entry is logged. The **canc-cmd:trm=** command is not allowed as a SEAS flow-thru command because the **canc-cmd:trm=** command belongs to the Security Administration Command Class.

For examples of the security log entries, see the **rtrv-seculog** command.

## Output

### **canc-cmd**

```
rlghncxa03w 04-07-27 17:00:36 EST EAGLE 31.6.0
canc-cmd
Command entered at terminal #2.
```

```
rlghncxa03w 04-07-27 17:00:36 EST EAGLE 31.6.0
Command aborted on terminal 2.
```

```
;
```

### **canc-cmd:trm=2**

```
rlghncxa03w 04-07-27 17:00:36 EST EAGLE 31.6.0
canc-cmd:trm=2
Command entered at terminal #3.
```

```
rlghncxa03w 04-07-27 17:00:36 EST EAGLE 31.6.0
Command aborted on terminal 2.
```

```
;
```

**canc-dlk****Cancel Data Link**

Use this command to remove a TCP/IP data link from service. The state of the TCP/IP data link is changed from in service normal (IS-NR) to out of service maintenance disabled (OOS-MT-DSBLD).

**Keyword:** **canc-dlk**

**Related Commands:** **act-dlk, dlt-dlk, ent-dlk, rept-stat-dlk, rtrv-dlk, tst-dlk**

**Command Class:** Link Maintenance

**Parameters**

**:loc=** (mandatory)

The card location as stenciled on the shelf of the system.

**Range:** **1101-1108, 1111-1112, 1201-1208, 1211-1218, 1301-1308, 1311-1318, 2101-2108, 2111-2118, 2201-2208, 2211-2218, 2301-2308, 2311-2318, 3101-3108, 3111-3118, 3201-3208, 3211-3218, 3301-3308, 3311-3318, 4101-4108, 4111-4118, 4201-4208, 4211-4218, 4301-4308, 4311-4318, 5101-5108, 5111-5118, 5201-5208, 5211-5218, 5301-5308, 5311-5318, 6101-6108, 6111-6118**

**Example**

```
canc-dlk:loc=1308
```

**Dependencies**

No other action command can be in progress when this command is entered.

The shelf and card must be equipped.

The card location must contain a STPLAN card.

The card location, frame, shelf, or slot must be within the allowed range.

The signaling link must be equipped in the database.

A card location that is valid and defined in the database must be specified.

**Notes**

None

**Output**

```
canc-dlk:loc=1308
```

```
rlghncxa03w 04-01-27 17:00:36 EST EAGLE 31.3.0
```

```
Deactivate Link message sent to card.
```

```
Command Completed.
```

```
;
```

**canc-echo****Cancel Echo**

Use this command to halt the echoing of command responses from the user's terminal to other terminals or printers.

**Keyword:** **canc-echo**

**Related Commands:** **act-echo, alw-trm, chg-trm, dact-echo, inh-trm, rept-stat-trm, rmv-trm, rst-trm, rtrv-trm**

**Command Class:** Basic

**Parameters**

**:trm=** (optional)

The ID number of the terminal for which the echo is being canceled.

**Range:** 1-16  
**Default:** Cancels all active echoes

### Example

```
canc-echo
canc-echo:trm=7
```

### Dependencies

The echo cannot be cancelled to the same terminal from which the **canc-echo** command is entered.  
 An **act-echo** command must be active at the specified terminal before this command can be entered to cancel the echo.

### Notes

Only the echoing of command output responses can be halted by this command. To halt the printing of alarm and network messages, the **chg-trm** command must be used.

### Output

```
canc-echo
rlghncxa03w 04-01-07 11:11:28 EST EAGLE 31.3.0
canc-echo
Command entered at terminal #6.
Scroll Area Output echo disabled to all terminals.
;

canc-echo:trm=7
rlghncxa03w 04-01-07 11:11:28 EST EAGLE 31.3.0
canc-echo:trm=7
Command entered at terminal #6
Scroll Area Output echo disabled for terminal 7.
;
```

## canc-lpo

### Cancel Local Processor Outage

Use this command to cancel a processor outage and restore the link to its previous state. LSSUs with status of processor outage are terminated, and the link begins sending MSUs.

**NOTE: The signaling link's blocked status is not preserved across a card reboot.**

**Keyword:** **canc-lpo**  
**Related Commands:** **act-lpo, blk-slk, ublk-slk**  
**Command Class:** Link Maintenance

### Parameters

**:link=** (mandatory)

The signaling link defined on the card specified in the **loc** parameter. The links can be specified in any sequence or pattern.

**Synonym:** **port**

**Range:** **a, b, a1-a31, b1-b31**

Not all card types support all **link** parameter values.

See Table A-1 for valid **link** parameter range values for each type of card that can have a location specified in the **loc** parameter.

**:loc=** (mandatory)

The address of the card containing the signaling link to be unblocked.

**Range:** **1101-1108, 1111-1112, 1201-1208, 1211-1218, 1301-1308, 1311-1318, 2101-2108, 2111-2118, 2201-2208, 2211-2218, 2301-2308, 2311-2318, 3101-3108, 3111-3118,**

3201-3208, 3211-3218, 3301-3308, 3311-3318, 4101-4108, 4111-4118, 4201-4208, 4211-4218, 4301-4308, 4311-4318, 5101-5108, 5111-5118, 5201-5208, 5211-5218, 5301-5308, 5311-5318, 6101-6108, 6111-6118

### Example

```
canc-lpo:loc=2311:link=b
```

### Dependencies

A card location must be specified that is valid and defined in the database.

No other action command can be in progress when this command is entered.

The card must be equipped and must be one of the following cards:

- A LIM card running the **ss7ansi**, **atmansi**, or **ccs7itu** application
- An E1-ATM card running the **atmitu** application
- An SSEDCCM or E5-ENET card running the **iplim** or **iplimi** application with links having **ipliml2=m2pa**
- An E1/T1 MIM card or an HC-MIM card running the **ss7ansi** or **ccs7itu** application
- An E5-ENET card running the **ipsg** application

This command cannot be entered for IPLIMx signaling links that have an **ipliml2** parameter setting that is not **m2pa**.

This command is not valid for SSEDCCM cards or E5-ENET cards with SS7IPGW or IPGWI TCP/IP links.

The card must contain signaling links.

The signaling link must be equipped in the database.

The **link** parameter values **a1**, **b1**, **a2**, **b2**, **a3**, and **b3** can be specified only for the following cards:

- A multi-port LIM
- An E1/T1 MIM or an HC MIM

This command is not valid for links belonging to proxy linksets.

### Notes

The function of this command is the same as the **ublk-slk** command.

Unblocking a signaling link removes a Level 2 failure resulting from a **blk-slk** of an ATM high-speed signaling link.

The *Installation Manual - EAGLE 5 ISS* provides an illustration of card locations.



**Output**

```
canc-lpo:loc=2311:link=a
```

```
tekelecstp 05-01-21 17:00:36 EST EAGLE5 33.0.0
Local processor outage being cleared.
```

```
;
```

In the following example, card location 1113 is not valid:

```
canc-lpo:loc=1113:link=a
```

```
tekelecstp 05-01-21 17:00:36 EST EAGLE5 33.0.0
Command Rejected : Location is not valid for command
```

```
;
```

**canc-slk****Cancel Signaling Link**

Use this command to change the state of the specified link to OOS-MT-DSBLD (Out-Of-Service Maintenance Disabled).



**CAUTION:** This command impacts network performance and should be used only during periods of low traffic.

**Keyword:** `canc-slk`

**Related Commands:** `act-slk`, `alw-slk`, `blk-slk`, `dact-slk`, `dlt-slk`, `ent-slk`, `inh-slk`, `rept-stat-slk`, `rtrv-slk`, `tst-slk`, `ublk-slk`, `unhb-slk`

**Command Class:** Link Maintenance

**Parameters**

**:link=** (mandatory)

Signaling link defined on the card specified in the `loc` parameter. The links can be specified in any sequence or pattern.

**Synonym:** `port`

**Range:** `a, b, a1-a31, b1-b31`

Not all card types support all `link` parameter values.

See Table A-1 for valid `link` parameter range values for each type of card that can have a location specified in the `loc` parameter.

**:loc=** (mandatory)

The card location as stenciled on the shelf of the system.

**Range:** `1101-1108, 1111-1112, 1201-1208, 1211-1218, 1301-1308, 1311-1318, 2101-2108, 2111-2118, 2201-2208, 2211-2218, 2301-2308, 2311-2318, 3101-3108, 3111-3118, 3201-3208, 3211-3218, 3301-3308, 3311-3318, 4101-4108, 4111-4118, 4201-4208, 4211-4218, 4301-4308, 4311-4318, 5101-5108, 5111-5118, 5201-5208, 5211-5218, 5301-5308, 5311-5318, 6101-6108, 6111-6118`

**Example**

```
canc-slk:loc=1301:link=a
```

**Dependencies**

A card location must be specified that is valid and defined in the database.

No other action command can be in progress when this command is entered.

The card must contain signaling links.

The signaling link must be equipped in the database.

The following **link** parameter values can be specified for the following cards that support more than 2 links per card:

- **a1-a3, b1-b3**—Multi-port LIM (MPL) or SSEDCCM card running the **iplim** or **iplimi** application with links having **ipliml2=m2pa**, E1/T1 MIM card
- **a1-a31, b1-b31**—HC-MIM card
- **a1-a15, b1-b15**—E5-E1T1 card
- **a1-a7, b1-b7**—E5-ENET card running the **iplim** or **iplimi** application that supports 16 links
- **a1-a15, b1-b15**—E5-ENET card running the **ipsg** application

The card that contains the specified signaling link must be equipped in the specified card location. The card in the specified card location cannot be a TDM card, an MDAL card, an HMUX or HIPR card, or the cards running the OAM application.

### Notes

Not every card location represents a signaling link. Be sure to address a signaling link in this command.

The *Installation Manual - EAGLE 5 ISS* provides an illustration of card locations.

After the **canc-slk** command is entered, the **rept-stat-slk** command can be entered to verify the cancellation.

### Output

```
canc-slk:loc=1301:link=a
rlghncxa03w 05-02-07 11:11:28 EST EAGLE5 33.0.0
Deactivate Link message sent to card
;
```

### canc-user

### Cancel User

Use this command to end a user session. The **dact-echo** or **logout** command has the same affect as the **canc-user** command.

**Keyword:** **canc-user**

**Related Commands:** **act-user, chg-pid, chg-user, dact-user, dlt-user, ent-user, login, logout, rept-stat-user, rtrv-secu-user, rtrv-user**

**Command Class:** Basic

### Parameters

This command has no parameters.

### Example

```
canc-user
```

### Dependencies

None

### Notes

The **dact-echo** or **logout** commands can be used in place of **canc-user**.

### Output

Not applicable.

**chg-acg-mic****Change ACG Manually Initiated Control**

Use this command to change the values of ACG controls assigned to certain queries. The control can apply to all queries or to specific query services and called party digits. A particular control is selected to be changed by either specifying that it is the **type=all** control or specifying its service and digits.

**Keyword:** **chg-acg-mic**

**Related Commands:** **dlt-acg-mic**, **ent-acg-mic**, **rept-stat-lnp**, **rtrv-acg-mic**

**Command Class:** Database Administration

**Parameters**

**:aintvl=** (optional)

AIN interval index

**Range:** **1-15**

**Default:** The current value

**:dgts=** (optional)

Digits

**Range:** **000-999, 000000-9999999999**

Specify 3 digits or 6-10 digits.

**:drtn=** (optional)

Duration index. The amount of time that the ACG is in effect. This number is mapped to a time value at the LNP node. Refer to the chapter on Automatic Call Gapping (AGC) configuration in the *LNP Feature Activation Guide* for a description of the use of the duration index.

**Range:** **1-13**

**Default:** The current value

**:intvl=** (optional)

Interval index. The amount of time between ACGs. This number is mapped to a time value for the LNP node. Refer to the chapter on Automatic Call Gapping configuration in the *LNP Feature Activation Guide* for a description of the use of the gap interval index.

**Range:** **0-15**

**Default:** Current value

**:nd=** (optional)

New number of digits

**Range:** **3, 6-10**

**Default:** The current value

**:serv=** (optional)

Query service

**Range:** **ain, in**

**:type=** (optional)

Type of control

**Range:** **all, sd**

**Default:** **sd**

**Example**

To change the type=all MIC to use 3 digits:

```
chg-acg-mic:type=all:nd=3
```

To change the MIC for AIN queries for 919-460-2132 to use an interval index of 15:

```
chg-acg-mic:serv=ain:dgts=9194602132:aintvl=15
```

To change the MIC for IN queries for 919-xxx-xxxx to use a duration index of 9 and an interval index of 5:

```
chg-acg-mic:serv=in:dgts=919:drtn=9:intvl=5
```

### Dependencies

If the **type=all** parameter is specified, at least one optional parameter (**nd**, **drtn**, **intvl**, or **aintvl**) must be specified.

If the **type=all** parameter is specified, optional parameters **serv** and **dgts** cannot be specified.

If the **type=sd** parameter is specified, optional parameters **serv** and **dgts** must be specified.

If the **type=sd** parameter is specified, optional parameter **nd** cannot be specified.

If the **serv=ain** parameter is specified, at least one optional parameter (**drtn** or **aintvl**) must be specified.

If the **serv=ain** parameter is specified, optional parameter **intvl** cannot be specified.

If the **serv=in** parameter is specified, at least one optional parameter (**drtn** or **intvl**) must be specified.

If the **serv=in** parameter is specified, optional parameter **aintvl** cannot be specified.

The **dgts** parameter value must be either 3 digits in the range **000-999** or 6-10 digits in the range **000000-9999999999**.

The **nd** parameter value must be **3** or **6-10** to indicate the number of new digits.

The LNP feature must be turned on (see the **enable-ctrl-feat** command) before this command can be entered.

If the **type=all** parameter is specified, a MIC with **type=all** must exist.

If the **type=sd** parameter is specified, a MIC with the same service and digits must exist.

### Notes

None

### Output

```
chg-acg-mic:type=all:nd=31
rlghncxa03w 04-01-28 08:50:12 EST EAGLE 31.3.0
ACG MIC table is (11 of 256) 4% full of type SD
CHG-ACG-MIC: MASP A - COMPLTD
;
```

## chg-acg-noc

## Change ACG Node Overload Control

Use this command to change the definition of a node overload level. The definition is comprised of the threshold LNP query rates for node overload levels and the values for the automatic call gappings (ACG) to be sent when at the specified level.

**Keyword:** **chg-acg-noc**

**Related Commands:** **dlt-acg-noc**, **ent-acg-noc**, **rept-stat-lnp**, **rtrv-acg-noc**

**Command Class:** Database Administration

### Parameters

**:lvl=** (mandatory)  
Overload level.

**Range:** **1-10**

**:and=** (optional)  
AIN number of digits. The number of digits in the global title address of an AIN query.

**Range:** 6, 10  
**Default:** The current value

**:drtn=** (optional)

Duration index. The amount of time that the ACG is in effect. This number is mapped to a time value at the LNP node. Refer to the chapter on Automatic Call Gapping (ACG) configuration in the *LNP Feature Activation Guide* for a description of the use of the duration index.

**Range:** 1-13  
**Default:** The current value

**:ind=** (optional)

IN number of digits. The number of digits in the global title address of an IN query.

**Range:** 6, 10  
**Default:** The current value

**:intvl=** (optional)

Interval index. The amount of time between ACGs. This number is mapped to a time value for the LNP node. Refer to the chapter on Automatic Call Gapping configuration in the *LNP Feature Activation Guide* for a description of the use of the gap interval index.

**Range:** 0-15  
**Default:** The current value

**:qr=** (optional)

Query rate. The number of LNP queries, which define a particular overload level, in a 30-second period.

**Range:** 1-2147483647  
**Default:** The current value

### Example

To change level 10's query rate and AIN number of digits:

```
chg-acg-noc:lvl=10:qr=900000:and=6
```

To change level 3's duration and interval indexes:

```
chg-acg-noc:lvl=3:drtn=7:intvl=3
```

### Dependencies

At least one optional parameter must be specified.

The **and** parameter value must be either **6** or **10**.

The specified overload level must be defined.

The LNP feature must be turned on (see the **enable-ctrl-feat** command) before this command can be entered.

The **ind** parameter value must be either **6** or **10**.

### Notes

None

### Output

```
chg-acg-noc:lvl=10:qr=900000:and=6
rlghncxa03w 03-02-28 08:50:12 EST EAGLE 28.1.0
CHG-ACG-NOC: MASP A - COMPLTD
;
```

**chg-ainpopts****Change AINP Options Command**

Use this command to provision AINPQ-specific data. This command updates the AINPOPTS table.

**Keyword:** **chg-ainpopts**

**Related Commands:** **rtrv-ainpopts**

**Command Class:** Database Administration

**Parameters**

**:defrn=** (optional)

Default routing number. This parameter specifies a default routing number that is used for own-network subscribers.

**Range:** 1-15 digits, **none**

**Default:** No change to the current value

**System**

**Default:** **none**

**:dialnai=** (optional)

Digits dialed nature of address indicator.

**Range:** **0, 1**

**0**— National

**1**— International

**Default:** No change to the current value

**System**

**Default:** **0**

**:dialpfx=** (optional)

Dialed party number prefix.

**Range:** 1-15 digits

Valid digits are **0-9, A-F, a-f**.

**Default:** No change to the current value

**System**

**Default:** **none**

**:dltpfx=** (optional)

Delete prefix. This parameter specifies whether to delete the **dialpfx**.

**Range:** **yes, no**

**Default:** No change to the current value

**System**

**Default:** **no**

**:ndialpfx=** (optional)

New dialed party number prefix.

**Range:** 1-15 digits, **none**

Valid digits are **0-9, a-f, A-F**.

**System**

**Default:** **none**

**:nec=** (optional)

National Escape Code.

**Range:** 1-5 digits, **none**

Valid digits are **0-9, A-F, a-f**.

**Default:** No change to the current value

**System**

**Default:** **none**

**:rfmt=** (optional)

Routing address format

**Range:** **rndn, rn, ccrndn, rnnecd, homerndn, rnasd, asdrn, rnasddn, asdrndn, ccrnasddn, asdrnccd, ccasdrndn, rnasdccd, rnasdnecd, asdrnnecd, rngrn, grnrn, rngrndn, grnrndn, ccrngrndn, ccgrnrndn, grnrnccd, rngrnccd, rngrnnecd, grnrnnecd**

**rndn**— Supports RN + [DIALPFX] + DN in the AINPQ "Return Result" response messages

**rn**— Supports Routing Number in the AINPQ "Return Result" response messages.

**ccrndn**— Supports [DIALPFX] +CC + RN + DN in the AINPQ "Return Result" response messages.

**rnnecd**— Supports RN+ [DIALPFX]+ NEC+ DN in the AINPQ "Return Result" response messages.

**homerndn**— Supports Home Routing Number in the AINPQ "Return Result" response messages.

**rnasd**— Supports RN+ ASD in the AINPQ "Return Result" response messages.

**asdrn**— Supports ASD+RN in the AINPQ "Return Result" response messages.

**rnasddn**— Supports RN +ASD+ [DIALPFX] + DN in the AINPQ "Return Result" response messages.

**asdrndn**— Supports ASD+ RN + [DIALPFX] + DN in the AINPQ "Return Result" response messages.

**ccrnasddn**— Supports [DIALPFX] +CC + RN + ASD+DN in the AINPQ "Return Result" response messages.

**asdrnccd**— Supports ASD+ RN+ [DIALPFX]+ CC+ DN in the AINPQ "Return Result" response messages.

**ccasdrndn**— Supports [DIALPFX] +CC + ASD + RN+DN in the AINPQ "Return Result" response messages.

**rnasdccd**— Supports RN + ASD + [DIALPFX] +CC + DN in the AINPQ "Return Result" response messages.

**rnasdnecd**— Supports RN+ ASD + [DIALPFX]+ NEC+ DN in the AINPQ "Return Result" response messages.

**asdrnnecd**— Supports ASD + RN+ [DIALPFX]+ NEC+ DN in the AINPQ "Return Result" response messages.

**rngrn**— Supports RN + GRN in the AINPQ "Return Result" response messages.

**grnrn**— Supports GRN + RN in the AINPQ "Return Result" response messages.

**rngrndn**— Supports RN + GRN + [DIALPFX] + DN in the AINPQ "Return Result" response messages.

**grnrndn**— Supports GRN + RN + [DIALPFX] + DN in the AINPQ "Return Result" response messages.

**ccrngrndn**— Supports [DIALPFX] + CC + RN + GRN + DN in the AINPQ "Return Result" response messages.

**ccgrnrndn**— Supports [DIALPFX] + CC + GRN + RN + DN in the AINPQ "Return Result" response messages.

**grnrnccd**— Supports GRN + RN+ [DIALPFX] + CC + DN in the AINPQ "Return Result" response messages.

**rngrnccd**— Supports RN + GRN + [DIALPFX] + CC + DN in the AINPQ "Return Result" response messages.

**rngrnnecd**— Supports RN + GRN + [DIALPFX] + NEC + DN in the AINPQ "Return Result" response messages.

**grnrnnecd**— Supports GRN + RN + [DIALPFX] + NEC + DN in the AINPQ "Return Result" response messages.

**Default:** No change to the current value

**System****Default:** rrdn**:rnaiv=** (optional)

Routing nature of address indicator

**Range:** natl, intl, frmsg**natl** — National significant number**intl** — International number**frmsg** — NAI from the incoming message

**NOTE: The nature of address indicator parameters (rnaiv or rnaiv) can be specified by supplying either a mnemonic or an explicit value. At no time may both the mnemonic and the explicit value be specified at the same time for the these parameters.**

**Default:** No change to the current value**System****Default:** frmsg**:rnaiv=** (optional)

Routing nature of address indicator value

**Range:** 0, 1**0** — National**1** — International**Default:** No change to the current value**System****Default:** none**:rnp=** (optional)

Routing numbering plan

**Range:** unknown, e164, e212, priv**unknown** — IS41 Numbering Plan Unknown**e164** — IS41 Telephony Number**e212** — IS41 Land Mobile Number**priv** — IS41 Private Number**Default:** No change to the current value**System****Default:** e164**:rnpv=** (optional)

Routing numbering plan value

**Range:** 0-15**Default:** No change to the current value**System****Default:** 2**:snai=** (optional)

Service Nature of Address indicator.

**Range:** sub, natl, intl, unknown, none**sub** — Subscriber Number**natl** — National Significant Number**intl** — International Number**unknown** — Unknown NAI value**none** — NAI value none**Default:** No change to the current value**System****Default:** none



**:sporttype=** (optional)

Service Portability type. This parameter specifies whether Service Portability is performed for the associated feature.

The S-Port feature must be enabled before this parameter can be specified. The S-Port feature must be turned on before any change to the parameter will impact the associated feature.

**Range:** **gsm, is41, all, none**

**gsm** — Apply Service Portability prefix (RTDB 'GRN' entity id ) for own-network GSM subscribers.

**is41** — Apply Service Portability prefix (RTDB 'GRN' entity id) for own-network IS41 subscribers.

**all** — Apply Service Portability prefix (RTDB 'GRN' entity id) for all own-network (IS41 and GSM) subscribers.

**none** — Service Portability is not performed for the feature.

**Default:** No change to the current value

**System**

**Default:** **none**

**:sprestype=** (optional)

SP response type. This parameter specifies the type of message that is sent by the system if an NPREQ message is received, the DN digits match, and the HLR ID is present.

**Range:** **rrwdgts, rrwodgts**

**rrwdgts** — The system sends a "Return Results with Digits" message.

**rrwodgts** — The system sends a "Return Results without Digits" message.

**Default:** No change to the current value

**System**

**Default:** **rrwdgts**

**Example**

```
chg-ainpopts:rfmt=rn:rnp=e164:rnai=intl:dialpfx=fac:dltprfx=yes
chg-
ainpopts:rfmt=rndn:rnp=e212:rnai=intl:dialpfx=fac:dltprfx=no :dialn
ai=1:snai=natl
chg-
ainpopts:rfmt=rngrnccdn:rnp=e164:rnai=intl:dialpfx=fac:dltprfx=yes
chg-ainpopts:sprestype=rrwdgts:rfmt=rnnecdn:nec=abcd1
chg-ainpopts:rfmt=rnnecdn:nec=abcd1
chg-ainpopts:rfmt=rnnecdn:nec=0
chg-
ainpopts:rfmt=asdrnccdn:rnp=e164:rnai=intl:dialpfx=fac:dltprfx=yes
```

**Dependencies**

At least one optional parameter must be specified.

The **rnp** and **rnpv** parameters cannot be specified together in the command.

The **rnai** and **rnaiv** parameters cannot be specified together in the command.

If the **ndialpfx** or **dltprfx** parameter is specified, then the **dialpfx** parameter must be specified.

The **dialpfx=none** parameter cannot be specified.

If the **ndialpfx=none** parameter is specified, then the **dltprfx** parameter cannot be specified.

If the **ndialpfx** and **dialpfx** parameters are specified, then the value specified for the **dialpfx** parameter must already exist in the AINPOPTS table.

The value specified for the **ndialpfx** parameter cannot already exist in the AINPOPTS table.

A maximum of 2 Dialed Party Number Nature of Address values are allowed.

The **dialnai** and **snai** parameters must be specified together in the command.

If the **snai=none** parameter is specified, then the value specified for the **dialnai** parameter must already exist in the AINPOPTS table.

A maximum of 40 Dialed Party Number Prefix values can be provisioned.

If the **nec=none** parameter is specified, then values of **asdrnecdn**, **rnsdnecdn**, **rnecdn**, **rngrnecdn**, and **grnrnecdn** cannot be specified for the **rfmt** parameter.

The S-Port feature must be enabled before the **sporttype** parameter can be specified.

The AINPQ feature must be enabled before this command can be entered.

## Output

```
chg-ainpopts:rfmt=rnsd:nec=0
tekelecstp 09-06-03 15:15:44 EST EAGLE 41.1.0
CHG-AINPOPTS: MASP A - COMPLTD
;
```

## chg-appl-rtkey

### Change Static Routing Key Table Entries

Use this command to change static entries in the Routing Key table. Only one attribute can be changed at a time.

**Keyword:** chg-appl-rtkey

**Related Commands:** dlt-appl-rtkey, ent-appl-rtkey, rtrv-appl-rtkey

**Command Class:** Database Administration

## Parameters

**NOTE:** See "Point Code Formats and Conversion" for a detailed description of point code formats, rules for specification, and examples.

**NOTE:** The following parameters are no longer available: nasname, norm, nsname, pstncat, pstnid

**:cice=** (optional)

The end range of circuit identification codes assigned to the routing key. Specify the **cice** and **cics** parameters to identify the routing key to be changed. The **cice** parameter is mandatory and valid only if the **si** parameter has a value of **4**, **5**, or **13**.

**Range:** 0-4294967295

See Table A-4 for valid CIC values for specified SI and MSU types.

**:cics=** (optional)

The start range of circuit identification codes assigned to the routing key. Specify the **cics** and **cice** parameters to identify the routing key to be changed. The **cics** parameter is mandatory and valid only if the **si** parameter has a value of **4**, **5**, or **13**.

**Range:** 0-4294967295

See Table A-4 for valid CIC values for specified SI and MSU types.

**:dpc=** (optional)

ANSI destination point code with subfields *network indicator-network cluster-network cluster member (ni-nc-ncm)*.

**Synonym:** dpca

**Range:** 000-255

Specify a valid value for each subfield of the point code, and separate the subfields with a dash (-).

When **chg-sid:pctype=ansi** is specified, *ni = 000* is not valid.

When **chg-sid:pctype=ansi** is specified, *nc = 000* is not valid if *ni = 001-005*.

When **chg-sid:pctype=ansi** is specified, *nc = 000* is valid if *ni = 006-255*.

The point code **000-000-000** is not a valid point code.

**:dpc/dpca/dpci/dpcn/dpcn24=** (optional)

Destination point code.

**:dpci=** (optional)

ITU international destination point code with subfields *zone-area-id*. The *prefix* subfield indicates a spare point code (*prefix-zone-area-id*)

**Range:** **s-, 0-255**

Specify a valid value for each subfield of the point code, and separate the subfields with a dash (-).

*prefix*—**s-**

*zone*—**0-7**

*area*—**000-255**

*id*—**0-7**

The point code **0-000-0** is not a valid point code.

**:dpcn=** (optional)

ITU national destination point code in the format of a 5-digit number (*nnnnn*); or 2, 3, or 4 numbers (members) separated by dashes (*m1-m2-m3-m4*) as defined by the **chg-stpopts:npcfmti** flexible point code option. A group code must be specified when the ITUDUPPC feature is turned on (*nnnnn-gc*, *m1-m2-m3-m4-gc*). The *prefix* subfield indicates a spare point code (*prefix-nnnnn*, *prefix-nnnnn-gc*, *prefix-m1-m2-m3-m4*, *prefix-m1-m2-m3-m4-gc*).

**Range:** **s-, 0-16383, aa-zz**

Specify a valid value for each subfield of the point code, and separate the subfields with a dash (-).

*prefix*—**s-**

*nnnnn*—**0-16383**

*gc*—**aa-zz**

*m1-m2-m3-m4*—**0-14** for each member; values must sum to 14

**:dpcn24=** (optional)

24-bit ITU national destination point code with subfields *main signaling area-sub signaling area-signaling point* (*msa-ssa-sp*).

**Range:** **000-255**

Specify a valid value for each subfield of the point code, and separate the subfields with a dash (-).

*msa*—**000-255**

*ssa*—**000-255**

*sp*—**000-255**

**:ncice=** (optional)

The new end range of circuit identification codes assigned to the routing key. Specify the **ncice** and/or **ncics** parameter to change the range of the circuit identification codes assigned to the routing key. The **ncice** parameter is valid only if **si=4, 5, or 13** and is not valid if the **split** parameter is specified.

**Range:** 0-4294967295

See Table A-4 for valid CIC values for specified SI and MSU types.

**:ncics=** (optional)

The new start range of circuit identification codes assigned to the routing key. Specify the **ncics** and/or **ncice** parameter to change the range of the circuit identification codes assigned to the routing key. The **ncics** parameter is valid only if **si=4, 5, or 13** and is not valid with the **split** parameter.

**Range:** 0-4294967295

See Table A-4 for valid CIC values for specified SI and MSU types.

**:nrcontext=** (optional)

This parameter modifies the routing context value assigned to this routing key.

Routing context is mandatory for routing keys associated with SUA Application Servers. Routing context is optional for routing keys associated with M3UA Application Servers.

An AS can be associated with only 1 routing key with routing context. An AS can be associated with multiple routing keys that do not contain routing context. An AS cannot be simultaneously assigned to a routing key with routing contexts and to routing keys without routing contexts.

**Range:** 0-4294967295

**:opc=** (optional)

ANSI originating point code with subfields *network indicator-network cluster-network cluster member (ni-nc-ncm)*.

**Synonym:** opca

**Range:** 000-255

Specify a valid value for each subfield of the point code, and separate the subfields with a dash (-).

When **chg-sid:pctype=ansi** is specified, **ni = 000** is not valid.

When **chg-sid:pctype=ansi** is specified, **nc = 000** is not valid if **ni = 001-005**.

When **chg-sid:pctype=ansi** is specified, **nc = 000** is valid if **ni = 006-255**.

The point code **000-000-000** is not a valid point code.

**:opc/opca/opci/opcn/opcn24=** (optional)

Originating point code. Valid only if **si=4, 5, or 13** and required if **si=4, 5, or 13**.

**:opci=** (optional)

ITU international originating point code with subfields *zone-area-id*. The *prefix* subfield indicates a spare point code (*prefix-zone-area-id*)

**Range:** s-, 0-255

Specify a valid value for each subfield of the point code, and separate the subfields with a dash (-).

*prefix*—s-

*zone*—0-7

*area*—000-255

*id*—0-7

The point code **0-000-0** is not a valid point code.

**:open=** (optional)

ITU national originating point code in the format of a 5-digit number (*nnnnn*); or 2, 3, or 4 numbers (members) separated by dashes (*m1-m2-m3-m4*) as defined by the **chg-stpopts:npfnti** flexible point code option. A group code must be specified when the ITUDUPPC feature is turned on (*nnnnn-gc*, *m1-m2-m3-m4-gc*). The *prefix* subfield indicates a spare point code (*prefix-nnnnn*, *prefix-nnnnn-gc*, *prefix-m1-m2-m3-m4*, *prefix-m1-m2-m3-m4-gc*).

**Range:** **s-, 0-16383, aa-zz**

Specify a valid value for each subfield of the point code, and separate the subfields with a dash (-).

*prefix*—s-

*nnnnn*—**0-16383**

*gc*—**aa-zz**

*m1-m2-m3-m4*—**0-14** for each member; values must sum to 14

**:open24=** (optional)

24-bit ITU national originating point code with subfields *main signaling area-sub signaling area-signaling point* (*msa-ssa-sp*).

**Range:** **000-255**

Specify a valid value for each subfield of the point code, and separate the subfields with a dash (-).

*msa*—**000-255**

*ssa*—**000-255**

*sp*—**000-255**

**:rcontext=** (optional)

This parameter specifies a routing key by its routing context when a routing key needs to be changed as an optional alternative to entering the **dpc/si/ssn/opc/cics/cice/type** parameters.

The **split** parameter cannot be specified if this parameter is specified. (Split operations are invalid for routing keys with routing context.)

**Range:** **0-4294967295**

**:si=** (optional)

The service indicator.

**Range:** **0-15**

**0-15** or equivalent text values:

**Number = Text—Description**

**0 = snm**—Signaling network management messages

**1 = regtest**—Signaling network testing and maintenance regular

**2 = spltest**—Signaling network testing and maintenance special

**3 = sccp**—SCCP

**4 = tup**—Telephone user part

**5 = isup**—ISDN user part

**13 = qbicc**

See Table A-4 and Table 5-5 for valid **si** values in combination with other parameters.

**:split=** (optional)

The CIC value where the routing key with the specified CICS and CICE range will be split. The specified routing key is split into two entries with adjacent CIC ranges. The existing routing key retains the range of CICS that is lower than the **split** value. The value of **split** minus 1 is used as the end range for this entry. The range of CICS assigned to the original entry is the values of **cics** to **split** minus 1.

A new routing key entry is created with the high end of the original range. The **split** value is used as the start of the CIC range for this entry. The range of CICs assigned to the new entry is the values of **split** to **cice**.

This parameter is valid only if **si=4, 5, or 13** and is not valid with **ncics** or **ncice**. See Table A-4 and Table 5-5.

**Range: 0-16363**

**:ssn=** (optional)

Subsystem number. This parameter is mandatory and valid only if the **si=3** parameter is specified.

**Range: 0-255**

**:type=** (optional)

Type of routing key.

**Range: full, partial, default**

**Default: full**

### Example

```
chg-appl-
rtkey:dpc=123-230-245:si=5:opc=123-230-244:cics=1:cice=100:split=
50
```

```
chg-appl-
rtkey:dpc=123-230-245:si=5:opc=123-230-244:cics=1:cice=50:ncice=1
00
```

```
chg-appl-
rtkey:dpcn24=10-100-10:si=5:opc24=10-100-11:cics=1:cice=100:ncic
e=200
```

```
chg-appl-rtkey:dpc=8-8-8:si=3:ssn=5:rcontext=500
```

```
chg-appl-
rtkey:dpci=s-3-11-1:si=5:opci=s-4-11-1:cics=1:cice=1000:ncice=500
```

```
chg-appl-rtkey:rcontext=5:ncice=100
```

```
chg-appl-rtkey:rcontext=1:nrcontext=2
```

### Dependencies

Optional parameters that must be specified with the **chg-appl-rtkey** command depend on the type of routing key being changed. See Table 5-5 for valid parameter combinations.

The **srkq** parameter value in the **chg-sg-opts** command limits the maximum number of static routing keys that can be provisioned using the **ent-appl-rtkey** command. For **ss7ipgw** and **ipgwi** applications running on SSED CM cards (870-2732-xx) or E5-ENET cards (870-2212-xx), there is a limit of 2500 routing keys in the system. See the **chg-sg-opts** command for parameter values that allow 2500 routing keys to be defined in the system.

The subsystem number is mandatory and valid only when the **si=3** (or **sccp**) parameter is specified; if the **si** parameter does not equal **3** (or **sccp**), the **ssn** parameter cannot be specified.

The value entered for the starting circuit identification code (**cics**) must be less than or equal to the value entered for the ending circuit identification code (**cice**).

The value entered for the new starting circuit identification code (**ncics**) must be less than or equal to the value entered for the new ending circuit identification code (**ncice**).

A circuit identification code range (**cics** to **cice**) cannot be specified that overlaps an existing routing key.

When **si=4, 5, or 13** (or **tup, isup, or qbicc**), the **opc**, **cics**, and **cice** parameters are required. The **opc**, **cics**, and **cice** parameters can be specified only if **si=4, 5, or 13**.

The value entered for the circuit identification code split range (**split**) must be greater than the value entered for the starting circuit identification code (**cics**) and less than or equal to the value entered for the ending circuit identification code (**cice**).

The value entered for the new starting circuit identification code (**ncics**) must be less than or equal to the value entered for the ending circuit identification code (**cice**) when the new ending circuit identification code (**ncice**) is not specified.

The value entered for the new ending circuit identification code (**ncice**) must be greater than or equal to the value entered for the starting circuit identification code (**cics**) when the new starting circuit identification code (**ncics**) is not specified.

The **split**, **ncics**, and **ncice** parameters are not allowed with the **si** parameter unless the **si=4, 5, or 13** (or **tup, isup, or qbicc**) parameter is specified.

A DPC/SI routing key must be specified when the DPC is ANSI and the **si=4** parameter is specified (TUP is used only in an ITU network).

Table A-4 shows valid CIC values for SI types **4, 5, and 13**.

Partial point codes are not allowed; no asterisks can be specified in the point codes in the command.

Mixed point code types are not allowed; **opc** and **dpc** types must match.

When the **type=partial** or **type=default** parameters are specified, the **split** and **resize** parameters are not supported.

When the **type=full** parameter is specified, the **dpc** and **si** parameters must be specified.

The following types of partial routing keys are supported:

- DPC-SI-OPC (ignore CIC) can be used as a partial match key for CIC- based traffic.
- DPC-SI (ignore all other fields) can be used as a partial match key for CIC- based traffic or SCCP traffic.
- DPC only (ignore all other fields) can be used as a partial match for any type of traffic.
- SI only (ignore all other fields) can be used as a partial match for any type of traffic.

If the **rcontext** parameter is specified, then the **split**, **ncics** and **ncice** parameters cannot be specified.

The **rcontext** parameter must be specified for routing keys that are associated with SUA Application Servers.

The specified **rcontext** parameter value must already exist in the database.

If specified, the service indicator parameter must be **si=3** for routing keys that are associated with SUA Application Servers.

An AS cannot be simultaneously assigned to a routing key with routing contexts and routing keys without routing context. To assign an M3UA or SUA association to multiple routing keys with routing context, the M3UA/SUA association must be assigned to more than one AS, and each AS must be assigned to a routing key with routing context.

The AS name and parameters specified for a routing key must use an address format that is valid for the adapter type assigned to the AS.

**Table 5-5.** Valid Parameter Combinations for Routing Key Types using the **chg-appl-rtkey** command.

Action	dpc	si	ssn	opc	cics	cice	ncics	ncice	split	type
Split CIC Range	X	X		X	X	X			X	full
Re-size CIC Range	X	X		X	X	X	X	X		full
Socket Name Override (SI=ISUP or 5)	X	X		X	X	X				full
Socket Name Override (SI = SCCP or 3)	X	X	X							full
Socket Name Override (SI = not 3, 4, 5, or 13)	X	X								full
Socket Name Override (SI = 4, 5, or 13)	X	X		X						partial
Socket Name Override (SI = 3, 4, 5 or 13)	X	X								partial
Socket Name Override SI-only key		X								partial
Socket Name Override DPC-only key	X									partial
Socket Name Overrride Default key										default

The value of the **nrcontext** parameter cannot be changed for a routing key if the **rcontext** parameter has not been configured for that routing key.

The attributes that are required to change a routing key must be specified in the command.

**Notes**

A routing key entry associates a routing key with a socket name or Application Server (AS) name.

The parameters **dpc**, **si**, **ssn**, **opc**, **cics**, and **cice** are used to identify the routing key to be changed.

The parameters **split**, **ncics**, and **ncice** are used to specify new values for the routing key.

The **opc**, **cics**, and **cice** parameters are not required for partial routing keys.

The **cics**, **cice**, **ncice**, **ncice**, and **split** parameters are valid and required when **si=4** and ITU DPCs (**dpca**, **dpca**) are specified. These parameters are not valid when an ANSI DPC (**dpc**, **dpca**) is specified and **si=4**.

The following changes can be made for routing keys. Only one of these changes is allowed per command.

- A routing key can be split into two entries with adjacent CIC ranges. The resulting entries retain the socket associations of the original entry.
- The range of CICs assigned to a routing key can be changed as long as it does not overlap another routing key. The new entry retains the socket associations of the original entry.

Group codes are required for ITU-N point codes (DPCN/OPCN) when the Duplicate Point Code feature is turned on.



Routing context is a routing key parameter that uniquely identifies routing keys. Routing context is mandatory for routing keys associated with SUA Application Servers and optional for routing keys associated with M3UA Application Servers.

An AS cannot be simultaneously assigned to a routing key with routing contexts and routing keys without routing contexts.

In this command, only ITU-international and ITU national point codes support the spare point code subtype prefix (s-).

## Output

```
chg-appl-rtkey:dpc=123-230-245:si=3:ssn=250:nsname=socket5
rlghncxa03w 04-01-28 08:50:12 EST EAGLE 31.3.0
CHG-APPL-RTKEY: MASP A - COMPLTD
;
```

## chg-as

### Change Application Server

Use this command to change the characteristics of an existing Application Server (AS).

**Keyword:** chg-as

**Related Commands:** dlt-as, ent-as, rept-stat-as, rtrv-as

**Command Class:** Database Administration

## Parameters

**:asname=** (mandatory)

This parameter specifies the application Server (AS) name in the AS table.

**Range:** *aaaaaaaaaaaaaaaa*

Up to 15 alphanumeric characters; the first character must be a letter.

**:mode=** (optional)

This parameter specifies the traffic mode assigned to this AS.

**Range:** **loadshare, override**

The **mode=override** parameter is not valid for SUA associations assigned to the AS.

**Default:** No change from current value

**System**

**Default:** **loadshare**

**:tr=** (optional)

This parameter specifies the recovery timer value for this AS, in milliseconds.

**Range:** **10 - 2000**

**Default:** No change from current value

**System**

**Default:** **200**

## Example

```
chg-as:asname=asx:mode=override
```

## Dependencies

The AS name (**asname**) must already exist in the AS table.

Association connection parameters must be unique.

The connection state for all associations assigned to the AS must be **open=no** before the **mode** parameter can be changed.

The override traffic mode is not supported for SUA associations.



**:bufsize=** (optional)

Association buffer size in Kilobytes.

**Range:** 8-400

**:cwmn=** (optional)

Minimum congestion window. This parameter specifies the minimum and initial sizes, in bytes, of the association's congestion window.

**Range:** 1500-409600

**Default:** No change in current value

**System**

**Default:** 3000

**:istrms=** (optional)

SCTP Inbound Stream Value. A 16-bit unsigned integer that defines the number of streams the sender allows the peer end to create in this association.

**:lhost=** (optional)

Local host name. This parameter specifies the local host name as defined in the IP Host table.

**Range:** ~~~~~

Any string of characters beginning with a letter and comprising up to 60 characters in length.

Valid characters are **0-9**, **a-z**, **A-Z**, - (dash), . (period).

**Default:** No change in current value.

**:link=** (optional)

The signaling link for this association.

**Synonym:** port

**Range:** a, b, a1-a31, b1-b31

Not all card types support all **link** parameter values.

See Table A-1 for valid **link** parameter range values for each type of card that can have assigned signaling links.

**Default:** Current value.

**:lport=** (optional)

Local port. This parameter specifies the SCTP port number for the local host.

**Range:** 1024-65535

**Default:** Current value.

**:m2patset=** (optional)

The M2PA timer set assigned to this association.

**Range:** 1-20

**Default:** 1

**:open=** (optional)

Connection state (open or closed) that the connection manager is to put the association in when the socket is operational.

The **chg-assoc** command allows initiation of SCTP graceful shutdown on a per association basis for IPSP M3UA associations. The **chg-assoc:open=no** command aborts the association unless graceful shutdown is provisioned (see the **chg-uaps** command). If provisioned, then SCTP graceful shutdown for an association occurs after execution of **chg-assoc:open=no**.

**Range:** yes, no

**yes** — The connection manager is to open the association if the association is operational.

**no** — The connection manager will not open the association.

**Default:** No change in current value



**:rmin=** (optional)

Minimum retransmission timeout. This parameter specifies the minimum value of the calculated retransmission timeout in milliseconds.

**Range:** 10-1000

**Default:** No change in current value

**System**

**Default:** 120

**:rmode=** (optional)

Retransmission mode. This parameter specifies the retransmission policy used when packet loss is detected.

**Range:** lin, rfc

**lin**— The Tekelec Linear Retransmission Policy where each retransmission timeout value is the same as the initial transmission timeout, and only the slow start algorithm is used for congestion control.

**rfc**— Standard RFC 2960 algorithm in the retransmission delay doubles after each retransmission. The RFC 2960 standard for congestion control is also used.

**Default:** No change in current value

**System**

**Default:** lin

**:rport=** (optional)

Remote port. This parameter specifies the SCTP port number for the remote host.

**Range:** 1024-65535

**Default:** Current value.

**:rtimes=** (optional)

Maximum retransmission retries. This parameter specifies the number of times a data retransmission will occur before closing the association.

**Range:** 1-12

**Default:** No change in current value.

**System**

**Default:** 10

**:rtxthr=** (optional)

Retransmission threshold. This parameter specifies the value of the retransmission threshold to tune the IP Connection Excess Retransmits alarm.

**Range:** 0-65535

**Default:** 0

**:uaps=** (optional)

User adapter parameter set. This parameter specifies the set used by the M3UA or SUA association for various SNM message and notification response options.

**Range:** 1-10

**:ver=** (optional)

Version. This parameter specifies the M2PA version supported by the association.

The M2PA version is valid only for associations with the **adapter=m2pa** parameter specified .

**Range:** d6, rfc

**Example**

```
chg-
assoc:aname=a1:lhost=gw105.nc.tekelec.com:lport=1030:rhost=gw100.
nc.tekelec.com:rport=1030:open=yes:alw=yes:uaps=10
```

```

chg-assoc:aname=m3ua03:rtxthr=65535
chg-
assoc:aname=a1:lhost=tek1.com:lport=1030:rport=1030:rhost=tek2.com:
m: rhostval=match:rhosttype=primary
chg-
assoc:aname=a1:rhost=tek.com:rhostval=relaxed:rhosttype=alternate

```

## Dependencies

At least one optional parameter must be specified.

The association name (**aname**) must already exist in the IP Socket/Association (IPAPSOCK) table.

An association's connection parameters (**lhost**, **rhost**, **lport**, **rport**) must be unique.

The connection state must be **open=no** to change **lhost**, **rhost**, **lport**, **rport**, **port**, **alhost**, **adapter**, **m2patset**, **istrms**, **ostrms**, **rmode**, **rmin**, **rmax**, **rtimes**, **cwmin**, and **bufsize** parameters.

To specify the **open=yes** parameter, the values must be specified for all parameters that are required to fully specify the connection (**lhost**, **lport**, **rhost**, and **rport**). Specifying the **open=no** parameter requires only the **aname** parameter and at least one other optional parameter.

The value of the **uaps** parameter can be changed for an association if the **open=yes** parameter is specified.

The hostnames specified in the **lhost** and **alhost** parameters must refer to different IP addresses.

The hostnames specified in the **lhost** and **alhost** parameters must refer to IP addresses on the same IP card.

An association with **adapter=sua** or **m3ua** cannot be specified for an **lhost** on a card running the **iplim** or **iplimi** application. An association with **adapter=m2pa** cannot be specified for an **lhost** on a card running the **ss7ipgw** or **ipgwi** application. An association with **adapter=sua** cannot be specified for an **lhost** on a card running the **ipsg** application.

Before **open=yes** can be specified for an association, the local host must have a signaling link assigned to its associated signaling link port.

An association's **lhost** and **alhost** cannot be assigned to a card's Ethernet interface B.

The adapter layer cannot be changed for an association that is already associated with an Application Server (AS).

Before the local host can be changed, the new local host must have a signaling link assigned to its associated signaling link port.

The **link** parameter values **a**, **b**, **a1-a3**, and **b1-b3** can be specified only if the card is an SSEDCCM card running the **iplim** or **iplimi** application. The **link** parameter values **a**, **b**, **a1-a7**, and **b1-b7** can be specified only if the card is an E5-ENET card running the **iplim** or **iplimi** application.

The card location for the card associated with the **lhost** and **alhost** must exist in the IP Link table.

The allowed maximum is 1 association per signaling link on IPLIMx cards.

A maximum of 50 connections (association-to-AS assignments) can be specified per local host on IPGWx cards.

A maximum of 4000 connections (association-to-AS assignments + sockets) are allowed per system.

Table 5-6 shows the IP signaling capacities per DCM Class card (SSEDCCM / E5-ENET).

Table 5-6. IP Signaling Capacities

Appl	Cards Per System	SS7 Links Per Card	IP Connections Per Card Link	Total Connections
IPLIMx	100	8 (SSEDCM) 16(E5-ENET)	8 (SSEDCM) 16 (E5-ENET)	800 (SSEDCM) 1600 (E5-ENET)
IPGWx	64	1	50	3200
IPSG	64	1	50	3200
ENET	100	32	16	1600
System				4000

- Eagle OAM enforces “Cards per System” in the above table on a per Application basis. Engineering rules do not support all IP Signaling Applications provisioned at their max card count simultaneously.
- OAM enforces a maximum of 4000 IP connections per Eagle.

The **rmin** parameter value must be less than or equal to the **rmax** parameter value.

The **cwmin** parameter value must be less than or equal to the **bufsize** parameter value.

To assign an association on an IPLIMx card for a local host, the association must have an adapter parameter value that is the same as the **ipliml2** setting of its assigned signaling link. An association having an adapter value of **m2pa** must be assigned to an IPLIM signaling link having an **ipliml2** value of **m2pa**.

If the **m2patset** parameter is specified, the **adapter=m2pa** parameter must be specified.

The trade ratio states the quantity of associations to sockets that may be provisioned on a certain card, as follows:

$$\text{Trade Ratio} = a:s$$

Where: a=associations and s=sockets

The requested buffer size increase cannot exceed available buffer space on the card. Use the **rtrv-assoc** command with the **aname**, **lhost**, or **alhost** parameter to display used and total buffer space on the card.

The **ver** parameter can only be specified if the **adapter=m2pa** parameter is specified.

If the **lhost** parameter is specified for an E5-ENET card running the **ipsg** application, then the **link** parameter cannot be specified.

If an IPSPG card is being used, and if the association is referenced by a signaling link, then new values cannot be specified for the **lhost** or **adapter** parameters.

An IPSPG card can contain a maximum of 32 associations.

If the value specified for the **aname** parameter refers to an M3UA association on an IPSPG card, then the **alw** parameter cannot be specified.

The value specified for the **lhost** parameter cannot change the local host for the association from an IPLIMx or IPGWx card to an IPSPG card or from an IPSPG card to an IPLIMx or IPGWx card.

The **rhosttype=primary** parameter must be specified before the **rhosttype=alternate** parameter can be specified.

If the **rhosttype** parameter is specified, then the **rhost** parameter must be specified.

The value specified for the alternate remote host cannot be the same as the value specified for the **lhost**, **alhost**, or **rhost** parameter in the same association.

The value specified for the **rhost** parameter cannot be the same as the value specified for the alternate remote host or for the **lhost** or **alhost** parameter in the same association.

The host name specified by the **lhost** parameter must exist in the IP Host table and must be provisioned as local to this EAGLE 5 ISS. The value specified for the **host** parameter must begin with an alphabetic character and can contain **a..z**, **A..Z**, **0..9**, - (hyphen), or . (period). If the host name contains a hyphen, then the host name must be enclosed within quotation marks.

**Notes**

The command that is entered cannot exceed a total of 150 characters in length.

The IPAPSOCK table is used to associate the Local Host/Local Port to a Remote Host/Remote Port. This fully specifies the connection.

If the **open=yes** parameter is specified, the association's **lhost** and **lport** configuration must not match that of any open association.

If the card's application is **iplim** or **iplimi**,

- The **adapter** parameter value must equal **m2pa**.
- The **ipliml2** value for the assigned signaling link must equal **m2pa**.

An association with an **adapter** value of **m2pa** cannot be assigned to an SS7IPGW or IPGWI host. The M2PA version is supported if the application is IPLIMx and the **adapter=m2pa** parameter is specified. When changing the association adapter type to **m2pa** and a version is not specified, the **m2pa=rfc** value is assigned by default.

Table 5-7 shows the validation rules used to establish an association.

**Table 5-7.** Validation Rules for Association Establishment

<b>RHOSTVAL</b>	<b>RHOST Configured</b>	<b>ARHOST Configured</b>	<b>Source Parameter in IP Header</b>	<b>IP Address List in INIT/INIT ACK</b>	<b>Host Name Address Present in INIT/INIT ACK</b>
RELAXED	Y	N	RHOST	NA (1 or more IP addresses can be present, not necessarily match RHOST.)	N
RELAXED	Y	N	NA	RHOST (other IP addresses can also be present )	N



**Table 5-7.** Validation Rules for Association Establishment

<b>RHOSTVAL</b>	<b>RHOST Configured</b>	<b>ARHOST Configured</b>	<b>Source Parameter in IP Header</b>	<b>IP Address List in INIT/INIT ACK</b>	<b>Host Name Address Present in INIT/INIT ACK</b>
RELAXED	Y	N	RHOST	NA	RHOST
MATCH	Y	N	RHOST	N	N
MATCH	Y	N	RHOST	RHOST only (no additional addresses can be present)	N
MATCH	Y	N	RHOST	NA	RHOSTonly
RELAXED	Y	Y	RHOST or ARHOST	NA	N
RELAXED	Y	Y	NA	RHOST or ARHOST	N
RELAXED	Y	Y	Same as Hostname	NA (Ignore any IP addresses present)	RHOST or ARHOST
MATCH	Y	Y	RHOST	ARHOST must be present. RHOST can also be present. No other additional addresses.	N
MATCH	Y	Y	ARHOST	RHOST must be present. ARHOST can also be present. No other additional addresses	N

## Output

```

chg-
assoc:aname=a1:lhost=gw105.nc.tekelec.com:lport=1030:rport=1030:u
aps=10:rhost=gw100.nc.tekelec.com:alw=yes:rhostval=match:rhosttyp
e=primary
    rlghncxa03w 09-03-19 15:35:05 EST  EAGLE 41.0.0
    CHG-ASSOC: MASP A - COMPLTD
;

```

## chg-atinpopts

## Change ATINP Options

Use this command to provision ATINP-specific data. This command updates the ATINPQOPTS table.

**NOTE: The ATINP feature must be enabled before this command can be entered.**

**Keyword:** chg-atinpopts

**Related Commands:** rtrv-atinpopts

**Command Class:** Database Administration

## Parameters

**:atiackimsi=** (optional)

ATIACK IMSI parameter for ATI ACK response message. This parameter specifies formatting of IMSI digits in the ATI ACK response message. The result of formatting determines whether the IMSI parameter will be included in the response.

**Range:** srfimsi, asd, grn, none

**srfimsi**— If an entity was found during RTDB lookup, and SRFIMSI was provisioned in the EPAP entity, then include the IMSI parameter and encode the IMSI digits as the SRFIMSI.

**asd**— If an entity was found during RTDB lookup and ASD (Additional Subscriber Data) was provisioned in the EPAP entity, then include the IMSI parameter and encode the IMSI digits as ASD.

**grn**— If an entity was found during RTDB lookup, and GRN (Generic Routing Number) was provisioned in the EPAP entity, then include the IMSI parameter and encode the IMSI digits as GRN.

**none**— Do not include the IMSI parameter in the response message.

**Default:** none

**:atiackmsisdn=** (optional)

MSISDN parameter for ATI ACK response message. This parameter specifies the formatting of MSISDN parameter in the ATI ACK response message. The result of formatting determines whether the MSISDN parameter will be included in the response.

**Range:** msisdn, asd, asddlmsisdn, grn, grndlmsisdn, none

**msisdn**— Include the MSISDN parameter in the ATI ACK response and encode MSISDN digits as the MSISDN from the incoming ATI query.

**asd**— If an entity was found during RTDB lookup and ASD (Additional Subscriber Data) was provisioned in the entity, then include the MSISDN parameter and encode the MSISDN digits as ASD.

**asddlmsisdn**— Include the MSISDN parameter in the ATI ACK response and encode MSISDN digits as ASD + delimiter (**atidlm**) + MSISDN. ASD is encoded if an entity is found and ASD is provisioned. The specified outbound message digits delimiter (**atidlm**) value is encoded if the value is not **none**. MSISDN is encoded as the MSISDN from the incoming ATI query.

**grn** — If an entity was found during RTDB lookup and GRN (Generic Routing Number) was provisioned in the EPAP entity, then include the IMSI parameter and encode the IMSI digits as GRN.

**grndlmsisdn** — Include the MSISDN parameter in the ATI ACK response and encode MSISDN digits as GRN + delimiter (**atidlm**) + MSISDN. GRN is encoded if GRN entity is found. The specified outbound message digits delimiter (**atidlm**) value is encoded if the value is not **none**. MSISDN is encoded as the MSISDN from the incoming ATI query.

**none** — Do not include the MSISDN parameter in the response message.

**Default:** **msisdn**

**:atiackrn=** (optional)

Routing number parameter for ATI ACK response message. This parameter specifies the formatting of the routing number parameter in the ATI ACK response message. The result of formatting determines whether the routing number parameter will be included in the response.

**Range:** **rn, rnsdp, asddlmsrnsdp, rnsdpdlmasd, srfimsi, srfimsidlmasd, asddlmsrimsi, grndlmsrnsdp, rnsdpdlmsgrn, srfimsidlmsgrn, grndlmsrimsi, none**

**rn** — Routing number.

**rnsdp** — Routing number or signaling point.

**asddlmsrnsdp** — ASD, delimiter and routing number or signaling point.

Format routing number digits as ASD (if supported and available from lookup entity) + **atidlm** (if not **none**) + entity digits (as described in the **atiackrn=rnsdp** parameter).

**rnsdpdlmasd** — Routing number or signaling point, delimiter, ASD

Format routing number digits as entity digits (as described in **atiackrn=rnsdp**) + delimiter (if **atidlm** is not **none**) + ASD (if supported and available from lookup entity).

**srfimsi** — Encode routing number digits as SRFIMSI configured in the entity data.

If SRFIMSI was not found (MSISDN not found in RTDB lookup, or MSISDN found but no entity found, or entity found but SRFIMSI not configured) then the routing number will not be included in the response message.

**srfimsidlmasd** — SRFIMSI, delimiter, ASD

Encode routing number digits as SRFIMSI + delimiter (if **atidlm** is not **none**) + ASD (if supported and available from lookup entity). SRFIMSI is encoded as described in the **atiackrn=srfimsi** option.

**asddlmsrimsi** — ASD, delimiter, SRFIMSI

Encode routing number as ASD (if supported and available from lookup entity) + delimiter (if **atidlm** is not **none**) + SRFIMSI (encoded as specified in the **atiackrn=srfimsi** parameter).

**grndlmsrnsdp** — GRN, delimiter, Routing number or signaling point

Encode routing number as GRN (if supported and available from RTDB lookup) + delimiter (if **atidlm** is not **none**) + RNSP (encoded as specified in the **atiackrn=rnsdp** parameter).

**rnsdpdlmsgrn** — Routing number or signaling point, delimiter, GRN

Encode routing number as entity digits (as described in **atiackrn=rnsdp**) + delimiter (if **atidlm** is not **none**) + GRN (if supported and available from RTDB lookup).

**srfimsidlmsgrn** — SRFIMSI, delimiter, GRN

Encode routing number as SRFIMSI (encoded as specified in the **atiackrn=srfimsi** parameter) + delimiter (if **atidlm** is not **none**) + GRN (if supported and available from RTDB lookup).

**grndlmsrfimsi** — GRN, delimiter, SRFIMSI

Encode routing number as GRN (if supported and available from RTDB lookup) + delimiter (if **atidlm** is not **none**) + SRFIMSI (encoded as specified in the **atiackrn=srfimsi** parameter).

**none** — Do not include the Routing Number field in the response message.

**Default:** **rn**

**:atidfltrn=** (optional)

Default Routing Number. This parameter specifies the routing number to be used in outgoing message formats while encoding outgoing digit formats in the ATI ACK response in cases where an RN is not returned from an RTDB lookup.

**Range:** 1-15 digits, **none**  
Valid digits are **0-9, A-F, a-f**.

**Default:** **none**

**:atidlm=** (optional)

Outbound message digits delimiter. This delimiter is used in outgoing message formats while encoding outbound digits in the ATI ACK response. This option can be set to **none** at any time by the user.

**Range:** 1-15 digits, **none**  
Valid digits are **0-9, A-F, a-f**.

**Default:** **none**

**:atinptype=** (optional)

Number Portability Type. This parameter indicates what is considered to be a successful RTDB lookup.

**Range:** **any, always**  
**any** — MSISDN lookup is considered successful when any match is found (RN, SP, PublicDN, PrivateDN, match with no entity, or entity type is GRN or VMS and portability type is **none (0xff)**).  
**always** — The lookup is always considered to be successful whether an MSISDN was found or not found in the RTDB.

**Default:** **any**

**:entitylen=** (optional)

Entity Length. This parameter indicates the maximum number of digits to be used from entity data (SRFIMSI or entity ID) in the specified encoding format.

**Range:** **1-15 none**  
**none** - SRFIMSI or entity ID will be used without modification in the specified **atiackrn** parameter format.

**Default:** **none**

**:snai=** (optional)

Service NAI. This parameter specifies the number conditioning that is performed on the MSISDN digits in the incoming ATI query message before RTDB lookup is performed.

**Range:** **intl, nat, nai**  
**intl** — Number conditioning is not performed.  
**nat** — The default country code (defined in the **chg-stpopts** command **defcc** parameter) is pre-pended to the MSISDN before RTDB lookup.  
**nai** — The NAI from the MSISDN in the incoming ATI query is used to perform number conditioning. If the message NAI is International (0x1) or Network Specific Number

(0x3) , then no conditioning is performed. In all other cases, the default country code (defined in the **chg-stpopts** command **defcc** parameter) is pre-pended to the MSISDN before RTDB lookup.

**Default:**     **nai**

**:sporttype=** (optional)

Service Portability type. This parameter specifies the application of Service Portability that is applied to the associated feature.

The S-Port feature must be enabled before this parameter can be specified. The S-Port feature must be turned on before any change to the parameter will impact the associated feature.

**Range:**       **gsm, is41, all, none**

**gsm**— Apply Service Portability prefix (RTDB GRN Entity ID) for own-network GSM subscribers

**is41**— Apply Service Portability prefix (RTDB GRN Entity ID) for own-network IS41 subscribers

**all**— Apply Service Portability prefix (RTDB GRN Entity ID) for all own-network (IS41 and GSM) subscribers

**none**— Service Portability is not performed for the feature.

**Default:**     No change to the current value

**System**

**Default:**     **none**

### Example

The following command specifies that the outbound message delimiter will not be used in outgoing message formats.

**chg-atinpopts:atidlm=none**

The following command specifies that the NAI of the incoming MSISDN digits will be considered to be National, and specifies that the IMSI parameter will not be included in the ATI ACK response message.

**chg-atinpopts:snai=nai:atiackimsi=none**

The following command specifies that the lookup is always considered to be successful, and specifies that the NAI of the incoming MSISDN digits will be considered to be National.

**chg-atinpopts:atinptype=always:snai=nat**

The following command specifies that the Routing Number field will not be included in the response, and that the MSISDN in the ATI ACK response will be encoded as the ASD.

**chg-atinpopts:atiackrn=none:atiackmsisdn=asd**

The following command specifies that the Routing Number field will not be included in the response.

**chg-atinpopts:atiackrn=none**

The following command specifies that the IMSI and MSISDN in the ATI ACK response will be encoded as GRN.

**chg-atinpopts:atiackimsi=grn:atiackmsisdn=grn**

### Dependencies

At least one optional parameter must be specified.

The ATINP feature must be enabled before this command can be entered.

The Service Portability feature must be enabled before the **sporttype** parameter can be specified.

**Output**

```

chg-
atinpqopts:atiackimsi=grn:atiackmsisdn=grndlmmsisdn:atiackrn=grnd
lmrnsp
tekelecstp 09-06-05 12:40:16 EST EAGLE 41.1.0
CHG-ATINPQOPTS: MASP A - COMPLTD
;

```

**chg-atm-lps****Change ATM Link Parameter Set**

Use this command to configure a link parameter set with timers and other parameters used by the system to provide level 2 functions for each ATM high-speed signaling link.

Use this command also to copy values from **lpset 20** and **30**, as well as any **lpset** to another. The **action=copy** and **srclpset=x** parameters provide this capability.

**Keyword:** **chg-atm-lps**

**Related Commands:** **ent-slk, rtrv-atm-lps**

**Command Class:** Database Administration

**Parameters**

**NOTE: Unless specified, the system default values are meant for both ANSI (T1) and ITU (E1) standards.**

**:lpset=** (mandatory)

The link parameter set being changed. Sets **1** through **19** and **21** through **29** can be configured by the user. Link parameter sets **20** and **30** are not configurable, but are used to contain the recommended default values for a set.

**Range:** **1-19, 21-29**

**Default:** **1** for ANSI  
**21** for ITU

**:action=** (optional)

This parameter copies a set of ATM signaling link parameters from one set to another.

**Range:** **copy**

**Default:** No change to the current value

**:maxcc=** (optional)

The maximum number of transmissions of BGN, END, ER, or RS PDU.

**Range:** **1-10**

**Default:** **4**

**:maxnrp=** (optional)

The maximum number of retransmitted PDUs during proving.

**Range:** **0-10**

**Default:** **1** for ANSI  
**0** for ITU

**:maxpd=** (optional)

The maximum number of SD PDUs that can be sent before a POLL is sent.

**Range:** **5-2120**

**Default:** **500**

**:maxstat=** (optional)

The maximum number of list elements in a STAT PDU.

**Range:** **3-67**

**Default: 67**

**:n1=** (optional)

The number of PDUs sent during proving.

**Range: 500-64552**

**Default: 64552** for ANSI  
**1000** for ITU

**:nblk=** (optional)

The number of monitoring intervals per block.

**Range: 1-10**

**Default: 3**

**:srclpset=** (optional)

The source **lpset** for a **copy** action. This parameter can be specified only with the **action=copy** parameter.

**Range: 1-30**

**:tmrcc=** (optional)

The timer, in milliseconds, used during the connection phase to guard against unacknowledged BGN, END, ER or RS PDUs.

**Range: 100-2000**

**Default: 200**

**:tmrerm=** (optional)

The error rate monitor interval, in milliseconds.

**Range: 25-500**

**Default: 100**

**:tmridle=** (optional)

The timer, in milliseconds, used during the idle phase when no SD PDUs are being sent to limit time in the idle phase.

**Range: 25-1000**

**Default: 100**

**:tmrkalive=** (optional)

The timer, in milliseconds, used during the transient phase when no SD PDUs are being sent to keep connection up.

**Range: 25-500**

**Default: 100**

**:tmrnocred=** (optional)

The timer, in milliseconds, used when the no credit exists and PDUs are available to be sent.

**Range: 1000-6000**

**Default: 1500**

**:tmrnorsp=** (optional)

The timer, in milliseconds, used to check that STAT PDUs are arriving often enough.

**Range: 500-2000**

**Default: 1500**

**:tmrpoll=** (optional)

The timer, in milliseconds, used to guarantee that POLL PDUs are sent often enough.

**Range: 25-500**

**Default: 100**

**:tmrprov=** (optional)

The timer, in milliseconds, used to monitor the status of a link after it is placed into service.

**Range:** 60000-120000

**Default:** 60000

**:tmrsrec=** (optional)

The timer, in milliseconds, used to prohibit closely spaced SSCOP recoveries from occurring.

**Range:** 60000-10800000

**Default:** 3600000

**:tmrt1=** (optional)

The time, in milliseconds, between link release action and the next link reestablish action during alignment.

**Range:** 1000-15000

**Default:** 5000

**:tmrt2=** (optional)

The total time, in milliseconds, that SSCF will attempt alignment.

**Range:** 15000-180000

**Default:** 120000 for ANSI  
30000 for ITU (E1)

**:tmrt3=** (optional)

The time, in microseconds, between proving PDUs.

**Range:** 450-23000

**Default:** 925

**Example**

```
chg-atm-lps:lpset=5:tmrprov=1000:tmridle=55
```

```
chg-atm-lps:lpset=3:src1pset=5:action=copy
```

**Dependencies**

The values in link parameter sets **20** and **30** are the system default values. They cannot be changed but can be copied to another link parameter set.

The values of the **lpset** and **src1pset** parameters cannot be the same.

The **action** and **src1pset** parameters must be specified together.

If **action=copy** is specified, only the **lpset** and **src1pset** parameters can be specified.

At least one optional parameter must be specified.

**Notes**

The **lpset** values **20** and **30** are non-configurable and contain the default values for ANSI and ITU ATM standards respectively. The **lpset** values **1** through **19** and **21** through **29** are configurable and initialized to the default values for ANSI and ITU standards respectively.

If no parameter value for **lpset** is included when the **ent-slk** command is entered, the system default value of **1** is assigned for ANSI links and the system default value of **21** is assigned for ITU links.

All timer values for link parameter sets are initialized to the system default values.



**Output**

```

chg-atm-lps:lpset=5:tmrprov=1000:tmridle=55

rlghncxa03w 04-01-05 16:40:40 EST EAGLE 31.3.0
CHG-ATM-LPS: MASP A - COMPLTD
;

```

**chg-attr-seculog****Change the Security Log Characteristics**

Use this command to modify various attributes that affect the operation of the security logging feature. These attributes include:

- Enabling or disabling the raising of alarms when the log needs uploading
- Specifying the log percentage full threshold at which an *upload required* alarm is raised for the active security log.

**Keyword:** **chg-attr-seculog**

**Related Commands:** **rtrv-attr-seculog**

**Command Class:** Security Administration

**Parameters**

**:upldalm=** (optional)

Enable or disable log alarms that pertain to uploading of the security log.

**Range:** **yes, no**

**yes**—Enables the log alarms pertaining to uploading of the log, as follows:

- Upload required
- Log overflowed
- Standby log contains greater than 0 un-uploaded entries

**no**—Prevents the log alarms from being raised when these conditions occur. Should the alarm already be raised when **no** is specified, the alarm is lowered.

**Default:** No change to the current value

**:upslg=** (optional)

Percent full threshold. This parameter specifies the percent full threshold for the security logs. If the **upldalm=yes** parameter is configured, an alarm is raised for the security log when the *%full* field (as displayed using the **rept-stat-seculog** command) in the log, on the active OAM, reaches or exceeds the value specified for **upslg**. This alarm indicates that the administrator must upload the log.

**Range:** **1-99**

**Default:** No change to the current value

**Example**

```
chg-attr-seculog:upslg=80:upldalm=yes
```

**Dependencies**

At least one optional parameter must be specified.

**Notes**

None

**Output**

```

chg-attr-seculog:upslg=80:upldalm=yes

rlghncxa03w 04-01-05 16:40:40 EST EAGLE 31.3.0
CHG-ATTR-SECULOG: MASP B - COMPLTD
;

```

**chg-clkopts****Change Clock Options**

Use this command to perform a software update of the clock elements and settings.

**Keyword:** chg-clkopts

**Related Commands:** rtrv-clkopts

**Command Class:** Database Administration

**Parameters**

**:clock=** (mandatory)

This parameter specifies the clock that is to be updated.

**Range:** **primary, secondary, all**

**primary** — The primary clock

**secondary** — The secondary clock

**all** — All clocks

E5-TDM cards must be installed before a value of **primary** or **secondary** can be specified.

**:force=** (optional)

The **force=yes** parameter is used to change the **hscsksrc** parameter value when the TDMs are reporting that the high speed system clocks are currently valid.

**Range:** **yes**

**:hscskll=** (optional)

High speed master clock line length.

**Range:** **longhaul, shorthaul**

**longhaul** — Gain is high for long haul

**shorthaul** — Gain is low for short haul

**Default:** No change to the current value

**System**

**Default:** **longhaul**

**:hscsksrc=** (optional)

High speed master clock source. The **force=yes** parameter must be specified with this parameter to change the clock source when the TDMs are reporting that the high speed system clocks are currently valid.



**CAUTION:** Changing the high speed master clock source can result in clock outage and loss of traffic on all links, if the new source type does not match the provisioned source for the E1 or T1 cards (what is actually plugged into the backplane).

**Range:** **rs422, e1framed, e1unframed, t1framed, t1unframed**

**rs422** — RS-422 clock source

**e1framed** — E1 Framed clock source

**e1unframed** — E1 Unframed clock source

**t1framed** — T1 Framed clock source

**t1unframed** — T1 Unframed clock source

**Default:** No change to the current value

**System**  
**Default:** rs422

**Example**

```
chg-clkopts:clock=primary:hsclksrc=t1framed
chg-clkopts:clock=all:hsclksrc=rs422:force=yes
chg-clkopts:hsclk11=shorthaul:clock=secondary
```

**Dependencies**

The parameters entered are not compatible with the card where the clock resides.

If the **hsclksrc** and **clock=all** parameters are specified, and the high speed clocks are reporting, then the **force=yes** parameter must be specified.

The **hsclksrc=rs422** parameter must be specified. The **hsclksrc** parameter values **t1unframed**, **t1framed**, **e1unframed**, and **e1framed** cannot be specified if either TDM is a version that does not support the Global Timing Interface feature (both TDMs must be TDM-15 or later (including E5-TDM), with the Global Timing Interface loaded). The **hsclk11** parameter cannot be specified if either TDM is a version that does not support the Global Timing Interface feature (both TDMs must be TDM-15 or later (including E5-TDM), with the Global Timing Interface loaded).

**Notes**

*Eagle Clocks with TDM-GTI*

Figure 5-1 shows a general schematic of clocking, without any of the redundant backup features, in the EAGLE 5 ISS with the TDM-GTI card. Low and high speed reference clocks can be plugged into the control shelf backplane as input clocks. The TDM card uses these input clocks as timing references to generate the low and high speed clocks that are distributed to the cards in the EAGLE 5 ISS STP. These distributed clocks are used for various purposes depending on what types of links or features are provisioned.

**Figure 5-1.** Eagle Input and Internal Clocks with TDM-GTI

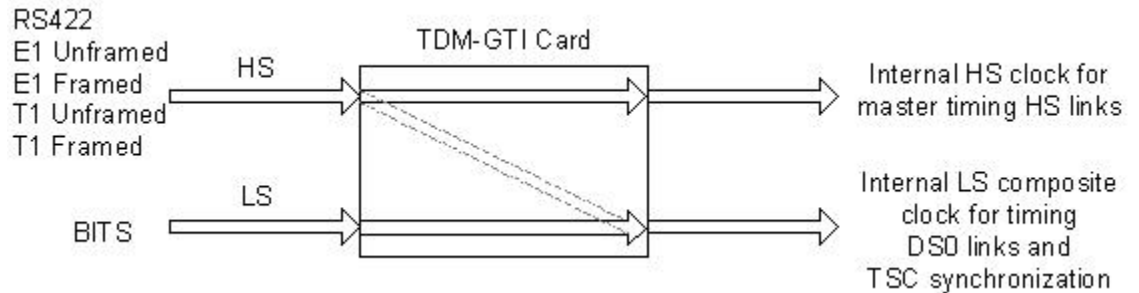

The high speed clock that is distributed to the cards in the EAGLE 5 ISS is used as the timing source only for high speed links that have been provisioned to use master timing. This clock can be derived only from the high speed input clock. Prior to TDM-GTI card, the high speed input clock could be only the RS422 type. The TDM-GTI card allows the clock to be recovered from a framed or unframed E1 or T1 signal interface.

The low speed composite clock that is distributed to the cards in the EAGLE 5 ISS is used for timing DS0 links and for the Time Slot Counter Synchronization (TSCSYNC) feature that is required for the Sentinel and IMF products. Prior to TDM-GTI this low speed clock could be generated only from a BITS clock source plugged into the control shelf backplane. TDM-GTI can generate this low speed internal clock from the high speed input clock source, with the following restriction:



**Range:** *ayy*  
Specify the parameter value in the format *ayy -no* or *ayy -yes*.  
*ayy*—Configurable command class name of 1 alphabetic character followed by 2 alphanumeric characters  
**-no**—Indicates that the command class is not allowed.  
**-yes**—Indicates that the command class is allowed.

**:class4=** (optional)

Configurable command class name (*ayy*), and indicator (**-yes** or **-no**) to specify whether the command class is allowed

**Range:** *ayy*  
Specify the parameter value in the format *ayy -no* or *ayy -yes*.  
*ayy*—Configurable command class name of 1 alphabetic character followed by 2 alphanumeric characters  
**-no**—Indicates that the command class is not allowed.  
**-yes**—Indicates that the command class is allowed.

**:class5=** (optional)

Configurable command class name (*ayy*), and indicator (**-yes** or **-no**) to specify whether the command class is allowed.

**Range:** *ayy*  
Specify the parameter value in the format *ayy -no* or *ayy -yes*.  
*ayy*—Configurable command class name of 1 alphabetic character followed by 2 alphanumeric characters  
**-no**—Indicates that the command class is not allowed.  
**-yes**—Indicates that the command class is allowed.

**:class6=** (optional)

Configurable command class name (*ayy*), and indicator (**-yes** or **-no**) to specify whether the command class is allowed.

**Range:** *ayy*  
Specify the parameter value in the format *ayy -no* or *ayy -yes*.  
*ayy*—Configurable command class name of 1 alphabetic character followed by 2 alphanumeric characters  
**-no**—Indicates that the command class is not allowed.  
**-yes**—Indicates that the command class is allowed.

**:class7=** (optional)

Configurable command class name (*ayy*), and indicator (**-yes** or **-no**) to specify whether the command class is allowed.

**Range:** *ayy*  
Specify the parameter value in the format *ayy -no* or *ayy -yes*.  
*ayy*—Configurable command class name of 1 alphabetic character followed by 2 alphanumeric characters  
**-no**—Indicates that the command class is not allowed.  
**-yes**—Indicates that the command class is allowed.

**:class8=** (optional)

Configurable command class name (*ayy*), and indicator (**-yes** or **-no**) to specify whether the command class is allowed



**Default:** No change to current value

**:nclass=** (optional)

This parameter specifies the new configurable command class name.

**Range:** *ayy*

1 alphabetic character followed by 2 alphanumeric characters (*ayy*)

**Default:** No change to current value

### Example

```
chg-cmdclass:class=abc:descr="my command class description"
chg-cmdclass:class=u23:nclass=dab:descr="his command class
description"
chg-cmdclass:class=dab:nclass=krb
```

### Dependencies

At least one optional parameter must be specified.

The Command Class Management feature must be enabled and turned on before this command can be entered.

The **class** parameter value must be a valid configurable command class name (one of the default configurable command class names or a user-defined command class name).

The new command class name parameter value (**nclass**) must not be the same as an existing configurable or non-configurable command class name.

### Notes

None

### Output

```
chg-cmdclass:class=abc:descr="my command class description"

rlghncxa03w 04-01-05 16:40:40 EST EAGLE 31.3.0
CHG-CMDCLASS: MASP B - COMPLTD
;
```

## chg-csl

### Change Common Screening List

Use this command to change an existing entry in the Common Screening List (CSL). The Common Screening List commands are used to tailor certain types of general screening information to specific features.

**Keyword:** **chg-csl**

**Related Commands:** **dlt-csl, ent-csl, rtrv-csl, rtrv-ctrl-feat**

**Command Class:** Database Administration

### Parameters

**NOTE:** See "Point Code Formats and Conversion" for a detailed description of point code formats, rules for specification, and examples.

**NOTE:** Either the **ds** parameter or the **pc** parameter must be specified in the command. Both parameters cannot be specified in the same command.

**:ds=** (optional)

Digit string. This parameter specifies a unique string of digits that is used by the specified screening feature.

- Range:** 1-15 digits  
Valid digits are **0-9, a-f, A-F**.
- 1-6 digits—Prepaid IDP Query Relay **ccnc** list
  - 1-15 digits—Prepaid IDP Query Relay **gt** list
  - 1-10 digits—Prepaid IDP Query Relay **skbcsm** list
  - 4 digits—IDP Screening for Prepaid **skts** list
  - 1-15 digits—IDP Screening for Prepaid **insl** list
  - 1-15 digits—VFLEX **vmpfx** list
  - 1-6 digits—Info Analyzed Relay Base **ccnc** list
  - 1-15 digits—Info Analyzed Relay Base **gt** list
  - 2 digits—Info Analyzed Relay Base **trig** list

Table 5-47 lists valid hexadecimal values for the Info Analyzed Relay Base **trig** list **ds** entries.

**:feature=** (optional)

Feature name. This parameter specifies the name of the enabled screening feature for which the command is entered.

**NOTE: Either the pn parameter or the feature parameter must be specified to identify the feature.**

- Range:** *abcdefghijklmnopqrstuvwxyz*  
1 alphabetic character followed by up to 24 optional alphanumeric characters, including spaces and special characters, enclosed in double quotation marks (" ").

Enter enough of the feature name to make the name unique if two features begin with the same word or acronym. The following feature names are valid for this command:

- Info Analyzed Relay Base
- IDP Screening for Prepaid
- Prepaid IDP Query Relay
- VFLEX

**:list=** (optional)

This parameter specifies the name of the Common Screening List that is associated with the feature.

**NOTE: The list parameter must be specified when the feature uses more than one type of Common Screening List.**

- Range:** **gt, skbcsm, ccnc, skts, insl, vmpfx, trig, delpfx**  
**gt**— Global Title List  
**skbcsm**— SK+BCSM List  
**ccnc**— CC+NC List  
**skts**— SK+TS List  
**insl**— In Network Subscriber List  
**vmpfx**— Voice Mail Prefix List  
**trig**— Trigger List  
**delpfx**— Delete Prefix List

The following screening lists are valid for the indicated features:



- **skts, insl**—IDP Screening for Prepaid
- **ccnc, gt**—Prepaid IDP Query Relay, Info Analyzed Relay Base
- **skbcsm**—Prepaid IDP Query Relay
- **vmpfx**—VFLEX
- **trig**—Info Analyzed Relay Base

The **delpfx** list is not supported at this time. This list should only be used by Tekelec personnel.

**:p1=** (optional)

Parameter value 1. This parameter value is specific to the feature and list using the parameter.

**NOTE: Currently, only the Prepaid IDP Query Relay (IDP Relay) feature uses this parameter.**

**Range:**        *zzzzzzzz*

Valid values are **0, 1, 3-35 (Prepaid1-Prepaid32), 255 (Prepaidno)**

**0, 1-gt** list

**3-35 (Prepaid1-Prepaid32 ), 255 (Prepaidno)-skbcsm** list

**:p2=** (optional)

Parameter 2. The parameter value is specific to the feature and list name that use this parameter. No feature currently uses this parameter.

**:p3=** (optional)

Parameter 3. The parameter value is specific to the feature and list name that use this parameter. No feature currently uses this parameter.

**:pc=** (optional)

ANSI point code with subfields *network indicator-network cluster-network cluster member (ni-nc-nm)*.

**Synonym: pca**

**Range:**        **000-255**

Specify a valid value for each subfield of the point code, and separate the subfields with a dash (-).

When **chg-sid:pctype=ansi** is specified, *ni = 000* is not valid.

When **chg-sid:pctype=ansi** is specified, *nc = 000* is not valid if *ni = 001-005*.

When **chg-sid:pctype=ansi** is specified, *nc = 000* is valid if *ni = 006-255*.

The point code **000-000-000** is not a valid point code.

**:pc/pca/pci/pcn/pcn24=** (optional)

Point code. Either the **ds** parameter or a point code parameter must be specified.

**:pci=** (optional)

ITU international point code with subfields *zone-area-id*.

**Range:**        **0-255**

Specify a valid value for each subfield of the point code, and separate the subfields with a dash (-).

The point code **0-000-0** is not a valid point code.

*zone*—**0-7**

*area*—**000-255**

*id*—**0-7**

**:pcn=** (optional)

ITU national destination point code in the format of a 5-digit number (*nnnnn*); or 2, 3, or 4 numbers (members) separated by dashes (*m1-m2-m3-m4*) as defined by the **chg-stpopts:npcfnti** flexible point code option. A group code must be specified when the ITUDUPPC feature is turned on (*nnnnn-gc*, *m1-m2-m3-m4-gc*).

**Range:** **s-, 0-16383, aa-zz**

Specify a valid value for each subfield of the point code, and separate the subfields with a dash (-).

*prefix*—**s-**

*nnnnn*—**0-16383**

*gc*—**aa-zz**

*m1-m2-m3-m4*—**0-14** for each member; values must sum to 14

**:pcn24=** (optional)

24-bit ITU national point code with subfields *main signaling area-sub signaling area-signaling point* (*msa-ssa-sp*).

**Range:** **000-255**

Specify a valid value for each subfield of the point code, and separate the subfields with a dash (-).

*msa*—**000-255**

*ssa*—**000-255**

*sp*—**000-255**

**:pn=** (optional)

Part Number. The 9-digit "893xxxxxx" part number of the feature for which the command is entered. The **rtrv-ctrl-feat** command description shows the part number in the command output example.

**NOTE: Either the pn parameter or the feature parameter must be specified to identify the feature.**

**Range:** **893000000-893999999**

The first 3 digits are **893**. Do not separate the digits with dashes or spaces. The following part numbers are valid for this command:

- **893015501**—IDP Screening for Prepaid
- **893016001**—Prepaid IDP Query Relay
- **893016701**—VFLEX
- **893034201**—Info Analyzed Relay Base

### Example

```
chg-csl:feature="IDP Screening for
Prepaid":list=insl:ds=123456789bcDEF
```

```
chg-csl:feature="VFLEX":list=vmpfx:ds=123456789abcDEF
```

### Dependencies

An enabled feature must be specified using either a valid part number (**pn**) or feature name (**feature**). The specified feature must use a Common Screening List.

The feature that is specified by the **feature** parameter must already be enabled.

The **list** parameter must be specified for features that use more than one type of screening list.

The value specified for the **list** parameter must be valid for the specified screening feature. The following **list** parameter values are valid for the indicated feature:

- **insl, skts**—IDP Screening for Prepaid
- **gt, ccnc**—Prepaid IDP Query Relay or Info Analyzed Relay Base
- **skbcsm**—Prepaid IDP Query Relay
- **vmpfx**—VFLEX
- **trig**—Info Analyzed Relay Base

The specified screening list entry must exist in the screening list that is used by the feature.

The length of the digit string that is specified for the **ds** parameter must be valid for the screening feature and list type.

A valid **ds** parameter value is required for the specified feature and list type.

The following parameters are allowed with the indicated common screening list type:

- **list=gt—ds** parameter
- **list=ccnc—ds** parameter
- **list=skbcsm—ds** parameter
- **list=skts—ds** parameter
- **list=insl—ds** parameter
- **list=vmpfx—ds** parameter
- **list=trig—ds** parameter

The leading digit pattern of the value specified for the **ds** parameter must be unique in the specified screening list for the indicated feature.

The **pc** and **ds** parameters cannot be specified together in the command.

The value specified for the **feature** parameter must be valid feature name for a feature that uses a Common Screening List. The feature name must be specified as it appears in the **rtrv-ctrl-feat** command output. Enough of the name must be specified to make the name unique when two features begin with the same word or acronym.

## Notes

None

## Output

```
chg-csl:feature="IDP Screening for
Prepaid":list=insl:ds=123456789bcDEF
tekelecstp 05-08-21 15:18:41 EST EAGLE 34.3.0
INSL List table is (5 of 25) 20% full
CHG-CSL: MASP A - COMPLTD
;

chg-csl:pn=893016701:list=vmpfx:ds=123456789abcDEF
tekelecstp 08-05-22 14:31:53 EST EAGLE 39.0.0
VM Prefix List table is (1 of 100) 1% full
CHG-CSL: MASP A - COMPLTD
;
```

**chg-ctrl-feat****Change Controlled Feature**

Use this command for controlled features that have been purchased and enabled with the **enable-ctrl-feat** command to:

- Turn on or turn off On/Off features
- Turn on Permanently On features (they cannot be turned off after they have been turned on)

Use this command when the system station shows an expired temporary key and the administrator wants to clear the CRITICAL system alarm without purchasing a permanent Feature Access Key.

**Keyword:** **chg-ctrl-feat**

**Related Commands:** **enable-ctrl-feat, rtrv-ctrl-feat**

**Command Class:** Database Administration

**Parameters**

If the Service Portability feature is turned on before a dependant feature is turned on, then a warning is issued:

**WARNING: No Service Portability dependent feature is on.**

If the Service Portability feature is turned off when more than one dependent feature is, then a warning is issued:

**WARNING: Service Portability is OFF.**

**:partnum=** (mandatory)

Part number. This parameter specifies the part number for the feature.

**Range:** **893000000 - 893999999**

Do not include dashes in the 9-digit number.

**:alarm=** (optional)

Clears alarms when temporary feature keys have expired.

**Range:** **clear**

**:status=** (optional)

Changes the operational status of the feature.

**Range:** **on, off**

**Default:** No change in current status

**Example**

```
chg-ctrl-feat:partnum=893xxxxxx:status=on
```

```
chg-ctrl-feat:partnum=893xxxxxx:alarm=clear
```

**Dependencies**

The controlled feature specified by the **partnum** parameter must be enabled (see the **enable-ctrl-feat** command) before this command can be entered.

One of the optional parameters, but not both, must be specified in the command.

To use this command to turn off a feature, the Part Number specified in the command must be for one of the following On/Off features that is currently on. (A Permanently On feature is turned on with this command; after the feature has been turned on, it cannot be turned off with this command):

- 893018001 1100 TPS/DSM for ITU NP
- 893022101 ATI Number Portability Query (ATINP)

- 893017601 Circ Route Auto-Recovery
- 893005801 Command Class Management
- 893400001 EAGLE OA&M IP Security
- 893018101 Enhanced Far-End Loopback
- 893015401 Flexible GTT Load Sharing (FGTTLS)
- 893027401 GTT Load Sharing with Alternate Routing Indicator (GTT LS ARI)
- 893020101 HIPR2 High Rate Mode
- 893025701 IDPR ASD
- 893025601 IDPR GRN
- 893035001 Info Analyzed Relay ASD
- 893035101 Info Analyzed Relay GRN
- 893026101 Info Analyzed Relay NP
- 893006901 Intermediate GTT Load Sharing (IGTTLS)
- 893005701 IP User Interface (Telnet)
- 893018401 Large BICC MSU Support for IP Signaling
- 893006601 LNP Short Message Service (LNP SMS)
- 893007001 MNP Circular Route Prevention
- 893026701 MO SMS ASD
- 893024601 MO SMS B-Party Routing
- 893026601 MO SMS GRN
- 893026201 MO SMS IS41-to-GSM Migration
- 893013501 MTP Map Screening
- 893009101 Network Security Enhancement
- 893009301 Portability Check for Mobile Originated SMS
- 893006701 Prepaid SMS Intercept Phase 1 (PPSMS)
- 893018801 SEAS over IP
- 893034301 Service Portability
- 893024501 TIF ASD
- 893025501 TIF GRN
- 893022501 TIF Number Substitution

Turning on a feature that is already on or turning off a feature that is already off has no effect.

The GTT feature must be turned on (see the **chg-feat** command) before the following features can be turned on:

- Intermediate Global Title Translation Load-Sharing (IGTTLS)
- LNP ELAP Configuration
- SCCP Loop Detection

All IPSM cards in the system must be inhibited before the IP User Interface (Telnet) feature can be turned on or off.

All IPSM cards in the system must be inhibited before the EAGLE OA&M IP Security Enhancements feature can be turned on or off.

The **mtplprst** option must be enabled (see the **chg-stpopts** command) before the Origin-based MTP Routing feature can be turned on.

Only one of the optional parameters, not both, can be specified in the command.

After a Permanently On feature is turned on, it cannot be turned off with this command. All controlled features with quantity feature access keys (like LNP ported TNs) and the following features are Permanently On features:

- 15 Minute Measurements
- Advanced GTT Modification (AMGTT)
- Advanced GTT Modification Called Party Only (AMGTT CdPA Only)
- Advanced GTT Modification Calling Party Upgrade (AMGTT CgPA Upgrade)
- ANSI-41 INP Query
- ANSI-41 Mobile Number Portability (A-Port)
- ANSI-ITU-China SCCP Conversion
- Enhanced GSM MAP Screening (EGMS)
- Equipment Identity Register (EIR)
- Flexible Linkset Optional Based Routing (FLOBR)
- G-Flex MAP Layer Routing
- G-Port SRI Query for Prepaid
- GSM Flexible Numbering (G-Flex)
- GSM MAP Screening (GMS)
- GSM MAP SRI Redirect for Serving HLR
- GSM Mobile Number Portability (G-Port)
- Hex Digit Support for GTT
- IDP A-Party Blacklist
- IDP A-Party Routing
- IDP Screening for Prepaid
- IDP Service Key Routing
- Info Analyzed Relay Base (IAR)
- INP
- IS41 GSM Migration (IGM)
- ISUP NP with EPAP
- ITU TCAP LRN Query (LRNQT)
- ITUN-ANSI SMS Conversion
- LNP ELAP Configuration

- MO-based GSM SMS NP
- MO-based IS41 SMS NP
- MT-Based GSM SMS NP
- MT-Based GSM MMS NP
- MT-Based IS41 SMS NP
- MTP Msgs for Prepaid Apps (MTPR)
- Multiple Linkset to a Single Adjacent Point Code
- Origin-Based MTP Routing
- Origin-based SCCP Routing
- Prepaid IDP Query Relay
- SCCP Loop Detection
- SLS Bit Rotation by Incoming Linkset (ISLSBR)
- Spare Point Code Support
- Support for 16 GTT Lengths in VGTT
- TCAP Opcode Based Routing (TOBR)
- TCAP Opcode Quantity
- TIF Number Portability
- TIF SCS Forwarding
- TIF Simple Number Substitution
- Transaction-based GTT Loadsharing (TBGTTLs)
- Voice Mail Router (V-Flex)
- Weighted GTT Loadsharing (WGTTLs)

The value specified for the **partnum** parameter must be the correct part number for the purchased feature.

Before the 15 Minute Measurements feature can be turned on,

1. The Measurements Platform feature must be turned on (see the **chg-feat** command).
2. The Measurements Platform Enabled option must be enabled (see the **chg-measopts** command).

Before the 15 Minute Measurements feature can be turned on, at least one MCPM card must be in the IS-NR state in the system.

The 15 Minute Measurements feature cannot be turned on when 30 minute measurements collection is in progress.

The Global Title Translation (GTT) feature must be turned on (using the **gtt=on** parameter for the **chg-feat** command ) before the Intelligent Network Application Part (INAP) Number-based Portability (INP) feature or the ANSI-41 INP Query (AINPQ) feature can be turned on.

Each provisioned Service Module card must have at least 4G memory before the AINPQ feature can be turned on.

The A-Port, G-Port, or IGM feature must be turned on before the MNP Circular Route Prevention feature can be turned on.

The G-Port feature requires Service Module cards running the **vsccp** application.

The GTT feature must be turned on before the G-Port feature can be turned on.

The SEAS Over IP feature must be enabled before it can be turned on.

The SEASCLI must be provisioned (see the **chg-seas-config** command) before the SEAS Over IP feature can be turned on.

At least one SEAS terminal must be configured (see the **chg-trm** command) before the SEAS Over IP feature can be turned on.

The IP address of at least one E5-IPSM card associated with a SEAS terminal must be configured before the SEAS Over IP feature can be turned on.

The IP User Interface feature must be turned on before the SEAS Over IP feature can be turned on.

The **login** and **hname** parameters must be provisioned (see the **chg-seas-config** command) before the SEAS Over IP feature can be turned on.

If the SEAS Over IP feature is turned on, then the IP User Interface feature cannot be turned off.

All card locations that correspond to SEAS terminals must be provisioned with E5-IPSM cards before the SEAS Over IP feature can be turned on.

The A-Port feature must be turned on before the MT-Based IS41 SMS NP feature can be turned on.

The G-Port feature must be turned on before the MT-Based GSM SMS NP feature can be turned on.

HIPR2 cards must be installed in all MUX locations before the HIPR2 High Rate Mode feature can be turned on.

The **defcc** system option (see the **chg-stpopts** command) must be provisioned before the IAR Base feature can be enabled and before the ATINP, MT-based GSM SMS NP, or MT-Based IS41 SMS NP feature can be turned on.

The **defmcc** GSM option (see the **chg-gsmopts** command) must be provisioned before the MT-Based GSM SMS NP feature can be turned on.

The MT-Based GSM SMS NP feature must be turned on before the MT-Based GSM MMS NP feature can be turned on.

The IDPRCDPN NPP service must be provisioned before the Prepaid IDP Query Relay feature can be turned on.

The **defcc** and **defndc** system options (see the **chg-stpopts** command) must be provisioned before the V-Flex feature can be turned on.

The EIR (Equipment Identity Register) feature cannot be turned on if the INP or AINPQ feature is turned on. The INP or AINPQ feature cannot be turned on if the EIR feature is turned on.

The Prepaid IDP Query Relay feature must be turned on before the IDPR ASD or IDPR GRN feature can be turned on.

The **matchseq=dn** parameter must be specified (see the **chg-tifopts** command) before the TIF GRN feature can be turned on.

The **matchseq=dn** parameter must be specified (see the **chg-tifopts** command) before the TIF ASD feature can be turned on.

The GTT LS ARI feature must be turned off before the IGTTLS feature can be turned off.

The **matchseq=dn** parameter must be specified (see the **chg-tifopts** command) before the TIF Number Substitution feature can be enabled.

If the **ansigflex=yes** system option is specified, then the IAR Base feature cannot be enabled.

The HIPR2 High Rate Mode feature status cannot be changed if an IMT Rate Change sequence is in progress.



The value specified for the **partnum** parameter must consist of 9 digits, without any dashes. The first three digits are **893**. The next six values are numeric (**0...9**).

### Notes

All terminals that are configured as SEAS are automatically allowed or inhibited when the SEAS Over IP feature is turned on or off, respectively.

***Commands blocked during IMT Rate Change sequence:***

If the HIPR2 High Rate Mode feature is turned on or off, then an IMT Rate change sequence is carried out (if required). The **act-upgrade**, **alw-imt**, **disc-imt**, **flash-card**, **inh-imt**, **init-flash**, **init-mux**, **init-sys**, and **tst-imt** commands cannot be entered if an IMT Rate Change sequence is in progress.

## Output

```

chg-ctrl-feat:partnum=893xxxxxx:status=on
tekelecstp 06-07-26 14:47:49 EST EAGLE 36.0.0
chg-ctrl-feat:partnum=893xxxxxx:status=on
Command entered at terminal #4.
CHG-CTRL-FEAT: MASP A - COMPLTD
;

chg-ctrl-feat:partnum=893xxxxxx:alarm=clear
tekelecstp 06-07-26 14:47:49 EST EAGLE 36.0.0
chg-ctrl-feat:partnum=893xxxxxx:alarm=clear
Command entered at terminal #4.
CHG-CTRL-FEAT: MASP A - COMPLTD
;

tekelecstp 06-07-26 14:47:49 EST EAGLE 36.0.0
0367.0181 * SYSTEM Temp Key(s) expiration alarm cleared.
;

```

The following example displays the output that results when the 1100 TPS/DSM for ITU NP feature is on, and the **chg-ctrl-feat** command is re-entered within 30 seconds for confirmation.

```

chg-ctrl-feat:partnum=893018001:status=on
tekelecstp 06-07-26 14:47:49 EST EAGLE 36.0.0
chg-ctrl-feat :partnum=893018001:status=on
Command entered at terminal #4.
CAUTION: Rated TPS for this feature supports an engineered GTT
traffic mix of no more than 70 percent EPAP-based traffic.
Re-enter the command within 30 seconds to confirm change.
CHG-CTRL-FEAT: MASP A - Command Aborted

```

Command is re-entered within 30 seconds

```

chg-ctrl-feat :partnum=893018001:status=on

```

```

tekelecstp 06-07-26 14:47:58 EST EAGLE 36.0.0
chg-ctrl-feat :partnum=893018001:status=on
Command entered at terminal #4.
CHG-CTRL-FEAT: MASP A - COMPLTD

```

The following example displays the output that results when the 1100 TPS/DSM for ITU NP feature is on, and the **chg-ctrl-feat** command is not re-entered within 30 seconds.

```

chg-ctrl-feat:partnum=893018001:status=on
tekelecstp 06-07-26 14:47:49 EST EAGLE 36.0.0
chg-ctrl-feat :partnum=893018001:status=on
Command entered at terminal #4.
CAUTION: Rated TPS for this feature supports an engineered GTT
traffic mix of no more than 70 percent EPAP-based traffic.
Re-enter the command within 30 seconds to confirm change.
CHG-CTRL-FEAT: MASP A - Command Aborted

```

Command is not re-entered within 30 seconds.  
CHG-CTRL-FEAT command aborted due to confirmation timeout.

The following example displays the output that results when the 1100 TPS/DSM for ITU NP feature is not on, and the **chg-ctrl-feat** command is re-entered within 30 seconds for confirmation.

```

chg-ctrl-feat:partnum=893018001:status=off
tekelecstp 06-07-26 14:47:49 EST EAGLE 36.0.0
chg-ctrl-feat :partnum=893018001:status=off
Command entered at terminal #4.
CAUTION: This command decreases the total TPS of the
SCCP system from 1100 to 850 TPS for each DSM.
Re-enter the command within 30 seconds to confirm.
CHG-CTRL-FEAT: MASP A - Command Aborted

```

Command is re-entered within 30 seconds

```
chg-ctrl-feat :partnum=893018001:status=off

tekelecstp 06-07-26 14:47:58 EST EAGLE 36.0.0
chg-ctrl-feat :partnum=893018001:status=off
Command entered at terminal #4.
CHG-CTRL-FEAT: MASP A - COMPLTD
```

**chg-db****Change Database**

Use this command to manipulate elements of the database.



**CAUTION:** When this command is entered, all other database operations are locked out while the command executes.



**CAUTION:** The cards that run both the active and standby OAM reboot whenever the restore operation completes successfully. When a database is repaired successfully, the card with the standby OAM reboots. This action purges old database data from memory and reloads the MASPs with the new data. When the card with the active OAM reboots, all terminals reinitialize, automatically logging off all users. Depending on the new database, the terminals may be initialized to a different configuration, and user IDs and passwords may change.

**Keyword:** chg-db

**Related Commands:** copy-meas, rept-stat-db

**Command Class:** System Maintenance

**Parameters**

**NOTE:** The removable cartridge is used with legacy MDAL cards. The removable drive is used with E5-MASP hardware.

**:action=** (mandatory)

The database management action.

**Range:** backup, repair, restore

**backup**— Copies the database from the current data partitions to the backup partitions on both fixed disks, the backup partition on the removable cartridge, the removable drive, or to a compressed tar file on a remote FTP server. If the destination is the server a database file with the following naming convention will be created: 'CLLI string' - 'Release number string' - 'yymmddhh'.tar.gz (tekelecstp-37.5.0-08012212.tar.gz)

**repair**— Copies the current and backup databases from the active to the standby fixed disk.

**restore**— Copies the backup partitions to the current data partitions on both fixed disks, or copies the database from the removable cartridge or drive, or the remote FTP server to the current partitions on both fixed disks.



**CAUTION:** The action=restore parameter initiates an emergency recovery procedure and requires the init-sys command to download the restored database to all the cards in the system.

**:dest=** (optional)

Destination. This parameter specifies the destination disk for the database backup.

**Range:** remove, fixed, server, usb

**remove**— Back up the database to a removable cartridge or drive

**fixed**— Back up the database to a fixed disk

**server**— Back up the database to a remote server

**usb**— Argument to be used by Tekelec personnel only.

**Default:** fixed

**:file=** (optional)

This parameter specifies the name of the TAR file on the remote server that contains the database to be restored to the system.

The **src=server** parameter must be specified before this parameter can be specified.

**Range:** yyy  
Up to 39 alphanumeric characters

**:sloc=** (optional)

Source location. This parameter specifies the location of the removable drive.

The **sloc** parameter can be used to specify a location in the active or standby E5-MASP.

**Range:** 1113, 1115

**Default:** location in the active E5-MASP

**:src=** (optional)

Source. This parameter specifies the source used to restore the database.

**Range:** remove, fixed, server, usb  
**remove** — Restore the database from a removable cartridge or drive  
**fixed** — Restore the database from the fixed disk  
**server** — Restore the database from a remote server  
**usb** — Argument to be used by Tekelec personnel only.

**Default:** fixed

**Example**

```
chg-db:action=backup:dest=server
chg-db:action=backup:dest=remove
chg-db:action=restore:src=fixed
chg-db:action=restore:src=remove
chg-db:action=repair
chg-
db:action=restore:src=server:file="CLLI-37.5.0-08012212.tar.gz"
```

**Dependencies**

The **chg-db** command cannot be entered while the system is in upgrade mode.

The removable drive must be accessible and ready and must be formatted as a system removable disk, NOT as a measurement removable disk.

The **dest** parameter can be specified only when **action=backup**. If the **dest=fixed** parameter is specified, or the **dest** parameter is not specified, the database on the current partition of the fixed disk is copied to the backup partition of the fixed disk. This action is shown in Figure 5-2.

**Figure 5-2.** The **chg-db:action=backup:dest=fixed** Command

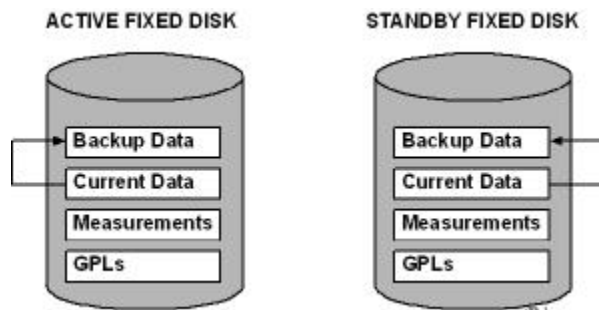

The current database partition of both fixed disks must be free of integrity violations (for example, incoherency, inconsistency, and data corruption) when **action=backup** is specified.

The **src** parameter can be used only when **action=restore**. To restore the database, if the **src=fixed** parameter is specified or the **src** parameter is not specified, the backup partition of each fixed disk is copied to the current partition of the fixed disk. This action is shown in Figure 5-3.

**Figure 5-3.** The **chg-db:action=restore:src=fixed** Command

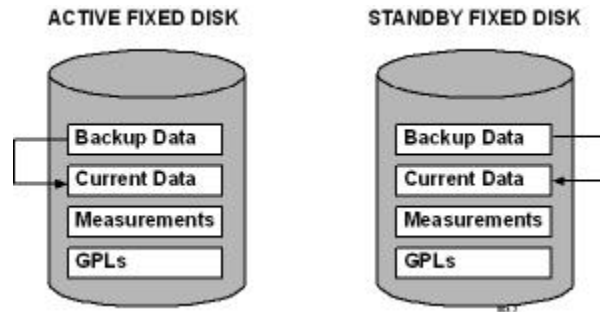

The backup database partition of both fixed disks must be coherent when **chg-db:action=restore:src=fixed** is specified.

The database on the removable cartridge or drive must be coherent when **action=restore:src=remove** is specified.

The current and backup database partitions of the active fixed disk must be free of integrity violations (for example, incoherency and data corruption) when **action=repair** is specified.

When the **action=repair/restore/repair** parameter is specified, the database(s) serving as the source of data for the operation must be free of integrity violations (for example, incoherency and data corruption).

All databases involved in the operation must contain a valid database version information.

The **action=restore** and **src=server** parameters must be specified before the **file** parameter can be specified. If the **src=server** parameter is specified, then the **file** parameter must be specified. The **action=restore** and **src=remove** parameters must be specified before the **sloc** parameter can be specified.

The DB application server must be provisioned (see the **ent-ftp-serv** command) before the **chg-db:action=backup:dest=server** or **chg-db:action=restore:src=server** command can be entered.

An E5-IPSM card must be provisioned before the **chg-db:action=restore:src=server** or **chg-db:action=backup:dest=server** commands can be entered.

The standby MASP must be in the Active state before the **chg-db** command can be entered.

If E5-MASP hardware is used for a restore procedure, and if the active and standby removable drives installed in the latched USB port have different DB levels, then the **sloc** parameter must be specified in the **chg-db:action=restore:src=remove** command to specify the removable drive to be used.

The value specified for the **file** parameter must have the correct extension.

A value of **1113** or **1115** must be specified for the **sloc** parameter.

## Notes

When the **chg-db** command is entered with the **action=backup** parameter, the following message appears when an audit is in progress:

```
Command In Progress: waiting for database audit to complete
```

The command executes when the audit is finished.

For **chg-db** command activities using the **backup**, **restore** and **repair** parameter values, the performance time varies depending on the number of records allocated for the database, system activity, and system setup. These operations should typically take no longer than 30 minutes. If one of these operations exceeds one hour, contact Tekelec Technical Services for assistance at (888) FOR-TKLC.

If the **dest=remove** parameter is specified on the GPSM-II card, the database on the current partition of the active fixed disk is copied to the removable cartridge in the MDAL. This action is shown in Figure 5-4.

**Figure 5-4.** The **chg-db:action=backup:dest=remove** Command

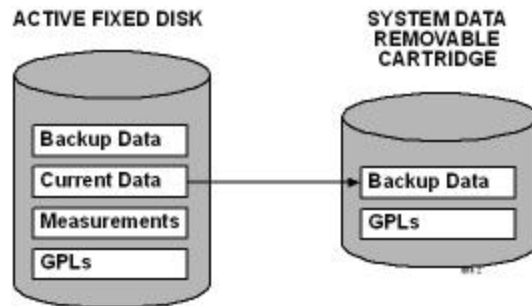

If the **chg-db:action=restore:src=server:filename=xxxxxx.tar** or **chg-db:action=backup:dest=server** command is entered, the database partitions are copied from or to the remote server application through an E5-IPSM card. This action is shown in Figure 5-5.

**Figure 5-5.** Remote Backup or Restore

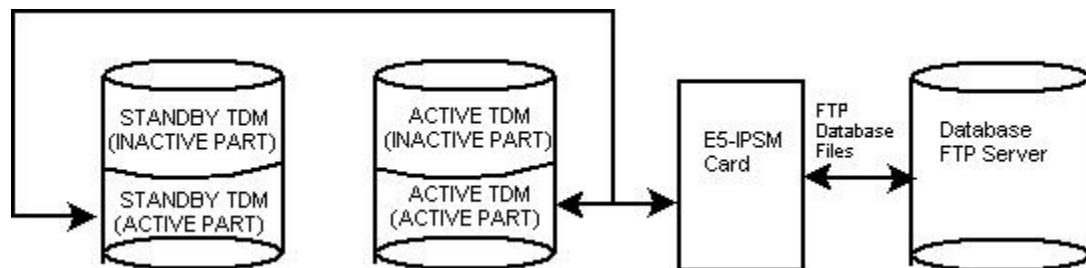

If the **action=repair** parameter is specified, the current and backup database partitions are copied from the active fixed disk to the standby fixed disk. This action is shown in Figure 5-6.

**Figure 5-6.** The **chg-db:action=repair** Command

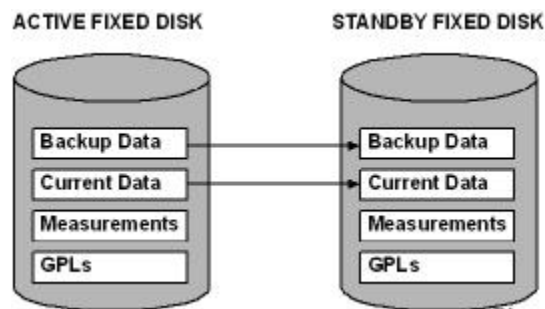

If the **src=remove** parameter is specified on the GPSM-II card, the database on the removable cartridge is copied to the current partitions on both the active and standby fixed disks. This action is shown in Figure 5-7.

Figure 5-7. The chg-db:action=restore:src=remove Command

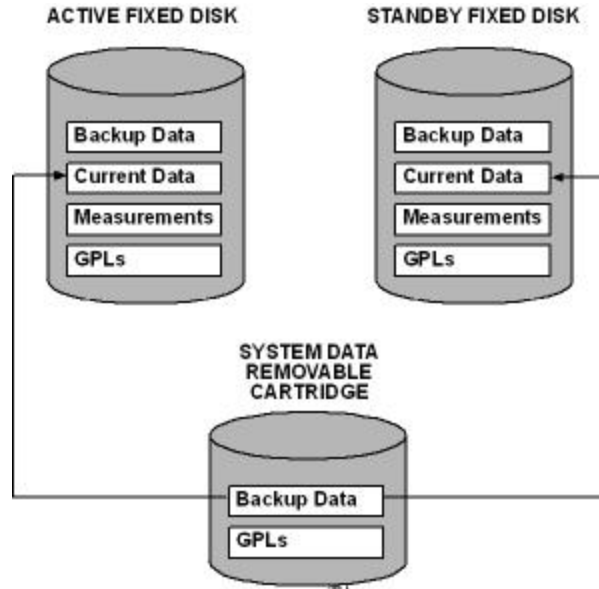

If the **action=restore** and **src=remove** parameters are specified on the E5-MASP hardware, the database of the removable drive (in the latched USB slot) is copied to the current partition of each fixed disk. The default is to use the removable drive in the active E5-MASP. The **sloc** parameter can be used to specify the removable drive in the active or standby E5-MASP.

If the **dest=remove** parameter is specified for an E5-MCAP card, the database on the current partition of each fixed disk is copied to the removable drive in both latched USB slots. If only the active OAM has a removable drive, then only the current partition on the active OAM is copied to the removable drive in the active OAM latched USB slot.

## Output

The output of the various actions of the **chg-db** command is shown in the following examples. Messages such as UIMs might appear at your terminal.

### **chg-db:action=backup**

```
BACKUP (FIXED): MASP B - Backup starts on active MASP.
BACKUP (FIXED): MASP B - Backup on active MASP to fixed disk complete.
BACKUP (FIXED): MASP B - Backup starts on standby MASP.
BACKUP (FIXED): Backup on standby MASP to fixed disk complete.
```

### **chg-db:action=restore**

```
RESTORE (FIXED): MASP A - Restore starts on active MASP.
RESTORE (FIXED): MASP A - Restore from fixed disk on active MASP complete.
RESTORE (FIXED): MASP A - Restore starts on standby MASP.
RESTORE (FIXED): MASP A - Restore from fixed disk on standby MASP complete.
RESTORE (FIXED): MASP A - MASP(s) will reboot to load data.
```

### **chg-db:action=backup:dest=remove**

```
BACKUP (REMOVABLE) : MASP A - Backup starts on active MASP.
BACKUP (REMOVABLE) : MASP A - Backup to removable cartridge complete.
```

### **chg-db:action=backup:dest=fixed**

```
BACKUP (FIXED) : MASP A - Backup starts on active MASP.
BACKUP (FIXED) : MASP A - Backup on active MASP to fixed disk complete.
BACKUP (FIXED) : MASP A - Backup starts on standby MASP.
BACKUP (FIXED) : MASP A - Backup on standby MASP to fixed disk complete.
```

### **chg-db:action=restore:src=remove**

```
RESTORE (REMOVABLE) : MASP A - Restore starts on active MASP.
RESTORE (REMOVABLE) : MASP A - Restore starts on standby MASP.
RESTORE (REMOVABLE) : MASP A - MASP(s) will reboot to load data.
RESTORE (REMOVABLE) : MASP A - Restore from removable cartridge complete.
```

### **chg-db:action=restore:src=fixed**

```
RESTORE (FIXED) : MASP A - Restore starts on active MASP.
RESTORE (FIXED) : MASP A - Restore from fixed disk on active MASP complete.
RESTORE (FIXED) : MASP A - Restore starts on standby MASP.
RESTORE (FIXED) : MASP A - MASP(s) will reboot to load data.
RESTORE (FIXED) : MASP A - Restore from fixed disk on stdby MASP complete.
```

### **chg-db:action=repair**

```
REPAIR: MASP A - Repair starts on standby MASP.
REPAIR: MASP A - Standby MASP will reboot to load data.
REPAIR: MASP A - Repair from fixed disk complete.
```

### **chg-db:action=backup:dest=server**

```
BACKUP (SERVER): MASP A - Backup starts on active MASP.
BACKUP (SERVER) : Copy Database to card memory for processing.
BACKUP (SERVER) : Compress Database before archiving.
BACKUP (SERVER) : Send database archive to server.
BACKUP (SERVER): MASP A - Backup to remote server complete.
```

### **chg-**

#### **db:action=restore:src=server:file="CLLI-37.5.0-08011112.tar.gz"**

```
RESTORE (SERVER) : Retrieve database archive from server.
RESTORE (SERVER) : Validate database archive.
RESTORE (SERVER) : Restore starts on active MASP.
RESTORE (SERVER) : Restore from server on active MASP complete.
RESTORE (SERVER) : Restore starts on standby MASP.
RESTORE (SERVER) : Restore from server on standby MASP complete.
RESTORE (SERVER) : MASP(s) will reboot to load data.
```



**chg-dstn****Change Destination**

Use this command to change the characteristics of the point codes that are considered destinations from this signal transfer point (STP). A destination does not have to be an adjacent signaling point, but the system must be able to route traffic to this destination.

**Keyword:** **chg-dstn**

**Related Commands:** **, dlt-dstn, dlt-rte, ent-dstn, ent-rte, rept-stat-dstn, rept-stat-rte, rtrv-dstn, rtrv-rte**

**Command Class:** Database Administration

**Parameters**

**NOTE:** See "Point Code Formats and Conversion" for a detailed description of point code formats, rules for specification, and examples.

**:dpc=** (mandatory)

ANSI destination point code with subfields *network indicator-network cluster-network cluster member (ni-nc-ncm)*. The *prefix* subfield indicates a private point code (*prefix-ni-nc-ncm*).

**Synonym:** **dpc**

**Range:** **p-, 000-255, \***

Specify a valid value for each subfield of the point code, and separate the subfields with a dash (-).

*prefix*—**p-**

The asterisk value (\*) is not valid for the *ni* subfield.

When **chg-sid:pctype=ansi** is specified, *ni* = **000** is not valid.

When **chg-sid:pctype=ansi** is specified, *nc* = **000** is not valid if *ni* = **001-005**.

When **chg-sid:pctype=ansi** is specified, *nc* = **000** is valid if *ni* = **006-255**.

The point code **000-000-000** is not a valid point code.

**:dpc/dpca/dpci/dpcn/dpcn24=** (mandatory)

Destination point code.

**:dpci=** (mandatory)

ITU international destination point code with subfields *zone-area-id*. The *prefix* subfield indicates a spare point code, private point code, or private and spare point code (*prefix-zone-area-id*).

**Range:** **s-, p-, ps-, 0-255**

Specify a valid value for each subfield of the point code, and separate the subfields with a dash (-).

*prefix*—**s-, p-, ps-**

*zone*—**0-7**

*area*—**000-255**

*id*—**0-7**

The point code **0-000-0** is not a valid point code.

**:dpcn=** (mandatory)

ITU national destination point code in the format of a 5-digit number (*nnnnn*); or 2, 3, or 4 numbers (members) separated by dashes (*m1-m2-m3-m4*) as defined by the **chg-stpopts:npcfnti** flexible point code option. A group code must be specified when the ITUDUPPC feature is turned on (*nnnnn-gc, m1-m2-m3-m4-gc*). The *prefix* subfield indicates a spare point code, private point code, or private and spare point code (*prefix-nnnnn, prefix-nnnnn-gc, prefix-m1-m2-m3-m4, prefix-m1-m2-m3-m4-gc*).

**Range:** **s-, p-, ps-, 0-16383, aa-zz**  
 Specify a valid value for each subfield of the point code, and separate the subfields with a dash (-).  
*prefix*—**s-, p-, ps-**  
*nnnnn*—**0-16383**  
*gc*—**aa-zz**  
*m1-m2-m3-m4*—**0-14** for each member; values must sum to 14

**:dpcn24=** (mandatory)

24-bit ITU national destination point code with subfields *main signaling area-sub signaling area-signaling point (msa-ssa-sp)*. The *prefix* subfield indicates a private point code (*prefix-msa-ssa-sp*).

**Range:** **p-, 000-255**  
 Specify a valid value for each subfield of the point code, and separate the subfields with a dash (-).  
*prefix*—**p-**  
*msa*—**000-255**  
*ssa*—**000-255**  
*sp*—**000-255**

**:aliasa=** (optional)

ANSI destination point code with subfields *network indicator-network cluster-network cluster member (ni-nc-ncm)*.

**Range:** **000-255, none**  
 Specify a valid value for each subfield of the point code, and separate the subfields with a dash (-).  
 When **chg-sid:pctype=ansi** is specified, *ni* = **000** is not valid.  
 When **chg-sid:pctype=ansi** is specified, *nc* = **000** is not valid if *ni* = **001-005**.  
 When **chg-sid:pctype=ansi** is specified, *nc* = **000** is valid if *ni* = **006-255**.  
 Enter **none** to delete the point code.  
 The point code **000-000-000** is not a valid point code.

**:aliasa/aliasi/aliasn/aliasn24=** (optional)

Alias point code.

**:aliasi=** (optional)

ITU international alias point code list with subfields *zone-area-id*. The *prefix* subfield indicates a spare point code (*prefix-zone-area-id*).

If an ITU international destination (**dpcci**) point code is entered, the **dpcci** and **aliasi** *prefix* subfields cannot be the same, (both spare or both non-spare). Up to 2 comma-delimited entries can be entered in the point code list.

**Range:** **s-, 0-255, none**  
 Specify a valid value for each subfield of the point code, and separate the subfields with a dash (-).  
*prefix*—**s-**  
*zone*—**0-7**  
*area*—**000-255**  
*id*—**0-7**  
 Enter **none** to delete the point code.  
 The point code **0-000-0** is not a valid point code.

**:aliasn=** (optional)

ITU national alias point code list in the format of a 5-digit number (*nnnnn*); or 2, 3, or 4 numbers (members) separated by dashes (*m1-m2-m3-m4*) as defined by the **chg-stpopts:npfnti** flexible point code option. A group code must be specified when the ITUDUPPC feature is turned on (*nnnnn-gc*, *m1-m2-m3-m4-gc*). The *prefix* subfield indicates a spare point code (*prefix-nnnnn*, *prefix-nnnnn-gc*, *prefix-m1-m2-m3-m4*, *prefix-m1-m2-m3-m4-gc*).

If an ITU national destination (**dpcn**) point code is entered, then the **dpcn** and **aliasn** *prefix* subfields cannot be the same (both spare or both non-spare). Up to 2 comma-delimited entries can be entered in the point code list.

**Range:** **s-, 0-16383, aa-zz, none**

Specify a valid value for each subfield of the point code, and separate the subfields with a dash (-).

*prefix*—**s-**

*nnnnn*—**0-16383**

*gc*—**aa-zz**

*m1-m2-m3-m4*—**0-14** for each member; values must sum to 14

Enter **none** to delete the point code.

**:aliasn24=** (optional)

24-bit ITU national destination point code with subfields *main signaling area-sub signaling area-signaling point* (*msa-ssa-sp*).

**Range:** **000-255, none**

Specify a valid value for each subfield of the point code, and separate the subfields with a dash (-).

*msa*—**000-255**

*ssa*—**000-255**

*sp*—**000-255**

Enter **none** to delete the point code.

**:bei=** (optional)

Broadcast exception indicator. This parameter specifies whether the STP broadcasts network management messages to adjacent signaling points. The network management messages contain information about the indicated cluster and any of that cluster's member signaling points that are on its exception list. The messages whose broadcast is determined by this parameter are:

- TFP—Transfer Prohibited
- TCP—Transfer Cluster Prohibited
- TFA—Transfer Allowed
- TCA—Transfer Cluster Allowed

**Range:** **yes, no**

**yes**— Network management messages are not broadcast

**no**— Network management messages are broadcast

**Default:** No change to the current value

**:cli=** (optional)

The Common Language Location Identifier assigned to this destination.

**Range:** *ayyyyyyyyyy*

1 alphabetic character followed by 10 alphanumeric characters

**Default:** No change to the current value

**:elei=** (optional)

Exception-list exclusion indicator, for cluster destinations only. This parameter specifies whether the system *excludes* or *includes (maintains)* a dynamic status exception list (x-list) for each cluster route used to reach the member signaling points that make up the cluster.

**Range:**     **yes, no**  
               **yes** — Do not maintain a dynamic status x-list  
               **no** — Maintain a dynamic status x-list

**Default:**    No change to current value.

**:homescp=** (optional)

This parameter specifies whether the destination point code (DPC) is considered a Home SCP when performing SCCP processing for messages with no Global Title Address Digits (Global Title Indicator (GTI) is set to zero).

This parameter can only be set to "yes" for full DPCs.

**Range:**     **yes, no**  
               **yes** — the DPC is considered a Home SCP  
               **no** — the DPC is not considered a Home SCP

**Default:**    No change to the current value

**:homesmsc=** (optional)

This parameter specifies whether the DPC is considered a Home SMSC when performing SCCP processing for messages with no Global Title Address Digits (GTI is set to zero).

This parameter can only be set to "yes" for full DPCs.

**Range:**     **yes, no**  
               **yes** — the DPC is considered a Home SMSC  
               **no** — the DPC is not considered a Home SMSC

**Default:**    No change to the current value

**:ncai=** (optional)

Nested cluster allowed indicator. Specifies whether the route to the cluster point code can be different for provisioned members of the cluster. A point code is a member of a cluster point code if it has the same network identifier (NI) and network cluster (NC) values as the cluster point code. This parameter can only be specified for cluster point codes. Nested cluster routing is allowed if this parameter is set to **yes** and the CRMD and NCR features are turned on.

**Range:**     **yes, no**  
               **yes** — The cluster point code is a nested cluster point code. Point codes that are members of this cluster point code can be assigned to route sets that are different from the route set assigned to the cluster point code.  
               **no** — The cluster point code is not a nested cluster point code. Point codes that are members of this cluster point code must be assigned to the same route set assigned to the cluster point code.

**Default:**    Current value.

**:nprst=** (optional)

NM bits reset. This parameter specifies whether the NM bits should be set to **00**.

This parameter applies only to ITU IAM messages. The **nptype=nm** parameter must be specified (see the **chg-tifo** command) before this parameter can be specified.

**Range:**     **off, on**  
               **off** — Do not set NM Bits to 00 in ITU IAM message if TIFOPTS **nptype** option value is **nm**  
               **on** — Set NM Bits to 00 in ITU IAM message if TIFOPTS **nptype** option value is **nm**

**Default:** No change to the current value

**:prx=** (optional)

Proxy point code indicator. This parameter specifies whether a destination point code is used as a proxy point code.

**Range:** **yes, no**

**yes**— The destination point code is used as a proxy point code.

**no**— The destination point code is not used as a proxy point code.

**Default:** No change in current value.

**:rcause=** (optional)

Release cause. This parameter specifies the value to be used as the release cause on REL messages. If the TIFOPTS **rlcopc** parameter is specified (see the **chg-tifo** command), and a value of **0-127** is specified for the **rcause** parameter, then the **rcause** parameter value overrides the values specified for the TIFOPTS **rcausenp** and **rcausepfx** parameters.

**Range:** **0-127, none**

**none**—use the values specified for the TIFOPTS **rcausenp** and **rcausepfx** parameters

**Default:** No change to the current value

**:spc=** (optional)

ANSI secondary point code with subfields *network indicator-network cluster-network cluster member (ni-nc-ncm)*. The *prefix* subfield indicates a private point code (*prefix-ni-nc-ncm*).

**Synonym:** **spca**

**Range:** **p-, 000-255, none**

Specify a valid value for each subfield of the point code, and separate the subfields with a dash (-).

*prefix*—**p-**

When **chg-sid:pctype=ansi** is specified, **ni = 000** is not valid.

When **chg-sid:pctype=ansi** is specified, **nc = 000** is not valid for **ni = 001-005**.

When **chg-sid:pctype=ansi** is specified, **nc = 000** is valid if **ni = 006-255**.

Enter **none** to delete the point code.

The point code **000-000-000** is not a valid point code.

**Default:** No change to current value

**:spc/spca/spci/spcn/spcn24=** (optional)

Secondary point code.

**:spci=** (optional)

ITU international secondary point code with subfields *zone-area-id*. The *prefix* subfield indicates a spare point code, private point code, or private and spare point code (*prefix-zone-area-id*).

**Range:** **s-, p-, ps-, 0-255, none**

Specify a valid value for each subfield of the point code, and separate the subfields with a dash (-).

*prefix*—**s-, p-, ps-**

*zone*—**0-7**

*area*—**000-255**

*id*—**0-7**

The point code **0-000-0** is not a valid point code.

Enter **none** to delete the point code.

**Default:** No change to current value

**:spcn=** (optional)

ITU national secondary point code in the format of a 5-digit number (*nnnnn*); or 2, 3, or 4 numbers (members) separated by dashes (*m1-m2-m3-m4*) as defined by the **chg-stpopts:npcfmti** flexible point code option. A group code must be specified when the ITUDUPPC feature is turned on (*nnnnn-gc*, *m1-m2-m3-m4-gc*). The *prefix* subfield indicates a spare point code, private point code, or private and spare point code (*prefix-nnnnn*, *prefix-nnnnn-gc*, *prefix-m1-m2-m3-m4*, *prefix-m1-m2-m3-m4-gc*).

**Range:** **s-, p-, ps-, 0-16383, aa-zz, none**

Specify a valid value for each subfield of the point code, and separate the subfields with a dash (-).

*prefix*—**s-, p-, ps-**

*nnnnn*—**0-16383**

*gc*—**aa-zz**

*m1-m2-m3-m4*—**0-14** for each member; values must sum to 14

Enter **none** to delete the point code.

**Default:** No change to current value

**:spcn24=** (optional)

24-bit ITU national secondary point code with subfields *main signaling area-sub signaling area-signaling point* (*msa-ssa-sp*). The *prefix* subfield indicates a private point code (*prefix-msa-ssa-sp*).

**Range:** **p-, 000-255, none**

Specify a valid value for each subfield of the point code, and separate the subfields with a dash (-).

*prefix*—**p-**

*msa*—**000-255**

*ssa*—**000-255**

*sp*—**000-255**

Enter **none** to delete the point code.

**Default:** No change to current value

**:splitiam=** (optional)

This parameter specifies when and how to split an ITU IAM message into 1 IAM message + 1 SAM message.

This parameter applies only to ITU IAM messages.

**Range:** **15-31, none**

**15-31**—Maximum number of CdPN digits allowed in the IAM message before splitting occurs. The remaining digits, up to a total of 32, are encoded in the SAM message.

**none**—use the value specified for the TIFOPTS **splitiam** parameter to determine when to split the IAM message

**Default:** No change to the current value

**Example**

To change the cli of destination 111-222-111 to rlghncxa01a:

```
chg-dstn:dpc=111-222-111:clli=rlghncxa01a
```

To change the exception-list exclusion indicator for cluster 20-2-\* to yes:

```
chg-dstn:dpca=20-2-*:elei=yes
```

To change an existing destination to contain an SPC:

```
chg-dstn:dpc=20-2-2:spc=5-5-5
```

To change Nested Cluster Allowed Indicator for cluster 20-2-\* to yes:

```
chg-dstn:dpc=20-2-*:ncai=yes
```

To change a network destination:

```
chg-dstn:dpc=25-*-*:clli=tklc
```

To change the bei parameter value of ITU national destination 8111-aa to yes:

```
chg-dstn:dpcn=8111-aa:bei=yes
```

To change the bei parameter value of 24-bit ITU-N destination 15-100-10 to yes:

```
chg-dstn:dpcn24=15-100-10:bei=yes
```

To change an existing 24-bit ITU-N destination to contain a 24-bit ITU-N SPC:

```
chg-dstn:dpcn24=12-12-12:spcn24=25-25-25
```

To change ITU-I spare destination point code s-2-100-1 to contain an ITU-I spare secondary point code, ANSI alias, and ITU-N spare alias:

```
chg-  
dstn:dpci=s-2-100-1:spci=s-2-129-9:aliasa=121-120-120:aliasn=s-12  
9
```

To prevent a destination point code from being used as a proxy point code:

```
chg-dstn:dpc=11-11-11:prx=no
```

To change ITU-N destination point code 10805-nz to delete its ANSI alias and add both ITU-I spare and non-spare aliases:

```
chg-dstn:dpcn=10805-nz:aliasa=none:aliasi=s-5-80-0,5-80-1
```

To change ITU-I spare destination point code s-5-60-3 to add ITU-N non-spare and spare aliases:

```
chg-dstn:dpci=s-5-60-3:aliasn=10723-gr,s-10723-gr
```

To change ITU-I spare destination point code s-5-60-5 to add ITU-N spare and ITU-I non-spare aliases:

```
chg-dstn:dpci=s-5-60-5:aliasn=s-10725-gr:aliasi=5-60-5
```

## Dependencies

**NOTE:** *A full point code contains numerical values for all three segments of the point code.*

At least one optional parameter must be specified.

The specified destination point code value must already be defined in the Destination point code table.

The destination address must be a full point code, a network destination, or a cluster point code.

The ANSI self-ID destination point code for the STP must be defined before ANSI destinations can be changed.

The ITU-I self-ID destination point code for the STP must be defined before ITU-I destinations can be changed.

The ITU-N self-ID destination point code for the STP must be defined before ITU-N destinations can be changed.

The Spare Point Code Support feature must be enabled before the spare point code prefix **s-** can be specified for an ITU-I or ITU-N destination, secondary, or alias point code.

If the **dpcn** or **aliasn** parameter is specified, the format must match the format that was assigned with the **chg-stpopts:npcfmti** parameter.

When the 7000 Routesets or 8000 Routesets feature quantity is enabled, the total number of provisioned aliases in the system cannot exceed 8000.

Alias point codes are allowed only for full point code destinations.

Alias point codes for destinations must be full point codes.

A specified alias type cannot already be defined as a destination address. The **aliasa** and **dpca** parameters cannot be specified together in the command. The **aliasi** and **dpci** parameters and the **aliasn** and **dpn** parameters cannot be specified together in the command if the *prefix* subfields are the same (both are spare or both are non-spare).

Alias ANSI point codes cannot be members of a cluster or network destination.

The specified alias network type must be different from the destination point code network type.

A 24-bit ITU-N point code cannot have a 14-bit ITU-N alias point code or an ANSI alias point code.

A 24-bit ITU-National point code can have an ITU-I point code alias. This allows conversion of 14-bit ITU-I routing label to 24-bit routing label and vice versa.

A 14-bit ITU-N point code cannot have a 24-bit ITU-N alias point code.

If an ITU-I point code is specified, either the **aliasn** or the **aliasn24** parameter can be specified, but not both.

Cluster destinations are allowed only if the CRMD feature is turned on.

The **ncai** parameter can be specified only for cluster destinations.

The **elei** parameter can be specified only for cluster destinations (for example, **dpca=ni-nc-\***).

The NCR (Nested Cluster Routing) feature must be turned on before the **ncai** parameter can be specified.

Network routing is valid only if the Network Routing (NRT) feature is turned on.

When using network routing, if the destination point code has a value of \* in the *nc* subfield, the *ncm* subfield must also be \* (for example, **dpca=21-\*-\***).

If a provisioned nested cluster point code is being changed to a non-nested cluster point code (**ncai=no**), previously provisioned members of the cluster must have the same route set.

If a provisioned non-nested cluster point code is being changed to a nested cluster point code (**ncai=yes**), the maximum number of provisioned nested clusters must be no greater than 500.

If specified, the **spc** parameter value must be already be configured as a secondary point code in the Secondary Point Code table.

The value specified for the **spc** parameter must be a full point code.

If the **spc** parameter is specified, the **domain=ss7** parameter must be specified.

If the **spc** parameter is specified, then the value specified for the **dpc** parameter must be a full point code.

The network type of the value specified for the **spc** parameter must match the network type of the value specified for the **dpc** parameter.

If a new **clli** for the destination point code is specified, it cannot match the **clli** of the system.

If the corresponding destination for the specified destination point code is an adjacent signaling point (matched a Far End point code in its linkset entity set), the **clli** of the specified destination point code cannot be assigned to any other destination address.

Alias point codes are supported only for destinations in the SS7 domain (**domain=ss7**).

A reserved word cannot be specified for the destination identifier (**clli**).

If the destination does *not* use an SPC, the group code of the destination must be the same as the group code of the ITU national true point code. If the destination uses an SPC, then the group code of the destination must match the group code of the SPC.



If an ITU national destination is being changed and the ITUDUPPC feature is turned on, this applies depending on whether the destination uses an SPC (secondary point code). For example, if the ITU national true point code has a group code of **ee**, then destinations with group codes of **ee** can be added without using an SPC. Destinations with a group code of **ff**, however, must use an SPC with a group code of **ff**.

ICNP feature must be enabled and turned on in order to specify the **icnpxlat**, **cgpafmt**, and **cdpafmt** parameters.

Alias point codes cannot already be defined as another destination.

The value specified for the **spc** parameter cannot already be specified as a secondary point code for the destination point code.

The Proxy Point Code feature must be enabled before the **prx** parameter can be specified.

If the **prx=yes** parameter is specified, then the value of the **dpc** parameter must be a full point code.

If the value of the **dpc** parameter is used as a proxy point code, then the **prx=no** parameter cannot be specified.

The number of proxy destinations cannot exceed the value allowed by the enabled Proxy Point Code quantity feature.

If the **prx=yes** parameter is specified, then the **spc/spca/spci/spcn/spcn24** parameter cannot be specified.

If the value specified for the **dpc** parameter is a private point code, then the **prx=yes** parameter cannot be specified.

The total number of proxy destinations cannot exceed the total capacity (100) of the Proxy Point Code feature.

If an IPGW linkset is used, then the **prx=yes** parameter cannot be specified.

The network type of the routeset must be the same as the network type of the destination point code. For example, a destination point code with an ANSI network type cannot use a routeset with an ITU network type.

If the specified destination point code is assigned a proxy point code (PPC) in the DSTN table, then the specified routeset must contain a linkset for the destination point code, and the PPC of the linkset must be equal to the PPC of the destination point code.

The value specified for the **spc** parameter must differ from the secondary point code of the destination/route entry specified by the **dpc** parameter.

The value specified for the **ncai** parameter cannot be same as the NCAI that is already assigned to the destination point code.

If the specified destination point code is a cluster or network destination point code, then the specified routeset cannot contain a route over proxy linksets.

If the destination point code and adjacent point code of the routes in the specified routeset are ITU point codes, then the following conditions must apply.

- If one point code is an ITUI point code, and the other is a ITUN or ITUN24 point code, then the network type of the secondary adjacent point code must match the network type of the destination point code.
- If both point codes have the same network type, then either both must be spare point codes or both must not be spare point codes.
- If the destination point code is a ITUN point code, and the ITUDUPC feature is turned on, then the group code of the destination point code must match the adjacent or the secondary adjacent point code.

A maximum of two aliases can be specified per destination.

If the **dpci** parameter is specified, then a combination of ITUI and ANSI aliases cannot be specified. If the **dpcn** parameter is specified, then a combination of ITUN and ANSI aliases cannot be specified.

Two ITUI or two ITUN aliases can be specified for the same destination point code only if the aliases have different prefixes. One alias must be spare and one non-spare.

The TIF Number Portability feature must be enabled before the **rcause** or **nprst** parameter can be specified.

A TIF feature must be enabled before the **splitiam** parameter can be specified.

**Notes**

The **domain** parameter of a destination (see the **ent-dstn** command) cannot be changed with this command. To change the **domain** parameter, the destination must be removed with the **dlt-dstn** command and re-entered with the **ent-dstn** command.

In this command, only ITU-international and ITU national point codes and aliases support the spare point code subtype prefix (**s-**). Only ITU-international and ITU national point codes support the private and spare point code subtype prefix (**ps-**). All of the point code types support the private (internal) point code subtype prefix (**p-**). Aliases do not support the private (internal) point code prefix.

The value specified for the **dpc** parameter must be a full point code in order to be used as a proxy point code. Cluster point codes and private point codes cannot be used as proxy point codes.

Invalid usage of **none** with **aliasi** and **aliasn**:

- **alias=none,none** parser code expects **none** to be the last argument
- **alias=none,pointcode** parser code expects **none** to be the last argument
- **alias=,pointcode** invalid usage of comman separator

*Alias Combination Matrix*

**Table 5-8.** Alias Combination Matrix

destination	specified			result	
	aliasN	aliasI	aliasA	alias1	alias2
ANSI		none		0	
		pci		pci	
	none				0
	pcn				pcn
	pcn24				pcn24
	none	none		0	0
	none	pci		pci	0
	pcn	none		0	pcn
	pcn24	none		0	pcn24

**Table 5-8. Alias Combination Matrix**

	specified			result	
	pcn	pci		pci	pcn
	pcn24	pci		pci	pcn24
ITUI			none	0a	
			pca	pca	
		none		0i	
		pci		pci	
		none	none	0a,i	
		none	pca	pca	
		pci	none	pci	
		pci	pca	E5074	
		none		0n	0
		pcn		0n	pcn
		pcn, none		0n	pcn
		pcn1, pcn2		pcn2	pcn1
		pcn24			pcn24
		none	none	0a,n	0
		none	pca	pca	0
		pcn	none	0a,n	pcn
		pcn	pca	pca	pcn
		pcn, none	none	0a,n	0
		pcn, none	pca	0a,n	pcn
		pcn1, pcn2	none	pcn1	pcn2
		pcn1, pcn2	pca	E5001	
		pcn24	none	0a	pcn24
		pcn24	pca	pca	pcn24
		none	none	0i,n	0
		none	pci	pci	0
		pcn	none	0i,n	pcn

**Table 5-8.** Alias Combination Matrix

	specified			result	
	pcn	pci		pci	pcn
	pcn, none	none		0i,n	pcn
	pcn, none	pci		pci	pcn
	pcn1, pcn2	none		pcn2	pcn1
	pcn1, pcn2	pci		E5001	
	pcn24	none		0i	pcn24
	pcn24	pci		pci	pcn24
	none	none	none	0a,i,n	0
	none	none	pca	pca	0
	none	pci	none	pci	0
	none	pci	pca	E5074	
	pcn	none	none	0a,i,n	pcn
	pcn	none	pca	pca	pcn
	pcn	pci	none	pci	pcn
	pcn	pci	pca	E5001	
	pcn, none	none	none	0a,i,n	pcn
	pcn, none	none	pca	pca	pcn
	pcn, none	pci	none	pci	pcn
	pcn, none	pci	pca	E5001	
	pcn2, pcn1	none	none	pcn2	pcn1
	pcn2, pcn1	none	pca	E5001	
	pcn2, pcn1	pci	none	E5001	
	pcn2, pcn1	pci	pca	E5001	
	pcn24	none	none	0a,i	pcn24
	pcn24	none	pca	pca	pcn
	pcn24	pci	none	pca	pcn
	pcn24	pci	pca	E5001	
ITUN			none	0a	

**Table 5-8. Alias Combination Matrix**

specified			result	
		pca	pca	
	none			0
	pci			pci
	pci, none		0i	pci
	pci1, pci2		pci2	pci1
	none	none	0a,i	0
	none	pca	pca	0
	pci	none	0a	pci
	pci	pca	pca	pci
	pci, none	none	0,a,i	pci
	pci, none	pca	pca	pci
	pci1, pci2	none	pci2	pci1
	pci1, pci2	pca	E5001	
none			0n	
pcn			pcn	
pcn24			pcn24	
none		none	0,a,n	
none		pca	pca	
pcn		none	pcn	
pcn		pca	E5074	
pcn24		none	pcn24	
pcn24		pca	E5074	
none	none		0,i,n	0
none	pci		0,i,n	pci
none	pci, none		0,i,n	pci
none	pci1, pci2		pci2	pci1
pcn	none		pcn	0
pcn	pci		pcn	pci

**Table 5-8.** Alias Combination Matrix

specified			result	
pcn	pci, none		pcn	pci
pcn	pci1, pci2		E5001	
pcn24	none		pcn24	0
pcn24	pci		pcn24	pci
pcn24	pci	none	pcn24	pci
pcn24	pci1, pci2		E5001	
none	none	none	0a,i,n	0
none	none	pca	pca	0
none	pci	none	0a,i,n	pci
none	pci	pca	pca	pci
none	pci, none	none	0a,i,n	0
none	pci, none	pca	pca	pci
none	pci, pci2	none	pci2	pci1
none	pci, pci2	pca	E5001	
pcn	none	none	pcn	0
pcn	none	pca	E5074	
pcn	pci	none	pcn	pci
pcn	pci	pca	E5001	
pcn	pci, none	none	pcn	pci
pcn	pci, none	pca	E5001	
pcn	pci1, pci2	none	E5001	
pcn	pci1, pci2	pca	E5001	
pcn24	none	none	pcn24	0
pcn24	none	pca	E5074	
pcn24	pci	none	pcn24	pci
pcn24	pci	pca	E5001	
pcn24	pci, none	none	pcn24	pci
pcn24	pci, none	pca	E5001	

**Table 5-8. Alias Combination Matrix**

	specified			result	
	pcn24	pci1, pci2	none	E5001	
	pcn24	pci1, pci2	pca	E5001	
ITUN24			none	0	
			pca	pca	
		none			none
		pci			pci
		none	none	0	0
		none	pca	pca	0
		pci	none	0	pci
		pci	pca	pca	pci

Legend:

**0**—clear alias if provisioned regardless of its pointcode type

**0A**—clear alias if provisioned and pointcode is ANSI

**0I**—clear alias if provisioned and pointcode is ITUI

**0N**—clear alias if provisioned and pointcode is ITUN

**0A,I**—clear alias if provisioned and pointcode is ANSI or ITUI

**0A,N**—clear alias if provisioned and pointcode is ANSI or ITUN

**0I,N**—clear alias if provisioned and pointcode is ITUI or ITUN

**0A,I,N**—clear alias if provisioned and pointcode is ANSI or ITUI or ITUN

**Output**

The following example shows the display of the destination memory space accounting command completion response with the NCR, NRT, and CRMD features off (disabled) and all Routes and Routesets features off (disabled):

```
chg-dstn:dpca=111-222-111:aliasn=321
rlghncxa03w 04-08-17 15:35:05 EST EAGLE 31.8.0
Destination table is (10 of 2000) 1% full
Destination table is (10 of 2000) 1% full
Alias table is (8 of 12000) 1% full
CHG-DSTN: MASP A - COMPLTD
;
```

The following example shows the display of the destination memory space accounting command completion response with the NCR, NRT, and CRMD features off (disabled) and the 5000 Routes feature on:

```
chg-dstn:dpca=111-222-111:aliasn=321
rlghncxa03w 04-08-18 08:29:15 EST EAGLE 31.8.0
Destination table is (10 of 5000) 1% full
Alias table is (8 of 12000) 1% full
CHG-DSTN: MASP A - COMPLTD
;
```

The following example shows the display of the destination memory space accounting command completion response with one or more of the NCR, NRT, or CRMD features on and the DSTN5000 (5000 Routes) feature on:

```
chg-dstn:dpca=111-222-111:aliasn=321
rlghncxa03w 04-08-18 08:29:15 EST EAGLE 31.8.0
DESTINATION ENTRIES ALLOCATED: 5000
  FULL DPC(s): 9
  NETWORK DPC(s): 0
  CLUSTER DPC(s): 1
  TOTAL DPC(s): 10
  CAPACITY (% FULL): 1%
ALIASES ALLOCATED: 12000
  ALIASES USED: 8
  CAPACITY (% FULL): 1%
X-LIST ENTRIES ALLOCATED: 500
CHG-DSTN: MASP A - COMPLTD
;
```

The following example shows the display of the destination memory space accounting command completion response with the NCR, NRT, and CRMD features off (disabled) and the 6000 Routesets feature on:

```
chg-dstn:dpca=111-222-111:aliasn=321
rlghncxa03w 04-08-18 08:29:15 EST EAGLE 31.8.0
Destination table is (60 of 6000) 1% full
Alias table is (8 of 12000) 1% full
CHG-DSTN: MASP A - COMPLTD
;
```

The following example shows the display of the destination memory space accounting command completion response with one or more of the NCR, NRT, or CRMD features and the 6000 Routesets feature on:

```
chg-dstn:dpca=111-222-111:aliasn=321
rlghncxa03w 04-08-18 08:29:15 EST EAGLE 31.8.0
DESTINATION ENTRIES ALLOCATED: 6000
```



```

FULL DPC(s):                46
NETWORK DPC(s):             1
CLUSTER DPC(s):             1
TOTAL DPC(s):               12
CAPACITY (% FULL):         1%
ALIASES ALLOCATED:          12000
ALIASES USED:                8
CAPACITY (% FULL):         1%
X-LIST ENTRIES ALLOCATED:   500
CHG-DSTN: MASP A - COMPLTD

```

;

The following example shows the display of the destination memory space accounting command completion response with the NCR, NRT, and CRMD features off (disabled). When the 7000 Routesets quantity feature is on, the Destination table line shows "...of 7000" as it appears in the example. When the 8000 Routesets quantity feature is on, the Destination table line shows "...of 8000."

```

chg-dstn:dPCA=111-222-111:aliasn=321
rlghncxa03w 04-08-18 08:29:15 EST EAGLE 31.8.0
Destination table is (60 of 7000) 1% full
Alias table is (8 of 8000) 1% full
CHG-DSTN: MASP A - COMPLTD

```

;

The following example shows the display of the destination memory space accounting command completion response with one or more of the NCR, NRT, or CRMD features on: When the 7000 Routesets quantity feature is on, the DESTINATION ENTRIES ALLOCATED line shows "8000" as it appears in the example. When the 7000 Routesets quantity feature is on, the DESTINATION ENTRIES ALLOCATED line shows "7000."

```

chg-dstn:dPCA=111-222-111:aliasn=321
rlghncxa03w 04-08-18 08:29:15 EST EAGLE 31.8.0
DESTINATION ENTRIES ALLOCATED: 8000
FULL DPC(s):                   9
NETWORK DPC(s):                 0
CLUSTER DPC(s):                 1
TOTAL DPC(s):                   10
CAPACITY (% FULL):              1%
ALIASES ALLOCATED:              8000
ALIASES USED:                    8
CAPACITY (% FULL):              1%
X-LIST ENTRIES ALLOCATED:       500
CHG-DSTN: MASP A - COMPLTD

```

;

The following example displays the destination memory space accounting command completion response with one or more of the NCR, NRT, or CRMD features on. In this example, a destination is defined as a proxy point code.

```

chg-dstn:dPC=1-1-1:prx=yes
tekelecstp 07-03-05 17:34:18 EST EAGLE 37.5.0
DESTINATION ENTRIES ALLOCATED: 2000
FULL DPC(s):                   27
EXCEPTION DPC(s):              0
NETWORK DPC(s):                 1
CLUSTER DPC(s):                 1
PROXY DPC(s):                   1
TOTAL DPC(s):                   30
CAPACITY (% FULL):              2%
ALIASES ALLOCATED:              12000
ALIASES USED:                    0
CAPACITY (% FULL):              0%
X-LIST ENTRIES ALLOCATED:       500

```

```
CHG-DSTN: MASP A - COMPLTD
;
```

The following example displays the output that results if the secondary point code is changed.

**chg-dstn:dpc=1-1-1:spc-144-23-48**

```
tekelecstp 07-03-05 17:34:18 EST EAGLE 37.5.0
CAUTION: Dstn's SPC has changed - verify remote node's route.
DESTINATION ENTRIES ALLOCATED: 2000
  FULL DPC(s): 27
  EXCEPTION DPC(s): 0
  NETWORK DPC(s): 1
  CLUSTER DPC(s): 1
  PROXY DPC(s): 1
  TOTAL DPC(s): 30
  CAPACITY (% FULL): 2%
ALIASES ALLOCATED: 12000
  ALIASES USED: 0
  CAPACITY (% FULL): 0%
X-LIST ENTRIES ALLOCATED: 500
CHG-DSTN: MASP A - COMPLTD
;
```

## chg-e1

## Change E1 Interface

Use this command to change an interface for an E1 card in the system:

- An E1/T1 MIM card
- An HC-MIM card used as an E1 card or an SE-HSL card
- An E5-E1T1 card used as an E1 card or an SE-HSL card

The E1 port number on the card and the E1 card location in the system must be specified.

The CRC4, CAS, CCS, encoding, timing source, and NFAS signaling bit options can be set.

On HC-MIM and E5-E1T1 cards, E1 ports 1, 3, 5, and 7 (master ports) can be independently channel bridged with their adjacent even-numbered E1 ports 2, 4, 6, and 8 (slave ports) to allow non-signaling data pass-through.

**Keyword:** chg-e1

**Related Commands:** dlt-e1, ent-e1, rtrv-e1, tst-e1

**Command Class:** Database Administration

## Parameters

**:e1port=** (mandatory)

E1 port number. The value must be an E1 port that has already been configured with an E1 interface on the specified E1 card.

**Range:** 1-8

Ports 3 - 8 can be specified only for HC-MIM and E5-E1T1 cards.

Any 2 of the 8 ports on an HC-MIM card can be specified when the card is used as an SE-HSL card.

Any 1 of the 8 ports on an E5-E1T1 card can be specified when the card is used as an SE-HSL card.

**:loc=** (mandatory)

Card address. The card location as stenciled on the shelf of the system.

**Range:** 1101-1108, 1111-1112, 1201-1208, 1211-1218, 1301-1308, 1311-1318, 2101-2108, 2111-2118, 2201-2208, 2211-2218, 2301-2308, 2311-2318, 3101-3108, 3111-3118,

3201-3208, 3211-3218, 3301-3308, 3311-3318, 4101-4108, 4111-4118, 4201-4208,  
4211-4218, 4301-4308, 4311-4318, 5101-5108, 5111-5118, 5201-5208, 5211-5218,  
5301-5308, 5311-5318, 6101-6108, 6111-6118

**:cas=** (optional)

CAS (**on**) or CCS (**off**) indicator.

**Range:** **on, off**

CAS cannot be specified for HC-MIM cards or E5-E1T1 cards.

**Default:** No change in current value

**:chanbrdg=** (optional)

Port bridging status. This parameter specifies whether an odd-numbered E1 port on an HC-MIM or E5-E1T1 card is channel bridged with its adjacent even-numbered E1 port for non-signaling data pass through.

**Range:** **on, off**

**Default:** No change to the current value

**:crc4=** (optional)

CRC4 enable or disable indicator.

**Range:** **on, off**

**Default:** No change in current value

**:e1tsel=** (optional)

Timing source.

**Range:** **line, external, recovered**

**line** — slave timing source

**external** — master timing source

**recovered** — timing source recovered from the paired master port for channel bridged slave ports

**Default:** No change to the current value

**:encode=** (optional)

Indicator for use of HDB3 or AMI encoding/decoding.

**Range:** **hdb3, ami**

AMI encoding is supported for the E1/T1 MIM card, the HC-MIM card, or the E5-E1T1 card used as an E1 card.

**Default:** No change in current value

**:force=** (optional)

This parameter specifies to provision an odd-numbered E1 port to channel bridging mode if the adjacent next higher even-numbered port is already provisioned with an E1 interface.

**Range:** **yes, no**

**:minsurate=** (optional)

Minimum signal unit rate. This parameter indicates the minimum number of SUs present on a link that are uniformly distributed. This parameter is valid only when the **linkclass=unchan** parameter is specified in the E1 interface.

**Range:** **500-2000**

**Default:** No change to the current value

**:si=** (optional)

Value of two Spare International bits of NFAS data.

**Range:** **0-3**

**Default:** No change in current value

**:sn=** (optional)

Value of five Spare International bits of NFAS data.

**Range:** 0-31  
**Default:** No change in current value

### Example

```
chg-
e1:loc=1205:e1port=1:crc4=off:cas=on:encode=hdb3:e1tsel=external:
si=2:sn=12
chg-e1:loc=1205:e1port=2:cas=off:encode=ami
chg-e1:loc=1205:e1port=3:chanbrdg=on:e1tsel=recovered
chg-e1:loc=1205:e1port=1:minsurate=1000
```

### Dependencies

At least one optional parameter must be specified.

The specified card location (**loc** parameter) must be equipped.

The card specified by the **loc** parameter must be a **lime1** card type.

The port specified by the **e1port** parameter must already be equipped with an E1 interface.

If the value specified for the **loc** parameter indicates an E1 card, then all signaling links that are serviced by the card must be deactivated (see the **dlt-slk** command) before the values for the **crc4**, **cas**, **encode**, and **e1tsel** parameters can be changed.

The **cas=on** parameter cannot be specified when timeslot 16 on the E1 card is being used by a signaling link.

If a value of **3 - 8** is specified for the **e1port** parameter, or if the **chanbrdg=on** parameter is specified, then the **cas=on** parameter cannot be specified.

The **encode=ami** parameter is supported only for the E1/T1 MIM card, HC-MIM card, or E5-E1T1 card used as an E1 card.

The **chanbrdg** parameter can be specified only for HC-MIM cards and E5-E1T1 cards used as E1 cards (not as SE-HSL cards).

The **chanbrdg=on** parameter cannot be specified for even-numbered E1 ports on HC-MIM and E5-E1T1 cards.

The timing source parameter **e1tsel** must be specified if **chanbrdg=on** is specified.

If the **chanbrdg=on** parameter is specified for an E1 port on an HC-MIM or E5-E1T1 card, then the **e1tsel=line** parameter cannot be specified.

The **chanbrdg=on** parameter must be specified for an HC-MIM or E5-E1T1 card before the **e1tsel=recovered** parameter can be specified. If the **e1tsel=recovered** parameter was specified previously, then the **e1tsel=line** parameter must be specified before the **chanbrdg=off** parameter can be specified.

The **force=yes** parameter must be specified before the **chanbrdg=on** parameter can be specified for an odd-numbered E1 port on an HC-MIM or E5-E1T1 card if the adjacent next higher even-numbered port is already provisioned with an E1 interface.

The **linkclass=unchan** parameter must be specified before the **minsurate** parameter can be specified. If the **linkclass=unchan** parameter is specified, then the **chanbrdg=on** and the **cas=on** parameters cannot be specified.

Before the **chanbrdg=on** parameter can be specified for an odd-numbered E1 port on an HC-MIM or E5-E1T1 card, all signaling links assigned to its next higher even-numbered adjacent E1 port must be deleted (see the **dlt-slk** command).

Parameter values cannot be changed for the even-numbered E1 port interface (**e1port** parameter) in a channel bridged pair. The values must be changed in the odd-numbered port interface.

HIPR cards must be equipped in card locations *xy09* and *xy10* (*x* is the frame, *y* is the shelf) on each EAGLE 5 ISS shelf that contains one or more HC-MIM cards or E5-E1T1 cards.

The **fan** feature bit (see the **chg-feat** command) must be turned on before HC-MIM cards can be used in an EAGLE 5 ISS shelf.

If the value specified by the **loc** parameter refers to a Channel card, then the **chanbrdg=on** parameter cannot be specified.

The following card locations cannot be specified in the **loc** parameter: 1113, 1114, 1115, 1116, 1117, 1118 (OAM, TDM, MDAL cards), or *xy09* and *xy10* where *x* is the shelf and *y* is the slot (HMUX or HIPR cards).

## Notes

When **e1tsel=external** is specified, a user-supplied BITS clock is required.

External timing is derived from the EAGLE 5 ISS High-Speed Master Clock (1.544 MHz for T1 or 2.048 MHz for E1); therefore, the Master Timing feature is required. Line timing is derived from its received data stream, if present.

## Output

```
chg-e1:loc=1205:e1port=2:cas=off:encode=ami
```

```
rlghncxa03w 04-01-20 09:07:58 EST EAGLE 31.3.0
CHG-E1: MASP A - COMPLTD
```

```
;
```

## chg-eisopts

### Change Eagle Support for Integrated Sentinel Options

Use this command to enable and disable the copy functions that are associated with the EAGLE 5 Integrated Monitoring Support (E5IS) feature.

**Keyword:** **chg-eisopts**

**Related Commands:** **rtrv-eisopts**

**Command Class:** Security Administration

## Parameters

**:eiscopy=** (optional)

System-wide control for MSU, alarm, and event copy to the ESP.

**Range:** **on, off**

**Default:** No change to the current value

**System**

**Default:** **off**

**:fcmode=** (optional)

This parameter specifies a system-wide control to enable or disable monitoring on FC-capable cards.

**Range:** **stc, fcopy, off**

**stc** — STC monitoring is performed on FC-capable cards

**fcopy** — FC monitoring is performed on FC-capable cards

**off** — Monitoring is not performed on FC-capable cards.

**Default:** No change to the current value

**System** **stc** - If Integrated Monitoring is turned on for the first time, and the **eiscopy=on**

**Default:** parameter has been specified, then the system default for the **fcmode** parameter is **stc**. If the **eiscopy=off** parameter has been specified, then the system default value is **off**.

**Example**

```
chg-eisopts:eiscopy=on
chg-eisopts:fcmode=fcopy
```

**Dependencies**

At least one parameter must be specified.

The Eagle 5 Support for Integrated Sentinel (E5IS) feature must be turned on before this command can be entered

Before the E5IS copy function can be enabled, at least 2 STC cards must be installed and in the IS-NR state in the system.

The **eiscopy=on** parameter must be specified before a value of **stc** or **fcopy** can be specified for the **fcmode** parameter.

The **fcmode=off** parameter must be specified before the **eiscopy=off** parameter can be specified. The **fcmode=off** parameter must be specified to change the value of the **fcmode** parameter between **stc** and **fcopy**.

At least one FC-capable card must be installed and in the IS-NR state before the **fcmode=fcopy** parameter can be specified.

**Notes****Fast Copy Cards**

A card that can run the Fast Copy interface is referred to as an *FC-capable* card. Currently, E5-ENET cards running the **ipsg** application are the only supported FC-capable cards. After the **fcmode=fcopy** parameter is specified, the card is referred to as an *FC-enabled* card.

**Output**

```
chg-eisopts:fcmode=fcopy
rlghncxa03w 08-12-11 09:07:58 EST EAGLE 40.1.0
CHG-EISOPTS: MASP A - COMPLTD
;
```

**chg-feat****Change Feature**

Use this command to activate the optional features available on the system.

You must purchase a feature before you turn the feature on. If you are not sure whether you have purchased a feature, contact your Tekelec Sales Representative or Account Representative.



CAUTION

**CAUTION: The features are off when you install the system. After they are turned on with this command, they cannot be turned off.**

**Keyword:** chg-feat

**Related Commands:** rtrv-feat

**Command Class:** Program Update

**Parameters**

**:cnf=** (optional)

This parameter turns on the Calling Name Conversion Facility (CNCF) feature.

**Range:** on

**Default:** No change in current value.

**System**

**Default:** off

**:crmd=** (optional)

This parameter turns on the Cluster Routing and Management Diversity (CRMD) feature.

**Range:** on

**Default:** No change in current value.

**System**

**Default:** off

**:dstn5000=** (optional)

This parameter turns on the 5000 Routes feature.

**Range:** on

**Default:** No change in current value.

**System**

**Default:** off

**:e5is=** (optional)

This parameter turns on the EAGLE 5 Integrated Monitoring Support (E5IS) feature. This feature cannot be turned on until the Time Slot Counter Synchronization (TSC) feature used with GSPM-II cards is turned on (**tsync=on**). The **e5is** parameter and the **tsync** parameter can be specified in the same **chg-feat** command to turn both features on at the same time.

**Range:** on

**Default:** No change in current value.

**System**

**Default:** off

**:egt=** (optional)

This parameter turns on the Enhanced Global Title Translation (EGTT) feature.

**Range:** on

**Default:** No change in current value.

**System**

**Default:** off

**:fan=** (optional)

This parameter turns on the cooling fan feature.

**Range:** on

**Default:** No change in current value.

**System**

**Default:** off

**:gtt=** (optional)

This parameter turns on the Global Title Translation (GTT) feature.

**Range:** on

**Default:** No change in current value.

**System**

**Default:** off

**:gws=** (optional)

This parameter turns on the Gateway Screening (GWS) feature.

**Range:** on

**Default:** No change in current value.

**System**

**Default:** off

**:ipisup=** (optional)

This parameter turns on the ISUP Routing Over IP (IPISUP) feature.

**Range:** on

**Default:** No change in current value.

**System**

**Default:** off

**:ituduppc=** (optional)

This parameter turns on the ITU National Duplicate Point Code (ITUDUPPC) feature.

**Range:** on

**Default:** No change in current value.

**System**

**Default:** off

**:itumtprs=** (optional)

This parameter turns on the ITU MTP Restart feature.

**Range:** on

**Default:** No change in current value.

**System**

**Default:** off

**:lan=** (optional)

This parameter turns on the STP LAN feature.

**Range:** on

**Default:** No change in current value.

**System**

**Default:** off

**:lfs=** (optional)

This parameter turns on the Link Fault Sectionalization (LFS) feature.

**Range:** on

**Default:** No change in current value.

**System**

**Default:** off

**:measplat=** (optional)

This parameter turns on the Measurements Platform feature. The **chg-measopts:platformenable=on** command must be entered to enable the Measurement Platform collection function (which cannot be disabled after it is enabled in the system).

**Range:** on

**Default:** No change in current value.

**System**

**Default:** off

**:mpc=** (optional)

This parameter turns on the Multiple Point Code (MPC) feature.

**Range:** on

**Default:** No change in current value.

**System**

**Default:** off

**:mtprs=** (optional)

This parameter turns on the ANSI MTP Restart feature.

**Range:** on

**Default:** No change in current value.

**System**

**Default:** off



**:ncr=** (optional)

This parameter turns on the Nested Cluster Routing (NCR) feature.

**Range:** on

**Default:** No change in current value.

**System**

**Default:** off

**:nrt=** (optional)

This parameter turns on the Network Routing feature.

**Range:** on



**CAUTION**

**CAUTION: When using the Network Routing feature, limited network management is provided for point codes not covered by full point code routing, Cluster Routing, or Nested Cluster Routing.**

**Default:** No change in current value.

**System**

**Default:** off

**:plnp=** (optional)

This parameter turns on the PCS (Personal Communication Service) 1900 Number Portability feature.

**Range:** on

**Default:** No change in current value.

**System**

**Default:** off

**:sccpcnv=** (optional)

This parameter turns on the SCCP Conversion feature.

**Range:** on

**Default:** No change in current value.

**System**

**Default:** off

**:seas=** (optional)

This parameter turns on the Signaling Engineering Administration System (SEAS) feature.

**Range:** on

**Default:** No change in current value.

**System**

**Default:** off

**:slsobc=** (optional)

This parameter turns on the Other CIC (Circuit Identification Code) Bit Used feature.

**Range:** on

**Default:** No change in current value.

**System**

**Default:** off

**:tcapcnv=** (optional)

This parameter turns on the TCAP Conversion feature.

**Range:** on

**Default:** No change in current value.

**System**

**Default:** off

**:tlnp=** (optional)

This parameter turns on the Triggerless Local Number Portability (TLNP) feature.

**Range:** on

**Default:** No change in current value.

**System**

**Default:** off

**:tscsync=** (optional)

This parameter turns on the Time Slot Counter Synchronization (TSC) feature that is used with GSM-II cards. This feature is required, along with use of STC cards, for the EAGLE 5 Integrated Monitoring Support feature (**e5is=on**).

**Range:** on

**Default:** No change in current value.

**System**

**Default:** off

**:vgtt=** (optional)

This parameter turns on the Variable Length GTT (VGTT) feature.

**Range:** on

**Default:** No change in current value.

**System**

**Default:** off

**:wnp=** (optional)

This parameter turns on the Wireless Number Portability (WNP) feature.

**Range:** on

**Default:** No change in current value.

**System**

**Default:** off

**:gflex=** (obsolete)

This parameter turns on the GSM flexible numbering (G-Flex) feature.

This parameter is obsolete.

**Range:** on

**Default:** No change in current value.

**System**

**Default:** off

**:mgtt=** (obsolete)

This parameter turns on the Modified Global Title Translation (MGTT) feature. The MGTT feature replaces the PRFXDLGT feature.

This parameter is obsolete.

**Range:** on

**Default:** No change in current value.

**System**

**Default:** off

**:x252000=** (obsolete)

This parameter turns on the 2000 X.25 Routes and Destinations feature.

This parameter is obsolete.

**Range:** on

**Default:** No change in current value.

**System**

**Default:** off

**:x25g=** (obsolete)

This parameter turns on the X.25/SS7 Gateway feature.

This parameter is obsolete.

**Range:** on

**Default:** No change in current value.

**System**

**Default:** off

### Example

```
chg-feat:gtt=on
```

```
chg-feat:gws=on:cncf=on
```

```
chg-feat:sccpcnv=on:tcapcnv=on
```

```
chg-feat:tscsync=on:e5is=on
```

### Dependencies

**NOTE: The "LNP feature" is turned on when the LNP ported TNs quantity appears in the rtrv-ctrl-feat command output. An LNP quantity feature access key has been enabled and turned on. See the enable-ctrl-feat and chg-ctrl-feat commands for more information about turning on the LNP feature.**

At least one optional parameter must be specified.

The Gateway Screening feature must be turned on (**gws=on**) before the following features can be turned on:

- The STP LAN feature (**lan=on**)
- The CNCF feature (**cncf=on**)

The SCCP Conversion feature must be on (**sccpcnv=on**) before the TCAP Conversion feature can be turned on (**tcapcnv=on**).

The LNP feature must be turned on before the following features can be turned on:

- The Wireless Number Portability feature (**wnp=on**)
- The PCS 1900 LNP feature (**plnp=on**)

The LNP feature must be turned on and the Gateway Screening feature must be turned on (**gws=on**) before the Triggerless LNP feature can be turned on (**tlnp=on**).

The X.25/SS7 Gateway feature must be turned on (**x25g=on**) before the 2000 X.25 Routes and Destinations feature can be turned on (**x252000=on**).

The Cluster Routing and Management Diversity (CRMD) feature must be turned on (**crmd=on**) before the Nested Cluster Routing (NCR) feature can be turned on (**ncr=on**).

The Global Title Translation (GTT) feature must be turned on (**gtt=on**) before the Enhanced Global Title Translation (EGTT) feature (**egtt=on**) can be turned on. When the EGTT feature is turned on, three command sets—the GTT Selector (**ent/chg/dlt/rtrv-gttsel**), GTT Set (**ent/dlt/rtrv-gttset**), and GTA (**ent/chg/dlt/rtrv-gta**) commands—are used instead of the Translation Type and Global Title Translation command sets—**ent/dlt/rtrv-tt**, and **ent/chg/dlt/rtrv-gtt**. All data previously provisioned with the GTT commands is maintained.

The Multiple Point Code (MPC) feature must be turned on (**mpc=on**) before the ITU National Duplicate Point Code (ITUDUPPC) feature can be turned on (**ituduppc=on**).

The Global Title Translation (GTT) feature must be turned on (**gtt=on**) before the Variable Length GTT (VGTT) feature (**vgtt=on**) can be turned on.

Both cards that run the OAM must be GSPM-II cards before the Time Slot Counter Synchronization (TSC) feature (**tscsync** parameter) can be turned on.



**CAUTION: Never install or initialize MCAP cards in card slots 1113 and 1115 after GSPM-II cards are provisioned in these slots. Attempting to initialize MCAP cards after GSPM-II cards have been provisioned in slots 1113 and 1115 will cause a system outage. Before replacing an existing GSPM-II card in slot 1113 or 1115, contact Tekelec Customer Service.**

The Time Slot Counter Synchronization (TSC) feature (**tscsync** parameter) must be turned on before the EAGLE 5 Integrated Monitoring Support feature (**e5is** parameter) can be turned on. The two parameters can be specified in the same **chg-feat** command to turn them both on at the same time.

The SCCP and TCAP conversion features (SCCPCNV and TCAPCNV) cannot be turned on when the ANSI-ITU-China SCCP Conversion feature is enabled (see the **enable-ctrl-feat** command).

The Gateway Screening feature (GWS) must be turned on (**gws=on**) before Calling Number Conversion Facility (CNCF) feature can be turned on.

The Global Title Translation GTT) feature (**gtt=on**) must be turned on before Global System for Mobile Screening (GSM) feature can be enabled.

As of Release 41.0, the X.25/SS7 (X25G) feature is not supported.

## Notes

This command is not allowed in upgrade mode.

After a feature bit is turned on, it cannot be turned off. Take care in turning on features that are not used in the network configuration.

The Calling Name Conversion Facility (CNCF) feature provides a conversion of ISUP IAM messages. The facility uses the following two versions of calling name identification presentation (CNIP) for calling name information delivery:

- The nonstandard, proprietary ISUP party information (PIP) parameter.
- The ANSI standard ISUP generic name (GN) parameter.

The conversion either replaces the PIP parameter with the GN parameter or the GN parameter with the PIP parameter in the ISUP IAM message. The user can set up GWS screens to apply the CNCF feature on a per-point-code or range-of-point-code basis.

The Cluster Routing and Management Diversity (CRMD) feature allows the system to configure one route set to an entire cluster of destinations, thus enabling the system to manage and switch traffic to more end nodes.

The Global Title Translation (GTT) feature allows the system to provide translation of the global title digits located in the called party address of an SCCP message. The translation consists of a point code and subsystem number. This feature requires Service Module cards loaded with the VSCCP application.

The Enhanced Global Title Translation (EGTT) feature provides enhancements to the way the system performs GTT for both ITU and ANSI messages. The feature allows the combination of domain (ANSI or ITU), global title indicator (GTI), translation type (TT), numbering plan (NP), and nature of address indicator (NAI) selectors to be used to select a translation table when the system receives a message requiring EGTT. The feature also allows inclusion of the translated subsystem number (SSN) in the called party address (CDPA) and inclusion of the originating point code (OPC) in the

calling party address (CGPA). The feature also provides deletion capability of the GT (global title) in the CDPA.

The Gateway Screening (GWS) feature allows the system to screen specific message types with selected parameters from entering the network through this STP. This feature requires TSM cards loaded with the GLS application.

The STP LAN feature allows selected SS7 messages to be copied and sent to a remote host over an ethernet LAN using the TCP/IP protocol. This feature requires up to 32 cards running the **stplan** application, and requires the Gateway Screening feature.

The Triggerless LNP (TLNP) feature gives service providers a method to route calls to ported numbers without having to upgrade their signaling switch (end office or mobile switching center) software. This feature uses the gateway screening stop action TLNP to intercept through-switched ISUP messages on the LIM.

The Link Fault Sectionalization (LFS) feature allows the system to perform a series of far end loopback tests that identify faulty segments of an SS7 transmission path up to and including the remote network element.

The ANSI MTP Restart (MTPRS) feature provides an orderly process for bringing signaling links back into service after the system has been isolated and restarted. A greater preference is given to restoring the STP to network service in an orderly fashion than to the speed of recovery. The time required is system dependent; Table 5-9 provides examples of some approximate times.

**Table 5-9.** Link Alignment Performance

<b>System Size (No. of LIMs)</b>	<b>Link Alignment Delay (seconds)</b>
Up to 64	62
64 to 127	97
128 to 191	132
More than 191	167

The ITU MTP Restart (ITUMTPRS) feature provides MTP restart support for ITU networks and extends the system’s ANSI MTP restart support to mixed ITU and ANSI networks. The performance of ITU MTP Restart is comparable to the performance of ANSI MTP Restart.

SEAS interface support allows the system to interface with the Signaling Engineering and Administration System (SEAS).

The SCCP and TCAP conversion features (SCCPCNV and TCAPCNV) allow the system to convert MTP-routed SCCP and TCAP messages from ANSI to ITU format and to convert ITU formatted messages to ANSI.

The PCS 1900 LNP (PLNP) feature provides for LNP query/response in a PCS wireless environment using the LRN method to support Service Provider Number Portability.

The Nested Cluster Routing (NCR) feature allows the system to support full point code entries on different routes within a cluster.

The Other CIC (Circuit Identification Code) Bit Used feature is one of two methods provided as ITU SLS enhancements for distributing the load across links in a combined and single linkset. The Other CIC Bit Used feature lets the system derive the LSB (Least Significant Bit) from bits 2 through 4 of the CIC to serve as the three lower bits of the SLS (Signaling Link Selection) and one other bit of

the CIC to serve as the MSB (Most Significant Bit) of the SLS. The SLSOCB feature applies only to ITU-ISUP messages. The other method of distributing the load is rotation of the four bits of the SLS to change the LSB of the SLS. For additional information on bit rotation, see the **ent-ls** command.

The Network Routing (NR) feature allows provisioning of a single routeset to be used for all MSUs destined to members of that network.

The DSTN5000 (5000 Routes) feature provides the ability to administer up to 5000 routes on the system. If **dstn5000=on**, the values of the **mtpdpcq** (destination point code) and **mtpxlq** (exception list entries) parameters of the **chg-stpropts** command can total **5500**. Otherwise, the sum total for **mtpdpcq** and **mtpxlq** cannot exceed **2500**. The Cluster Routing and Management Diversity (CRMD) feature must be turned on before the **mtpxlq** parameter can be specified.

The MPC (Multiple Point Code) feature enables the user to use SPCs (secondary point codes) in addition to the true point codes that the EAGLE 5 ISS uses. The SPCs are used for provisioning and routing as if they were the true point code of the EAGLE 5 ISS. SPCs can be provisioned in any of the three domains (ANSI, ITU-N, and ITU-I). SPCs are supported for any type of link.

The ITUDUPPC (ITU National Duplicate Point Code) feature allows an EAGLE 5 ISS mated pair to route traffic for two or more countries that may have overlapping point code values.

The VGTT (Variable Length GTT) feature provides the ability to provision global title entries of varying lengths to a single translation type or GTT set. Users are able to assign global title entries of up to 10 different lengths to a single translation type or GTT set.

The Time Slot Counter Synchronization (TSCSYNC) feature allows the system's A (Active) and B (Standby) internal clocks to be synchronized by the GPSM-II card that is running the standby OAM.

The EAGLE 5 Integrated Monitoring Support feature provides an Ethernet interface between the EAGLE 5 ISS and the Sentinel Extended Services Platform (ESP) or the Integrated Message Feeder (IMF), to eliminate the need for cabling between each SS7 link and the ESP or IMF to monitor SS7 traffic.

The Measurements Platform feature provides a dedicated processor for collecting and reporting STP, LNP, INP, G-Flex, and G-Port Measurements data, with support for EAGLE 5 ISS growth to more than 700 links.

## Output

```
chg-feat:gtt=on
```

```
rlghncxa03w 04-01-11 11:34:04 EST EAGLE 31.3.0
CHG-FEAT: MASP A - COMPLD
```

```
;
```

## chg-frm-pwr

## chg-frm-pwr

Use this command to change the power threshold value in the Frame Power Threshold table for a specified frame.

The entries in the Frame Power Threshold table contain a Frame ID and the corresponding power threshold value.

You can use the following commands to display the threshold and calculated maximum power consumption for the frames in the system.

- The **rtrv-frm-pwr** command displays the current provisioned frame power threshold for each provisioned frame.

- The **rtrv-stp:display=power** command displays the provisioned frame power threshold for each provisioned frame, and displays the maximum calculated power consumption for each frame, based on card population.
- The **rtrv-stp:display=power:frm=xxxx** command displays the provisioned frame power threshold for the specified frame, the maximum calculated power consumption for the frame based on card population, and the maximum power consumption for each card in the frame and for a fan assembly for each shelf.

**NOTE: The frame-level power threshold value needs to be determined from the capacity in Amps of the fuse alarm panel (FAP) for the frame. Contact your site engineer to determine the FAP capacity.**

**Keyword:** chg-frm-pwr

**Related Commands:** dlt-frm-pwr, ent-frm-pwr, rtrv-frm-pwr, rtrv-stp

**Command Class:** Database Administration

## Parameters

**:frm=** (mandatory)

Frame ID

**Range:** cf00, ef00, ef01, ef02, ef03, ef04

cf00 — Control frame

ef00 — First extension frame

ef01 — Second extension frame

ef02 — Third extension frame

ef03 — Fourth extension frame

ef04 — Fifth extension frame

**:thrshld=** (mandatory)

Threshold. This parameter specifies the frame-level power threshold, in Amps. This value is compared with the current calculated maximum power consumption for the frame (use the **rtrv-stp:display=power:frm=** command to obtain the maximum power consumption value), and the appropriate alarms are raised if that power consumption exceeds the threshold limit.

The value of the **thrshld** parameter needs to be determined from the capacity of the fuse alarm panel (FAP) for the frame. Contact your site engineer to determine the frame FAP capacity.

**Range:** 30-65

**Default:** 30

## Example

Change the frame power threshold value for the first extension frame.

```
chg-frm-pwr:frm=ef00:thrshld=58
```

## Dependencies

A power threshold value must already be provisioned for the specified frame.

## Notes

The maximum calculated power for a frame is based on the cards that are populated in the system, and includes a fan tray assembly for every shelf (the system cannot detect the presence or absence of a fan tray, and assumes presence for the calculation). These values are typically much higher than the actual power being drawn; the values cannot be used as a gauge of the actual power consumption of the EAGLE 5 ISS.





## Dependencies

At least one optional parameter must be specified.

The **app** parameter must specify an application that uses the FTP Support feature.

The **ipaddr** parameter must specify a valid IP address for the FTP server.

The **path** parameter value must be in a valid FTP path format.

The **prio** parameter specifies a priority for use of an FTP server by an application when the application has more than one FTP server defined in the table. Each FTP server defined for use by the application must have a priority from 1 to 10 assigned. The available FTP server with the highest priority (smallest number) will be used first by the application.

If the **login** parameter is specified, a separate prompt appears for entry of the FTP server password. You must enter a password that is at least 1 and not more than 15 characters long. If an invalid password is entered or the Return key is pressed without entering a password, the entire command must be entered again to cause the password prompt to appear again. The password is not displayed as it is entered.

An entry for the specified application ID at the specified priority cannot already exist.

The FTP server entry to be changed with this command must already exist in the FTP Server table for the specified IP address and application.

## Notes

The same FTP server can be defined more than once, but the specified application must be different for each entry.

## Output

```
chg-ftp-serv:app=meas:ipaddr=1.255.0.102:path="-ftpmeas1"
  rlgncxa03w 04-01-20 09:07:58 EST EAGLE 31.3.0
  CHG-FTP-SERV: MASP A - COMPLTD
;

chg-ftp-serv:app=meas:ipaddr=1.255.0.102:login=ftpmeas1
  rlgncxa03w 04-01-20 09:07:58 EST EAGLE 31.3.0
Enter Password:*****
  CHG-FTP-SERV: MASP A - COMPLTD
;

chg-ftp-serv:app=user:ipaddr=1.22.10.2:prio=3
  rlgncxa03w 04-01-20 09:07:58 EST EAGLE 31.3.0
  CHG-FTP-SERV: MASP A - COMPLTD
;
```

## chg-gpl

### Change Generic Program Load

Use this command to copy a generic program load from the system removable cartridge or drive to the destination active and standby system disks as a "trial" version. The system release identification file is uploaded from the system removable cartridge or drive to the active and standby fixed drives along with each GPL. This command also provides a parameter to turn GPL auditing "on" and "off".

**Keyword:** chg-gpl

**Related Commands:** act-gpl, alw-card, copy-gpl, init-card, init-sys, rept-stat-gpl, rtrv-gpl

**Command Class:** Program Update

## Parameters

**:audit=** (optional)

This parameter specifies whether the active MASP system release running version is to be audited every 90 seconds. The audit state is preserved through a system restart or power up.

**NOTE: When audit is turned off, the system release audit process is stopped. The detection, marking, and reporting of corrupt GPLs is continuous and not affected by turning audit off.**

**Range:** on, off

**Default:** on

**:gpl=** (optional)

Generic program load. This parameter specifies the name of the GPL identifier to be moved from "trial" to "approved" status on cartridge or drive to the disk.

**Range:** xxxxxxxx

1 alphabetic character followed by up to 7 alphanumeric characters. Valid GPLs are:

**atmansi**—Used by the LIM cards to support the high-speed ATM signaling link feature

**atmhc**—Supports functionality for the E5-ATM card. The E5-ATM card runs either the ATMANSI or ATMITU application. The GPL allows the card to support up to 2 signaling links.

**atmitu**—Used by E1 ATM cards to support the high-speed E1 ATM signaling link feature

**blbepm**—Flash GPL containing the BIOS ROM image on E5-E1T1 and E5-ENET cards

**blbios**—Flash GPL containing the BIOS ROM image on HC-MIM cards that are used for E1 or T1 signaling links

**blbsmg**—Flash GPL containing the BIOS ROM image on E5-SM4G cards

**blepld**—Flash GPL containing the bit files for the CPLD on HC-MIM, E5-E1T1, and E5-ENET cards that are used for E1 or T1 signaling links.

**bldiag6**—Flash GPL containing the diagnostic code on E5-E1T1 cards, HC-MIM cards, and E5-ENET cards

**blmcap**—Flash GPL containing a tar image with all code required on E5-MCAP cards

**blvxw6**—Flash GPL containing the VxWorks operating system on E5-E1T1 cards, HC-MIM cards, and E5-ENET cards

**blrom1**—Flash GPL containing the bootloader code for VxWorks operating system on HC-MIM cards

**bpdcn**—Used to support the flash memory Board PROM for DCM, DSM, and GPSM boards, original design

**bpdcn2**—Used to support the flash memory Board PROM for DCM and GPSM boards, revised design

**bphcap**—Used to support Board PROM for HCAP flash memory

**bphcapt**—Supports Board PROM for HCAP-T flash memory

**bphmux**—Supports Board PROM for HMUX flash memory

**bpmpl**—Supports Board PROM for MPL flash memory

**bpmplt**—Supports Board PROM for E1/T1 flash memory

**cd**—Used in the card manufacturing process.

**eoam**—Used by the GPSM-II card for enhanced OAM functions

**eroute**—Used by the STC card for EAGLE 5 Integrated Monitoring Support functions

**erthc**—Used by the E5-ENET card when the card acts as an STC card (E5-STC card) for EAGLE 5 Integrated Monitoring Support functions

**gls**—Used by TSM cards to download gateway screening to LIM cards

**glsch**—Used by E5-TSM cards to download gateway screening to LIM and SCCP cards

- hipr**—Communication software used on the High Speed IMT Packet Router (HIPR) card
- hipr2**—Communication software used on the High Speed IMT Packet Router (HIPR2) card
- imt**—Communication processor on the logical processing element (LPE)
- imtpci**—Communication software that operates the IMT bus on HC-MIM, E5-E1T1, and E5-ENET cards
- ipghc**—Used by E5-ENET cards to support TCP/IP point-to-multipoint connectivity for both ANSI and ITU point codes
- ipgwi**—Used by SSEDCCM cards for TCP/IP point-to-point connectivity for ITU point codes
- iplhc**—Used by E5-ENET cards for TCP/IP point-to-point connectivity for both ANSI and ITU point codes
- iplim**—Used by SSEDCCM cards for TCP/IP point-to-point connectivity for ANSI point codes
- iplimi**—Used by SSEDCCM cards for TCP/IP point-to-point connectivity for ITU point codes
- ips**—Used by IPSM cards for the IP User Interface feature
- ipsg**—Used by E5-ENET cards to support the combined functionality of IPLIMx M2PA and IPGWx M3UA
- ipshc**—Used by E5-IPSM cards to support the IPS application
- mcp**—Used by MCPM cards for the Measurements Platform feature
- oamhc**—Used by E5-MCAP cards for enhanced OAM functions
- pldpmc1**—Flash GPL used on HC-MIM and E5-E1T1 cards for E1 and T1 signaling links
- scpc hc**—Used by E5-SM4G cards to support the EPAP-based features and the LNP ELAP Configuration feature. If no EPAP-based or LNP ELAP Configuration feature is turned on, and if an E5-SM4G card when the card acts as an STC card (E5-STC card) for EAGLE 5 Integrated Monitoring Support functions.
- ss7hc**—Supports the functionality for HC-MIM or E5-E1T1 cards. The HC-MIM and E5-E1T1 cards run the SS7ANSI or CCS7ITU application; the GPL allows the card to support up to 64 signaling links for E1 and T1 functions.
- ss7ipgw**—Used by SSEDCCM cards to support TCP/IP point-to-multipoint connectivity
- ss7ml**—Support functionality for MPL and the E1/T1 MIM cards. MPL cards run the SS7ANSI application on a LIMDS0 card (as in the command **ent-card:type=limds0:appl=ss7ansi**); the GPL allows the card to support 8 signaling links rather than the usual 2 links for LIM cards. MPL cards support only the DS0 interface. E1/T1 MIM card runs either the SS7ANSI or CCS7ITU application; the GPL allows the card to support 8 signaling links for E1 and T1 functions.
- utility**—Used by the factory for testing, and when directed by the Customer Care Center
- vcdu**—Used in the card manufacturing process
- vsccp**—Used by Service Module cards to support the EPAP-based and the LNP ELAP Configuration features. If no EPAP-based or LNP ELAP Configuration feature is turned on, and if a Service Module card is present, then the GPL processes normal GTT traffic.
- vxwslan**—Used by SSEDCCM cards to support the STP LAN application

**:src=** (optional)

Source drive. This parameter specifies the identification of the disk containing the GPL to be copied

**Range:** **remove, usb**

**remove** — The removable cartridge or drive

**usb** — Argument to be used by Tekelec personnel only.

**:ver=** (optional)

Version number of the GPL, in the form of *major-minor-fix*.

**Range:** *major-minor-fix*

Specify a valid value for each component of the version number, in the range **0-255**

### Example

```
chg-gpl:audit=on
```

```
chg-gpl:gpl=atmitu:ver=114-1-0
```

```
chg-gpl:gpl=sccphc:ver=128-1-0
```

```
chg-gpl:gpl=hipr2:ver=128-1-0
```

```
chg-gpl:gpl=ipsg:ver=129-1-0
```

```
chg-gpl:gpl=atmhc:ver=125-1-0
```

### Dependencies

No other activate, change, copy, or retrieve GPL command can be in progress when this command is entered.

If either the **ver** or the **gpl** parameter is specified, both parameters must be specified.

The **audit** parameter, or the **ver** and **gpl** parameters together, or the **audit**, **ver**, and **gpl** parameters together must be specified.

The value specified for the **gpl** parameter must be supported. See the **gpl** definition for a list of supported GPLs.

### Notes

If there is a failure changing the active system, the operation is stopped. If there is a failure changing the standby system, the active system is still updated.

A removable cartridge or drive must be inserted into the removable cartridge drive or latched USB port, initialized, and formatted as a system disk.

Use the **rtrv-gpl** command to determine the version number and audit state of a GPL.

The **ver** and **gpl** parameters are mandatory if a generic program load is being uploaded from a removable cartridge.

The **audit** parameter is required only when turning GPL auditing on or off and the **ver** and **gpl** parameters are optional.

When the **audit** parameter is set to **off**, the system release audit process is stopped. The detection, marking, and reporting of corrupt GPLs is continuous and not affected by turning audit off.

**Output**

The output for a successful command execution is in the following format; the name of the uploaded GPL is shown for card locations 1114 and 1116.

```
chg-gpl:gpl=ss7hc:ver=125-1-0
rlghncxa03w 09-03-01 11:43:04 EST EAGLE 40.1.0
SS7HC upload to 1114 completed
SS7HC upload to 1116 completed
System Release ID table upload to 1116 completed
System Release ID table upload to 1114 completed
```

;

The following example shows an error in the upload.

```
chg-gpl:gpl=bphcap:ver=101-014-000
rlghncxa03w 06-06-01 11:43:04 EST EAGLE 35.0.0
BPHCAP corrupted on 1117 removable: mismatched checksums
```

;

**chg-gsm-msg****Change GSM test message**

Use this command to provision GSM test messages. These messages are used by the MO SMS NPP Test Tool to test MO-based GSM SMS message processing by the NPP.

**Keyword:** chg-gsm-msg

**Related Commands:** rtrv-gsm-msg, tst-msg

**Command Class:** Database Administration

**Parameters**

**:msgn=** (mandatory)

Message number. This parameter specifies the GSM message number to be changed.

**Range:** 1-10

**:active=** (optional)

This parameter specifies whether the GSM test message is sent to the network card for processing.

**Range:** yes, no

**yes** — The message is sent to the network card.

**no** — The message is not sent to the network card.

**Default:** No change to the current value

**System**

**Default:** no

**:cdpadgts=** (optional)

Called party address digits. This parameter specifies the SCCP CdPA digits for the GSM test message.

**Range:** 1-15 digits

1 - 15 hexadecimal digits. Valid digits are **0-9, a-f, A-F**.

**Default:** No change to the current value

**System**

**Default:** 0123456789abcde

**:cdpagti=** (optional)

Called party address global title indicator. This parameter specifies the SCCP CdPA GT for the GSM test message.

**Range:** 0-15

**Default:** No change to the current value

**System**

**Default:** 4

- :cdpagnai=** (optional)  
Called party address global title nature of address indicator. This parameter specifies the SCCP CdPA GT NAI for the GSM test message.  
**Range:** 0-127  
**Default:** No change to the current value  
**System**  
**Default:** 4
- :cdpndgts=** (optional)  
Called party number digits. This parameter specifies the TCAP CdPN (*SM-RP-UI TP-DA*) digits for the GSM test message.  
**Range:** 1-20 digits  
**Default:** No change to the current value  
**System**  
**Default:** 01234567890abcde
- :cdpnnai=** (optional)  
Called party number nature of address indicator. This parameter specifies the TCAP CdPN (*SM-RP-UI TP-DA*) NAI for the GSM test message.  
**Range:** 0-7  
**Default:** No change to the current value  
**System**  
**Default:** 1
- :cdpnp=** (optional)  
Called party numbering plan. This parameter specifies the TCAP CdPN (*SM-RP-UI TP-DA*) NP for the GSM test message.  
**Range:** 0-15  
**Default:** No change to the current value  
**System**  
**Default:** 1
- :cgpagdts=** (optional)  
Calling party address digits. This parameter specifies the SCCP CgPA digits for the GSM test message.  
**Range:** 1-15 digits  
Range is 1 - 15 hexadecimal digits. Valid digits are **0-9, a-f, A-F**.  
**Default:** No change to the current value  
**System**  
**Default:** 0123456789abcde
- :cgpagti=** (optional)  
Calling party address global title indicator. This parameter specifies the SCCP CgPA GT for the GSM test message.  
**Range:** 0-15  
**Default:** No change to the current value.  
**System**  
**Default:** 4
- :cgpagnai=** (optional)  
Calling party address global title nature of address indicator. This parameter specifies the SCCP CgPA GT NAI for the GSM test message.  
**Range:** 0-127  
**Default:** No change to the current value

**System****Default:** 4**:cgpndgts=** (optional)

Calling party number digits. This parameter specifies the TCAP CgPN (*SM-RP-OA MSISDN*) for the GSM test message.

**Range:** 1-21 digits**Default:** No change to the current value**System****Default:** 01234567890abcde**:cgpnnai=** (optional)

Calling party number nature of address indicator. This parameter specifies the TCAP CgPN (*SM-RP-OA MSISDN*) NAI for the GSM test message.

**Range:** 0-7**Default:** No change to the current value**System****Default:** 1**:cgpnp=** (optional)

Calling party numbering plan. This parameter specifies the TCAP CgPN (*SM-RP-OA MSISDN*) NP for the GSM test message.

**Range:** 0-15**Default:** No change in the current value.**System****Default:** 1**:reset=** (optional)

This parameter resets all of the parameters to their system default values.

**Range:** yes, no

**yes** — Message parameters are reset to their default values

**no** — None of the message parameters are reset.

**Default:** No change to the current value**Example****chg-gsm-**

```
msg:mgn=1:cdpnnai=4:cdpadgts=12457896abcd:cgpnnai=2:cgpndgts=919818541560
```

```
chg-gsm-msg:mgn=1:reset=yes
```

**Dependencies**

If the **reset** parameter is specified, then no other parameter can be specified.

At least one optional parameter must be specified.

**Output**

```
chg-gsm-msg:mgn=1:cdpnnai=4:cdpndgts=987654321:cgpnnai=4
```

```
tekelecstp 09-03-02 10:46:51 EST EAGLE 40.1.0
```

```
CHG-GSM-MSG: MASP A - COMPLTD
```

```
;
```

**chg-gsmmap-scrn****Change GSM MAP Screening Entry**

Use this command to change the attributes (**nforbid**, **npc/npcn/npci/npcn24**, **nssn**, **ncgsr**, **ncdsr**, **naction**, **nri** and **ntt**) of GSM Map Screening CgPA and CdPA entries that are used to filter

out or allow SCCP messages containing Map Op-Codes, CgPA GTA+NPV+NAIV, CdPA GTA+NPV+NAIV, and forbidden parameters.

**Keyword:** chg-gsmmap-scrn

**Related Commands:** dlt-gsmmap-scrn, ent-gsmmap-scrn, rtrv-gsmmap-scrn

**Command Class:** Database Administration

### Parameters

**NOTE:** See "Point Code Formats and Conversion" for a detailed description of point code formats, rules for specification, and examples.

**:cgsr=** (mandatory)

CgPA Screening Reference.

**Range:** *ayyy*

1 alphabetic character followed by up to 3 optional alphanumeric characters

**:opname=** (mandatory)

The user-defined name for the operation code. The **opname** value references the operation code (**opcode**) defined with the **ent-gsms-opcode** command. GSM MAP Screening is performed on the specified address or addresses for the referenced operation code.

**Range:** *ayyyyyyy*

Up to 8 alphanumeric characters

**:cdsr=** (optional)

CdPA Screening Reference.

**Range:** *ayyy*

1 alphabetic character followed by up to 3 optional alphanumeric characters

**:force=** (optional)

Check Mated Application Override. This parameter must be used to complete command execution if the **npc/npci/npci/npcn** and **nssn** parameter combination specified in the command is not already defined in the SCCP Application entity set (Remote Point Code/Mated Application Table).

**Range:** **yes, no**

**Default:** **no**

**:naction=** (optional)

The new screening action to take if a message is forbidden as defined by the **forbid** parameter.

**Range:** **atierr, discard, dupdisc, duplicate, forward, pass, route**

**atierr** — Do not route the MSU. An ATI (Any Time Interrogation) reject message is generated to the originator. This value is valid only for ATI MAP operation codes.

**discard** — Do not route the MSU. The MSU is discarded (thrown away) and an appropriate UIM is issued.

**dupdisc** — Route the original message to the duplicate node. The original message will not be sent to the original node. If, however, the duplicate node is not available for routing, the MSU is discarded.

**duplicate** — Route the message as normal to the original destination and route a copy of the original message to the duplicate node. If the MSU fails to route to the duplicate node, a UIM is generated indicating the duplicate routing failure.

**forward** — Route the original message to the forward node. The original message will not be sent to the original node. If, however, the forward node is not available for routing, the MSU is routed to the original node.

**pass** — Route the message as normal to the destination; a UIM will be issued. This is intended to be a test mode and is recommended when setting up GSM Map Screening during the initial phase to assure that no MSUs will be inadvertently thrown away.



**route**— Route the message as normal to the original destination node; no UIM will be generated. The original destination is the node to which normal GTT would be sent if no GSM MAP actions are taken.

**Default:** No change to current value

**:ncdsr=** (optional)

The new CDPA Screening Reference.

**Range:** *ayyy*

1 alphabetic character followed by up to 3 optional alphanumeric characters

**:ncgsr=** (optional)

The new CGPA Screening Reference.

**Range:** *ayyy*

1 alphabetic character followed by up to 3 optional alphanumeric characters

**:nforbid=** (optional)

The new forbidden parameter value. Indicates a forbidden parameter for the specified entry. If a forbidden parameter is detected, the message is handled with the action defined by the **action/naction** parameter.

**Range:** **all, none, state, location**

**all**—All parameters are forbidden. Take the specified screening action defined by the **naction** parameter for messages arriving at the system.

**none**—None of the parameters are forbidden. Route the message to its destination.

**state**—Take the specified screening action defined by the **naction** parameter for messages arriving at the system that contain **state** as the forbidden parameter for the entered address/operation code combination. **Note:** The **state** parameter is valid only for GSM ATI messages.

**location**—Take the specified screening action defined by the **naction** parameter for messages arriving at the system that contain **location** as the forbidden parameter for the entered address/operation code combination. **Note:** The **location** parameter is valid only for GSM ATI messages.

**Default:** No change to current value

**:nmapset=** (optional)

The new MAP set ID.

**Range:** **1-36000 dflt**

**dflt**—Default MAP set

**Default:** No change to the MAP set value.

**:npc=** (optional)

New ANSI point code with subfields *network indicator-network cluster-network cluster member (ni-nc-ncm)*.

**Synonym:** **npca**

**Range:** **000-255**

Specify a valid value for each subfield of the point code, and separate the subfields with a dash (-).

When **chg-sid:pctype=ansi** is specified, **ni = 000** is not valid.

When **chg-sid:pctype=ansi** is specified, **nc = 000** is not valid if **ni = 001-005**.

When **chg-sid:pctype=ansi** is specified, **nc = 000** is valid if **ni = 006-255**.

The point code **000-000-000** is not a valid point code.

**:npc/npca/npci/npcn/npcn24=** (optional)

New point code. The **npc/npca/npci/npcn/npcn24** and **nssn** parameters are used when the new screening action (**naction**) is **forward**, **duplicate**, or **dupdisc** (duplicate and discard). These parameters allow the craftsperson to change the defined node to which the input message will be routed.

**:npci=** (optional)

New ITU international destination point code with subfields *zone-area-id*. The *prefix* subfield indicates a spare point code (*prefix-zone-area-id*).

**Range:** **s-, 0-255**

Specify a valid value for each subfield of the point code, and separate the subfields with a dash (-).

*prefix*—**s-**

*zone*—**0-7**

*area*—**000-255**

*id*—**0-7**

The point code **0-000-0** is not a valid point code.

**:npcn=** (optional)

New ITU national destination point code in the format of a 5-digit number (*nnnnn*); or 2, 3, or 4 numbers (members) separated by dashes (*m1-m2-m3-m4*) as defined by the **chg-stpopts:npcfnti** flexible point code option. A group code must be specified when the ITUDUPPC feature is turned on (*nnnnn-gc*, *m1-m2-m3-m4-gc*). The *prefix* subfield indicates a spare point code (*prefix-nnnnn*, *prefix-nnnnn-gc*, *prefix-m1-m2-m3-m4*, *prefix-m1-m2-m3-m4-gc*).

**Range:** **s-, 0-16383, aa-zz**

Specify a valid value for each subfield of the point code, and separate the subfields with a dash (-).

*prefix*—**s-**

*nnnnn*—**0-16383**

*gc*—**aa-zz**

*m1-m2-m3-m4*—**0-14** for each member; values must sum to 14

**:npcn24=** (optional)

New 24-bit ITU national point code with subfields *main signaling area-sub signaling area-signaling point* (*msa-ssa-sp*).

**Range:** **000-255**

Specify a valid value for each subfield of the point code, and separate the subfields with a dash (-).

*msa*—**000-255**

*ssa*—**000-255**

*sp*—**000-255**

**:nri=** (optional)

New routing indicator. This parameter specifies whether a subsequent global title translation is required.

This parameter can be specified only if the screening action is **forward**, **duplicate** or **dupdisc**.

**Range:** **gt, ssn**

**:nssn=** (optional)

New Subsystem Number. The **npc/npca/npci/npcn/npcn24** and **nssn** parameters are used when the new screening action (**naction**) is **forward**, **duplicate**, or **dupdisc** (duplicate and discard). These

parameters allow the craftsperson to change the defined node to which the input message will be routed.

**Range:** 002 - 255 none

**Default:** No change to the existing value

**:ntt=** (optional)

New translation type. This parameter specifies the value that the CdPA TT is set to as the result of Enhanced GSM Map Screening.

**This parameter can be specified only if the screening action is forward, duplicate, or dupdisc.**

**Range:** 0-255 none

**Default:** No change to the existing value

### Example

```
chg-gsmmap-scrn:opname=xyz:cgsr=fela:naction=pass
```

```
chg-gsmmap-scrn:opname=xyz:cgsr=fela:cdsr=fall:naction=discard
```

```
chg-gsmmap-scrn:opname=test2:cgsr=pcn1:npcn=s-333:nssn=254
```

```
chg-gsmmap-
```

```
scrn:opname=test1:naction=forward:npc=2-2-2:nssn=20:nmapset=12
```

```
chg-gsmmap-
```

```
scrn:opname=test2:naction=duplicate:npc=1-1-2:nssn=20:cgsr=cg1:nmapset=df1t
```

```
chg-gsmmap-scrn:opname=test3:cgsr=ad:nri=ssn
```

```
chg-gsmmap-scrn:opname=test4:cgsr=ks1:ntt=12
```

### Dependencies

At least one optional parameter must be specified.

If the **cdsr** parameter is specified, at least one additional optional parameter must be specified.

If the **ncdsr** parameter is specified, then the **cdsr** parameter must be specified.

If the **cdsr** parameter is specified, then the **ncgsr** parameter cannot be specified.

The **ncgsr** parameter and the **ncdsr** parameter cannot be specified together in the same command.

The specified **cgsr** parameter value must exist in the database.

The specified **cdsr** parameter value must exist in the database.

The specified **ncgsr** parameter value cannot already exist in the database.

The specified **ncdsr** parameter value cannot already exist in the database.

The GSM Map Screening feature (see the **enable-ctrl-feat** command) must be turned on before this command can be entered.

The Enhanced GSM Map Screening (EGMS) feature must be turned on before the **cdsr**, **ncdsr**, **pc**, and **pca** parameters can be specified.

The specified **opname** parameter value must exist in the GSM Map Op-Code table.

A value of **state** or **location** cannot be specified for the **nforbid** parameter unless the operation code (**opcode**) referenced by the **opname** parameter is **71**. The **opcode=71** parameter signifies an ATI MAP operation code.

A value of **atierr** cannot be specified for the **naction** parameter unless the operation code (**opcode**) referenced by **opname** is **71**. The **atierr** option is valid only for ATI MAP operation codes; **opcode=71** signifies an ATI MAP operation code.

If specified, the **npc/npca/npci/npcn/npcn24** parameter must be a full point code.

If the **naction** parameter is specified, and its value is **forward**, **duplicate**, or **dupdisc**, then the **npc/npc/npci/npci/npcn/npcn24** parameter and the **nssn** parameter must be specified.

The **force** parameter can be specified only if the **npc/npc/npci/npci/npcn/npcn24** parameter and the **nssn** parameter are specified.

If the **npc/npc/npci/npci/npcn/npcn24** parameter and the **nssn** parameter are specified, and the **force** parameter is not specified as **yes**, the PC-SSN must be populated in the SCCP Application entity set (Remote Point Code / Mated Application Table).

If specified, the **npc/npc/npci/npci/npcn/npcn24** parameter value must exist as a destination in the Ordered Route entity set (ANSI only), or must reside in a cluster that exists as a destination in the Ordered Route entity set (for global title routing).

The **npc/npc/npci/npci/npcn/npcn24** and **nssn** parameters can be specified only if the **naction** parameter is specified and its value is **forward**, **duplicate**, or **dupdisc**.

If the value of the **naction** parameter is **forward**, **duplicate**, or **dupdisc**, then the **nmapset** parameter must be specified.

The **naction** parameter must have a value of **forward**, **duplicate**, or **dupdisc** before the **npc/npc/npci/npci/npcn/npcn24**, **nssn**, **nri**, **ntt**, or **naction** parameters can be specified. If the **naction** parameter has a value of **forward**, **duplicate**, or **dupdisc**, then the **npc/npc/npci/npci/npcn/npcn24** parameter and the **nssn** parameter must be specified.

The Flexible GTT Load Sharing feature must be enabled before the **nmapset** parameter can be specified.

The specified new MAP set must exist in the MAP table.

If the value of the **nmapset** parameter is not **dflt**, or if the **nmapset=dflt** parameter is specified, but the value of the **force** parameter is not **yes**, then the values for the **npc** and **nssn** parameters must exist in the new MAP set.

If the **nmapset**, **nri**, or **ntt** parameter is specified, and the **naction** parameter is not specified, then the **naction** parameter (see the **ent-gsmmap-scrn** command) must have a value of **forward**, **duplicate**, or **dupdisc**.

The **force** parameter can be specified only if the **nmapset** parameter is specified.

If the value of the **naction** parameter is **forward**, **duplicate**, or **dupdisc**, then the value specified for the **npc/npc/npci/npci/npcn/npcn24** parameter cannot be associated with a proxy point code.

If the **nri=ssn** parameter is specified, then the **nssn=none** parameter cannot be specified.

If the **nforbid=none** parameter is specified, then the **naction** parameter must have a value of **pass**.

## Notes

Unlike GTT (Global Title Translation) entries, the GSM MAP Screening commands do not support splits of ranges during deletion or changes of entries.

In this command, only ITU-international and ITU national point codes support the spare point code subtype prefix (**s-**).

**Output**

```

chg-gsmmap-
scrn:opname=test2:naction=duplicate:npc=1-1-2:nssn=20:cgsr=cg1:nm
apset=df1t
    tekelecstp 06-05-29 13:24:41 EST EAGLE 35.0.0
    GSM Map Screening table is (3 of 4000) 1% full
    CHG-GSM MAP-SCRN: MASP A - COMPLTD
;

chg-gsmmap-scrn:opname=test3:cgsr=ad:nri=ssn
    tekelecstp 08-01-18 17:34:53 EST EAGLE 38.0.0
    GSM MAP Screening Table (4 of 4000) is 1% full
    CHG-GSM MAP-SCRN: MASP A - COMPLTD
;

chg-gsmmap-scrn:opname=test4:cgsr=ks1:ntt=12
    tekelecstp 08-08-20 19:13:01 EST EAGLE 39.2.0
    GSM MAP Screening Table (1 of 4000) is 1% full
    CHG-GSM MAP-SCRN: MASP A - COMPLTD
;

```

**chg-gsmopts****Change GSM System Options**

Use this command to enter GSM (Global System for Mobile Telecommunications) system options in the database. This command updates the GSMOPTS Table.

**Keyword:** chg-gsmopts

**Related Commands:** chg-gsmsmopts, rtrv-gsmopts, rtrv-gsmsmopts

**Command Class:** Database Administration

**Parameters**

**NOTE:** See "Point Code Formats and Conversion" for a detailed description of point code formats, rules for specification, and examples.

**:ccnc=** (optional)

E214 country code and network code.

**Range:** 2-8 digits

**Default:** No change to current value

**:defmapvr=** (optional)

Default MAP version.

**Range:** 1-3

**Default:** No change to the current value

**System**

**Default:** 1

**:defmcc=** (optional)

E212 default mobile country code.

**Range:** 3 digits, none

Valid digits are 0-9, A-F, a-f.

none—Deletes the current value for the defmcc parameter.

**Default:** No change to the current value

**System**

**Default:** none

**:defmnc=** (optional)

E212 default mobile network code.

**Range:** 1-4 digits, **none**  
 Valid digits are **0-9, A-F, a-f**.  
**none**—Deletes the current value for the **defmnc** parameter.  
**Default:** No change to the current value  
**System**  
**Default:** **none**

**:dfltrn=** (optional)  
 Default routing number. This parameter specifies the digits to use as the routing number portion of the **msrndig** parameter when an SRI is processed by the SRI Query for Prepaid feature, an RTDB match is found for an own-network subscriber, and Service Portability is not applied.

**Range:** 1-15 digits, **none**  
**Default:** No change to the current value  
**System**  
**Default:** **none**

**:eirgrsp=** (optional)  
 Equipment Identity Register (EIR) Global Response status.

**Range:** **off, whitelst, graylst, blklst, unknown**  
**off**— EIR Global Response is not used.  
**whitelst**— Indicates that the IMEI is “valid” and registration should be allowed for this handset.  
**graylst**— Indicates that the IMEI is “questionable.” Registration should be allowed, but the event is logged in the EIR log and a special measurement peg is incremented.  
**blklst**— Indicates that the IMEI is “invalid” and registration should not be allowed for this handset.  
**unknown**— Indicates that the IMEI is not in the White list, the Gray list, or the Black list and registration should not be allowed for this handset.  
**Default:** No change to the current value  
**System**  
**Default:** **off**

**:eirmsichk=** (optional)  
 Equipment Identity Register (EIR) IMSI Check status. This parameter is not valid for IMEI ranges.

**Range:** **on, off**  
**Default:** No change to the current value  
**System**  
**Default:** **off**

**:eirrsptype=** (optional)  
 Equipment Identity Register (EIR) Response Type.

**Range:** **type1, type2, type3**  
 Table 5-10 contains information to help you choose the value for this parameter.

**Table 5-10.** EIR Response Type (**eirrsptype**) Values

Presence in List			EIR Response Type		
White	Gray	Black	Type 1	Type 2	Type 3
X			in white list	in white list	in white list
X	X		in gray list	in gray list	in gray list
X	X	X	in black list	in black list	in black list

**Table 5-10. EIR Response Type (eirrsptype) Values**

Presence in List			EIR Response Type		
White	Gray	Black	Type 1	Type 2	Type 3
X		X	in black list	in black list	in black list
	X		in gray list	in gray list	unknown
	X	X	in black list	in black list	unknown
		X	in black list	in black list	unknown
			in white list*	unknown*	unknown*

\* This entry in the table indicates that there has been no match found for the IMEI in an incoming message within the database.

**Default:** No change to the current value

**System**

**Default:** type1

**:gflexmaplayerrtg=** (optional)

G-Flex MAP layer routing status. This parameter specifies whether G-Flex MAP layer routing is performed.

**Range:** on, off

**Default:** No change to current value

**System**

**Default:** off

**:gsm2is41=** (optional)

GSM to IS41 migration prefix.

**Range:** 1-15 digits, none

Valid digits are **0-9, A-F, a-f**.

**none**—Deletes the current value of the **gsm2is41** parameter.

**Default:** No change to the current value

**System**

**Default:** none

**:is412gsm=** (optional)

IS-41 to GSM migration prefix. To specify this parameter, the G-Port feature must be turned on.

**Range:** Valid digits are **0-9, A-F, a-f**.

**none**—Deletes the current value of the **is412gsm** parameter.

**:is412gsm=** (optional)

IS41 to GSM migration prefix.

**Range:** 1-15 digits, none

Valid digits are **0-9, A-F, a-f**.

**none**—Deletes the current value of the **is412gsm** parameter.

**Default:** No change to the current value

**System**

**Default:** none

**:mccmnc=** (optional)

E212 mobile country code and mobile network code.

**Range:** 4-7 digits, **none**  
Valid digits are **0-9, A-F, a-f**.  
**none**—Deletes the current **mccmnc** and **ccnc** parameter combination entry.

**Default:** No change to current value

**:migrpfx=** (optional)

Migration prefix. This parameter specifies whether the database routing number (RN) or the GSM to IS-41 Migration prefix is used as the source for the prefix in the SRI ACK response message for a migrated subscriber.

**Range:** **single, multiple**

**single**— The RN from the RTDB lookup is not used as the prefix in the SRI Ack. If the **gsm2is41** parameter has a value other than **none**, then that value is used as the prefix in the SRI Ack Response.

**multiple**— The RN from the database lookup is used as the prefix in the SRI Ack response.

**Default:** No change to the current value

**System** **single** - A value of **single** is the system default value for a new system, or for a system

**Default:** that upgraded to 36.0 without the IGM feature being turned on. If the IGM feature was turned on before upgrade to 36.0, then a value of **multiple** is hardcoded as the system default value.

**:msisdntrunc=** (optional)

MS ISDN truncation digits. Specifies number of digits to delete from the beginning of the National MSISDN (MSISDN without Country Code) before formulating the MSRN parameter of the SRI-ack response. The G-Port feature or the IGM feature must be enabled before this parameter can be specified.

**Range:** **0-5**

**Default:** No change to current value

**System**

**Default:** **0**

**:msrndig=** (optional)

The routing number to be used as is or to be concatenated with the MSISDN. The G-Port feature or the IGM feature must be enabled before this parameter can be specified.

**Range:** **rn, rndn, ccrndn, rnccdn, rnasd, asdrn, rnasddn, asdrndn, ccrnasddn, ccasdrndn, rnasdcdn, asdrnccdn, rngrn, grnrn, rngrndn, grnrndn, cerngrndn, ccgrnrndn, rngrnccdn, grnrnccdn**

**rn**— Routing number

**rndn**— Routing number prefix and the international DN (dialed/directory number)

**ccrndn**— Country code, routing number, and national directory number

**rnccdn**— Routing number, country code and directory number

**rnasd**— Routing number and additional subscriber data

**asdrn**— Additional subscriber data and routing number

**rnasddn**— Routing number, additional subscriber data, and directory number

**asdrndn**— Additional subscriber data, routing number, and directory number

**ccrnasddn**— Country code, routing number, additional subscriber data, and directory number

**ccasdrndn**— Country code, additional subscriber data, routing number and directory number

**rnasdcdn**— Routing number, additional subscriber data, country code, and directory number

**asdrnccdn**— Additional subscriber data, routing number, country code, and directory number

**rngrn**— Routing number and generic routing number

**grnrn**— Generic routing number and routing number



**rngrndn**— Routing number, generic routing number, and directory number

**grnrndn**— Generic routing number, routing number, and directory number

**ccrnrndn**— Country code, routing number, generic routing number, and directory number

**ccgrnrndn**— Country code, generic routing number, routing number, and directory number

**rngrncdn**— Routing number, generic routing number, country code, and directory number

**grnrncdn**— Generic routing number, routing number, country code, and directory number

**Default:** No change to the current value

**System**

**Default:** **rn**

**:msrnnai=** (optional)

The nature of address indicator value for the MSRN. The G-Port feature or the IGM feature must be enabled before this parameter can be specified.

This parameter is mandatory if the **msrnp** parameter is specified.

**Range:** **0-7**

**0**—Unknown Nature of Address

**1**—International Number

**2**—National Significant Number

**3**—Network Specific Number

**4**—Subscriber Number

**5**—Reserved for national use

**6**—Abbreviated Number

**7**—Reserved for extension

**Default:** No change to current value

**:msrnp=** (optional)

The numbering plan value for the MSRN. The G-Port feature or the IGM feature must be enabled before this parameter can be specified.

This parameter is mandatory if the **msrnnai** parameter is specified.

**Range:** **0-15**

**Default:** No change to current value

**:multcc=** (optional)

Multiple country code.

**NOTE: The G-Port or IGM feature must be enabled or the V-Flex feature must be turned on before this parameter can be specified.**

**Range:** 1-3 digits

Valid digits are **0-9, A-F, a-f**.

**Default:** No change to current value

**:nmultcc=** (optional)

New multiple country code. This parameter changes the **multcc** value to the specified **nmultcc** value, or deletes the **multcc** value if **nmultcc=none** is specified.

**NOTE: The G-Port or IGM feature must be enabled or the V-Flex feature must be turned on before this parameter can be specified.**

**Range:** 1-3 digits, **none**

Valid digits are **0-9, A-F, a-f**.

**none**—Deletes the specified **multcc** value from the multiple country code list.

**Default:** No change to current value

**:serverpfx=** (optional)

Server SRI prefix. The G-Port feature or the IGM feature must be enabled before this parameter can be specified.

**Range:** 1-4 digits, **none**  
Valid digits are **0-9, A-F, a-f**.  
**none**—No Server SRI prefix is provisioned

**Default:** No change to current value

**System**

**Default:** **none**

**:sporttype=** (optional)

Service Portability type. This parameter specifies whether Service Portability applies to SRI Query for Prepaid messages for own-network subscribers.

The S-Port and SRI Query for Prepaid features must be enabled before this parameter can be specified. The S-Port feature must be turned on before any change to the parameter will impact the G-Port SRI Query for Prepaid feature.

**Range:** **gsm, is41, all, none**  
**gsm**—Apply Service Portability prefix (RTDB GRN Entity ID) for own-network GSM subscribers.  
**is41**—Apply Service Portability prefix (RTDB GRN Entity ID) for own-network IS41 subscribers.  
**all**—Apply Service Portability prefix (GRN from RTDB entity) for all own-network (IS41 and GSM) subscribers.  
**none**—Service Portability is not performed for this feature.

**Default:** No change to the current value

**System**

**Default:** **none**

**:srfaddr=** (optional)

Entity address of the MNP\_SRF node. The G-Port feature or the IGM feature must be enabled before this parameter can be specified.

This parameter is mandatory if the **srfnai** and **srfnp** parameters are specified.

**Range:** 1-15 digits, **none**  
Valid digits are **0-9, A-F, a-f**.  
**none**—Deletes the current value for the **srfaddr** parameter.

**Default:** No change to current value

**System**

**Default:** **none**

**:srfnai=** (optional)

The nature of address indicator value of the MNP\_SRF. The G-Port feature or the IGM feature must be enabled before this parameter can be specified.

This parameter is mandatory if the **srfaddr** and **srfnp** parameters are specified.

**Range:** **0-127**

**Default:** No change to current value

**:srfnp=** (optional)

The numbering plan value of the MNP\_SRF. The G-Port feature or the IGM feature must be enabled before this parameter can be specified.

This parameter is mandatory if the **srfnai** and **srfaddr** parameters are specified.

**Range:** **0-15**

**Default:** No change to current value

**:sridn=** (optional)

The Send Routing Information Dialed Number location. The G-Port feature or the IGM feature must be enabled before this parameter can be specified.

**Range:** **tcap, sccp**

**Default:** No change to current value

**System**

**Default:** **tcap**

**:sridnnotfound=** (optional)

This parameter specifies the processing that is used when G-Port encounters an RTDB query result that indicates that the specified directory number is not known.

**Range:** **gtt, srinack**

**gtt** — GTT is performed on the message for routing to an HLR

**srinack** — an SRI negative acknowledgement is generated and returned to the calling party

**Default:** No change to the current value

**System**

**Default:** **gtt**

**Example**

```
chg-
gsmopts:msisdntrunc=1:srfaddr=123456789abcdef:srfnai=0:srfnp=0
chg-gsmopts:msrnnai=1:msrnp=1:msrndig=ccrndn:defmapvr=2
chg-gsmopts:sridn=sccp
chg-gsmopts:is412gsm=1234:gsm2is41=1234
chg-gsmopts:serverpfx=1000
chg-gsmopts:multcc=011
chg-gsmopts:multcc=011:nmultcc=11
chg-gsmopts:ccnc=33322123:mccmnc=21434
chg-gsmopts:eirimsichk=on:eirrsptype=type2:eigrsp=blk1st
chg-gsmopts:migrpfx=multiple
chg-gsmopts:sridnnotfound=srinack
chg-gsmopts:defmcc=214:defmnc=34
chg-gsmopts:msrndig=rnsd
chg-gsmopts:msrndig=rngrndn
```

**Dependencies**

At least one parameter must be specified.

The G-Flex feature must be turned on before the **defmnc**, **ccnc**, or **mccmnc** parameter can be specified.

The G-Port or IGM feature must be enabled before the following parameters can be specified: **srfaddr**, **msrndig**, **msrnnai**, **sridn**, **msisdntrunc**, **migrpfx**, **gsm2is41**, **serverpfx**.

An **is412gsm** parameter value must exist in the database before the **serverpfx** parameter can be specified.

The **serverpfx** value must be set to **none** in the database before the **is412gsm** value can be set to **none**.

The EIR feature must be enabled and turned on before the following parameters can be specified: **eirgrsp**, **eirsptype**, **eirimsichk**.

The **ccnc** and **mccmnc** parameter values must be specified together in the command.

A maximum of 10 **ccnc** records can exist in the database.

The value specified for the **ccnc** parameter cannot already exist in the database unless the **mccmnc=none** parameter is specified.

The **srfaddr**, **srfnai**, and **srfnp** parameters must be specified together in the command.

The **msrnnai** and **msrnp** parameters must be specified together in the command.

The value specified for the **ccnc** parameter must already exist in the database if the **mccmnc=none** parameter is specified.

A maximum of 10 entries can be defined in the multiple country code list (in addition to the STP options **defcc** value).

A multiple country code cannot be entered when the STP options **defcc** value is none. A **defcc** value must first be defined before the first multiple country code can be entered. See the **chg-stpopts** command.

If the **multcc** parameter is specified to enter a new value in the multiple country code list, then the value specified for the parameter cannot already exist in the list.

The value specified for the **nmultcc** parameter cannot already exist in the multiple country code list.

If the **multcc** and **nmultcc** parameters are specified to change the **multcc** value to the **nmultcc** value, then the **multcc** value must already exist in the multiple country code list.

The specified **multcc** and **nmultcc** values cannot already be defined as the STP options **defcc** parameter value.

The IGM feature must be enabled before the **is412gsm**, **gsm2is41**, or **migrpfx** parameter can be specified.

The G-Port, IGM, MO SMS ASD, MO SMS B-Party Routing, MO SMS GRN, MO SMS IS41-to-GSM Migration, MO-based GSM SMS NP, or Prepaid SMS Intercept Ph1 feature must be enabled, or the G-Flex, EIR, or V-Flex feature must be turned on before this command can be entered.

The G-Port or IGM feature must be enabled or the V-Flex feature must be turned on before the **multcc** and **nmultcc** parameters can be specified.

The G-Flex MAP Layer Routing feature must be enabled and turned on before the **gflexmaplayerrrtg** parameter can be specified.

The G-Flex or G-Port feature must be turned on or the MT-Based GSM SMS NP or IGM feature must be enabled before the **defmcc** parameter can be specified.

If the MT-Based GSM SMS NP feature is turned on, then the **defmcc=none** parameter cannot be specified.

The **nmultcc** and **multcc** parameters must be specified together in the command.

If the **multcc** parameter is specified to enter a new value in the multiple country list, then the specified value cannot already exist in the list.

The IGM or MO SMS IS41-to-GSM Migration feature must be enabled before the **is412gsm** parameter can be specified.

The G-Port feature must be enabled before the **sridnotfound** parameter can be specified.

The G-Port feature must be turned on before the **migrpfx=multiple** parameter can be specified.

The G-Port, IGM, MO SMS ASD, MO SMS B-Party Routing, MO SMS GRN, MO-based GSM SMS NP, or Prepaid SMS Intercept Ph1 feature must be enabled before the **defmapvr** parameter can be specified.

The G-Port SRI Query for Prepaid feature must be enabled before the **dfltrn** parameter can be specified.

The S-Port and G-Port SRI Query for Prepaid features must be enabled before the **sporttype** parameter can be specified.

The G-Flex feature must be turned on or the G-Port or IGM feature must be enabled before the **ccnc** and **mccmnc** parameters can be specified.

### Notes

The **sridn** parameter can be used with the G-Port feature only or with the G-Port feature and the MNP Circular Route Prevention feature. Refer to the *Feature Manual - G-Port* for more information.

If the IGM feature was turned on prior to upgrade to Release 36.0, then the migration prefix is hard-coded to a value of **multiple**. After upgrade, if the **chg-gsmopts:migrpfx=single** command is used to change the migration prefix to **single**, then the G-Port feature must be turned on before the migration prefix can be changed back to **multiple** (**chg-gsmopts:migrpfx=multiple**).

### Output

```
chg-gsmopts:msrnnai=1:msrnnp=1:msrndig=ccrngrndn:defmapvr=2
tekelecstp 09-05-05 12:28:07 EST EAGLE 41.1.0
CHG-GSMOPTS: MASP A - COMPLTD
;
```

## chg-gsms-opcode

### Change GSM MAP Screening Operation Code

Use this command to change the attributes of the GSM (Global System for Mobile Telecommunication) MAP (mobile application part) screening operation codes. The command allows you to change the default screening action and the operation-code name for a specific operation code.

**Keyword:** **chg-gsms-opcode**

**Related Commands:** **dlt-gsms-opcode**, **ent-gsms-opcode**, **rtrv-gsms-opcode**

**Command Class:** Database Administration

### Parameters

**NOTE:** See "**Point Code Formats and Conversion**" for a detailed description of point code formats, rules for specification, and examples.

**:opname=** (mandatory)

Operation code name. This parameter specifies the user-defined name for the operation code. The **opname** value is defined with the **ent-gsms-opcode** command.

**Range:** *ayyyyyyy*  
Up to 8 alphanumeric characters

**:force=** (optional)

Check Mated Application Override. This parameter must be used to complete command execution if the **npc/npca/npci/npcn/npcn24** and **nssn** parameter combination specified in the command is not already defined in the SCCP Application entity set (Remote Point Code/Mated Application Table).

**Range:** **yes, no**

**Default:** **no**

**:ndfltact=** (optional)

New default screening action.

**Range:** **pass, discard, atierr, route, forward, duplicate, dupdisc**

**pass**—Route the message as normal to the destination; a UIM will be issued. This is intended to be a test mode and is recommended when setting up GSM Map Screening during the initial phase to assure that no MSUs will be inadvertently thrown away.

**discard**—Do not route the MSU. The MSU is discarded (thrown away) and an appropriate UIM is issued.

**atierr**—Do not route the MSU. An ATI (Any Time Interrogation) reject message is generated to the originator. This value is valid only for ATI MAP operation codes.

**route**—Route the message as normal to the original destination node; no UIM will be generated. The original destination is the node to which normal GTT would be sent if no GSM MAP actions are taken.

**forward**—Route the original message to the forward node. The original message will not be sent to the original node. If, however, the forward node is not available for routing, the MSU is routed to the original node.

**duplicate**—Route the message as normal to the original destination and route a copy of the original message to the duplicate node. If the MSU fails to route to the duplicate node, a UIM is generated indicating the duplicate routing failure.

**dupdisc**—Route the original message to the duplicate node. The original message will not be sent to the original node. If, however, the duplicate node is not available for routing, the MSU is discarded.

**Default:** No change to the existing value

**:nmapset=** (optional)

New MAP set ID.

**Range:** **1-36000 dflt**  
**dflt**—Default MAP set

**:nopname=** (optional)

This parameter specifies the new user-defined name for the operation code.

**Range:** *ayyyyyyy*  
 Up to 8 alphanumeric characters

**Default:** No change to current value

**:npc=** (optional)

ANSI point code with subfields *network indicator-network cluster-network cluster member (ni-nc-ncm)*.

**Synonym:** **npca**

**Range:** **000-255**

Specify a valid value for each subfield of the point code, and separate the subfields with a dash (-).

When **chg-sid:pctype=ansi** is specified, **ni = 000** is not valid.

When **chg-sid:pctype=ansi** is specified, **nc = 000** is not valid if **ni = 001-005**.

When **chg-sid:pctype=ansi** is specified, **nc = 000** is valid if **ni = 006-255**.

The point code **000-000-000** is not a valid point code.

**:npc/npca/npci/npcn/npcn24=** (optional)

New point code. The **npc/npca/npci/npcn/npcn24** and **nssn** parameters are used when the default screening action (**dfltact**) is **forward, duplicate, or dupdisc** (duplicate and discard). These parameters allow the craftsperson to change the defined node to which the input message will be routed.

**:npci=** (optional)

New ITU international point code with subfields *zone-area-id*. The *prefix* subfield indicates a spare point code (*prefix-zone-area-id*).

**Range:** **s-, 0-255**

Specify a valid value for each subfield of the point code, and separate the subfields with a dash (-).

*prefix*—**s-**

*zone*—**0-7**

*area*—**000-255**

*id*—**0-7**

The point code **0-000-0** is not a valid point code.

**:npcn=** (optional)

New ITU national destination point code in the format of a 5-digit number (*nnnnn*); or 2, 3, or 4 numbers (members) separated by dashes (*m1-m2-m3-m4*) as defined by the **chg-stpopts:npcfnti** flexible point code option. A group code must be specified when the ITUDUPPC feature is turned on (*nnnnn-gc*, *m1-m2-m3-m4-gc*). The *prefix* subfield indicates a spare point code (*prefix-nnnnn*, *prefix-nnnnn-gc*, *prefix-m1-m2-m3-m4*, *prefix-m1-m2-m3-m4-gc*).

**Range:** **s-, 0-16383, aa-zz**

Specify a valid value for each subfield of the point code, and separate the subfields with a dash (-).

*prefix*—**s-**

*nnnnn*—**0-16383**

*gc*—**aa-zz**

*m1-m2-m3-m4*—**0-14** for each member; values must sum to 14

**:npcn24=** (optional)

New 24-bit ITU national point code with subfields *main signaling area-sub signaling area-signaling point* (*msa-ssa-sp*).

**Range:** **000-255**

Specify a valid value for each subfield of the point code, and separate the subfields with a dash (-).

*msa*—**000-255**

*ssa*—**000-255**

*sp*—**000-255**

**:nri=** (optional)

New routing indicator. This parameter specifies whether a subsequent global title translation is required.

This parameter can be specified only when the screening action is **forward**, **duplicate** or **dupdisc**.

**Range:** **gt, ssn**

**:nssn=** (optional)

New Subsystem Number. The **npc/npcn/npci/npcn/npcn24** and **nssn** parameters are used when the new default screening action (**ndfltact**) is **forward**, **duplicate**, or **dupdisc** (duplicate and discard). These parameters allow the craftsperson to change the defined node to which the input message will be routed.

**Range:** **002 - 255 none**

**Default:** No change to the existing value

**:ntt=** (optional)

New translation type. This parameter specifies the value that the CdPA TT is set to as the result of Enhanced GSM Map Screening.

**This parameter can be specified only if the screening action is forward, duplicate, or dupdisc.**

**Range:** 0-255 none

**Default:** No change to the existing value

### Example

```
chg-gsms-opcode:opname=ati:ndfltact=atierr
chg-gsms-
opcode:opname=ati:ndfltact=forward:npci=1-1-1:nssn=5:force=yes
chg-gsms-opcode:opname=xyz:npca=9-9-9:nssn=3
chg-gsms-opcode:opname=test2:npci=s-1-1-1

chg-gsms-
opcode:opname=test2:ndfltact=dupdisc:npci=1-1-1:nssn=5:nmapset=8
chg-gsms-
opcode:opname=ts4:ndfltact=forward:npc=1-1-2:nssn=5:nmapset=df1t
chg-gsms-opcode:opname=test:nri=ssn
chg-gsms-opcode:opname=test4:ntt=12
```

### Dependencies

At least one optional parameter must be specified.

If the **ndfltact** parameter is specified and its value is **forward**, **duplicate**, or **dupdisc**, the **npc/npca/npci/npcn/npcn24** and **nssn** parameters must be specified.

The reserved word **none** cannot be specified as a value for the **opname** parameter or **nopname** parameter.

If the **npc/npca/npcinpcn/npcn24** and **nssn** parameters are specified with the **ndfltact** parameter, the **ndfltact** parameter value must be **forward**, **duplicate**, or **dupdisc**.

The **force** parameter can be specified only if the **npc/npca/npci/npcn/npcn24** parameter and the **nssn** parameter are specified.

The value specified for the **opname** parameter must already exist in the GSM Map Op-Code table.

The GSM Map Screening feature (see the **enable-ctrl-feat** command) must be turned on before this command can be entered.

The EGMS feature must be enabled and turned on before the **npc** or **npca** parameters can be specified.

The **ndfltact=atierr** parameter cannot be specified unless the value of the operation code referenced by the **opcode** parameter is **71**. The **atierr** option is valid only for ATI MAP operation codes, and the **opcode=71** parameter signifies an ATI MAP operation code.

If specified, the **npc/npca/npci/npcn/npcn24** parameter value must be a full point code.

If the **npc/npca/npci/npcn/npcn24** parameter and the **nssn** parameter are specified, and the **force** parameter is not specified as **yes**, the PC-SSN must be populated in the SCCP Application entity set (Remote Point Code / Mated Application Table).

If specified, the **npc/npca/npci/npcn/npcn24** parameter value must exist as a destination in the Ordered Route entity set or reside in a cluster (ANSI only) that exists as a destination in the Ordered Route entity set (for global title routing).

The **nmapset** parameter must be specified if the value of the **ndfltact** parameter is **forward**, **duplicate**, or **dupdisc**.



If the **ndfltact** parameter is specified with the **nmapset**, **nri**, or **ntt** parameters, or the **pc** or **ssn** parameters, then the **ndfltact** parameter must have a value of **forward**, **duplicate**, or **dupdisc**.

The **force** parameter can be specified only if the **nmapset** parameter is specified.

The Flexible GTT Load Sharing feature must be enabled before the **nmapset** parameter can be specified.

The specified new MAP set must exist.

If the **nmapset=dflt** parameter is not specified, or the **nmapset=dflt** parameter is specified, but the **force=yes** parameter is not specified, then the new PC and new SSN must exist in the new MAP set.

If the **nmapset**, **nri**, or **ntt** parameter is specified, and the **ndfltact** parameter is not specified, then the **dfltact** parameter must have a previously provisioned value of **forward**, **duplicate**, or **dupdisc**.

If the value of the **ndfltact** parameter is **forward**, **duplicate**, or **dupdisc**, then the value specified for the **npc/npca/npci/npcn/npcn24** parameter cannot be associated with a proxy point code.

If the **nri=ssn** parameter is specified, then the **ssn=none** parameter cannot be specified.

## Notes

In this command, only ITU-international and ITU national point codes support the spare point code subtype prefix (s-).

## Output

```
chg-gsms-
opcode:opname=ts4:ndfltact=forward:npc=1-1-2:nssn=5:nmapset=dflt
tekelecstp 06-06-01 10:19:51 EST EAGLE 35.0.0
CHG-GSMS-OPCODE: MASP A - COMPLTD
;

chg-gsms-opcode:opname=test:nri=ssn
tekelecstp 08-01-18 17:32:16 EST EAGLE 38.0.0
CHG-GSM-OPCODE: MASP A - COMPLTD
;

chg-gsms-opcode:opname=test4:ntt=12
tekelecstp 08-08-20 19:13:01 EST EAGLE 39.2.0
CHG-GSM-OPCODE: MASP A - COMPLTD
;
```

## chg-gsmsmsopts

## Change GSM SMS System Options

Use this command to enter GSM SMS system options in the database. This command updates the GSMSMSOPTS table.

**Keyword:** chg-gsmsmsopts

**Related Commands:** chg-gsmopts, rtrv-gsmopts, rtrv-gsmsmsopts

**Command Class:** Database Administration

## Parameters

**NOTE:** As of Release 40.1, the **mosmsdnfmt** and **mosmsdnnai** parameters are obsolete.

**:bpartygttsn=** (optional)

MO SMS B-Party Routing GTT Set name. This parameter specifies the GTT set where Global Title Translation lookup on B-Party digits is performed.

**Range:** ayyyyyyy

1 leading alphabetic and up to 8 following alphanumeric characters.

**Default:** No change to the current value

**System**

**Default:** none

**:defis41smsc=** (optional)

Default IS41 short message service center. This parameter specifies the default SMSC where an SRI\_SM message received for an own network IS41 subscriber is relayed.

If the **igmsmsrelay=yes** parameter is specified, then this parameter must be specified.

**Range:** 1-15 digits, none

**Default:** No change to the current value

**System**

**Default:** none

**:defrn=** (optional)

Default routing number. This parameter specifies a default routing number that is used for own-network subscribers.

**Range:** 1-15 digits, none

Valid digits are **0-9, A-F, a-f**.

**Default:** No change to the current value

**System**

**Default:** none

**:igmsmsrelay=** (optional)

IGM - based SMS relay. This parameter specifies whether IGM relays an SRI\_SM message that is received for an own network IS41 subscriber to a default SMSC or sends an SRI\_SM-NACK error message.

**Range:** yes, no

**yes** — IGM relays the message to the default SMSC

**no** — IGM sends an SRI\_SM-NACK

**Default:** No change to the current value

**System**

**Default:** no

**:is41smscgttsn=** (optional)

IS41 SMSC GTT Set name. This parameter specifies the GTT set where Global Title Translation lookup on default IS41 SMSC digits is performed.

**Range:** ayyyyyyyy

1 leading alphabetic and up to 8 following alphanumeric characters.

**Default:** No change to the current value

**:mosmsaclen=** (optional)

This parameter specifies the number of the digits that are taken from the MO SMS CgPA and used as the Area Code in the MO SMS CdPA.

**Range:** 0-8

**Default:** No change to the current value

**System**

**Default:** 0

**:mosmsdigmat=** (optional)

MO-based SMS Home SMSC match. This parameter specifies the method used by the Portability Check for MO SMS or the MO-based GSM SMS NP feature to find a Home SMSC match.

**Range:** exact, bestfit

**exact** — The system searches for an exact match of digits in the HomeSMSC Table.

**bestfit** — The system searches for a match on the leading digits of an incoming message with any provisioned entry in HomeSMSC table if an exact match is not found.

**Default:** No change to the current value  
**System**  
**Default:** **exact**

**:mosmsfwd=** (optional)

MO-based SMS forward. This parameter specifies whether the value of the SCCP CDPA in the MO-based SMS message is modified to the GTA value that is specified by the **mosmsgta** parameter.

**Range:** **yes, no**  
**yes** — The SCCP CDPA value is modified.  
**no** — The SCCP CDPA value is not modified.  
The **mosmsgta** parameter must be specified before the **mosmsfwd=yes** parameter can be specified.

**Default:** No change to the current value  
**System**  
**Default:** **no**

**:mosmsgta=** (optional)

MO-based SMS GTA. This parameter specifies the GTA value that is used to replace the SCCP CDPA value in the MO-based SMS message.

**Range:** 5-21 digits, **none**  
**Default:** No change to the current value  
**System**  
**Default:** **none**

**:mosmsgttdig=** (optional)

MO SMS B-Party Routing GTT digits. This parameter specifies the digits that are used for Global Title Translation.

**Range:** **sccpcdpa, mapbparty**  
**sccpcdpa** — The SCCP CdPA is used for GTT.  
**mapbparty** — The MAP B-Party number is used for GTT.  
**Default:** No change to the current value  
**System**  
**Default:** **sccpcdpa**

**:mosmsnai=** (optional)

MO-based SMS NAI. This parameter specifies the number conditioning that is performed on the SMS message destination address before lookup in the number portability database is performed.

**Range:** **intl, nai, nat, unknown**  
**intl** — Number is treated as INTL (1) for number conditioning.  
**nai** — The NAI from the SMS message is used to perform number conditioning.  
**nat** — Number is treated as NATL (2) for number conditioning.  
**unknown** — Number is treated as UNKNOWN (0) for number conditioning.  
A value of **nai** must be specified before the **intl, natl, nai1, nai2, nai3, and unkn** parameters in the **chg-npp-serv** command can be changed to non-default values for the MOSMSGCDPN service.

**Default:** No change to the current value  
**System**  
**Default:** **intl**

**:mosmssa=** (optional)

MO-based SMS sub-address. This parameter specifies whether sub-address is searched in the SMS called party (destination address).

**Range:** **yes, no**  
**yes** — Sub-address is searched in the SMS called party.

- no**— Sub-address is not searched in the SMS called party.
- Default:** No change to the current value
- System**
- Default:** **no**
- :mosmstcapseg=** (optional)  
MO-based SMS TCAP Segmentation for GSM. This parameter specifies whether Mobile-Originated segmented TCAP messages are supported.
- Range:** **on, off**  
**on**— Segmented messages are supported.  
**off**— Segmented messages are not supported.
- Default:** No change to the current value
- System**
- Default:** **off**
- :mosmstype=** (optional)  
MO-based SMS type. This parameter specifies the value of the entity type that indicates that a successful lookup occurred in the number portability database.
- Range:** **sp, rn, sprn, all**  
**sp**— signaling point  
**rn**— routing number  
**sprn**— Lookup is successful if the value of the entity type is **sp** or **rn**.  
**all**— Lookup is successful if the value of the entity type is **sp** or **rn**, or if no entity type is found.
- Default:** No change to the current value
- System**
- Default:** **sprn**
- :mtmmsackn=** (optional)  
MT-Based MMS acknowledgement. This parameter specifies the message that is generated in response to a successful number portability database lookup for an SRI\_SM message from a Home MMSC.
- Range:** **ack, nack**  
**ack**— SRI\_SM\_ACK message  
**nack**— SRI\_SM\_NACK (Return Error) message
- Default:** No change to the current value
- System**
- Default:** **ack**
- :mtmmsentilen=** (optional)  
MT-Based MMS Entity length. This parameter specifies the maximum number of digits that are used from the entity value of a returned RN, SP, or SRFIMSI entity for Multimedia Service (MMS) processing.
- Range:** **1-15 none**  
**none**—all digits from the entity value are used
- Default:** No change to the current value
- System**
- Default:** **none**
- :mtmmsgta=** (optional)  
MT-Based MMS GTA. This parameter specifies the GTA that is compared with the SCCP CgPA GTA of an SRI\_SM message to determine whether the originator of the message is a Home MMSC.
- Range:** 5-21 digits, **none**  
Valid digits are **0-9, A-F, a-f**.  
**none**—Deletes the current value of the **mtmmsgta** parameter.

**Default:** No change to the current value  
**System**  
**Default:** none

**:mtmmslen=** (optional)

MT-Based MMS Length. This parameter indicates the maximum number of digits used in the returned IMSI and/or NNI fields for MMS processing.

**Range:** 1-24 none  
 none—all digits from the fields are used  
**Default:** No change to the current value  
**System**  
**Default:** none

**:mtmmstype=** (optional)

MT-Based MMS type. This parameter specifies the value of the entity type that indicates that a successful lookup occurred in the number portability database.

**Range:** sp, rn, sprn, all, nonsp  
 sp— signalling point  
 rn— routing number  
 sprn— sp or rn  
 all— sp, rn, or DN with no entity  
 nonsp— rn or DN with no entity  
**Default:** No change to the current value  
**System**  
**Default:** rn

**:mtsmsackn=** (optional)

MT-Based SMS acknowledgement. This parameter specifies the message that is generated in response to a successful number portability database lookup for an SRI\_SM message from a Home SMSC.

**Range:** ack, nack  
 ack— SRI\_SM\_ACK message  
 nack— SRI\_SM\_NACK (Return Error) message  
**Default:** No change to the current value  
**System**  
**Default:** ack

**:mtsmschksrc=** (optional)

MT-Based SMS check source. This parameter specifies whether the SCCP CgPA GTA of a SRI\_SM message is validated to determine if the source of the message is a Home SMSC.

**Range:** yes, no  
 yes— The SCCP CgPA GTA of an SRI\_SM message is validated.  
 no— The SCCP CgPA GTA of an SRI\_SM message is not validated.

If the **mtsmschksrc=yes** parameter is specified, and if the incoming SRI\_SM message has SCCP CgPA GTA, then the SCCP CgPA GTA must be found in the Home SMSC list for the source of the message to be considered a Home SMSC. If the message is not found in the Home SMSC list, then the MT-Based GSM SMS NP feature does not process the message.

If the **mtsmschksrc=no** parameter is specified, or if SCCP CgPA GTA does not exist in the incoming message, then the source of the message is considered to be a Home SMSC, and the MT-Based GSM SMS NP feature considers the message for processing.

**Default:** No change to the current value  
**System**  
**Default:** no

**:mtsmsdltr=** (optional)

MT-Based SMS delimiter. This parameter specifies whether to insert a delimiter digit string before or after the routing number (RN) if the RN is used in the outbound digit format.

The delimiter string that is inserted is determined by the **mtsmsdltrv** parameter.

**Range:** **no, prern, postrn**

**no** — A delimiter digit string is not inserted.

**prern** — A delimiter digit string is inserted before the RN.

**postrn** — A delimiter digit string is inserted after the RN.

**Default:** No change to the current value

**System**

**Default:** **no**

**:mtsmsdltrv=** (optional)

MT-Based SMS delimiter value. This parameter specifies the delimiter digit string that is inserted before or after the RN when the RN is used in the outbound digit format.

This parameter must be specified if the value specified for the **mtsmsdltr** parameter is **prern** or **postrn**.

**Range:** 1-5 digits, **none**

Valid digits are **0-9, A-F, a-f**.

**Default:** No change to the current value

**System**

**Default:** **none**

**:mtsmsimsi=** (optional)

MT-Based SMS IMSI. This parameter specifies the required format of digits that are encoded in the “IMSI” parameter of the SRI\_SM response message.

**Range:** **rn, rndn, ccrndn, dn, srfimsi, mccrndn**

**rn** — routing number

**rndn** — routing number and the international dialed or directory number

**ccrndn** — country code, routing number, and national directory or dialed number

**dn** — directory or dialed number

**srfimsi** — IMSI is encoded as the “SRFIMSI” parameter from the number portability database.

**mccrndn** — mobile country code, routing number, and directory or dialed number

**Default:** No change to the current value

**System**

**Default:** **mccrndn**

**:mtsmsnakerr=** (optional)

MT-Based SMS negative acknowledgement error. This parameter specifies the TCAP error choice code used in the NACK response message generated for SRI\_SM messages.

**Range:** **0-255**

**Default:** No change to the current value

**System**

**Default:** **1**

**:mtsmsnni=** (optional)

MT-Based SMS network node indicator. This parameter specifies the required format of digits that are encoded in the “Network Node Number” parameter of the SRI\_SM response message.

**Range:** **rn, rndn, ccrndn, dn, srfimsi, mccrndn, none**

**rn** — routing number

**rndn** — routing number and the international dialed or directory number

**ccrndn** — country code, routing number, and national directory or dialed number

**dn** — Directory or Dialed Number

**srfimsi**— IMSI is encoded as the “SRFIMSI” parameter from the number portability database.

**mccrndn**— mobile country code, routing number, and directory or dialed number.

**none**— The Network Node Number parameter is not encoded in the response message.

**Default:** No change to the current value

**System**

**Default:** **rn**

**:mtsmstype=** (optional)

MT-Based SMS type. This parameter specifies the value of the entity type that indicates that a successful lookup occurred in the number portability database for messages that are modified by the MT-Based GSM SMS NP feature.

**Range:** **sp, rn, sprn, all, nonsp**

**sp**— signalling point

**rn**— routing number

**sprn**— **sp** or **rn**

**all**— **sp, rn,** or DN with no entity

**nonsp**— **rn** or DN with no entity

**Default:** No change to the current value

**System**

**Default:** **rn**

**:spfill=** (optional)

This parameter specifies whether the Numbering Plan Processor (NPP) can populate SP and RN entities for own network subscribers at the same time.

**Range:** **off, on**

**off**— Do not populate the RN and SP entities at the same time

**on**— Allow population of the RN and SP entities at the same time

**Default:** No change to the current value

**System**

**Default:** **off**

**:sporttype=** (optional)

Service Portability type. This parameter specifies whether Service Portability is performed for the associated feature.

**Range:** **gsm, is41, all, none**

**gsm**— Apply Service Portability prefix (RTDB ‘GRN’ entity id ) for own-network GSM subscribers

**is41**— Apply Service Portability prefix (RTDB ‘GRN’ entity id) for own-network IS41 subscribers

**all**— Apply Service Portability prefix (‘GRN’ from RTDB entity) for all own-network (IS41 and GSM) subscribers

**none**— Service Portability is not performed for the feature.

**Default:** No change to the current value

**System**

**Default:** **none**

**:mosmsdnfmt=** (obsolete)

MO-based SMS directory number format. This parameter specifies the format for the digits in the outgoing message.

This parameter is Obsolete.

**Range:** **rn, rndn, ccrndn**

**rn**— routing number (RN is used if available, otherwise DN is used)

**rndn**— routing number+directory number

**ccrndn**— country code + routing number + directory number

**Default:** rdn

**:mosmsdnnai=** (obsolete)

MO-based SMS directory number NAI. This parameter specifies the NAI that is used in the outgoing message.

This parameter is Obsolete.

This parameter modifies only the NAI field of the message.

**Range:** 0-7, none

0—unknown nature of address

1—international number

2—national significant number

3—network specific number

4—subscriber number

5—reserved for national use

6—abbreviated number

7—reserved for extension

none—The NAI from the incoming message is used.

**Default:** none

### Example

```
chg-gsmsmsopts:mosmsnai=intl:mosmstype=sp:mosmssa=no
```

```
chg-gsmsmsopts:mosmsfwd=no:mosmsgta=987654321
```

```
chg-
```

```
gsmsmsopts:mtsmsnakerr=55:mtsmsimsi=dn:mtsmsnni=rdn:mtsmstype=sp  
rn
```

```
chg-
```

```
gsmsmsopts:mtsmsackn=nack:mtsmsdltr=no:mtsmsdltrv=125:mtsmschksrc  
=no
```

```
chg-
```

```
gsmsmsopts:mtmmsgta=51111:mtmmstype=sp:mtmmsackn=nack:mtmmsentyle  
n=7:mtmmslen=10
```

```
chg-gsmsmsopts:mosmsdigmat=bestfit
```

```
chg-gsmsmsopts:bpartygttsn=setint001:mosmsgtttdig=mapbparty
```

```
chg-gsmsmsopts:mosmsaclen=4
```

```
chg-gsmsmsopts:mosmstcapseg=on
```

### Dependencies

At least one parameter must be specified.

The Hex Digit Support for GTT feature must be enabled before a hexadecimal value for the **mosmsgta** parameter can be specified.

The **mosmsgta** parameter must be specified before the **mosmsfwd=yes** parameter can be specified.

The **mtsmsdltrv** parameter must be provisioned before a value of **prern** or **postrn** can be specified for the **mtsmsdltr** parameter.

The value specified for the **bpartygttsn** or **is41smcgttsn** parameter must match the name of an existing GTT Set.

The **mosmsgtttdig=sccpcdpa** parameter must be specified before the **bpartygttsn=none** parameter can be specified.



The GTT set specified for the **bpartygttsn** or **is41smcgttsn** parameter must have **settype=cdgta** (see the **ent-gttset** command).

If the **bpartygttsn=none** parameter is specified, then the **mosmsgttdig=mapbparty** parameter cannot be specified.

The MO-based GSM SMS NP, MO SMS ASD, or MO SMS GRN feature must be enabled before the **mosmsfwd** or **mosmsgta** parameter can be specified.

The Portability Check for MO SMS feature or the MO-based GSM SMS NP feature must be turned on before the **mosmsdigmat** or **mosmstcapseg** parameter can be specified.

The MT-Based GSM SMS NP feature must be enabled before the **mtsmsimsi**, **mtsmsnni**, **mtsmstype**, **mtsmsackn**, **mtsmsdltr**, **mtsmsdltrv**, **mtsmsnakerr**, or **mtsmschksrc** parameters can be specified.

The MT-Based GSM MMS NP feature must be enabled before the **mtmmsgta**, **mtmmstype**, **mtmmsackn**, **mtmmsentyle**, or **mtmmslen** parameter can be specified.

The MO SMS B-Party Routing feature must be enabled before the **bpartygttsn** or **mosmsgttdig** parameter can be specified.

The MO-based GSM SMS NP feature must be enabled before the **mosmstype**, **defrn**, or **spfill** parameter can be specified.

The MO SMS ASD, MO SMS GRN, MO-based GSM SMS NP, or Prepaid SMS Intercept Ph feature must be enabled before the **mosmsaclen**, **mosmsnai**, or **mosmssa** parameter can be specified.

If a digit string value has already been specified for the **mosmsgta** or **mtmsdltrv** parameter, then a value of **none** cannot be specified subsequently for that parameter.

The IS41 GSM Migration feature must be turned on before the **igmsmsrelay**, **is41smcgttsn**, or **defis41smc** parameter can be specified.

If the **defis41smc=none** parameter is specified, then the **igmsmsrelay=yes** parameter cannot be specified.

If the **defis41smc** parameter has a value other than **none**, then the **is41smcgttsn=none** parameter cannot be specified.

The S-Port feature must be enabled before the **sporttype** parameter can be specified.

The EGTT feature must be turned on before the **is41smcgttsn** parameter can be specified.

## Notes

The **mosmstcapseg** parameter is turned off automatically if the Portability Check for MO SMS feature is turned off or the temporary FAK for the feature expires, and the MO-based GSM SMS NP feature is not enabled.

## Output

```
chg-
gsmsmsopts:mtmmsgta=51111:mtmmstype=sp:mtmmsackn=nack:mtmmsentyle
n=7:mtmmslen=10
  rlgncxa03w 09-07-27 12:04:05 EST  EAGLE 41.1.0
  CHG-GSMSMSOPTS: MASP A - COMPLTD
;

chg-
gsmsmsopts:is41smcgttsn=set1:defis41smc=1234:igmsmsrelay=yes
  tekelecstp 09-06-08 18:52:54 EST  EAGLE 41.1.0
  CHG-GSMSMSOPTS: MASP A - COMPLTD
;
```

**chg-gta****Change Global Title Address Information**

Use this command to change the global title address information (GTA) for applicable global title selectors required to specify a global title entry.

This command changes the routing objects for messages requiring global title translations. The specified point code, subsystem number, MRN set ID, and routing indicator overwrite the existing data values.

When the Intermediate GTT Load Sharing feature and the Flexible GTT Load Sharing feature are both on, multiple relationships can be defined among a set of destination point codes in the existing MRN table. The relationship used in a particular translation is based on the GTA digits used for translation. The MRN Set ID and the post-translation PC create a key that is used to perform a lookup in the MRN table. This lookup results in a set of alternate PCs from which a PC is selected, based on relative cost, to route the MSU in most cost-effective way.

**Keyword:** `chg-gta`

**Related Commands:** `dlt-gta`, `ent-gta`, `rtrv-gta`

**Command Class:** Database Administration

**Parameters**

**NOTE:** See "Point Code Formats and Conversion" for a detailed description of point code formats, rules for specification, and examples.

**NOTE:** As of Release 41.0, the `cggtasn`, `cgpcsn`, `cgssnsn`, and `selid` parameters are obsolete. The `optsn` parameter replaces the `cggtasn`, `cgpcsn`, and `cgssnsn` parameters. The `cgselid` or `cdselid` parameter replaces the `selid` parameter.

**NOTE:** The TCAP Opcode Based Routing (TOBR) feature must be turned on before the `cdssn` or `ecdssn` parameter can be specified. A TOBR quantity feature must be turned on before the `acn`, `family`, `opcode`, or `pkgtype` parameter can be specified.

**NOTE:** The Flexible Linkset Optional Based Routing (FLOBR) feature must be turned on before the `cdselid`, `fallback`, or `testmode` parameter can be specified.

**NOTE:** The SCCP Conversion feature must be enabled and the FLOBR feature must be turned on before the `cgcnvsn` parameter can be specified. The Origin-based SCCP Routing (OBSR) feature must be enabled or the FLOBR feature must be turned on before the `cgselid` parameter can be specified.

**NOTE:** The OBSR feature must be enabled before the `cgssn` parameter can be specified.

**:gttsn=** (mandatory)

GTT set name. A GTT set is an entity to which global title addresses and selectors are assigned.

**Range:** `ayyyyyyy`

1 leading alphabetic and up to 8 following alphanumeric characters.

**:acn=** (optional)

Application context name. This parameter specifies the ITU TCAP `acn` field in the incoming MSU.

**Range:** `0-255 *`, `none`

The `acn` supports up to 7 subfields separated by a dash (e.g., `1-202-33-104-54-26-007`).

\*—any valid value in the ITU TCAP `acn` field in the incoming MSU

`none`—there is no ITU TCAP `acn` field in the incoming MSU

**Default:** No change to the current value

**:ccgt=** (optional)

Cancel called global title indicator.

**Range:**     **yes, no****Default:**    No change to **ccgt** value**:cdselid=** (optional)

CdPA selector ID.

**Range:**     **0-65534 none****none**—deletes the current value of the *cdselid* field**Default:**    No change to the current value**:cdssn=** (optional)

Starting CdPA subsystem number.

**Range:**     **0-255****:cgcnvsn=** (optional)

Calling party conversion set name.

**Range:**     *ayyyyyyy*, **none**

1 leading alphabetic character and up to 8 following alphanumeric characters.

**none**—deletes the current value of the parameter**:cgtmod=** (optional)

Calling party GT modification indicator. This parameter specifies whether calling party global title modification is required.

**Range:**     **yes, no****Default:**    **no****:cgpc=** (optional)ANSI CgPA point code with subfields *network indicator-network cluster-network cluster member* (*ni-nc-ncm*).**Synonym:** **cgpca****Range:**     **000-255, \***

Specify a valid value for each subfield of the point code, and separate the subfields with a dash (-).

The asterisk (\*) value is not valid for the *ni* subfield.When **chg-sid:pctype=ansi** is specified, *ni* = **000** is not valid.When **chg-sid:pctype=ansi** is specified, *nc* = **000** is not valid if *ni* = **001-005**.When **chg-sid:pctype=ansi** is specified, *nc* = **000** is valid if *ni* = **006-255**.When **chg-sid:pctype=ansi** is specified, *ni*-\*-\* is valid if *ni* = **006-255**.The point code **000-000-000** is not a valid point code.**:cgpci=** (optional)ITU international CgPA point code with subfields *zone-area-id*. The *prefix* subfield indicates a spare point code (*prefix-zone-area-id*).**Range:**     **s-, 0-255**

Specify a valid value for each subfield of the point code, and separate the subfields with a dash (-).

*prefix*—**s-***zone*—**0-7***area*—**000-255***id*—**0-7**

The point code **0-000-0** is not a valid point code.

**:cgpcn=** (optional)

ITU national CgPA point code in the format of a 5-digit number (*nnnnn*); or 2, 3, or 4 numbers (members) separated by dashes (*m1-m2-m3-m4*) as defined by the **chg-stpopts:npcfnti** flexible point code option. A group code must be specified when the ITUDUPPC feature is turned on (*nnnnn-gc*, *m1-m2-m3-m4-gc*). The *prefix* subfield indicates a spare point code (*prefix-nnnnn*, *prefix-nnnnn-gc*, *prefix-m1-m2-m3-m4*, *prefix-m1-m2-m3-m4-gc*).

**Range:** **s-, 0-16383, aa-zz**

Specify a valid value for each subfield of the point code, and separate the subfields with a dash (-).

*prefix*—**s-**

*nnnnn*—**0-16383**

*gc*—**aa-zz**

*m1-m2-m3-m4*—**0-14** for each member; values must sum to 14

**:cgpcn24=** (optional)

24-bit ITU national CgPA point code with subfields *main signaling area-sub signaling area-signaling point* (*msa-ssa-sp*).

**Range:** **000-255**

Specify a valid value for each subfield of the point code, and separate the subfields with a dash (-).

*msa*—**000-255**

*ssa*—**000-255**

*sp*—**000-255**

**:cgselid=** (optional)

Calling party selector ID.

**Range:** **0-65534 none**

**none**—deletes the current value of the *cgselid* field

**Default:** No change to the current value

**:cgssn=** (optional)

The subsystem number of the start CgPA.

**Range:** **0-255**

**:ecdssn=** (optional)

Subsystem number of the end called party.

**Range:** **0-255**

**:ecgssn=** (optional)

Subsystem number of the end CgPA.

**Range:** **0-255**

**:egta=** (optional)

End global title address. This parameter specifies the end of a range of global title digits.

**Range:** 1-21 digits

If the Hex Digit Support for GTT feature is not enabled and on, the range is 1-21 decimal digits; valid digits are **0-9**.

If the Hex Digit Support for GTT feature is enabled and on, the range is 1 - 21 hexadecimal digits; valid digits are **0-9, a-f, A-F**.

**Default:** Same as the specified **gta** value

**:fallback=** (optional)

Fallback option. This parameter specifies the action that is taken if the last translation doesn't match when performing GTT using a FLOBR-specific GTT mode.

**Range:** **yes, no, sysdflt**

**yes** — GTT is performed based on the last matched entry

**no** — GTT fails and the MSU is discarded

**sysdflt** — The system-wide default fallback option in the SCCPOPTS table is used.

**Default:** No change to the current value

**:family=** (optional)

This parameter specifies the ANSI TCAP *family* field in the incoming MSU.

**Range:** **0-255 \*, none**

**\***—any valid value in the ANSI TCAP *family* field in the incoming MSU

**none**—there is no value in the ANSI TCAP *family* field in the incoming MSU

**System**

**Default:** **none**

**:force=** (optional)

Check mated application override.

**Range:** **yes, no**

**Default:** **no**

**:gta=** (optional)

Global title address. This parameter specifies the beginning of a range of global title digits.

**Range:** 1-21 digits

If the Hex Digit Support for GTT feature is not enabled and on, the range is 1-21 decimal digits; valid digits are **0-9**.

If the Hex Digit Support for GTT feature is enabled and on, the range is 1 - 21 hexadecimal digits; valid digits are **0-9, a-f, A-F**.

**:loopset=** (optional)

SCCP loopset name. This parameter associates a translation set with a loopset.

**Range:** *ayyyyyyy*, **none**

One leading alphabetic character and up to 7 following alphanumeric characters.

**none**—Disassociates the translation set from all loopsets.

**:mapset=** (optional)

MAP set ID. This parameter specifies the Mated Application set ID.

**Range:** **1-36000 dflt**

**dflt**—Default MAP set

**:mrnset=** (optional)

MRN set ID. This parameter specifies the Mated Relay Node set ID.

**Range:** **1-3000 none, dflt**

**dflt**—Default MRN set

**none**—The GTA translation does not participate in any load sharing.

**:ngti=** (optional)

New GTI code. When the ANSI-ITU-China SCCP Conversion and AMGTT features are on and the Translated Point Code is of a different network type, this parameter specifies whether the new GTI translation format is GTI type 2 or GTI type 4.

**Range:** **2, 4**

**:nnai=** (optional)

New nature of address indicator. This parameter specifies the nature of address indicator that will replace the received nature of address indicator.

**Range:** 0-127  
**Default:** If the **rmgtt=no** parameter is specified, there is no change to the current value.  
 If the **rmgtt=yes** parameter is specified, the value resets to a default of 0.

**:nnp=** (optional)

New numbering plan. This parameter specifies the numbering plan that will replace the received numbering plan.

**Range:** 0-15  
**Default:** If the **rmgtt=no** parameter is specified, there is no change to the current value.  
 If the **rmgtt=yes** parameter is specified, the value resets to a default of 0xFFFF.

**:npdd=** (optional)

New prefix digits to be deleted. This parameter specifies the new prefix digits to be deleted that will replace the received prefix digits to be deleted.

**Range:** 0-21  
**Default:** If the **rmgtt=no** parameter is specified, there is no change to the current value.  
 If the **rmgtt=yes** parameter is specified, the value resets to a default of 0xFFFF.

**:npds=** (optional)

New prefix digits string. This parameter specifies the new prefix digits string that will replace the received prefix digits string.

**Range:** 1-21 digits  
 If the Hex Digit Support for GTT feature is not enabled and on, the range is 1 - 21 decimal digits; valid digits are 0-9.  
 If the Hex Digit Support for GTT feature is enabled and on, the range is 1 - 21 hexadecimal digits; valid digits are 0-9, a-f, A-F.

**Default:** If **rmgtt=no** is specified, no change to current value  
 If **rmgtt=yes** is specified, resets to default value of no digits.

**:nsdd=** (optional)

New suffix digits to be deleted. This parameter identifies the new suffix digits to be deleted that will replace the received suffix digits to be deleted.

**Range:** 0-21  
**Default:** 0

**:nsds=** (optional)

New suffix digits string. This parameter specifies the new suffix digits string that will replace the received suffix digits string.

**Range:** 1-21 digits  
 If the Hex Digit Support for GTT feature is not enabled and on, the range is 1 - 21 decimal digits; valid digits are 0-9.  
 If the Hex Digit Support for GTT feature is enabled and on, the range is 1 - 21 hexadecimal digits; valid digits are 0-9, a-f, A-F.

**Default:** No digits

**:ntt=** (optional)

New translation type. The point code domain translation types for EGTT are handled by the EAGLE 5 ISS protocol processing as either ANSI or ITU; therefore, ITU applies to ITU-I, ITU-I Spare, ITU-N, and ITU-N Spare. ITU-I includes ITU-I Spare, and ITU-N includes ITU-N Spare.

**Range:** 000-255  
**Default:** If the **xlat** parameter does not change from **dpcngt**—No change to the current value.  
 If the **xlat** parameter changes from **dpcngt**—The **ntt** parameter value is removed.

**:opc=** (optional)

ANSI originating point code with subfields *network indicator-network cluster-network cluster member (ni-nc-ncm)*.

**Synonym:** opca**Range:** 000-255, \*

Specify a valid value for each subfield of the point code, and separate the subfields with a dash (-).

The asterisk (\*) value is not valid for the *ni* subfield.

When **chg-sid:pctype=ansi** is specified, *ni* = 000 is not valid.

When **chg-sid:pctype=ansi** is specified, *nc* = 000 is not valid if *ni* = 001-005.

When **chg-sid:pctype=ansi** is specified, *nc* = 000 is valid if *ni* = 006-255.

When **chg-sid:pctype=ansi** is specified, *ni*-\*-\* is valid if *ni* = 006-255.

The point code 000-000-000 is not a valid point code.

**:opci=** (optional)

ITU international originating point code with subfields *zone-area-id*. The *prefix* subfield indicates a spare point code (*prefix-zone-area-id*).

**Range:** s-, 0-255

Specify a valid value for each subfield of the point code, and separate the subfields with a dash (-).

*prefix*—s-*zone*—0-7*area*—000-255*id*—0-7

The point code 0-000-0 is not a valid point code.

**:opcn=** (optional)

ITU national originating point code in the format of a 5-digit number (*nnnnn*); or 2, 3, or 4 numbers (members) separated by dashes (*m1-m2-m3-m4*) as defined by the **chg-stpopts:npfnti** flexible point code option. A group code must be specified when the ITUDUPPC feature is turned on (*nnnnn-gc*, *m1-m2-m3-m4-gc*). The *prefix* subfield indicates a spare point code (*prefix-nnnnn*, *prefix-nnnnn-gc*, *prefix-m1-m2-m3-m4*, *prefix-m1-m2-m3-m4-gc*).

**Range:** s-, 0-16383, aa-zz

Specify a valid value for each subfield of the point code, and separate the subfields with a dash (-).

*prefix*—s-*nnnnn*—0-16383*gc*—aa-zz*m1-m2-m3-m4*—0-14 for each member; values must sum to 14**:open24=** (optional)

24-bit ITU national originating point code with subfields *main signaling area-sub signaling area-signaling point* (*msa-ssa-sp*).

**Range:** 000-255

Specify a valid value for each subfield of the point code, and separate the subfields with a dash (-).

*msa*—000-255*ssa*—000-255*sp*—000-255**:opcode=** (optional)

This parameter specifies the TCAP *opcode* field in the incoming MSU.

**Range:** **0-255 \***, **none**  
 \*—any valid value in the TCAP *opcode* field in the incoming MSU  
**none**—there is no value in the TCAP *opcode* field in the incoming MSU

**:opcsn=** (optional)

The new OPC GTT set name.

**Range:** *ayyyyyyyy*, **none**  
 1 leading alphabetic character and up to 8 following alphanumeric characters.

**:optsn=** (optional)

Optional GTT set name.

**Range:** *ayyyyyyyy*, **none**  
 1 leading alphabetic character and up to 8 following alphanumeric characters.  
**none**—deletes the current value of the parameter

**:pc=** (optional)

ANSI point code with subfields *network indicator-network cluster-network cluster member (ni-nc-ncm)*. The *prefix* subfield indicates a private point code (*prefix-ni-nc-ncm*).

**Synonym:** **pca**

**Range:** **p-**, **000-255**  
 Specify a valid value for each subfield of the point code, and separate the subfields with a dash (-).  
*prefix*—**p-**  
 When **chg-sid:pctype=ansi** is specified, *ni* = **000** is not valid.  
 When **chg-sid:pctype=ansi** is specified, *nc* = **000** is not valid if *ni* = **001-005**.  
 When **chg-sid:pctype=ansi** is specified, *nc* = **000** is valid if *ni* = **006-255**.  
 The point code **000-000-000** is not a valid point code.

**:pci=** (optional)

ITU international point code with subfields *zone-area-id*. The *prefix* subfield indicates a spare point code, private point code, or private and spare point code (*prefix-zone-area-id*).

**Range:** **s-**, **p-**, **ps-**, **0-255**  
 Specify a valid value for each subfield of the point code, and separate the subfields with a dash (-).  
*prefix*—**s-**, **p-**, **ps-**  
*zone*—**0-7**  
*area*—**000-255**  
*id*—**0-7**  
 The point code **0-000-0** is not a valid point code.

**:pcn=** (optional)

ITU national destination point code in the format of a 5-digit number (*nnnnn*); or 2, 3, or 4 numbers (members) separated by dashes (*m1-m2-m3-m4*) as defined by the **chg-stpopts:npcfnti** flexible point code option. A group code must be specified when the ITUDUPPC feature is turned on (*nnnnn-gc*, *m1-m2-m3-m4-gc*). The *prefix* subfield indicates a spare point code, private point code, or private and spare point code (*prefix-nnnnn*, *prefix-nnnnn-gc*, *prefix-m1-m2-m3-m4*, *prefix-m1-m2-m3-m4-gc*).

**Range:** **s-**, **p-**, **ps-**, **0-16383**, **aa-zz**  
 Specify a valid value for each subfield of the point code, and separate the subfields with a dash (-).  
*prefix*—**s-**, **p-**, **ps-**



*nnnnn*—**0-16383**

*gc*—**aa-zz**

*m1-m2-m3-m4*—**0-14** for each member; values must sum to 14

**:pcn24=** (optional)

24-bit ITU national point code with subfields *main signaling area-sub signaling area-signaling point (msa-ssa-sp)*. The *prefix* subfield indicates a private point code (*prefix-msa-ssa-sp*).

**Range:** **p-, 000-255**

Specify a valid value for each subfield of the point code, and separate the subfields with a dash (-).

*prefix*—**p-**

*msa*—**000-255**

*ssa*—**000-255**

*sp*—**000-255**

**Default:** No change to current value.

**:pkgtype=** (optional)

This parameter specifies the ANSI and ITU TCAP package type.

**Range:** **ansiuni, qwp, qwop, resp, cwp, cwop, ansiabort, any, cnt, end, ituuni, ituabort, bgn**

**ansiuni** — ANSI unidirectional

**qwp** — Query with Permission

**qwop** — Query without Permission

**resp** — Response

**cwp** — Conversation with Permission

**cwop** — Conversation without Permission

**ansiabort** — ANSI abort

**any** — Wildcard value

**cnt** — Continue

**end** — End

**ituuni** — ITU unidirectional

**ituabort** — ITU abort

**bgn** — Begin

ANSI TCAP Package Types—**ansiuni, qwp, qwop, resp, cwp, cwop, ansiabort, any**

ITU TCAP Package Types—**bgn, ituabort, ituuni, any, end, cnt**

**:ri=** (optional)

Routing indicator.

**Range:** **gt, ssn**

**Default:** No change to current value.

**:rmgtt=** (optional)

Reset MGTT. This parameter resets all GT Modification fields to default values before applying values for other parameters in the command.

**Range:** **yes, no**

**Default:** **no**

**:split=** (optional)

Split or change an existing GTA range.

**Range:** **yes, no**

**yes** — Splits the existing GTA range.

**no** — Changes the existing GTA range.

**Default:** **yes**

**:ssn=** (optional)

Subsystem number.

**Range:** 002-255

**Default:** If the **xlat** parameter is not changed to **dpengt**—No change to current value.  
If the **xlat** parameter is changed to **dpengt** —The **ssn** parameter value is removed.

**:testmode=** (optional)

This parameter invokes a Test Tool that is used to debug the FLOBR/TOBR rules.



**CAUTION:** If the **testmode=yes** parameter is specified, then the rule is used only by test messages. The rule is ignored by 'live' traffic. If the **testmode=off** parameter is specified, then both test and live messages use the rule. Changing from **testmode=off** to **testmode=on** is equivalent to deleting the rule for live traffic.

**Range:** on, off

**on** — process the translation rules defined in the test message

**off** — perform standard GTT behavior

**Default:** off

**:xlat=** (optional)

Translate indicator. This parameter is used to specify translation actions and routing actions.

**Range:** dpc, dpengt, dpcssn, udts, disc

**Default:** No change to current value.

**:cggtasn=** (obsolete)

CgPA GTA GTT set name.

**NOTE:** This parameter is obsolete, use the **optsn** parameter.

**Range:** ayyyyyyyy, none

1 leading alphabetic and up to 8 following alphanumeric characters.

**none**—Set names do not point to the CgGTA set.

**:cgpcsn=** (obsolete)

CgPA GTA GTT set name.

**NOTE:** This parameter is obsolete, use the **optsn** parameter.

**Range:** ayyyyyyyy, none

1 leading alphabetic character and up to 8 following alphanumeric characters.

**none**—Set names do not point to the CgPA set.

**:cgssnsn=** (obsolete)

CgPA SSN GTT set name.

**NOTE:** This parameter is obsolete, use the **optsn** parameter.

**Range:** ayyyyyyyy, none

1 leading alphabetic and up to 8 following alphanumeric characters.

**none**—Set names do not point to the CgSSN set.

**:selid=** (obsolete)

Selector ID.

**NOTE:** This parameter is obsolete, use the **cgselid** parameter for CgPA selectors and the **cdselid** parameter for CdPA selectors.

**Range:** 0-65534 none

**Example**

```
chg-
gta:gttsn=lidb:gta=9195554321:xlat=dpcssn:ri=ssn:pc=001-255-252:sn=254
```

```
chg-
gta:gttsn=test:gta=100000:egta=199999:pca=1-1-1:xlat=dpcngt:ri=gt:rmgtt=yes :nnp=3:nnai=120
```

```
chg-gta:gttsn=setnat003:gta=987658321198765432102:pcn=s-129
```

```
chg-gta:gttsn=itui1:gta=987658321198765432112:pci=s-1-210-1
```

```
chg-gta:gttsn=setnat003:gta=987658321198765432122:pcn=s-128-aa
```

The following examples require the Flexible GTT Load Sharing feature to be ON.

```
chg-
gta:gttsn=setmap:gta=2345678901:egta=3456789012:ri=ssn:PC=1-1-3:sn=225:mapset=2
```

```
chg-
gta:gttsn=setmap:gta=2345678911:egta=3456789022:ri=ssn:PC=2-2-2:sn=221:mapset=df1t
```

In the following example, the database contains a GTA range [5556000-5558000], but no part of the GTA range [5558001-5559000] exists. The command deletes the GTA range [5556000-5558000] from the database and adds two new GTA ranges [5556000-5556799] and [5556800-5559000].

```
chg-gta:gttsn=tst1:gta=5556800:egta=5559000:split=yes
```

The following command deletes the GTA range [5556000-5556799] from the database and adds a new GTA range [5556200-5556500] to the database. All the parameters for specified GTA range [5556200-5556500] have the same values as that of the deleted [5556000-5556799] GTA range, except the pc parameter that is assigned the specified value of 1-1-2.

```
chg-gta:gttsn=tst1:gta=5556200:egta=5556500:pc=1-1-2:split=no
```

The following command deletes the GTA range [5556200-5556500] from the database and adds two new GTA ranges [5556200-5556400] and [5556401-5556500] to the database.

```
chg-gta:gttsn=tst1:gta=5556401:egta=5556500
```

The following example specifies the default MRN set.

```
chg-gta:gttsn=setmrn:gta=1234567880:pc=1-1-2:mrnset=df1t
```

The following example specifies the mrnset=none parameter to remove the MRN set ID.

```
chg-
gta:gttsn=setmrn:gta=1234567890:egta=2234567890:pc=1-1-2:mrnset=none
```

The following example specifies MRN set ID 2.

```
chg-
gta:gttsn=setmrn:gta=2345678901:egta=3456789012:pc=1-1-3:mrnset=2
```

```
chg-
gta:gttsn=setcdgta:gta=123456789012345678901:egta=223456789012345678901:optsn=cggtal:opcsn=opc1
```

```
chg-
gta:gttsn=setcdgta:gta=123456789012345678901:egta=223456789012345678901:cgselid=1024:opcsn=opc1
```

```
chg-
gta:gttsn=setcdgta:gta=123456789012345678901:egta=223456789012345
678901:optsn=none
```

```
chg-
gta:gttsn:setcggta:gta=323456789012345678901:egta=323456789012345
678901:optsn=none
```

```
chg-gta:gttsn=setopc:opca=002-001-001:xlat=dpcssn:ri=ssn:
pca=001-001-001:ssn=20:optsn=setcgssn
```

```
chg-gta:gttsn=setcgpc:cgpca=001-001-001:xlat=dpcssn:ri=ssn:
pca=001-001-001:ssn=20:optsn=setcgssn
```

```
chg-gta:gttsn=setcgssn:cgssn=100:ecgssn=200:xlat=dpcssn:ri=ssn:
pca=001-001-001:ssn=20
```

```
chg-gta:gttsn=set1:gta=2543:egta=2943:xlat=disc
```

```
chg-gta:gttsn=set2:cgpc=1-2-*:xlat=udts
```

```
chg-gta:gttsn=set3:opcn=2543:xlat=udts
```

```
chg-gta:gttsn=set4:cgssn=25:ecgssn=29:xlat=disc
```

The following example specifies hexadecimal digits for the gta, egta, and npds parameters.

```
chg-gta:gttsn=set1:gta=abcd:egta=abce:npds=fab
```

```
chg-
gta:gttsn=setmap:gta=2345678901:egta=3456789012:ri=ssn:pc=1-1-3:s
sn=225:mapset=2:loopset=raleigh1
```

The following example specifies that calling party GT modification is required.

```
chg-gta:gttsn=setans004:cggtmod=yes:gta=981234
```

The following example changes the GTA translations when the FLOBR feature is turned on.

```
chg-gta:gttsn=setcdgta:gta=1234567890:egta=2234567890:
xlat=dpcssn:ri=ssn:pca=001-001-001:ssn=100:fallback=no:testmode=o
n
```

The following example changes the GTA translations when the OBSR feature is enabled and the FLOBR feature is turned on.

```
chg-gta:gttsn=setcdgta:gta=1234567890:egta=2234567890:
xlat=dpcssn:ri=ssn:pc=2-2-2:ssn=100:fallback=yes:optsn=setcggta:t
estmode=on
```

The following example changes the GTA translations when the TOBR feature is turned on.

```
chg-gta:gttsn=setcdssn:cdssn=15:ecdssn=29:xlat=dpc:pc=1-1-1:ri=gt
```

The following example changes the GTA translations when the TOBR and OBSR features are turned on.

```
chg-
gta:gttsn=setopcode:pkgtype=qwop:opcode=none:family=*:xlat=dpc:ri
=gt:pc=2-2-2:opcsn=setopc:optsn=setcdgta
```

```
chg-
gta:gttsn=setopcode:pkgtype=bgn:opcode=none:acn=1-22-123-43-54-65
-76:xlat=dpc:ri=gt:pc=2-2-2:opcsn=setopc:optsn=setcdgta
```

## Dependencies

The EGTT feature must be turned on before this command can be entered.

The AMGTT feature must be turned on before the **rmgtt**, **nnp**, **nnai**, **ngti**, **nsdd**, **nsds**, **npdd**, and **npds** parameters can be specified.

The ANSI-ITU-China SCCP Conversion feature must be enabled and turned on before the **ngti** parameter can be specified.

The ANSI-ITU-China SCCP Conversion feature must be turned on before a translated point code that is of a different domain than the GTT set specified by the **gttsn** parameter can be specified.

The **nsdd**, **nsds**, **npdd**, and **npds** parameters cannot be changed with this command. Use the **rmgtt** parameter to reset all GT Modification entry values to their default values, and enter the command again to specify new GT Modification parameter values.

At least one optional parameter must be specified.

The **gttsn** parameter cannot have a value of **none**.

The point code specified for the **pc** parameter must be a full point code.

If the **egta** parameter is specified, the values of the **gta** and **egta** parameters must be the same length.

If the **ngti=4** parameter is specified, the **nnp** and **nnai** parameters must be specified.

If the **ngti=4** parameter is specified, the translated point code cannot be ANSI. For ANSI point codes, the GTI value must be **2**.

If the **ngti=2** parameter is specified, the **nnp** and **nnai** parameters cannot be specified.

If the **ccgt** parameter is specified, the **ngti** parameter cannot be specified. If the **ngti** parameter is specified, the **ccgt** parameter cannot be specified.

If the ANSI-ITU-China SCCP Conversion feature is not on, and the specified GTT set is an ANSI set, then the **pc/pca** parameter must be a valid ANSI point code.

If the ANSI-ITU-China SCCP Conversion feature is not on, and the specified GTT set is an ITU set, the **pci/pcn/pcn24** parameter must be a valid ITU point code.

The length of the specified **gta** parameter must match the number of digits provisioned for the specified GTT set when the VGTT feature is turned off. If the VGTT feature is turned on, then up to 10 GTA lengths can exist per GTT set. If the Support for 16 GTT Lengths in VGTT feature is turned on, then up to 16 GTA lengths can exist per GTT set.

The specified **gta/egta** range must exist for the specified GTT set in the STP active database. While an exact match is not required, an overlap with another range cannot be specified. If the range overlaps, an error is generated that displays a list of overlapped global title addresses. An example follows that shows what happens when the user attempts to enter a range (such as 8005550000 to 8005559999) that overlaps an existing range. The overlapping links must match. If they do not, error message E2401 is generated displaying the list of overlapped global title addresses:

The following GTA ranges overlap the input GTA range

```
START GTA END GTA
8005550000 8005551999
8005552000 8005553999
8005554000 8005555999
CHG-GTA: MASP A - Command Aborted
```

If the ANSI-ITU-China SCCP Conversion feature is not on, the **ntt** parameter can be specified only when the **xlat=dpcngt** parameter is specified.

If the ANSI-ITU-China SCCP Conversion feature is on, the **ntt** parameter can be specified only when the value of the **xlat** parameter is **dpc** or **dpcngt**.

If the ANSI-ITU-China SCCP Conversion feature is on, and the **ntt** parameter is specified, the **ri=gt** parameter must be specified.

The **ngti** parameter can be specified only when the translated point code and the translation type are in different domains, or are both in the ITU domain.

If the **xlat=dpengt** parameter is specified, the **ntt** parameter must be specified.

If a new or existing **xlat=dpengt** parameter is specified, a new or existing **ri=gt** parameter must be specified.

If the **ssn** parameter is specified, a new or existing **xlat=dpcssn** parameter must be specified.

If the **xlat=dpcssn** parameter is specified, the **ssn** parameter must be specified.

If the **pc/pca/pci/pcn/pcn24** parameter is specified, and the point code is the STP true point code, then the value of the new or existing **xlat** parameter must be **dpcssn**, and the new or existing value of the **ri** parameter must be **ssn**.

If the **pc/pca/pci/pcn/pcn24** parameter, **ssn** parameter, or both, are specified, and the point code is the STP true point code, the **ssn** value must exist in the SS-APPL table.

If the **pc/pca/pci/pcn** parameter is specified, then it must exist as a destination in the Route table or reside in a cluster that exists as a destination in the Route table (for global routing) unless the point code is the STP's true point code.

If new or existing **ri=ssn** and **xlat=dp** parameters are specified, and the **pc/pca/pci/pcn/pcn24** parameter is not specified, then the existing PC must exist in the Remote Point Code/MAP table, unless the **force=yes** parameter is specified.

If new or existing **ri=ssn**, **xlat=dp**, and **pc/pca/pci/pcn/pcn24** parameters are specified, the new point code must exist in the Remote Point Code/MAP table, unless the **force=yes** parameter is specified.

If a new or existing **ccgt=yes** parameter is specified, a new or existing **ri=ssn** parameter must be specified.

If a new or existing **ri=gt** parameter is specified, a new or existing **ccgt=no** parameter must be specified.

If the new or existing **pc/pca/pci/pcn/pcn24** parameter is an STP PC or CPC, the **ccgt=no** parameter must be specified.

If the **rmgtt** parameter is specified, the **nnp**, **nnai**, **ngti**, **nsdd**, **nsds**, **npdd**, and **npds** parameters cannot be specified.

If new or existing **ri=ssn** and **xlat=dpcssn** parameters are specified, a new or existing **xlat=dpcssn** parameter must exist in the Remote Point Code/MAP table, unless the **force=yes** parameter is specified.

The GTT table cannot be full.

If the **ri=gt** parameter is specified, the **mrnset** parameter must be specified. If the **ri=gt** parameter is not specified, the **mrnset** parameter cannot be specified.

If the Flexible GTT Load Sharing feature is enabled, the specified PC must already exist in the specified MRN set.

The specified MRN set must already exist in the MRN table.

If the Flexible GTT Load Sharing feature is enabled, the specified PC must exist in the MRN set.

The Flexible GTT Load Sharing feature must be enabled before the **mrnset** parameter can be specified.

If the **ri=gt** parameter is specified, the **mrnset** parameter must be specified. If the **ri=ssn** parameter is specified, the **mrnset** parameter cannot be specified.

The SEAS command can operate only on the default MRN set or the default MAP set.

If the **ri=ssn** parameter is specified, the **mapset** parameter must be specified. If the **ri=gt** parameter is specified, the **mapset** parameter cannot be specified. Note: The **mapset** parameter can only be specified if the Flexible GTT Load Sharing feature is enabled.

The Flexible GTT Load Sharing feature must be enabled before the **mapset** parameter can be specified.

The specified MAP set must exist in the database.

The specified or previously provisioned PC/SSN must exist in the specified or previously provisioned MAP set.

The SEAS command cannot operate on any MAP set other than the default MAP set.

If the **xlat=dpc** parameter is specified, and the value of the **force** parameter is not **yes**, then the point code and MAP set must exist in the MAP table.

The specified GTA must occur within an existing GTA range in the specified GTT Set.

The **gta**, **cgpc/cgpca/cgpci/cgpcn/cgpcn24**, **opc/opca/opci/opcn/opcn24**, **cgssn/cdssn**, **opcode/acn/pkgtype**, or **opcode/family/pkgtype** parameter must be specified.

The FLOBR feature must be turned on before the **cgssn**, **opcsn**, **optsn**, and **cgselid** parameters can be specified in the same command.

The **cgpc/cgpca/cgpci/cgpcn/cgpcn24** and **opc/opca/opci/opcn/opcn24** parameters must have values within the valid range for each subfield.

If the **ecgssn/ecdssn** parameter is specified, its value must be greater than the value of the **cgssn / cdssn** parameter.

If the **egta** parameter is specified, then the **ecgssn/ecdssn** parameter cannot be specified. If the **cgpc** parameter is specified, then the **egta** and **ecgssn/ecdssn** parameters cannot be specified. If the **opc** parameter is specified, then the **egta** and **ecgssn/ecdssn** parameters cannot be specified. If the **cgssn** parameter is specified, then the **egta** parameter cannot be specified. If the **xlat** parameter has a value of **udts** or **disc**, then the **egta**, **cgpc**, **opc**, or **cgssn/ecgssn** parameters are the only other optional parameters that can be specified. If the **cgpc** or **opc** parameter is specified, the **egta**, **ecgssn/ecdssn**, and **split** parameters cannot be specified. If the **cgssn/cdssn** parameter is specified, the **egta** and **split** parameters cannot be specified. If the **cgssn** parameter is specified, the **ecdssn** parameter cannot be specified. If the **cdssn** parameter is specified, the **ecgssn** parameter cannot be specified. If the **opcode** parameter is specified, the **egta**, **ecdssn**, and **ecgssn** parameters cannot be specified. The **acn** and **family** parameters cannot be specified together in the command.

The OBSR feature must be enabled before the **opcsn**, **cgpc/cgpca/cgpci/cgpcn/cgpcn24**, **opc/opca/opci/opcn/opcn24** or **(e)cgssn** parameters are specified or before the **xlat** parameter is specified with a value of **udts** or **discard**.

If the GTT set specified by the **gttsn** parameter (GTTSN set) has a set type of **cdgta** (see the **ent-gttset** command), then the **optsn** parameter cannot specify a GTT set (OPTSN set) with a set type of **cgssn**. If the GTTSN set has a set type of **cdgta**, then the OPTSN set must have a set type of **cggta** or **cgpc**. The FLOBR feature must be turned on before a GTTSN set with a set type of **cgpc**, **cggta** or **opc** can be specified with an OPTSN with a set type other than **cgssn**. If the FLOBR feature is turned on, and the GTTSN set has a set type of **cdgta**, then the OPTSN set cannot have a set type of **opc**. If the TOBR feature is turned on, and the GTTSN set has a set type of **cdgta**, **cdssn**, or **opcode**, then the OPTSN set cannot have a set type of **opc**.

The **cdselid**, **cgselid**, and **optsn** parameters cannot be specified together in the command. If the GTTSN has a set type of **cdgta**, **cdssn**, or **opcode** (see the **ent-gttset** command) then the **optsn** parameter can be specified if one of the other exclusive parameters is specified.

The **gta** parameter must be specified if the GTTSN set type has a value of **cdga** or **cggta**. The **gta** parameter cannot be specified for other set types.

The **cgpc/cgpc/a/cgpci/cgpcn/cgpcn24** parameter must be specified if the GTTSN set type has a value of **cgpc**. The **cgpc/cgpc/a/cgpci/cgpcn/cgpcn24** parameter cannot be specified for other set types.

The **opc/opca/opci/opcn/opcn24** parameter must be specified if the GTTSN set type has a value of **opc**. The **opc/opca/opci/opcn/opcn24** cannot be specified for other set types

The **cgssn** parameter must be specified if the GTTSN set type is **cgssn**. The **cgssn** parameter cannot be specified for other set types

The range specified by the **cgssn/ecgssn** and **cdssn/ecdssn** parameters cannot overlap a currently existing range for the specified GTT set.

The GTT set specified by the **opcsn** parameter must have a set type of **opc** (see the **ent-gttset** command).

If the specified GTT set is an ANSI set, the **cgpc/cgpc/a** and **opc/opca** parameters must be valid ANSI point codes. If the specified GTT set is an ITU set, the **cgpci/cgpcn/cgpcn24** and **opci/opcn/opcn24** parameters must be valid ITU point codes.

The set domain of the **opcsn** parameter must be the same as the set domain of the **gttsn** parameter. For example, if the set domain of the **gttsn** parameter is ANSI, then the set domain of the **opcsn** parameter must be ANSI. If the set domain of the **gttsn** parameter is ITU, then the set domain of the **opcsn** parameter must be ITU.

The range specified by the **cgssn/ecgssn** and **cdssn/ecdssn** parameters must exist for the specified GTT set in the STP active data base. An exact match is not required.

If the value of the **xlat** parameter is changed to **dpc**, **dpengt**, or **dpssn**, then the **pc/pca/pci/pn/pcn24** and **ri** parameters must be specified. If the value of the **xlat** parameter is **udts** or **disc**, then changing the PC or other fields requires the **xlat** parameter value to be changed to a value other than **udts** or **disc**.

The point code specified by the **cgpc** or **opc** parameter must exist.

The **cgpc**, **cgssn**, **gta**, **opc**, **cdssn**, and **opcode** parameters cannot be specified in the same command.

The Hex Digit Support for GTT feature must be enabled and on before hexadecimal digits can be specified for the **gta**, **egta**, **npds**, or **nsds** parameters.

The SCCP Loop Detection feature must be enabled before the **loopset** parameter can be specified.

The value of the **loopset** parameter must already exist in the database.

The point codes specified for the **pc**, **cgpc** and **opc** parameters cannot be out of range.

If the **egta** parameter is specified, the value of the **egta** parameter must be greater than value of the **gta** parameter.

The value specified for the **pc** parameter cannot be associated with a proxy point code.

The AMGTT feature or the AMGTT CgPA Upgrade feature must be turned on before the **cggtmod** parameter can be specified.

The FLOBR feature must be turned on before the **fallback**, **testmode**, or **cdselid** parameter can be specified.

The FLOBR feature must be turned on before the **gttsn** parameter can specify a GTT set with a set type other than **cdgta** (see the **ent-gttset** command) in the same command with the **cgselid** parameter.

The OBSR feature must be enabled or the FLOBR feature must be turned on before the **cgselid** parameter can be specified.

The set type of the GTT set specified by the **gttsn** parameter cannot be the same as the set type of the GTT set specified by the **opcsn** parameter.

The SCCP Conversion feature must be enabled before the GTT set specified by the **opcsn** parameter can have a different domain than the GTT set specified by the **gttsn** parameter.



A TOBR quantity feature must be turned on before the **opcode**, **pkgtype**, **acn**, or **family** parameter can be specified.

The **opcode**, **pkgtype**, and **family** parameters must be specified together for ANSI TCAP translations. The **opcode**, **pkgtype**, and **acn** parameters must be specified together for ITU TCAP translations.

If the GTT set specified by the **gttsn** parameter has a set type of **opcode** (see the **ent-gttset** command), then the **opcode/acn/pkgtype** or **opcode/family/pkgtype** parameters must be specified. These parameters cannot be specified if the GTT set has of any other set type.

The TOBR feature must be turned on before the **cdssn** or **ecdssn** parameter can be specified.

If the GTT set specified by the **gttsn** parameter has a set type of **cdssn** (see the **ent-gttset** command), then the **cdssn** parameter must be specified. This parameter cannot be specified if the GTT set has of any other set type.

The **opcsn** parameter can be specified only if the GTT set specified by the **gttsn** parameter has a set type of **cdgta**, **opcode**, or **cdssn** (see the **ent-gttset** command).

The value specified for the **gttsn** parameter must match the name of an existing GTT Set.

A value of **none** must be specified for the **optsn**, **cgselid**, or **cdselid** parameter before the parameter can be changed to another value.

The SCCP Conversion feature must be enabled and the FLOBR feature must be turned on before the **cgcnvsn** parameter can be specified.

The GTT set specified by the **gttsn** parameter must have a set type of **cdgta** or **cggta** (see the **ent-gttset** command), before the **cgcnvsn** parameter can be specified.

The value specified for the **gttsn** parameter cannot be the same as the value specified for the **cgcnvsn** parameter.

If the **family** parameter is specified, then the **pkgtype** parameter must have a value of **ansiuni**, **qwp**, **qwop**, **resp**, **cwp**, **cwop**, **ansiabort** or **any**.

If the **acn** parameter is specified, then the **pkgtype** parameter must have a value of **bgn**, **ituabort**, **ituuni**, **any**, **end**, or **cnt**.

The **gttsn** parameter must be specified and must match an existing GTT set.

The GTT set name specified in the **optsn**, **opcsn**, or **cgcnvsn** parameters must match an existing GTT set name.

If the **pkgtype=ituabort** parameter is specified, then a value of **none** must be specified for the **acn** and **opcode** parameters. If the **pkgtype=ansiabort** parameter is specified then a value of **none** must be specified for the **family** and **opcode** parameters.

The OBSR feature must be enabled or the TOBR feature must be turned on before the **optsn** parameter can be specified.

## Notes

The maximum length of the resulting GTA string must not exceed 21 digits when translation is complete.

If the EGTT feature is turned on, then the GTT Selector (**ent/chg/dlt/rtrv-gttset**), GTT Set (**ent/dlt/rtrv-gttset**), and GTA (**ent/chg/dlt/rtrv-gta**) commands replace the Translation Type (**ent/dlt/rtrv-tt**) and Global Title Translation (**ent/chg/dlt/rtrv-gtt**) commands. All data previously provisioned with these commands is maintained.

If a GTT is being deleted or changed and the point code (**dpc** or **rte**) is not found in the route table (unless the point code is the STP's true point code), then the following message is displayed in the terminal scroll area:

```
NOTICE: No DPC and/or RTE found for GTT being deleted or changed.
```

The above situation may occur for the following reasons:

- A database was upgraded from a release prior to EAGLE 5 ISS Release 27.1 or IP<sup>7</sup> Secure Gateway Release 3.0 when GTT entries were not linked to the route table and the deletion of the **dpc** was permitted. The GTT referenced a **dpc/rte** that was deleted, and the enforce reference counts between the GTT and route tables were not updated.
- A serious problem occurred in which the reference count rules were not enforced and a **dpc** and/or **rte** were deleted while being referenced by a GTT entry. This indicates a software error; notify the Customer Care Center at (888) FOR-TKLC.

In this command, only ITU-international and ITU national point codes support the spare point code subtype prefix **s-** and the private and spare point code subtype prefix (**ps-**). All of the point code types support the private (internal) point code subtype prefix (**p-**).

When the Flexible GTT Load Sharing feature and the Intermediate GTT Load Sharing feature are on, multiple relationships can be defined among a set of destination point codes in the existing MRN table. The relationship used in a particular translation is based on the GTA digits used for translation. The **mrnset** parameter and the post-translation PC create a key that is used to perform a lookup in the MRN table. This lookup results in a set of alternate PCs, from which a PC is selected, based on relative cost, to route the MSU in most cost-effective way.

When the Flexible GTT Load Sharing feature is turned on, multiple relationships can be defined among a set of PC/SSN pairs in the existing MAP table. The relationship used in a particular translation is based on the GTA digits used for translation.

When the Origin-based SCCP Routing feature is enabled, the CdPA GTA entry can be provisioned in addition to the CgPA GTA, CgPA PC, CgPA SSN, and OPC entries. When provisioning, the Advanced CdPA GTA entry can associate with the CgPA GTA set or the CgPA PC set, the SELID and/or OPC set; the CgPA GTA, CgPA PC, or OPC can associate with the CgPA SSN set; the CgPA SSN cannot associate with any other GTT set. The Advanced CdPA GTA entry may contain the selector ID along with CgPA information present in the MSU to search the Selector table again for the CgPA GTA or CgPA PC Set.

A loopset consists of a set of point codes that form a routing loop in the network. If the SCCP Loop Detection feature is enabled, then the loopset can be associated with or disassociated from specified translation entries. Loopsets that are associated with translation entries are checked during intermediate and final GTT traffic routing. If a loop exists, then the system can be notified with or without discarding the associated traffic.

The maximum length of the resulting GTA string must not exceed 21 digits when translation is complete.

If the range specified by the **gta** and **egta** parameters does not exactly match the existing range, then the existing range is split. All addresses in the existing range that are outside the range specified by the **gta** and **egta** parameters retain the original **xlat**, **ri**, **pc**, **ssn**, and **ngt** parameters. A new range is created that is bounded by the **gta** and **egta** parameters. The new range contains new values for the **xlat**, **ri**, **pc**, **ssn**, and **ngt** parameters that are present in the command, while retaining parameter values from the previous range that do not have corresponding new values in the command.

To change existing **nsdd**, **nsds**, **npdd**, and **npds** parameter values, enter the command with the **rmgtt** parameter to reset the GT Modification values, and enter the command with new **nnp** and **nnai** or **npdd** and **npds** parameter values.

If the FLOBR GTT hierarchy is provisioned on a linkset, then translations do not have to be searched in a predetermined manner (a specific translation can only point to specific GTTSETs, and CgPA SSN translation is the terminating point). If a translation points to another GTTSET/SELID, then database searches continue. The number of searches is limited by the following conditions:

- Same GTT set type can't be referred more than once.

- Number of database searches is limited to 7.

If the FLOBR feature is turned on, then any translation can point to any GTTSETs that do not have the same GTT set type. The CdPA GTA translations can also point to an OPC GTTSET. For CdPA GTA translations, if a GTTSET/SELID is provisioned apart from an OPC GTTSET, then the GTTSET/SELID takes precedence over the OPC GTTSET.

The TOBR feature introduces 2 new type of translations.

1. TOBR CdPA SSN Translations—CdPA SSN translations can be configured with routing and flexible routing data. The provisioning rules for CdPA SSN translations are the same as CgPA SSN translations in OBSR.
2. TOBR Opcode Translations—Opcode translations support ANSI or ITU opcodes.
  - TOBR translations with ANSI Opcode—ANSI opcode specifier, ANSI TCAP Package type, and Family
  - TOBR translations with ITU Opcode—ITU opcode, ITU TCAP Package Type, and ACN

## Output

The following example changes the GTA translations when the FLOBR and OBSR features are turned on.

```
chg-
gta:gttsn=setcdgta:gta=12345678901:xlata=dpcssn:ri=ssn:pca=001-001
-001:ssn=100:optsn=setcggta:opcsn=setopc
tekelecstp 09-03-24 12:09:18 EST EAGLE 41.0.0
CHG-GTA: MASP A - COMPLTD
;
```

## chg-gtcnv

### Change Global Title Conversion

Use this command to change entries in the Default Global Title Conversion table. A table entry is identified by the direction and either the **tta** parameter, the **tti** parameter, or the **tti/np/nai** parameter combination. The Notes section for this command describes rules for changing entry information.

**Keyword:** chg-gtcnv

**Related Commands:** dlt-gtcnv, ent-gtcnv, rtrv-gtcnv

**Command Class:** Database Administration

### Parameters

**:dir=** (mandatory)

Direction of conversion.

**Range:** **atoi, itoa, both**

**atoi**—ANSI to ITU conversion

**itoa**—ITU to ANSI conversion

**both**—Conversion in both directions

**:nai=** (optional)

Nature of address indicator. This parameter is mandatory when **gtixlat=24** is specified, and cannot be specified when **gtixlat=22** is specified.

**Range:** **0-63 \***

**Default:** No change to current value

- :np=** (optional)  
 Numbering plan. This parameter is mandatory when **gtixlat=24** is specified, and cannot be specified when **gtixlat=22** is specified.  
**Range:** 0-15 \*  
**Default:** No change to current value
- :npdd=** (optional)  
 New prefix digits to be deleted. This parameter specifies the number of new prefix digits to be deleted. These digits will be replaced with the new prefix digits string (**npds**).  
**Range:** 0-21  
**Default:** No change to current value
- :npds=** (optional)  
 New prefix digits string. This parameter specifies the new prefix digits string that will replace the received prefix digits.  
**Range:** 1-21 digits  
 If the Hex Digit Support for GTT feature is not enabled and on, the range is 1 - 21 decimal digits; valid digits are **0-9**.  
 If the Hex Digit Support for GTT feature is enabled and on, the range is 1 - 21 hexadecimal digits; valid digits are **0-9, a-f, A-F**.  
**Default:** No change to current value
- :nsdd=** (optional)  
 New suffix digits to be deleted. This parameter specifies the number of new suffix digits to be deleted. These digits will be replaced with the new suffix digits string (**nsds**).  
**Range:** 0-21  
**Default:** No change to current value
- :nsds=** (optional)  
 New suffix digits string. This parameter specifies the new suffix digits string that will replace the received suffix digits.  
**Range:** 1-21 digits  
 If the Hex Digit Support for GTT feature is not enabled and on, the range is 1 - 21 decimal digits; valid digits are **0-9**.  
 If the Hex Digit Support for GTT feature is enabled and on, the range is 1 - 21 hexadecimal digits; valid digits are **0-9, a-f, A-F**.  
**Default:** No change to current value
- :rdmod=** (optional)  
 Reset digit modifiers (**npdd** and **npds** or **nsdd** and **nsds**) values to "no digit modification."  
**Range:** yes, no  
**yes**—Reset the **npdd** and **npds** parameter or **nsdd** and **nsds** parameter values.  
**no**—Do not reset the **npdd** and **npds** parameter or **nsdd** and **nsds** parameter values.  
**Default:** No change to current value
- :tta=** (optional)  
 ANSI translation type. This parameter is mandatory when **dir=atoi** or **dir=both** is specified.  
**Range:** 0-255 \*  
**Default:** No change to current value
- :tti=** (optional)  
 ITU translation type. This parameter is mandatory when **dir=atoi** is specified.  
**Range:** 0-255 \*  
**Default:** No change to current value

**Example**

The following example changes a dir=atoi entry's current tti value to 5.

```
chg-gtcnv:dir=atoi:tta=10:tti=5
```

The following example changes a dir=atoi entry's current tti, nai, and np values to 7, 8, and 6 respectively, and either changes or adds the nsdd and nsds values.

```
chg-gtcnv:dir=atoi:tta=11:tti=7:nai=8:np=6:nsdd=3:nsds=123
```

The following example changes a dir=itoa entry's current tta value to 11, and either changes or adds the npdd and npds values.

```
chg-gtcnv:dir=itoa:tta=11:tti=7:npdd=3:npds=123
```

The following example changes a dir=itoa entry's current tta value to 12, and either changes or adds the nsdd and nsds values.

```
chg-gtcnv:dir=itoa:tta=12:tti=7:nai=8:np=6:nsdd=5:nsds=45667
```

The following example adds or changes a dir=both entry's nsdd and nsds values.

```
chg-gtcnv:dir=both:tta=12:tti=33:nsdd=3:nsds=456
```

The following example changes a default dir=atoi entry's current tti value to 9, and either changes or adds the nsdd and NSDS values.

```
chg-gtcnv:dir=atoi:tta=*:tti=9:nsdd=1:nsds=9
```

The following example changes a default dir=atoi entry's current tti, nai, and np value to 4, 6, and 5 respectively.

```
chg-gtcnv:dir=atoi:tta=*:tti=4:nai=6:np=5
```

The following example changes a default dir=itoa entry's current tta value to 17, and either changes or adds the npdd and npds values.

```
chg-gtcnv:dir=itoa:tta=17:tti=*:nai=*:np=*:npdd=3:npds=123
```

The following example resets existing npdd/npds or nsdd/nsds values to "no digit modification."

```
chg-gtcnv:dir=both:tta=12:tti=11:rdmod=yes
```

The following example specifies hexadecimal digits for the nsds parameter.

```
chg-gtcnv:dir=atoi:tta=*:tti=4:npdd=3:npds=abc1234fed
```

**Dependencies**

The ANSI-ITU-China SCCP Conversion feature must be turned on before this command can be entered.

If the **dir=atoi** parameter is specified, the **tta** parameter must be specified.

If the **dir=both** parameter is specified, at least the **tta** and **tti** parameters must be specified.

If the **dir=both** parameter is specified, asterisk parameter values (\*) cannot be specified.

If the **dir=atoi** parameter is specified, the asterisk parameter value (\*) can be specified only for the **tta** parameter.

If the **dir=itoa** parameter is specified, the asterisk parameter value (\*) must be specified for the **tti**, **np**, and **nai** parameters.

If the **dir=itoa** and **gtixlat=22** parameters are specified, asterisk parameter values (\*) cannot be specified. The **gtixlat=24** parameter must be specified with asterisk parameter values when the **dir=itoa** parameter is specified.

The specified **dir**, **tta**, **tti**, **np**, and **nai** parameter combination cannot already exist in the database.

If the **nsdd** and **nsds** parameters are specified, the **npdd** and **npds** parameters cannot be specified.

The Default Global Title Conversion table can contain a maximum of 1000 entries.

The Hex Digit Support for GTT feature must be enabled and on before hexadecimal digits can be specified for the **npds** and **nsds** parameters.

### Notes

The use of asterisks (wildcards) is allowed only once for each direction of ANSI to ITU and ITU to ANSI. This provides a configurable default.

In the conversion direction of ANSI to ITU, an asterisk can be specified only for the ANSI **tta** parameter.

In the conversion direction of ITU to ANSI, the asterisk value must be specified for the **itu tti**, **np**, and **nai** parameters.

Asterisks are not allowed when conversion is in both directions (**dir=both**).

The suffix digit manipulation parameters **nsdd** and **nsds** cannot be specified in the same command with the prefix digit manipulation parameters **npdd** and **npds** parameters. The **npdd** and **nsdd** parameters specify how many digits to delete, if any, from the beginning or end respectively of the Global Title address digits. The **npds** and **nsds** parameters specify what digits, if any, to append to the beginning or end respectively of the Global Title address digits.

The **gtixlat** parameter is expressed in the form of the ANSI GTI and the ITU GTI. The **gtixlat** parameter is used to indicate the conversion of the Global Title Indicator between the ANSI and ITU standards. For example: A **gtixlat** value of **24** converts an incoming ANSI GTI2 to an outgoing ITU GTI 4 or an incoming ITU GTI 4 to an outgoing ANSI GTI2.

### Output

```
chg-gtcnv:dir=atoi:gtixlat=22:tta=10:tti=5
  rlgncxa03w 03-11-07 11:43:07 EST EAGLE 31.3.0
  CHG-GTCNV: MASP A - COMPLTD
;
```

## chg-gtt

### Change Global Title Translation

Use this command to change the routing objects for messages requiring global title translation. The global title addresses remain unchanged.

If the EGTT (Enhanced Global Title Translation) feature is turned on, the system will no longer accept GTT (Global Title Translation) and TT (Translation Type) commands. Refer to the new command sets that replace the GTT and TT commands:

- GTT Selector commands (**ent/chg/dlt/rtrv-gttset**)
- GTT Set commands (**ent/dlt/rtrv-gttset**)
- GTA commands (**ent/chg/dlt/rtrv-gta**).

See the "Notes" section in this command description for functions provided when various controlled features are turned on.

**Keyword:** **chg-gtt**

**Related Commands:** **dlt-gtt**, **ent-gtt**, **rtrv-gtt**

**Command Class:** Database Administration

## Parameters

At least one of these parameters must be specified: **pc/pca/pci/pcn/pcn24, ri, ssn, ttn, type/typea/typei/typen/typen24, xlat**.

**NOTE: See "Point Code Formats and Conversion" for a detailed description of point code formats, rules for specification, and examples.**

**:gta=** (mandatory)

Global title address. This parameter specifies the beginning of a range of global title digits.

**Range:** 1-21 digits

If the Hex Digit Support for GTT feature is not enabled and on, the range is 1 - 21 decimal digits; valid digits are **0-9**.

If the Hex Digit Support for GTT feature is enabled and on, the range is 1 - 21 hexadecimal digits; valid digits are **0-9, a-f, A-F**.

**:cggtmod=** (optional)

Calling party GT modification indicator. This parameter specifies whether calling party global title modification is required.

**Range:** **yes, no**

**Default:** **no**

**:egta=** (optional)

End global title address. This parameter specifies the end of a range of global title digits.

**Range:** 1-21 digits

If the Hex Digit Support for GTT feature is not enabled and on, the range is 1 - 21 decimal digits; valid digits are **0-9**.

If the Hex Digit Support for GTT feature is enabled and on, the range is 1 - 21 hexadecimal digits; valid digits are **0-9, a-f, A-F**.

**Default:** **egta** same as **gta**

**:loopset=** (optional)

SCCP loopset name. This parameter associates a translation set with a loopset.

**Range:** *ayyyyyyy*, **none**

1 alphabetic character followed by up to 7 alphanumeric characters.

**none**—Disassociates the translation set from all loopsets.

**:mapset=** (optional)

MAP set ID. This parameter specifies the Mated Application set ID.

**Range:** **1-36000 dflt**

**dflt**—Default MAP set

**:mrnset=** (optional)

MRN set ID. This parameter specifies the Mated Relay Node set ID.

**Range:** **1-3000 none, dflt**

**dflt**—Default MRN set

**none**—The GTT translation does not participate in any load sharing

**:ngt=** (optional)

New global title

**Range:** **000-255**

**Default:** If the value for the **xlat** parameter changes from **dpngt**, the **ngt** parameter is removed. If the value for the **xlat** parameter does not change from **dpngt**, there is no change to the **ngt** parameter value.

**:ngti=** (optional)

New GTI code. When the ANSI-ITU-China SCCP Conversion and AMGTT features are ON and the Translated Point Code is of a different network type, the **ngti** parameter specifies whether the new GTI translation format is GTI type 2 or GTI type 4.

**Range:** 2, 4

**:nnai=** (optional)

New nature of address indicator. This parameter specifies the nature of address indicator that will replace the received nature of address indicator.

**Range:** 0-127

**Default:** If the **rmgtt=no** parameter is specified, there is no change to the current value.  
If the **rmgtt=yes** parameter is specified, the value resets to a default of 0.

**:nnp=** (optional)

New numbering plan. This parameter identifies the numbering plan that will replace the received numbering plan.

**Range:** 0-15

**Default:** If the **rmgtt=no** parameter is specified, there is no change to the current value.  
If the **rmgtt=yes** parameter is specified, the value resets to a default of 0xFFFF.

**:npdd=** (optional)

New prefix digits to be deleted. This parameter identifies the new prefix digits to be deleted that will replace the received prefix digits to be deleted.

**Range:** 0-21

**Default:** If the **rmgtt=no** parameter is specified, no change to the current value.  
If the **rmgtt=yes** parameter is specified, the value resets to a default of 0xFFFF.

**:npds=** (optional)

New prefix digits string. This parameter specifies the new prefix digits string that will replace the received prefix digits string.

**Range:** 1-21 digits

If the Hex Digit Support for GTT feature is not enabled and on, the range is 1 - 21 decimal digits; valid digits are 0-9.

If the Hex Digit Support for GTT feature is enabled and on, the range is 1 - 21 hexadecimal digits; valid digits are 0-9, a-f, A-F.

**Default:** If the **rmgtt=no** parameter is specified, there is no change to the current value.  
If the **rmgtt=yes** parameter is specified, the value resets to a default of no digits.

**:nsdd=** (optional)

New suffix digits to be deleted. This parameter identifies the new suffix digits to be deleted that will replace the received suffix digits to be deleted.

**Range:** 0-21

**Default:** 0

**:nsds=** (optional)

New suffix digits string. This parameter specifies the new new suffix digits string that will replace the received suffix digits string

**Range:** 1-21 digits

If the Hex Digit Support for GTT feature is not enabled and on, the range is 1 - 21 decimal digits; valid digits are 0-9.

If the Hex Digit Support for GTT feature is enabled and on, the range is 1 - 21 hexadecimal digits; valid digits are 0-9, a-f, A-F.

**Default:** No digits



**:pc=** (optional)

ANSI point code with subfields *network indicator-network cluster-network cluster member (ni-nc-ncm)*. The *prefix* subfield indicates a private point code (*prefix-ni-nc-ncm*).

**Synonym:** **pca**

**Range:** **p-, 000-255**

Specify a valid value for each subfield of the point code, and separate the subfields with a dash (-).

*prefix*—**p-**

When **chg-sid:pctype=ansi** is specified, *ni = 000* is not valid.

When **chg-sid:pctype=ansi** is specified, *nc = 000* is not valid if *ni = 001-005*.

When **chg-sid:pctype=ansi** is specified, *nc = 000* is valid if *ni = 006-255*.

The point code **000-000-000** is not a valid point code.

**:pc/pca/pci/pcn/pcn24=** (optional)

Point code.

**:pci=** (optional)

ITU international point code with subfields *zone-area-id*. The *prefix* subfield indicates a spare point code, private point code, or private and spare point code (*prefix-zone-area-id*).

**Range:** **s-, p-, ps-, 0-255**

Specify a valid value for each subfield of the point code, and separate the subfields with a dash (-).

*prefix*—**s-, p-, ps-**

*zone*—**0-7**

*area*—**000-255**

*id*—**0-7**

The point code **0-000-0** is not a valid point code.

**:pcn=** (optional)

ITU national point code in the format of a 5-digit number (*nnnnn*); or 2, 3, or 4 numbers (members) separated by dashes (*m1-m2-m3-m4*) as defined by the **chg-stpopts:npcfmti** flexible point code option. A group code must be specified when the ITUDUPPC feature is turned on (*nnnnn-gc, m1-m2-m3-m4-gc*). The *prefix* subfield indicates a spare point code, private point code, or private and spare point code (*prefix-nnnnn, prefix-nnnnn-gc, prefix-m1-m2-m3-m4, prefix-m1-m2-m3-m4-gc*).

**Range:** **s-, p-, ps-, 0-16383, aa-zz**

Specify a valid value for each subfield of the point code, and separate the subfields with a dash (-).

*prefix*—**s-, p-, ps-**

*nnnnn*—**0-16383**

*gc*—**aa-zz**

*m1-m2-m3-m4*—**0-14** for each member; values must sum to 14

**:pcn24=** (optional)

24-bit ITU national point code with subfields *main signaling area-sub signaling area-signaling point (msa-ssa-sp)*. The *prefix* subfield indicates a private point code *prefix-ni-nc-ncm*. (*prefix-ni-nc-ncm*).

**Range:** **p-, 000-255**

Specify a valid value for each subfield of the point code, and separate the subfields with a dash (-).

*prefix*—**p-**

*msa*—000–255

*ssa*—000–255

*sp*—000–255

**:ri=** (optional)

Routing Indicator. This parameter provides routing instructions to the receiving signaling point. In gateway screening, messages may be screened based on the value of the routing indicator.

**Range:** **gt, ssn**

**gt** — Allow a called party address with a routing indicator value of **global title**.

**ssn** — Allow a called party address with a routing indicator value of **dpc/ssn**.

**Default:** No change in current value.

**:rmgtt=** (optional)

This parameter resets all GT modification fields to default values before applying values for other parameters in the command.

**Range:** **yes, no**

**Default:** **no**

**:split=** (optional)

Split or change an existing GTA range.

**Range:** **yes, no**

**yes** — Split the existing GTA range.

**no** — Change the existing GTA range.

**Default:** **yes**

**:ssn=** (optional)

Subsystem number.

**Range:** **002-255**

**Default:** If the **xlat=dpcngt** parameter is specified, there is no change to the current value.  
If the **xlat=dpcngt** parameter is not specified, the **ssn** parameter is removed.

**:ttn=** (optional)

Translation type name.

**Range:** *ayyyyyyyy*

1 alphabetic character followed by up to 7 alphanumeric characters

**Default:** No translation name is given

**:type/typea/typei/typen/typen24=** (optional)

Translation type. This parameter identifies the translation type and network type. This parameter is the decimal representation of the 1-byte field used in SS7.

The **type** and **typea** parameters specify an ANSI network.

The **typei** parameter specifies an ITU-international network.

The **typen** parameter specifies an ITU-national network.

The **typen24** parameter specifies a 24-bit ITU-national network.

A translation type numeric value may be entered as ANSI type (**type** or **typea**) and also as an ITU type (**typei** or **typen**). However, they are separate entities.

The point code domain translation types for GTT are handled by the EAGLE 5 ISS protocol processing as either ANSI or ITU; therefore, ITU applies to ITU-I, ITU-I Spare, ITU-N, and ITU-N Spare. ITU-I includes ITU-I Spare, and ITU-N includes ITU-N Spare.

**Range:** **0-255**

**Default:** No translation type is specified

**:xlat=** (optional)

Translate indicator. This parameter specifies translation actions and routing actions.

**Range:** dpc, dpcssn, dpcngt

**Default:** No change in current value.

### Example

```
chg-
gtt:type=5:gta=9195551212:egta=9195551999:xlat=dpcssn:ri=ssn:pc=2
55-002-001 :ssn=255
```

```
chg-
gtt:ttn=lidb2:gta=9197771212:egta=9197771999:xlat=dpcngt:ri=gt:pc
=255-002-001 :ngt=3
```

```
chg-gtt:ttn=lidb6:gta=910777:pc=255-002-002
```

```
chg-gtt:
type=10:gta=8005553232:egta=8005554000:rmgtt=yes:nnp=3:npdd=5
```

```
chg-
gtt:type=11:gta=8005553232:egta=8005554000:nnai=4:nnp=4:nsdd=5:ns
ds=2341 :ngti=4
```

```
chg-gtt:gta=123456:pci=s-1-129-7:typei=41
```

```
chg-gtt:gta=223456:pcn=s-128-aa:typen=3
```

```
chg-
gtt:ttn=setmrn:gta=1234567890:egta=2234567890:pc=1-1-2:mrnset=non
e
```

```
chg-
gtt:ttn=setmrn:gta=2234567891:egta=2234567892:pc=1-1-2:mrnset=df1
t
```

```
chg-
gtt:ttn=setmrn:gta=2345678901:egta=3456789012:pc=1-1-3:mrnset=2
```

The following examples require the Flexible GTT Load Sharing feature to be ON.

```
chg-
gtt:ttn=setmap:gta=2345678901:egta=3456789012:ri=ssn:pc=1-1-3:ssn
=10:mapset=2
```

```
chg-
gtt:ttn=setmap:gta=2345678911:egta=3456789022:ri=ssn:pc=2-2-2:ssn
=6:mapset=df1t
```

The database contains a GTA range [5556000-5558000], but no part of the GTA range [5558001-5559000] exists. The following command deletes the GTA range [5556000-5558000] from the database and adds a new GTA range [5556800-5559000] to the database.

```
chg-gtt:ttn=tst1:gta=5556800:egta=5559000:split=no
```

The following command deletes the GTA range [5556800-5559000] from the database and adds three new GTA ranges [5556800-5556899], [5556900-5557000] and [5557001-5559000] to the database.

```
chg-gtt:ttn=tst1:gta=5556900:egta=5557000
```

The following example specifies hexadecimal digits for the gta, egta, and nsds parameters.

```
chg-
gtt:type=1:xlat=dpc:ssn:ri=ssn:ssn=10:pc=1-1-1:gta=df3456789012345
678906:egta=df345678901234567890a:nsds=EF012345DF012
```

```
chg-
gtt:tt=setmap:gta=2345678901:egta=3456789012:ri=ssn:pc=1-1-3:ssn
=10:mapset=2:loopset=none
```

The following example specifies that calling party GT modification is required.

```
chg-gtt:gta=981234:type=4:cggtmod=yes
```

## Dependencies

This command is not valid when the EGTT feature is turned on.

If the **pcn** parameter is specified, its format must match the format that was assigned with the **chg-stpopts:npcfnti** parameter.

The value of the **tt** parameter must correspond to a value of the **type/typea/typei/typen/type24** parameter.

The value of the **tt** parameter must exist in the Translation Type table.

The network type (ANSI, ITU-I, ITU-N, or 24-bit ITU-N) of the translation type and the translated point code must be the same.

The ANSI-ITU-China SCCP Conversion feature must be enabled before the **ngti** parameter can be specified.

If the **xlat=dpc**, **ri=ssn**, and **pc/pca/pci/pcn** parameters are specified, then the point code must exist in the MAP table.

If the new or existing **xlat** parameter value is **dpc**, the new or existing **ri** parameter value is **ssn**, and the **pc/pca/pci/pcn** parameter is not specified, a point code must exist in the Remote Point Code/ MAP table.

If the **xlat** parameter value is changed from **dpcssn** to **dpc** or **dpcngt**, a new **ssn** parameter value cannot be specified, and the current **ssn** parameter value must be removed.

If the new **xlat** parameter value is **dpcssn**, and the current **ssn** parameter value has been removed, a new **ssn** parameter value must be specified.

The start **gta** length must equal the number of digits specified by the translation type. If the VGTT (variable length GTT) feature is turned on, then up to 10 GTA lengths per translation type are allowed. When the **ent-gtt** command is entered to create entries, the software keeps track of the lengths and allows only ten different lengths. The global title address specified for the translation type must then have the same number of digits as an existing GTA.

If the **rmgtt** parameter is specified, then the **nnp**, **nnai**, **nsdd**, **nsds**, **npdd**, and **npds** parameters cannot be specified.

The AMGTT feature must be turned on before the **rmgtt**, **nnp**, **nnai**, **nsdd**, **nsds**, **npdd**, and **npds** parameters can be specified.

If the **nsdd** and **nsds** parameters are specified, the **npdd** and **npds** parameters cannot be specified.

The **ngti** parameter can be specified only when the translated point code and the translation type are in different domains, or are both in the ITU domain.

If the **ngti=4** parameter is specified, the **nnp** and **nnai** parameters must be specified.

If the **ngti=4** parameter is specified, the translated point code cannot be ANSI. For ANSI point codes, the GTI value must be **2**.

If the **ngti=2** parameter is specified, the **nnp** and **nnai** parameters cannot be specified.

If the **egta** parameter is specified, the length must equal the length of the start **gta**.

If the **egta** parameter is specified, the value must be greater than the value specified for the **gta** parameter.

The range of global title addresses to be changed, as specified by the start and end global title addresses, must match exactly or be contained within an existing range in the global title translation data for the specified translation type.

The new **gta-egta** range cannot include the **gta** or the **egta** of an existing range. However, the new global title address range can completely fall within an existing global title address range. If the range overlaps, an error is generated that displays a list of overlapped global title addresses. An example follows that shows what happens when the user attempts to enter a global title address range (such as 8005550000 to 8005559999) that overlaps an existing range. The overlapping links must match. If they do not, the error message displays the list of overlapped global title addresses:

The following GTA ranges overlap the input GTA range

```
START GTA END GTA
8005550000 8005551999
8005552000 8005553999
8005554000 8005555999
CHG-GTT: MASP A - Command Aborted
```

If the **xlat=dpcngt** parameter is not specified, then the **ngt** parameter cannot be specified.

If the new **xlat** parameter value is **dpcngt**, and the current **ngt** parameter value has been removed, a new **ngt** parameter value must be specified.

If the ANSI-ITU-China SCCP Conversion feature is on, the **ngt** parameter can be specified only if the **xlat=dpc** parameter or the **xlat=dpcngt** parameter is specified.

If the ANSI-ITU-China SCCP Conversion feature is turned on, and the **ngt** parameter is specified, the **ri=gt** parameter must be specified.

The **tt** parameter cannot be specified with a value that has been defined as an alias for another translation type.

Either the **type** parameter or the **ttn** parameter must be specified.

Point code entries must be full point codes. Partial point codes are not allowed.

Table 5-11 shows the valid combinations for the **xlat**, **ri**, **ssn**, and **ngt** parameters. All other combinations are rejected.

**Table 5-11.** Valid Parameter Combinations for the **chg-gtt** Routing Parameters

New or Existing XLAT Value	New or Existing RI Value	Routing Action	SSN Value	NGT Value
DPC	GT	Translate DPC only and route on GT	Cannot be specified. The current database entry is removed.	Cannot be specified unless ANSI-ITU-China SCCP Conversion is enabled. The current database entry is removed.
DPC	SSN	Translate DPC only and route on SSN	Cannot be specified. The	Cannot be specified. The current database entry is removed.

Table 5-11. Valid Parameter Combinations for the **chg-gtt** Routing Parameters

New or Existing XLAT Value	New or Existing RI Value	Routing Action	SSN Value	NGT Value
			current database entry is removed.	
<b>DPCSSN</b>	<b>GT</b>	Translate <b>DPC</b> and <b>SSN</b> and route on <b>GT</b>	Must be specified.	Cannot be specified. The current database entry is removed.
<b>DPCSSN</b>	<b>SSN</b>	Translate <b>DPC</b> and <b>SSN</b> and route on <b>SSN</b>	Must be specified.	Cannot be specified. The current database entry is removed.
<b>DPCNGT</b>	<b>GT</b>	Translate <b>DPC</b> , new translation type ( <b>TT</b> ), and route on <b>GT</b>	Cannot be specified. The current database entry is removed.	Must be specified.

If the **ri=ssn** parameter is specified, the **mrnset** parameter cannot be specified.

If the Flexible GTT Load Sharing feature is enabled, the point code must already exist in the specified MRN set.

The specified MRN set must already exist in the MRN table.

The Flexible GTT Load-Sharing feature must be enabled before the **mrnset** parameter can be specified.

The SEAS command is not allowed to operate on any other MRN set except the default MRN set.

The **mapset** parameter can only be specified if the Flexible GTT Load Sharing feature is enabled, and the **ri=ssn** parameter is specified. If the **ri=ssn** parameter is specified, the **mapset** parameter must be specified. If the **ri=gt** parameter is specified, the **mapset** parameter cannot be specified.

If the Flexible GTT Load Sharing feature is not enabled, the **mapset** parameter cannot be specified.

At least one entry must be provisioned in the specified MAP set in the MAP table.

The specified or previously provisioned point code and subsystem number must exist in the specified or previously provisioned MAP set.

The SEAS command cannot operate on any MAP set other than the default MAP set.

The specified GTA must lie within an existing GTA range in the specified GTT Set.

The specified GTA range must not overlap with any other existing GTA range in the specified GTT Set.

If the Flexible GTT Load Sharing feature is enabled, then the specified PC must exist in the MRN set.

If the **ri=gt** parameter is specified, the **mapset** parameter cannot be specified.

The Hex Digit Support for GTT feature must be enabled and on before hexadecimal digits can be specified for the **gta**, **egta**, **npds**, or **nsds** parameters.

The SCCP Loop Detection feature must be enabled before the **loopset** parameter can be specified.

The value of the **loopset** parameter must already exist in the database.

The SCCP Loop Detection feature must be enabled before the **loopset** parameter can be specified.

The value of the **loopset** parameter must exist in the Loopset table.

If the **ri=gt** parameter is specified, the **mrnset** parameter must be specified.

The new or existing **pc** or **ssn** combination must exist as a mated application.

The GTT table cannot be full.

If the value of the **pc/pca/pci/pcn/pcn24** parameter is the True Point Code, then the **xlat=dpcssn** parameter and the **ri=ssn** parameter must be specified.

If the **ssn** parameter is specified, and if the value of the **pc/pca/pci/pcn/pcn24** parameter is the True Point Code, then the value of the **ssn** parameter must exist in the SS-APPL table.

The value of the **pc/pca/pci/pcn/pcn24** parameter must exist as a destination in the ordered route entity set or must reside in a cluster (ANSI only) that exists as a destination in the ordered route entity set.

If the **xlat=dpcngt** and **ri=gt** parameters are specified, then the **ngt** parameter must be specified.

If the **xlat=dpcssn** and **ri=gt** parameters are specified, then the **ssn** parameter must be specified.

The **xlat=dpcssn** parameter must be specified before the **ssn** parameter can be specified.

If the **xlat=dpcngt** parameter is specified, then the **ri=gt** parameter must be specified.

The **gta** length is not defined for the specified translation type entity.

The **tt** parameter and the **pc/pca/pci/pcn/pcn24** parameter must have matching network types.

The value of the **typei** parameter must exist in the Translation Type table.

The value of the **typen** parameter must exist in the Translation Type table.

If the **tt** parameter is not specified, then the value of the **ttn** parameter must match the value of a **tt** parameter in the STP database.

The value of the **pc/pca/pci/pcn/pcn24** parameter cannot be out of range.

At least one optional parameter must be specified.

The value specified for the **pc** parameter cannot be associated with a proxy point code.

The AMGTT feature or the AMGTT CgPA Upgrade feature must be turned on before the **cggmod** parameter can be specified.

## Notes

The specified DPC, SSN, relative cost, and routing indicator will overwrite the existing data values in the table.

In this command, only ITU-international and ITU-national point codes support the spare point code subtype prefix (**s-**) and the private and spare point code subtype prefix (**ps-**). All of the point code types support the private (internal) point code subtype prefix (**p-**).

When the Intermediate GTT Load Sharing feature and the Flexible GTT Load Sharing feature are on, multiple relationships can be defined among a set of destination point codes in the existing MRN table. The relationship used in a particular translation is based on the GTA digits used for translation. The MRN Set and the post-translation PC formulate a key used as a lookup in the MRN table. The MRN table lookup results in a set of alternate PCs, one of which is selected (based on relative cost) to route the MSU in the most cost effective way.

When the Flexible GTT Load Sharing feature is turned on, multiple relationships among a set of PCs and SSNs in the existing MAP table are supported. The relationship used in a particular translation is based on the GTA digits used for translation. The MAP set ID and PC/SSN formulate a key that is used to perform lookup tasks in the MAP table. The lookup results in a set of mate PC/SSNs, one of which is selected to route the MSU in the most cost effective way.

If the ANSI-ITU-China SCCP Conversion feature is turned on, then the Translated Point Code (**pc**, **pca**, **pci**, **pcn**, and **pcn24** parameters) can be of a different network type than the Translation Type (**type** parameter).

If the ANSI-ITU-China SCCP Conversion and AMGTT features are turned on, and the Translated Point Code is of a different network type, then the **ngti** parameter specifies whether the new GTI translation format is GTI type 2 or GTI type 4.

If the AMGTT feature is turned OFF, then the **ngti** parameter cannot be specified and the Default GT Conversion Table is used for conversion. If the ANSI-ITU-China SCCP Conversion feature is turned OFF, then mixed network types are not allowed.

A loopset consists of a set of point codes that form a routing loop in the network. If the SCCP Loop Detection feature is enabled, then the loopset can be associated with or disassociated from specified translation entries. Loopsets that are associated with translation entries are checked during intermediate and final GTT traffic routing. If a loop exists, then the system can be notified with or without discarding the associated traffic.

The maximum length of the resulting GTA string must not exceed 21 digits when translation is complete.

If the range specified by the **gta** and **egta** parameters does not exactly match the existing range, then the existing range is split. All addresses in the existing range that are outside the range specified by the **gta** and **egta** parameters retain the original **xlat**, **ri**, **pc**, **ssn**, and **ngt** parameters.

A new range is created that is bounded by the **gta** and **egta** parameters. The new range contains new values for the **xlat**, **ri**, **pc**, **ssn**, and **ngt** parameters that are present in the command, while retaining parameter values from the previous range that do not have corresponding new values in the command.

To change existing **nsdd**, **nsds**, **npdd**, and **npds** parameter values, enter the command with the **rmgtt** parameter to reset the GT Modification values, and enter the command with new **nmp** and **nmai** or **npdd** and **npds** parameter values.

## Output

```
chg-gtt:gta=981234:type=4:cggtmod=yes
tekelecstp 08-02-24 17:29:06 EST EAGLE 38.0.0
CHG-GTT: MASP A - COMPLTD
;
```

## chg-gttsel

### Change GTT Selectors

Use this command to change the global title translation (GTT) set linked with an existing **gti(x)**, **tt**, **np/npv**, **nai/naiv**, **lsn**, **selid**, **eaglegen**, and **cgssn** combination.

**Keyword:** chg-gttsel

**Related Commands:** dlt-gttsel, ent-gttsel, rtrv-gttsel

**Command Class:** Database Administration

## Parameters

**NOTE:** The Origin-based SCCP Routing (OBSR) feature must be enabled before the **cdgtasn**, **cgpcsn**, **cggtasn**, or **cgssn** parameter can be specified. If the Flexible Linkset Optional



**Based Routing (FLOBR) feature is turned on, then the cdgtasn, cgpcsn, and cggtsn parameters cannot be specified.**

**NOTE: The FLOBR feature must be turned on before the cdgttsn, cggtsn, eaglegen, or lsn parameter can be specified.**

**NOTE: If the OBSR feature is enabled or the FLOBR feature is turned on, then the gttsn parameter cannot be specified.**

**NOTE: The OBSR feature must be enabled or the FLOBR feature must be turned on before the selid parameter can be specified.**

**:gti/gtia/gtii/gtin/gtin24=** (mandatory)

Global title indicator. For all EGTT selector commands, the domain is defined as **gti** and **gtia** (ANSI), **gtii** (ITU international), **gtin** (ITU national), and **gtin24** (24-bit ITU national).

For the selector commands, **gti** and **gtia** are equivalent; **gtii** and **gtin/gtin24** are mutually exclusive because the EGTT database does not distinguish between ITU national and ITU international translations. This means that while ITU-I and ITU-N selectors are stored separately, two separate ITU-I and ITU-N entries with the same selector values cannot exist. For example, if an entry with **gtii=2** and **tt=4** already exists, an entry of **gtin=2** and **tt=4** cannot be entered.

**Range:** Supported value for ANSI: **gti=2** and **gtia=2**  
Supported values for ITU: **gtii=2, 4** and **gtin/gtin24=2, 4**

**:tt=** (mandatory)

Translation type.

**Range:** **0-255**

**:cdgtasn=** (optional)

CdPA GTA GTT set name.

**Range:** *ayyyyyyyy*, **none**  
1 leading alphabetic character and up to 8 following alphanumeric characters.  
**none**—Set names do not point to the CdGTA set.

**:cdgttsn=** (optional)

CdPA GTT set name.

**Range:** *ayyyyyyyy*, **none**  
1 leading alphabetic and up to 8 following alphanumeric characters.  
**none**—Set names do not point to the CdPA GTT set.

**:cggtsn=** (optional)

CgPA GTA GTT set name.

**Range:** *ayyyyyyyy*, **none**  
1 leading alphabetic character and up to 8 following alphanumeric characters.  
**none**—Set names do not point to the CgGTA set.

**:cggtsn=** (optional)

CgPA GTT set name.

**Range:** *ayyyyyyyy*, **none**  
1 leading alphabetic and up to 8 following alphanumeric characters.  
**none**—Set names do not point to the CgPA GTT set.

**:cgpcsn=** (optional)

CgPA PC GTT set name.

**Range:** *ayyyyyyyy*, **none**  
 1 leading alphabetic character and up to 8 following alphanumeric characters.  
**none**—Set names do not point to the CgPC set.

**:cgssn=** (optional)

CgPA subsystem number.

**Range:** **0-255**

**:eaglegen=** (optional)

This parameter specifies whether the selector is used by EAGLE 5 ISS generated messages.

**Range:** **yes**

**yes** — used by an EAGLE 5 ISS MSU

**:gttsn=** (optional)

GTT set name. A GTT set is an entity to which global title addresses and selectors are assigned.

**Range:** *ayyyyyyyy*

1 leading alphabetic character and up to 8 following alphanumeric characters.

**:lsn=** (optional)

Linkset name. This parameter specifies the linkset that is used in GTT routing.

**Range:** *ayyyyyyyyy*

1 alphabetic character followed by up to 9 alphanumeric characters

**:nai=** (optional)

Nature of Address indicator. The Nature of Address indicator can be specified by supplying either a mnemonic value (**nai** parameter) or an explicit numeric value (**naiv** parameter). Either the **nai** parameter or the **naiv** parameter, but not both, can be specified in the command. Table A-5 shows the mapping between the **naiv** and the **nai** parameter values.

**Range:** **sub, rsvd, natl, intl, dflt**

**:naiv=** (optional)

Nature of Address indicator value. The Nature of Address indicator can be specified by supplying either a mnemonic value (**nai** parameter) or an explicit numeric value (**naiv** parameter). Either the **nai** parameter or the **naiv** parameter, but not both, can be specified in the command. Table A-5 shows the mapping between the **naiv** and the **nai** parameter values.

**Range:** **0-127**

**:np=** (optional)

Numbering Plan. The numbering plan can be specified by supplying either a mnemonic value (**np** parameter) or an explicit numeric value (**npv** parameter). Either the **np** parameter or the **npv** parameter, but not both, can be specified in the command. Table A-6 shows the mapping between the **npv** and the **np** parameter values.

**Range:** **e164, generic, x121, f69, e210, e212, e214, private, dflt**

**:npv=** (optional)

Numbering Plan value. The numbering plan indicator can be specified by supplying either a mnemonic value (**np** parameter) or an explicit numeric value (**npv** parameter). Either the **np** parameter or the **npv** parameter, but not both, can be specified in the command. Table A-6 shows the mapping between the **npv** and the **np** parameter values.

**Range:** **0-15**

**:selid=** (optional)

Selector ID.

**Range:** **0-65534**

**Example**

```
chg-
gttsel:gtii=2:tt=40:cdgtasn=setcggta:cgpcsn=none:cgssn=10:selid=1
2
```

```
chg-gtttsel:gtia=2:tt=253:gttsn=newansi
```

```
chg-gtttsel:gtin=4:tt=0:np=df1t:nai=df1t:gttsn=setint000
```

The following example would change the selectors (gtii=4, tt=5, npv=1, naiv=2) linked with GTTSN ansi1 so that the selectors are linked with ansi2 (assuming that ansi2 is an existing GTT set in the database):

```
chg-gtttsel:gtii=4:tt=5:npv=1:naiv=2:gttsn=ansi2
```

```
chg-
```

```
gttsel:gtin=4:tt=60:npv=5:naiv=5:cgpcsn=setcgpc:selid=100:cgssn=1
0
```

```
chg-
```

```
gttsel:gtia=2:tt=21:cggttsn=setcgpc:cdgttsn=setcdgta:cgssn=20:sel
id=1:lsn=ls10
```

```
chg-gtttsel:gtia=2:tt=2:cdgttsn=setcdgta:lsn=ls1010
```

```
chg-gtttsel:gtia=2:tt=2:cdgttsn=setcdgta:eaglegen=yes
```

**Dependencies**

The EGTT feature must be turned on before this command can be entered.

The **np** and **npv** parameters cannot be specified together in the same command.

The **nai** and **naiv** parameters cannot be specified together in the same command.

The parameter values **gtia=4**, **gti/gtia/gtii/gtin/gtin24=1**, and **gti/gtia/gtii/gtin/gtin24=3** cannot be specified.

When the **gti/gtia/gtii/gtin/gtin24=2** parameter is specified, the **np/npv** and **nai/naiv** parameter combinations cannot be specified.

When the **gtii/gtin/gtin24=4** parameter is specified, an **np(v)** and **nai(v)** parameter combination must be specified. These parameters can be specified in any combination: **np** and **naiv**, **npv** and **nai**, **np** and **nai**, or **npv** and **naiv**.

The network domain (ANSI or ITU) must match that of the GTT Set entry that is specified by the **cdgttsn**, **cdgtasn**, or **gttsn** parameter.

The GTT set specified by the **cdgtasn**, **cdgttsn**, or **gttsn** parameter must already exist in the GTT Set table.

A value of **none** cannot be specified for the **gttsn**, **cdgtasn**, **cdgttsn**, **cggttsn**, **cggtasn**, or **cgpcsn** parameter.

The OBSR feature must be enabled before the **cdgtasn**, **cggtasn**, **cgpcsn**, or **cgssn** parameter can be specified.

The GTT set specified by the **cggttsn**, **cggtasn**, or **cgpcsn** parameter must already exist in the GTT Set table.

The network domain of the CgPA GTT Set specified by the **cggttsn**, **cggtasn**, or **cgpcsn** parameter must match the domain indicated by the **gti(x)** parameter.

The set type specified by the **cggtasn** or **cgpcsn** parameter must match the set type of the corresponding entry in the GTT set table. For example, the **cggtasn** parameter should have a set type of **cggtta**, and the **cgpcsn** parameter should have a set type of **cgpc**.

A value of **none** cannot be specified for the **cdgtasn** parameter if the **gttsn** parameter specifies the only GTTSET associated with that selector.

The OBSR or FLOBR feature must be turned on before the **selid** parameter can be specified.

If the FLOBR feature is turned on, then the **cdgtasn**, **cggtasn**, and **cgpcsn** parameters cannot be specified.

An entry must already exist that matches the **gti(x)**, **tt**, and **np(v)** and **nai(v)** combination of parameters.

If the OBSR feature is enabled or the FLOBR feature is turned on, then the **gttsn** parameter cannot be specified.

The **np** and **nai** parameters must both have a value of **dflt** or neither can have a value of **dflt**.

The domain indicated by the **gti(x)** parameter must match the domain of the linkset specified by the **lsn** parameter.

The FLOBR feature must be turned on before the **lsn**, **eaglegen**, **cdgttsn**, and **cggttsn** parameters can be specified.

At least one GTT set name parameter must be specified. These parameters include:

- **cdgtasn**, **cggtasn**, or **cgpcsn** if the OBSR feature is enabled
- **cdgttsn** or **cggttsn** if the FLOBR feature is turned on
- **gttsn** if the OBSR feature is not enabled and the FLOBR feature is not turned on

The GTT Set specified by the **cdgttsn**, **cdgtasn**, or **gttsn** parameter must have a set type of **cdgta** (see the **ent-gttset** command).

The linkset specified by the **lsn** parameter must already exist in the Linkset table.

The SSNSELID Table cannot contain more than 100,000 entries.

The GTTDBMM Table cannot contain more than 42,502 entries.

If the **lsn** parameter is specified, then the **cdgttsn** or **cggttsn** parameter must be specified.

The **cggtasn**, **cgpcsn**, and **cggttsn** parameters cannot be specified together in the command.

The **gttsn**, **cdgtasn**, and **cdgttsn** parameters cannot be specified together in the command.

If the **gttsn**, **cdgttsn**, or **cdgtasn** parameter is specified, then the **cgssn** parameter cannot be specified.

If the **cggtasn**, **cgpcsn**, or **cggttsn** parameter is specified, then the **cgssn** parameter must be specified.

If the **gttsn** or **cdgtasn** parameter is specified, then the **selid** parameter cannot be specified.

If the **eaglegen=yes** parameter is specified, then the **lsn**, **selid**, **gttsn**, **cdgtasn**, **cgssn**, **cggttsn**, **cggtasn**, and **cgpcsn** parameters cannot be specified.

If the **np=dflt** or **nai=dflt** parameter is specified, then the **cggtasn**, **cggttsn**, **cgpcsn**, **cgssn**, **eaglegen**, **lsn**, and **selid** parameters cannot be specified.

## Notes

When the EGTT feature is turned on, the GTT Selector (**ent/chg/dlt/rtrv-gttset**), GTT Set (**ent/dlt/rtrv-gttset**), and GTA (**ent/chg/dlt/rtrv-gta**) commands replace the Translation Type (**ent/dlt/rtrv-tt**) and Global Title Translation (**ent/chg/dlt/rtrv-gtt**) commands. All data previously provisioned with these commands is maintained.

The entry that matches the specified parameter combination is assigned to the specified **gttsn**.

When the Origin-based SCCP Routing feature is enabled, two GTT sets, either the **cdgtasn/cggtasn** or the **cdgtasn/cgpcsn**, can be assigned to a GTT selector. The **cggtasn** and **cgpcsn** GTT sets are mutually exclusive and cannot be assigned to the same GTT selector.

When the value of the **cggtasn/cgpcsn** GTT set is specified as **none**, that combination (domain, **tt**, **gti**, **np/npi**, **na/ani**, **cgssn**, and **selid**) are deleted from the database. At any point of time, each provisioned selector must have at least one GTT set.

### Output

```
chg-gttset:gti=2:tt=10:gttsn=t800

rlghncxa03w 04-01-18 08:50:12 EST EAGLE 31.3.0
GTT Selector table is (114 of 1024) 11% full
CHG-GTTSEL: MASP A - CMLPTD
;
```

## chg-gttset

### Change GTT Set

Use this command to specify the attributes to change for an existing set of global title translations.

**Keyword:** **chg-gttset**

**Related Commands:** **dlt-gttset**, **ent-gttset**, **rtrv-gttset**

**Command Class:** Database Administration

### Parameters

**:gttsn=** (mandatory)

GTT set name. A GTT set is an entity to which global title addresses and selectors are assigned.

**Range:** *ayyyyyyyy*

1 alphabetic character followed by up to 8 alphanumeric characters.

**:ndgt=** (optional)

Number of digits. This parameter specifies the number of digits required for GTAs (global title addresses) associated with this GTT set.

If the VGTT feature is turned on or if the **settype** parameter has a value of **cgpc**, **cgssn**, **opc**, **cdssn**, or **opcode**, then this parameter cannot be specified.

**Range:** **1-21**

**:netdom=** (optional)

Network domain. This command does not distinguish between ITU national or ITU international because the Enhanced Global Title Translation (EGTT) feature does not discriminate between the ITU-I and ITU-N translations.

**NOTE: The netdom parameter refers to the incoming message network domain.**

**Range:** **cross, ansi, itu**

### Example

```
chg-gttset:gttsn=lidb:netdom=cross
chg-gttset:gttsn=setxyz:netdom=cross:ndgt=10
```

### Dependencies

The **gttsn=none** parameter cannot be specified.

The specified **netdom** parameter value must be **cross**. This command cannot be used to change the **netdom** setting from **cross** to **ansi** or **itu**.

The **ndgt** parameter cannot be specified if the **settype** parameter has a value of **cdssn**, **cgpc**, **cgssn**, **opc**, or **opcode**.

The EGTT feature must be turned on prior to using this command.

The value specified for the **gttsn** parameter must match the name of an existing GTT Set.

If the VGTT feature is turned on, the **ndgt** parameter cannot be specified.

The ANSI-ITU-China SCCP Conversion feature must be turned on before the **netdom** parameter can be specified.

If GTAs are assigned to the GTT set, the **ndgt** parameter cannot be specified.

The **netdom=cross** parameter can be specified only if the **settype=cdgta** parameter is specified.

### Output

```
chg-gttset:gttsn=lidb:netdom=cross
rlghncxa03w 09-08-01 08:50:12 EST EAGLE 41.1.0
CHG-GTTSET: MASP A - COMPLTD

GTT-SET table is (3 of 2000) 1% full.
```

## chg-gtw-stp

### Change Gateway Parameters

Use this command to modify the level 3 ANSI transfer control status (TFCSTAT) when converted from ITU to ANSI.

**Keyword:** chg-gtw-stp

**Related Commands:** rtrv-gtw-stp

**Command Class:** Database Administration

### Parameters

**:tfcstat=** (mandatory)

This parameter identifies the desired level 3 control status on a TFC message received from an ITU node destined for an ANSI node.

**Range:** 1-3

### Example

```
chg-gtw-stp:tfcstat=1
```

### Dependencies

None

### Notes

None

### Output

```
chg-gtw-stp:tfcstat=1

rlghncxa03w 04-01-11 11:34:04 EST EAGLE 31.3.0
CHG-GTW-STP: MASP A - COMPLTD
;
```

## chg-gws-actset

### Change Gateway Screening Stop Action Sets

Use this command to configure the gateway screening (GWS) stop action sets in the system database. Stop action sets are used to define the actions performed on the Message Sending Units (MSUs) that pass the gateway screening process. The GWS Stop Action table contains a maximum of 16 stop action sets, with each stop action set containing a maximum of 10 stop actions. The first three GWS stop action sets (**actid=1**, **actid=2**, and **actid=3**) are already defined with the existing GWS stop actions shown in Table 5-12.

**Table 5-12.** Gateway Screening Stop Action Definitions

Gateway Screening Stop Action ID	Gateway Screening Stop Action Set Name	Stop Action 1	Stop Action 2	Action Performed by the system
1	copy	copy	—	Copy the MSU for the STP LAN feature.
2	rdct	rdct	—	Redirect the MSU for the DTA feature.
3	cr	copy	rdct	Copy the MSU for the STP LAN feature and redirect the MSU for the DTA feature.



**CAUTION:** Even though gateway screening is in the screen test mode, as defined by the parameters `gwsa=off` and `gwsn=on` in the `chg-ls` command, the GWS action in the stop action set *will* be performed at the end of the screening process.

**Keyword:** `chg-gws-actset`  
**Related Commands:** `rtrv-gws-actset`  
**Command Class:** Database Administration

**Parameters**

**NOTE:** Each of the `tif`, `tif2`, and `tif3` stop actions represents a specific TIF service. These services are provisioned using the `chg-npp-serv` command.

**NOTE:** For definitions of the values for the `act1` - `act10` parameters, see the *Notes* section.

**:actid=** (mandatory)

The identification number of the GWS stop action set.

**Range:** 4-16

**:act1=** (optional)

Stop action 1.

**Range:** `cnf`, `copy`, `none`, `rdct`, `tlnp`, `tinp`, `tif`, `tif2`, `tif3`, `sccp`

**Default:** No change to the existing value.

**:act10=** (optional)

Stop action 10.

**Range:** `cnf`, `copy`, `none`, `rdct`, `tlnp`, `tinp`, `tif`, `tif2`, `tif3`, `sccp`

**Default:** No change to the existing value.

**:act2=** (optional)

Stop action 2.

**Range:** `cnf`, `copy`, `none`, `rdct`, `tlnp`, `tinp`, `tif`, `tif2`, `tif3`, `sccp`

**Default:** No change to the existing value.

**:act3=** (optional)

Stop action 3.

**Range:** `cnf`, `copy`, `none`, `rdct`, `tlnp`, `tinp`, `tif`, `tif2`, `tif3`, `sccp`

- Default:** No change to the existing value.
- :act4=** (optional)  
Stop action 4.  
**Range:** **cncf, copy, none, rdct, tlnp, tinp, tif, tif2, tif3, sccp**  
**Default:** No change to the existing value.
- :act5=** (optional)  
Stop action 5.  
**Range:** **cncf, copy, none, rdct, tlnp, tinp, tif, tif2, tif3, sccp**  
**Default:** No change to the existing value.
- :act6=** (optional)  
Stop action 6.  
**Range:** **cncf, copy, none, rdct, tlnp, tinp, tif, tif2, tif3, sccp**  
**Default:** No change to the existing value.
- :act7=** (optional)  
Stop action 7.  
**Range:** **cncf, copy, none, rdct, tlnp, tinp, tif, tif2, tif3, sccp**  
**Default:** No change to the existing value.
- :act8=** (optional)  
Stop action 8.  
**Range:** **cncf, copy, none, rdct, tlnp, tinp, tif, tif2, tif3, sccp**  
**Default:** No change to the existing value.
- :act9=** (optional)  
Stop action 9.  
**Range:** **cncf, copy, none, rdct, tlnp, tinp, tif, tif2, tif3, sccp**  
**Default:** No change to the existing value.
- :actname=** (optional)  
The name of the GWS stop action set.  
This parameter is mandatory when an action set is first entered.  
**Range:** *ayyyyy*  
One alphabetic character followed by up to five alphanumeric characters.  
**Default:** No change to the existing value.
- :all=** (optional)  
The **all=none** parameter clears all of the actions in the specified stop action set, and deletes the stop action set.  
**Range:** **none**  
**Default:** Undefined
- :force=** (optional)  
Use the **force=yes** parameter when erasing the action set or changing the action name.  
**Range:** **yes**

**Example**

```
chg-gws-actset:actid=4:actname=cncf:act1=cncf
```

**Dependencies**

At least one optional parameter must be specified.

If the **all=none** parameter is specified, then no other optional parameters can be specified.

The **actname=none** parameter cannot be specified.



The **force=yes** parameter must be specified to change an existing stop action.

The Calling Name Conversion Feature (CNCF) must be turned on before a value of **cncf** can be specified for the **act1** through **act10** parameters.

To provision a Gateway Screening TLNP stop action (**tlnp**), either the TLNP feature must be turned on or the ISUP NP with EPAP feature must be enabled.

If **tlnp** is specified for **act1** through **act10** for Triggerless LNP in the system,

- The Triggerless LNP feature (TLNP) must be on. Use the **rtrv-feat** command to determine whether TLNP is on or off. If TLNP is off, TLNP can be turned on with the **chg-feat** command. (Verify that TLNP has been purchased for your system before you turn it on.)
- The LNP (Local Number Portability) and GWS (Gateway Screening) features must be on before TLNP can be turned on. See the **enable-ctrl-feat** command and the **chg-feat** command.

If **tlnp** is specified for **act1** through **act10** with the ISUP NP with EPAP feature in the system,

- The ISUP NP with EPAP feature must be enabled. Use the **rtrv-ctrl-feat** command to determine whether the ISUP NP with EPAP feature is enabled. The feature is listed in the output if it is enabled. If the ISUP NP with EPAP feature does not appear in the output, you must purchase it and receive the feature access key before you can enable it with the **enable-ctrl-feat** command.
- The G-Port and GWS (Gateway Screening) features must be on before the ISUP NP with EPAP feature can be enabled. See the **chg-feat** command.

A specific gateway screening stop action (**cncf**, **copy**, **none**, **rdct**, **tif**, **tif2**, **tif3**, **tlnp**, **tinp**) can be specified for one and only one gateway screening stop action parameter for each gateway screening stop action set.

If a value is entered for the **actname** parameter, the value must be unique. Note that the **actname** parameter is *mandatory* when you first enter a gateway screening stop action set in the database and *optional* thereafter.

If **copy** is specified for an action set, it must be specified in stop action 1 (**act1**). A parameter value of **copy** cannot be specified for **act2** through **act10**.

If the redirect gateway screening action (**rdct**) is specified with other gateway screening stop actions, it must be specified with the last gateway screening stop action parameter specified for the command.

The **tlnp** (Triggerless LNP) gateway screening stop action cannot be specified in the same action set with either the **cncf** (Calling Name Conversion Facility) or **rdct** (Redirect) gateway screening stop actions.

The **tinp** (Triggerless ISUP NP) gateway screening stop action cannot be specified in the same action set with the **cncf** (Calling Name Conversion Facility) gateway screening stop action.

The TINP feature must have been enabled before upgrading to Release 39.2 or later before the **tinp** stop action can be specified.

At least one TIF feature must be enabled before the **tif**, **tif2**, or **tif3** stop action can be specified.

Only one of the **tif**, **tif2**, **tif3**, **tlnp**, **tinp**, **rdct**, and **sccp** stop actions can be specified in the command.

If specified, the **tif**, **tif2**, **tif3**, **tlnp**, **tinp**, **rdct**, or **sccp** stop action must be the last stop action in the command.

The **sccp** GWS stop action cannot be specified in the same Action Set with the **cncf** GWS stop action.

The MTP Routed GWS Stop Action feature must be enabled before the **sccp** GWS stop action can be specified.

**Notes**

The GWS stop action 1 (**act1**) is the first stop action to be performed, and GWS stop action 10 (**act10**) is the last stop action to be performed on the MSU. These parameters can have the following values:

- **cncf**—Convert the PIP parameter with the GN parameter or the GN parameter with the PIP parameter in the ISUP IAM message for the Calling Name Conversion Facility feature
- **copy**—Copy the MSU for the STP LAN feature
- **none**—No action is performed on the MSU
- **rdct**—Redirect the MSU for the DTA feature
- **tif**—Apply TIF processing to MSU
- **tif2**—Apply TIF processing to MSU
- **tif3**—Apply TIF processing to MSU
- **tinp**—ISUP IAMs that pass gateway screening are intercepted by the Triggerless ISUP NP equipped EAGLE 5 ISS and converted to include the RN if the call is to a ported number. This GWS stop action applies only to the Triggerless ISUP NP feature.
- **tlnp**—ISUP IAMs that pass gateway screening are intercepted by the Triggerless LNP equipped EAGLE 5 ISS and converted to include the LRN if the call is to a ported number. This GWS stop action applies only to the Triggerless LNP feature.
- **sccp**—SCCP messages that pass gateway screening are forwarded to the SCCP card for service processing. This GWS stop action applies only to MTP routed UDT/UDTS and XUDT/XUDTS messages.

**Output**

```
chg-gws-actset:actid=4:actname=cncf:act1=cncf
rlghncxa03w 04-01-10 11:43:04 EST EAGLE 31.3.0
CAUTION: GWS action set may be referenced by one or more GWS rules
CHG-GWS-ACTSET: MASP A - COMPLTD
;
```

**chg-gws-redirect****Change Gateway Screening Redirect**

Use this command to change the provisioning data for the redirect function. The values that are specified for this command are stored in the Redirect table, and they are used to set the variable fields of the MSUs being redirected. For example, if the **ri=gt** parameter is specified, the value **gt** is set for the routing indicator in the called party address (CDPA) of the MSU being redirected.

**Keyword:** **chg-gws-redirect**

**Related Commands:** **dlt-gws-redirect**, **ent-gws-redirect**,

**Command Class:** Database Administration

**Parameters**

**NOTE:** See "Point Code Formats and Conversion" for a detailed description of point code formats, rules for specification, and examples.

**:dpc=** (optional)

Specifies the value used to set the ANSI destination point code field in the routing label of the MSU that is being redirected. The point code has subfields *network indicator-network cluster-network cluster member (ni-nc-ncm)*.

**Synonym:** **dpca**

**Range:** 000-255

Specify a valid value for each subfield of the point code, and separate the subfields with a dash (-).

When **chg-sid:pctype=ansi** is specified, *ni* = 000 is not valid.

When **chg-sid:pctype=ansi** is specified, *nc* = 000 is not valid if *ni* = 001-005.

When **chg-sid:pctype=ansi** is specified, *nc* = 000 is valid if *ni* = 006-255.

The point code 000-000-000 is not a valid point code.

**Default:** Current value.

**:dpc/dpca/dpci/dpcn/dpcn24=** (optional)

Destination point code.

**:dpci=** (optional)

Specifies the value used to set the ITU international destination point code field in the routing label of the MSU that is being redirected. The point code has subfields *zone-area-id*.

**Range:** 0-255

Specify a valid value for each subfield of the point code, and separate the subfields with a dash (-).

The point code 0-000-0 is not a valid point code.

*zone*—0-7

*area*—000-255

*id*—0-7

**Default:** Current value.

**:dpcn=** (optional)

Specifies the value used to set the ITU national destination point code field in the routing label of the MSU that is being redirected. The point code is in the format of a 5-digit number (*nnnnn*); or 2, 3, or 4 numbers (members) separated by dashes (*m1-m2-m3-m4*) when the **chg-stpopts:npfnti** flexible point code option is on. A group code (*gc*) must be specified when the ITUDUPPC feature is on (*nnnnn-gc*, *m1-m2-m3-m4-gc*).

**Range:** 0-16383, aa-zz

Specify a valid value for each subfield of the point code, and separate the subfields with a dash (-).

*nnnnn*—0-16383

*gc*—aa-zz

*m1-m2-m3-m4*—0-14 for each member; values must sum to 14

**Default:** Current value.

**:dpcn24=** (optional)

Specifies the value used to set the 24-bit ITU national destination point code field in the routing label of the MSU that is being redirected. The point code has subfields *main signaling area-sub signaling area-signaling point* (*msa-ssa-sp*).

**Range:** 000-255

Specify a valid value for each subfield of the point code, and separate the subfields with a dash (-).

*msa*—000-255

*ssa*—000-255

*sp*—000-255

**Default:** Current value.

**:enabled=** (optional)

Specifies whether MSUs that have passed gateway screening are to be redirected (**enabled=on**) or routed as normal (**enabled=off**).

**Range:** on, off

**Default:** Current value.

**:gta=** (optional)

Specifies the value used to set the global title address (dialed digits) in the SCCP called party address of the MSU being redirected.

**Range:** 1-21 digits

**:ri=** (optional)

Specifies the value used to set the routing indicator in the SCCP called party address of the MSU being redirected. Use the **gt** value to route by global title digits or use the **ssn** value to route by subsystem number.

**Range:** gt, ssn

**Default:** Current value

**:ssn=** (optional)

Specifies the value used to set the subsystem number (SSN) in the SCCP called party address of the MSU being redirected. This number is the SSN of the SCP to which all MSUs meeting the redirect criteria are to be redirected.

**Range:** 0-255

**Default:** Current value

**:tt=** (optional)

Identifies the type of the global title translation (GTT). It is the decimal representation of the 1-byte field used in SS7. This value is used to set the type of the GTT in the SCCP called party address of the MSU being redirected.

**Range:** 0-255

**Default:** Current value

**Example**

```
chg-gws-redirect:dpc=111-222-111:ri=gt:ssn=10:tt=1:gta=180833:enabled=on
```

```
chg-gws-redirect:dpc=111-222-111:ri=ssn:ssn=10:tt=1:gta=1800833:enabled=off
```

```
chg-gws-redirect:enabled=off
```

**Dependencies**

At least one optional parameter must be specified.

The **dpc/dpca/dpci/dpcn/dpcn24** parameter must be defined in the Destination table or defined as the STP site point code.

If the **dpc/dpca/dpci/dpcn/dpcn24** parameter is defined as a destination, at least one route must be defined.

The redirect function data must exist in the database before it can be changed with this command.

**Notes**

None

**Output**

```
chg-gws-redirect:dpc=111-222-111:ri=gt:ssn=10:tt=1:gta=180833:enabled=on
```

```
rlghncxa03w 04-07-10 11:43:04 EST EAGLE 31.6.0
CHG-GWS-REDIRECT: MASP A - COMPLTD
```

```
;
```

**chg-inpopts****Change INP Options Command**

Use this command to provision INP-specific data. This command updates the INPOPTS table.

**Keyword:** **chg-inpopts**

**Related Commands:** **rtrv-inpopts**

**Command Class:** Database Administration

**Parameters**

**:cdpnnai=** (optional)

Called Party Number Nature of Address indicator.

**Range:** **0-127**

The following **cdpnnai** parameter values are valid for this feature:

- **1** (Subscriber), **2** (Unknown), **3** (National), and **4** (International)

**Default:** Current value

**:cdnpfx=** (optional)

Called Party Number Prefix.

**Range:** 1-15 digits

Valid digits are **0-9, A-F, a-f**.

**Default:** Current value

**:defrn=** (optional)

Default routing number. This parameter specifies a default routing number that is used for own-network subscribers.

**Range:** 1-15 digits, **none**

Valid digits are **0-9, a-f, A-F**.

**Default:** No change to the current value

**System**

**Default:** **none**

**:dltpfx=** (optional)

Delete prefix.

**Range:** **yes, no**

**Default:** **no**

**:dra=** (optional)

The destination routing address.

**Range:** **rndn, rn, ccrndn, rnnecdn, homerndn, rnasd, asdrn, rnasddn, asdrndn, cernasddn, asdrnccdn, ccasdrndn, rnasdccdn, rnasdnecdn, asdrnnecdn, rngrn, grnrn, rngrndn, grnrndn, cerngrndn, ccgrnrndn, grnrnccdn, rngrnccdn, rngrnnecdn, grnrnnecdn**

**rndn**— Supports RN + [CDPNPFX] + DN in the INP "CONNECT" response messages

**rn**— Supports Routing Number in the INP "CONNECT" response messages.

**ccrndn**— Supports [CDPNPFX] +CC + RN + DN in the INP "CONNECT" response messages.

**rnnecdn**— Supports RN+ [CDPNPFX]+ NEC+ DN in the INP "CONNECT" response messages.

**homerndn**— Supports Home Routing Number in the INP "CONNECT" response messages.

**rnasd**— Supports RN+ ASD in the INP "CONNECT" response messages.

**asdrn**— Supports ASD+RN in the INP "CONNECT" response messages.

**rnasddn**— Supports RN +ASD+ [CDPNPFX] + DN in the INP "CONNECT" response messages.

**asdrndn**— Supports ASD+ RN + [CDPNPFX] + DN in the INP "CONNECT" response messages.

**ccrnasddn**— Supports [CDPNPFX] +CC + RN + ASD+DN in the INP "CONNECT" response messages.

**asdrnccdn**— Supports ASD+ RN+ [CDPNPFX]+ CC+ DN in the INP "CONNECT" response messages.

**ccasdrndn**— Supports [CDPNPFX] +CC + ASD + RN+DN in the INP "CONNECT" response messages.

**rnasdccdn**— Supports RN + ASD + [CDPNPFX] +CC + DN in the INP "CONNECT" response messages.

**rnasdnecdn**— Supports RN+ ASD + [CDPNPFX]+ NEC+ DN in the INP "CONNECT" response messages.

**asdrnnecdn**— Supports ASD + RN+ [CDPNPFX]+ NEC+ DN in the INP "CONNECT" response messages.

**rngrn**— Supports RN + GRN in the INP "CONNECT" response messages.

**grnrn**— Supports GRN + RN in the INP "CONNECT" response messages.

**rngrndn**— Supports RN + GRN + [CDPNPFX] + DN in the INP "CONNECT" response messages.

**grnrndn**— Supports GRN + RN + [CDPNPFX] + DN in the INP "CONNECT" response messages.

**ccrngrndn**— Supports [CDPNPFX] + CC + RN + GRN + DN in the INP "CONNECT" response messages.

**ccgrnrndn**— Supports [CDPNPFX] + CC + GRN + RN + DN in the INP "CONNECT" response messages.

**grnrnccdn**— Supports GRN + RN+ [CDPNPFX] + CC + DN in the INP "CONNECT" response messages.

**rngrnccdn**— Supports RN + GRN + [CDPNPFX] + CC + DN in the INP "CONNECT" response messages.

**rngrnnecdn**— Supports RN + GRN + [CDPNPFX] + NEC + DN in the INP "CONNECT" response messages.

**grnrnnecdn**— Supports GRN + RN + [CDPNPFX] + NEC + DN in the INP "CONNECT" response messages.

**Default:** No change to the current value

**System**

**Default:** **rndn**

**:dranai=** (optional)

The Nature of Address indicator.

**Range:** **sub, unknown, natl, intl, ntwk**

**NOTE: The nature of address indicator parameters (dranaiv or dranai) can be specified by supplying either a mnemonic or an explicit value. At no time may both the mnemonic and the explicit value be specified at the same time for the**

same parameter. Either the **dranaiv** or **dranai** parameter can be specified. Table 5-13 shows the mapping between the **drnaiv** and the **drnai** parameters.

Table 5-13. DRANAIV/DRANAI Mapping

dranaiv	dranai	Description
1	sub	Subscriber Number
2	unknown	Unknown
3	natl	National significant number
4	intl	International number
5	ntwk	Network
The mnemonic's list is different from the list for the Service Selector commands because the INAP destination routing address uses ISUP values instead of SCCP values.		

**Default:** Current value

**:dranaiv=** (optional)

The Nature of Address indicator value.

The nature of address indicator parameters (**dranaiv** or **dranai**) can be specified by supplying either a mnemonic or an explicit value. At no time may both the mnemonic and the explicit value be specified at the same time for the same parameter. Either the **dranaiv** or **dranai** parameter can be specified. Table 5-13 shows the mapping between the **drnaiv** and the **drnai** parameters.

**Range:** 0-127

**:dranp=** (optional)

The numbering plan.

**NOTE: The numbering plan parameters (dranpv or dranp) can be specified by supplying either a mnemonic or an explicit value. At no time may both the mnemonic and the explicit value be specified at the same time for the same parameter. Either the dranpv or dranp parameter can be specified. Table 5-14 shows the mapping between the dranpv and the dranp parameters.**

**Range:** e164, x121, f69

**Default:** Current value

**:dranpv=** (optional)

The numbering plan value.

**NOTE: The numbering plan parameters (dranpv or dranp) can be specified by supplying either a mnemonic or an explicit value. At no time may both the mnemonic and the explicit value be specified at the same time for the same parameter. Either the dranpv or dranp parameter can be specified. Table 5-14 shows the mapping between the dranpv and the dranp parameters**

Table 5-14. DRANPV/DRANP Mapping

dranpv	dranp	Description
1	E164	ISDN/telephony numbering plan
3	X121	Data numbering plan

**Table 5-14.** DRANPV/DRANP Mapping

<b>dranpv</b>	<b>dranp</b>	<b>Description</b>
4	F69	Telex numbering plan
Several of the numbering plan mnemonics that apply to the Service Selector commands are not in this list because they do not apply to INAP destination routing addresses.		

**Range:** 0-7  
**Default:** Current value

**:ncdnpfx=** (optional)  
 The New Called Party Number Prefix.

**Range:** 1-15 digits, **none**  
 Valid digits are **0-9, a-f, A-F**.

**:nec=** (optional)  
 National Escape Code.

**Range:** 1-5 digits, **none**  
 Valid digits are **0-9, A-F, a-f**.

**Default:** **None**.

**:relcause=** (optional)  
 Release cause. This parameter specifies the reason for releasing the call when an INP Circular Route is detected.

**Range:** 1-127  
**Default:** 31 - normal, unspecified

**:snai=** (optional)  
 The Service Nature of Address indicator.

**Range:** **sub, natl, intl, none, unknown**  
**Default:** Current value

**:sporttype=** (optional)  
 Service Portability type. This parameter specifies whether Service Portability is performed for the associated feature.

The S-Port feature must be enabled before this parameter can be specified. The S-Port feature must be turned on before any change to the parameter will impact the associated feature.

**Range:** **gsm, is41, all, none**  
**gsm** — Apply Service Portability prefix (RTDB ‘GRN’ entity id) for own-network GSM subscribers  
**is41** — Apply Service Portability prefix (RTDB ‘GRN’ entity id) for own-network IS41 subscribers  
**all** — Apply Service Portability prefix (RTDB ‘GRN’ entity id) for all own-network (IS41 and GSM) subscribers  
**none** — Service Portability is not performed for the feature.

**Default:** No change to the current value

**System**

**Default:** **none**

**:sprestype=** (optional)  
 INP option that indicates the type of message the EAGLE 5 ISS is to send when an IDP message is received for INP service, the DN digits match, and the HLR ID is present.

**Range:** **connect, continue**  
**connect** — The EAGLE 5 ISS sends a “Connect” message.



**continue** — The EAGLE 5 ISS sends a “Continue” message.  
**Default:** **continue**

**Example**

```
chg-inpopts:dra=rn:dranp=e164:dranai=intl
chg-inpopts:dranp=f69:dranai=sub:dra=rndn
chg-inpopts:dra=rn:dranp=e164:dranai=intl:cdpnpx=fac:dltpr=yes
chg-inpopts:dranp=f69:dranai=sub:dra=rndn:cdpnpx=200
chg-
inpopts:dranp=f69:dranai=sub:dra=rndn:cdpnpx=200:ncdpnpx=3abcde
f:dltpr=yes
chg-
inpopts:dranp=f69:dranai=sub:dra=rndn:cdpnpx=3abcdef:ncdpnpx=no
ne
chg-
inpopts:dranp=f69:dranai=sub:dra=rndn:cdpnpx=fed123:dltpr=no
chg-
inpopts:dra=rn:dranp=e164:dranai=intl:cdpnpx=fac:dltpr=yes:cdp
nai=50 :snai=intl
chg-
inpopts:dra=rndn:dranp=x121:dranai=intl:cdpnpx=fac:dltpr=no:cdp
nnai=1:snai=natl
chg-
inpopts:dra=rn:dranp=e164:dranai=intl:cdpnpx=fac:dltpr=yes:cdp
nai=70 :snai=sub
chg-
inpopts:dra=rn:dranp=e164:dranai=intl:cdpnpx=fac:dltpr=no:cdpnn
ai=1 :snai=none
chg-inpopts:sprestype=connect
chg-inpopts:dra=rnnecdn:nec=abcd1
chg-inpopts:dra=rnnecdn:nec=0
chg-inpopts:dra=homern:dranp=e164:dranai=intl
chg-inpopts:dra=rnasd:nec=0
chg-inpopts:dra=asdrndn:dranp=e164:dranai=intl
chg-
inpopts:dra=asdrnccdn:dranp=e164:dranai=intl:cdpnpx=fac:dltpr=y
es
chg-inpopts:dra=rnasdnecdn:nec=0
chg-inpopts:relcause=30
chg-inpopts:dra=grnrndn:dranp=e164:dranai=intl
chg-inpopts:dra=rngrn:nec=0
chg-inpopts:dranp=e164:dranaiv=10:dra=rn
chg-inpopts:dranai=sub:dranpv=3
chg-inpopts:dranpv=4:dranaiv=20
chg-inpopts:cdpnpx=2a3b4c5d6e7f
```

```
chg-inpopts:cdpnnai=1:snai=sub
```

### Dependencies

At least one optional parameter must be specified.

The **dranp** and **dranpv** parameters cannot be specified together in the command.

The **dranai** and **dranaiv** parameters cannot be specified together in the command.

If the **ncdnpfx** or **dltplx** parameter is specified, the **cdnpfx** parameter must be specified.

A value of **none** cannot be specified for the **cdnpfx** parameter.

If the **ncdnpfx=none** parameter is specified, then the **dltplx** parameter cannot be specified.

The specified Called Party Number Prefix (**cdnpfx** parameter) must exist in the INPOPTS table.

The specified New Called Party Number Prefix (**ncdnpfx** parameter) must not already exist in the INPOPTS table.

A maximum of 5 Called Party Number Nature of Address values is allowed.

The **cdpnai** and **snai** parameters must be specified together in the command.

If this command is entered to delete a Called Party Number Nature of Address value from the INPOPTS table (for example, if the command is entered with **:cdpnai=1:ssnai=none**), then the value for the **cdpnai** parameter must exist in the INPOPTS table.

The National Escape Code (**nec** parameter) can contain between 1 and 5 digits. Otherwise the value is **none**.

A maximum of 40 Called Party Number Prefix values can be provisioned.

If the **nec=none** parameter is specified, then values of **asdrnecdn**, **rnsdrnecdn**, **rnnecdn**, **rngrnecdn**, and **grnrnecdn** cannot be specified for the **dra** parameter.

The INP CRP feature must be enabled before the **relcause** parameter can be specified.

The S-Port feature must be enabled before the **sporttype** parameter can be specified.

The INP feature must be enabled before this command can be entered.

### Output

```
chg-inpopts:dra=rngrn:nec=0
tekelecstp 09-05-05 12:20:32 EST EAGLE 41.1.0
CHG-INPOPTS: MASP A - COMPLTD
;
```

## chg-ip-card

## Change Internet Protocol Card

Use this command to provision IP networking parameters for a given card.

**Keyword:** chg-ip-card

**Related Commands:** chg-sg-opts, rtrv-ip-card

**Command Class:** Database Administration

### Parameters

**:loc=** (mandatory)

Card location. The unique identifier of a specific application subsystem located in the STP.

**Range:** 1101-1108, 1111-1112, 1201-1208, 1211-1218, 1301-1308, 1311-1318, 2101-2108, 2111-2118, 2201-2208, 2211-2218, 2301-2308, 2311-2318, 3101-3108, 3111-3118, 3201-3208, 3211-3218, 3301-3308, 3311-3318, 4101-4108, 4111-4118, 4201-4208, 4211-4218, 4301-4308, 4311-4318, 5101-5108, 5111-5118, 5201-5208, 5211-5218, 5301-5308, 5311-5318, 6101-6108, 6111-6118

**:bipaddr=** (optional)

Bonded Port IP address. This parameter specifies an IP address for the card in the specified location.

**Range:** 4 numbers separated by dots, with each number in the range of **0-255**.

A value of **0.0.0.0** removes the IP address.

**Default:** No change to the current value

**:bpsubmask=** (optional)

Bonded Port IP submask.

**Range:** The value must be valid for the class of the entered IP address.

**Table 5-15.** Valid Subnet Mask Values

Valid for Class A Networks	Valid for Class A or B Networks	Valid for Class A, B, or C Networks
255.0.0.0	255.255.0.0	255.255.255.0
255.192.0.0	255.255.192.0	255.255.255.192
255.224.0.0	255.255.224.0	255.255.255.224
255.240.0.0	255.255.240.0	255.255.255.240
255.248.0.0	255.255.248.0	255.255.255.248
255.252.0.0	255.255.252.0	255.255.255.252
255.254.0.0	255.255.254.0	
255.255.128.0	255.255.255.128	

**:defrouter=** (optional)

Default router IP address. This is a TCP/IP address expressed in standard dot notation. IP addresses consist of the system's network number and the machine's unique host number. An example IP address is 192.126.100.5, where 192.126.100 is the network number and 5 is the machine's host number.

**Range:** 4 numbers separated by dots, with each number in the range of **0-255**.

A value of **0.0.0.0** will remove an IP address from this parameter.

**Default:** No change to the parameter value

**System**

**Default: 0.0.0.0**

**:dnasa=** (optional)

The IP address for Domain Name Server A. This is a TCP/IP address expressed in standard dot notation. IP addresses consist of the system's network number and the machine's unique host number. An example IP address is 192.126.100.5, where 192.126.100 is the network number and 5 is the machine's host number.

**Range:** 4 numbers separated by dots, with each number in the range of **0-255**.

A value of **0.0.0.0** will remove an IP address from this parameter.

**Default:** No change to the parameter value.

**System**

**Default: 0.0.0.0**

- :dn**sb**=** (optional)  
 The IP address for Domain Name Server B. This is a TCP/IP address expressed in standard dot notation. IP addresses consist of the system's network number and the machine's unique host number. An example IP address is 192.126.100.5, where 192.126.100 is the network number and 5 is the machine's host number.  
**Range:** 4 numbers separated by dots, with each number in the range of **0-255**.  
 A value of **0.0.0.0** will remove an IP address from this parameter.  
**Default:** No change to the parameter value.  
**System**  
**Default:** **0.0.0.0**
  
- :domain=** (optional)  
 Domain name of the Domain server.  
**Range:**   
 ~~~~~  
 ~~~~~  
 Any string of characters beginning with a letter and comprising up to 120 characters in length.  
 Valid characters are **a-z, A-Z, 0-9, -** (dash), **.** (period).  
**Default:** No change to the parameter value.  
**System**  
**Default:** Null
  
- :rstdomain=** (optional)  
 Reset Domain Name. This parameter is used to reset the Domain Name to a NULL value.  
**Range:** **yes, no**  
**yes**—reset Domain Name to a NULL value  
**no**—Domain Name does not change  
**Default:** **no**
  
- :sctpsum=** (optional)  
 SCTP checksum algorithm. This parameter specifies the configured SCTP checksum algorithm for a specific card.  
 The system-wide setting for the SCTP checksum algorithm type (see the **chg-sg-opts** command) takes precedence over the setting for an individual card. The **chg-sg-opts:sctpsum=percard** command must be entered before the **chg-ip-card:sctpsum=** command can be entered.  
**Range:** **adler32, crc32c**  
**System**  
**Default:** **crc32c**
  
- :srchodr=** (optional)  
 Host table search order.  
**Range:** **local, svr, svronly**  
**local**—Local host table is searched first.  
**svr**—Domain Server is searched first.  
**svronly**—Only the Domain Server is searched.  
**Default:** No change to the parameter value  
**System**  
**Default:** No search

**Example**

```
chg-ip-
card:loc=1211:dnsa=150.1.1.1:domain=nc.tekelec.com:defrouter=150.
1.1.105
```

```
chg-ip-card:loc=1107:sctpcsum=adler32
```

### Dependencies

At least one optional parameter must be specified.

The value specified for the **loc** parameter must correspond to the location of a card that can run an IP application (other than the **eroute** application, which is not supported by this command). For a list of the cards and their associated applications, see Table A-7.

The card in the location specified by the **loc** parameter must be inhibited before this command can be entered.

If the **domain** parameter is specified, the **rstdomain** parameter cannot be specified.

The **defrouter** IP address must be local to the Ethernet A network or Ethernet B network for the card. The B network can be used only on SSEDCM cards.

If the card in the location specified by the **loc** parameter is not an E5-SM4G card, or if a DSM card is provisioned in the system, then the **bpipaddr** and **bpsubmask** parameters cannot be specified.

The IP address specified by the **bpipaddr** and **bpsubmask** parameters must be unique.

The **bpipaddr** parameter must be specified before the **bpsubmask** parameter can be specified.

A valid value must be specified for the **bpsubmask** parameter.

If the **bpipaddr** parameter is specified, then the **bpsubmask** parameter must be specified.

The **chg-sg-opts:sctpcsum=perc** command must be entered before the **sctpcsum** parameter can be specified in the **chg-ip-card** command.

### Notes

The Domain Name has a 120 character limitation.

### Output

```
chg-ip-
card:loc=1211:dnsa=150.1.1.1:domain=nc.tekelec.com:defrouter=150.
1.1.105:sctpcsum=adler32
    rlgncxa03w 08-02-22 15:35:05 EST EAGLE 38.0.0
    CHG-IP-CARD: MASP A - COMPLTD
;
```

## chg-ip-lnk

## Change Internet Protocol Link

Use this command to provision the IP link table.

**Keyword:** **chg-ip-lnk**

**Related Commands:** **rtrv-ip-lnk**

**Command Class:** Database Administration

### Parameters

**:loc=** (mandatory)

Card location. The unique identifier of a specific application subsystem located in the system.

**Range:** 1101-1108, 1111-1112, 1201-1208, 1211-1218, 1301-1308, 1311-1318, 2101-2108, 2111-2118, 2201-2208, 2211-2218, 2301-2308, 2311-2318, 3101-3108, 3111-3118, 3201-3208, 3211-3218, 3301-3308, 3311-3318, 4101-4108, 4111-4118, 4201-4208, 4211-4218, 4301-4308, 4311-4318, 5101-5108, 5111-5118, 5201-5208, 5211-5218, 5301-5308, 5311-5318, 6101-6108, 6111-6118

**:port=** (mandatory)

Ethernet interface Port ID.

**Range:** a, b  
Port **b** is not valid for SS7IPGW and IPGWI applications with Application Sockets.

**:auto=** (optional)

Tells hardware whether to automatically determine duplex and speed.

**Range:** yes, no  
**yes** — Automatically determines duplex and speed  
**no** — Do not automatically determine duplex and speed

**Default:** No change to the parameter value

**System**

**Default:** no

**:duplex=** (optional)

This is the mode of operation of the interface.

**Range:** half, full  
**half** — Half duplex  
**full** — Full duplex

**Default:** No change to the parameter value

**System**

**Default:** full

**:ipaddr=** (optional)

The IP address for the specified port. This is a TCP/IP address expressed in standard dot notation. IP addresses consist of the system's network number and the machine's unique host number. An example IP address is 192.126.100.5, where 192.126.100 is the network number and 5 is the machine's host number.

**Range:** 4 numbers separated by dots, with each number in the range of **0-255**.  
A value of **0.0.0.0** will remove an IP address from this parameter.

**Default:** No change to the parameter value.

**System**

**Default:** 0.0.0.0

**:mactype=** (optional)

The Media Access Control Type of the interface.

**Range:** 802.3, dix  
**802.3** — The IEEE standard number 802.3 for Ethernet 1  
**dix** — The Digital/Inter/Xerox *de facto* standard for Ethernet 2

**Default:** No change to the parameter value

**System**

**Default:** dix

**:mcast=** (optional)

Multicast Control. This parameter enables or disables multicast support for the interface. This parameter is necessary for INP, G-Port, and G-Flex to establish the connection from the Service Module card to the MPS system.

**Range:** yes, no  
**yes** — Multicasting is enabled on the interface and the sending and receiving of multicast frames is allowed.  
**no** — All multicast frames are silently dropped.

**System**

**Default:** no

**:speed=** (optional)

The bandwidth for the interface in megabits per second

**Range:** 10, 100

**Default:** No change to the parameter value  
**System Default:** 100

**:submask=** (optional)

The subnet mask of the IP interface in the form of an IP address with a restricted range of values. This parameter is mandatory when the **ipaddr** parameter is specified.

**Range:** The value must be valid for the class of the entered IP address.

**Table 5-16. Valid Subnet Mask Values**

Valid for Class A Networks	Valid for Class A or B Networks	Valid for Class A, B, or C Networks
255.0.0.0	255.255.0.0	255.255.255.0
255.192.0.0	255.255.192.0	255.255.255.192
255.224.0.0	255.255.224.0	255.255.255.224
255.240.0.0	255.255.240.0	255.255.255.240
255.248.0.0	255.255.248.0	255.255.255.248
255.252.0.0	255.255.252.0	255.255.255.252
255.254.0.0	255.255.254.0	
255.255.128.0	255.255.255.128	

**Default:** If **ipaddr** is not specified, there is no change to the parameter value.

When a host's IP address is known, the default subnet mask should be chosen according to Table 5-17.

**Table 5-17. Default Subnet Mask Values**

Network Class	IP Network Address Range	Default Subnet Mask
A	1.0.0.0 to 127.0.0.0	255.0.0.0
B	128.0.0.0 to 191.255.0.0	255.255.0.0
C	192.0.0.0 to 223.255.255.0	255.255.255.0

**System Default:** 0.0.0.0

**Example**

**chg-ip-lnk:loc=1211:port=A**

**Dependencies**

The IP address must be entered in the IP Host table using the **ent-ip-host** command before it can be entered in the IP Link table using the **chg-ip-lnk** command.

Each IP address entered into the IP Link table must be unique.

At least one optional parameter must be specified.

If the **auto** parameter is entered, then the **duplex** and **speed** parameters are not allowed.

The value specified for the **loc** parameter must correspond to the location of a card that can run an IP application (other than the **eroute** application, which is not supported by this command). For a list of the cards and their associated applications, see Table A-7.

The card in the location specified by the **loc** parameter must be inhibited before this command can be entered.

For SS7IPGW and IPGWI, Application Sockets on port **b** are not allowed.

The local **ipaddr** and **submask** values of either the A or B network cannot be changed to an address that represents a different network if a default router and/or other gateway routers are assigned to the current local network (display with **rtrv-ip-card** and **rtrv-ip-rte**).

The local IP address cannot be changed if the current or new local host has open sockets or associations (the **open** parameter set to **yes** with the **ent-assoc** or **chg-assoc** command).

The IP address of an existing IP link entry in the IP Link table cannot be changed if it exists in the IP Host table.

An IP link entry must be provisioned in the IP Link table before an IP host entry can be provisioned with a corresponding IP address in the IP Host table.

The IP host entry must be deleted from the IP Host table before an IP link entry can be deleted from the IP Link table.

An existing IP link entry in the IP Link table cannot be deleted (**ipaddr=0.0.0.0**) if it exists in the IP Host table.

The IP network address specified by the **ipaddr** and **submask** parameters must be different from the IP and fast copy network address specified by the **pvn** and **pvnmask**, **fcna** and **fcnamask**, and **fcnb** and **fcnbmask** parameters in the NETOPTS table.

## Notes

None

## Output

```
chg-ip-lnk:loc=1211:port=a
```

```
rlghncxa03w 04-01-17 15:35:05 EST EAGLE 31.3.0
CHG-IP-LNK: MASP A - COMPLTD
```

```
;
```

## chg-is41-msg

### Change IS41 test message

Use this command to provision IS41 test messages. These messages are used by the MO SMS NPP Test Tool to test MO-based IS41 SMS message processing by the NPP.

**Keyword:** **chg-is41-msg**

**Related Commands:** **rtrv-is41-msg**, **tst-msg**

**Command Class:** Database Administration

## Parameters

**:msgn=** (mandatory)

Message number. This parameter specifies the test message number that will be changed.

**Range:** **1-10**



**:active=** (optional)

This parameter specifies whether the IS41 MOSMS message can be sent to the network card for processing.

**Range:**     **yes, no**

**yes** — The message is sent to the network card.

**no** — The message is not sent to the network card.

**Default:**   No change to the current value

**System**

**Default:**   **no**

**:cdpadgts=** (optional)

Called party address digits. This parameter specifies the SCCP CdPA digits for the IS41 test message.

**Range:**     1-15 digits

1 - 15 hexadecimal digits. Valid digits are **0-9, a-f, A-F**.

**Default:**   No change to the current value

**System**

**Default:**   **0123456789abcde**

**:cdpagti=** (optional)

Called party address global title indicator. This parameter specifies the SCCP CdPA GT for the IS41 test message.

**Range:**     **0-15**

**Default:**   No change to the current value

**System**

**Default:**   **4**

**:cdpagtnai=** (optional)

Called party address global title nature of address indicator. This parameter specifies the SCCP CdPA GT NAI for the IS41 test message.

**Range:**     **0-127**

**Default:**   No change to the current value

**System**

**Default:**   **4**

**:cdpndgts=** (optional)

Called party number digits. This parameter specifies the TCAP CdPN (*SMS\_DA* / *SMS\_ODA*) digits for the IS41 test message.

**Range:**     1-21 digits

**Default:**   No change to the current value

**System**

**Default:**   **01234567890abcde**

**:cdpnes=** (optional)

Called party number encoding scheme. This parameter specifies the TCAP CdPN (*SMS\_DA* / *SMS\_ODA*) encoding scheme for the IS41 test message

**Range:**     **0-15**

**Default:**   No change to the current value

**System**

**Default:**   **1**

**:cdpnnai=** (optional)

Called party number nature of address indicator. This parameter specifies the TCAP CdPN (*SMS\_DA* / *SMS\_ODA*) NAI for the IS41 test message.

**Range:**     **0-1**

**Default:**   No change to the current value

**System****Default:** 1**:cdpnp=** (optional)

Called party numbering plan. This parameter specifies the TCAP CdPN (*SMS\_DA* / *SMS\_ODA*) NP for the IS41 test message.

**Range:** 0-15**Default:** No change to the current value**System****Default:** 2**:cgpadgts=** (optional)

Calling party address digits. This parameter specifies the SCCP CgPA digits for the IS41 MOSMS message.

**Range:** 1-15 digitsRange is 1 - 15 hexadecimal digits. Valid digits are **0-9, a-f, A-F**.**Default:** No change to the current value**System****Default:** 0123456789abcde**:cgpagti=** (optional)

Calling party address global title indicator. This parameter specifies the SCCP CgPA GT for the IS41 test message.

**Range:** 0-15**Default:** No change to the current value**System****Default:** 4**:cgpagnai=** (optional)

Calling party address global title nature of address indicator. This parameter specifies the SCCP CgPA GT NAI for the IS41 test message.

**Range:** 0-127**Default:** No change to the current value**System****Default:** 4**:cgpndgts=** (optional)

Calling party number digits. This parameter specifies the TCAP CgPN (*SMS\_OOA*) digits for the IS41 test message.

**Range:** 1-21 digits**Default:** No change to the current value**System****Default:** 01234567890abcde**:cgpnes=** (optional)

Calling party number encoding scheme. This parameter specifies the TCAP CgPN (*SMS\_OOA*) encoding scheme for the IS41 test message

**Range:** 0-15**Default:** No change to the current value**System****Default:** 1**:cgpnnai=** (optional)

Calling party number nature of address indicator. This parameter specifies the TCAP CgPN (*SMS\_OOA*) NAI for the IS41 test message.

**Range:** 0-1  
**Default:** No change to the current value  
**System**  
**Default:** 1

**:cgpnnp=** (optional)

Calling party numbering plan. This parameter specifies the TCAP CgPN (*SMS\_OOA*) NP for the IS41 test message.

**Range:** 0-15  
**Default:** No change in the current value  
**System**  
**Default:** 2

**:reset=** (optional)

This parameter resets all of the parameters to their default values.

**Range:** **yes, no**  
**yes** — All of the message parameters are reset to their default values.  
**no** — None of the message parameters are reset.  
**Default:** No change to the current value

### Example

```
chg-is41-msg:msgn=1:cdpnnai=1:cdpadgts=12457896abcd:cgpnnai=1
chg-is41-msg:msgn=1:cdpnnai=1:cdpndgts=981123456
```

### Dependencies

If the **reset** parameter is specified, then no other parameters can be specified.

At least one optional parameter must be specified.

### Output

```
chg-is41-msg:msgn=1:cdpnnai=1:cdpndgts=987654321:cgpnnai=1
tekelecstp 09-03-02 10:46:51 EST EAGLE 40.1.0
CHG-IS41-MSG: MASP A - COMPLTD
```

;

## chg-is41opts

## Change IS41 Options

Use this command to change the values of one or more of the IS41 option indicators maintained in the IS41 Options (IS41OPTS) table.

**Keyword:** **chg-is41opts**

**Related Commands:** **chg-is41smsopts, rtrv-is41opts, rtrv-is41smsopts**

**Command Class:** Database Administration

### Parameters

**NOTE:** The following parameters are no longer available in this command: **mosmsdnfmt, mosmsdnai, mosmsnai, mosmstype, mtmsdnfmt, mtmsmstype, mtmsparm, mtmsdltr, mtmsdltrv, mtmsackn, mtmsesn, mtmsssn, mtmsnakerr, mtmsdigtype, and mtmschksrc.** Use the **chg-is41smsopts** command to specify these parameters.

**:esnmfg=** (optional)

ESN manufacturer code. This parameter specifies the value that will be encoded in the manufacturer code section of the **esn** parameter for a LOCREQ response message.

**Range:** 0-255  
**Default:** 0

**:esnsn=** (optional)

ESN serial number. This parameter specifies the value that will be encoded in the serial number section of the **esn** parameter for a LOCREQ response message.

**Range:** 0-16777215

**Default:** 0

**:iec=** (optional)

International escape code. This parameter specifies the international escape code that a received LOCREQ message can contain and have lookup performed.

**Range:** 1-5 digits, **none**

**none**—Removes the IEC from a received LOCREQ message before lookup.

**Default:** **none**

**:locreqdn=** (optional)

This parameter specifies whether to obtain the Called Party, used for database lookup, from the SCCP or TCAP layer of a received LOCREQ message.

**Range:** **tcap, sccp**

**tcap**— Obtains the Called Party from the TCAP layer.

**sccp**— Obtains the Called Party from the SCCP layer.

**Default:** **sccp**

**:locreqrmhrn=** (optional)

LOCREQ remove HomeRN. This parameter specifies whether to remove the HomeRN from the TCAP Outgoing Called Party for a relayed LOCREQ message.

**Range:** **yes, no**

**yes**— Remove HomeRN.

**no**— Do not remove HomeRN.

**Default:** **no**

**:mscmktid=** (optional)

MSCID market ID. This parameter specifies the value that will be encoded in the Market ID section of the **mscid** parameter for a response LOCREQ message.

**Range:** 0-65535

**Default:** 0

**:mscswitch=** (optional)

MSCID market ID switch. This parameter specifies the value that will be encoded in the Market ID Switch section of the **mscid** parameter for a response LOCREQ message.

**Range:** 0-255

**Default:** 0

**:mtplocreqlen=** (optional)

This parameter specifies the number of terminating called party digits to extract from the LOCREQ message.

**Range:** 5-15

**Default:** 15

**System**

**Default:** 0

**:mtplocreqnai=** (optional)

MTP-routed LOCREQ nature of address indicator. This parameter specifies how the Called Party from the TCAP layer of a received MTP-routed LOCREQ message will be interpreted.

**Range:** **ccrndn, frmsg, intl, natl, rnidn, rnrndn, rnsdn, sub, locreqlen**

**ccrndn**— Country code, routing number, and national directory number

**frmsg**— Incoming message value.

**intl** — International number  
**natl** — National number  
**rnidn** — Routing number prefix and international dialed/directory number  
**rnndn** — Routing number prefix and national dialed/directory number  
**rnsdn** — Routing number prefix and subscriber dialed/directory number  
**sub** — Subscriber number  
**locreqlen** — Number of terminating called party digits specified by the **locreqlen** parameter  
**Default:** **frmsg**

**:nec=** (optional)

National escape code. This parameter specifies the national escape code that a received LOCREQ message can contain and have lookup performed.

**Range:** 1-5 digits, **none**  
**none**—Removes the NEC from the received LOCREQ message before database lookup.

**Default:** **none**

**:rspcdpapcp=** (optional)

Response called party point code present. This parameter specifies the point code present bit that will encode the SCCP CdPA GTA of a LOCREQ response message.

**Range:** **off, on, frmsg**  
**off** — The response will not contain a point code present bit.  
**on** — The point code in the SCCP CgPA of the received LOCREQ message will be used. If no point code is present, the originating point code in the MTP Routing Label will be used.  
**frmsg** — The point code present bit from the received message will be used. Override does not occur.

**Default:** **off**

**:rspcdpari=** (optional)

Response called party routing indicator. This parameter specifies the value of the routing indicator bit that will encode the SCCP CdPA GTA of a LOCREQ response message.

**Range:** **frmsg, gt, ssn**  
**frmsg** — The received message routing indicator bit will be used. Override does not occur.  
**gt** — The GTA digits in the SCCP CgPA GTA of the received message will be used. If no GTA digits are present in the SCCP CgPA GTA, override will occur according to the **cdpari=ssn** parameter.  
**ssn** — The SCCP CgPA of the received message will be used.

**Default:** **frmsg**

**:rspcgpanai=** (optional)

Response calling party nature of address indicator. This parameter specifies the nature of address (NAI) that will encode the SCCP CgPA GTA of a LOCREQ response message.

**Range:** **0-127, none**  
**none**—The NAI value in the SCCP CdPA of the received message will be used. Override does not occur.

**Default:** **none**

**:rspcgpanp=** (optional)

Response calling party numbering plan. This parameter specifies the numbering plan (NP) that will encode the SCCP CgPA GTA of a LOCREQ response message.

**Range:**     **0-15 none**  
**none**—The NP in SCCP CdPA of the received message will be used. Override does not occur.

**Default:**   **none**

**:rspcpapcp=** (optional)

Response calling party point code present. This parameter specifies the point code present bit that will encode the SCCP CgPA GTA of a LOCREQ response message.

**Range:**     **frmsg, on, off**  
**frmsg**— The point code present bit from the received message will be used.  
**on**— The point code in the SCCP CdPA of the incoming LOCREQ message will be used. If no point code is present, the destination point code in the MTP Routing Label will be used.  
**off**— The response message will not contain a point code present bit.

**Default:**   **frmsg**

**:rspcpari=** (optional)

Response calling party routing indicator. This parameter specifies the routing indicator bit that will encode the SCCP CgPA GTA of a LOCREQ response message.

**Range:**     **frmsg, gt, ssn**  
**frmsg**— The value from the received message will be used. Override does not occur.  
**gt**— The GTA digits in the SCCP CdPA GTA of the received message will be used. If no GTA digits are present, override occurs according to the **cgpari=ssn** parameter.  
**ssn**— The SCCP CdPA of the received message will be used.

**Default:**   **frmsg**

**:rspcpatt=** (optional)

Response calling party translation type. This parameter specifies the translation type (TT) that will encode the SCCP CgPA GTA of a LOCREQ response message.

**Range:**     **0-255 none**  
**none**—The TT in the SCCP CdPA of the received message will be used. Override does not occur.

**Default:**   **none**

**:rspdig=** (optional)

Routing number. This parameter specifies the digit encoding format of the TCAP Outgoing Called Party parameter for a LOCREQ response message.

The routing number will be used as is or concatenated with the Called Party Number. The routing number format will be used on a per EAGLE 5 ISS node basis.

**Range:**     **ccrndn, hrnrndn, rn, rndn**  
**ccrndn**— Country Code + RN + DN  
**hrnrndn**— HomeRN + RN + DN  
**rndn**— RN + DN

**Default:**   **rn**

**:rspdigtype=** (optional)

Response digit type. This parameter specifies the value that will encode the Digit Type field in the TCAP Outgoing Called Party parameter of a LOCREQ response message.

**Range:**     **0-255**

**Default:**   **6**

**:rspmin=** (optional)

Response LOCREQ MIN parameter encoding. This parameter specifies how the **min** parameter of a LOCREQ response message will be encoded.

**Range:**     **homern, nothomern, tendelhomern, tenhomern, tenzero**

**homern**— The exact number of digits, with home RN prefix, as encoded in the Called Party of the received LOCREQ message.

**nothomern**— The exact number of digits, without home RN prefix, as encoded in the Called Party of the received LOCREQ message.

**tendelhomern**— The leading 10 digits of the Called Party of the received LOCREQ message after deleting the home RN prefix, if it exists.

**tenhomern**— The leading 10 digits the Called Party of the received LOCREQ message without deletion of the home RN prefix.

**tenzero**— 10 digits filled with 0.

**Default:** **homern**

**:rspnon=** (optional)

MSRN nature of number. This parameter specifies the nature of number value that will encode the TCAP Outgoing Called Party parameter of a LOCREQ response message.

**Range:** **0-255 none**

**none**—The NAI value in the Digits[Dialed] parameter of a received LOCREQ message is used.

**Default:** **none**

**:rspnp=** (optional)

MSRN numbering plan. This parameter specifies the numbering plan that will encode the TCAP Outgoing Called Party parameter of the LOCREQ response message.

**Range:** **0-15 none**

**2**—Telephony Numbering

**Default:** **2**

**:rspparm=** (optional)

Response parameter. This parameter specifies the TCAP parameter that will encode the RN and/or DN information for a LOCREQ response message.

This value encodes the DigitType field of the TerminationList, RoutingDigits, or Digits[Destination] on a per EAGLE 5 ISS node basis.

**Range:** **ddigit, rtdigit, tlist**

**ddigit**— Digits[Destination].

**rtdigit**— Routingdigits

**tlist**— Termination list (Default)

**Default:** **tlist**

**:smsreqbypass=** (optional)

This parameter specifies whether a received SMSREQ message that passes the MNP Service Selector (**serv=mnp** parameter in the **chg-sccp-serv** command) will undergo A-Port message processing.

**Range:** **yes, no**

**yes**— Bypass A-Port.

**no**— Do not bypass A-Port.

**Default:** **no**

**:tcapsnai=** (optional)

This parameter specifies how the Called Party from the TCAP layer of a received LOCREQ message will be interpreted.

**Range:** **ccrndn, frmsg, intl, natl, rnidn, rnrndn, rnsdn, sub**

**ccrndn**— Country code, routing number, and national directory number

**frmsg**— Incoming message value

**intl**— International number

**natl**— National number

**rnidn**— Routing number prefix and international dialed/directory number

**rnrndn**— Routing number prefix and national dialed/directory number

**rnsdn** — Routing number prefix and subscriber dialed/directory number

**sub** — Subscriber number

**Default:** frmsg

### Example

```
chg-is41opts:iec=12345:nec=12345:rspcgpari=gt:rspcdpari=gt
chg-is41opts:rspnon=1:tcapsnai=sub:mscmktid=78
chg-
is41opts:locreqdn=tcap:rspcgpapcp=frmsg:rspnp=14:rspmin=tendelhom
ern
chg-is41opts:smsreqbypass=yes:rspcdpapcp=off
chg-is41opts:rspcgpanai=120:rspcgpanp=5:rspcgpatt=25
chg-is41opts:mtplocreqnai=intl:rspparm=tlist:rspdig=rn
chg-is41opts:rspnon=25:mscmktid=535:mscswitch=55
chg-is41opts:esnmfg=159:esnsn=7215:rspdigtype=67:locreqrmhrn=yes
```

### Dependencies

The A-Port or IS41 GSM Migration (IGM) feature must be enabled before this command can be entered.

### Output

```
chg-is41opts:smsreqbypass=yes
tekelecstp 06-09-11 15:13:20 EST EAGLE 36.0.0
Command entered at terminal #4.
CHG-IS41OPTS: MASP A - COMPLTD
```

;

## chg-is41smsopts

## Change IS41 SMS System Options

Use this command to enter IS41 SMS system options in the database. This command updates the IS41SMSOPTS table.

**Keyword:** chg-is41smsopts

**Related Commands:** chg-is41opts, rtrv-is41opts, rtrv-is41smsopts

**Command Class:** Database Administration

### Parameters

**NOTE:** As of Release 40.1, the mosmsdnai and mosmsdnfmt parameters are obsolete.

**:bpartygttsn=** (optional)

MO SMS B-Party Routing GTT Set name. This parameter specifies the GTT set where Global Title Translation lookup on B-Party digits is performed.

**Range:** ayyyyyyyy

1 leading alphabetic and up to 8 following alphanumeric characters.

**Default:** No change to the current value

**System**

**Default:** none

**:defrn=** (optional)

Default routing number. This parameter specifies a default routing number that is used for own-network subscribers.



**Range:** 1-15 digits, **none**  
Valid digits are **0-9, A-F, a-f**.

**Default:** No change to the current value

**System**

**Default:** **none**

**:modaparam=** (optional)

This parameter specifies whether the SMS\_DestinationAddress or SMS\_OriginalDestinationAddress parameter from the IS41 SMDPP message is used for conditioning, lookup, and modification for the MO-based IS41 SMS NP and MO SMS IS41-to-GSM Migration features.

**Range:** **da, oda**  
**da** — Destination Address  
**oda** — Original Destination Address

**Default:** No change to the current value

**System**

**Default:** **da**

**:moigmpfx=** (optional)

MO SMS IS41-to-GSM migration prefix. This parameter specifies whether the MO SMS IS41-to-GSM Migration feature uses digits from the RTDB network entity (NE) associated with the B number or the **is412gsm** parameter (see the **chg-gsmopts** command) as a prefix to modify the destination address in the outgoing SMDPP.

**Range:** **ne, is412gsm**  
**ne** — The RTDB NE data associated with the B number is used for prefixing.  
**is412gsm** — The provisioned IS412GSM migration prefix is used for prefixing.

**Default:** No change to the current value

**System**

**Default:** **ne**

**:mosmsaclen=** (optional)

This parameter specifies the number of the digits that are taken from the MO SMS CgPA and used as the Area Code in the MO SMS CdPA.

**Range:** **0-8**

**Default:** No change to the current value

**System**

**Default:** **0**

**:mosmsdigmat=** (optional)

This parameter specifies that the “HomeSMSC Match with Digits” search option can be used with the MO-based IS41 SMS NP and MO SMS IS41-to-GSM Migration features.

**Range:** **exact, bestfit, bypass**  
**exact** — The system searches for an exact match of digits in the HomeSMSC Table.  
**bestfit** — The system searches for a match on the leading digits of an incoming message with any provisioned entry in HomeSMSC table if an exact match is not found.  
**bypass** — The HomeSMSC search is not performed.

**Default:** No change to the current value

**System**

**Default:** **exact**

**:mosmsgttdig=** (optional)

MO SMS B-Party Routing GTT digit. This parameter specifies the digits that are used for Global Title Translation.

**Range:** **sccpcdpa, mapbparty**  
**sccpcdpa** — The SCCP CdPA is used for GTT.  
**mapbparty** — The MAP B-Party number is used for GTT.

**Default:** No change to the current value

**System**

**Default:** **sccpcdpa**

**:mosmsnai=** (optional)

MO-based SMS Nature Address Indicator. This parameter specifies the number conditioning that is performed on the SMS\_DestinationAddress digits in the SMDPP message before lookup in the number portability database is performed.

**Range:** **intl, nai, nat, unknown**  
**intl** — Number is treated as INTL (1) for number conditioning.  
**nai** — The NAI from the SMS\_DestinationAddress parameter in the SMDPP message is used to perform number conditioning  
**nat** — Number is treated as NATL (0) for number conditioning.  
**unknown** — Number is treated as UNKNOWN (2) for number conditioning.  
A value of **nai** must be specified before the **intl, natl, nai1, nai2, nai3,** and **unkn** parameters in the **chg-npp-serv** command can be changed to non-default values for the MOSMSICDPN service.

**Default:** No change to the current value

**System**

**Default:** **intl**

**:mosmstype=** (optional)

MO-based SMS type. This parameter specifies the value of the entity type that indicates that a successful lookup occurred in the number portability database.

**Range:** **sp, rn, sprn, all**  
**sp** — signalling point  
**rn** — routing number  
**sprn** — Lookup is successful if the value of the entity type is **sp** or **rn**.  
**all** — Lookup is successful if the value of the entity type is **sp** or **rn**, or if no entity type is found.

**Default:** No change to the current value

**System**

**Default:** **sprn**

**:mtsmsackn=** (optional)

MT-Based SMS acknowledgement. This parameter specifies the message that is generated in response to a successful number portability database lookup for an SMSREQ message from a Home SMSC.

**Range:** **ack, nack**  
**ack** — SMSREQ\_ACK message  
**nack** — SMSREQ\_NACK (Return Error) message

**Default:** **No change to current value.**

**System**

**Default:** **ack**

**:mtsmschksrc=** (optional)

MT-Based SMS check source. This parameter specifies whether the SCCP CgPA GTA of a SMSREQ message is validated to determine whether the source of the message is a Home SMSC.

**Range:** **yes, no**  
**yes** — The SCCP CgPA GTA of an SMSREQ message is validated.

**no** — The SCCP CgPA GTA of an SMSREQ message is not validated.

If the **mtsmschksrc=yes** parameter is specified, and if the incoming SMSREQ message has SCCP CgPA GTA, then the SCCP CgPA GTA must be found in the Home SMSC list for the source of the message to be considered a Home SMSC. If the message is not found in the Home SMSC list, then the MT-Based IS41 SMS NP feature does not process the message.

If the **mtsmschksrc=no** parameter is specified, or if SCCP CgPA GTA does not exist in the incoming message, then the source of the message is considered to be a Home SMSC, and the MT-Based IS41 SMS NP feature considers the message for processing.

**Default:** No change to current value

**System**

**Default:** **no**

**:mtsmsdigtype=** (optional)

MT-Based SMS digit type. This parameter specifies the value that is used to encode the "Type of digits" field in the SMS\_Address parameter of an SMSREQ ACK message.

**Range:** **0-255**

**Default:** No change to the current value

**System**

**Default:** **6**

**:mtsmsdltr=** (optional)

MT-Based SMS delimiter. This parameter specifies whether to insert a delimiter string before or after the routing number (RN) when the RN is used in the **mtsmsdnfmt** digits.

The delimiter string that is inserted is determined by the **mtsmsdltrv** parameter.

**Range:** **no, prern, postrn**

**no** — A delimiter string is not inserted.

**prern** — A delimiter digit string is inserted before the RN.

**postrn** — A delimiter digit string is inserted after the RN.

**Default:** No change to the current value

**System**

**Default:** **no**

**:mtsmsdltrv=** (optional)

MT-Based SMS delimiter value. This parameter specifies the delimiter digit string that is inserted before or after the RN when the RN is used in the **mtsmsdnfmt** digits.

This parameter must be specified if the value specified for the **mtsmsdltr** parameter is **prern** or **postrn**.

**Range:** 1-5 digits, **none**

Valid digits are **0-9, A-F, a-f**.

**Default:** No change to the current value

**System**

**Default:** **none**

**:mtsmsdnfmt=** (optional)

MT-Based SMS DN format. This parameter specifies the required format of digits to be encoded in the "SMS\_Address" parameter of the SMSREQ response.

**Range:** **rn, rndn, ccrndn, dn, srfimsi**

**rn** — routing number

**rndn** — routing number and the international dialed/directory number

**ccrndn** — country code, routing number, and national directory/dialed number

**dn** — directory or dialed number

**srfimsi** — IMSI is encoded as the "SRFIMSI" parameter from the number portability database.

- Default:** No change to the current value  
**System**  
**Default:** **rndn**
- :mtsmesen=** (optional)  
 MT-Based SMS electronic serial number. This parameter specifies whether to encode the ESN parameter while generating the SMSREQ response message.  
**Range:** **no, yes**  
**no** — The ESN parameter is not encoded.  
**yes** — The ESN parameter is encoded.  
**Default:** No change to the current value  
**System**  
**Default:** **no**
- :mtsmnakerr=** (optional)  
 MT-Based SMS negative acknowledgement error. This parameter specifies the TCAP access denied reason to be included in the NACK response message that is generated for SMSREQ messages.  
**Range:** **0-255**  
**Default:** No change to the current value.  
**System**  
**Default:** **5**
- :mtmsparm=** (optional)  
 MT-Based SMS parameter. This parameter specifies the format that is used to encode the "SMS\_Address" parameter of an SMSREQ response message.  
**Range:** **digit, pcssn**  
**digit** — DIGIT format  
**pcssn** — PCSSN format  
**Default:** No change to the current value  
**System**  
**Default:** **digit**
- :mtsmssn=** (optional)  
 MT-Based SMS subsystem number. This parameter specifies the SSN that is encoded in "SMS\_Address" field, if the **mtmsparm=pcssn** parameter is specified, and the SSN entry is not found in the entity.  
**Range:** **2-255**  
**Default:** No change to the current value  
**System**  
**Default:** **6**
- :mtsmstype=** (optional)  
 MT-Based SMS type. This parameter specifies the entity type that indicates a successful lookup occurred in the number portability database.  
**Range:** **sp, rn, sprn, all, nonsp**  
**sp** — signalling point  
**rn** — routing number  
**sprn** — **sp** or **rn**  
**all** — **sp, rn**, or DN with no entity  
**nonsp** — **rn** or DN with no entity  
**Default:** No change to the current value  
**System**  
**Default:** **rn**

**:spfill=** (optional)

This parameter specifies whether the Numbering Plan Processor (NPP) can populate SP and RN entities for own network subscribers at the same time.

**Range:**     **off, on**  
               **off**— Do not populate both RN and SP entities at the same time  
               **on**— Allow population of the RN and SP entities at the same time

**Default:**   No change to the current value

**System**

**Default:**   **off**

**:sporttype=** (optional)

Service Portability type. This parameter specifies whether Service Portability is performed for the associated feature.

**Range:**     **gsm, is41, all, none**  
               **gsm**— Apply Service Portability prefix (RTDB 'GRN' entity id ) for own-network GSM subscribers  
               **is41**— Apply Service Portability prefix (RTDB 'GRN' entity id) for own-network IS41 subscribers  
               **all**— Apply Service Portability prefix ('GRN' from RTDB entity) for all own-network (IS41 and GSM) subscribers  
               **none**— Service Portability is not performed for the feature.

**Default:**   No change to the current value

**System**

**Default:**   **none**

**:mosmsdnfmt=** (obsolete)

MO-based SMS directory number format. This parameter specifies the format for the digits in the outgoing message.

**Range:**     **rn, rndn, ccrndn**  
               **rn**— routing number (RN is used if available, otherwise DN is used)  
               **rndn**— routing number+directory number  
               **ccrndn**— country code + routing number + directory number

**Default:**   **rndn**

**:mosmsdnnai=** (obsolete)

MO-based SMS directory number NAI. This parameter specifies the NAI that is used in the outgoing message.

**NOTE: This parameter is Obsolete.**

The **mosmsdnnai** parameter modifies only the three least significant bits of the NAI field of the message. Each value of this parameter represents a specific configuration of the three bits.

**Range:**     **0-15 none**  
               **0**—national number, presentation allowed, number available  
               **1**—international number, presentation allowed, number available  
               **2**—national number, presentation restricted, number available  
               **3**—international number, presentation restricted, number available  
               **4**—national number, presentation allowed, number not available  
               **5**—international number, presentation allowed, number not available  
               **6**—national number, presentation restricted, number not available  
               **7**—international number, presentation restricted, number not available  
               **8**—national number, presentation allowed, number available  
               **9**—international number, presentation allowed, number available  
               **10**—national number, presentation restricted, number available

- 11**—international number, presentation restricted, number available
- 12**—national number, presentation allowed, number not available
- 13**—international number, presentation allowed, number not available
- 14**—national number, presentation restricted, number not available
- 15**—international number, presentation restricted, number not available
- none**—The NAI from the incoming message is used.

**Default:** none

### Example

The following example sets the IS41 SMS options when MO SMS ASD or MO SMS GRN feature is enabled:

```
chg-is41smsopts:modaparam=da:mosmsnai=intl:mosmsaclen=3
```

The following example sets the IS41 SMS options when the MT-based IS41 SMS NP feature is enabled:

```
chg-is41smsopts:mtsmsdltr=no:mtsmsparm=digit
```

The following example sets the IS41 SMS options when the MT-based IS41 SMS NP feature is enabled:

```
chg-is41smsopts:mtsmsdltrv=9854:mtsmsackn=nack:mtsmsesn=no
```

The following example sets the IS41 SMS options when the MT-based IS41 SMS NP feature is enabled:

```
chg-is41smsopts:mtsmsssn=2:mtsmsnakerr=55:mtsmsdigtype=25
```

The following example sets the IS41 SMS options when the MT-based IS41 SMS NP feature is enabled:

```
chg-is41smsopts:mtsmschksrc=no
```

The following example sets the IS41 SMS options when the MO SMS B-Party Routing feature is enabled:

```
chg-is41smsopts:bpartygttsn=setint001:mosmsgttdig=mapbparty
```

The following example sets the IS41 SMS options when the MT-based IS41 SMS NP feature is enabled:

```
chg-is41smsopts:mtsmsdnfmt=dn:mtsmsstype=sp
```

The following example sets the IS41 SMS options when the MO-based IS41 SMS NP feature is enabled:

```
chg-is41smsopts:mosmstype=sp:mosmsnai=intl:mosmsdigmat=exact:modaparam=da:mosmsaclen=3
```

The following example sets the IS41 SMS options when the MO SMS IS41-to-GSM Migration feature is enabled.

```
chg-is41smsopts:mosmsdigmat=exact:moigmpfx=is412gsm:modaparam=da:mosmsnai=intl:mosmsaclen=3
```

The following example sets the Area Code Length, when MO-based IS41 SMS NP, MO SMS IS41-to-GSM Migr , MO SMS ASD or MO SMS GRN feature is enabled:

```
chg-is41smsopts:mosmsaclen=5
```

### Dependencies

At least one parameter must be specified.

The **mtsmsdltrv** parameter must be specified before a value of **prern** or **postrn** can be specified for the **mtsmsdltr** parameter.

The value specified for the **bpartygttsn** parameter must match the name of an existing GTT Set.

The **mosmsgttdig=scpcdpa** parameter must be specified before the **bpartygttsn=none** parameter can be specified.

The GTT set specified for the **bpartygttsn** parameter must have **settype=cdgta** (see the **ent-gttset** command).

If the **bpartygttsn=none** parameter is specified, then the **mosmsgttdig=mapbparty** parameter cannot be specified.

The MT-Based IS41 SMS NP feature must be enabled before the **mtsmsdnfmt**, **mtsmstype**, **mtsmsparm**, **mtsmsdltr**, **mtsmsdltrv**, **mtsmsackn**, **mtsmsesn**, **mtsmsssn**, **mtsmsnakerr**, **mtsmsdigtype** or **mtsmschksrc** parameters can be specified.

The MO SMS IS41-to-GSM Migration feature must be enabled before the **moigmpfx** parameter can be specified.

The MO SMS B-Party Routing feature must be enabled before the **bpartygttsn** or **mosmsgttdig** parameter can be specified.

The MO-based IS41 SMS NP or MO SMS IS41-to-GSM Migration feature must be enabled before the **mosmsdigmat** parameter can be specified.

The MO-based IS41 SMS NP feature must be enabled before the **mosmstype**, **defrn**, and **spfill** parameters can be specified.

The MO-based IS41 SMS NP, MO SMS IS41-to-GSM Migration, MO SMS ASD, or MO SMS GRN feature must be enabled before the **modaparam**, **mosmsnai**, or **mosmsaclen** parameter can be specified. The **modaparam** parameter can also be specified if the MO SMS B-Party Routing feature is enabled.

The S-Port feature must be enabled before the **sporttype** parameter can be specified.

## Output

```
chg-is41smsopts:mtsmsackn=ack
tekelecstp 08-05-11 13:11:27 EST EAGLE 39.0.0
CHG-IS41SMSOPTS: MASP A - COMPLTD
;
```

## chg-isup-msg

## Change ISUP Message

Use this command to enter or change specific parameters of an ISUP test message in the TESTMSG table. The TIF Test Tool processes ISUP test messages to verify the TIF and NPP provisioned configuration in the system.

**Keyword:** chg-isup-msg

**Related Commands:** rtrv-isup-msg, tst-msg

**Command Class:** Database Administration

## Parameters

**:msgn=** (mandatory)

Test message number. This parameter specifies the ISUP test message number for which parameters are being changed in the TESTMSG table.

**Range:** 1-10

**:active=** (optional)

Active. This parameter sets the *Active* field of the specified ISUP test message.

**Range:** **no, yes**  
**no** — Do not send the message to the network card for processing.  
**yes** — Send the message to the network card for processing.

**Default:** **no**

**:cdpndgts=** (optional)

Called Party Number digits. This parameter specifies the value for the CdPN digits in the specified ISUP test message.

**Range:** 1-32 digits  
 1 - 32 hexadecimal digits. Valid digits are **0-9, a-f, A-F**.

**Default:** No change to the current value

**:cdpnnai=** (optional)

Called Party Number Nature of Address Indicator. This parameter specifies the value for the CdPN NAI in the specified ISUP test message.

**Range:** **0-127**

**Default:** No change to the current value

**:cgpncat=** (optional)

Calling Party Number Category. This parameter specifies the value of the CgPN Category in the specified ISUP test message.

**Range:** **0-255**

**Default:** **0**

**:cgpndgts=** (optional)

Calling Party Number digits. This parameter specifies the value for the CgPN digits in the specified ISUP test message.

**Range:** 1-32 digits  
 1 - 32 hexadecimal digits. Valid digits are **0-9, a-f, A-F**.

**Default:** No change to the current value

**:cgpnnai=** (optional)

Calling Party Number Nature of Address Indicator. This parameter specifies the value of the CgPN NAI in the specified ISUP test message.

**Range:** **0-127**

**Default:** No change to the current value

**:nmbits=** (optional)

NM Bits. This parameter specifies the value of the NM bits in the specified ISUP test message. The NM bits are used to determine whether a number portability lookup has already been performed in the network.

**Range:** **0-3**  
**0-1**—Portability has not been performed.  
**2**—The number is not ported.  
**3**—The number is ported.

**Default:** **0**

### Example

```
chg-isup-  
msg:msgn=1:active=yes:nmbits=1:cgpndgts=987654321:cdpndgts=923487  
:cdpnnai=125  
chg-isup-msg:msgn=6:cgpncat=200:cdpnnai=23
```



**Dependencies**

At least one of the optional parameters must be specified.

At least one TIF feature must be enabled before this command can be entered.

**Output**

```
chg-isup-msg:msgn=10:active=yes:nmbits=1
tekelecstp 08-07-24 10:37:20 EST EAGLE 39.2.0
CHG-ISUP-MSG: MASP A - COMPLTD
;
```

**chg-l2t****Change Level 2 Timers**

Use this command to change the values of the SS7 MTP level 2 timers. The timers are organized in 35 timer sets of 9 timer values each. The timer sets are grouped and system default values are initialized by specification (ANSI, ITU, High Speed for China, High Speed for Q.703 Annex A, and High Speed for Unchannelized T1).

**NOTE: Each timer set is administered individually by this command. The ent-slk command is used to assign an SS7 signaling link to any of the timer sets. Each assigned link is associated with a timer set.**

**Keyword:** chg-l2t

**Related Commands:** ent-slk, rtrv-l2t, rtrv-slk

**Command Class:** Database Administration

**Parameters**

**:l2tset=** (mandatory)

Level 2 timer set. This parameter specifies the Level 2 timer set identifier or timer set number. Up to 35 different timer sets can be defined. A signaling link can be assigned to any of the timer sets.

**Range:** 1-35

1-10 for ANSI links

11-20 for low-speed ITU links

21-25 for China high speed links

26-30 for Q.703 Annex A high speed links

31-35 for Unchannelized T1 high speed links

**:nodata=** (optional)

This parameter specifies a value for the NODATA timer.

The NODATA timer measures the amount of time, in milliseconds, that must pass with no transmissions on a link before the EAGLE 5 ISS interprets the condition as a link failure or terminal equipment failure and initiates changeover procedures.

**Range:** 100-500

**Default:** No change to the current value

**System**

**Default:** 100

**:t1=** (optional)

Timer 1—Aligned/ready

**Range:** 5000-350000

For ANSI timer sets 1-10—5000-20000 milliseconds

For ITU timer sets 11-20—40000-50000 milliseconds

For China timer sets 21-25—25000-350000 milliseconds

For Q.703 Annex A timer sets 26-30—25000-350000 milliseconds

For Unchannelized T1 timer sets 31-35—16000-151000 milliseconds

**Default:** No change to the current value

**System**

**Default:** For ANSI timer sets 1–10—**13000** milliseconds  
 For ITU timer sets 11–20—**40000** milliseconds  
 For China timer sets 21–25—**150000** milliseconds  
 For Q.703 Annex A timer sets 26–30—**300000** milliseconds  
 For Unchannelized T1 timer sets 31–35—**151000** milliseconds

**:t2=** (optional)

Timer 2—Not aligned

**Range:** **5000-150000**  
 For ANSI timer sets 1–10—**5000-30000** milliseconds  
 For ITU timer sets 11–20—**5000-150000** milliseconds  
 For China timer sets 21–25—**5000-150000** milliseconds  
 For Q.703 Annex A timer sets 26–30—**5000-150000** milliseconds  
 For Unchannelized T1 timer sets 31–35—**5000-14000** milliseconds

**Default:** No change to the current value

**System**

**Default:** For ANSI timer sets 1–10—**11500** milliseconds  
 For ITU timer sets 11–20—**30000** milliseconds  
 For China timer sets 21–25—**130000** milliseconds  
 For Q.703 Annex A timer sets 26–30—**130000** milliseconds  
 For Unchannelized T1 timer sets 31–35—**14000** milliseconds

**:t3=** (optional)

Timer 3—Aligned

**Range:** **1000-20000**  
 For ANSI timer sets 1–10—**5000-20000** milliseconds  
 For ITU timer sets 11–20—**1000-2000** milliseconds  
 For China timer sets 21–25—**1000-2000** milliseconds  
 For Q.703 Annex A timer sets 26–30—**1000-2000** milliseconds  
 For Unchannelized T1 timer sets 31–35—**5000-14000** milliseconds

**Default:** No change to the current value

**System**

**Default:** For ANSI timer sets 1–10—**11500** milliseconds  
 For ITU timer sets 11–20—**2000** milliseconds  
 For China timer sets 21–25—**1000** milliseconds  
 For Q.703 Annex A timer sets 26–30—**1000** milliseconds  
 For Unchannelized T1 timer sets 31–35—**14000** milliseconds

**:t4epp=** (optional)

Timer 4—Proving period Emergency

**Range:** **200-10000**  
 For ANSI timer sets 1–10—**200-1000** milliseconds  
 For ITU timer sets 11–20—**400-600** milliseconds  
 For China timer sets 21–25—**400-600** milliseconds  
 For Q.703 Annex A timer sets 26–30—**400-600** milliseconds  
 For Unchannelized T1 timer sets 31–35—**3000-10000** milliseconds

**Default:** No change to the current value

**System**

**Default:** For ANSI timer sets 1–10—**600** milliseconds  
 For ITU timer sets 11–20—**500** milliseconds  
 For China timer sets 21–25—**500** milliseconds  
 For Q.703 Annex A timer sets 26–30—**500** milliseconds  
 For Unchannelized T1 timer sets 31–35—**3000** milliseconds

**:t4npp=** (optional)

Timer 4— Proving period normal

**Range:** 500-70000

For ANSI timer sets 1–10—500–5000 milliseconds

For ITU timer sets 11–20—7500–9500 milliseconds

For China timer sets 21–25—3000–70000 milliseconds

For Q.703 Annex A timer sets 26–30—3000–70000 milliseconds

For Unchannelized T1 timer sets 31–35—3000–30000 milliseconds

**Default:** No change to the current value**System****Default:** For ANSI timer sets 1–10—2300 milliseconds

For ITU timer sets 11–20—8200 milliseconds

For China timer sets 21–25—30000 milliseconds

For Q.703 Annex A timer sets 26–30—30000 milliseconds

For Unchannelized T1 timer sets 31–35—30000 milliseconds

**:t5=** (optional)

Timer 5—Sending SIB

**Range:** 40-500

For ANSI timer sets 1–10—40–500 milliseconds

For ITU timer sets 11–20—80–120 milliseconds

For China timer sets 21–25—80–120 milliseconds

For Q.703 Annex A timer sets 26–30—80–120 milliseconds

For Unchannelized T1 timer sets 31–35—80–120 milliseconds

**Default:** No change to the current value**System****Default:** For ANSI timer sets 1–10—100 milliseconds

For ITU timer sets 11–20—100 milliseconds

For China timer sets 21–25—100 milliseconds

For Q.703 Annex A timer sets 26–30—100 milliseconds

For Unchannelized T1 timer sets 31–35—80 milliseconds

**:t6=** (optional)

Timer 6—Remote congestion

**Range:** 1000-10000

For ANSI timer sets 1–10—1000–10000 milliseconds

For ITU timer sets 11–20—3000–6000 milliseconds

For China timer sets 21–24—3000–6000 milliseconds

For Q.703 timer sets 26–30—3000–6000 milliseconds

For Unchannelized T1 sets 31–35—3000–6000 milliseconds

**Default:** No change to the current value**System****Default:** For ANSI timer sets 1–10—4000 milliseconds

For ITU timer sets 11–20—4000 milliseconds

For China timer sets 21–25—5000 milliseconds

For Q.703 Annex A timer sets 26–30—5000 milliseconds

For Unchannelized T1 timer sets 31–35—5000 milliseconds

**:t7=** (optional)

Timer 7—Excessive delay of acknowledgment

**Range:** 200-3000

For ANSI timer sets 1–10—200–3000 milliseconds

For ITU timer sets 11–20—500–2000 milliseconds

For China timer sets 21–25—500–2000 milliseconds

For Q.703 Annex A timer sets 26–30—**500–2000** milliseconds  
 For Unchannelized T1 timer sets 31–35—**500–2000** milliseconds  
**Default:** No change to the current value  
**System**  
**Default:** For ANSI timer sets 1–10—**1500** milliseconds  
 For ITU timer sets 11–20—**1500** milliseconds  
 For China timer sets 21–25—**800** milliseconds  
 For Q.703 Annex A timer sets 26–30—**800** milliseconds  
 For Unchannelized T1 timer sets 31–35—**500** milliseconds

### Example

```
chg-l2t:l2tset=1:t1=5400
chg-l2t:l2tset=21:t4epp=600:t5=90:t6=3500:t7=1900
chg-l2t:l2tset=1:nodata=200
```

### Dependencies

At least one optional parameter must be specified.  
 The value specified for the timer must be within the range for that domain.

### Notes

ANSI timer defaults are within the Telcordia recommended ranges.  
 ITU timer defaults are within ITU Q.703 white book recommended ranges.  
 If the value specified for the **nodata** parameter is greater than 200 milliseconds, then the following message appears:



CAUTION

**CAUTION: WARNING: If NODATA timer value is greater than 200ms, links could go into congestion before link failure is declared**

### Output

```
chg-l2t:l2tset=21:t4epp=600:t5=90:t6=3500:t7=1900
rlghncxa03w 05-02-07 11:11:28 EST EAGLE5 34.0.0
CHG-L2T: MASP A - COMPLTD
;

chg-l2t:l2tset=1:nodata=200
tekelecstp 08-05-02 16:36:09 EST EAGLE 39.0.0
CHG-L2T: MASP A - COMPLTD
```

## chg-l3t

### Change Level 3 Timers

Use this command to change the SS7 MTP level 3 timers. The SS7 MTP level 3 timers are organized in a timer set of 21 values each. Only one timer set is administered by this command. Each linkset is associated with the SS7 MTP level 3 Timer set. The linkset and timer set association is assigned with the link administration commands.

**Keyword:** chg-l3t

**Related Commands:** chg-l2t, rtrv-l2t, rtrv-l3t

**Command Class:** Database Administration

## Parameters

**NOTE: You can enter seconds or milliseconds for the timer values. If seconds are entered, the timer value must contain at least one decimal place, but it can contain up to three decimal places. If you do not use decimal places, the system accepts the value as milliseconds. Be aware that the rtrv-l3t command always displays the output in seconds, not milliseconds.**

**:l3tset=** (mandatory)

Timer set table. Only one timer set table exists. All SS7 signaling links use the SS7 MTP level 3 timer set table.

**Range:** 1

**:it18=** (optional)

For ITU networks.

Timer 18—Timer within a signaling point whose MTP restarts to supervise the receipt of routing information and the activation of the link and link set; in seconds.

**Range:** 19.0-50.0

**Default:** No change to the current value.

**System**

**Default:** 50.0

**:it19=** (optional)

For ITU networks.

Timer 19—Supervision timer during MTP restart to avoid ping-pong of TFP, TFR1, and TRA messages; in seconds.

**Range:** 67.0-69.0

**Default:** No change to the current value

**System**

**Default:** 67.0

**:it20=** (optional)

For ITU networks.

Timer 20—Overall MTP restart timer at the signaling point whose MTP restarts; in seconds.

**Range:** 59.0-61.0

**Default:** No change to the current value.

**System**

**Default:** 59.0

**:it21=** (optional)

For ITU networks.

Timer 21—Overall MTP restart timer at a signaling point adjacent to one whose MTP restarts; in seconds.

**Range:** 63.0-65.0

**Default:** No change to the current value.

**System**

**Default:** 63.0

**:it22=** (optional)

For ITU networks.

Timer 22—Waiting to repeat local inhibit test; in seconds.

**Range:** 180.0-360.0

**Default:** No change to the current value

**System**  
**Default:** 90.0

**:it23=** (optional)

For ITU networks.

Timer 23—Waiting to repeat remote inhibit test; in seconds.

**Range:** 180.0-360.0  
**Default:** No change to the current value  
**System**  
**Default:** 90.0

**:t1=** (optional)

For ANSI or ITU networks.

Timer 1—Changeover delay in seconds. Also used as isolation timer for ITU MTP Restart.

**Range:** 0.1-2.0  
**Default:** No change to the current value  
**System**  
**Default:** 0.8

**:t10=** (optional)

For ANSI or ITU networks.

Timer 10—Wait to repeat signaling route set test (SRST) message; in seconds.

**Range:** 20.0-90.0  
**Default:** No change to the current value  
**System**  
**Default:** 30.0

**:t11=** (optional)

For ANSI or ITU networks.

Timer 11—Transfer restricted; in seconds.

**Range:** 1.0-90.0  
**Default:** No change to the current value  
**System**  
**Default:** 30.0

**:t12=** (optional)

For ANSI or ITU networks.

Timer 12—Wait for uninhibit acknowledgment; in seconds.

**Range:** 0.1-2.0  
**Default:** No change to the current value  
**System**  
**Default:** 0.8

**:t13=** (optional)

For ANSI or ITU networks.

Timer 13—Wait for force uninhibit; in seconds.

**Range:** 0.1-2.0  
**Default:** No change to the current value.  
**System**  
**Default:** 0.8

**:t14=** (optional)

For ANSI or ITU networks.

Timer 14—Wait for inhibit acknowledgment; in seconds.

**Range:** 0.2-4.0  
**Default:** No change to the current value  
**System**  
**Default:** 2.0

**:t15=** (optional)

For ANSI or ITU networks.

Timer 15—Wait for repeat route set congestion test (RSCT); in seconds.

**Range:** 0.2-4.0  
**Default:** No change to the current value  
**System**  
**Default:** 3.0

**:t16=** (optional)

For ANSI or ITU networks.

Timer 16—Wait for route set congestion test (RSCT) update; in seconds.

**Range:** 0.2-3.0  
**Default:** No change to the current value  
**System**  
**Default:** 1.4

**:t17=** (optional)

For ANSI or ITU networks.

Timer 17—Delay to avoid oscillation of initial alignment failure; in seconds.

**Range:** 0.5-2.0  
**Default:** No change to the current value  
**System**  
**Default:** 0.8

**:t18=** (optional)

For ANSI networks.

Timer 18—Repeat transfer restricted (TFR) once by response method; in seconds.

**Range:** 2.0-20.0  
**Default:** No change to the current value  
**System**  
**Default:** 10.0

**:t19=** (optional)

For ANSI networks.

Timer 19—Failed link craft referral timer; in seconds.

**Range:** 30.0-600.0  
**Default:** No change to the current value.  
**System**  
**Default:** 480

**:t2=** (optional)

For ANSI or ITU networks.

Timer 2—Wait for changeover acknowledge (COA); in seconds.

**Range:** 0.1-3.0  
**Default:** No change to the current value

**System****Default:** 1.4**:t20=** (optional)

For ANSI networks.

Timer 20—Repeat local inhibit test; in seconds.

**Range:** 90.0-120.0**Default:** No change to the current value**System****Default:** 90.0**:t21=** (optional)

For ANSI networks.

Timer 21—Repeat remote inhibit test; in seconds.

**Range:** 90.0-120.0**Default:** No change to the current value**System****Default:** 90.0**:t22=** (optional)

For ANSI networks.

Timer 22—Timer at restarting STP, waiting for signaling links to become available; in seconds.

**Range:** 10.0-60.0**Default:** No change to the current value.**System****Default:** 10.0**:t23=** (optional)

For ANSI networks.

Timer 23—Timer at restarting STP, started after T22, waiting to receive all TRA messages; in seconds.

**Range:** 9.0-100.0**Default:** No change to the current value.**System****Default:** 10.0**:t24=** (optional)

For ANSI networks.

Timer 24—Timer at restarting STP with transfer function, started after T23, waiting to broadcast all TRA messages; in seconds.

**Range:** 9.0-60.0**Default:** No change to the current value.**System****Default:** 10.0**:t25=** (optional)

For ANSI networks.

Timer 25—Timer at adjacent STP and restarting STP, waiting for TRA message; may be started at level 2; in seconds.

**Range:** 30.0-35.0**Default:** No change to the current value**System****Default:** 30.0



**:t26=** (optional)

For ANSI networks.

Timer 26—Timer at restarting STP, waiting to repeat TRW message; in seconds.

**Range:** 12.0-15.0**Default:** No change to the current value.**System****Default:** 12.0**:t28=** (optional)

For ANSI networks.

Timer 28—Timer at STP adjacent to restarting STP, waiting for TRW message; in seconds.

**Range:** 3.0-35.0**Default:** No change to the current value**System****Default:** 3.0**:t29=** (optional)

For ANSI networks.

Timer 29—Timer started when a TRA is sent in response to an unexpected TRA or TRW; also, started when traffic resumed without receipt of TRA; in seconds.

**Range:** 60.0-65.0**Default:** No change to the current value**System****Default:** 60.0**:t3=** (optional)

For ANSI or ITU networks.

Timer 3—Time controlled diversion on changeback; in seconds.

**Range:** 0.1-2.0**Default:** No change to the current value**System****Default:** 0.8**:t30=** (optional)

For ANSI networks.

Timer 30—Timer to limit sending of TFPs/TFRs in response to an unexpected TRA or TRW; in seconds.

**Range:** 30.0-35.0**Default:** No change to the current value**System****Default:** 30.0**:t31=** (optional)

For ANSI networks.

Timer 31—False link congestion detection; in seconds.

**Range:** 10.0-120.0**Default:** No change to the current value.**System****Default:** 60.0**:t32=** (optional)

For ANSI networks.

Timer 32—Link oscillation timer – Procedure A; in seconds.

**Range:** 60.0-120.0

**Default:** No change to the current value.

**System**

**Default:** 60.0

**:t4=** (optional)

For ANSI or ITU networks.

Timer 4—Wait for changeback acknowledge (CBA) #1; in seconds.

**Range:** 0.1-2.0

**Default:** No change to the current value

**System**

**Default:** 0.8

**:t5=** (optional)

For ANSI or ITU networks.

Timer 5—Wait for changeback acknowledge (CBA) #2; in seconds.

**Range:** 0.1-2.0

**Default:** No change to the current value

**System**

**Default:** 0.8

**:t6=** (optional)

For ANSI or ITU networks.

Timer 6—Controlled reroute; in seconds.

**Range:** 0.1-2.0

**Default:** No change to the current value

**System**

**Default:** 0.8

**:t7=** (optional)

For ANSI or ITU networks.

Timer 7—Signaling data link connection (SDLC) acknowledg; in seconds.

**Range:** 0.1-3.0

**Default:** No change to the current value.

**System**

**Default:** 1.0

**:t8=** (optional)

For ANSI or ITU networks.

Timer 8—Transfer prohibited (TFP) inhibit; in seconds.

**Range:** 0.5-2.0

**Default:** No change to the current value.

**System**

**Default:** 0.8

### Example

```
chg-13t:13tset=1:t1=800
```

```
chg-13t:13tset=1:t5=800:t6=800:t32=70000
```

### Dependencies

The minimum parameter requirement is the table number and at least one timer specified.

Do not specify T20 and IT22 pairs of timers together because one value overrides the other.

Do not specify T21 and IT23 pairs of timers together because one value overrides the other.

### Notes

The command line allows 157 characters. Some SS7 MTP level 3 timer changes may exceed this limit. Multiple entries of this command may be required in such cases.

Timer 9 is not currently supported in the SS7 protocol, and has been omitted from this manual. The command will support this timer when it has been defined in the protocol.

The default values are within the Telcordia recommended ranges.

### Output

```
chg-l3t:13tset=1:t1=800
```

```
rlghncxa03w 04-01-07 08:40:50 EST EAGLE 31.3.0
CHG-L3T: MASP A - COMPLTD
```

```
;
```

## chg-lbp

### Change Loopback Point's Attribute Values

Use this command to change a far-end loopback point's attribute values maintained in the link fault sectionalization table.

**Keyword:** **chg-lbp**

**Related Commands:** **act-lbp, dact-lbp, dlt-lbp, ent-lbp, rtrv-lbp**

**Command Class:** Database Administration

### Parameters

**:lbp=** (mandatory)

Loopback point ID. This parameter identifies a far-end loopback point that lies along an SS7 signaling link path between the STP and the target device (up to *and including* the target device).

**Range:** **1-32**

**:link=** (mandatory)

SS7 signaling links. The SS7 signaling link to be tested.

**Synonym:** **port**

**Range:** **a, b, a1-a31, b1-b31**

Not all card types support all **link** parameter values.

See Table A-1 for valid **link** parameter range values for each type of card that can have assigned signaling links.

**:loc=** (mandatory)

Card location. The unique identifier of a specific application subsystem located in the STP.

**Range:** **1101-1108, 1111-1112, 1201-1208, 1211-1218, 1301-1308, 1311-1318, 2101-2108, 2111-2118, 2201-2208, 2211-2218, 2301-2308, 2311-2318, 3101-3108, 3111-3118, 3201-3208, 3211-3218, 3301-3308, 3311-3318, 4101-4108, 4111-4118, 4201-4208, 4211-4218, 4301-4308, 4311-4318, 5101-5108, 5111-5118, 5201-5208, 5211-5218, 5301-5308, 5311-5318, 6101-6108, 6111-6118**

**:cli=** (optional)

Common Language Location Identifier (CLLI) code. This parameter specifies the CILLI or other mnemonic identifier used to refer to the given loopback point.

**Range:** **ayyyyyyyyy**

1 alphabetic character followed by up to 23 alphanumeric characters

**Default:** No change to the cli value

**:lfst=** (optional)

Link fault sectionalization test. The type of link fault sectionalization loopback test to be performed.

**Range:** **llt, nlt**

**llt**—latching loopback test

**nlt**—nonlatching loopback test

**:rep=** (optional)

Repetition count. The number of link elements of the same type (not including the target device) that lie between the STP and the link element to be tested.

**Range:** **0-31**

**Default:** No change unless:

**0**—The link element to be looped back for testing is NEI (**rle=nei** is specified)

**0**—The type of link fault sectionalization test is NLT (**lfst=nlt** is specified)

**0**—The type of link fault sectionalization test is NLT (**lfst=nlt** is specified)

**0**—The new remote link element is the first loopback point of the link to be tested

**1-30**—Next sequential number for subsequent loopback points of the link to be tested

**:rle=** (optional)

Remote link element. The link element to be looped back for testing.

**Range:** **ds0, ocu, csu, dsu, nei**

**Default:** No change to the rle value

### Example

```
chg-lbp:loc=1101:link=a:lbp=1:rle=ds0:lfst=llt
```

### Dependencies

The Link Fault Sectionalization (LFS) feature must be on before using this command.

At least one optional parameter must be specified.

The card location specified in the **loc** parameter cannot be reserved by the system.

The card location (**loc** parameter) must identify a provisioned **limds0**, **limt1**, or **limch** (associated to a **limt1**) card configured with either an **ss7ansi** or **ccs7itu** application.

The CLLI cannot be a reserved word.

The **rep** parameter value that is specified for this loopback point (LBP) must be greater than the **rep** parameter value of any previously defined LBP and *less* than the **rep** parameter value of any subsequently defined LBP.

The **rep** parameter must be specified if the default value is a duplicate of the **rep** parameter value of any previously defined loopback point.

The LBP must have been previously defined.

The **rep** parameter can be specified only if the **lfst=llt** parameter is specified.

If the **rle=nei** parameter is specified, the **rep=0** parameter must be specified.

The **rle=ds0** or the **rle=nei** parameter cannot be specified if the **lfst=nlt** parameter is specified. The DS0 and Network Element Interface (NEI) link elements do not support non-latching loopbacks.

For each SS7 signaling link, you can define only one loopback point with **rle=nei** specified; and that loopback point must be the terminating SS7 signaling link component.

For each SS7 signaling link, the loopback point with **rle=nei** specified must be the terminating SS7 signaling link component.

The card location specified in the **loc** parameter must be equipped.

**Notes**

None

**Output**

```
chg-lbp:loc=1101:port=a:lbp=1:rle=ds0:lfst=11t
      rlgncxa03w 05-01-17 15:35:05 EST  EAGLE5 33.0.0
      CHG-LBP: MASP A - COMPLTD
      ;
```

**chg-lnp-serv****Change LNP Service**

Use this command to change an existing LNP service. You can specify a new translation type, digit validity indicator, and translation type name for the existing service. A new translation type name of **none** defaults the name back to the reserved service type name.

**Keyword:** **chg-lnp-serv**

**Related Commands:** **dlt-lnp-serv, ent-lnp-serv, rtrv-lnp-serv**

**Command Class:** Database Administration

**Parameters**

**NOTE:** All alias translation types must be removed before the service can be moved to another translation type.

**:ndv=** (optional)

New digits valid.

**Range:** **sccp, tcap**

**Default:** The current value

**:nserv=** (optional)

New reserved service type name.

**Range:** **ain, in, pcs, wnp, class, lidb, cnam, isvm, lnpqs, wmsc, udf1, udf2, udf3, udf4, lrnqt**

**Default:** The current value

**:ntt=** (optional)

New translation type.

**Range:** **0-255**

**Default:** The current value

**:nttn=** (optional)

User defined TT name.

**Range:** **aaaaaaaa, none**  
1 to 8 alphabetic characters, or **none**

**Default:** If **none** is specified, the default value is the reserved service type name (**serv** parameter).  
If **none** is not specified, no change to current value.

**:serv=** (optional)

Reserved service type name.

**Range:** **ain, in, pcs, wnp, class, lidb, cnam, isvm, lnpqs, wmsc, udf1, udf2, udf3, udf4, lrnqt**

**Default:** The current value

**:tt=** (optional)

Translation type.

**Range:** 0-255  
**Default:** The current value

### Example

```
chg-lnp-serv:serv=lidb:ntt=22, ndv=tcap:nttn=mrlidb
chg-lnp-serv:tt=11:nserv=lnpqs
chg-lnp-serv:tt=239:nserv=lrnqt
```

### Dependencies

The LNP feature must be turned on before this command can be entered (see the **enable-ctrl-feat** and **chg-ctrl-feat** commands).

The LNP feature is "turned on" when a value for the LNP ported TNs quantity is shown in the **rtrv-ctrl-feat** command output.

The LNP SMS feature must be turned on before the **serv=wsmisc** parameter can be specified.

The PCS 1900 LNP (PLNP) feature must be turned on before the **nserv=pcs** parameter can be specified.

The WNP feature must be turned on before the **nserv=wnp** parameter can be specified.

The **serv** parameter or the **tt** parameter must be specified in the command.

The value of the **ntt** parameter cannot already exist in the LNP database.

The value of the **nttn** parameter cannot already exist in the LNP database.

The value of the **serv** parameter must already exist in the LNP database.

The **nserv** and **tt** parameters must be specified together in the command. If these parameters are specified, then no other parameter can be specified in the command. If the value specified for the **tt** or **nserv** parameter is already associated with the **class**, **lidb**, **enam**, **isvm**, **wsmisc**, **udf1**, **udf2**, **udf3**, or **udf4** service, then a value of **lnpqs**, **ain**, **in**, **wnp**, or **pcs** cannot be specified for the **nserv** or **tt** parameter, respectively. The **tt** and **ntt** parameters cannot be specified together in the command.

The value of the **ndv** parameter cannot match the parameter of the **dv** parameter.

An LNP alias cannot be specified as the value for the **ntt** parameter.

All LNP aliases for the value of the **serv** parameter must be removed from the LNP database before the **serv** parameter can be specified.

A reserved service type name can be specified for the **nttn** parameter only if the name matches the existing service (**serv** parameter)

If a value of **udf1**, **udf2**, **udf3**, or **udf4** is specified for the **serv** parameter, then the **ndv=sccp** parameter must be specified.

If a value of **lnpqs**, **ain**, **in**, **pcs**, **wnp**, or **lrnqt** is specified for the **serv** parameter, then the **ndv=tcap** parameter must be specified.

If the **serv** parameter is specified, then the **ntt**, **nttn**, or **ndv** parameter must be specified. If the **tt** parameter is specified, then the **nserv** parameter must be specified.

The LRNQT feature must be turned on (see the **chg-ctrl-feat** command) before the (n)**serv=lrnqt** parameter can be specified.

A maximum of 6 Message Relay services are allowed.

The values entered or referenced in the command create an invalid DV or SERV.

If a user-defined type is specified as a value for the **nserv** parameter or was specified for the **serv** parameter (see the **ent-lnp-serv** command), then a value of **sccp** must have been specified for the **dv** parameter or must be specified for the **ndv** parameter.

If a value of **wnp**, **ain**, **pcs**, **in**, or **lnpqs** is specified for the **nserv** parameter or was specified for the **serv** parameter, then a value of **tcap** must have been specified for the **dv** parameter or must be specified for the **ndv** parameter.

### Notes

None

### Output

```
chg-lnp-serv:serv=lidb:ntt=22:ndv=tcap:nttn=mrldb
rlghncxa03w 02-11-18 08:50:12 EST EAGLE 30.0.0
CHG-LNP-SERV: MASP A - COMPLTD
;
```

## chg-lnp-ttmap

### Change LNP Translation Type Mapping

Use this command to create, change, or disable the existing message relay global title (MRGT) LNP GT entry for a group of existing telephone numbers (TN) in the database. This command allows you to specify a translation type and global title address treatment of different service providers according to the DPC configured in the message relay (MR) global title translation (GTT) table.

**NOTE: As of Release 40.1, this command is obsolete.**

**Keyword:** **chg-lnp-ttmap**

**Related Commands:**

**Command Class:** LNP Database

### Parameters

**NOTE: See "Point Code Formats and Conversion" for a detailed description of point code formats, rules for specification, and examples.**

**:pc=** (mandatory)

ANSI destination point code with subfields *network indicator-network cluster-network cluster member (ni-nc-ncm)*.

**Synonym:** **pca**

**Range:** **000-255**

Specify a valid value for each subfield of the point code, and separate the subfields with a dash (-).

When **chg-sid:pctype=ansi** is specified, **ni = 000** is not valid.

When **chg-sid:pctype=ansi** is specified, **nc = 000** is not valid if **ni = 001-005**.

When **chg-sid:pctype=ansi** is specified, **nc = 000** is valid if **ni = 006-255**.

The point code **000-000-000** is not a valid point code.

**:tt=** (mandatory)

Translation type.

**Range:** **0-255**

**:nngt=** (optional)

New new global title translation type.

**Range:** **0-255 none**

**Default:** No change to current value

**:nrgta=** (optional)

New replacement **gta** treatment.

**Range:** **yes, no**

**Default:** No change to current value

### Example

```
chg-lnp-ttmap:tt=16:pc=233-233-233:nngt=28
```

### Dependencies

The LNP feature must be turned on (see the **enable-ctrl-feat** command) before this command can be entered.

At least one optional parameter must be specified.

The **tt** cannot be an LNP alias.

The point code (**pc/pca** parameter) must exist in the routing table.

### Notes

Entering this command one time affects all of the TNs that reference the specified DPC in their default MR GTT or MR GTT respectively.

If the **nngt** parameter is specified, the **xlat=dpcnngt** and **ri=gt** parameter values must be specified. If they are not specified, they are changed to those values.

The **nrgta** parameter assumes an associated LRN is specified. If no LRN is specified, the real-time database displays *not found* information.

If the **nrgta** or **ngt** parameter is specified, it performs a global database assignment of **ngt** or **rgta** to the specified translation type and point code combination in the database.

### Output

```
chg-lnp-ttmap:tt=16:pc=233-233-233:nngt=28
```

```
rlghncxa03w 04-01-05 16:40:40 EST EAGLE 31.3.0
CHG-LNP-TTMAP: MASP A - COMPLTD
```

```
;
```

## chg-lnpopts

## Change LNP System Options

Use this command to enter LNP-specific system options in the database. This command updates the LNPOPTS table.

**Keyword:** chg-lnpopts

**Related Commands:** rtrv-lnpopts

**Command Class:** Database Administration

### Parameters

**NOTE:** The **aud** parameter is obsolete.

**:admhipri=** (optional)

Give LNP database administration the highest administrative priority in the system.

**Range:** yes, no

**Default:** The current value.

**:amactype=** (optional)

AMA call type.

**Range:** 3 digits

**Default:** The current value.

**:amafeatid=** (optional)

AMA feature ID.



- Range:** 3 digits  
**Default:** The current value.
- :amaslpid=** (optional)  
AMA slip ID.  
**Range:** 9 digits  
**Default:** The current value.
- :ccp=** (optional)  
Copy charge parameters. When this parameter is enabled (**ccp=yes**), the EAGLE 5 ISS copies the Charge Number and Charge Party Station type from an LNP AIN query (if present) to the LNP AIN Response message.  
**Range:** **yes, no**  
**Default:** The current value.
- :cic=** (optional)  
Carrier identification code.  
**Range:** 3-4 digits  
**Default:** The current value.
- :dra=** (optional)  
Destination routing address content.  
**Range:** **lrntn, lrn**  
**Default:** No change to the current value
- :frcsmplx=** (optional)  
Allow simplex database updates.  
**Range:** **yes, no**  
**Default:** The current value.
- :gtwystp=** (optional)  
Indicates that the LNP system is also configured as a Gateway STP.  
**Range:** **yes, no**  
**Default:** The current value.
- :incslp=** (optional)  
Include AMA slip ID in the response.  
**Range:** **yes, no**  
**Default:** The current value.
- :jipdigits=** (optional)  
The Jurisdictional Information Parameter value.  
**Range:** 6 digits  
**Default:** The current value.
- :jiprv=** (optional)  
Determines whether a Jurisdictional Information Parameter value is to be added to the IAM.  
**Range:** **yes, no**  
**Default:** The current value.
- :lrndgts=** (optional)  
LRN digits.  
**Range:** 1-10 digits  
**Default:** No change to the current value
- :naiv=** (optional)  
Nature of address indicator value.

**Range:** 0-127 digits  
**Default:** No change to the current value

**:servport=** (optional)

Service portability.

**Range:** **yes, no**

**yes**— This is a protocol setting that allows splitting services between TN and LRN override records. This setting lets the EAGLE LNP craftsperson update LRN overrides for message relay services that are to be supported in the network. The EAGLE 5 ISS then uses the TN gateway point code (NPAC subscription data) for message relay services the CLEC wants to provide.

**no**— If no LRN override services are provisioned, then the TN's gateway point codes (NPAC subscription data) are used to route queries out of the network. If one or more LRN override services are provisioned, the TN is considered to be ported into the network. In this case, if an LRN override service is requested and the LRN has other services administered, but the requested service is not provisioned, then a UDTS response for the service is provided.

**Default:** The current value

**:sp=** (optional)

Service provider ID.

**Range:** *xyyy*  
 4 alphanumeric characters

**Default:** The current value.

**:tndgts=** (optional)

TN digits.

**Range:** 1-10 digits

**Default:** No change to the current value

**:wqredrct=** (optional)

Wireless queries directed to default GTT.

**Range:** **on, off**

**on**— This setting allows the GTT functionality to treat any wireless LNP (WNP and PCS) queries that require GT as a normal GTT.

**off**— This setting routes all wireless LNP queries (WNP and PCS) that require GT directly to the local subsystem.

**Default:** the current value

**:wsmsc10dig=** (optional)

SCCP GTA digit length indicator for 10 or 11 digits.

**Range:** **yes, no**

**yes**— The system verifies that either 10 or 11 digits are present in the CDPA GTA. If 11 digits are present, the first digit is stripped to derive 10 digits for LNP SMS translation. If 10 digits are present, all 10 digits are used for LNP SMS translation.

**no**— The system verifies that 11 digits (plus a padded 0 digit) are present in the CDPA GTA. If 11 digits are present, the system strips the first digit and considers only 10 digits for LNP SMS translation.

**Default:** the current value

**:aud=** (obsolete)

Audit indicator.

**Range:** **on, off**

**Default:** The current value.

**Example**

```
chg-lnpopts:amaslpid=123456789
chg-lnpopts:amactype=003
chg-lnpopts:amafeatid=010
chg-lnpopts:incslp=yes
chg-lnpopts:cic=1369
chg-lnpopts:aud=on
chg-lnpopts:sp=1234
chg-lnpopts:jipdigits=919460
chg-lnpopts:jipprv=yes
chg-lnpopts:frcsmplx=yes
chg-lnpopts:admhipri=yes
chg-lnpopts:gtwystp=yes
chg-lnpopts:ccp=yes
chg-lnpopts:servport=yes
chg-lnpopts:wqredrct=off
chg-lnpopts:wsmc10dig=yes
```

**Dependencies**

At least one optional parameter must be specified.

The LNP feature (see the **enable-ctrl-feat** command) and the Triggerless LNP (TLNP) feature must be turned on before this command can be entered.

The Triggerless LNP feature must be turned on before the **jipprv** and the **jipdigits** parameters can be specified.

The LNP SMS feature must be turned on before the **wsmc10dig** parameter can be specified.

The LNP feature (see the **enable-ctrl-feat** command) must be turned on before this command can be entered.

The INP feature must be turned on before the **lrndgts**, **tndgts**, **dra**, or **naiv** parameters can be specified.

The WNP or PCS feature must be turned on before the **wqredrct** parameter can be specified.

**Notes**

The **frcsmplx** parameter is used to force the system in a forced simplex mode. In this mode, simplex updates are accepted by the active OAM if the standby OAM is in one of the following states: incoherent, diff level, or unstable.

If the **admhipri** parameter is set to **yes**, LNP database administration can starve out normal STP updates during LNP administration of 2 TNs per second. If the parameter is set to **no**, then STP and LNP updates receive the same priority. Depending on the system activity level, the performance of LNP updates may be reduced.

If the **gtwystp** parameter is set to **yes**, the LNP system is also configured as a gateway STP. The NPAC sends down capability point codes without routes. In this configuration, the system does not output a warning (UIM 1176) about capability point codes or true point codes without routes.

**Output**

```
chg-lnpopts:amaslpid=123456789

rlghncxa03w 04-01-07 00:57:31 EST EAGLE 31.3.0
CHG-LNPOPTS: MASP A - COMPLTD
;
```

**chg-loopset****Change Loop Set command**

Use this command to change the loopset data in the database. This command updates the Loopset Table. A single instance of the **chg-loopset** command can be used to append up to 6 point codes to the loopset (a loopset can contain a total of 12 point codes), replace all data in the loopset, or change one or two point codes in the loopset.

**Keyword:** **chg-loopset**

**Related Commands:** **dlt-loopset**, **ent-loopset**, **rtrv-loopset**

**Command Class:** Database Administration

**Parameters**

**:name=** (mandatory)

Loopset name. This parameter specifies an entry in the Loopset table.

The **name=none** parameter cannot be specified.

**Range:** *ayyyyyyy*

1 alphabetic and up to 7 alphanumeric characters.

**:apcl=** (optional)

ANSI appending point code list with subfields *network indicator-network cluster-network cluster member (ninc-ncm)*. The *prefix* subfield indicates a private point code (*prefix-ni-nc-ncm*). This parameter allows up to 6 comma-delimited entries in the point code list.

**Synonym:** **apcla**

**Range:** **p-, 000-255**

Specify a valid value for each subfield of the point code, and separate the subfields with a dash (-).

*prefix—p-*

When **chg-sid:pctype=ansi** is specified, *ni = 000* is not valid.

When **chg-sid:pctype=ansi** is specified, *nc = 000* is not valid if *ni = 001-005*.

When **chg-sid:pctype=ansi** is specified, *nc = 000* is valid if *ni = 006-255*.

The point code **000-000-000** is not a valid point code.

**:apcli=** (optional)

ITU international appending point code list with subfields *zone-area-id*. The *prefix* subfield indicates a spare point code, private point code, or private and spare point code (*prefix-zone-area-id*). This parameter allows up to 6 comma delimited entries in the point code list.

**Range:** **s-, p-, ps-, 0-255**

Specify a valid value for each subfield of the point code, and separate the subfields with a dash (-).

*prefix—s-, p-, ps-*

*zone—0-7*

*area—000-255*

*id—0-7*

The point code **0-000-0** is not a valid point code.

**:apcn=** (optional)

ITU national appending point code list in the format of a 5-digit number (*nnnnn*); or 2, 3, or 4 numbers (members) separated by dashes (*m1-m2-m3-m4*) as defined by the **chg-stpopts:npcfmti** flexible point code option. A group code must be specified when the ITUDUPPC feature is turned on (*nnnnn-gc*, *m1-m2-m3-m4-gc*). The *prefix* subfield indicates a spare point code (*prefix-nnnnn*, *prefix-nnnnn-gc*, *prefix-m1-m2-m3-m4*, *prefix-m1-m2-m3-m4-gc*). This parameter allows up to 6 comma-delimited entries in the point code list.

**Range:** **s-, p-, ps-, 0-16383, aa-zz**

Specify a valid value for each subfield of the point code, and separate the subfields with a dash (-).

*prefix*—**s-, p-, ps-**

*nnnnn*—**0-16383**

*gc*—**aa-zz**

*m1-m2-m3-m4*—**0-14** for each member; values must sum to 14

**:apcn24=** (optional)

24-bit ITU national appending point code list with subfields *main signaling area-sub signaling area-signaling point* (*msa-ssa-sp*). This parameter allows up to 6 comma-delimited entries in the point code list.

**Range:** **p-, 000-255**

Specify a valid value for each subfield of the point code, and separate the subfields with a dash (-).

*prefix*—**p-**

*msa*—**000-255**

*ssa*—**000-255**

*sp*—**000-255**

**:force=** (optional)

The **force=yes** parameter must be specified to modify a loopset that is being used by GTT.

**Range:** **yes**

**:mode=** (optional)

Mode of operation. This parameter specifies whether the message is discarded when an SCCP loop is detected.

**Range:** **notify, discard**

**notify** — Generates a UIM without discarding the message.

**discard** — Generates a UIM and discards the message.

**:npc1=** (optional)

ANSI new point code 1 with subfields *network indicator-network cluster-network cluster member* (*ninc-ncm*). The *prefix* subfield indicates a private point code (*prefix-ni-nc-ncm*).

**Synonym:** **npc1a**

**Range:** **p-, 000-255**

Specify a valid value for each subfield of the point code, and separate the subfields with a dash (-).

*prefix*—**p-**

When **chg-sid:pctype=ansi** is specified, *ni* = **000** is not valid.

When **chg-sid:pctype=ansi** is specified, *nc* = **000** is not valid if *ni* = **001-005**.

When **chg-sid:pctype=ansi** is specified, *nc* = **000** is valid if *ni* = **006-255**.

The point code **000-000-000** is not a valid point code.

**:npc1i=** (optional)

ITU international new point code 1 with subfields *zone-area-id*. The *prefix* subfield indicates a spare point code, private point code, or private and spare point code (*prefix-zone-area-id*).

**Range:** **s-, p-, ps-, 0-255**

Specify a valid value for each subfield of the point code, and separate the subfields with a dash (-).

*prefix*—**s-, p-, ps-**

*zone*—**0-7**

*area*—**000-255**

*id*—**0-7**

The point code **0-000-0** is not a valid point code.

**:npc1n=** (optional)

ITU national new point code 1 in the format of a 5-digit number (*nnnnn*); or 2, 3, or 4 numbers (members) separated by dashes (*m1-m2-m3-m4*) as defined by the **chg-stpopts:npcfmti** flexible point code option. A group code must be specified when the ITUDUPPC feature is turned on (*nnnnn-gc*, *m1-m2-m3-m4-gc*). The *prefix* subfield indicates a spare point code (*prefix-nnnnn*, *prefix-nnnnn-gc*, *prefix-m1-m2-m3-m4*, *prefix-m1-m2-m3-m4-gc*).

**Range:** **s-, p-, ps-, 0-16383, aa-zz**

Specify a valid value for each subfield of the point code, and separate the subfields with a dash (-).

*prefix*—**s-, p-, ps-**

*nnnnn*—**0-16383**

*gc*—**aa-zz**

*m1-m2-m3-m4*—**0-14** for each member; values must sum to 14

**:npc1n24=** (optional)

24-bit ITU national new point code 1 with subfields *main signaling area-sub signaling area-signaling point* (*msa-ssa-sp*).

**Range:** **p-, 000-255**

Specify a valid value for each subfield of the point code, and separate the subfields with a dash (-).

*prefix*—**p-**

*msa*—**000-255**

*ssa*—**000-255**

*sp*—**000-255**

**:npc2=** (optional)

ANSI new point code 2 with subfields *network indicator-network cluster-network cluster member* (*ninc-ncm*). The *prefix* subfield indicates a private point code (*prefix-ni-nc-ncm*).

**Synonym:** **npc2a**

**Range:** **p-, 000-255**

Specify a valid value for each subfield of the point code, and separate the subfields with a dash (-).

*prefix*—**p-**

When **chg-sid:pctype=ansi** is specified, *ni* = **000** is not valid.

When **chg-sid:pctype=ansi** is specified, *nc* = **000** is not valid if *ni* = **001-005**.

When **chg-sid:pctype=ansi** is specified, *nc* = **000** is valid if *ni* = **006-255**.

The point code **000-000-000** is not a valid point code.

**:npc2i=** (optional)

ITU international new point code 2 with subfields *zone-area-id*. The *prefix* subfield indicates a spare point code, private point code, or private and spare point code (*prefix-zone-area-id*).

**Range:** **s-, p-, ps-, 0-255**

Specify a valid value for each subfield of the point code, and separate the subfields with a dash (-).

*prefix*—**s-, p-, ps-**

*zone*—**0-7**

*area*—**000-255**

*id*—**0-7**

The point code **0-000-0** is not a valid point code.

**:npc2n=** (optional)

ITU national new point code 2 in the format of a 5-digit number (*nnnnn*); or 2, 3, or 4 numbers (members) separated by dashes (*m1-m2-m3-m4*) as defined by the **chg-stpopts:npcfnti** flexible point code option. A group code must be specified when the ITUDUPPC feature is turned on (*nnnnn-gc*, *m1-m2-m3-m4-gc*). The *prefix* subfield indicates a spare point code (*prefix-nnnnn*, *prefix-nnnnn-gc*, *prefix-m1-m2-m3-m4*, *prefix-m1-m2-m3-m4-gc*).

**Range:** **s-, p-, ps-, 0-16383, aa-zz**

Specify a valid value for each subfield of the point code, and separate the subfields with a dash (-).

*prefix*—**s-, p-, ps-**

*nnnnn*—**0-16383**

*gc*—**aa-zz**

*m1-m2-m3-m4*—**0-14** for each member; values must sum to 14

**:npc2n24=** (optional)

24-bit ITU national new point code 2 with subfields *main signaling area-sub signaling area-signaling point* (*msa-ssa-sp*).

**Range:** **p-, 000-255**

Specify a valid value for each subfield of the point code, and separate the subfields with a dash (-).

*prefix*—**p-**

*msa*—**000-255**

*ssa*—**000-255**

*sp*—**000-255**

**:pc1=** (optional)

ANSI point code 1 with subfields *network indicator-network cluster-network cluster member* (*ninc-ncm*). The *prefix* subfield indicates a private point code (*prefix-ni-nc-ncm*).

**Synonym:** **pc1a**

**Range:** **p-, 000-255**

Specify a valid value for each subfield of the point code, and separate the subfields with a dash (-).

*prefix*—**p-**

When **chg-sid:pctype=ansi** is specified, *ni* = **000** is not valid.

When **chg-sid:pctype=ansi** is specified, *nc* = **000** is not valid if *ni* = **001-005**.

When **chg-sid:pctype=ansi** is specified, *nc* = **000** is valid if *ni* = **006-255**.

The point code **000-000-000** is not a valid point code.

**:pc1i=** (optional)

ITU international point code 1 with subfields *zone-area-id*. The *prefix* subfield indicates a spare point code, private point code, or private and spare point code (*prefix-zone-area-id*).

**Range:** **s-, p-, ps-, 0-255**

Specify a valid value for each subfield of the point code, and separate the subfields with a dash (-).

*prefix*—**s-, p-, ps-**

*zone*—**0-7**

*area*—**000-255**

*id*—**0-7**

The point code **0-000-0** is not a valid point code.

**:pc1n=** (optional)

ITU national point code 1 in the format of a 5-digit number (*nnnnn*); or 2, 3, or 4 numbers (members) separated by dashes (*m1-m2-m3-m4*) as defined by the **chg-stpopts:npcfnti** flexible point code option. A group code must be specified when the ITUDUPPC feature is turned on (*nnnnn-gc*, *m1-m2-m3-m4-gc*). The *prefix* subfield indicates a spare point code (*prefix-nnnnn*, *prefix-nnnnn-gc*, *prefix-m1-m2-m3-m4*, *prefix-m1-m2-m3-m4-gc*).

**Range:** **s-, p-, ps-, 0-16383, aa-zz**

Specify a valid value for each subfield of the point code, and separate the subfields with a dash (-).

*prefix*—**s-, p-, ps-**

*nnnnn*—**0-16383**

*gc*—**aa-zz**

*m1-m2-m3-m4*—**0-14** for each member; values must sum to 14

**:pc1n24=** (optional)

24-bit ITU national point code 1 with subfields *main signaling area-sub signaling area-signaling point* (*msa-ssa-sp*).

**Range:** **p-, 000-255**

Specify a valid value for each subfield of the point code, and separate the subfields with a dash (-).

*prefix*—**p-**

*msa*—**000-255**

*ssa*—**000-255**

*sp*—**000-255**

**:pc2=** (optional)

ANSI point code 2 with subfields *network indicator-network cluster-network cluster member* (*ninc-ncm*). The *prefix* subfield indicates a private point code (*prefix-ni-nc-ncm*).

**Synonym:** **pc2a**

**Range:** **p-, 000-255**

Specify a valid value for each subfield of the point code, and separate the subfields with a dash (-).

*prefix*—**p-**

When **chg-sid:pctype=ansi** is specified, *ni* = **000** is not valid.

When **chg-sid:pctype=ansi** is specified, *nc* = **000** is not valid if *ni* = **001-005**.

When **chg-sid:pctype=ansi** is specified, *nc* = **000** is valid if *ni* = **006-255**.

The point code **000-000-000** is not a valid point code.



**:pc2i=** (optional)

ITU international point code 2 with subfields *zone-area-id*. The *prefix* subfield indicates a spare point code, private point code, or private and spare point code (*prefix-zone-area-id*).

**Range:** **s-, p-, ps-, 0-255**

Specify a valid value for each subfield of the point code, and separate the subfields with a dash (-).

*prefix*—**s-, p-, ps-**

*zone*—**0-7**

*area*—**000-255**

*id*—**0-7**

The point code **0-000-0** is not a valid point code.

**:pc2n=** (optional)

ITU national point code 2 in the format of a 5-digit number (*nnnnn*); or 2, 3, or 4 numbers (members) separated by dashes (*m1-m2-m3-m4*) as defined by the **chg-stpopts:npcfmti** flexible point code option. A group code must be specified when the ITUDUPPC feature is turned on (*nnnnn-gc*, *m1-m2-m3-m4-gc*). The *prefix* subfield indicates a spare point code (*prefix-nnnnn*, *prefix-nnnnn-gc*, *prefix-m1-m2-m3-m4*, *prefix-m1-m2-m3-m4-gc*).

**Range:** **s-, p-, ps-, 0-16383, aa-zz**

Specify a valid value for each subfield of the point code, and separate the subfields with a dash (-).

*prefix*—**s-, p-, ps-**

*nnnnn*—**0-16383**

*gc*—**aa-zz**

*m1-m2-m3-m4*—**0-14** for each member; values must sum to 14

**:pc2n24=** (optional)

24-bit ITU national point code 2 with subfields *main signaling area-sub signaling area-signaling point* (*msa-ssa-sp*).

**Range:** **p-, 000-255**

Specify a valid value for each subfield of the point code, and separate the subfields with a dash (-).

*prefix*—**p-**

*msa*—**000-255**

*ssa*—**000-255**

*sp*—**000-255**

**:rpcl=** (optional)

ANSI replacing point code list with subfields *network indicator-network cluster-network cluster member* (*ninc-ncm*). The *prefix* subfield indicates a private point code (*prefix-ni-nc-ncm*). This parameter allows up to 6 comma-delimited entries in the point code list.

**Synonym:** **rpcla**

**Range:** **p-, 000-255**

Specify a valid value for each subfield of the point code, and separate the subfields with a dash (-).

*prefix*—**p-**

When **chg-sid:pctype=ansi** is specified, *ni* = **000** is not valid.

When **chg-sid:pctype=ansi** is specified, *nc* = **000** is not valid if *ni* = **001-005**.

When **chg-sid:pctype=ansi** is specified, *nc* = **000** is valid if *ni* = **006-255**.

The point code **000-000-000** is not a valid point code.

**:rpcli=** (optional)

ITU international replacing point code list with subfields *zone-area-id*. The *prefix* subfield indicates a spare point code, private point code, or private and spare point code (*prefix-zone-area-id*). This parameter allows up to 6 comma-delimited entries in the point code list.

**Range:** **s-, p-, ps-, 0-255**

Specify a valid value for each subfield of the point code, and separate the subfields with a dash (-).

*prefix*—**s-, p-, ps-**

*zone*—**0-7**

*area*—**000-255**

*id*—**0-7**

The point code **0-000-0** is not a valid point code.

**:rpcln=** (optional)

ITU national replacing point code list in the format of a 5-digit number (*nnnnn*); or 2, 3, or 4 numbers (members) separated by dashes (*m1-m2-m3-m4*) as defined by the **chg-stpopts:npcfnti** flexible point code option. A group code must be specified when the ITUDUPPC feature is turned on (*nnnnn-gc*, *m1-m2-m3-m4-gc*). The *prefix* subfield indicates a spare point code (*prefix-nnnnn*, *prefix-nnnnn-gc*, *prefix-m1-m2-m3-m4*, *prefix-m1-m2-m3-m4-gc*). This parameter allows up to 6 comma-delimited entries in the point code list.

**Range:** **s-, p-, ps-, 0-16383, aa-zz**

Specify a valid value for each subfield of the point code, and separate the subfields with a dash (-).

*prefix*—**s-, p-, ps-**

*nnnnn*—**0-16383**

*gc*—**aa-zz**

*m1-m2-m3-m4*—**0-14** for each member; values must sum to 14

**:rpcln24=** (optional)

24-bit ITU national replacing point code list with subfields *main signaling area-sub signaling area-signaling point* (*msa-ssa-sp*). This parameter allows up to 6 comma-delimited entries in the point code list.

**Range:** **p-, 000-255**

Specify a valid value for each subfield of the point code, and separate the subfields with a dash (-).

*prefix*—**p-**

*msa*—**000-255**

*ssa*—**000-255**

*sp*—**000-255**

## Example

This example sets the mode to discard and appends the listed point codes to the loopset rtp1 if the set is not being used by GTT.

```
chg-loopset:name=rtp1:mode=discard:apcl=3-7-3,5-7-5,7-4-7,5-4-5
```

This example replaces the point codes in the set with the listed point codes for the loopset rtp1 if the set is not being used by GTT.

```
chg-loopset:name=rtp2:rpcl=3-2-3,5-7-8,7-8-7,3-5-3
```

This example sets the mode to discard in the loopset rtp2 if the set is not being used by GTT.

```
chg-loopset:name=rtp2:mode=discard
```

This example replaces pc1 with npc1 in the loopset rtp1 if the set is not being used by GTT.

```
chg-loopset:name=rtp1:pc1=3-3-3:npc1=3-3-9
```

This example replaces pc1 and pc2 with npc1 and npc2 in the loopset rtp2 if the set is not being used by GTT.

```
chg-loopset:name=rtp2:pc1=3-2-3:npc1=3-3-9:pc2=7-8-7:npc2=7-7-9
```

This example sets the mode to notify in the loopset rtp2 even if the set is being used by GTT.

```
chg-loopset:name=rtp2:mode=notify:force=yes
```

## Dependencies

If the loopset is being used by GTT, and the **rpcl**, **pc1/pc2/npc1/npc2**, or **mode** parameter is specified, then the **force=yes** parameter must be specified.

If the **pc2** parameter is specified, then the **pc1** parameter must be specified.

If the **npc1** or **npc2** parameter is specified, then the corresponding **pc1** or **pc2** parameter must be specified.

The command requires at least one optional parameter.

The **rpcl** and **apcl** parameters cannot be specified together in the command.

If the **pc1** or **pc2** parameter is specified, then the **apcl** and **rpcl** parameters cannot be specified.

The value of the **name** parameter must already exist in the database.

The SCCP Loop Detection feature must be enabled before this command can be entered.

The GTT feature must be turned on before this command can be entered.

A maximum of 6 point codes can be added using this command with the **apcl** parameter. The Loopset entry can contain a maximum of 12 point codes.

The Loopset table can hold a maximum of 1,000 loopset entries, with each entry containing up to 12 point codes. Additional loopset entries and point codes cannot be added when the table is full.

The values for the **apcl** and **rpcl** parameters cannot consist of any invalid point codes. The valid point codes must be consecutively specified and separated by commas.

The **name=none** parameter cannot be specified.

At least one valid point code must be specified as a value for the **apcl** and **rpcl** parameters.

The values specified for the **apcl** and **rpcl** parameters must be unique.

If the **npc1/pc1** or **npc2/pc2** parameters are specified together, then the value of the **npc** parameter cannot equal the value of the **pc** parameter.

A valid point code must be specified for the **pc1**, **pc2**, **npc1** or **npc2** parameter.

Equal values cannot be specified for the **pc1** and **pc2** parameters.

Equal values cannot be specified for the **npc1** and **npc2** parameters.

When adding point codes using the **apcl** parameter, or changing individual point codes using the **pc1/npc1** or **pc2/npc2** parameters, the new point code type must match the point code type of the loopset where the point codes are being added or changed.

The value of the **apcl** parameter cannot already exist in the loopset.

The value of the **pc1** or **pc2** parameter must already exist in the loopset.

**Output**

The following example replaces the existing point codes with new point codes in the loopset **rtp2** when that set is not being used by GTT.

```
chg-loopset:name=rtp2:pc1=3-2-3:npc1=3-3-9:pc2=7-8-7:npc2=7-7-9
  rlghncxa03w 07-02-10 08:41:17 EST EAGLE Rel 35.6.0
  LOOPSET table is (12 of 1000) 1% full
  CHG-LOOPSET: MASP A - COMPLTD
;
```

**chg-ls****Change Linkset**

Use this command to change the attributes for a specified linkset in the system database. The new values overwrite the existing values. All parameters required for MTP distribution will be used whether they are explicitly specified or obtain from existing provisioning.

**Keyword:** **chg-ls**

**Related Commands:** **chg-lsopts, chg-slt, dlt-ls, rtrv-ls**

**Command Class:** Database Administration

**Parameters**

**NOTE:** See "Point Code Formats and Conversion" for a detailed description of point code formats, rules for specification, and examples.

**:lsn=** (mandatory)

Linkset name. Each linkset name must be unique in the system.

**Range:** *ayyyyyyyyy*

1 alphabetic character followed by up to 9 alphanumeric characters

**:action=** (optional)

This parameter adds or deletes the SAPC, mate IPGWx linkset name, or the value specified for the **rcontext** parameter.

**Range:** **add, delete**

**Default:** No change to current value.

No change to the current value

**System**

**Default:** **add**

**:adapter=** (optional)

This parameter specifies the adapter layer for links provisioned in a IPSG linkset.

**Range:** **m3ua, m2pa**

**Default:** No change to the current value

**System**

**Default:** **m2pa**

**:apc=** (optional)

ANSI point code with subfields *network indicator-network cluster-network cluster member (ni-nc-ncm)*. The *prefix* subfield indicates a private point code (*prefix-ni-nc-ncm*).

**Synonym:** **apca**

**Range:** **p-, 000-255**

Specify a valid value for each subfield of the point code, and separate the subfields with a dash (-).

*prefix—p-*

When **chg-sid:pctype=ansi** is specified, *ni = 000* is not valid.

When **chg-sid:pctype=ansi** is specified, *nc = 000* is not valid if *ni = 001-005*.

When **chg-sid:pctype=ansi** is specified, *nc* = **000** is valid if *ni* = **006-255**.

The point code **000-000-000** is not a valid point code.

**:apc/apca/apci/apcn/apcn24=** (optional)

Adjacent point code.

**:apci=** (optional)

ITU international point code with subfields *zone-area-id*. The *prefix* subfield indicates a spare point code, private point code, or private and spare point code (*prefix-zone-area-id*).

**Range:** **s-, p-, ps-, 0-255**

Specify a valid value for each subfield of the point code, and separate the subfields with a dash (-).

*prefix*—**s-, p-, ps-**

*zone*—**0-7**

*area*—**000-255**

*id*—**0-7**

The point code **0-000-0** is not a valid point code.

**:apcn=** (optional)

ITU national point code in the format of a 5-digit number (*nnnnn*); or 2, 3, or 4 numbers (members) separated by dashes (*m1-m2-m3-m4*) as defined by the **chg-stpopts:npcfmti** flexible point code option. A group code must be specified when the ITUDUPPC feature is turned on (*nnnnn-gc*, *m1-m2-m3-m4-gc*). The *prefix* subfield indicates a spare point code, private point code, or private and spare point code (*prefix-nnnnn*, *prefix-nnnnn-gc*, *prefix-m1-m2-m3-m4*, *prefix-m1-m2-m3-m4-gc*).

**Range:** **s-, p-, ps-, 0-16383, aa-zz**

Specify a valid value for each subfield of the point code, and separate the subfields with a dash (-).

*prefix*—**s-, p-, ps-**

*nnnnn*—**0-16383**

*gc*—**aa-zz**

*m1-m2-m3-m4*—**0-14** for each member; values must sum to 14

**:apcn24=** (optional)

24-bit ITU national point code with subfields *main signaling area-sub signaling area-signaling point* (*msa-ssa-sp*). The *prefix* indicates a private point code (*prefix-msa-ssa-sp*).

**Range:** **p-, 000-255**

Specify a valid value for each subfield of the point code, and separate the subfields with a dash (-).

*prefix*—**p-**

*msa*—**000-255**

*ssa*—**000-255**

*sp*—**000-255**

**:apctype=** (optional)

ITU-N Adjacent Point Code Type. This parameter specifies the format that will be used for changeover and changeover acknowledgement messages.

**Range:** **itun, itunchina**

**itun** — ITU National Adjacent Point Code type

**itunchina** — ITU National China Adjacent Point Code type

**Default:** **itun**

**:asl8=** (optional)

Adjacent SLS 8-bit indicator. This parameter specifies whether the adjacent node is sending MSUs with 8-bit SLSs.

**Range:**     **yes, no**

**Default:**    Current value

**:asnotif=** (optional)

AS notification. This parameter specifies whether AS notifications are sent for an IPSG linkset.

**Range:**     **yes, no**

If the **adapter=m2pa** parameter is specified, then the default value of the **asnotif** parameter is **no**.

If the **adapter=m3ua** parameter is specified, then the default value of the **asnotif** parameter is **yes**.

**Default:**    **yes**

**:bei=** (optional)

Broadcast exception indicator. This parameter specifies whether TFP (transfer prohibited) messages are allowed to be broadcast on the linkset.

**Range:**     **yes, no**

**yes** — TFPs are not broadcast.

**no** — TFPs are broadcast.

**Default:**    Current value

**:cggmod=** (optional)

Calling party GT modification indicator. This parameter specifies whether calling party global title modification is required for the specified linkset.

**Range:**     **yes, no**

**Default:**    No change to the current value

**:cli=** (optional)

Far-end Common Language Location Identifier (CLLI). This parameter specifies the CLLI assigned to the linkset.

**Range:**     ayyyyyyyyyy

1 alphabetic character followed by up to 10 alphanumeric characters

**Default:**    Current value

**:gsmscrn=** (optional)

GSM MAP screening. This parameter specifies whether GSM MAP screening is allowed.

**Range:**     **on, off**

**Default:**    Current value

**:gttmode=** (optional)

Global Title Translation Mode. This parameter specifies a GTT Mode hierarchy for each link set.

**Range:**     **cd, cg, acdcd, acdcg, acdcdcg, cgacdcd, cgcd, cdcg, fcd, fcg, fcg, fcd, fcd, sysdflt**

**cd** — CdPA GTT only

**cg** — CgPA GTT only

**acdcd** — Advanced CdPA GTT, CdPA GTT

**acdcg** — Advanced CdPA GTT, CgPA GTT, CdPA GTT

**acdcdcg** — Advanced CdPA GTT, CdPA GTT, CgPA GTT

**cgacdcd** — CgPA GTT, Advanced CdPA GTT, CdPA GTT

**cgcd** — CgPA GTT, CdPA GTT

**cdcg** — CdPA GTT, CgPA GTT

**fcd** — FLOBR CdPA only

**fcg** — FLOBR CgPA only

**fcgfd** — FLOBR CgPA, FLOBR CdPA  
**fcdfcg** — FLOBR CdPA, FLOBR CgPA  
**sysdfit** — System wide default value

**Default:** No change to current value.

**:gwsa=** (optional)

Gateway screening action. This parameter specifies whether gateway screening (GWS) is on or off for the specified linkset.

**Range:** **on, off**

**Default:** Current value

**:gwsd=** (optional)

Gateway screening MSU discard. This parameter specifies whether the discarding of MSUs that bypass the gateway screening function due to load-shedding is on or off. This parameter is also used with the redirect function; MSUs that cannot be screened are discarded if **gwsd=on** is specified.

**Range:** **on, off**

**Default:** **off**

**:gwsn=** (optional)

Gateway screening messaging. This parameter specifies whether messages are generated for each message screened by gateway screening.

**Range:** **on, off**

**Default:** Current value

**:ipsg=** (optional)

IP signaling gateway adjacent point code. This parameter specifies whether a linkset is entered for an IPSP card. The specified adjacent point code is an IPLIM or IP gateway adjacent point code.

**Range:** **yes, no**

**Default:** **no**

**:iptps=** (optional)

IPGWx Linkset TPS.

The sum of the TPS values assigned to all linksets in the system cannot exceed 500,000.

**Range:** **100-32000**

The specified value must be divisible by 10.

**Default:** No change to current value.

**:islsrsb=** (optional)

Incoming rotated signaling link selection (SLS) bit. This parameter specifies the bit (1–4) for ITU and (1–8) for ANSI link sets to rotate as the new SLS LSB (Least Significant Bit) of the incoming linkset. The SLS is not modified in the outgoing message.

Table 5-18 shows how the rotation affects the four bits of the ITU SLS during linkset selection:

**Table 5-18.** Incoming SLS Bit Rotation for ITU

<b>If This Bit Is Selected...</b>	<b>Then Bit Locations 4 3 2 1 Are Rotated To...</b>	
Bit 4	3 2 1 4	SLS = 0110 becomes Rotated SLS = 1100 SLS = 1011 becomes Rotated SLS = 0111
Bit 3	2 1 4 3	SLS = 0110 becomes Rotated SLS = 1001 SLS = 1011 becomes Rotated SLS = 1110
Bit 2	1 4 3 2	SLS = 0110 becomes Rotated SLS = 0011 SLS = 1011 becomes Rotated SLS = 1101
Bit 1	No rotation is performed because bit 1 is the existing LSB.	

Table 5-19 shows how the rotation affects the eight bits of the ANSI SLS during linkset selection:

**Table 5-19.** Incoming SLS Bit Rotation for ANSI

<b>If This Bit Is Selected...</b>	<b>Then Bit Locations 8 7 6 5 4 3 2 1 Are Rotated To...</b>	
Bit 8	7 6 5 4 3 2 1 8	SLS = 10010110 becomes Rotated SLS = 00101101 SLS = 11001011 becomes Rotated SLS = 10010111
Bit 7	6 5 4 3 2 1 8 7	SLS = 10010110 becomes Rotated SLS = 01011010 SLS = 11001011 becomes Rotated SLS = 00101111
Bit 6	5 4 3 2 1 8 7 6	SLS = 10010110 becomes Rotated SLS = 10110100 SLS = 11001011 becomes Rotated SLS = 01011110



**Table 5-19.** Incoming SLS Bit Rotation for ANSI

<b>If This Bit Is Selected...</b>	<b>Then Bit Locations 8 7 6 5 4 3 2 1 Are Rotated To...</b>	
Bit 5	4 3 2 1 8 7 6 5	SLS = 10010110 becomes Rotated SLS = 01101001 SLS = 11001011 becomes Rotated SLS = 10111100
Bit 4	3 2 1 8 7 6 5 4	SLS = 10010110 becomes Rotated SLS = 11010010 SLS = 11001011 becomes Rotated SLS = 01111001
Bit 3	2 1 8 7 6 5 4 3	SLS = 10010110 becomes Rotated SLS = 10100101 SLS = 11001011 becomes Rotated SLS = 11110010
Bit 2	1 8 7 6 5 4 3 2	SLS = 10010110 becomes Rotated SLS = 01001011 SLS = 11001011 becomes Rotated SLS = 11100101
Bit 1	No rotation is performed because bit 1 is the existing LSB.	

This parameter is used for ITU or ANSI messages on a per-linkset basis.

**Range:** 1-8

ITU linkset—1-4

ANSI linkset—1-8

The **rsls8=yes** parameter must be specified (see the **chg-lsopts** command) before a value greater than 5 can be specified for the **islsrsb** parameter.

**Default:** No change to the current value

**System**

**Default:** 1

**:itutfr=** (optional)

ITU TFR (Transfer Restricted) procedure indicator. This parameter specifies whether the TFR procedure is on or off on a per-linkset basis. This parameter is valid for ITU national linksets only.

**Range:** on, off

**Default:** No change to current value

**:l3tset=** (optional)

Link timer set. This parameter is defined with the **chg-l3t** command.

**Range:** 1

**Default:** No change to current value

**:lst=** (optional)

Linkset type of the specified linkset. This parameter specifies whether the specified link is an access link, bridge link, cross link, diagonal link, or extended link, as defined in Telcordia GR-246-CORE, T1.111.5.

**Range:**     **a, b, c, d, e**  
               **a** — Access links  
               **b** — Bridge links  
               **c** — Cross links  
               **d** — Diagonal links  
               **e** — Extended links  
**Default:**    No change to current value

**:lsusealm=** (optional)

IPTPS linkset alarm threshold percent. This parameter specifies the percent of the linkset TPS (**iptps**) at which an alarm is generated to indicate that the actual linkset TPS is approaching the configured **iptps** value for the linkset.

**Range:**     **10-100**  
**Default:**    No change to current value

**:matelsn=** (optional)

Mate linkset name.

**Range:**     *ayyyyyyyyy*  
               1 alphabetic character followed by up to 9 alphanumeric characters  
**Default:**    No change to current value

**:mtprse=** (optional)

ANSI or ITU MTP Restart equipped. This parameter specifies whether the node adjacent to the linkset is equipped with MTP Restart.

**Range:**     **yes, no**  
               **yes** — equipped  
               **no** — not equipped  
**Default:**    No change to current value

**:multgc=** (optional)

Multiple group codes. The parameter specifies whether multiple group codes can be specified.

**Range:**     **yes, no**

**:nis=** (optional)

Network Indicator Spare. This parameter specifies whether the Network Indicator Spare option is on or off for the specified linkset. When this option is enabled, the Network Spare value for network indicator for both ANSI and ITU-National (ITU-N) links is supported by the system.

**Range:**     **on, off**  
**Default:**    **off**

**:nlsn=** (optional)

New linkset name. This parameter specifies the name to be used when changing the linkset name specified in the **lsn** parameter.

**Range:**     *ayyyyyyyyy*  
               Up to 10 alphanumeric characters; the first character must be a letter  
**Default:**    No change to current value

**:randsls=** (optional)

Random SLS (signaling link selection). This parameter is used to apply random SLS generation on a per linkset basis.

Specifying the **randsls** parameter in the **chg-ls** command enables random SLS generation on a per linkset basis only if the **randsls=perls** parameter has been specified in the **chg-stpopts** command.

**Range:** **off, class0, all**

**off**— Disables random SLS generation on a specified linkset.

**class0**— Enables random SLS generation for Class0 SCCP traffic on a specified linkset.

**all**— Enables random SLS generation for Class0 and Class1 SCCP traffic on a specified ITU linkset and for Class0 and ISUP traffic on a specified ANSI linkset.

**Default:** No change to current value.

No change to the current value

**:rcontext=** (optional)

Routing Context. This parameter specifies a new routing context for an IPSG-M3UA linkset.

**Range:** **0-4294967295**

**Default:** No change to current value

**:sapci=** (optional)

ITU international secondary adjacent point code with subfields *zone-area-id*. The *prefix* subfield indicates a spare point code, private point code, or private and spare point code (*prefix-zone-area-id*).

**Range:** **s-, p-, ps-, 0-255**

Specify a valid value for each subfield of the point code, and separate the subfields with a dash (-).

*prefix*—**s-, p-, ps-**

*zone*—**0-7**

*area*—**000-255**

*id*—**0-7**

The point code **0-000-0** is not a valid point code.

**:sapci/sapcn/sapcn24=** (optional)

Secondary adjacent point code.

**:sapcn=** (optional)

ITU national secondary adjacent point code in the format of a 5-digit number (*nnnnn*); or 2, 3, or 4 numbers (members) separated by dashes (*m1-m2-m3-m4*) as defined by the **chg-stpopts:npcfmti** flexible point code option. A group code must be specified when the ITUDUPPC feature is turned on (*nnnnn-gc, m1-m2-m3-m4-gc*). The *prefix* subfield indicates a spare point code, private point code, or private and spare point code (*prefix-nnnnn, prefix-nnnnn-gc, prefix-m1-m2-m3-m4, prefix-m1-m2-m3-m4-gc*).

**Range:** **s-, p-, ps-, 0-16383, aa-zz**

Specify a valid value for each subfield of the point code, and separate the subfields with a dash (-).

*prefix*—**s-, p-, ps-**

*nnnnn*—**0-16383**

*gc*—**aa-zz**

*m1-m2-m3-m4*—**0-14** for each member; values must sum to 14

**:sapcn24=** (optional)

24-bit ITU national secondary adjacent point code with subfields *main signaling area-sub signaling area-signaling point* (*msa-ssa-sp*). The *prefix* indicates a private point code (*prefix-msa-ssa-sp*).

**Range:** **p-, 000-255**

Specify a valid value for each subfield of the point code, and separate the subfields with a dash (-).

*prefix*—**p**

*msa*—**000–255**

*ssa*—**000–255**

*sp*—**000–255**

**:scrn=** (optional)

Gateway screening screen set. This parameter specifies the gateway screening screen set assigned to this linkset.

When using the **scrn** parameter to change Gateway Screening from an old screenset name with Gateway Screening Allowed Mode **gwsa=off** to a new screenset name with **gwsa=on**, the command must first be entered to assign the screenset name to NONE (**scrn=none**). This assignment will prevent any rules from the old screenset from being applied during the interim period that it takes for the new screenset to load.

**Range:** *ayyy*  
1 alphabetic character followed by up to 3 alphanumeric characters or none (deletes screen set association)

**Default:** No change to current value

**:slktps=** (optional)

Per signaling link TPS. This parameter is specified for each link provisioned in a specified IPSP linkset.

The sum of the TPS values assigned to all linksets in the system cannot exceed 500,000.

**Range:** **100-5000**

**:slkusealm=** (optional)

IPSP signaling link alarm threshold percent. This parameter specifies the percent of the link "fair share" TPS at which an alarm is generated to indicate that the actual link TPS is approaching the link's "fair share" of its linkset's configured TPS (**iptps**). The "fair share" of the linkset TPS for a link is the configured linkset TPS divided by the number of in-service links in the linkset.

**Range:** **10-100**

**Default:** No change to current value

**:slsci=** (optional)

5-bit to 8-bit SLS conversion indicator. This parameter specifies whether the 5-bit to 8-bit SLS conversion feature is used to select links for outgoing messages direct to the given linkset. When enabled, the system replaces any 5-bit SLS values contained in received messages, with a random 8-bit value before the 5-bit SLS values are used by the STP to select the outgoing link in that linkset.

**Range:** **yes, no**  
**yes** — enabled  
**no** — disabled

**Default:** No change to current value.

**:slsocbit=** (optional)

Other CIC (Circuit Identification Code) Bit. If the SLSOCB feature is turned on, this parameter specifies whether the Other CIC Bit option is to be used during link selection. If the option is to be used, specify which bit (5– 16) of the CIC is to be used as the other CIC bit. During link selection, the specified bit acts as the most significant bit of the new SLS and bits 2 through 4 of the received CIC become the least significant bits of the new SLS. This parameter is used for ITU-ISUP messages. The SLS is not modified in the outgoing message. The following example shows a received CIC where bit 9 is the other CIC bit (**slsocbit=9**). The new SLS is 0100:

<b>16</b>	<b>15</b>	<b>14</b>	<b>13</b>	<b>12</b>	<b>11</b>	<b>10</b>	<b>9</b>	<b>8</b>	<b>7</b>	<b>6</b>	<b>5</b>	<b>4</b>	<b>3</b>	<b>2</b>	<b>1</b>
0	0	0	0	1	0	0	0	1	0	0	1	1	0	0	1
New SLS							0					1	0	0	

**Range:** 5-16 none  
**Default:** No change to current value

**:slrsb=** (optional)  
 Rotated SLS (Signaling Link Selection) Bit. This parameter specifies the bit (1–4) to rotate as the new SLS LSB (Least Significant Bit). The SLS is not modified in the outgoing message. Table 5-20 shows how the rotation affects the four bits of the SLS during linkset selection:

**Table 5-20.** SLS Bit Rotation

If This Bit Is Selected...	Then Bit Locations 4 3 2 1 Are Rotated To...	
Bit 4	3 2 1 4	SLS = 0110 becomes Rotated SLS = 1100 SLS = 1011 becomes Rotated SLS = 0111
Bit 3	2 1 4 3	SLS = 0110 becomes Rotated SLS = 1001 SLS = 1011 becomes Rotated SLS = 1110
Bit 2	1 4 3 2	SLS = 0110 becomes Rotated SLS = 0011 SLS = 1011 becomes Rotated SLS = 1101
Bit 1	No rotation is performed because bit 1 is the existing LSB.	

This parameter is used for ITU messages on a per-linkset basis.

**Range:** 1-4  
**Default:** No change to current value.

**:sltset=** (optional)  
 SLTM record. This parameter specifies the SLTM record to be associated with the linkset.

**Range:** 1-20  
**Default:** No change to current value.

**:spc=** (optional)  
 ANSI secondary point code with subfields *network indicator-network cluster-network cluster member (ni-nc-ncm)*.

**Range:** 000-255, none

Specify a valid value for each subfield of the point code, and separate the subfields with a dash (-).

When **chg-sid:pctype=ansi** is specified, *ni* = **000** is not valid.

When **chg-sid:pctype=ansi** is specified, *nc* = **000** is not valid if *ni* = **001-005**.

When **chg-sid:pctype=ansi** is specified, *nc* = **000** is valid if *ni* = **006-255**.

Enter **none** to delete the point code.

The point code **000-000-000** is not a valid point code.

**:spc/spca/spci/spcn/spcn24=** (optional)

Secondary point code.

**:spci=** (optional)

ITU international secondary point code with subfields *zone-area-id*. The *prefix* subfield indicates a spare point code (*prefix-zone-area-id*).

**Range:** **s-, 0-255, none**

Specify a valid value for each subfield of the point code, and separate the subfields with a dash (-).

*prefix*—**s-**

*zone*—**0-7**

*area*—**000-255**

*id*—**0-7**

Enter **none** to delete the point code.

The point code **0-000-0** is not a valid point code.

**:spcn=** (optional)

ITU national secondary point code in the format of a 5-digit number (*nnnnn*); or 2, 3, or 4 numbers (members) separated by dashes (*m1-m2-m3-m4*) as defined by the **chg-stpopts:npcfmti** flexible point code option. A group code must be specified when the ITUDUPPC feature is turned on (*nnnnn-gc*, *m1-m2-m3-m4-gc*). The *prefix* subfield indicates a spare point code (*prefix-nnnnn*, *prefix-nnnnn-gc*, *prefix-m1-m2-m3-m4*, *prefix-m1-m2-m3-m4-gc*).

**Range:** **s-, 0-16383, aa-zz, none**

Specify a valid value for each subfield of the point code, and separate the subfields with a dash (-).

*prefix*—**s-**

*nnnnn*—**0-16383**

*gc*—**aa-zz**

*m1-m2-m3-m4*—**0-14** for each member; values must sum to 14

Enter **none** to delete the point code.

**:spcn24=** (optional)

24-bit ITU national secondary point code with subfields *main signaling area-sub signaling area-signaling point* (*msa-ssa-sp*).

**Range:** **000-255, none**

Specify a valid value for each subfield of the point code, and separate the subfields with a dash (-).

*msa*—**000-255**

*ssa*—**000-255**

*sp*—**000-255**

Enter **none** to delete the point code.

**:tfatcabmlq=** (optional)

TFA/TCA broadcast minimum link quantity. This parameter specifies the minimum number of links in the given linkset, or in the combined linkset in which the linkset resides, that must be available to user-part messages traffic. This parameter value is used by the STP to consider the first-choice ordered routes using that linkset as Allowed rather than Restricted.

If the **tfatcabmlq** parameter provisioned or default value is **0**, then the TFA/TCA broadcast minimum link quantity is calculated by the EAGLE 5 ISS to be either **1** for linksets containing 2 or fewer links, or half (rounded-up) of the number of links configured in the linkset for linksets containing more than 2 links.

If the **tfatcabmlq** parameter value is set to a specific value greater than **0**, then the EAGLE 5 ISS does not calculate a TFA/TCA broadcast minimum link quantity. The specified value is used.

If the **lsrestrict** option is **off** (see the **chg-ss7opts** command), then the **tfatcabmlq** database value for C linksets cannot be changed to a value greater than **0**. If the **lsrestrict** option is **on** (see the **chg-ss7opts** command), then the **tfatcabmlq** value for C linksets (**lst=c**) can be set to a value from **1** to **16**. If the **tfatcabmlq** value for one or more C linksets in the system is changed, then the **lsrestrict** option cannot be set from **on** to **off** until all of the changed C linkset **tfatcabmlq** values are changed back to **0**.

**NOTE:** The **rtrv-ls** command output always shows the calculated value or the provisioned value for the **tfatcabmlq** parameter. See the **rtrv-ls** command description.

**Range:** 0, 1-16  
**Default:** No change to current value.  
**System**  
**Default:** 0

### Example

Changes link set wy644368 to use APC 144-202-5

```
chg-ls:lsn=wy644368:apc=144-202-005
```

Changes link set wy644368 to Link Set Type A

```
chg-ls:lsn=wy644368:lst=a
```

Changes link set wy644370 to use APCN24 10-100-15

```
chg-ls:lsn=wy644370:apcn24=10-100-15
```

Adds an SAPC to a linkset

```
chg-ls:lsn=linkset:sapcn=1234-fr:action=add
```

Deletes an SAPC from a linkset

```
chg-ls:lsn=linkset:sapcn=1234-fr:action=delete
```

Modifies an SAPC, sapc has to be deleted first and added again

```
chg-ls:lsn=nc001:apc=144-201-001
```

```
chg-ls:lsn=c002:gwsm=on: nis=on
```

```
chg-ls:lsn=nc002:gwsm=on
```

```
chg-ls:lsn=nc003:sltm=reg:lst=b
```

Adds a 24-bit ITU-N SAPC to a linkset

```
chg-ls:lsn=ls1:sapcn24=5-5-5
```

Deletes a 24-bit ITU-N SAPC from a linkset:

```
chg-ls:lsn=ls1:sapcn24=5-5-5:action=delete
```

Assigns a mate linkset to a linkset:

```
chg-ls:lsn=linkset:matelsn=matelinkset
```

```
chg-ls:lsn=linkset:matelsn=matelinkset:action=add
```

Removes a mate linkset assignment from a linkset:

```
chg-ls:lsn=linkset:matelsn=matelinkset:action=delete
```

Changes an ITUN24 linkset to an apcntype for China:

```
chg-ls:lsn=ls2:apcntype=itunchina
```

Changes an ITUN24 linkset to an apcntype for Q703.A:

```
chg-ls:lsn=ls2:apcntype=itun
```

Additional examples:

```
chg-ls:lsn=nc003:slsci=yes:tfatcabmlq=2
```

```
chg-ls:lsn=lsitu1:gsmscrn=off
```

```
chg-ls:lsn=wy644370:apcn24=10-100-15
```

```
chg-ls:lsn=ls1:sapcn24=5-5-5
```

```
chg-ls:lsn=ls1:sapcn24=5-5-5:action=delete
```

```
chg-ls:apca=p-011-2-3:lsn=lsa1:lsta=a
```

```
chg-ls:apci=s-1-2-3:lsn=lsn1:lsta=c
```

```
chg-ls:apcn= ps-1-1-1-2047:lsta=a
```

```
chg-ls:lsn=ls1:randsls=all
```

Indicates that calling party GT modification is required

```
chg-ls:lsn=ls1:apc=1-1-1:cggtmod=yes
```

Changes the linkset's SPC value.

```
chg-ls:lsn=ls1:spc=100-23-48
```

Changes the adapter of a specified IPSP linkset.

```
chg-ls:lsn=ls2:adapter=m2pa
```

Changes the AS notification status and routing context value for an IPSP-M3UA linkset.

```
chg-ls:lsn=m3ua33:rcontext=9999:action=add
```

Deletes the routing context value for the IPSP-M3UA linkset.

```
chg-ls:lsn=m3ua33:action=delete:rcontext=2000
```

Converts the linkset to IPSP.

```
chg-ls:lsn=m2pa33:ipsp=yes
```

This command changes the Incoming SLS Bit Rotation value to 6 for ANSI link sets

```
chg-ls:lsn=ls1:islsrsb=6
```

Changes the gttmode value to FLOBR CdPA when the FLOBR feature is turned on.

```
chg-ls:lsn=ls3:gttmode=fcd
```

## Dependencies

A valid screenset name must be associated with the linkset, or the **scrn** parameter must be specified with a valid screenset name before the **gwsa**, **gwsn**, and **gwsd** parameters can be specified.

The **gwsd=on** parameter can be specified only if the **gwsa=on** parameter is specified.

At least one optional parameter must be specified.



If the **lsrestrict** option is **off** (see the **chg-ss7opts** command), the **tfatcabmlq** database value for C linksets cannot be changed from the system default of **0**. If the **lsrestrict** option is **on** (see the **chg-ss7opts** command), the **tfatcabmlq** value for C linksets (**lst=c**) can be set to a value from **1** to **16**. If you change the **tfatcabmlq** value for one or more C linksets in the system, you cannot set the **lsrestrict** option from **on** to **off** until you set all of the changed C linkset **tfatcabmlq** values back to **0**. C linksets are never the primary route (except to reach the STP's mate).

The **tfatcabmlq** parameter value cannot exceed the total number of assigned links in the linkset.

The **slsci** parameter cannot be specified for X25 linksets.

The linkset name must be in the database.

The screen set name specified by the **scrn** parameter must be valid and must be in the database.

Adjacent point codes must be full point codes.

The adjacent point code must be defined as a destination point code.

The adjacent point code cannot match the site point code.

If the adjacent point code is in the X.25 domain, the **bei=yes** parameter must be specified or the **bei** parameter must be omitted.

The domain of the new adjacent point code must be the same as the previous adjacent point code unless there are no links in the linkset.

The adjacent point code cannot be referenced by an X.25 route with the **lc2nm=yes** parameter specified.

Only one linkset can be defined for an adjacent point code.

An SAPC cannot be deleted when routes exist for its SS7 domain.

If the **gwsa=off** and **gwsn=off** parameters are specified, all MSUs are passed. If the **gwsa=off** and **gwsn=off** parameters are specified for all linksets, gateway screening and the GWS redirect function for the DTA feature are disabled.

If the **gwsa=on** and **gwsn=off** parameters are specified, MSUs are screened but messages are not generated.



**CAUTION:** Even though gateway screening is in the screen test mode, as defined by the parameters **gwsa=off** and **gwsn=on**, the gateway screening action in the stop action set specified by the **actname** parameter of the screen set *will* be performed at the end of the screening process.

The **mtrse** parameter can be specified only if the MTP restart feature, MTPRS (for ANSI), or ITUMTPRS (for ITU), is turned on. The **rtrv-feat** command can be used to verify whether the feature is turned on (MTPRS=YES or ITUMTPRS=YES in the output).

If the **ipgwapc=yes** or **ipsg=yes** parameter is specified, then the **mtrse=yes** parameter cannot be specified.

The **mtrse=yes** parameter is not valid for IPGWx and IPSP-M3UA signaling links.

The **clli** parameter and the **apc/apca/apci/apcn/apcn24** parameter must be specified together in the command.

The value of the **cilli** parameter must match the **cilli** of the current site.

The **asl8=yes** parameter can be assigned only to an SS7 linkset (a linkset containing an adjacent point code in the SS7 domain).

The **apcn** parameter format must match the format that was assigned with the **chg-stpopts:npcfmti** parameter.

An SAPC parameter can be specified only for ITU-N and ITU-N24 linksets.

The **slsobit** parameter is valid only for ITU linksets.

The **slrsrb** parameter is valid only for ITU linksets.

The GSM Map Screening feature must be turned on before the **gmscrn** parameter can be specified (see the **enable-ctrl-feat** and **chg-ctrl-feat** commands).

The Enhanced GSM Map Screening feature must be turned on before the **gmscrn=on** parameter can be specified for an ANSI linkset.

The **itutfr** parameter is valid only for ITU national linksets.

The group code of DPC(s) must match the group code of the APC/SAPC when the **multgc=no** parameter is specified. If the adjacent point code's group code is changed, the **multgc=yes** parameter must be specified, or there must be no routes using the linkset. The **multgc** parameter value can be changed to **no** only if there are no routes with group codes different from the adjacent point code's group code.

Only one ITU-N APC/SAPC is allowed with the **multgc=no** parameter.

Only one ITU-I or 24-bit ITU-N APC/SAPC is allowed per linkset

The **apctype** parameter can be specified only for ITU-N and ITU-N24 linksets.

A linkset cannot have both a 14-bit ITU-N and a 24-bit ITU-N APC/SAPC unless it contains only IPGWI links or IPLIM M3UA links. These links support 14-bit ITU-N and 24-bit ITU-N traffic simultaneously. A linkset with the **ipgwapc=no** parameter cannot have both a 14-bit ITU-N and a 24-bit ITU-N APC/SAPC if no links are provisioned. The SAPC cannot be a 24-bit ITU-N point code if the linkset contains IPLIM or E1 ATM links, which do not support 24-bit ITU-N traffic.

Private (**p-**) and private and spare (**ps-**) point codes can be assigned only to IPGW linksets (the **ipgwapc=yes** parameter is specified).

The **iptps** parameter cannot be specified for linksets that are not IPGWx.

The total of the **iptps** parameter values for all linksets cannot exceed the IPGWx Signaling TPS feature quantity that is enabled in the system.

The **ipgwapc=yes** or **ipsg=yes** parameter must be specified before the **lsusealm** parameter can be specified.

The **ipgwapc=yes** or **ipsg=yes** parameter must be specified before the **slkusealm** parameter can be specified.

The specified linkset name (**lsn**) cannot be the same as the specified mate linkset name (**matelsn**).

If the **action=add** parameter is specified, the specified mate linkset cannot already be assigned as the mate of the specified linkset.

When the **action=add** parameter is specified, the specified mate linkset cannot already be the mate of another linkset.

The specified mate linkset must be an existing linkset in the database.

A mated linkset can have only one assigned link.

Mated linksets can contain only SS7IPGW or IPGWI links.

Mated linksets must have APCs of the same network type.

The card that has the link assigned to the specified linkset must be inhibited before the **action=add** parameter can be specified to assign the specified mate linkset to the specified linkset.

The card that has a link in the mate linkset must be inhibited before the **action=delete** parameter can be specified to delete the mate linkset assignment.

If the **action=delete** parameter is specified to delete a mate linkset assignment, the specified mate linkset must be the mate of the specified linkset in the database.

If the **action=delete** parameter is specified, then the **sapc**, **matelsn**, or **rconext** parameter must be specified. The parameters cannot be specified together in the command.

The **mtrprse** parameter can be specified only if the MTP restart feature ITUMTPRS (for ITU) is turned on. The **rtrv-feat** command can be used to verify whether the feature is turned on (ITUMTPRS=YES in the output).

The **slsobit** parameter is valid only if the SLSOCB feature is turned on.

The adjacent point code cannot match the capability point code.

An APC cannot be changed to a point code that has exception routes provisioned

The **apc** or **sapc** parameter cannot be specified for an IPGWx linkset that is already assigned to a route involving another linkset.

The Origin-based SCCP Routing feature must be turned on before the **gttmode** parameter can have a value of **acded**, **cgacded**, **acdcged**, **acdedcg**, **cgcd**, **cdcg**, or **cg**.

The APC/SAPC of an existing IPGW link set cannot be changed to an APC/SAPC that is already configured in a routing key.

All links assigned to the linkset must be removed before changing the **apctype** parameter value from **apcn** to **apcn24** or from **apcn24** to **apcn**.

If one or more of the links in the specified linkset are in service, then the **apc/apca/apci/apcn/apcn24** parameter cannot be specified.

If **apcn** is specified for the Adjacent Point Code then the format of **apcn** must match the format dictated by the **n pcfmti** parameter via the **chg-stpopts** command.

Linksets can be configured only from an OAP terminal, not from an EAGLE 5 ISS terminal.

If the system is configured for ANSI formatted point code, the network indicator value of the foreign pointcode parameter must be 6 or greater when the cluster value is 0.

The value of the **apc/apca/apci/apcn/apcn24** or **sapc/sapca/sapci/sapcn/sapcn24** parameter cannot be assigned to more than one linkset.

The new **apc/apca/apci/apcn/apcn24** parameter must have the same point code type as the **apc/apca/apci/apcn/apcn24** parameter currently specified for the linkset.

The value of the **apc/apca/apci/apcn/apcn24** parameter must exist in the Point Code table.

The **lst** parameter must have a value of **b**, **c**, or **d** if a network or cluster route is configured through the linkset.

If the **multgc=yes** parameter is specified, then an IPGWI or IPLIMI link must be specified.

If the ITUDUPPC feature is off, then the **multgc=yes** parameter cannot be specified.

If the **multgc=yes** parameter is specified, then the **apci**, **apcn**, or **apcn24** parameter must be specified.

The value of the **sapc/sapca/sapci/sapcn/sapcn24** parameter must exist in the Destination Point Code table.

The **apc/apca/apci/apcn/apcn24** or the **sapc/sapca/sapci/sapcn/sapcn24** parameter can be defined only once per linkset.

The maximum number of **sapc/sapca/sapci/sapcn/sapcn24** entries has been exceeded.

The value of the specified **lsn** parameter already exists in the database.

The specified **matelsn** parameter be already equipped in the linkset database.

If the linkset is not mated to the linkset specified by the **matelsn** parameter, then **action=delete** parameter cannot be specified.

The value specified for the **spc** parameter must be a valid full point code.

The values specified for the **spc** and **apc** parameters must have the same network type.

If the **sapc**, **matelsn**, **rcontext**, or **action** parameter is specified, then those four parameters are the only optional parameters that can be specified. If the **action** parameter is specified, then the **sapc** or

**rcontext** or **matelsn** parameter must be specified. If the **ipsg** parameter is specified, then no other optional parameters can be specified.

The Multiple Linksets to Single Adjacent PC (MLS) feature must be turned on before the **spc** parameter can be specified.

The value specified for the **spc** parameter must already exist in the SPC table.

The point code type of the value specified for the **spc** parameter must be the same as the point code type of the value of the existing **spc** parameter.

The value specified for the **spc** parameter cannot already be specified as a secondary point code for an adjacent destination point code.

The value specified for the **apc** parameter must differ from the adjacent point code of the linkset specified by the **lsn** parameter.

The value specified for the **spc** parameter must differ from the secondary point code of the linkset specified by the **lsn** parameter.

If a proxy linkset is used, then the **apc**, **sapc**, **action**, and **lst** parameters cannot be specified.

An IPGW linkset cannot be moved to a node that already contains a linkset.

If an IPGW linkset is used, then the value specified for the **apc** parameter cannot be associated with a proxy point code.

If the **ipgwapc=yes** parameter is specified, then the **spc** parameter cannot be specified.

The specified combination of the **apc** and **spc** parameters must be unique for each linkset.

The specified combination of the **apc** and **sapc** parameters must be unique for each linkset.

The AMGTT feature or the AMGTT CgPA Upgrade feature must be turned on before the **cggtmod** parameter can be specified.

The **ipgwapc=yes** parameter and the **ipsg=yes** parameter cannot be specified together in the command.

The **ipsg=yes** parameter must be specified before the **adapter** parameter can be specified.

The **ipsg=yes** and **adapter=m3ua** parameters must be specified before the **asnotif** parameter can be specified.

The **ipsg=yes** and **adapter=m3ua** parameters must be specified before the **rcontext** parameter can be specified.

If the IPSG linkset contains links, then the **adapter** parameter cannot be specified.

The **ipgwapc=yes** parameter must be specified before the value specified for the **apc** parameter can be an invalid point code (ANSI network = 0).

The **ipgwapc=yes** parameter must be specified before the **iptps** parameter can be specified.

The value specified for the **iptps** parameter must be divisible by 10.

The **ipsg=yes** parameter must be specified before the **slktps** parameter can be specified.

If the **ipsg=yes** and **adapter=m3ua** parameters are specified, then the **lst=a** parameter must be specified.

A maximum of 1 IPGW linkset or maximum of 6 of any other linksets are allowed between any APC and the EAGLE 5 ISS.

The total capacity assigned to any card hosting a signaling link assigned to the specified linkset cannot exceed the total maximum capacity (5000 TPS) of the card.

The value specified for the **iptps** parameter cannot cause the card to exceed the total maximum capacity (5000 TPS) of the card.

If the **ipsg=yes** and **adapter=m3ua** parameters are specified, then the **multgc=yes** parameter cannot be specified.

If the **ipsg=yes** and **adapter=m3ua** parameters are specified, then the **tfatcabmlq** parameter cannot be specified.

If the **action=delete** parameter is specified to delete the routing context, then the value specified for the **rcontext** parameter must be the value used by the specified linkset in the database.

If the linkset already contains IPSG links, then the **ipsg=no** parameter cannot be specified.

If the **ipsg=yes** and **adapter=m3ua** parameters are specified, then a secondary adjacent point code cannot be specified for the linkset.

The **ipsg=yes** and **adapter=m3ua** parameters must be specified before the **slktps** parameter can be specified.

If one or more links in a specified linkset are in service, then the **rcontext** parameter cannot be specified.

Multiple signaling links in a single linkset cannot share the same association.

If multiple linksets share an association, then the **rcontext** parameter cannot be specified for only one linkset.

The value specified for the **rcontext** parameter must already exist in the database.

If a linkset shares an association with another linkset, then a unique value for the **rcontext** parameter must be specified for each linkset.

If the **ipsg=yes** parameter is specified, then the **slktps** parameter must be specified.

If the **multgc=yes** parameter is specified, then all links assigned to the linkset must be of the same type.

If any of the links are not in the OOS state, then the **rcontext** parameter cannot be specified.

The ISLSBR feature must be enabled before the **islsrsb** parameter can be specified.

The FLOBR feature must be turned on before the **gttmode** parameter can have a value of **fed**, **fcg**, **fcgfd**, or **fedfcg**.

The **rsls8=yes** parameter (see the **chg-lsopts** command) must be specified for an ANSI linkset before a value greater than **5** can be specified for the **islsrsb** parameter.

If an ITU linkset is used, then a value of **1–4** must be specified for the **islsrsb** parameter.

## Notes

Any optional parameter that is not specified is not changed.

The links that directly connect the system with a distant node are grouped into one or more linksets. A linkset can contain up to 8 (international standards) or 16 (national standard) signaling links, depending on how the system attributes were defined when the network was created.

Signaling link test acknowledgments (SLTA) are the same type of maintenance message as the SLTMs received on the link.

MTP restart provides an orderly process for bringing signaling links back into service after the system has been isolated and restarted. A greater preference is given to restoring the STP to network service in an orderly fashion than to the speed of recovery. The time required is system-dependent. Table 5-21 provides examples of some approximate times.

**Table 5-21.** Link Alignment Performance

System Size (No. of LIMs)	Link Alignment Delay (seconds)
up to 64	62
64 to 127	97
128 to 191	132
more than 191	167

When two linksets are used as a combined linkset, each linkset should have the same **slsci** and **asl8** values. **This is not enforced in the system and there is no warning mechanism if the values of these parameters are not the same for each linkset.**

The **tfacabmlq** parameter is not supported for linksets that terminate in the X.25 domain.

The **slsrbs** parameter alone does not provide an even distribution of ITU-ISUP messages across all links within a linkset. The system uses all four bits of the SLS to determine the actual link to route messages. Because the static bit is simply rotated within the SLS, all possible values of the SLS field will still not be realized. The **slsocbit** parameter must also be used to provide an even distribution across all links within the linkset. If both parameters are used for a given linkset, the SLS field is processed in the following order.

1. The SLS is modified using the Other CIC Bit option.
2. The modified SLS is modified again using the Rotated SLS Bit option.
3. The modified SLS is used by the existing linkset and link selection algorithms to select a link.
4. The ISUP message is sent out of the link containing the original, unmodified SLS field.

To modify a secondary adjacent point code, **sapc** has to be first deleted, then added again.

A 24-bit ITU-N point code can be provisioned as an SAPC only if the APC is not already a 24-bit ITU-N point code.

Only one 24-bit ITU-N point code is allowed to be provisioned as an SAPC.

For a linkset containing either low speed CCS7ITU links or IPLIM M2PA links, if the APC is a 14-bit ITU-N point code, then a 24-bit ITU-N point code cannot be provisioned as an SAPC.

For a linkset containing either low speed CCS7ITU links or IPLIM M2PA links, if the APC is a 24-bit ITU-N point code, then a 14-bit ITU-N point code cannot be provisioned as a SAPC.

For a linkset containing either low speed CCS7ITU links or IPLIM M2PA links, if the APC is a ITU-I point code, then either a 24-bit ITU-N point code or a 14-bit ITU-N point code can be provisioned as an SAPC, but not both

In this command, only ITU-international and ITU national point codes support the spare point code subtype prefix (**s-**) and the private and spare point code subtype prefix (**ps-**). All of the point code types support the private (internal) point code subtype prefix (**p-**).

The ITU National and ITU National China Adjacent Point Code types indicate the format that is used for changeover and changeover acknowledgement messages. China specifies a 16-bit field for data in changeover messages. The FSN occupies the first 12 bits. The trailing 4 bits are spare and are coded as 0. ITU uses a 24-bit field for data in the extended changeover/changeover acknowledgement

messages. The FSN is encoded in the first 12 bits. The last 12 bits of the field are spare and are coded as zero.

The **randsls** parameter value applies to SCCP ITU-T messages and Class0 and ISUP ANSI messages when random SLS generation is set to occur on a per linkset basis (the **randsls=perls** parameter is specified in the **chg-stpopts** command).

If the **randsls=perls** parameter is specified in the **chg-stpopts** command, it is recommended that the linksets in a combined linkset be provisioned with the same **randsls** value to avoid undesired SLS distribution.

The **lc2nm** parameter in the X.25 route commands allows the system to apply network management procedures to X.25 logical channels. If an X.25 logical channel fails, then network management reroutes messages to an alternate route.

The **tfatcabmlq=0** parameter specifies that the system broadcasts TFAs or TCAs only when half the links in the given linkset, or in the combined linkset in which it resides, become available.

A gateway linkset can be configured only from a SEAS terminal and not from a system terminal.

If the **gwsa=off** and **gwsn=on** parameters are specified, then all MSUs pass. Error messages are generated if an MSU matches a screening condition.

If the **gwsa=on** and **gwsn=off** parameters are specified, then MSUs are screened but messages are not generated.

If the **gwsa=off** and **gwsn=on** parameters are specified, then gateway screening is defined to be in the screen test mode. The gateway screening action in the stop action set specified by the **actname** parameter of the screen set is performed at the end of the screening process.

If the **asl8=yes** and the **lst=a** (a linkset containing access signaling links) parameters are specified, then the originator of the MSUs is generating 8-bit SLSs. For other linkset types, the **asl8=yes** parameter indicates that the adjacent STP is converting 5-bit SLSs to 8-bit SLSs. The SLS in MSUs received by the system on a linkset that has the **asl8=yes** parameter assigned is not converted. These MSUs are assumed to contain 8-bit SLSs.

If the **gwsa=on**, **gwsn=on**, and **gwsd=off** parameters are specified, then MSUs are screened, and error messages are generated if an MSU is passed when it should have been screened.

If the ISLSBR feature is turned on, and Incoming SLS Bit Rotation is applied to an MSU, then the outgoing SLS bit rotation is not applied for that MSU. If the ISLSBR feature is turned off, or Incoming SLS Bit Rotation is not applied to an MSU, then the outgoing SLS bit rotation is applied for that MSU.

The valid ISLSRSB values are **1–4** for ITU linksets and **1–8** for ANSI linksets.

The **randsls** parameter is applied on incoming linksets for ANSI messages and on outgoing linksets for ITU messages.

## Output

The following example displays the output that results if the secondary point code is changed.

```
chg-ls:lsn=ls1:spc=100-23-48
rlghncxa03w 07-07-18 08:16:14 EST EAGLE 37.5.0
CAUTION: Linkset SPC has changed - verify remote node's route.
Link set table is (114 of 1024) 1% full
```

```
CHG-LS: MASP A - COMPLTD
```

The following example displays the command output when GTT mode is changed to FLOBR CdPA.

```
chg-ls:lsn=ls3:gttmode=fcd
tekelecstp 09-04-12 13:34:33 EST EAGLE 41.0.0
Link set table is (5 of 1024) 1% full.
```

```
CHG-LS: MASP A - COMPLTD
```

```
;
```

**chg-lsopts****Change Linkset Options**

Use this command to administer the thresholds for IPSPG-M3UA linksets and to set SLS bit rotation for ANSI linksets.

**Keyword:** **chg-lsopts**

**Related Commands:** **chg-ls, rtrv-ls**

**Command Class:** Database Administration

**Parameters**

**:lsn=** (mandatory)

Linkset name. This parameter specifies the name of the linkset. Each linkset name must be unique in the system.

**Range:** *ayyyyyyyyy*

1 alphabetic character followed by up to 9 alphanumeric characters.

**:icnimap=** (optional)

Incoming NI Map. This parameter specifies the NI mapping for incoming MSUs on a linkset. The NI value in the incoming MSU is changed to the value specified by the **icnimap** parameter before processing the message.

**Range:** **itui2ituis, ituis2itui, itun2ituns, ituns2itun, none**

**itui2ituis** — Map ITU International to ITU International Spare

**ituis2itui** — Map ITU International Spare to ITU International

**itun2ituns** — Map ITU National to ITU National Spare

**ituns2itun** — Map ITU National Spare to ITU National

**none** — NI mapping is not performed on the specified linkset.

**Default:** No change to the current value

**System**

**Default:** **none**

**:numslkalw=** (optional)

Number of signaling links allowed. This parameter specifies the IS-NR link count threshold required for an IPSPG-M3UA linkset to transition from the Restricted or Prohibited state to the Allowed state.

When the number of IS-NR links in an IPSPG-M3UA linkset transitions from a value less than **numslkalw** to a value equal to or greater than **numslkalw**, the linkset transitions to the allowed state.

**Range:** **0-16**

**0**—The IS-NR link count threshold value for an IPSPG-M3UA linkset is considered to be half of the number of links configured in the linkset.

**Default:** No change to current value

**System**

**Default:** **1**

**:numslkproh=** (optional)

Number of signaling links required to prohibit a linkset. This parameter specifies the IS-NR link count threshold required for an IPSPG-M3UA linkset to transition from the Restricted or Allowed state to the Prohibited state.

When the number of IS-NR links in an IPSPG-M3UA linkset transitions from a value equal to or greater than **numslkproh** to a value less than **numslkproh**, the linkset transitions to the Prohibited state.

**Range:** **0-16**

**0**—The IS-NR link count threshold value for an IPSPG-M3UA linkset is considered to be half of the number of links configured in the linkset.

**Default:** No change to current value



**System****Default:** 1**:numslkrstr=** (optional)

Number of signaling links required to restrict a linkset. This parameter specifies the IS-NR link count threshold required for an IPSPG-M3UA linkset to transition from the Allowed state to the Restricted state.

When the number of IS-NR links in an IPSPG-M3UA linkset transitions from a value equal to or greater than **numslkrstr** to a value less than **numslkrstr** and greater than **numslkproh**, the linkset transitions from the Allowed state to the Restricted state. Transition from the Prohibited state to the Restricted state is not supported.

**Range:** 0-16

0—The IS-NR link count threshold value for an IPSPG-M3UA linkset is considered to be half of the number of links configured in the linkset.

**Default:** No change to current value**System****Default:** 1**:ognimap=** (optional)

Outgoing NI Map. This parameter specifies the NI mapping for outgoing MSUs on a linkset. The NI value in the processed MSU is changed to the value specified by the **ognimap** parameter for that linkset before routing the message to the intended destination.

**Range:** itui2ituis, ituis2itui, itun2ituns, ituns2itun, none

**itui2ituis** — Map ITU International to ITU International Spare

**ituis2itui** — Map ITU International Spare to ITU International

**itun2ituns** — Map ITU National to ITU National Spare

**ituns2itun** — Map ITU National Spare to ITU National.

**none** — NI mapping is not performed on the specified linkset.

**Default:** No change to the current value**System****Default:** none**:rsls8=** (optional)

Rotate SLS by 5 or 8 bits. This parameter specifies whether the signaling link selector (SLS) of the incoming ANSI linkset is rotated by 5 or 8 bits.

**Range:** yes, no

**yes** — 8 bit SLS of the incoming linkset is considered for bit rotation

**no** — 5 bit SLS of the incoming linkset is considered for bit rotation

**Default:** No change to the current value**System****Default:** no**Example**

The following example changes the threshold value of the numslkproh parameter to 3 for an IPSPG-M3UA linkset.

```
chg-lsopts:lsn=1sm3ual:numslkproh=3
```

The following example sets the incoming and outgoing NI Mapping for a linkset.

```
chg-lsopts:lsn=1snimap1:icnimap=itun2ituns:ognimap=ituns2itun
```

The following example sets 8 bit incoming bit rotation for an ANSI link set

```
chg-lsopts:lsn=1s1:rsls8=yes
```

**Dependencies**

The value specified for the **numslkproh** parameter cannot be greater than the value specified for the **numslkrstr** parameter.

The value specified for the **numslkrstr** parameter cannot be greater than the value specified for the **numslkalw** parameter.

The value specified for the **lsn** parameter must indicate an IPSG-M3UA linkset before the **numslkalw**, **numslkproh**, and **numslkrstr** parameters can be specified.

The value specified for the **numslkalw**, **numslkproh**, or **numslkrstr** parameter cannot be greater than the number of links configured in the IPSG-M3UA linkset.

The ITU National and International Spare Point Code Support feature must be enabled before the **icnimap** and **ognimap** parameters can be specified.

The **icnimap** and **ognimap** parameters must be specified together in the command.

The NI mapping for incoming messages in a linkset must be compatible with the NI mapping for the outgoing messages.

Values for the **icnimap** and **ognimap** parameters other than **none** can be specified only for ITU-I and ITU-N APCs of the linkset.

An ANSI linkset must be specified by the **lsn** parameter before the **rsls8=yes** parameter can be specified.

The ISLSBR feature must be enabled before the **rsls8** parameter can be specified.

**Notes**

The values specified for the **icnimap** and **ognimap** parameters for a linkset must be compatible. The following table shows the relationship between the parameters for a linkset.

<b>NI Mapping Rules</b>	
<b>ICNIMAP</b>	<b>OGNIMAP</b>
ITUI2ITUIS	ITUIS2ITUI
ITUIS2ITUI	ITUI2ITUIS
ITUN2ITUNS	ITUNS2ITUN
ITUNS2ITUN	ITUN2ITUNS
NONE	NONE

If the **rsls8=yes** parameter is specified, then 8 bits of the Incoming ANSI SLS are used for the ISLSBR feature. If the **rsls8=no** parameter is specified, then 5 bits are used.

Table 5-22 summarizes the cases in which rotation is done on the Incoming ANSI SLS bits:

**Table 5-22.** Incoming SLS Bit Rotation for ANSI Linksets

Number of Incoming SLS Bits	RSLs8	Valid range of values of ISLSRSB	SLSCNV/SLSCI	If Incoming SLS bits are rotated or not
5	No	1-5	No	Yes
5	No	1-5	Yes	Yes ( Lower 5 bits)
5	Yes	1-8	No	No
5	Yes	1-8	Yes	Yes
8	No	1-5	Yes/No	Yes (Lower 5 bits)
8	Yes	1-8	Yes/No	Yes

**Output**

```
chg-lsopts:lsn=ls1:rsls8=yes
tekelecstp 09-03-03 10:52:55 EST EAGLE 41.0.0
Command entered at terminal #4.
Link set table is (7 of 1024) 1% full.
CHG-LSOPTS: MASP A - COMPLTD
```

**chg-m2pa-tset**

**Change M2PA Timer Set**

Use this command to change M2PA timers in an M2PA timer set. The **srctset** and **tset** parameters can be used to copy from one timer set to another.

**NOTE: The M2PA RFC feature introduces 20 new timer sets. M2PA timer sets created prior to this feature become M2PA Draft 6 timer sets, which are used by the M2PA Draft 6 associations. M2PA RFC associations use the RFC timer sets.**

**Keyword:** chg-m2pa-tset  
**Related Commands:** rtrv-m2pa-tset  
**Command Class:** Database Administration

**Parameters**

- :tset=** (mandatory)  
 Timer set. This parameter specifies the name of the M2PA timer set.  
**Range: 1-20**
- :srctset=** (optional)  
 This parameter specifies which timer set is to be copied into the timer set specified by the **tset** parameter. If the **srctset** parameter is specified, no other timer values can be specified. The timer set specified by the **srctset** parameter cannot be the same timer set that is specified by the **tset** parameter.  
**Range: 1-20**
- :t1=** (optional)  
 T1 timer. This parameter specifies the alignment timer in milliseconds. This timer marks the amount of time M2PA waits to receive a Link Status Alignment message from the peer.  
**Range: 1000-350000**  
**Default: 10000 - D6**

**35000 - RFC****:t16=** (optional)

T16 timer. This parameter specifies the proving rate timer in milliseconds. This timer marks the amount of time between sending Link Status Proving messages while T2N or T2E is running. The T16 value is given in microseconds.

**Range:** 100-500000

**Default:** 200000

**:t17=** (optional)

T17 timer. This parameter specifies the ready rate timer in milliseconds. This timer marks the amount of time between sending Link Status Ready messages while T3 is running.

**Range:** 100-500

**Default:** 250

**:t18=** (optional)

T18 timer. This parameter specifies the processor outage rate timer. This timer marks the amount of time between sending Link Status Processor Outage messages while the link is in service.

**Range:** 100-10000

**Default:** 1000

**:t2=** (optional)

T2 timer. This parameter specifies the M2PA RFC timer. The T2 timer is not used in M2PA Draft 6 timer sets.

**Range:** 5000-150000

**Default:** 20000

**:t3=** (optional)

T3 timer. This parameter specifies the ready timer in milliseconds. This timer marks the amount of time after proving that M2PA waits to receive a Link Status Ready message from the peer.

**Range:** 1000-60000

**Default:** 10000 - D6  
2000 - RFC

**:t4e=** (optional)

T4E timer. This parameter specifies the emergency proving timer in milliseconds. The emergency proving timer marks the amount of time M2PA generates Link Status Proving messages during emergency proving.

**Range:** 400-5000

**Default:** 500

**:t4n=** (optional)

T4N timer. This parameter specifies the normal proving timer in milliseconds. This timer marks the amount of time M2PA generates Link Status Proving messages during normal proving.

**Range:** 1000-70000

**Default:** 10000 - D6  
30000 - RFC

**:t5=** (optional)

T5 timer. This parameter specifies the busy rate timer in milliseconds. This timer marks the amount of time between sending Link Status Busy messages while the link is in service.

**Range:** 80-10000

**Default:** 1000 - D6  
100 - RFC

**:t6=** (optional)

T6 timer. This parameter specifies the remote congestion timer. This timer marks the amount of time that a congested link will remain in service.

**Range:** 1000-6000

**Default:** 3000

**:t7=** (optional)

T7 timer. This parameter specifies the excessive acknowledgement delay timer. This timer marks the maximum amount of time that can pass between transmission of a user data message and receipt of an acknowledgement for that message from the peer. If this timer expires, the link is taken out of service.

**Range:** 200-2000

**Default:** 1200

**:ver=** (optional)

Version. This parameter specifies the M2PA version used by the association.

**Range:** d6, rfc

### Example

```
chg-m2pa-tset:tset=1:t1=20000
chg-m2pa-tset:tset=1:t1=20000:ver=d6
chg-m2pa-tset:srctset=1:tset=2:ver=rfc
```

### Dependencies

At least one optional parameter must be specified.

The **srctset** parameter and the **tset** parameter cannot specify the same timer set name.

The specified timer is not supported for the Draft 6 version of M2PA.

Either a timer value or the **srctset** parameter must be specified.

### Notes

None

### Output

```
chg-m2pa-tset:tset=1:t1=20000:ver=d6
  rlgncxa03w 06-01-18 08:16:14 EST EAGLE 34.3.0
  CHG-M2PA-TSET: MASP A - COMPLTD
;
```

## chg-map

## Change Mate Applications

Use this command to add or modify an entry in the Mated Application Part (MAP) table. A MAP table entry consists of a mate PC/SSN, its attributes, and an Alternate Routing Indicator Mate MRN Set and MRN point code.

**NOTE: A mate point code defines an adjacent signaling point, which is considered the mated signal transfer point (STP) to the system. See the *Notes* section for additional information on multiplicity modes.**

**NOTE: The GTT Load Sharing with Alternate Routing Indicator (GTT LS ARI) feature must be enabled before an Alternate RI Mate for a MAP Set can be provisioned.**

**Keyword:** chg-map

**Related Commands:** dlt-map, ent-map, rtrv-map

**Command Class:** Database Administration

## Parameters

**NOTE:** See "Point Code Formats and Conversion" for a detailed description of point code formats, rules for specification, and examples.

**NOTE:** The `mrnset` and `mrnpc` parameters indicate whether an Alternate RI Mate search is performed in the MRN table if all of the point code/subsystem number combinations provisioned in a given MAP Set are unavailable or congested.

**:pc=** (mandatory)

ANSI point code with subfields *network indicator-network cluster-network cluster member (ni-nc-ncm)*.

**Synonym:** `pca`

**Range:** **000-255**

Specify a valid value for each subfield of the point code, and separate the subfields with a dash (-).

When `chg-sid:pctype=ansi` is specified, `ni = 000` is not valid.

When `chg-sid:pctype=ansi` is specified, `nc = 000` is not valid if `ni = 001-005`.

When `chg-sid:pctype=ansi` is specified, `nc = 000` is valid if `ni = 006-255`.

The point code **000-000-000** is not a valid point code.

**:pc/pca/pci/pcn/pcn24=** (mandatory)

Primary remote point code.

**:pci=** (mandatory)

ITU international point code with subfields *zone-area-id*. The *prefix* subfield indicates a spare point code (*prefix-zone-area-id*).

**Range:** **s-, 0-255**

Specify a valid value for each subfield of the point code, and separate the subfields with a dash (-).

*prefix*—**s-**

*zone*—**0-7**

*area*—**000-255**

*id*—**0-7**

The point code **0-000-0** is not a valid point code.

**:pcn=** (mandatory)

ITU national point code in the format of a 5-digit number (*nnnnn*); or 2, 3, or 4 numbers (members) separated by dashes (*m1-m2-m3-m4*) as defined by the `chg-stpopts:npfmtti` flexible point code option. A group code must be specified when the ITUDUPPC feature is turned on (*nnnnn-gc*, *m1-m2-m3-m4-gc*). The *prefix* subfield indicates a spare point code (*prefix-nnnnn*, *prefix-nnnnn-gc*, *prefix-m1-m2-m3-m4*, *prefix-m1-m2-m3-m4-gc*).

**Range:** **s-, 0-16383, aa-zz**

Specify a valid value for each subfield of the point code, and separate the subfields with a dash (-).

*prefix*—**s-**

*nnnnn*—**0-16383**

*gc*—**aa-zz**

*m1-m2-m3-m4*—**0-14** for each member; values must sum to 14

**:pcn24=** (mandatory)

24-bit ITU national point code with subfields *main signaling area-sub signaling area-signaling point (msa-ssa-sp)*.

**Range:**     **000-255**

Specify a valid value for each subfield of the point code, and separate the subfields with a dash (-).

*msa*—**000-255**

*ssa*—**000-255**

*sp*—**000-255**

**:ssn=** (mandatory)

Subsystem number.

**Range:**     **2-255**

**:eswt=** (optional)

Entity set weight. This parameter specifies the weight assigned to each PC/SSN in a weighted entity set. The Weighted GTT Loadsharing feature must be turned on before this parameter can be specified. This parameter cannot be specified when adding PC/SSNs to a weighted entity set or when modifying RC or weight values for an individual PC/SSN.

**Range:**     **1-99 none**

**none**—Changes a weighted entity set to a non-weighted entity set.

**:force=** (optional)

The **force=yes** parameter must be specified to modify the **rc** parameter and the **srm**, **mrc**, or **wt** parameter in the same command.

Modification of the **srm**, **mrc**, or **wt** parameter is dependent on the parameter's current multiplicity state, which is dependent on the RC value. Changing the **rc** parameter value can change the multiplicity state, which can then cause the **srm**, **mrc**, or **wt** parameter value to become invalid.

**Range:**     **yes**

**:grp=** (optional)

Group. This parameter specifies the concerned point code broadcast list (CSPC) group name. The CSPC is a group of point codes that should be notified of the subsystem status. A different CSPC group can be assigned to each mated PC/SSN. For ANSI, the EAGLE 5 ISS broadcasts SSP or SSA to the mate subsystem only if the mate's point code is provisioned as part of the CSPC group to receive an SSP or SSA.

**Range:**     *ayyyyyyy*

1 alphabetic character followed by up to 7 alphanumeric characters or **none**

**none**—Disassociates a concerned point code broadcast list group from the given mate application

**Default:**    Current value.

**:grpwt=** (optional)

Group weight. This parameter specifies the weight assigned to each PC/SSN in a weighted RC group. The Weighted GTT Loadsharing feature must be turned on before this parameter can be specified. This parameter cannot be specified when adding PC/SSNs to a weighted entity set or when modifying RC or weight values for an individual PC/SSN.

**Range:**     **1-99**

**:mapset=** (optional)

MAP set ID.

**Range:**     **1-36000 dflt**

**dflt**—Default MAP set

**Default:**    **dflt** - If the Flexible GTT Load Sharing feature is not enabled

No change to current value—If the Flexible GTT Load Sharing feature is enabled

**:materc=** (optional)

Mate relative cost. This parameter specifies the RC assigned to the mate PC/SSN that is being added to the entity set. The EAGLE 5 ISS determines the multiplicity mode based on the RC values (the **rc** and **materc** parameters) of the subsystem.

**Range:** 0-99

**Default:** Current value.

**:mpc=** (optional)

ANSI point code with subfields *network indicator-network cluster-network cluster member (ni-nc-ncm)*.

**Synonym:** mpca

**Range:** 000-255

Specify a valid value for each subfield of the point code, and separate the subfields with a dash (-).

When **chg-sid:pctype=ansi** is specified, *ni = 000* is not valid.

When **chg-sid:pctype=ansi** is specified, *nc = 000* is not valid if *ni = 001-005*.

When **chg-sid:pctype=ansi** is specified, *nc = 000* is valid if *ni = 006-255*.

The point code **000-000-000** is not a valid point code.

**Default:** 000-000-000

**:mpc/mpca/mpci/mpcn/mpcn24=** (optional)

Mate remote point code.

**:mpci=** (optional)

ITU international point code with subfields *zone-area-id*. The *prefix* subfield indicates a spare point code (*prefix-zone-area-id*).

**Range:** s-, 0-255

Specify a valid value for each subfield of the point code, and separate the subfields with a dash (-).

*prefix*—s-

*zone*—0-7

*area*—000-255

*id*—0-7

The point code **0-000-0** is not a valid point code.

**Default:** 000-000-000

**:mpcn=** (optional)

ITU national point code in the format of a 5-digit ITU number (*nnnnn*). The *prefix* subfield indicates a spare point code (*prefix-nnnnn*).

**Range:** s-, 0-16383, aa-zz

Specify a valid value for each subfield of the point code, and separate the subfields with a dash (-).

*prefix*—s-

*nnnnn*—0-16383

*gc*—aa-zz

*m1-m2-m3-m4*—0-14 for each member; values must sum to 14

**Default:** 00000



**:mpcn24=** (optional)

24-bit ITU national point code with subfields *main signaling area-sub signaling area-signaling point* (*msa-ssa-sp*).

**Range:** 000-255

Specify a valid value for each subfield of the point code, and separate the subfields with a dash (-).

*msa*—000–255

*ssa*—000–255

*sp*—000–255

**Default:** 000-000-000

**:mrc=** (optional)

Message routing under congestion. This parameter specifies whether Class 0 messages are routed during congestion conditions.

This value can be provisioned in any of the multiplicity modes, but its value only affects traffic if the multiplicity mode is *DOM*. See the *Notes* section for more information on multiplicity modes.

**Range:** yes, no

**Default:** Current value.

**:mrnpc=** (optional)

ANSI point code with subfields *network indicator-network cluster-network cluster member* (*ni-nc-ncm*).

**Synonym:** mrnpca

**Range:** 000-255

Specify a valid value for each subfield of the point code, and separate the subfields with a dash (-).

When **chg-sid:pctype=ansi** is specified, *ni* = 000 is not valid.

When **chg-sid:pctype=ansi** is specified, *nc* = 000 is not valid if *ni* = 001–005.

When **chg-sid:pctype=ansi** is specified, *nc* = 000 is valid if *ni* = 006–255.

The point code 000-000-000 is not a valid point code.

**Default:** 000-000-000

**:mrnpc\mrnpca\mrnpci\mrnpcn\mrnpcn24=** (optional)

Alternate RI Mate point code.

**:mrnpci=** (optional)

ITU international point code with subfields *zone-area-id*. The *prefix* subfield indicates a spare point code (*prefix-zone-area-id*).

**Range:** s-, 0-255

Specify a valid value for each subfield of the point code, and separate the subfields with a dash (-).

*prefix*—s-

*zone*—0-7

*area*—000-255

*id*—0-7

The point code 0-000-0 is not a valid point code.

**Default:** 0-000-0

**:mrnpcn=** (optional)

ITU national point code in the format of a 5-digit number (*nnnnn*); or 2, 3, or 4 numbers (members) separated by dashes (*m1-m2-m3-m4*) as defined by the **chg-stpopts:npfmt** flexible point code option. A group code must be specified when the ITUDUPPC feature is turned on (*nnnnn-gc*, *m1-m2-m3-m4-gc*). The *prefix* subfield indicates a spare point code (*prefix-nnnnn*, *prefix-nnnnn-gc*, *prefix-m1-m2-m3-m4*, *prefix-m1-m2-m3-m4-gc*).

**Range:** **s-**, **0-16383**, **aa-zz**

Specify a valid value for each subfield of the point code, and separate the subfields with a dash (-).

*prefix*—**s-**

*nnnnn*—**0-16383**

*gc*—**aa-zz**

*m1-m2-m3-m4*—**0-14** for each member; values must sum to 14

**Default:** **00000**

**:mrnpcn24=** (optional)

24-bit ITU national point code with subfields *main signaling area-sub signaling area-signaling point* (*msa-ssa-sp*).

**Range:** **000-255**

Specify a valid value for each subfield of the point code, and separate the subfields with a dash (-).

*msa*—**000-255**

*ssa*—**000-255**

*sp*—**000-255**

**Default:** **000-000-000**

**:mrnset=** (optional)

Alternate RI Mate MRN Set ID. This parameter specifies the MRN Set where the Alternate RI Mate search is performed.

**Range:** **1-6000** **dflt**

**dflt**—default MRN Set

If the **mrnpc** parameter is specified, and the **mrnset** parameter is not specified, then the value for the **mrnset** parameter is automatically set to **dflt**.

**Default:** No change to the current value

**:mssn=** (optional)

Mated subsystem number. This parameter specifies the SSN that acts as a backup if the SSN fails.

**Range:** **2-255**

**Default:** Current value.

**:mwt=** (optional)

Mate point code weight. This parameter specifies the weight assigned to the PC/SSN that is being added to a weighted entity set. The Weighted GTT Loadsharing feature must be turned on before this parameter can be specified.

**Range:** **1-99**

**:rc=** (optional)

Relative cost. This parameter specifies the RC assigned to a specified PC/SSN. The EAGLE 5 ISS determines the multiplicity mode based on the relative costs (the **rc** and **materc** parameters) of the subsystem.

**Range:** **0-99**

**Default:** Current value.

**:srm=** (optional)

Subsystem routing messages. This parameter specifies whether subsystem routing messages (SBR, SNR) are transmitted between the mated applications.

This value can be provisioned in any of the multiplicity modes, but its value only affects traffic if the multiplicity mode is *DOM* or *COM*. See the *Notes* section for more information on multiplicity modes.

**Range:**     **yes, no**

**Default:**    Current value.

**:sso=** (optional)

Subsystem status option. This parameter specifies whether the PC/SSN will initiate a subsystem test when a RESUME is received for the PC.

**Range:**     **on, off**

**on**—prohibited

**off**—allowed

**Default:**    Primary—no change

Mate, if entered—**off**

**:thr=** (optional)

Threshold. This parameter specifies the in-service threshold assigned to each PC/SSN in a weighted entity set or RC group. The Weighted GTT Loadsharing feature must be turned on before this parameter can be specified.

This parameter cannot be specified when adding PC/SSNs to a weighted entity set or RC group or when modifying RC or weight values for an individual PC/SSN.

If the **thr** parameter is not specified, a value of **1%** is assigned to each weighted PC/SSN.

**Range:**     **1-100**

**:wt=** (optional)

Weight. This parameter specifies the new weight assigned to the primary PC/SSN. The Weighted GTT Loadsharing feature must be turned on before this parameter can be specified.

**Range:**     **1-99**

**Example**

The following example enters 1-1-3/10 into the MAP table and adds it to the same group as 1-1-0/10. Because 1-1-0/10 already exists in the MAP table, the rc parameter is not used.

**chg-map:pc=1-1-0:ssn=10:mpc=1-1-3:mssn=10:materc=40**

The following example enters 1-1-2/10 into the MAP table, and adds it to the same group as 1-1-0/10 (see above example). Because 1-1-2/10 has a lower relative cost than 1-1-3/10, it is placed into the group in relative cost order.

**chg-map:pc=1-1-0:ssn=10:mpc=1-1-2:mssn=10:materc=30**

The following example changes the relative cost (rc) for the specified pc/ssn pair:

**chg-map:pc=1-1-0:ssn=10:rc=20**

The following example changes the concerned PC broadcast list group name (grp) for the specified pc/ssn pair:

**chg-map:pc=1-1-0:ssn=10:grp=abc**

The following example changes the ITU-I spare point code entry s-1-12-2 and adds the spare mate point code entry s-2-23-3 in the map table:

**chg-map:pci=s-1-12-2:ssn=10:rc=10:mpci=s-2-23-3:mssn=20:materc=10**

The following example turns ON the sso option for pc1-1-0 and ssn10.

**chg-map:pc=1-1-0:ssn=10:sso=on**

The following example turns OFF the sso option for pc1-1-0 and ssn10.

**chg-map:pc=1-1-0:ssn=10:sso=off**

The following example does not change the current value of the sso option for the primary or the mate.

**chg-map:pc=1-1-0:ssn=10:rc=10**

The following example turns ON the sso option for primary and mate.

**chg-map:pc=1-1-0:ssn=10:mpc=3-3-3:mssn=2:sso=on**

The following example turns OFF the sso option for primary and mate.

**chg-map:pc=1-1-0:ssn=10:mpc=4-4-4:mssn=2:sso=off**

The following example does not change the current value for the sso option for the primary. The sso option is turned OFF for the mate, because the mate is specified but the sso parameter is not specified (the default is OFF for the mate when the mate is specified).

**chg-map:pc=1-1-0:ssn=10:mpc=5-5-5:mssn=2**

The following example changes the ITU-I spare s-1-12-2 entry and adds the spare mate point code s-2-23-3 entry in the map table.

**chg-map:pci=s-1-12-2:ssn=10:rc=10:mpci=s-2-23-3:mssn=20:materc=10**

The following example adds a new PC/SSN 1-1-3/10 in the existing MAP set 362.

**chg-map:pc=1-1-1:ssn=10:mpc=1-1-3:mssn=10:materc=40:mapset=362**

The following example adds a new PC/SSN 1-1-3/15 to the same load-sharing group in the default MAP set to which 1-1-1/15 belongs.

**chg-map:pc=1-1-1:ssn=15:mpc=1-1-3:mssn=15:materc=40:mapset=df1t**

The following example changes the RC of 1-1-1/10 in existing MAP set 362 to 20.

**chg-map:pc=1-1-1:ssn=10:rc=20:mapset=362**

The following example changes a non-weighted shared or non-weighted combined entity set to a weighted shared or weighted combined entity set.

**chg-map:pc=1-1-1:ssn=10:eswt=30**

The following example changes a non-weighted shared or non-weighted combined entity set to a weighted shared or weighted combined entity set. This example also sets a threshold value and changes the weights of all of the PC/SSNs in the entity set.

**chg-map:pc=1-1-1:ssn=10:eswt=30:thr=50**

The following example changes a weighted shared or weighted combined entity set to a non-weighted shared or non-weighted combined entity set.

**chg-map:pc=1-1-1:ssn=10:eswt=none**

The following example assigns a weight value to each PC/SSN in an RC group within a weighted entity set.

**chg-map:pc=1-1-1:ssn=10:grpwt=20**

The following example assigns a threshold value to each PC/SSN in an RC group within a weighted entity set.

**chg-map:pc=1-1-1:ssn=10:thr=70**

The following example assigns weight and threshold values to each PC/SSN in an RC group within a weighted entity set.

**chg-map:pc=1-1-1:ssn=10:grpwt=20:thr=70**

The following example changes the weight of an existing PC/SSN in a weighted entity set.

```
chg-map:pc=1-1-1:ssn=10:wt=20
```

The following example changes the weight of PC/SSN 1-1-1/10 and adds PC/SSN 1-2-1/10 to an existing weighted entity set.

```
chg-map:pc=1-1-1:ssn=10:wt=50:mpc=1-2-1:mssn=10:materc=20:mwt=30
```

The following example adds PC/SSN 1-3-2/10 to an existing non-weighted entity set.

```
chg-map:pc=1-1-1:ssn=10:mpc=1-3-2:mssn=10:materc=20:mwt=10
```

The following example changes the RC value and turns on MRC of an existing PC/SSN in a weighted entity set.

```
chg-map:pc=1-1-1:ssn=10:rc=30:mrc=yes:force=yes
```

The following example changes the RC value and turns on SRM of an existing PC/SSN in a weighted entity set.

```
chg-map:pc=1-1-1:ssn=10:rc=30:srm=yes:force=yes
```

The following example changes the RC value and the weight of an existing PC/SSN in a weighted entity set.

```
chg-map:pc=1-1-1:ssn=10:rc=30:wt=20:force=yes
```

The following example changes the Alternate RI Mate (MRNSET and MRNPC) in an existing MAP set.

```
chg-map:mapset=362:pc=1-1-1:ssn=10:mrnset=1:mrnpc=1-1-2
```

## Dependencies

At least one optional parameter must be specified.

The specified remote PC must exist in the MAP table.

The Spare Point Code Support feature must be enabled before an ITU-I or ITU-N spare point code can be specified.

The specified SSN must exist for the specified remote PC.

If a subsystem is configured for a SSN value in the SS-APPL table, then the specified MAP table entry for that subsystem must be a valid point code type for that subsystem. The following point code types are not valid for the indicated subsystems:

- If the subsystem number is configured for the INP subsystem in the SS-APPL table, then the True Point code cannot be an ITU-I or ANSI point code.
- If the subsystem number is configured for the EIR subsystem in the SS-APPL table, then the True Point code cannot be an ANSI point code.
- If the subsystem number is configured for the ATINPQ or VFLEX subsystem in the SS-APPL table, then the True Point code cannot be an ITU-N24 point code.

The mate PC/SSN cannot be the same as the primary PC/SSN.

If the PC value is an ITU type (**pci**, **pcn**, or **pcn24**), the **srm=yes** parameter cannot be specified.

The **apca** and **pcn24** parameters cannot be specified for the same MAP set. The **pci** and **pcn** parameters cannot be specified for the same MAP set if the MAP set contains a true point code.

To mix group and PC network types, the ANSI-ITU-China SCCP Conversion feature must be on.

The network type of the specified CSPC group must match the network type of the specified PC.

The mated PC/SSN must not already exist in the MAP table.

The DPCs of the primary subsystem and the mate subsystem must be full PCs.

The format of the **pcn** or **mpcn** parameter must match the format assigned with the **npcfnti** parameter of the **chg-stpopts** command.

If the **mpc** parameter is specified, the **mssn** and **materc** parameters must be specified.

A maximum of 32 mated applications is allowed per MAP set.

The **sso** parameter cannot be specified with a PC that is the system true PC.

A true PC can have only one mate.

A true PC cannot be routed to itself.

If the **mssn** or **materc** parameter is specified, the **mpc** parameter must be specified.

The PC must already exist in the CPC group.

The specified CSPC broadcast list group name must already exist.

If the **mpc** parameter is specified, then the **mssn** parameter must be specified.

The number of MPC Subsystem entries must not exceed the table capacity.

A maximum of 1024 unique remote point codes are allowed.

If a remote MPC is specified, then the remote MPC must exist in the Routing table.

If the Flexible GTT Load Sharing feature is not enabled, then the **mapset** parameter must not be specified. If the Flexible GTT Load Sharing feature is enabled, then the **mapset** parameter must be specified.

The specified MAP set must exist in the database.

The specified PC/SSN/MAP set must already be provisioned in the MAP table.

The EAGLE 5 ISS true PC can be provisioned only in the default MAP set.

The Weighted GTT Loadsharing feature must be turned on before the **wt**, **mwt**, **eswt**, **grpwt**, or **thr** parameters can be specified.

If the **eswt**, **grpwt** or **thr** parameter is specified, the **mpc** parameter cannot be specified.

If the **eswt**, **grpwt** and **thr** parameters are specified, the **rc**, **wt**, **mrc**, **srm**, **sso** or **grp** the parameters cannot be specified.

The **eswt** and **grpwt** parameters cannot be specified together in the command.

If the **eswt=none** parameter is specified, the **thr** parameter cannot be specified.

If the **mwt** parameter is specified, the **mpc** parameter must be specified.

The **mpc** parameter value must be a full point code.

If the **mpc** parameter is specified for a weighted entity set, the **mwt** parameter must be specified.

If the **mpc** parameter is specified for a non-weighted entity set, the **mwt** parameter cannot be specified.

The **eswt=none** parameter cannot be specified for a non-weighted entity set.

The **grpwt** and **thr** parameters cannot be specified for a non-weighted entity set.

If the **chg-sid:pctype=ansi** command is entered, a value of *ni=000* cannot be specified. If the **chg-sid:pctype=ansi** command is entered, and a value of *ni=001 – 005* is specified, a value of *nc=000* cannot be specified

The mate point code in the command will exceed the maximum number of entries in the MAP table.

The maximum number of possible entries in the MAP table has been reached for the specified True Point code.

**Table 5-23.** Maximum limit of True PC entries

True Point Code Type	Maximum limit in MAP table
ANSI	1 (With LNP) 2 (With ATINPQ and V-FLEX) (LNP is mutually exclusive with ATINPQ, EIR, INP, and VFLEX)
ITU-I	3 (For ATINPQ, EIR and V-FLEX)
ITU-N	4 (For ATINPQ, EIR, INP, and V-FLEX)

The true point code in the entity set must be the primary PC/SSN for that entity set. The **rc** parameter value for the specified point code cannot be changed, and a new point code cannot be added that causes the true point code to no longer be the primary PC/SSN.

If the **pc** parameter value is a true point code, the subsystem must have a lower RC than all other mated subsystems in the RC group.

If the **mpc** parameter value is a true point code, the subsystem must have a lower RC than all other mated subsystems in the RC group.

The **eswt**, **grpwt**, and **thr** parameters cannot be specified for solitary or dominant entity sets.

The AINPQ, EIR, INP, or V-Flex feature must be turned on, or the ATINP feature must be enabled before the value specified for the **mpcn** parameter can be a true point code.

The **force=yes** parameter must be specified before the **rc** parameter can be specified in the same command with the **srn**, **mrc**, or **wt** parameter.

The **force** parameter can be used only to specify the **rc** parameter and the **srn**, **mrc**, or **wt** parameter in the same command.

If the **pcn** or **mpcn** parameter is specified, then the format of the parameter must match the format dictated by the **chg-stpopts:npcfnti** command.

D45MPC/MSSN must be defined for given value of MULT.

PC and SSN are not primary applications.

The values specified for the **pc** and **mpc** parameters cannot be associated with proxy point codes.

The EIR or V-Flex feature must be turned on, or the ATINP feature must be enabled before the value specified for the **mpci** parameter can be a true point code.

The LNP or V-Flex feature must be turned on, or the ATINP feature must be enabled before the value specified for the **mpca** parameter can be a true point code.

The GTT LS ARI feature must be enabled before the **mrnset** and **mrnpc** parameters can be specified.

The value specified for the **mrnpc** parameter must be a full point code.

The value specified for the **mrnset** parameter must already exist in the MRN table.

The point codes and alternate RI Mate point codes must have the same network type. Table 5-24 displays the allowed PC and Alternate RI Mate PC combinations

**Table 5-24.** Allowed PC and Alternate RI Mate PC Combinations

Network Type of PC	Allowed Network Type of Alternate ARI Mate PC
ITU-I, ITU-N, ITU-I spare, ITU-N spare	ITU-I, ITU-N, ITU-I spare, ITU-N spare
ANSI	ANSI
ITUN-24	ITUN-24

The value specified for the **mrnpc** parameter must already exist in the specified MRN Set.

If the **mrnset** parameter is specified, then the **mrnpc**, **mrnpca**, **mrnpci**, **mrnpcn**, or **mrnpc24** parameter must be specified.

If the **eswt**, **grpwt**, or **thr** parameter is specified, then the **mrnpc** parameter cannot be specified.

The **mrnset** parameter cannot be specified if the MAP Set specified by the **mapset** parameter contains a True Point Code.

### Notes

When the ANSI-ITU-China SCCP Conversion feature is turned on, the Concerned Point Code (CSPC) Group's network type can be of a different network than the mated application's network type. For example, the mated application's network type could be ANSI and the CSPC Group could be ITU or mixed with ANSI, ITU, and ITUN concerned point codes.

#### *Multiplicity Modes*

For the **-map** commands, an entity set consists of a group of PC/SSNs that are used for traffic distribution, and an RC group consists of PC/SSNs within an entity set that have the same RC. In loadsharing mode, an entity set contains 1 RC group. In combined loadsharing /dominant mode, an entity set can contain multiple loadsharing groups.

The EAGLE 5 ISS supports the following multiplicity modes for nodes/subsystems:

- When a PC/SSN pair is not replicated, the pair is in *solitary* (SOL) mode. The subsystem acts as the only application, with no backup. If this subsystem fails, messages routed to it are discarded and SCCP management returns "Subsystem Unavailable" messages to the originator.
- A group of replicated PC/SSN pairs are in *dominant* (DOM) mode if each PC/SSN pair in the group has a unique RC. The specified subsystem with the lowest RC acts as the primary subsystem, while the mate subsystem acts as a backup. In the event of congestion, messages route to the mate subsystem. When the congestion subsides, messages are again routed to the primary (dominant) subsystem.
- A group of replicated PC/SSN pairs are in *load sharing* (SHR) mode if each PC/SSN pair in the group has the same RC. All messages are evenly distributed at the SCCP level to all nodes/subsystems in the group. In the event of congestion or failure, the non-affected subsystem assumes the load of its failed or congested mate.
- The *combined load sharing/dominant* (COM) mode supports a combination of load sharing and dominant mode. A group of PC/SSN pairs are in combined load sharing/dominant mode when at least two of the PC/SSN pairs have the same RC and another node subsystem in the group has a different RC. A combination of node accessibility and RC determines the preferred PC/SSN.



The **sso** parameter changes the initialization of the subsystem status (“prohibited” or “allowed”) for PC/SSN MAP entries. The EAGLE 5 ISS previously marked the subsystem status “allowed” (OFF) for each PC/SSN entry. The **sso** option marks the subsystem status “prohibited” for each entry that has **sso=on**. This causes the EAGLE 5 ISS to generate an SST to the remote PC when an MTP-RESUME is received. Upon reception of an SSA, the subsystem status is marked “allowed”.

In this command, only ITU-international and ITU national point codes support the spare point code subtype prefix (s-).

When the Flexible GTT Load Sharing feature is turned on, MAP Load-Sharing Sets are supported. Each MAP set is identified by a new **mapset** parameter.

When the Weighted GTT Loadsharing feature is turned on, weighted entity sets and RC groups are supported, and threshold values can be assigned to each PC/SSN in a weighted entity set.

## Output

```

chg-map:pc=1-1-0:ssn=10:mpc=1-1-3:mssn=10:materc=40:mapset=362
tekelecstp 09-01-22 12:29:22 EST EAGLE 40.1.0
CHG-MAP: MASP A - COMPLTD
;

chg-map:pc=1-1-1:ssn=10:mapset=df1t:mrnset=2:mrnpc=1-1-4
tekelecstp 09-01-22 12:29:22 EST EAGLE 40.1.0
CHG-MAP: MASP A - COMPLTD
;

chg-map:pc=1-1-1:ssn=100:mrc=no:srm=no
tekelecstp 09-07-22 12:29:22 EST EAGLE 41.1.0
chg-map:pc=1-1-1:ssn=100:mrc=no:srm=no
Command entered at terminal #4.
CAUTION: THE VALUE OF SRM IS EFFECTIVE WHEN MULT IS COM OR DOM AND
THE VALUE OF MRC IS EFFECTIVE WHEN MULT IS DOM.
CHG-MAP: MASP A - COMPLTD
;

```

## chg-meas

### Change Measurements

Use this command to change both the report and collecting status of the EOAM based measurement subsystem.

**NOTE: After the Measurements Platform collection function has been enabled, the collect=on/off parameter controls only the output of reports to the UI. The parameter has no effect on enabling and disabling collection and report generation for the Measurements Platform.**

**Report generation for the Measurements Platform is controlled by the rept-ftp-meas and chg-measopts commands.**

**Keyword:** chg-meas

**Related Commands:** copy-meas, rept-ftp-meas, rept-meas, rtrv-meas-sched

**Command Class:** Link Maintenance

## Parameters

**:collect=** (optional)

Activates or deactivates the reporting of scheduled measurements to the UI. This parameter does not affect measurements collection and generation for the Measurements Platform.

**Range:** on, off

**Default:** No change to value

**System**

**Default:** off - off

- :complink=** (optional)  
 Activates or deactivates scheduled measurement report for links.  
**Range:** on, off  
**Default:** Current value
- :complnkset=** (optional)  
 Activates or deactivates scheduled measurement report for linksets.  
**Range:** on, off  
**Default:** Current value
- :gtwylnkset=** (optional)  
 Activates or deactivates the scheduled GTWY measurement report for the linkset.  
**Range:** on, off  
**Default:** Current value
- :gtwylsfltr=** (optional)  
 Filters the linksets included in the GTWY report.  
**Range:** both, stp, seas, none  
**both**—Only gateway linksets are included in the report to the terminal and SEAS.  
**stp**—Only gateway linksets are included in the report to the terminal. All defined linksets are included in the report to SEAS.  
**seas**—All defined linksets are included in the report to the terminal. Only gateway linksets are included in the report to SEAS.  
**none**—All defined linksets are included in the report to the terminal and SEAS.
- :gtwystp=** (optional)  
 Activates or deactivates the scheduled GTWY measurement report for the STP.  
**Range:** on, off  
**Default:** Current value
- :systotstp=** (optional)  
 Activates or deactivates scheduled measurement report for STP system totals.  
**Range:** on, off  
**Default:** Current value
- :systotstplan=** (optional)  
 Activates or deactivates scheduled measurement report for the STPLAN feature system totals.  
**Range:** on, off  
**Default:** Current value
- :systotstt=** (optional)  
 Activates or deactivates scheduled measurement report for translation type system totals.  
**Range:** on, off  
**Default:** Current value

### Example

```
chg-meas:collect=on
chg-
meas:complink=on:complnkset=on:systotstt=off:systotstp=off:collect
=on
chg-meas:gtwylsfltr=both
```

### Dependencies

At least one optional parameter must be specified.

If the 15 Minute Measurements collection option is turned on, the **collect=on** parameter cannot be specified in this command.

If there are no configured links, then the **collect=on** parameter cannot be specified.

### Notes

Activated scheduled reports print at serial ports configured for traffic-related unsolicited messages (the **traf=yes** parameter of the **chg-trm** command).

When the Measurements Platform is not enabled, the daily maintenance scheduled reports are always allowed and cannot be inhibited.

The *Maintenance Manual* provides detailed information on measurements and measurement reports.

### Output

```
chg-
meas:complink=on:complnkset=on:systottt=off:systotstp=off:collect
=on
```

```
rlghncxa03w 04-01-18 17:02:57 EST EAGLE 31.3.0
CHG-MEAS: MASP A - COMPLTD
```

```
;
```

## chg-measopts

## Change Measurements Options

Use this command for the following functions:

- Enable the Measurements Platform collection function
- Turn on or turn off the 15 Minute Measurements collection function
- Enable or disable the automatic generation and FTP transfer of scheduled measurements reports to the FTP server
- Turn on or off the CLLI-based file name option for measurements reports files

**NOTE:** After the Measurements Platform collection function has been enabled with the **platformenable=on** parameter, it cannot be disabled with this command.

**NOTE:** The hourly and daily maintenance report controls are being moved to the **chg-mtc-measopts** command. Currently, these reports can be redundantly controlled by the **chg-measopts** and the **chg-mtc-measopts** commands. These parameters will be removed from the **chg-measopts** command in a future release. The affected reports are:

- **mtcdlink, mtcdlnkset, mtcdstp, mtcdstplan, mtcdlnp, mtcddnp, mtcddmap, mtcddsetpasoc, mtcddsetpcard, mtcddua, mtcdeir, mtchlnp, mtchnp, mtchmap, and mtcheir**

**Keyword:** **chg-measopts**

**Related Commands:** **chg-ftp-serv, chg-meas, chg-mtc-measopts, chg-netopts, dlt-ftp-serv, ent-ftp-serv, rept-ftp-meas, rept-meas, rept-stat-meas, rtrv-ftp-serv, rtrv-measopts, rtrv-mtc-measopts, rtrv-netopts**

**Command Class:** Link Maintenance

### Parameters

**:all=** (optional)

Activates or deactivates the automatic generation and FTP transfer of all scheduled measurements reports.

**NOTE: The all parameter does not change the setting of the platformenable parameter.**

**Range:** on, off

**Default:** No change to the current value

**:avldlink=** (optional)

Activates or deactivates the automatic generation and FTP transfer of the scheduled daily availability measurement report for links.

**Range:** on, off

**Default:** No change to the current value

**System**

**Default:** off

**:avllink=** (optional)

Activates or deactivates the automatic generation and FTP transfer of the scheduled hourly availability measurement report for links.

**Range:** on, off

**Default:** No change to the current value

**System**

**Default:** off

**:avlstplan=** (optional)

Activates or deactivates the automatic generation and FTP transfer of the scheduled hourly availability measurement report for STPLAN.

**Range:** on, off

**Default:** No change to the current value

**System**

**Default:** off

**:cllibasedname=** (optional)

Enable or disable CLLI-based measurements report file name option.

**Range:** on, off

**Default:** No change to the current value

**System**

**Default:** off

**:collect15min=** (optional)

Turns on or off the 15 Minute Measurements collection function.

**Range:** on, off

**Default:** No change to the current value

**System**

**Default:** off

**:complink=** (optional)

Activates or deactivates the automatic generation and FTP transfer of the scheduled component measurement report for links.

**Range:** on, off

**Default:** No change to the current value

**System**

**Default:** off

**:complnkset=** (optional)

Activates or deactivates the automatic generation and FTP transfer of the scheduled component measurement report for linksets.

**Range:** on, off

**Default:** No change to the current value

**System****Default:** off**:compctpasoc=** (optional)

Activates or deactivates the automatic generation and FTP transfer of the scheduled component measurement report for per association SCTP data.

**Range:** on, off**Default:** No change to the current value**:compctpcard=** (optional)

Activates or deactivates the automatic generation and FTP transfer of the scheduled component measurement report for per card SCTP data.

**Range:** on, off**Default:** No change to the current value**:compua=** (optional)

Activates or deactivates the automatic generation and FTP transfer of the scheduled component measurement report for M3UA and SUA application server/association pairs.

**Range:** on, off**Default:** No change to the current value**:gtwylnkset=** (optional)

Activates or deactivates the automatic generation and FTP transfer of scheduled GTWY measurement report for linksets.

**Range:** on, off**Default:** No change to the current value**System****Default:** off**:gtwylsdestni=** (optional)

Activates or deactivates the automatic generation and FTP transfer of scheduled GTWY link set measurement report for destination NI

**Range:** on, off**Default:** No change to the current value**System****Default:** off**:gtwylsonismt=** (optional)

Activates or deactivates the automatic generation and FTP transfer of scheduled GTWY linkset measurement report for ISUP message type per linkset per originating NI

**Range:** on, off**Default:** No change to the current value**System****Default:** off**:gtwylsorigni=** (optional)

Activates or deactivates the automatic generation and FTP transfer of scheduled GTWY link set measurement report for originating NI

**Range:** on, off**Default:** No change to the current value**System****Default:** off**:gtwyorigni=** (optional)

Activates or deactivates the automatic generation and FTP transfer of scheduled GTWY link measurement report for originating NI.

**Range:** on, off  
**Default:** No change to the current value  
**System**  
**Default:** off

**:gtwyoriginnc=** (optional)

Activates or deactivates the automatic generation and FTP transfer of scheduled GTWY link measurement report for originating NI and NC.

**Range:** on, off  
**Default:** No change to the current value  
**System**  
**Default:** off

**:gtwystp=** (optional)

Activates or deactivates the automatic generation and FTP transfer of scheduled GTWY measurement report for STP.

**Range:** on, off  
**Default:** No change to the current value  
**System**  
**Default:** off

**:mtdeir=** (optional)

Activates or deactivates the automatic generation and FTP transfer of the daily maintenance measurement report for Equipment Identity Register (EIR).

**Range:** on, off  
**Default:** No change to the current value  
**System**  
**Default:** off

**:mtcdlink=** (optional)

Activates or deactivates the automatic generation and FTP transfer of the daily maintenance measurement report for links.

**Range:** on, off  
**Default:** No change to the current value  
**System**  
**Default:** off

**:mtcdlnkset=** (optional)

Activates or deactivates the automatic generation and FTP transfer of the daily maintenance measurement report for link sets.

**Range:** on, off  
**Default:** No change to the current value  
**System**  
**Default:** off

**:mtcdlnp=** (optional)

Activates or deactivates the automatic generation and FTP transfer of the scheduled daily maintenance measurement report per LNP.

**Range:** on, off  
**Default:** No change to the current value  
**System**  
**Default:** off

**:mtcdmap=** (optional)

Activates or deactivates the automatic generation and FTP transfer of the scheduled daily maintenance measurement report per GSM MAP Screening server entry.

**Range:** on, off  
**Default:** No change to the current value  
**System**  
**Default:** off

**:mtcdnp=** (optional)

Activates or deactivates the automatic generation and FTP transfer of the scheduled daily maintenance measurement report per NP.

**Range:** on, off  
**Default:** No change to the current value  
**System**  
**Default:** off

**:mtcdsctpasoc=** (optional)

Activates or deactivates the automatic generation and FTP transfer of the scheduled daily maintenance measurement report for per association SCTP data.

**Range:** on, off  
**Default:** No change to the current value

**:mtcdsctpcard=** (optional)

Activates or deactivates the automatic generation and FTP transfer of the scheduled daily maintenance measurement report for per card SCTP data.

**Range:** on, off  
**Default:** No change to the current value

**:mtcdstp=** (optional)

Activates or deactivates the automatic generation and FTP transfer of the daily maintenance measurement report for STP.

**Range:** on, off  
**Default:** No change to the current value  
**System**  
**Default:** off

**:mtcdstplan=** (optional)

Activates or deactivates the automatic generation and FTP transfer of the daily maintenance measurement report for STPLAN.

**Range:** on, off  
**Default:** No change to the current value  
**System**  
**Default:** off

**:mtcdua=** (optional)

Activates or deactivates the automatic generation and FTP transfer of the scheduled daily maintenance measurement report for M3UA and SUA application server/association pairs.

**Range:** on, off  
**Default:** No change to the current value  
**System**  
**Default:** off

**:mtcheir=** (optional)

Activates or deactivates the automatic generation and FTP transfer of the scheduled hourly maintenance measurement report for Equipment Identity Register (EIR).

**Range:** on, off  
**Default:** No change to the current value  
**System**  
**Default:** off

**:mtchlnp=** (optional)

Activates or deactivates the automatic generation and FTP transfer of the scheduled hourly maintenance measurement report per LNP.

**Range:** on, off

**Default:** No change to the current value

**System**

**Default:** off

**:mtchmap=** (optional)

Activates or deactivates the automatic generation and FTP transfer of scheduled hourly maintenance measurement report per GSM MAP Screening server entry.

**Range:** on, off

**Default:** No change to the current value

**System**

**Default:** off

**:mtchnp=** (optional)

Activates or deactivates the automatic generation and FTP transfer of the scheduled hourly maintenance measurement report per NP.

**Range:** on, off

**Default:** No change to the current value

**System**

**Default:** off

**:nmlink=** (optional)

Activates or deactivates automatic generation and FTP transfer of the scheduled network management measurement report for links.

**Range:** on, off

**Default:** No change to the current value

**System**

**Default:** off

**:nmlnkset=** (optional)

Activates or deactivates automatic generation and FTP transfer of the scheduled network management measurement report for link sets.

**Range:** on, off

**Default:** No change to the current value

**System**

**Default:** off

**:nmstp=** (optional)

Activates or deactivates automatic generation and FTP transfer of scheduled network management measurement report for STP.

**Range:** on, off

**Default:** No change to the current value

**System**

**Default:** off

**:platformenable=** (optional)

Enables the Measurements Platform collection function.

This parameter cannot be turned off after it has been turned on.

**Range:** on

**Default:** No change to the current value

**System**

**Default:** off



**:systotstp=** (optional)

Activates or deactivates automatic generation and FTP transfer of scheduled measurement report for STP system totals.

**Range:** on, off

**Default:** No change to the current value

**System**

**Default:** off

**:systotstplan=** (optional)

Activates or deactivates automatic generation and FTP transfer of the scheduled measurement report for the STPLAN feature system totals.

**Range:** on, off

**Default:** No change to the current value

**System**

**Default:** off

**:systotstt=** (optional)

Activates or deactivates automatic generation and FTP transfer of scheduled measurement report for translation type system totals.

**Range:** on, off

**Default:** No change to the current value

**System**

**Default:** off

**Example**

```
chg-measopts:platformenable=on
```

```
chg-
```

```
measopts:platformenable=on:complink=on:complnkset=on:systotstt=off
:systotstp=off
```

**Dependencies**

The Measurements Platform feature must be on before this command can be entered.

An MCPM card must be in the IS-ANR Restrict state before the Measurements Platform collection option can be enabled.

The 15 Minute Measurements feature must be enabled and turned on before the 15 Minute Measurements collection option can be turned on.

The Measurements Platform collection option must be enabled (**platformenable=on**) before the CLLI-based name option can be turned on (**cllibasedname=on**).

The LNP feature must be turned on (see the **enable-ctrl-feat** command) before the **mtchlnp=on** parameter or the **mtcdlnp=on** parameter can be specified.

The GSM Map Screening (GSMSCR) feature must be turned on before the **mtcdmap=on** parameter or the **mtchmap=on** parameter can be specified.

The Equipment Identity Register (EIR) feature must be turned on before the **mtcheir=on** parameter or the **mtcdeir=on** parameter can be specified.

This command is not allowed while in upgrade mode.

Half-hour collection and report processing cannot be in progress when **collect15min=on** is specified.

Quarter-hour collection and report processing cannot be in progress when **collect15min=off** is specified.

If there are no configured links, then the **platformenable=on** parameter cannot be specified.

The A-Port, G-Port, IS41 GSM Migration, MO SMS IS41-to-GSM Migration, MO-based GSM SMS NP, MO-based IS41 SMS NP, Prepaid SMS Intercept Ph1, TIF ASD, TIF GRN, TIF Number Portability, or TIF Simple Number Substitution feature must be enabled, or the INP feature must be turned on before the **mtchnp=on** parameter or the **mtcdnp=on** parameter can be specified.

## Notes

The function of the **all** parameter does not affect the **mtchnp**, **mtchlnp**, **mtchmap**, **mtcheir**, **mtcdnp**, **mtcdlnp**, **mtcdmap**, and **mtcdeir** reports. These reports must be turned on and off using the individual report parameters.

Activated scheduled reports are generated and transferred to the customer's FTP server.

The **rept-ftp-meas** command can be used to manually generate and transfer one report at a time as needed.

The primary application of the **set-time** command is for Daylight Savings Time changes, setting the time forward or backward 1 hour. To reduce effects of **set-time** changes on measurements, the time change should be done within the first 15 minutes of any hour.

The *Maintenance Manual* provides detailed information on measurements and measurement reports.

### **CLLI-Based Measurements Report File Name**

When the CLLI-based file name option (**cllibasedname**) is turned on, the CLLI is added to the measurements report file name, and the year is removed from the file name to ensure that the file name is equal to or fewer than 39 characters.

### **15 Minute Measurements**

When the SEAS feature is turned on and 15 Minute Measurements collection is turned from off to on with the **collect15min=on** parameter, the message "Disabling SEAS Measurements..." is displayed at the UI.

When the SEAS feature is turned on and 15 Minute Measurements collection is running (**collect15min=on**), EAGLE 5 ISS measurements output to the SEAS interface is disabled.

When the SEAS feature is turned on and 15 Minute Measurements collection is turned from on to off with the **collect15min=off** parameter, EAGLE 5 ISS measurements output to the SEAS interface is enabled again.

**NOTE: If SEAS reporting is turned on, for the 24 hours after the 15 Minute Measurements option is turned from on to off, 30-minute demand SEAS reports for time periods prior to the option status change will contain only 15 minutes of data, and SEAS will not support reporting at the xx15 and xx45 times.**

Some quarter-hour measurements data might not be available for 24 hours after turning 15 Minute Measurements collection on. This condition exists for quarter-hour intervals for which 15 Minute Measurements collection has not yet occurred. Data that was collected on a 30-minute basis is available for reporting for up to 24 hours after it is collected. After the 15 Minute Measurements collection option is turned on, this data remains available on a half-hour basis (xx00 and xx30) but is not available on a quarter-hour basis (xx15 and xx45) because no data was collected on the quarter hours. After the 15 Minute Measurements collection option has been turned on for 24 hours, all 15-minute measurements data is available on a quarter-hour basis (xx00, xx15, xx30, and xx45).

In addition, full 30-minute data coverage will not be available until 24 hours after turning off the 15 Minute Measurements collection option. Reports for specific periods will always contain the amount of data collected for that period.

The action of turning 15-minute measurements feature control status on using the **chg-ctrl-feat** command also has an impact on the generation of measurements reports for **period=active**. Specifically, if the feature control status of 15-minute measurements is turned on and a report is requested for the active interval prior to the next scheduled measurements collection (based on the

current 15-minute measurements status), the starting time for the period shown in the report will be incorrect. As soon as the next scheduled collection occurs, active reports will show the correct starting time. For example, if 15-minute feature control status is turned on with the **chg-ctrl-feat** command at 13:03, and the 15-minute measurements collection option is turned on using the **chg-measopts** command at 13:05, and a comp-link report for **period=active** is requested at 13:10, that report will contain an incorrect interval start time. If the same report is requested at 13:20, the start time shown in the report will be correct, because a collection occurred at 13:15.

A similar limitation exists for **period=last**. If the feature control status of 15-minute measurements is turned on and a report is requested for the last interval prior to the next scheduled measurements collection (based on the current 15-minute measurements status), the start and end times for the period shown in the report will be incorrect. The data presented in the report will correspond to the start and end times. As soon as the next scheduled collection occurs, then **period=last** reports will show the correct start and end times and the corresponding data for that interval. To generate measurements from the last collected interval before the first collection with feature control status on, a **period=specific** report will need to be entered. In the example given in the previous paragraph, the first report requested at 13:10 would not give the last interval, but the data given would correspond to the interval shown in the report. The second report requested at 13:20 would show correct start and end times and the data would correspond to the interval.

If the 15 Minute Measurements collection option is turned from on to off in the first 15 minutes of a half-hour (xx00-xx15 or xx30-xx45) and a demand report is requested in the second 15 minutes of a half-hour (xx15-xx30 or xx45-xx60) for **period=last** or **period** not specified, the report that is displayed will be the last 15-minute interval (xx00-xx15 or xx30-xx45), not the last collected 15-minute interval (xx45-xx00 or xx15-xx30). Collection did not occur during this 15-minute period, and the message “Measurements data not current” will be displayed. To report the last collected 15-minute interval, **period=specific** must be specified in the command with the correct **qh/hh** value.

The time interval in each measurements report shows which collection option was on when the measurements were collected. (This might not be the option that is currently on if the option was changed in the last 24 hours).

Table 5-25 summarizes the impacts of turning on the 15 Minute Measurements collection option.

**Table 5-25.** Impacts on Data Collection of Turning On the 15 Minute Measurements Option

Time Window for Turning On the Option	Impact on Data Collection
xx00-xx15	None. 15 minutes of data will be collected for the quarter-hour xx15.
xx-15-xx30	The xx15 interval will contain no data. The xx30 interval will contain 30 minutes of data
xx30-xx45	None. 15 minutes of data will be collected for the quarter-hour xx15.
xx45-xx00	The xx45 interval will contain no data. The xx00 interval will contain 30 minutes of data

**Output**

```

chg-
measopts:platformenable=on:complink=on:complnkset=on:systotst=off
:systotstp=off
  tekelecstp 08-06-01 14:31:25 EST EAGLE 39.0.0
  CHG-MEASOPTS: MASP A - COMPLTD
;

```

**chg-mrn****Change Mated Relay Node**

Use this command to add new point codes, modify existing point codes and relative costs, and add or modify Alternate RI Mate data in the Mated Relay Node (MRN) table. The Intermediate GTT Load-Sharing (IGTTLS) feature must be on to enter this command. The GTT Load Sharing with Alternate Routing Indicator Feature (GTT LS ARI) must be enabled to provision an Alternate RI Mate.

If the IGTTLS feature is on, and the Flexible GTT Load Sharing feature (FGTTLS) is enabled, then entries are added to or changed in existing MRN sets in the MRN table.

If the IGTTLS feature is on, and the FGTTLS feature is not enabled, then the MRN table can contain a maximum of 3000 entries. If both the IGTTLS and FGTTLS features are on, then the MRN table can contain a maximum of 6000 entries.



**CAUTION:** If any entries are provisioned in the SCCP-SERV table, the maximum number of entries that the MRN table can contain is reduced by that amount. Enter the `rtrv-sccp-serv` command output to see if entries exist in the SCCP-SERV table. See the Notes section for additional information on multiplicity modes.

**Keyword:** `chg-mrn`

**Related Commands:** `dlt-mrn`, `ent-mrn`, `rtrv-mrn`

**Command Class:** Database Administration

**Parameters**

**NOTE:** See "Point Code Formats and Conversion" for a detailed description of point code formats, rules for specification, and examples.

**NOTE:** The `mapset`, `mappc`, and `mapssn` parameters indicate whether an Alternate RI Mate search is performed in the MAP table if all PCs provisioned in a given MRN Set are unavailable or congested.

**:pc=** (mandatory)

ANSI point code with subfields *network indicator-network cluster-network cluster member (ni-nc-ncm)*.

**Synonym:** `pca`

**Range:** **000-255**

Specify a valid value for each subfield of the point code, and separate the subfields with a dash (-).

When `chg-sid:pctype=ansi` is specified, `ni = 000` is not valid.

When `chg-sid:pctype=ansi` is specified, `nc = 000` is not valid if `ni = 001-005`.

When `chg-sid:pctype=ansi` is specified, `nc = 000` is valid if `ni = 006-255`.

The point code **000-000-000** is not a valid point code.

**:pc/pca/pci/pcn/pcn24=** (mandatory)

Post-GTT-translated point code.

**:pci=** (mandatory)

ITU international point code with subfields *zone-area-id*. The *prefix* subfield indicates a spare point code (*prefix-zone-area-id*).

**Range:** **s-, 0-255**

Specify a valid value for each subfield of the point code, and separate the subfields with a dash (-).

*prefix*—**s-**

*zone*—**0-7**

*area*—**000-255**

*id*—**0-7**

The point code **0-000-0** is not a valid point code.

**:pcn=** (mandatory)

ITU national point code in the format of a 5-digit number (*nnnnn*); or 2, 3, or 4 numbers (members) separated by dashes (*m1-m2-m3-m4*) as defined by the **chg-stpopts:npcfmti** flexible point code option. A group code must be specified when the ITUDUPPC feature is turned on (*nnnnn-gc*, *m1-m2-m3-m4-gc*). The *prefix* subfield indicates a spare point code (*prefix-nnnnn*, *prefix-nnnnn-gc*, *prefix-m1-m2-m3-m4*, *prefix-m1-m2-m3-m4-gc*).

**Range:** **s-, 0-16383, aa-zz**

Specify a valid value for each subfield of the point code, and separate the subfields with a dash (-).

*prefix*—**s-**

*nnnnn*—**0-16383**

*gc*—**aa-zz**

*m1-m2-m3-m4*—**0-14** for each member; values must sum to 14

**:pcn24=** (mandatory)

24-bit ITU national point code with subfields *main signaling area-sub signaling area-signaling point* (*msa-ssa-sp*).

**Range:** **000-255**

Specify a valid value for each subfield of the point code, and separate the subfields with a dash (-).

*msa*—**000-255**

*ssa*—**000-255**

*sp*—**000-255**

**:eswt=** (optional)

Entity set weight. This parameter specifies the weight assigned to each PC in a weighted entity set. The Weighted GTT Loadsharing feature must be turned on before this parameter can be specified. This parameter cannot be specified when adding PCs to a weighted entity set or when modifying RC or weight values for an individual PC.

**Range:** **1-99 none**

**none**—Changes a weighted entity set to a non-weighted entity set.

**:force=** (optional)

The **force=yes** parameter must be specified to modify the **rc**, **rc1**, **rc2**, **rc3**, or **rc4** parameter and the **wt**, **wt1**, **wt2**, **wt3**, or **wt4** parameter in the same command.

Modification of the **wt**, **wt1**, **wt2**, **wt3**, or **wt4** parameters is dependent on the parameter's current multiplicity state, which is dependent on the RC value. Changing the **rc** parameter value can change the multiplicity state, which can then cause any of the weight parameter values to become invalid.

**Range:**     **yes**

**:grpwt=** (optional)

Group weight. This parameter specifies the weight assigned to each PC in a weighted RC group. The Weighted GTT Loadsharing feature must be turned on before this parameter can be specified.

This parameter cannot be specified when adding PCs to a weighted entity set or when modifying RC or weight values for an individual PC.

**Range:**     **1-99**

**:mappc=** (optional)

ANSI point code with subfields *network indicator-network cluster-network cluster member (ni-nc-ncm)*.

**Synonym:** **mappca**

**Range:**     **000-255**

Specify a valid value for each subfield of the point code, and separate the subfields with a dash (-).

When **chg-sid:pctype=ansi** is specified, **ni = 000** is not valid.

When **chg-sid:pctype=ansi** is specified, **nc = 000** is not valid if **ni = 001-005**.

When **chg-sid:pctype=ansi** is specified, **nc = 000** is valid if **ni = 006-255**.

The point code **000-000-000** is not a valid point code.

**Default:**   **000-000-000**

**:mappc\mappca\mappci\mappcn\mappcn24=** (optional)

Alternate RI Mate point code.

**:mappci=** (optional)

ITU international point code with subfields *zone-area-id*. The *prefix* subfield indicates a spare point code (*prefix-zone-area-id*).

**Range:**     **s-, 0-255**

Specify a valid value for each subfield of the point code, and separate the subfields with a dash (-).

*prefix*—**s-**

*zone*—**0-7**

*area*—**000-255**

*id*—**0-7**

The point code **0-000-0** is not a valid point code.

**Default:**   **0-000-0**

**:mappcn=** (optional)

ITU national point code in the format of a 5-digit number (*nnnnn*); or 2, 3, or 4 numbers (members) separated by dashes (*m1-m2-m3-m4*) as defined by the **chg-stpopts:npcfmti** flexible point code option. A group code must be specified when the ITUDUPPC feature is turned on (*nnnnn-gc*, *m1-m2-m3-m4-gc*). The *prefix* subfield indicates a spare point code (*prefix-nnnnn*, *prefix-nnnnn-gc*, *prefix-m1-m2-m3-m4*, *prefix-m1-m2-m3-m4-gc*).

**Range:**     **s-, 0-16383, aa-zz**

Specify a valid value for each subfield of the point code, and separate the subfields with a dash (-).

*prefix*—s-  
*nnnnn*—0-16383  
*gc*—aa-zz  
*m1-m2-m3-m4*—0-14 for each member; values must sum to 14

**Default:** 00000

**:mappcn24=** (optional)

24-bit ITU national point code with subfields *main signaling area-sub signaling area-signaling point* (*msa-ssa-sp*).

**Range:** 000-255

Specify a valid value for each subfield of the point code, and separate the subfields with a dash (-).

*msa*—000-255

*ssa*—000-255

*sp*—000-255

**Default:** 000-000-000

**:mapset=** (optional)

Alternate RI Mate MAP Set ID. This parameter specifies the MAP set where Alternate Routing Indicator searches are performed.

**Range:** 1-36000 **dflt**

**dflt**—Default MAP Set

If the **mappc** and **mapssn** parameters are specified, and the **mapset** parameter is not specified, then the **mapset** parameter is automatically set to a value of **dflt**.

**Default:** No change to the current value

**:mapssn=** (optional)

Alternate RI Mate Subsystem Number. This parameter specifies the subsystem number that is used for the Alternate Routing Indicator search.

**Range:** 2-255 \*, **none**

If the **mapssn=\*** parameter is specified, then the values specified for the **mapset** and **mappc** parameters must already exist in the MAP table.

**Default:** No change to the current value

**:mrnset=** (optional)

MRN set ID.

**Range:** 1-3000 **dflt**

**dflt**—Default MRN set.

**:pc1=** (optional)

ANSI point code with subfields *network indicator-network cluster-network cluster member* (*ni-nc-ncm*).

**Synonym:** **pca1**

**Range:** 000-255

Specify a valid value for each subfield of the point code, and separate the subfields with a dash (-).

When **chg-sid:pctype=ansi** is specified, *ni* = 000 is not valid.

When **chg-sid:pctype=ansi** is specified, *nc* = 000 is not valid if *ni* = 001-005.

When **chg-sid:pctype=ansi** is specified, *nc* = 000 is valid if *ni* = 006-255.

The point code 000-000-000 is not a valid point code.

**:pc1/pca1/pci1/pcn1/pcn241=** (optional)

Alternate post-GTT-translated point code.

**:pc2=** (optional)

ANSI point code with subfields *network indicator-network cluster-network cluster member (ni-nc-ncm)*.

**Synonym: pca2**

**Range: 000-255**

Specify a valid value for each subfield of the point code, and separate the subfields with a dash (-).

When **chg-sid:pctype=ansi** is specified, **ni = 000** is not valid.

When **chg-sid:pctype=ansi** is specified, **nc = 000** is not valid if **ni = 001-005**.

When **chg-sid:pctype=ansi** is specified, **nc = 000** is valid if **ni = 006-255**.

The point code **000-000-000** is not a valid point code.

**:pc2/pca2/pci2/pcn2/pcn242=** (optional)

Alternate post-GTT-translated point code.

**:pc3=** (optional)

ANSI point code with subfields *network indicator-network cluster-network cluster member (ni-nc-ncm)*.

**Synonym: pca3**

**Range: 000-255**

Specify a valid value for each subfield of the point code, and separate the subfields with a dash (-).

When **chg-sid:pctype=ansi** is specified, **ni = 000** is not valid.

When **chg-sid:pctype=ansi** is specified, **nc = 000** is not valid if **ni = 001-005**.

When **chg-sid:pctype=ansi** is specified, **nc = 000** is valid if **ni = 006-255**.

The point code **000-000-000** is not a valid point code.

**:pc3/pca3/pci3/pcn3/pcn243=** (optional)

Alternate post-GTT-translated point code.

**:pc4=** (optional)

ANSI point code with subfields *network indicator-network cluster-network cluster member (ni-nc-ncm)*.

**Synonym: pca4**

**Range: 000-255**

Specify a valid value for each subfield of the point code, and separate the subfields with a dash (-).

When **chg-sid:pctype=ansi** is specified, **ni = 000** is not valid.

When **chg-sid:pctype=ansi** is specified, **nc = 000** is not valid if **ni = 001-005**.

When **chg-sid:pctype=ansi** is specified, **nc = 000** is valid if **ni = 006-255**.

The point code **000-000-000** is not a valid point code.

**:pc4/pca4/pci4/pcn4/pcn244=** (optional)

Alternate post-GTT-translated point code.



**:pci1=** (optional)

ITU international point code with subfields *zone-area-id*. The *prefix* subfield indicates a spare point code (*prefix-zone-area-id*).

**Range:** s-, 0-255

Specify a valid value for each subfield of the point code, and separate the subfields with a dash (-).

*prefix*—s-

*zone*—0-7

*area*—000-255

*id*—0-7

The point code **0-000-0** is not a valid point code.

**:pci2=** (optional)

ITU international point code with subfields *zone-area-id*. The *prefix* subfield indicates a spare point code (*prefix-zone-area-id*).

**Range:** s-, 0-255

Specify a valid value for each subfield of the point code, and separate the subfields with a dash (-).

*prefix*—s-

*zone*—0-7

*area*—000-255

*id*—0-7

The point code **0-000-0** is not a valid point code.

**:pci3=** (optional)

ITU international point code with subfields *zone-area-id*. The *prefix* subfield indicates a spare point code (*prefix-zone-area-id*).

**Range:** s-, 0-255

Specify a valid value for each subfield of the point code, and separate the subfields with a dash (-).

*prefix*—s-

*zone*—0-7

*area*—000-255

*id*—0-7

The point code **0-000-0** is not a valid point code.

**:pci4=** (optional)

ITU international point code with subfields *zone-area-id*. The *prefix* subfield indicates a spare point code (*prefix-zone-area-id*).

**Range:** s-, 0-255

Specify a valid value for each subfield of the point code, and separate the subfields with a dash (-).

*prefix*—s-

*zone*—0-7

*area*—000-255

*id*—0-7

The point code **0-000-0** is not a valid point code.

**:pcn1=** (optional)

ITU national point code in the format of a 5-digit number (*nnnnn*); or 2, 3, or 4 numbers (members) separated by dashes (*m1-m2-m3-m4*) as defined by the **chg-stpopts:npcfnti** flexible point code option. A group code must be specified when the ITUDUPPC feature is turned on (*nnnnn-gc*, *m1-m2-m3-m4-gc*). The *prefix* subfield indicates a spare point code (*prefix-nnnnn*, *prefix-nnnnn-gc*, *prefix-m1-m2-m3-m4*, *prefix-m1-m2-m3-m4-gc*).

**Range:** **s-, 0-16383, aa-zz**

Specify a valid value for each subfield of the point code, and separate the subfields with a dash (-).

*prefix*—**s-**

*nnnnn*—**0-16383**

*gc*—**aa-zz**

*m1-m2-m3-m4*—**0-14** for each member; values must sum to 14

**:pcn2=** (optional)

ITU national point code in the format of a 5-digit number (*nnnnn*); or 2, 3, or 4 numbers (members) separated by dashes (*m1-m2-m3-m4*) as defined by the **chg-stpopts:npcfnti** flexible point code option. A group code must be specified when the ITUDUPPC feature is turned on (*nnnnn-gc*, *m1-m2-m3-m4-gc*). The *prefix* subfield indicates a spare point code (*prefix-nnnnn*, *prefix-nnnnn-gc*, *prefix-m1-m2-m3-m4*, *prefix-m1-m2-m3-m4-gc*).

**Range:** **s-, 0-16383, aa-zz**

Specify a valid value for each subfield of the point code, and separate the subfields with a dash (-).

*prefix*—**s-**

*nnnnn*—**0-16383**

*gc*—**aa-zz**

*m1-m2-m3-m4*—**0-14** for each member; values must sum to 14

**:pcn241=** (optional)

24-bit ITU national point code with subfields *main signaling area-sub signaling area-signaling point* (*msa-ssa-sp*).

**Range:** **000-255**

Specify a valid value for each subfield of the point code, and separate the subfields with a dash (-).

*msa*—**000-255**

*ssa*—**000-255**

*sp*—**000-255**

**:pcn242=** (optional)

24-bit ITU national point code with subfields *main signaling area-sub signaling area-signaling point* (*msa-ssa-sp*).

**Range:** **000-255**

Specify a valid value for each subfield of the point code, and separate the subfields with a dash (-).

*msa*—**000-255**

*ssa*—**000-255**

*sp*—**000-255**

**:pcn243=** (optional)

24-bit ITU national point code with subfields *main signaling area-sub signaling area-signaling point (msa-ssa-sp)*.

**Range:**     **000-255**

Specify a valid value for each subfield of the point code, and separate the subfields with a dash (-).

*msa*—**000-255**

*ssa*—**000-255**

*sp*—**000-255**

**:pcn244=** (optional)

24-bit ITU national point code with subfields *main signaling area-sub signaling area-signaling point (msa-ssa-sp)*.

**Range:**     **000-255**

Specify a valid value for each subfield of the point code, and separate the subfields with a dash (-).

*msa*—**000-255**

*ssa*—**000-255**

*sp*—**000-255**

**:pcn3=** (optional)

ITU national point code in the format of a 5-digit number (*nnnnn*); or 2, 3, or 4 numbers (members) separated by dashes (*m1-m2-m3-m4*) as defined by the **chg-stpopts:npcfmti** flexible point code option. A group code must be specified when the ITUDUPPC feature is turned on (*nnnnn-gc, m1-m2-m3-m4-gc*). The *prefix* subfield indicates a spare point code (*prefix-nnnnn, prefix-nnnnn-gc, prefix-m1-m2-m3-m4, prefix-m1-m2-m3-m4-gc*).

**Range:**     **s-, 0-16383, aa-zz**

Specify a valid value for each subfield of the point code, and separate the subfields with a dash (-).

*prefix*—**s-**

*nnnnn*—**0-16383**

*gc*—**aa-zz**

*m1-m2-m3-m4*—**0-14** for each member; values must sum to 14

**:pcn4=** (optional)

ITU national point code in the format of a 5-digit number (*nnnnn*); or 2, 3, or 4 numbers (members) separated by dashes (*m1-m2-m3-m4*) as defined by the **chg-stpopts:npcfmti** flexible point code option. A group code must be specified when the ITUDUPPC feature is turned on (*nnnnn-gc, m1-m2-m3-m4-gc*). The *prefix* subfield indicates a spare point code (*prefix-nnnnn, prefix-nnnnn-gc, prefix-m1-m2-m3-m4, prefix-m1-m2-m3-m4-gc*).

**Range:**     **s-, 0-16383, aa-zz**

Specify a valid value for each subfield of the point code, and separate the subfields with a dash (-).

*prefix*—**s-**

*nnnnn*—**0-16383**

*gc*—**aa-zz**

*m1-m2-m3-m4*—**0-14** for each member; values must sum to 14

**:rc=** (optional)

Relative cost. This parameter specifies the relative cost of the route for the primary PC.

**Range: 0-99**

**:rc 1=** (optional)

The relative cost of the route for alternate post-GTT-translated point code 1.

**:rc1=** (optional)

Relative cost 1. This parameter specifies the relative cost of the route for mate PC 1.

**Range: 0-99**

**:rc2=** (optional)

Relative cost 2. This parameter specifies the relative cost of the route for mate PC 2.

**Range: 0-99**

**:rc3=** (optional)

Relative cost 3. This parameter specifies the relative cost of the route for mate PC 3.

**Range: 0-99**

**:rc4=** (optional)

Relative cost 4. This parameter specifies the relative cost of the route for mate PC 4.

**Range: 0-99**

**:thr=** (optional)

Threshold. This parameter specifies the in-service threshold of all PCs in a weighted entity set or RC group. The Weighted GTT Loadsharing feature must be turned on before this parameter can be specified.

This parameter cannot be specified when adding PCs to a weighted entity set or RC group or when modifying RC or weight values for an individual PC.

If the **thr** parameter is not specified, a value of **1%** is assigned to each weighted PC.

**Range: 1-100**

**:wt=** (optional)

Weight. This parameter specifies the new weight assigned to the primary PC. The Weighted GTT Loadsharing feature must be turned on before this parameter can be specified.

This parameter cannot be specified when adding PCs to a weighted entity set.

**Range: 1-99**

**:wt1=** (optional)

Weight 1. This parameter specifies the weight assigned to the mate PC 1 that is being added to the weighted entity set. The Weighted GTT Loadsharing feature must be turned on before this parameter can be specified.

**Range: 1-99**

**:wt2=** (optional)

Weight 2. This parameter specifies the weight assigned to the mate PC 2 that is being added to the weighted entity set. The Weighted GTT Loadsharing feature must be turned on before this parameter can be specified.

**Range: 1-99**

**:wt3=** (optional)

Weight 3. This parameter specifies the weight assigned to the mate PC 3 that is being added to the weighted entity set. The Weighted GTT Loadsharing feature must be turned on before this parameter can be specified.

**Range: 1-99**

**:wt4=** (optional)

Weight 4. This parameter specifies the weight assigned to the mate PC 4 that is being added to the weighted entity set. The Weighted GTT Loadsharing feature must be turned on before this parameter can be specified.

**Range:** 1-99

### Example

In the following example, the system searches the MRN table for a point code of 1-1-0. If the point code is found, its relative cost is set to 40.

**chg-mrn:pc=1-1-0:rc=40**

In the following example, the system searches the MRN table for point code 1-1-0. Having found it, the system then searches the entity set for 1-1-10. If 1-1-10 is not in the entity set, the command will add point code 1-1-10 to the entity set and assign it a relative cost of 30.

**chg-mrn:pc=1-1-0:pc1=1-1-10:rc1=30**

In the following example, the system searches the MRN table for a point code of 1-1-0. Having found it, the system then searches for each of the two specified associated point codes in the entity set. If neither of the associated point codes are found, the specified point codes and their relative costs are inserted into the entity set in the MRN table.

**chg-mrn:pc=1-1-0:pc1=1-1-1:rc1=10:pc2=1-1-10:rc2=20**

The following examples include spare point codes.

**chg-mrn:pcn=s-1-1-1-123-aa:rc=1:pcn1=s-1-1-1-235-aa:rc1=2:pcn2=s-1-1-1-235-aa:rc2=3**

**chg-**

**mrn:pci=s-2-2-1:rc=20:pci1=s-2-2-2:rc1=21:pci2=s-2-100-1:rc2=22**

**chg-mrn:pc=1-1-1:rc=30:mrnset=df1t**

**chg-mrn:pc=1-1-1:rc=20:pc1=2-2-2:rc1=20:mrnset=111**

**chg-mrn:pc=1-1-1:pc1=3-3-3:rc1=30:mrnset=111**

The following examples change a non-weighted entity set to a weighted entity set.

**chg-mrn:pc=1-1-1:eswt=30**

**chg-mrn:pc=1-1-1:eswt=30:thr=50**

The following example changes a weighted entity set to a non-weighted entity set.

**chg-mrn:pc=1-1-1:eswt=none**

The following example assigns a weight value to each PC in a weighted RC group within a weighted entity set.

**chg-mrn:pc=1-1-1:grpwt=20**

The following example assigns a threshold value to each PC in the RC group within a weighted entity set.

**chg-mrn:pc=1-1-1:thr=70**

The following example assigns a weight and threshold to each PC in an RC group within a weighted entity set.

**chg-mrn:pc=1-1-1:grpwt=20:thr=70**

The following example assigns PC 1-1-1 a weight of 30.

**chg-mrn:pc=1-1-1:wt=30**

The following example adds PC 1-1-10 to the weighted entity set containing PC 1-1-0 and assigns PC 1-1-10 an RC of 30 and a weight of 20.

```
chg-mrn:pc=1-1-0:pc1=1-1-10:rc1=30:wt1=20
```

The following example assigns specified PCs and their associated RCs and weights to the weighted entity set that contains the point code 1-1-0.

```
chg-mrn:pc=1-1-0:pc1=1-1-1:rc1=10:wt1=35:pc2=1-1-10:rc2=20:wt2=20
```

The following example modifies both RC values and weights for PCs in an existing weighted entity set.

```
chg-  
mrn:pc=1-1-0:rc=30:wt=10:pc1=1-1-10:rc1=20:pc2=1-1-2:wt2=5:force=  
yes
```

The following example modifies only weights for PCs in an existing weighted entity set.

```
chg-mrn:pc=1-1-0:wt=10:pc1=1-1-10:wt1=20:pc2=1-1-2:wt2=5  
chg-mrn:pc=1-1-1:mrnset=111:mapset=df1t:mappc=2-1-1:mapssn=10  
chg-mrn:pc=1-1-1:mrnset=111:mapssn=*  
chg-mrn:pc=1-1-1:mrnset=111:mapset=1:mappc=2-1-2:mapssn=12  
chg-mrn:pci=1-002-1:mrnset=10:mapset=2:mappcn=00126:mapssn=12
```

## Dependencies

The Intermediate Global Title Translation Load Sharing feature must be turned on before this command can be entered.

The **apca** and **pcn24** parameters cannot be specified for the same MRN set.

When a new point code is specified, its relative cost (**rc**) must be specified; a new point code and its relative cost must be entered together in the command.

A new point code that is specified in the command must not already exist in the MRN table.

The point codes cannot have the same value as the EAGLE 5 ISS SID.

The same point code value cannot be entered more than once in the MRN table.

Each point code group can contain a maximum of 32 point codes.

ITU-N point codes must be in the format set by the **npcfnti** parameter of the **chg-stpopts** command. (Use the **rtvr-stpopts** command to display the STP option settings).

Mate remote point codes must already exist as destinations in the Ordered Route entity set or reside in a cluster destination for which ordered routes are specified.

To change the relative cost for a point code, the point code must already exist in the MRN table.

The Flexible GTT Loadsharing feature must be enabled before the **mrnset** parameter can be specified..

If the Flexible GTT Loadsharing feature is enabled, the specified PC must already exist in the specified MRN set.

The specified MRN set must already exist in the MRN table.

One or more point codes in the command will exceed the maximum number of point codes that can be entered into the MRN table (3000 if the IGTTLS feature is turned on and 6000 if the IGTTLS and FGTTLS features are turned on).

The Weighted GTT Loadsharing feature must be turned on before the **wt/wt1/wt2/wt3/wt4**, **eswt**, **grpwt**, or **thr** parameter can be specified.

If the **rc** parameter is not specified, the **wt** parameter cannot be specified.

The **eswt** and **grpwt** parameters cannot be specified together in the command.

If the **eswt=none** parameter is specified, the **thr** parameter cannot be specified.

If the **eswt**, **grpwt**, or **thr** parameters are specified, the **rc/rc1/rc2/rc3/rc4** and **wt/wt1/wt2/wt3/wt4** parameters cannot be specified.

If the Weighted GTT Loadsharing feature is enabled, and individual PCs are being modified, the **wt** or **rc** parameter must be specified for each PC.

Alternate point codes cannot be specified when modifying an entity set or RC group.

If the **pc1/pc2/pc3/pc4** parameter is specified for a weighted entity set, a corresponding **wt1/wt2/wt3/wt4** parameter must be specified.

If the **pc1/pc2/pc3/pc4** parameter is specified for a non-weighted entity set, the **wt1/wt2/wt3/wt4** parameter cannot be specified.

The **eswt=none** parameter cannot be specified for non-weighted entity sets.

The **grpwt** and **thr** parameters cannot be specified for non-weighted entity sets.

At least one additional point code must be specified.

If the **wt/wt1/wt2/wt3/wt4** parameter is specified, the corresponding **pc/pc1/pc2/pc3/pc4** parameter must be specified.

The **pc/pc1/pc2/pc3/pc4** parameter values must be full point codes.

At least one optional parameter must be specified.

If the Weighted GTT Loadsharing feature is not enabled, and individual PCs are being modified, the **rc** parameter must be specified for each PC.

The **eswt**, **grpwt**, and **thr** parameters cannot be specified for solitary or dominant entity sets.

If the **chg-sid:pctype=ansi** command is entered, a value of *ni=000* cannot be specified. If the **chg-sid:pctype=ansi** command is entered, and a value of *ni=001 – 005* is specified, a value of *nc=000* cannot be specified.

The **force=yes** parameter must be specified before the **rc**, **rc1**, **rc2**, **rc3**, or **rc4** parameter can be specified in the same command with the **wt**, **wt1**, **wt2**, **wt3**, or **wt4** parameter.

The **force** parameter can be used only to specify the **rc**, **rc1**, **rc2**, **rc3** or **rc4** parameter and the **wt**, **wt1**, **wt2**, **wt3**, or **wt4** parameter in the same command.

The value specified for the **pc/pc1/pc2/pc3/pc4** parameter cannot be associated with a proxy point code.

The GTT LS ARI feature must be enabled before the **mapset**, **mappc**, or **mapssn** parameter can be specified.

The value specified for the **mappc** parameter must be a full point code.

The point codes and alternate RI Mate point codes must have the same network type. Table 5-26 displays the allowed PC and Alternate RI Mate PC combinations.

**Table 5-26.** Allowed PC and Alternate RI Mate PC Combinations

Network Type of PC	Allowed Network Type of Alternate ARI Mate PC
ITU-I, ITU-N, ITU-I spare, ITU-N spare	ITU-I, ITU-N, ITU-I spare, ITU-N spare
ANSI	ANSI
ITUN-24	ITUN-24

The value specified for the **mapset** parameter must already exist in the MAP table.

The values specified for the **mappc** and **mapssn** parameters must already exist in the specified MAP Set.

The values specified for the **mapset** and **mappc** parameters must already exist in the MAP table.

The value specified for the **mappc** parameter cannot match an existing STP point code.

The **mappc** and **mapssn** parameters must be specified together in the command.

### Notes

For the MRN commands, an entity set consists of a group of PCs that are used for traffic distribution, and an RC group consists of PCs within an entity set that have the same RC. In loadsharing mode, an entity set contains 1 RC group. In combined/dominant loadsharing mode, an entity set can contain multiple loadsharing groups.

All of the point codes that are specified in one command must exist in the same point code group in the MRN table.

In this command, only ITU-international and ITU national point codes support the spare point code subtype prefix (s-).

The EAGLE 5 ISS supports the following multiplicity modes for nodes/subsystems.

- A group of replicated PCs are in *dominant* mode if each PC in the group has a unique RC. The specified subsystem with the lowest RC acts as the primary subsystem, while the mate subsystem acts as a backup. In the event of congestion, messages route to the mate subsystem. When the congestion subsides, messages are again routed to the primary (dominant) subsystem.
- A group of replicated PCs are in *load sharing* mode if each PC in the group has the same RC. All messages are evenly distributed at the SCCP level to all nodes/subsystems in the group. In the event of congestion or failure, the non-affected subsystem assumes the load of its failed or congested mate.
- The *combined load sharing/dominant* mode supports a combination of load sharing and dominant mode. A group of PCs are in combined load sharing/dominant mode when at least two of the PCs have the same RC and another node subsystem in the group has a different RC. A combination of node accessibility and RC determines the preferred PC.

When the Weighted GTT Loadsharing feature is turned on, weighted entity sets and RC groups are supported, and threshold values can be assigned to each PC.

When the GTT LS ARI feature is enabled, the Alternate RI Mate for an MRN Set can be provisioned.



**Output**

```

chg-mrn:pci=1-1-2:mrnset=111:mapset=10:mappc=1-1-1:mapssn=*
tekelecstp 08-12-22 15:43:00 EST EAGLE 40.1.0
chg-mrn:pci=1-1-2:mrnset=111:mapset=10:mappc=1-1-1:mapssn=*
Command entered at terminal #4.
CHG-MAP: MASP A - COMPLTD
;

```

**chg-mtc-measopts****Change Maintenance Measurements Options**

Use this command to enable or disable the automatic generation and FTP transfer of scheduled maintenance measurements reports to the FTP server.

**Keyword:** **chg-mtc-measopts**

**Related Commands:** **chg-ftp-serv, chg-meas, chg-measopts, chg-netopts, dlt-ftp-serv, ent-ftp-serv, rept-ftp-meas, rept-meas, rept-stat-meas, rtrv-ftp-serv, rtrv-measopts, rtrv-mtc-measopts, rtrv-netopts**

**Command Class:** Link Maintenance

**Parameters**

**:mtcdatinpq=** (optional)

Activates or deactivates the automatic generation and FTP transfer of the scheduled daily maintenance measurement report for ATI Number Portability Query (ATINP).

**Range:** **on, off**

**Default:** No change to the current value

**System**

**Default:** **off**

**:mtcdeir=** (optional)

Activates or deactivates the automatic generation and FTP transfer of the daily maintenance measurement report for Equipment Identity Register (EIR).

**Range:** **on, off**

**Default:** No change to the current value

**System**

**Default:** **off**

**:mtcdlink=** (optional)

Activates or deactivates the automatic generation and FTP transfer of the daily maintenance measurement report for links.

**Range:** **on, off**

**Default:** No change to the current value

**System**

**Default:** **off**

**:mtcdlnkset=** (optional)

Activates or deactivates the automatic generation and FTP transfer of the daily maintenance measurement report for link sets.

**Range:** **on, off**

**Default:** No change to the current value

**System**

**Default:** **off**

**:mtcdlnp=** (optional)

Activates or deactivates the automatic generation and FTP transfer of the scheduled daily maintenance measurement report for LNP.

**Range:** on, off

**Default:** No change to the current value

**System**

**Default:** off

**:mtcdmap=** (optional)

Activates or deactivates the automatic generation and FTP transfer of the scheduled daily maintenance measurement report per GSM MAP Screening server entry.

**Range:** on, off

**Default:** No change to the current value

**System**

**Default:** off

**:mtcdnp=** (optional)

Activates or deactivates the automatic generation and FTP transfer of the scheduled daily maintenance measurement report for INP.

**Range:** on, off

**Default:** No change to the current value

**System**

**Default:** off

**:mtcdsctpasoc=** (optional)

Activates or deactivates the automatic generation and FTP transfer of the scheduled daily maintenance measurement report for per association SCTP data.

**Range:** on, off

**Default:** No change to the current value

**:mtcdsctpcard=** (optional)

Activates or deactivates the automatic generation and FTP transfer of the scheduled daily maintenance measurement report for per card SCTP data.

**Range:** on, off

**Default:** No change to the current value

**:mtcdstp=** (optional)

Activates or deactivates the automatic generation and FTP transfer of the daily maintenance measurement report for STP.

**Range:** on, off

**Default:** No change to the current value

**System**

**Default:** off

**:mtcdstplan=** (optional)

Activates or deactivates the automatic generation and FTP transfer of the daily maintenance measurement report for STPLAN.

**Range:** on, off

**Default:** No change to the current value

**System**

**Default:** off

**:mtcdua=** (optional)

Activates or deactivates the automatic generation and FTP transfer of the scheduled daily maintenance measurement report for M3UA and SUA application server/association pairs.

**Range:** on, off  
**Default:** No change to the current value  
**System**  
**Default:** off

**:mtcdvflex=** (optional)

Activates or deactivates the automatic generation and FTP transfer of the daily maintenance measurement report for V-Flex (Voice Mail Router).

**Range:** on, off  
**Default:** No change to the current value  
**System**  
**Default:** off

**:mtchatinpq=** (optional)

Activates or deactivates the automatic generation and FTP transfer of the scheduled hourly maintenance measurement report of Any Time Interrogation (ATI) Number Portability (NP) Queries.

**Range:** on, off  
**Default:** No change to the current value  
**System**  
**Default:** off

**:mtcheir=** (optional)

Activates or deactivates the automatic generation and FTP transfer of the scheduled hourly maintenance measurement report for Equipment Identity Register (EIR).

**Range:** on, off  
**Default:** No change to the current value  
**System**  
**Default:** off

**:mtchlnp=** (optional)

Activates or deactivates the automatic generation and FTP transfer of the scheduled hourly maintenance measurement report for LNP.

**Range:** on, off  
**Default:** No change to the current value  
**System**  
**Default:** off

**:mtchmap=** (optional)

Activates or deactivates the automatic generation and FTP transfer of scheduled hourly maintenance measurement report per GSM MAP Screening server entry.

**Range:** on, off  
**Default:** No change to the current value  
**System**  
**Default:** off

**:mtchnp=** (optional)

Activates or deactivates the automatic generation and FTP transfer of the scheduled hourly maintenance measurement report for INP.

**Range:** on, off  
**Default:** No change to the current value  
**System**  
**Default:** off

**:mtchvflex=** (optional)

Activates or deactivates the automatic generation and FTP transfer of the scheduled hourly maintenance measurement report for V-Flex (Voice Mail Router).

**Range:** on, off  
**Default:** No change to the current value  
**System Default:** off

### Example

```
chg-mtc-measopts:mtcdeir=off:mtcheir=on
chg-mtc-measopts:mtchvflex=on:mtcdvflex=on
```

### Dependencies

The Measurements Platform feature must be on before this command can be entered.

The LNP feature must be turned on (see the **enable-ctrl-feat** command) before the **mtchlnp=on** parameter or the **mtcdlnp=on** parameter can be specified.

The GSM Map Screening (GSMSCR) feature must be turned on before the **mtcdmap=on** parameter or the **mtchmap=on** parameter can be specified.

The Equipment Identity Register (EIR) feature must be turned on before the **mtcheir=on** parameter or the **mtcdeir=on** parameter can be specified.

This command is not allowed while in upgrade mode.

The V-Flex feature must be turned on before the **mtchvflex=on** parameter or the **mtcdvflex=on** parameter can be specified.

The ATINP feature must be enabled before the **mtchatinpq=on** parameter or the **mtcdatinpq=on** parameter can be specified.

The A-Port, G-Port, IS41 GSM Migration, MO SMS IS41-to-GSM Migration, MO-based GSM SMS NP, MO-based IS41 SMS NP, Prepaid SMS Intercept Ph1, TIF ASD, TIF GRN, TIF Number Portability, or TIF Simple Number Substitution feature must be enabled, or the INP feature must be turned on before the **mtchnp=on** parameter or the **mtcdnp=on** parameter can be specified.

### Notes

Activated scheduled reports are generated and transferred to the customer's FTP server

The **rept-ftp-meas** command can be used to manually generate and transfer one report at a time as needed.

The *Maintenance Manual* provides detailed information on measurements and measurement reports.

### Output

```
chg-mtc-measopts:mtchvflex=on:mtcdvflex=on
tekelecstp 08-06-01 14:31:25 EST EAGLE 39.20.0
CHG-MTC-MEASOPTS: MASP A - COMPLTD
;
```

## chg-netopts

## Change Network Options

Use this command to change the Private Virtual Network (PVN) address and PVN subnet mask values for the IP networks and the network address and subnet mask values for the Fast Copy networks used by the EAGLE 5 ISS.

**Keyword:** chg-netopts

**Related Commands:** rtrv-netopts

**Command Class:** Database Administration

**Parameters**

**:fcna=** (optional)

Fast Copy Network A. This parameter specifies the network address for the Fast Copy A network.

**NOTE: The fcna parameter consists of a classless Inter Domain Routing (Supernet) address with a network prefix of up to 23 bits.**

**Range: 0.0.2.0-255.255.253.0**

The last 9 bits are zero (0) and are reserved for the Host ID.

**Default:** No change to the current value

**System**

**Default: 172.21.48.00**

**:fcnb=** (optional)

Fast Copy Network B. This parameter specifies the network address for the Fast Copy B network.

**NOTE: The fcnb parameter consists of a classless Inter Domain Routing (Supernet) address with a network prefix of up to 23 bits.**

**Range: 0.0.2.0-255.255.253.0**

The last 9 bits are zero (0) and are reserved for the Host ID.

**Default:** No change to the current value

**System**

**Default: 172.22.48.00**

**:pvn=** (optional)

Private Virtual Network (PVN) address for the EAGLE 5 ISS. The value must be valid for a Class B network IP address.

**Range: 128.0.0.0-191.255.0.0**

4 numbers separated by dots in the range **128.0.0.0** to **191.255.0.0**

**Default:** No change to the current value

**System**

**Default: 172.20.48.00**

**:pvnmask=** (optional)

Subnet mask for the EAGLE 5 ISS PVN. An IP address with a restricted range of values.

**Range:** The value must be valid for a Class B network IP address as shown in the following table.

**Table 5-27.** Valid PVN Subnet Mask Values

<b>Valid for Class B Networks</b>	
255.255.0.0	255.255.248.0
255.255.192.0	255.255.252.0
255.255.224.0	255.255.254.0
255.255.240.0	255.255.255.128

**Default:** No change to the current value

**System**

**Default: 255.255.252.00**

**Example**

```
chg-netopts:pvn=170.120.50.1:pvnmask=255.255.252.0
chg-netopts:fcna=170.120.50.0
chg-netopts:fcnb=172.121.50.0
```

**Dependencies**

At least one pair of optional parameters must be specified in the command (i.e. **pvn** and **pvnmask** or **fcna** and **fcnb**).

The **pvn** and **pvnmask** IP addresses cannot have the same value.

The **pvn** and **pvnmask** parameters must be specified together in the command.

The IP network address specified by the **pvn** and **pvnmask** parameters or the **fcna** and **fcnb** parameters must be different from the IP network addresses assigned to Ethernet interface A or B for the IPGWx, IPLIMx, and FC-capable cards.

The IP Network address specified by the **pvn** and **pvnmask** parameters or the **fcna** and **fcnb** parameters cannot have an existing route in the IP Route table.

The E5IS feature bit must be turned on (see the **chg-feat** command) before this command can be specified.

The value specified for the **fcna** parameter must be a classless Inter Domain Routing (Supernet) address with a 23-bit network prefix.

The value specified for the **fcnb** parameter must be a classless Inter Domain Routing (Supernet) address with a 23-bit network prefix.

If the **fcmode=fcopy** parameter is specified (see the **chg-eisopts** command), then the **fcna** and **fcnb** parameters cannot be specified.

The **eiscopy=off** parameter must be specified (see the **chg-eisopts** command) before the **pvn** or **pvnmask** parameter can be specified.

The same value cannot be specified for the **pvn**, **fcna**, and **fcnb** parameters.

The same value cannot be specified for the **fcna** and **fcnamask** parameters.

The same value cannot be specified for the **fcnb** and **fcnbmask** parameters.

**Notes****Fast Copy Cards**

A card that can run the Fast Copy interface is referred to as an *FC-capable* card. Currently, E5-ENET cards running the **ipsg** application are the only supported FC-capable cards. After the **fcmode=fcopy** parameter is specified (see the **chg-eisopts** command) for an FC-capable card, the card is referred to as an *FC-enabled* card.

**Output**

```
chg-netopts:fcna=170.120.50.0
r1ghncxa03w 08-12-11 16:37:58 IST EAGLE 40.1.0
CHG-NETOPTS: MASP A - COMPLTD
;
```

**chg-npp-as****Change a NPP Action Set**

Use this command to change a Numbering Plan Processor (NPP) Action Set (AS). An AS is used by the NPP to assist with digit string filtering, conditioning, and encoding for selected EAGLE 5 ISS applications. An AS is a collection of NPP Conditioning Actions (CAs), Service Actions (SAs), and Formatting Actions (FAs).

**Keyword:** chg-npp-as

**Related Commands:** chg-npp-as, dlt-npp-as, rtrv-npp-as

**Command Class:** Database Administration

### Parameters

**NOTE:** Release 41.1 introduces the ability to provision the CA, FA, and SA values using either a comma-separated list or individual caX, saX, and faX parameters.

**NOTE:** CAs and FAs are processed in consecutive order. If the comma-separated list is used, then the CAs and FAs are processed in the order that they are specified in the list. If individual parameters are used, then the CAs and FAs do not have to be specified in consecutive numerical order. However, they must be consecutively numbered within the command and must contain ca1 or fa1, respectively.

**NOTE:** SAs are processed in order of high-to-low precedence. If the comma-separated list is used, then the SAs must be specified in high-to-low precedence order in the list, and cannot be duplicated in the list. If multiple SAs have the same precedence, then the SAs are processed in the order in which they appear in the list. If individual parameters are used, then the SA with the highest precedence must be assigned as the value for sa1, and additional SAs must be assigned in descending precedence to consecutively numbered parameters. The SA parameters do not have to be specified in consecutive numerical order in the command. However, they must be consecutively numbered within the command and must contain sa1.

**NOTE:** The ac\*, dn\*, sn\*, and cc\* values refer to all CAs that begin with ac, dn, sn, or cc, respectively.

**NOTE:** To change the value of a single CA, FA, or SA within an AS, all of the associated parameters that were specified for that CA, FA, or SA for the AS must be entered.

**NOTE:** Refer to the *Numbering Plan Processor (NPP) Overview* and to the Feature Manual for the feature of interest for more information on provisioning Action Sets and for definitions for the CA, FA, and SA values.

**:asn=** (mandatory)

Action set name. This parameter specifies the name of the AS.

**Range:** ayyyyyyyyy  
1 alphabetic character followed by up to 9 alphanumeric characters

**:ca=** (optional)

Conditioning Action list. This parameter specifies a comma-separated CA list that can be applied to an incoming digit string. Up to 12 CAs can be specified in the list. The CAs are processed in the order they are specified in the list.

**Range:** ign1, ign2, ign3, ign4, ign5, ign6, ign7, ign8, ign9, ign10, pfx, pfxa1, pfxa2, pfxa3, pfxa4, pfxa5, pfxa6, pfxa7, pfxa8, pfxb1, pfxb2, pfxb3, pfxb4, pfxb5, pfxb6, pfxb7, pfxb8, pfxc1, pfxc2, pfxc3, pfxc4, pfxc5, pfxc6, pfxc7, pfxc8, pfxd1, pfxd2, pfxd3, pfxd4, pfxd5, pfxd6, pfxd7, pfxd8, pfxe1, pfxe2, pfxe3, pfxe4, pfxe5, pfxe6, pfxe7, pfxe8, pfxf1, pfxf2, pfxf3, pfxf4, pfxf5, pfxf6, pfxf7, pfxf8, cc1, cc2, cc3, ccdef, ac1, ac2, ac3, ac4, ac5, ac6, ac7, ac8, sn1, sn2, sn3, sn4, sn5, sn6, sn7, sn8, sn9, sn10, sn11, sn12, sn13, sn14, sn15, snx, dn1, dn2, dn3, dn4, dn5, dn6, dn7, dn8, dn9, dn10, dn11, dn12, dn13, dn14, dn15, dnx, znx, aclac, accgpn, acdef, cccgpn

**:ca1=** (optional)

Conditioning action 1. This parameter specifies the first CA that can be applied to an incoming digit string.

**Range:** ign1, ign2, ign3, ign4, ign5, ign6, ign7, ign8, ign9, ign10, fpx, pfxa1, pfxa2, pfxa3, pfxa4, pfxa5, pfxa6, pfxa7, pfxa8, pfb1, pfb2, pfb3, pfb4, pfb5, pfb6, pfb7, pfb8, pfc1, pfc2, pfc3, pfc4, pfc5, pfc6, pfc7, pfc8, pfd1, pfd2, pfd3, pfd4, pfd5, pfd6, pfd7, pfd8, pxe1, pxe2, pxe3, pxe4, pxe5, pxe6, pxe7, pxe8, pxf1, pxf2, pxf3, pxf4, pxf5, pxf6, pxf7, pxf8, cc1, cc2, cc3, cdef, ac1, ac2, ac3, ac4, ac5, ac6, ac7, ac8, sn1, sn2, sn3, sn4, sn5, sn6, sn7, sn8, sn9, sn10, sn11, sn12, sn13, sn14, sn15, snx, dn1, dn2, dn3, dn4, dn5, dn6, dn7, dn8, dn9, dn10, dn11, dn12, dn13, dn14, dn15, dnx, znx, aclac, accgpn, acdef, cccgpn

**:ca10=** (optional)

Conditioning action 10. This parameter specifies the tenth CA that can be applied to an incoming digit string.

**Range:** ign1, ign2, ign3, ign4, ign5, ign6, ign7, ign8, ign9, ign10, fpx, pfxa1, pfxa2, pfxa3, pfxa4, pfxa5, pfxa6, pfxa7, pfxa8, pfb1, pfb2, pfb3, pfb4, pfb5, pfb6, pfb7, pfb8, pfc1, pfc2, pfc3, pfc4, pfc5, pfc6, pfc7, pfc8, pfd1, pfd2, pfd3, pfd4, pfd5, pfd6, pfd7, pfd8, pxe1, pxe2, pxe3, pxe4, pxe5, pxe6, pxe7, pxe8, pxf1, pxf2, pxf3, pxf4, pxf5, pxf6, pxf7, pxf8, cc1, cc2, cc3, cdef, ac1, ac2, ac3, ac4, ac5, ac6, ac7, ac8, sn1, sn2, sn3, sn4, sn5, sn6, sn7, sn8, sn9, sn10, sn11, sn12, sn13, sn14, sn15, snx, dn1, dn2, dn3, dn4, dn5, dn6, dn7, dn8, dn9, dn10, dn11, dn12, dn13, dn14, dn15, dnx, znx, aclac, accgpn, acdef, cccgpn

**:ca11=** (optional)

Conditioning action 11. This parameter specifies the eleventh CA that can be applied to an incoming digit string.

**Range:** ign1, ign2, ign3, ign4, ign5, ign6, ign7, ign8, ign9, ign10, fpx, pfxa1, pfxa2, pfxa3, pfxa4, pfxa5, pfxa6, pfxa7, pfxa8, pfb1, pfb2, pfb3, pfb4, pfb5, pfb6, pfb7, pfb8, pfc1, pfc2, pfc3, pfc4, pfc5, pfc6, pfc7, pfc8, pfd1, pfd2, pfd3, pfd4, pfd5, pfd6, pfd7, pfd8, pxe1, pxe2, pxe3, pxe4, pxe5, pxe6, pxe7, pxe8, pxf1, pxf2, pxf3, pxf4, pxf5, pxf6, pxf7, pxf8, cc1, cc2, cc3, cdef, ac1, ac2, ac3, ac4, ac5, ac6, ac7, ac8, sn1, sn2, sn3, sn4, sn5, sn6, sn7, sn8, sn9, sn10, sn11, sn12, sn13, sn14, sn15, snx, dn1, dn2, dn3, dn4, dn5, dn6, dn7, dn8, dn9, dn10, dn11, dn12, dn13, dn14, dn15, dnx, znx, aclac, accgpn, acdef, cccgpn

**:ca12=** (optional)

Conditioning action 12. This parameter specifies the twelfth CA that can be applied to an incoming digit string.

**Range:** ign1, ign2, ign3, ign4, ign5, ign6, ign7, ign8, ign9, ign10, fpx, pfxa1, pfxa2, pfxa3, pfxa4, pfxa5, pfxa6, pfxa7, pfxa8, pfb1, pfb2, pfb3, pfb4, pfb5, pfb6, pfb7, pfb8, pfc1, pfc2, pfc3, pfc4, pfc5, pfc6, pfc7, pfc8, pfd1, pfd2, pfd3, pfd4, pfd5, pfd6, pfd7, pfd8, pxe1, pxe2, pxe3, pxe4, pxe5, pxe6, pxe7, pxe8, pxf1, pxf2, pxf3, pxf4, pxf5, pxf6, pxf7, pxf8, cc1, cc2, cc3, cdef, ac1, ac2, ac3, ac4, ac5, ac6, ac7, ac8, sn1, sn2, sn3, sn4, sn5, sn6, sn7, sn8, sn9, sn10, sn11, sn12, sn13, sn14, sn15, snx, dn1, dn2, dn3, dn4, dn5, dn6, dn7, dn8, dn9, dn10, dn11, dn12, dn13, dn14, dn15, dnx, znx, aclac, accgpn, acdef, cccgpn



**:ca2=** (optional)

Conditioning action 2. This parameter specifies the second CA that can be applied to an incoming digit string.

**Range:** ign1, ign2, ign3, ign4, ign5, ign6, ign7, ign8, ign9, ign10, fpx, pfxa1, pfxa2, pfxa3, pfxa4, pfxa5, pfxa6, pfxa7, pfxa8, pfb1, pfb2, pfb3, pfb4, pfb5, pfb6, pfb7, pfb8, pfc1, pfc2, pfc3, pfc4, pfc5, pfc6, pfc7, pfc8, pfd1, pfd2, pfd3, pfd4, pfd5, pfd6, pfd7, pfd8, pxe1, pxe2, pxe3, pxe4, pxe5, pxe6, pxe7, pxe8, pxf1, pxf2, pxf3, pxf4, pxf5, pxf6, pxf7, pxf8, cc1, cc2, cc3, cdef, ac1, ac2, ac3, ac4, ac5, ac6, ac7, ac8, sn1, sn2, sn3, sn4, sn5, sn6, sn7, sn8, sn9, sn10, sn11, sn12, sn13, sn14, sn15, snx, dn1, dn2, dn3, dn4, dn5, dn6, dn7, dn8, dn9, dn10, dn11, dn12, dn13, dn14, dn15, dnx, znx, aclac, accgpn, acdef, cccgpn

**:ca3=** (optional)

Conditioning action 3. This parameter specifies the third CA that can be applied to an incoming digit string.

**Range:** ign1, ign2, ign3, ign4, ign5, ign6, ign7, ign8, ign9, ign10, fpx, pfxa1, pfxa2, pfxa3, pfxa4, pfxa5, pfxa6, pfxa7, pfxa8, pfb1, pfb2, pfb3, pfb4, pfb5, pfb6, pfb7, pfb8, pfc1, pfc2, pfc3, pfc4, pfc5, pfc6, pfc7, pfc8, pfd1, pfd2, pfd3, pfd4, pfd5, pfd6, pfd7, pfd8, pxe1, pxe2, pxe3, pxe4, pxe5, pxe6, pxe7, pxe8, pxf1, pxf2, pxf3, pxf4, pxf5, pxf6, pxf7, pxf8, cc1, cc2, cc3, cdef, ac1, ac2, ac3, ac4, ac5, ac6, ac7, ac8, sn1, sn2, sn3, sn4, sn5, sn6, sn7, sn8, sn9, sn10, sn11, sn12, sn13, sn14, sn15, snx, dn1, dn2, dn3, dn4, dn5, dn6, dn7, dn8, dn9, dn10, dn11, dn12, dn13, dn14, dn15, dnx, znx, aclac, accgpn, acdef, cccgpn

**:ca4=** (optional)

Conditioning action 4. This parameter specifies the fourth CA that can be applied to an incoming digit string.

**Range:** ign1, ign2, ign3, ign4, ign5, ign6, ign7, ign8, ign9, ign10, fpx, pfxa1, pfxa2, pfxa3, pfxa4, pfxa5, pfxa6, pfxa7, pfxa8, pfb1, pfb2, pfb3, pfb4, pfb5, pfb6, pfb7, pfb8, pfc1, pfc2, pfc3, pfc4, pfc5, pfc6, pfc7, pfc8, pfd1, pfd2, pfd3, pfd4, pfd5, pfd6, pfd7, pfd8, pxe1, pxe2, pxe3, pxe4, pxe5, pxe6, pxe7, pxe8, pxf1, pxf2, pxf3, pxf4, pxf5, pxf6, pxf7, pxf8, cc1, cc2, cc3, cdef, ac1, ac2, ac3, ac4, ac5, ac6, ac7, ac8, sn1, sn2, sn3, sn4, sn5, sn6, sn7, sn8, sn9, sn10, sn11, sn12, sn13, sn14, sn15, snx, dn1, dn2, dn3, dn4, dn5, dn6, dn7, dn8, dn9, dn10, dn11, dn12, dn13, dn14, dn15, dnx, znx, aclac, accgpn, acdef, cccgpn

**:ca5=** (optional)

Conditioning action 5. This parameter specifies the fifth CA that can be applied to an incoming digit string.

**Range:** ign1, ign2, ign3, ign4, ign5, ign6, ign7, ign8, ign9, ign10, fpx, pfxa1, pfxa2, pfxa3, pfxa4, pfxa5, pfxa6, pfxa7, pfxa8, pfb1, pfb2, pfb3, pfb4, pfb5, pfb6, pfb7, pfb8, pfc1, pfc2, pfc3, pfc4, pfc5, pfc6, pfc7, pfc8, pfd1, pfd2, pfd3, pfd4, pfd5, pfd6, pfd7, pfd8, pxe1, pxe2, pxe3, pxe4, pxe5, pxe6, pxe7, pxe8, pxf1, pxf2, pxf3, pxf4, pxf5, pxf6, pxf7, pxf8, cc1, cc2, cc3, cdef, ac1, ac2, ac3, ac4, ac5, ac6, ac7, ac8, sn1, sn2, sn3, sn4, sn5, sn6, sn7, sn8, sn9, sn10, sn11, sn12, sn13, sn14, sn15, snx, dn1, dn2, dn3, dn4, dn5, dn6, dn7, dn8, dn9, dn10, dn11, dn12, dn13, dn14, dn15, dnx, znx, aclac, accgpn, acdef, cccgpn

**:ca6=** (optional)

Conditioning action 6. This parameter specifies the sixth CA that can be applied to an incoming digit string.

**Range:** ign1, ign2, ign3, ign4, ign5, ign6, ign7, ign8, ign9, ign10, fpx, pfxa1, pfxa2, pfxa3, pfxa4, pfxa5, pfxa6, pfxa7, pfxa8, pfb1, pfb2, pfb3, pfb4, pfb5, pfb6, pfb7, pfb8, pfc1, pfc2, pfc3, pfc4, pfc5, pfc6, pfc7, pfc8, pfd1, pfd2, pfd3, pfd4, pfd5, pfd6, pfd7, pfd8, pxe1, pxe2, pxe3, pxe4, pxe5, pxe6, pxe7, pxe8, pxf1, pxf2, pxf3, pxf4, pxf5, pxf6, pxf7, pxf8, cc1, cc2, cc3, cdef, ac1, ac2, ac3, ac4, ac5, ac6, ac7, ac8, sn1, sn2, sn3, sn4, sn5, sn6, sn7, sn8, sn9, sn10, sn11, sn12, sn13, sn14, sn15, snx, dn1, dn2, dn3, dn4, dn5, dn6, dn7, dn8, dn9, dn10, dn11, dn12, dn13, dn14, dn15, dnx, znx, aclac, accgpn, acdef, cccgpn

**:ca7=** (optional)

Conditioning action 7. This parameter specifies the seventh CA that can be applied to an incoming digit string.

**Range:** ign1, ign2, ign3, ign4, ign5, ign6, ign7, ign8, ign9, ign10, fpx, pfxa1, pfxa2, pfxa3, pfxa4, pfxa5, pfxa6, pfxa7, pfxa8, pfb1, pfb2, pfb3, pfb4, pfb5, pfb6, pfb7, pfb8, pfc1, pfc2, pfc3, pfc4, pfc5, pfc6, pfc7, pfc8, pfd1, pfd2, pfd3, pfd4, pfd5, pfd6, pfd7, pfd8, pxe1, pxe2, pxe3, pxe4, pxe5, pxe6, pxe7, pxe8, pxf1, pxf2, pxf3, pxf4, pxf5, pxf6, pxf7, pxf8, cc1, cc2, cc3, cdef, ac1, ac2, ac3, ac4, ac5, ac6, ac7, ac8, sn1, sn2, sn3, sn4, sn5, sn6, sn7, sn8, sn9, sn10, sn11, sn12, sn13, sn14, sn15, snx, dn1, dn2, dn3, dn4, dn5, dn6, dn7, dn8, dn9, dn10, dn11, dn12, dn13, dn14, dn15, dnx, znx, aclac, accgpn, acdef, cccgpn

**:ca8=** (optional)

Conditioning action 8. This parameter specifies the eighth CA that can be applied to an incoming digit string.

**Range:** ign1, ign2, ign3, ign4, ign5, ign6, ign7, ign8, ign9, ign10, fpx, pfxa1, pfxa2, pfxa3, pfxa4, pfxa5, pfxa6, pfxa7, pfxa8, pfb1, pfb2, pfb3, pfb4, pfb5, pfb6, pfb7, pfb8, pfc1, pfc2, pfc3, pfc4, pfc5, pfc6, pfc7, pfc8, pfd1, pfd2, pfd3, pfd4, pfd5, pfd6, pfd7, pfd8, pxe1, pxe2, pxe3, pxe4, pxe5, pxe6, pxe7, pxe8, pxf1, pxf2, pxf3, pxf4, pxf5, pxf6, pxf7, pxf8, cc1, cc2, cc3, cdef, ac1, ac2, ac3, ac4, ac5, ac6, ac7, ac8, sn1, sn2, sn3, sn4, sn5, sn6, sn7, sn8, sn9, sn10, sn11, sn12, sn13, sn14, sn15, snx, dn1, dn2, dn3, dn4, dn5, dn6, dn7, dn8, dn9, dn10, dn11, dn12, dn13, dn14, dn15, dnx, znx, aclac, accgpn, acdef, cccgpn

**:ca9=** (optional)

Conditioning action 9. This parameter specifies the ninth CA that can be applied to an incoming digit string.

**Range:** ign1, ign2, ign3, ign4, ign5, ign6, ign7, ign8, ign9, ign10, fpx, pfxa1, pfxa2, pfxa3, pfxa4, pfxa5, pfxa6, pfxa7, pfxa8, pfb1, pfb2, pfb3, pfb4, pfb5, pfb6, pfb7, pfb8, pfc1, pfc2, pfc3, pfc4, pfc5, pfc6, pfc7, pfc8, pfd1, pfd2, pfd3, pfd4, pfd5, pfd6, pfd7, pfd8, pxe1, pxe2, pxe3, pxe4, pxe5, pxe6, pxe7, pxe8, pxf1, pxf2, pxf3, pxf4, pxf5, pxf6, pxf7, pxf8, cc1, cc2, cc3, cdef, ac1, ac2, ac3, ac4, ac5, ac6, ac7, ac8, sn1, sn2, sn3, sn4, sn5, sn6, sn7, sn8, sn9, sn10, sn11, sn12, sn13, sn14, sn15, snx, dn1, dn2, dn3, dn4, dn5, dn6, dn7, dn8, dn9, dn10, dn11, dn12, dn13, dn14, dn15, dnx, znx, aclac, accgpn, acdef, cccgpn

**:fa=** (optional)

Formatting Action list. This parameter specifies a comma-separated FA list that can be applied to the outgoing digit string. Up to 12 FAs can be specified in the list. The FAs are processed in the order they are specified in the list and cannot be duplicated.

**Range:** sn, dn, zn, ac, rn, sp, cc, fpx, pfxa, pfxb, pfxc, pfxd, pfxe, pfxf, dlma, dlmb, dlmc, asd, orig, grn, vmid, srfimsi, dlmd, dlme, dlmf, dlmg, dlmh, dlmi, dlmj, dlmk, dlml, dlmm, dlmn, dlmo, dlmp, rnospodn, rnospoz, rnosposn

**:fa1=** (optional)

Formatting action 1. This parameter specifies the first FA that can be applied to the outgoing digit string.

**Range:** sn, dn, zn, ac, rn, sp, cc, fpx, pfxa, pfxb, pfxc, pfxd, pfxe, pfxf, dlma, dlmb, dlmc, asd, orig, grn, vmid, rnospodn, rnospoz, rnosposn, srfimsi, dlmd, dlme, dlmf, dlmg, dlmh, dlmi, dlmj, dlmk, dlml, dlmm, dlmn, dlmo, dlmp

**:fa10=** (optional)

Formatting action 10. This parameter specifies the tenth FA that can be applied to the outgoing digit string.

**Range:** sn, dn, zn, ac, rn, sp, cc, fpx, pfxa, pfxb, pfxc, pfxd, pfxe, pfxf, dlma, dlmb, dlmc, asd, orig, grn, vmid, srfimsi, dlmd, dlme, dlmf, dlmg, dlmh, dlmi, dlmj, dlmk, dlml, dlmm, dlmn, dlmo, dlmp, rnospodn, rnospoz, rnosposn

**:fa11=** (optional)

Formatting action 11. This parameter specifies the eleventh FA that can be applied to the outgoing digit string.

**Range:** sn, dn, zn, ac, rn, sp, cc, fpx, pfxa, pfxb, pfxc, pfxd, pfxe, pfxf, dlma, dlmb, dlmc, asd, orig, grn, vmid, srfimsi, dlmd, dlme, dlmf, dlmg, dlmh, dlmi, dlmj, dlmk, dlml, dlmm, dlmn, dlmo, dlmp, rnospodn, rnospoz, rnosposn

**:fa12=** (optional)

Formatting action 12. This parameter specifies the twelfth FA that can be applied to the outgoing digit string.

**Range:** sn, dn, zn, ac, rn, sp, cc, fpx, pfxa, pfxb, pfxc, pfxd, pfxe, pfxf, dlma, dlmb, dlmc, asd, orig, grn, vmid, srfimsi, dlmd, dlme, dlmf, dlmg, dlmh, dlmi, dlmj, dlmk, dlml, dlmm, dlmn, dlmo, dlmp, rnospodn, rnospoz, rnosposn

**:fa2=** (optional)

Formatting action 2. This parameter specifies the second FA that can be applied to the outgoing digit string.

**Range:** sn, dn, zn, ac, rn, sp, cc, fpx, pfxa, pfxb, pfxc, pfxd, pfxe, pfxf, dlma, dlmb, dlmc, asd, orig, grn, vmid, srfimsi, dlmd, dlme, dlmf, dlmg, dlmh, dlmi, dlmj, dlmk, dlml, dlmm, dlmn, dlmo, dlmp, rnospodn, rnospoz, rnosposn

**:fa3=** (optional)

Formatting action 3. This parameter specifies the third FA that can be applied to the outgoing digit string.

**Range:** sn, dn, zn, ac, rn, sp, cc, fpx, pfxa, pfxb, pfxc, pfxd, pfxe, pfxf, dlma, dlmb, dlmc, asd, orig, grn, vmid, srfimsi, dlmd, dlme, dlmf, dlmg, dlmh, dlmi, dlmj, dlmk, dlml, dlmm, dlmn, dlmo, dlmp, rnospodn, rnospoz, rnosposn

**:fa4=** (optional)

Formatting action 4. This parameter specifies the fourth FA that can be applied to the outgoing digit string.

**Range:** sn, dn, zn, ac, rn, sp, cc, fpx, pfxa, pfxb, pfxc, pfxd, pfxe, pfxf, dlma, dlmb, dlmc, asd, orig, grn, vmid, srfimsi, dlmd, dlme, dlmf, dlmg, dlmh, dlmi, dlmj, dlmk, dlml, dlmm, dlmn, dlmo, dlmp, rnospodn, rnospozn, rnosposn

**:fa5=** (optional)

Formatting action 5. This parameter specifies the fifth FA that can be applied to the outgoing digit string.

**Range:** sn, dn, zn, ac, rn, sp, cc, fpx, pfxa, pfxb, pfxc, pfxd, pfxe, pfxf, dlma, dlmb, dlmc, asd, orig, grn, vmid, srfimsi, dlmd, dlme, dlmf, dlmg, dlmh, dlmi, dlmj, dlmk, dlml, dlmm, dlmn, dlmo, dlmp, rnospodn, rnospozn, rnosposn

**:fa6=** (optional)

Formatting action 6. This parameter specifies the sixth FA that can be applied to the outgoing digit string.

**Range:** sn, dn, zn, ac, rn, sp, cc, fpx, pfxa, pfxb, pfxc, pfxd, pfxe, pfxf, dlma, dlmb, dlmc, asd, orig, grn, vmid, srfimsi, dlmd, dlme, dlmf, dlmg, dlmh, dlmi, dlmj, dlmk, dlml, dlmm, dlmn, dlmo, dlmp, rnospodn, rnospozn, rnosposn

**:fa7=** (optional)

Formatting action 7. This parameter specifies the seventh FA that can be applied to the outgoing digit string.

**Range:** sn, dn, zn, ac, rn, sp, cc, fpx, pfxa, pfxb, pfxc, pfxd, pfxe, pfxf, dlma, dlmb, dlmc, asd, orig, grn, vmid, srfimsi, dlmd, dlme, dlmf, dlmg, dlmh, dlmi, dlmj, dlmk, dlml, dlmm, dlmn, dlmo, dlmp, rnospodn, rnospozn, rnosposn

**:fa8=** (optional)

Formatting action 8. This parameter specifies the eighth FA that can be applied to the outgoing digit string.

**Range:** sn, dn, zn, ac, rn, sp, cc, fpx, pfxa, pfxb, pfxc, pfxd, pfxe, pfxf, dlma, dlmb, dlmc, asd, orig, grn, vmid, srfimsi, dlmd, dlme, dlmf, dlmg, dlmh, dlmi, dlmj, dlmk, dlml, dlmm, dlmn, dlmo, dlmp, rnospodn, rnospozn, rnosposn

**:fa9=** (optional)

Formatting action 9. This parameter specifies the ninth FA that can be applied to the outgoing digit string.

**Range:** sn, dn, zn, ac, rn, sp, cc, fpx, pfxa, pfxb, pfxc, pfxd, pfxe, pfxf, dlma, dlmb, dlmc, asd, orig, grn, vmid, srfimsi, dlmd, dlme, dlmf, dlmg, dlmh, dlmi, dlmj, dlmk, dlml, dlmm, dlmn, dlmo, dlmp, rnospodn, rnospozn, rnosposn

**:ofnai=** (optional)

Outgoing filter nature of address indicator. This parameter specifies the filter nature of address indicator (FNAI) class of the outgoing digit string.

**Range:** intl, natl, nai1, nai2, nai3, unkn, inc  
**intl** — intl value provisioned in the **chg-npp-serv** command  
**natl** — natl value provisioned in the **chg-npp-serv** command  
**nai1** — nai1 value provisioned in the **chg-npp-serv** command  
**nai2** — nai2 value provisioned in the **chg-npp-serv** command  
**nai3** — nai3 value provisioned in the **chg-npp-serv** command  
**unkn** — unkn value provisioned in the **chg-npp-serv** command  
**inc** — NAI of the incoming digit string

**:sa=** (optional)

Service Action list. This parameter specifies a comma-separated SA list that can be applied to an incoming digit string. Up to 8 SAs can be specified in the list. The SAs must be specified in high-to-low precedence order in the list, and cannot be duplicated in the list.

**Range:** **rtdbtrn, rtdbtsp, rtdbtrnsp, cdial, ccncchk, cdpnnp, cgpnpn, cgpnsverqd, lacck, fwdscs, npnrls, nprelay, nprls, crp, snscegpn, fraudchk, pprelay, migrate, asdlkup, grnlkup, cgpnasdrqd, cgpngrnrqd, nscgpn, nscdpn, blklstqry, blklstrly, cgpnrng, none**  
**none**—Deletes ALL SAs from the Action Set.

**:sa1=** (optional)

Service action 1. This parameter specifies the first SA that can be applied to an incoming digit string. SAs are service-specific.

**Range:** **rtdbtrn, rtdbtsp, rtdbtrnsp, cdial, ccncchk, cdpnnp, cgpnpn, cgpnsverqd, lacck, fwdscs, npnrls, nprelay, nprls, crp, snscegpn, fraudchk, pprelay, migrate, asdlkup, grnlkup, cgpnasdrqd, cgpngrnrqd, nscgpn, nscdpn, blklstqry, blklstrly, cgpnrng, none**  
**none**—Deletes ALL SAs from the Action Set.

**:sa2=** (optional)

Service action 2. This parameter specifies the second SA that can be applied to an incoming digit string.

SAs are service-specific.

**Range:** **rtdbtrn, rtdbtsp, rtdbtrnsp, cdial, ccncchk, cdpnnp, cgpnpn, cgpnsverqd, lacck, fwdscs, npnrls, nprelay, nprls, crp, snscegpn, fraudchk, pprelay, migrate, asdlkup, grnlkup, cgpnasdrqd, cgpngrnrqd, nscgpn, nscdpn, blklstqry, blklstrly, cgpnrng, none**  
**none**—Deletes **sa2** and any subsequent SAs (**sa3** through **sa8**) from the Action Set.

**:sa3=** (optional)

Service action 3. This parameter specifies the third SA that can be applied to an incoming digit string. SAs are service-specific.

**Range:** **rtdbtrn, rtdbtsp, rtdbtrnsp, cdial, ccncchk, cdpnnp, cgpnpn, cgpnsverqd, lacck, fwdscs, npnrls, nprelay, nprls, crp, snscegpn, fraudchk, pprelay, migrate, asdlkup, grnlkup, cgpnasdrqd, cgpngrnrqd, nscgpn, nscdpn, blklstqry, blklstrly, cgpnrng, none**  
**none**—Deletes **sa3** and any subsequent SAs (**sa4** through **sa8**) from the Action Set.

**:sa4=** (optional)

Service action 4. This parameter specifies the fourth SA that can be applied to an incoming digit string.

SAs are service-specific.

**Range:** **rtdbtrn, rtdbtsp, rtdbtrnsp, cdial, ccncchk, cdpnnp, cgpnpn, cgpnsverqd, lacck, fwdscs, npnrls, nprelay, nprls, crp, snscegpn, fraudchk, pprelay, migrate, asdlkup, grnlkup, cgpnasdrqd, cgpngrnrqd, nscgpn, nscdpn, blklstqry, blklstrly, cgpnrng, none**  
**none**—Deletes **sa4** and any subsequent SAs (**sa5** through **sa8**) from the Action Set.

**:sa5=** (optional)

Service action 5. This parameter specifies the fifth SA that can be applied to an incoming digit string. SAs are service-specific.

**Range:** **rtdbtrn, rtdbtsp, rtdbtrnsp, cdial, ccncchk, cdpnnp, cgpnpn, cgpnsverqd, lacck, fwdscs, npnrls, nprelay, nprls, crp, snscegpn, fraudchk, pprelay, migrate, asdlkup, grnlkup, cgpnasdrqd, cgpngrnrqd, nscgpn, nscdpn, blklstqry, blklstrly, cgpnrng, none**  
**none**—Deletes **sa5** and any subsequent SAs (**sa6** through **sa8**). from the Action Set.

**:sa6=** (optional)

Service action 6. This parameter specifies the sixth SA that can be applied to an incoming digit string. SAs are service-specific.

**Range:** `rtdbtrn, rtdbtsp, rtdbtrnsp, cdial, ccncchk, cdpnnp, cgpnpn, cgpnsverqd, lacck, fwdscs, npnrls, nprelay, nprls, crp, snsccgn, fraudchk, pprelay, migrate, asdlkup, grnlkup, cgpnasdrqd, cgpngrnrqd, nscgpn, nscdpn, blklstqry, blklstly, cgpnrng, none`  
**none**—Deletes **sa6** and any subsequent SAs (**sa7** through **sa8**). from the Action Set.

**:sa7=** (optional)

Service action 7. This parameter specifies the seventh SA that can be applied to an incoming digit string.

SAs are service-specific.

**Range:** `rtdbtrn, rtdbtsp, rtdbtrnsp, cdial, ccncchk, cdpnnp, cgpnpn, cgpnsverqd, lacck, fwdscs, npnrls, nprelay, nprls, crp, snsccgn, fraudchk, pprelay, migrate, asdlkup, grnlkup, cgpnasdrqd, cgpngrnrqd, nscgpn, nscdpn, blklstqry, blklstly, cgpnrng, none`  
**none**—Deletes **sa7** and **sa8** from the Action Set.

**:sa8=** (optional)

Service action 8. This parameter specifies the eighth SA that can be applied to an incoming digit string.

SAs are service-specific.

**Range:** `rtdbtrn, rtdbtsp, rtdbtrnsp, cdial, ccncchk, cdpnnp, cgpnpn, cgpnsverqd, lacck, fwdscs, npnrls, nprelay, nprls, crp, snsccgn, fraudchk, pprelay, migrate, asdlkup, grnlkup, cgpnasdrqd, cgpngrnrqd, nscgpn, nscdpn, blklstqry, blklstly, cgpnrng, none`  
**none**—Deletes **sa8** from the Action Set.

### Example

```
chg-npp-
as:asn=asn7:ca1=ign1:ca2=ac1:ca3=cc3:ca4=sn2:fa1=cc:fa2=sn:fa3=ac
chg-npp-as:asn=asn7:ca1=cc1:ca2=dn1:fa1=cc:fa2=dn
chg-npp-as:asn=asn1:ca1=znx:fa1=asd:sa1=cgpnasdrqd
chg-npp-as:asn=asn8:ca1=cc2:ca2=dnx:fa1=cc:fa2=rnospodn
chg-npp-as:asn=asn9:sa1=migrate:sa2=asdlkup
chg-npp-as:asn=asn6:ca1=znx:fa1=zn:sa1=nscdpn:sa2=nscgpn
chg-npp-as:asn=asn7:ca=ign1,ac1,cc3,sn2:fa=cc,sn,ac
chg-npp-as:asn=asn7:ca=cc1,dn1:fa=cc,dn
chg-npp-as:asn=asn1:ca=znx:fa=asd:sa=cgpnasdrqd
chg-npp-as:asn=asn8:ca=cc2,dnx:fa=cc,rnospodn
chg-npp-as:asn=asn9:sa=migrate,asdlkup
chg-npp-as:asn=asn6:ca=znx:fa=zn:sa=nscdpn,nscgpn
```

### Dependencies

One of the following combinations of CA values must be specified for the AS:

- **znx**
- **cc\***, **dn\***
- **cc\***, **ac\***, **sn\***

The existing FAs or the new FAs specified for the AS must contain the corresponding FA that a CA will populate or load.

The AS must contain a CA that can load or populate the specified FA.

If specified, the **caX** parameters must be consecutively numbered, always including **ca1**. The parameters do not have to be entered in sequential order in the command.

If specified, the **saX** parameters must be consecutively numbered, always including **sa1**. The parameters do not have to be entered in sequential order in the command. The SA with the highest precedence must be assigned as the value for **sa1**.

If specified, the **faX** parameters must be consecutively numbered, always including **fa1**. The parameters do not have to be entered in sequential order in the command.

The CAs within an AS cannot condition more than 32 digits.

The AS cannot contain CAs that load or populate the same FA.

If the ZNX CA is specified, then the AC\* and DNX CAs cannot be specified in the same Action Set. Each AC\*, CC\*, DN\*, and SN\* CA can be specified only once in the Action Set.

The same value cannot be specified for the **faX** parameters within an AS.

The AS cannot contain the following combinations of FAs:

- If the DN FA is specified, then the AC\*, SN\*, and ZN FAs cannot be specified.
- If the ZN FA is specified, then the AC\*, CC\*, SN\*, and DN\* FAs cannot be specified.
- If the SN FA is specified, then the ZN and DN\* FAs cannot be specified.
- If the RNOSPODN, RNOSPOSN, or RNOSPOZN FA is specified, then the RN\*, SP, SN\*, DN\*, and ZN FAs cannot be specified.
- The RNOSPODN, RNOSPOSN, and RNOSPOZN FAs cannot be specified together in the command.

If specified, the FPFX CA must be the first value (**fpfx**) in the **ca** value list or **caX** parameter sequence.

If specified, the ZNX, SNX, or DNX CA must be the final value (**znx**, **snx**, or **dnx**) in the **ca** value list or **caX** parameter sequence.

The same value cannot be specified for the **saX** parameters within an AS.

If rules that reference an AS exist, then the AS cannot be changed.

The **ca** and **caX**, **fa** and **faX**, and **sa** and **saX** parameters cannot be specified together in the command.

The AS specified by the **asn** parameter must already exist.

## Notes

None.

## Output

```
chg-npp-as:asn=asn7:ca=cc1,dn1:fa=cc,dn
tekelecstp 09-08-18 13:57:06 EST EAGLE 41.1.0
NPP-AS table is (5 of 1024) 1% full.

CHG-NPP-AS: MASP A - COMPLTD
;
```

## chg-npp-serv

## Change NPP Service Data

Use this command to change a Numbering Plan Processor (NPP) service entry. An NPP service is any EAGLE 5 ISS feature that uses the NPP to assist with the processing of digit strings.

**NOTE: This command can be used to enter values for the dlma - dlmc parameters. However, if these parameters have a value other than none in the tifopts:dlma - dlmc or ttropts:dlma**

- dlmc commands, then those values will overwrite the values that were entered for the parameters using the chg-npp-serv command for the TIF and IDPR services, respectively.

**NOTE:** The intl, natl, nai1, nai2, nai3, and unkn parameters are used to change the FNAI class to NAI mappings for a service.

A value of incoming must be specified for the ttropts:snai parameter before the intl, natl, nai1, nai2, nai3, and unkn parameters can be changed to non-default values for the IDPRCDPN service.

A value of incoming must be specified for the ttropts:cgsnai parameter before the intl, natl, nai1, nai2, nai3, and unkn parameters can be changed to non-default values for the IDPRCGPN service.

A value of nai must be specified for the is41smsopts:mosmsnai parameter before the intl, natl, nai1, nai2, nai3, and unkn parameters can be changed to non-default values for the MOSMSICDPN service

A value of nai must be specified for the gsmmsopts:mosmsnai parameter before the intl, natl, nai1, nai2, nai3, and unkn parameters can be changed to non-default values for the MOSMSGCDPN service

**Keyword:** chg-npp-serv

**Related Commands:** chg-npp-srs, dlt-npp-srs, ent-npp-srs, rtrv-npp-serv, rtrv-npp-srs

**Command Class:** Database Administration

## Parameters

**:srvn=** (mandatory)

Service name. This parameter specifies the name of the NPP Service.

**Range:** nppt, idprcdpn, idprcgpn, tif, tif2, tif3, mosmsicgpn, mosmsicdpn, mosmsgcgpn, mosmsgcdpn, iarcdpn, iarcgpn

**nppt** — NPP Test Service

**idprcdpn** — IDPRCDPN Service

**idprcgpn** — IDPRCGPN Service

**tif** — TIF Service

**tif2** — TIF2 Service

**tif3** — TIF3 Service

**mosmsicgpn** — MOSMSICGPN Service

**mosmsicdpn** — MOSMSICDPN Service

**mosmsgcgpn** — MOSMSGCGPN Service

**mosmsgcdpn** — MOSMSGCDPN Service

**iarcdpn** — IARCDPN Service

**iarcgpn** — IARCGPN Service

**:dlma=** (optional)

This parameter specifies a delimiter that is used to format the outgoing dialed number.

**Range:** 1-16 digits, none

1-16 hexadecimal digits. Valid digits are **0-9, a-f, A-F**.

**none**—deletes the current value of the delimiter

**Default:** none

**:dlmb=** (optional)

This parameter specifies a delimiter that is used to format the outgoing dialed number.

**Range:** 1-16 digits, none

1-16 hexadecimal digits. Valid digits are **0-9, a-f, A-F**.

**none**—deletes the current value of the delimiter

**Default:** none



**:dlmc=** (optional)

This parameter specifies a delimiter that is used to format the outgoing dialed number.

**Range:** 1-16 digits, **none**  
1-16 hexadecimal digits. Valid digits are **0-9, a-f, A-F**.  
**none**—deletes the current value of the delimiter

**Default:** **none**

**:dlmd=** (optional)

This parameter specifies a delimiter that is used to format the outgoing dialed number.

**Range:** 1-16 digits, **none**  
1-16 hexadecimal digits. Valid digits are **0-9, a-f, A-F**.  
**none**—deletes the current value of the delimiter

**Default:** **none**

**:dlme=** (optional)

This parameter specifies a delimiter that is used to format the outgoing dialed number.

**Range:** 1-16 digits, **none**  
1-16 hexadecimal digits. Valid digits are **0-9, a-f, A-F**.  
**none**—deletes the current value of the delimiter

**Default:** **none**

**:dlmf=** (optional)

This parameter specifies a delimiter that is used to format the outgoing dialed number.

**Range:** 1-16 digits, **none**  
1-16 hexadecimal digits. Valid digits are **0-9, a-f, A-F**.  
**none**—deletes the current value of the delimiter

**Default:** **none**

**:dlmg=** (optional)

This parameter specifies a delimiter that is used to format the outgoing dialed number.

**Range:** 1-16 digits, **none**  
1-16 hexadecimal digits. Valid digits are **0-9, a-f, A-F**.  
**none**—deletes the current value of the delimiter

**Default:** **none**

**:dlmh=** (optional)

This parameter specifies a delimiter that is used to format the outgoing dialed number.

**Range:** 1-16 digits, **none**  
1-16 hexadecimal digits. Valid digits are **0-9, a-f, A-F**.  
**none**—deletes the current value of the delimiter

**Default:** **none**

**:dlmi=** (optional)

This parameter specifies a delimiter that is used to format the outgoing dialed number.

**Range:** 1-16 digits, **none**  
1-16 hexadecimal digits. Valid digits are **0-9, a-f, A-F**.  
**none**—deletes the current value of the delimiter

**Default:** **none**

**:dlmj=** (optional)

This parameter specifies a delimiter that is used to format the outgoing dialed number.

**Range:** 1-16 digits, **none**  
1-16 hexadecimal digits. Valid digits are **0-9, a-f, A-F**.  
**none**—deletes the current value of the delimiter

**Default:** **none**

**:dlmk=** (optional)

This parameter specifies a delimiter that is used to format the outgoing dialed number.

**Range:** 1-16 digits, **none**  
 1-16 hexadecimal digits. Valid digits are **0-9, a-f, A-F**.  
**none**—deletes the current value of the delimiter

**Default:** **none**

**:dlml=** (optional)

This parameter specifies a delimiter that is used to format the outgoing dialed number.

**Range:** 1-16 digits, **none**  
 1-16 hexadecimal digits. Valid digits are **0-9, a-f, A-F**.  
**none**—deletes the current value of the delimiter

**Default:** **none**

**:dlmm=** (optional)

This parameter specifies a delimiter that is used to format the outgoing dialed number.

**Range:** 1-16 digits, **none**  
 1-16 hexadecimal digits. Valid digits are **0-9, a-f, A-F**.  
**none**—deletes the current value of the delimiter

**Default:** **none**

**:dlmn=** (optional)

This parameter specifies a delimiter that is used to format the outgoing dialed number.

**Range:** 1-16 digits, **none**  
 1-16 hexadecimal digits. Valid digits are **0-9, a-f, A-F**.  
**none**—deletes the current value of the delimiter

**Default:** **none**

**:dlmo=** (optional)

This parameter specifies a delimiter that is used to format the outgoing dialed number.

**Range:** 1-16 digits, **none**  
 1-16 hexadecimal digits. Valid digits are **0-9, a-f, A-F**.  
**none**—deletes the current value of the delimiter

**Default:** **none**

**:dlmp=** (optional)

This parameter specifies a delimiter that is used to format the outgoing dialed number.

**Range:** 1-16 digits, **none**  
 1-16 hexadecimal digits. Valid digits are **0-9, a-f, A-F**.  
**none**—deletes the current value of the delimiter

**Default:** **none**

**:intl=** (optional)

International. This parameter maps an International FNAI class to the NAI of the incoming digit string.

**Range:** **0-255 none**  
**none**—A rule with an FNAI or OFNAI of **intl** cannot be provisioned

**Default:** No change to the current value

**System**

**Default:** **1** - IARCDPN, IARCGPN services and all MOSMS services  
**4** - NPPT, TIF, TIF2, TIF3, IDPRCDPN and IDPRCGPN services

**:nai1=** (optional)

This parameter maps an NAI-1 FNAI class to the NAI of the incoming digit string.

**Range:** 0-255 none  
**none**—A rule with an FNAI or OFNAI of **nai1** cannot be provisioned  
**Default:** No change to the current value  
**System**  
**Default:** none

**:nai2=** (optional)

This parameter maps an NAI-2 FNAI class to the NAI of the incoming digit string.

**Range:** 0-255 none  
**none**—A rule with an FNAI or OFNAI of **nai2** cannot be provisioned  
**Default:** No change to the current value  
**System**  
**Default:** none

**:nai3=** (optional)

This parameter maps an NAI-3 FNAI class to the NAI of the incoming digit string.

**Range:** 0-255 none  
**none**—A rule with an FNAI or OFNAI of **nai3** cannot be provisioned  
**Default:** No change to the current value  
**System**  
**Default:** none

**:natl=** (optional)

This parameter maps a National FNAI class to the NAI of the incoming digit string.

**Range:** 0-255 none  
**none**—A rule with an FNAI or OFNAI of **natl** cannot be provisioned  
**Default:** No change to the current value  
**System**  
**Default:** 0 - IARCDPN, IARCGPN, MOSMSICDPN and MOSMSICGPN services  
2 - MOSMSGCDPN and MOSMSGCGPN services  
3 - NPPT, TIF, TIF2, TIF3, IDPRCDPN and IDPRCGPN services

**:status=** (optional)

This parameter specifies whether the service can be processed by the NPP.

**Range:** off, on  
**off**— The service cannot be processed by the NPP.  
**on**— The service can be processed by the NPP.  
The **status=on** parameter must be specified before a service can be processed by the NPP.  
**Default:** off

**:unkn=** (optional)

This parameter maps an Unknown FNAI class to the NAI of the incoming digit string.

**Range:** 0-255  
**Default:** No change to the current value  
**System** 0 - NPPT, TIF, TIF2, TIF3, IDPRCDPN, IDPRCGPN, MOSMSGCDPN and  
**Default:** MOSMSGCGPN services  
2 - IARCDPN, IARCGPN, MOSMSICDPN and MOSMSICGPN services

**Example**

```
chg-npp-serv:svn=nppt:status=on
chg-npp-serv:svn=nppt:status=on:nai3=6:intl=15:natl=50
chg-npp-serv:svn=nppt:status=on:nai3=6:intl=15
chg-npp-serv:svn=tif3:status=on:nai3=6:intl=15
```

```
chg-npp-
serv:svrn=tif:dlma=1234567890abcdef:dlmb=aaaaabbbbcccccd:dlmc=10
2030405
```

### Dependencies

The service specified by the **svrn** parameter must have associated rules before the **status=on** parameter can be specified.

If the service specified by the **svrn** parameter references any NPP rules, then the **intl**, **natl**, **nai1**, **nai2**, and **nai3** parameters cannot have a value of **none**.

### Output

```
chg-npp-serv:svrn=nppt:status=on:nai3=6:intl=15:natl=50
tekelecstp 08-05-17 15:55:35 EAGLE 39.0.0
chg-npp-serv:svrn=nppt:status=on:nai3=6:intl=15:natl=50
CHG-NPP-SERV: MASP A - COMPLTD
;
```

## chg-npp-srs

### Change a NPP Service Rule Set

Use this command to change the Action Set (AS) that is associated with a Numbering Plan Processor (NPP) Rule. An NPP Rule is an association between a single NPP filter and an AS.

**Keyword:** **chg-npp-srs**

**Related Commands:** **chg-npp-as**, **dlt-npp-srs**, **ent-npp-as**, **ent-npp-srs**, **rtrv-npp-as**, **rtrv-npp-srs**

**Command Class:** Database Administration

### Parameters

**:asn=** (mandatory)

Action set name. This parameter specifies the name of the AS.

**Range:** *ayyyyyyyyy*  
1 alphabetic character followed by up to 9 alphanumeric characters

**:fdl=** (mandatory)

Filter digit length. This parameter specifies the number of digits on the incoming digit string that is filtered by the NPP.

**Range:** **1-32** \*  
\*—multiple lengths of digit strings can be filtered

**:fnai=** (mandatory)

Filter nature of address indicator. This parameter specifies the filter Nature of Address Indicator (NAI) class.

**Range:** **intl**, **natl**, **nai1**, **nai2**, **nai3**, **unkn**  
**intl**— filter messages with NAI=INTL  
**natl**— filter messages with NAI=NATL  
**nai1**— filter messages with NAI=NAI1  
**nai2**— filter messages with NAI=NAI2  
**nai3**— filter messages with NAI=NAI3  
**unkn**— filter messages with NAI=UNKN

The **chg-npp-serv** command is used to assign values to the various FNAI classes.

**:fpfx=** (mandatory)

Filter prefix. This parameter specifies the prefix used to filter incoming digit strings.

**Range:** 1-16 digits, \*, ?  
 1 - 16 hexadecimal digits inclusive of single digit wildcard (?); or wildcard (\*) matching the entire digit string; valid digits are ?, 0-9, a-f, A-F.

**:srvn=** (mandatory)

Service name. This parameter specifies the name of the NPP Service.

**Range:** **nppt, idprcdpn, idprcgpn, tif, tif2, tif3, mosmsicgpn, mosmsicdpn, mosmsgcgpn, mosmsgcdpn, iarcdpn, iarcgpn**  
**nppt** — NPP Test Service  
**idprcdpn** — IDPRCDNP Service  
**idprcgpn** — IDPRCGPN Service  
**tif** — TIF Service  
**tif2** — TIF2 Service  
**tif3** — TIF3 Service  
**mosmsicgpn** — MOSMSICGPN Service  
**mosmsicdpn** — MOSMSICDPN Service  
**mosmsgcgpn** — MOSMSGCGPN Service  
**mosmsgcdpn** — MOSMSGCDPN Service  
**iarcdpn** — IARCDPN Service  
**iarcgpn** — IARCGPN Service

### Example

```
chg-npp-srs:srvn=nppt:fpfx=a:fdl=16:fnai=int1:asn=asn3
chg-npp-srs:srvn=tif:fnai=int1:fpfx=9090:fdl=*:asn=set1
```

### Dependencies

The AS specified by the **asn** parameter must already exist in the NPP AS table.

The AS specified by the **asn** parameter cannot contain CAs that are not supported by the service specified by the **srvn** parameter.

The AS specified by the **asn** parameter cannot contain SAs that are not supported by the service specified by the **srvn** parameter.

The AS specified by the **asn** parameter cannot contain FAs that are not supported by the service specified by the **srvn** parameter.

The AS specified by the **asn** parameter cannot contain SAs that do not conform to the precedence order that is supported by the service specified by the **srvn** parameter.

The CAs in the AS specified by the **asn** parameter cannot condition more digits than allowed by the **fdl** parameter.

If the **fdl=\*** parameter is specified, then the AS specified by the **asn** parameter must contain CAs that support variable digit string conditioning.

The NPP Rule that is specified by the **fdl, fnai, fpfx,** and **srvn** parameters must already exist in the NPP Rule table.

All of the features that are associated with the SAs in the AS that is specified by the **asn** parameter must be turned on before the AS can be used.

The SAs in the AS specified by the **asn** parameter cannot violate mutual exclusivity rules defined by the service specified by the **srvn** parameter. Refer to the Feature Manual for the feature of interest for additional information.

The AS specified by the **asn** parameter cannot contain an OFNAI class with a value of **none**.

At least one TIF feature must be turned on before an AS containing the **cdial** SA can be specified as a value for the **asn** parameter.

The TIF SCS Forwarding feature must be turned on before an AS containing the **fwdsacs** SA can be specified as a value for the **asn** parameter.

The TIF Simple Number Substitution feature must be turned on before an AS containing the **snschgpn** SA can be specified as a value for the **asn** parameter.

The TIF Number Portability feature must be turned on before an AS containing the **crp**, **nprls**, **cgpnprqd**, **nprelay**, or **nprls** SA can be specified as a value for the **asn** parameter.

The IDPR ASD feature must be enabled before an AS containing the **asdlkup** or **cgpnasdrqd** SA can be specified as a value for the **asn** parameter with the IDPRCDPN or IDPRCGPN service.

The IDPR GRN feature must be enabled before an AS containing the **grnlkup** or **cgpngrnrqd** SA can be specified as a value for the **asn** parameter with the IDPRCDPN or IDPRCGPN service.

An AS containing the **asdlkup** and **cgpnasdrqd** SAs cannot be specified as a value for the **asn** parameter.

An AS containing the **grnlkup** and **cgpngrnrqd** SAs cannot be specified as a value for the **asn** parameter.

The TIF ASD feature must be enabled before an AS containing the **asdlkup** or **cgpnasdrqd** SAs can be specified as value for the **asn** parameter with the TIF services.

The TIF GRN feature must be enabled before an AS containing the **grnlkup** or **cgpngrnrqd** SAs can be specified as a value for the **asn** parameter with the TIF services.

The MO SMS ASD feature must be enabled before an AS containing the **asdlkup** or **cgpnasdrqd** SA can be specified as a value for the **asn** parameter with the MOSMSGCDPN, MOSMSGCGPN, MOSMSICDPN, or MOSMSICGPN service.

The MO SMS GRN feature must be enabled before the an AS containing the **cgpngrnrqd** or **grnlkup** SAs can be specified as a value for the **asn** parameter with the MOSMSGCDPN, MOSMSGCGPN, MOSMSICDPN, or MOSMSICGPN service.

If a rule contains an FPFx with a wildcard value, then the rule cannot also contain an AS where the **fpfx** CA is specified.

The value specified for the **fpfx** parameter cannot contain a **?** as the final character.

The TIF Number Substitution feature must be enabled before an AS containing the **nscgpn** or **nscdpn** SA can be specified.

The AS specified by the **asn** parameter cannot contain both the **nscgpn** and **snschgpn** SAs.

The Prepaid SMS Intercept Ph1 feature must be enabled before an AS containing the **pprelay** SA can be specified as a value for the **asn** parameter with the MOSMSGCDPN or MOSMSGCGPN service.

The Portability Check for MO SMS feature must be enabled before an AS containing the **fraudchk** SA can be specified as a value for the **asn** parameter with the MOSMSGCGPN service.

The MO SMS IS41-to-GSM Migration feature must be enabled before an AS containing the **migrate** SA can be specified as a value for the **asn** parameter with the MOSMSICDPN service.

The MO-based IS41 SMS NP feature must be enabled before an AS containing the **cdpnpn** SA can be specified as a value for the **asn** parameter with the MOSMSICDPN service.

The MO-based GSM SMS NP feature must be enabled an AS containing the **cdpnpn** SA can be specified as a value for the **asn** parameter with the MOSMSGCDPN service.

The IDP A-Party Routing feature must be enabled before the **saX=cgpnrtg** parameter can be specified.

The IDP A-Party Blacklist feature must be enabled before the **saX=blklstqry** or **saX=blklsttry** parameter can be specified.

The **sa1=blklstqry** service action cannot be specified with any other service actions.

The **caX=accgpn** and **caX=cccgpn** parameters cannot be specified together in the command.

The IAR Base feature must be enabled before an AS containing the **ccncchk**, **cdial** or **cgpnsvrqr** SA can be specified as a value for the **asn** parameter with the IARCDPN or IARCGPN service.

The IAR NP feature must be enabled before an AS containing the **cdpnp** or **cgpnnp** SA can be specified as a value for the **asn** parameter with the IARCDPN or IARCGPN service.

The IAR ASD feature must be enabled before an AS containing the **asdlkup** or **cgpnasdrqd** SA can be specified as a value for the **asn** parameter with the IARCDPN or IARCGPN service.

The IAR GRN feature must be enabled before an AS containing the **grnlkup** or **cgpngrnrqd** SA can be specified as a value for the **asn** parameter with the IARCDPN or IARCGPN service.

## Notes

None

## Output

```
chg-npp-srs:svrn=tif:fnai=intl:fpfx=9090:fdl=*:asn=set1
tekelecstp 09-04-05 15:45:28 EST EAGLE 41.0.0
NPP-SRS table is (1 of 8192) 1% full.

CHG-NPP-SRS: MASP A - COMPLTD
;
```

## chg-oap-config

### Change OAP Configuration

Use this command to configure the EAGLE 5 ISS database with the OAP configuration information. This information is sent to the specified OAP with the **act-oap-config** command.

**NOTE: This command enables you to configure the OAP from the EAGLE 5 ISS terminal. You should no longer perform this function from a terminal connected to the OAP.**

**Keyword:** chg-oap-config

**Related Commands:** chg-lnp-serv, chg-sid, dlt-lnp-serv, ent-lnp-serv, rtrv-lnp-serv, rtrv-oap-config, rtrv-sid

**Command Class:** Database Administration

## Parameters

**NOTE: You must provision the EAGLE 5 ISS database with valid information for the SEAS feature if this feature is turned on (as shown by SEAS=on in the output of the rtrv-feat command). The information must be provisioned to clear the checksum mismatch alarm (UAM 0364).**

**NOTE: The following parameters are no longer available: lsms, mpssel, mssel, mnsap, snsap, spsel, sssel**

**:aipaddr=** (optional)

The IP address of OAP A. This is a TCP/IP address expressed in standard dot notation. IP addresses consist of the system's network number and the machine's unique host number. A sample IP address is **192.126.100.5**, where **192.126.100** is the network number and **5** is the machine's host number. If you are unsure of your IP address, check with your Information Services department.

**Range:** **1-223, 0-255**  
 4 numbers separated by dots  
**1-223**—first number  
**0-255**—the other three numbers

**:aname=** (optional)

The name assigned to OAP A.

This parameter is mandatory for SEAS.

**Range:** *xxxxxxxxxxxx*

1 alphabetic character followed by 1 to 13 alphanumeric characters.

The value must be enclosed in double quotation marks (" "); for example,

**aname="tekelec-10"**.

**:anmask=** (optional)

The netmask for OAP A. If you are not sure that your network requires this configuration, check with your Information Services department.

Depending on your network configuration, this parameter may be mandatory for SEAS.

**Range:** 4 numbers separated by dots, with each number in the range of **0-255**.

**:arouter=** (optional)

The IP address of the default router assigned to OAP A. This is a TCP/IP address expressed in standard "dot notation." IP addresses consist of the system's network number and the machine's unique host number. A sample IP address is **192.126.100.5**, where **192.126.100** is the network number and **5** is the machine's host number. If you are not sure if your network requires this configuration, check with your Information Services department.

Depending on your network configuration, this parameter may be mandatory for SEAS.

**Range:** **1-223, 0-255**

4 numbers separated by dots

**1-223**—first number

**0-255**—the other three numbers

**:bipaddr=** (optional)

The IP address of OAP B. This is a TCP/IP address expressed in standard dot notation. IP addresses consist of the system's network number and the machine's unique host number. A sample IP address is **192.126.100.5**, where **192.126.100** is the network number and **5** is the machine's host number. If you are unsure of your IP address, check with your Information Services department.

**Range:** **1-223, 0-255**

4 numbers separated by dots

**1-223**—first number

**0-255**—the other three numbers

**:bname=** (optional)

The name assigned to OAP B.

This parameter is mandatory for SEAS.

**Range:** *xxxxxxxxxxxx*

1 alphabetic character followed by 1 to 13 alphanumeric characters.

The value must be enclosed in double quotation marks (" "), for example,

**bname="tekelec-10"**.

**:bnmask=** (optional)

The netmask for OAP B. If you are not sure that your network requires this configuration, check with your Information Services department.

Depending on your network configuration, this parameter may be mandatory for SEAS.

**Range:** **1-223, 0-255**

4 numbers separated by dots

**1-223**—first number

**0-255**—the other three numbers



**:brouter=** (optional)

The IP address of the default router assigned to OAP B. This is a TCP/IP address expressed in standard dot notation. IP addresses consist of the system's network number and the machine's unique host number. A sample IP address is **192.126.100.5**, where **192.126.100** is the network number and **5** is the machine's host number. If you are not sure that your network requires this configuration, check with your Information Services department.

Depending on your network configuration, this parameter may be mandatory for SEAS.

**Range:** 4 numbers separated by dots, with each number in the range of **0-255**.

**:cfg=** (optional)

The number of OAPs being configured.

This parameter is mandatory for SEAS.

**Range:** **sngl, dual**

**sngl**— OAP A

**dual**— OAP A and OAP B

**:mpsel=** (optional)

The presentation selector of the main LSMS.

This parameter is mandatory for LNP if **lsms=main**.

**Range:** *xyyy*

1-4 alphanumeric characters.

The value must be enclosed in double quotation marks (" ").

**:mssel=** (optional)

The session selector of the main LSMS.

This parameter is mandatory for LNP if **lsms=main**.

**Range:** *xyyy*

1-4 alphanumeric characters.

The value must be enclosed in double quotation marks (" ").

**:seaccli=** (optional)

The common language location identifier (CLLI) of the SEAC the OAP is connecting to.

This parameter is mandatory for SEAS.

**Range:** *ayyyyyyyyy*

1 alphabetic character followed by 1 to 10 alphanumeric characters.

**:spsel=** (optional)

The presentation selector of the shadow LSMS. The value is enclosed in quotes (" ").

This parameter is mandatory for LNP if **lsms=shadow**.

**Range:** *xyyy*

1 to 4 alphanumeric characters.

**:sssel=** (optional)

The session selector of the shadow LSMS.

This parameter is mandatory for LNP if **lsms=shadow**.

**Range:** *xyyy*

1-4 alphanumeric characters.

The value must be enclosed in double quotation marks.

**:x25mode=** (optional)

The mode of the x.25 link to the SEAC.

This parameter is mandatory for SEAS.

**Range:** **dte, dce**

**:x25ps=** (optional)

The x.25 packet size for the link to the SEAC.

This parameter is mandatory for SEAS.

**Range:** 7, 8

### Example

```
chg-oap-config:aname="tekelec-xx":bname="tekelec-xx"
```

```
chg-oap-config:aipaddr=128.132.64.15:bipaddr=128.132.64.16
```

### Dependencies

At least one parameter must be specified each time the **chg-oap-config** command is entered.

The **chg-oap-config** command allows one or several parameters to be specified at a time. If the required information for a feature has already been provisioned in the EAGLE 5 ISS database, all of the parameters for that feature do not need to be specified when you make a change. It is mandatory, however, that the configuration data in the EAGLE 5 ISS and the OAP database match. The EAGLE 5 ISS generates an alarm (UAM 0364) if the EAGLE 5 ISS database is not provisioned with the same information as the OAP.

To keep OAP parameters in sync with the EAGLE 5 ISS, a checksum is created using all of the OAP configuration data stored on the EAGLE 5 ISS. The OAP also calculates this checksum based on the data it has. The OAP returns this checksum every five seconds. The EAGLE 5 ISS compares the checksums, and generates the following alarm within ten seconds of any mismatch:

```
rlghncxa03w 04-01-07 11:11:28 EST EAGLE 31.3.0
```

```
* nnnn.0364 * OAP A Configuration data checksum mismatch
```

The alarm is cleared when a maintenance poll returns a checksum that matches the EAGLE 5 ISS' checksum, indicating that the databases are back in sync. The EAGLE 5 ISS clears the alarm within five seconds. The following UAM clears the alarm:

```
rlghncxa03w 04-01-07 11:11:28 EST EAGLE 31.3.0
```

```
nnnn.0365 OAP A Configuration data checksum alarm cleared
```

In addition to parameters configured with the **chg-oap-config** command, the EAGLE 5 ISS' Site ID (:cli) is also included in the checksum. See the **chg-sid** command for more information.

The SEAS feature must be turned on before the **seaccli** parameter can be specified.

The SEAS feature must be turned on before the **x25ps** parameter can be specified.

The SEAS feature must be turned on before the **x25mode** parameter can be specified.

### Notes

None

### Output

```
chg-oap-config:aipaddr=128.132.64.15:bipaddr=128.132.64.16
```

```
rlghncxa03w 04-01-07 11:11:28 EST EAGLE 31.3.0
```

```
CHG_OAP_CONFIG: MASP A - COMPLTD
```

```
;
```

## chg-pid

## Change Password ID

Use this command to change your password.

When this command is executed, you are prompted to enter your current password. This prevents anyone but you from changing your password.

**Keyword:** `chg-pid`

**Related Commands:** `act-user`, `chg-secu-dflt`, `chg-user`, `dact-user`, `dlt-user`, `ent-user`, `login`, `logout`, `rept-stat-user`, `rtrv-secu-dflt`, `rtrv-secu-user`, `rtrv-user`

**Command Class:** Basic

### Parameters

This command has no parameters.

### Example

```
chg-pid
```

### Dependencies

Passwords cannot be created or modified from a telnet terminal (terminal IDs 17-40) without the OA&M IP Security Enhancements feature turned on.

Use the following rules for creating passwords:

- A new password cannot contain more than 12 characters.
- A new password must contain at least the number of characters that is specified on the **minlen** parameter of the **chg-secu-dflt** command.
- A new password must contain at least the number of alphabetic (**alpha** parameter), numeric (**num** parameter), and punctuation (**punc** parameter) characters that is specified on the **chg-secu-dflt** command.
- A new password cannot contain the associated user ID.

### Notes

When a new system is shipped, both the user ID and password are set to the system. Change these immediately to ensure system security.

### Output

```
chg-pid
```

```
rlghncxa03w 04-01-07 09:10:41 EST EAGLE 31.3.0
CHG-PID: MASP A - COMPLTD
```

```
;
```

## chg-ppsopts

### Change Prepaid SMS Options

Use this command to enter Prepaid Short Message Service options (PPSOPTS) in the database. This command updates the PPSOPTS Table with entries that correspond to Intelligent Network (IN) platforms.

**NOTE: The Prepaid SMS Intercept Ph1 (PPSMS), IDP A-Party Routing, or IDP Service Key Routing feature must be turned on before this command can be specified.**

**Keyword:** `chg-ppsopts`

**Related Commands:** `rtrv-ppsopts`

**Command Class:** Database Administration

## Parameters

**NOTE:** See "Point Code Formats and Conversion" for a detailed description of point code formats, rules for specification, and examples.

**NOTE:** If the CgPA GTA matches the value of the `gta`, `gta1`, `gta2`, or `gta3` parameter during message screening, then the message falls through to GTT instead of receiving PPSMS screening.

**:bpartychk=** (optional)

MO SMS B-Party PPSMS Check. This parameter specifies whether a prepaid check on the B-Party is performed on an incoming MO SMS message.

**Range:**     **off, on**  
                   **off**— Prepaid Check on B-Party is not performed  
                   **on**— Prepaid Check on B-Party is performed

**Default:**    No change to current value

**System**

**Default:**    **off**

**:gta=** (optional)

Global title address. This parameter specifies the entity address for an IN platform and determines whether an incoming message receives PPSMS screening.

**Range:**     1-15 digits  
                   Valid digits are **0-9, A-F, a-f**.

**Default:**    No change to current value

**:gta1=** (optional)

Global title address. This parameter specifies the entity address for an IN platform and determines whether an incoming message receives PPSMS screening.

**Range:**     1-15 digits  
                   Valid digits are **0-9, A-F, a-f**.

**Default:**    No change to current value.

**:gta2=** (optional)

Global title address. This parameter specifies the entity address for an IN platform and determines whether an incoming message receives PPSMS screening.

**Range:**     1-15 digits  
                   Valid digits are **0-9, A-F, a-f**.

**Default:**    No change to current value.

**:gta3=** (optional)

Global title address. This parameter specifies the entity address for an IN platform and determines whether an incoming message receives PPSMS screening.

**Range:**     1-15 digits  
                   Valid digits are **0-9, A-F, a-f**.

**Default:**    No change to current value.

**:ngta=** (optional)

New global title address. This parameter specifies an entity address that replaces an existing entity address for an IN platform.

**Range:**     1-15 digits, **none**  
                   Valid digits are **0-9, A-F, a-f**.

**none**—Deletes the current value.

**Default:**    No change to current value.

**:pc=** (optional)

ANSI point code with subfields *network indicator-network cluster-network cluster member (ni-nc-ncm)*. The *prefix* subfield indicates a private point code (*prefix-ni-nc-ncm*).

**Synonym:** **pca**

**Range:** **p-, 000-255, none**

Specify a valid value for each subfield of the point code, and separate the subfields with a dash (-).

*prefix*—**p-**

When **chg-sid:pctype=ansi** is specified, *ni = 000* is not valid.

When **chg-sid:pctype=ansi** is specified, *nc = 000* is not valid for *ni = 001-005*.

When **chg-sid:pctype=ansi** is specified, *nc = 000* is valid if *ni = 006-255*.

Enter **none** to delete the point code.

The point code **000-000-000** is not a valid point code.

**Default:** No change to current value.

**:pci=** (optional)

ITU international point code with subfields *zone-area-id*. The *prefix* subfield indicates a spare point code (*prefix-zone-area-id*).

**Range:** **s-, 0-255, none**

Specify a valid value for each subfield of the point code, and separate the subfields with a dash (-).

*prefix*—**s-**

*zone*—**0-7**

*area*—**000-255**

*id*—**0-7**

Enter **none** to delete the point code.

The point code **0-000-0** is not a valid point code.

**Default:** No change to current value.

**:pcn=** (optional)

ITU national point code in the format of a 5-digit number (*nnnnn*); or 2, 3, or 4 numbers (members) separated by dashes (*m1-m2-m3-m4*) as defined by the **chg-stpopts:npcfmti** flexible point code option. A group code must be specified when the ITUDUPPC feature is turned on (*nnnnn-gc, m1-m2-m3-m4-gc*). The *prefix* subfield indicates a spare point code (*prefix-nnnnn, prefix-nnnnn-gc, prefix-m1-m2-m3-m4, prefix-m1-m2-m3-m4-gc*).

**Range:** **s-, 0-16383, aa-zz, none**

Specify a valid value for each subfield of the point code, and separate the subfields with a dash (-).

*prefix*—**s-**

*nnnnn*—**0-16383**

*gc*—**aa-zz**

*m1-m2-m3-m4*—**0-14** for each member; values must sum to 14

Enter **none** to delete the point code.

**Default:** No change to current value.

**:ppt=** (optional)

Prepaid portability type. This parameter specifies the IN platform where the incoming message is sent.

This parameter is mandatory if the **pc**, **ri**, or **setid** parameter is specified.

**Range:** 1-32

**:ri=** (optional)

Routing indicator. This parameter specifies the IN platform routing indicator.

**Range:** **gt**, **ssn**

**gt**— Routes on the GT value.

**ssn**— Routes on the SSN value.

**Default:** No change to current value.

**:setid=** (optional)

Set ID. This parameter specifies the MAP set ID (if the **ri=ssn** parameter is specified) or the MRN set ID (if the **ri=gt** parameter is specified) that is used by a loadsharing IN platform.

The Flexible GTT Load Sharing (FGTTLS) feature must be enabled before this parameter can be specified. If the FGTTLS feature is not enabled, lookup is performed in the default set of the MAP table or MRN table.

**Range:** 1 - 36000, none, dflt

1 - 36000, none, dflt— MAP Table

1 - 3000—MRN table

none—Lookup is not performed. This value applies only to the MRN table.

dflt—Lookup is performed in the default MAP set or MRN set.

**Default:** No change to current value.

**:ssn=** (optional)

Subsystem number

**Range:** 2-255 none

**Default:** none

### Example

The following command provisions a single GTA in the PPSOPTS table.

```
chg-ppsopts:gta=1234
```

The following command provisions four GTAs in the PPSOPTS table.

```
chg-ppsopts:gta=1101:gta1=1102:gta2=1103:gta3=1104
```

The following command replaces an existing GTA with a new GTA.

```
chg-ppsopts:gta=1101:ngta=4567
```

The following command deletes a specified GTA from the PPSOPTS table.

```
chg-ppsopts:gta=1102:ngta=none
```

The following command deletes the pc, ri, and setid values for a specified IN platform.

```
chg-ppsopts:ppt=1:pci=none
```

The following command provisions a loadsharing set for a specified IN platform.

```
chg-ppsopts:ppt=2:setid=2
```

The following example provisions point code, routing indicator, and set ID values for a specified IN platform and loadsharing set.

```
chg-ppsopts:ppt=1:pci=1-1-1:ri=gt:setid=1
```

The following command provisions the prepaid check on B-Party.

```
chg-ppsopts:bpartychk=on
```

The following example provisions ANSI point code, routing indicator, and set ID values for a specified IN platform and loadsharing set.

```
chg-ppsopts:ppt=2:pca=2-2-1:ri=ssn:setid=4
```

## Dependencies

At least one parameter must be specified.

The PPSMS, IDP A-Party Routing, or IDP Service Key Routing feature must be turned on before this command can be entered.

If the **ngta** parameter is specified, then the **gta** parameter must be specified.

The **gta**, **gta1**, **gta2**, and **gta3** parameters cannot have a value of **none**.

If the **ngta** parameter is specified, the **gta** parameter value must already exist in the database.

The **ngta** parameter value cannot already exist in the database.

The value specified for the for the **pc**, **pca**, **pci**, or **pcn** parameter cannot be the same as the STP True Point Code.

The value specified for the **pc**, **pca**, **pci**, or **pcn** parameter cannot be the same as the STP Capability Point Code.

If the **pc**, **ri**, **ssn**, or **setid** parameter is specified, then the **ppt** parameter must be specified.

If the **gta1**, **gta2**, or **gta3** parameter is specified, then the **ngta** parameter cannot be specified.

The Flexible GTT Load Sharing (FGTTLS) feature must be enabled before the **setid** parameter can be specified.

If the **ri=gt** parameter is specified, then the value of the **setid** parameter cannot exceed the value of the maximum MRN set ID.

The value specified for the **pc**, **pca**, **pci**, or **pcn** parameter must already exist in the Routing Indicator table.

The value of the **gta**, **gta1**, **gta2**, or **gta3** parameter cannot already exist in the database unless the **ngta** parameter is specified.

The **pc/pca/pci/pcn** parameter and the **ri** parameter must be specified together in the command, or a value of **none** must be specified for the **pc/pca/pci/pcn** parameter.

The **gta**, **gta1**, **gta2**, and **gta3** parameters cannot have the same value.

A maximum of 32 GTA values (for 32 IN platforms) can be defined in the database.

If the Flexible GTT Load Sharing (FGTTLS) feature is enabled, and if the **ri=ssn** parameter is specified, then the values specified for the **pc/pca/pci/pcn**, and **ssn** parameters must exist in the MAP table in the MAP set specified by the **setid** parameter, or in the default MAP set if the **setid** parameter is not specified.

If the **ri=gt** parameter is specified, then the value specified for the **pc**, **pca**, **pci**, or **pcn** parameter must exist in the MRN table.

If the **ri=ssn** parameter is specified, then the **setid=none** parameter cannot be specified.

The **pc/pca/pci/pcn**, **ri**, **setid**, and **ssn** parameters must be specified before the **ppt** parameter can be specified.

The **pc**, **pca**, **pci**, or **pcn** parameter must be provisioned for the prepaid type specified by the **ppt** parameter before the **setid** parameter can be specified.

If a value of **none** is specified for the **pc**, **pca**, **pci**, or **pcn** parameter, then the **ri** or **setid** parameter cannot be specified.

If the Flexible GTT Load Sharing (FGTTLS) feature is not enabled, and if the **ri=ssn** parameter is specified, then the value specified for the **pc**, **pca**, **pci**, or **pcn** parameter must exist in the default MAP set of the MAP table.

The value specified for the **pc/pca/pci/pcn** parameter cannot be associated with a proxy point code.

If the **ssn** parameter is specified, then the **pc/pca/pci/pcn** parameter must be specified.

**Notes**

The spare point code subtype prefix **s-** is supported only for ITU international and ITU national point codes.

The GTA digits are used during message screening to determine whether an incoming message should receive PPSMS screening. If the CgPA GTA matches the value of any of the GTA parameters, then the message falls through to GTT instead of receiving PPSMS screening.

The point code and routing indicator values (the **pc**, **pca**, **pci**, **pcn**, and **ri** parameters) are used to route messages from prepaid subscribers to the correct IN for credit checking.

**Output**

```
chg-ppsopts:ppt=1:pci=1-1-1:ri=gt:setid=1
tekelecstp 06-06-25 09:04:14 EST EAGLE 37.0.0
CHG-PPSOPTS: MASP A - COMPLTD
;
```

**chg-prefix****Change Prefix**

Use this command to enter the name of a feature, the value of a prefix used by the feature, and a prefix number that is used to refer to the prefix from another table.

**Keyword:** **chg-prefix**

**Related Commands:** **dlt-prefix**, **rtrv-ctrl-feat**, **rtrv-prefix**

**Command Class:** Database Administration

**Parameters**

**:feature=** (mandatory)

Feature Name. This parameter specifies the name of an enabled controlled feature that is supported by this command. The parameter value must match the feature name as it is displayed in the **rtrv-ctrl-feat** command output.

**Range:** *aaaaaaaaaaaaaaaaaaaaaaaa*

1 alphabetic character and up to 24 optional alphanumeric characters and spaces, enclosed in double quotation marks.

The parameter value is not case-sensitive; upper case or lower case or both can be entered.

Part or all of the feature name can be entered. If part of the feature name is specified, the entry must start with the first letter of the name, and must contain enough of the name to uniquely identify the feature. For example, there are two feature names that begin with "GSM MAP." Enough additional characters to identify which GSM MAP feature is being entered (at least "GSM MAP SR" to identify the "GSM MAP SRI Redirect" feature). This command supports the following controlled features:

- GSM MAP SRI Redirect
- ISUP NP for EPAP

**:prefix=** (mandatory)

Prefix Value. Prefix table entries for the following features:

- GSM MAP SRI Redirect
- ISUP NP with EPAP

**Range:** 1-15 digits  
1-15 hexadecimal digits; valid digits are **0-9**, **a-f**, **A-F**.

**Default:** Current value



**:prefixnum=** (mandatory)

Prefix Number. The prefix number identifies the prefix value to use for the specified feature name.

**Range:** 1-7

1-3 for GSM MAP SRI Redirect feature prefix values

1-5 for ISUP NP with EPAP feature prefix values

6 for the ISUP NP with EPAP feature Insertion Country Code

7 for the ISUP NP with EPAP feature Deletion Condition value

**Default:** Current value

### Example

Define a prefix with prefix number 1 for the ISUP NP with EPAP feature.

```
chg-prefix:feature="isup np with epap":prefix=1004:prefixnum=1
```

Define a prefix with prefix number 2 and specify part of the GSM MAP SRI Redirect feature name.

```
chg-prefix:feature="GSM MAP SRI":prefix=104:prefixnum=2
```

### Dependencies

The specified feature name value (**feature** parameter) must be enclosed in double quotation marks (" ").

The G-Port feature must be turned on before a prefix can be defined for the GSM MAP SRI Redirect feature.

The GSM MAP SRI Redirect feature must be enabled before a GSM MAP SRI Redirect prefix can be defined.

The ISUP NP with EPAP feature must be enabled before an ISUP NP with EPAP prefix can be defined.

The specified prefix value must contain a number of digits that is equal to or greater than the minimum number of digits required by the specified feature.

The specified prefix value must contain a number of digits that is equal to or less than the maximum number of digits required by the specified feature.

The prefix value **none** is not valid for GSM MAP SRI Redirect prefixes.

The specified prefix number (**prefixnum**) must be valid for the specified feature.

The maximum number of prefixes that can be defined is:

- 3 for the GSM MAP SRI Redirect feature
- 5 values, 1 Insertion Country Code, and 1 Deletion Condition for the ISUP NP with EPAP feature

The specified feature name must be the name of an enabled controlled feature as it is displayed in the **rtrv-ctrl-feat** command output; The specified feature must be one of the following features that are supported by this command:

- GSM MAP SRI Redirect
- ISUP NP for EPAP

The FEATPFX table cannot be full when a new entry is added.

### Notes

The Prefix table contains different groups of entries based on the features that are turned on. For the GSM MAP SRI Redirect for Serving HLR feature, the entries are referenced by the VendID table, based on a Vendor Number matching a Prefix Number. For the ISUP NP with EPAP feature, the

entries are referenced by the SubnetID table, based on a Subnet Number matching a Prefix Number. The Prefix table for the ISUP NP with EPAP feature also reserves Prefix Number 6 for the Insertion Country Code value, and reserves Prefix Number 7 for the Deletion Condition value. Figure 5-8 illustrates the references to the Prefix table.

Figure 5-8. Prefix Table References

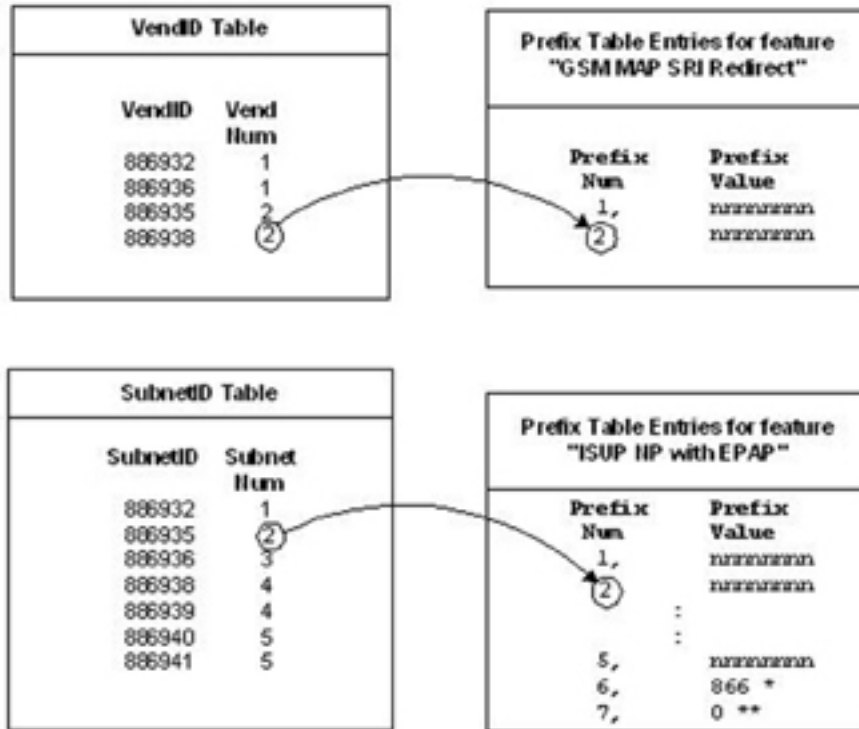

\* Reserved for the ISUP NP with EPAP feature Insertion Country Code value

\*\* Reserved for the ISUP NP with EPAP feature Deletion Condition value

For the ISUP NP with EPAP feature:

- When the Insertion Country Code (prefix number 6) is defined, the following information message appears:  
ISUP NP with EPAP, Insertion Country Code value is now defined
- When the Deletion Condition (prefix number 7) is defined, the following information message appears:  
ISUP NP with EPAP, Deletion Condition value is now defined

**Output**

**chg-prefix:feature="isup np with epap":prefix=1004:prefixnum=1**

```
rlghncxa03w 04-09-20 09:04:14 EST EAGLE 31.11.0
CHG-PREFIX: MASP A - COMPLTD
;
```

**chg-rte****Change Route**

Use this command to change the “cost,” or priority of a route. The cost is based on whether this route is first choice, second choice, and so on. Prioritize routes in such a way that the most direct route (fewest intermediate signaling points) is highest priority.

**Keyword:** **chg-rte**

**Related Commands:** **chg-dstn, dlt-dstn, dlt-rte, ent-dstn, ent-rte, rept-stat-dstn, rept-stat-rte, rtrv-dstn, rtrv-rte**

**Command Class:** Database Administration

**Parameters**

**NOTE:** See "Point Code Formats and Conversion" for a detailed description of point code formats, rules for specification, and examples.

**:lsn=** (mandatory)

Linkset name. This parameter specifies the name of the linkset associated with the route. The linkset name must be unique.

**Range:** *ayyyyyyyyy*  
1 alphabetic character followed by 9 alphanumeric characters

**:dpc=** (optional)

ANSI destination point code with subfields *network indicator-network cluster-network cluster member (ni-nc-ncm)*. The *prefix* subfield indicates a private point code (*prefix-ni-nc-ncm*).

**Synonym:** **dpca**

**Range:** **p-, 000-255, \***  
Specify a valid value for each subfield of the point code, and separate the subfields with a dash (-).  
*prefix—p-*  
The asterisk value (\*) is not valid for the *ni* subfield.  
When **chg-sid:pctype=ansi** is specified, *ni = 000* is not valid.  
When **chg-sid:pctype=ansi** is specified, *nc = 000* is not valid if *ni = 001–005*.  
When **chg-sid:pctype=ansi** is specified, *nc = 000* is valid if *ni = 006–255*.  
The point code **000-000-000** is not a valid point code.

**:dpc/dpca/dpci/dpcn/dpcn24=** (optional)

Destination point code.

**:dpci=** (optional)

ITU international destination point code with subfields *zone-area-id*. The *prefix* subfield indicates a spare point code, private point code, or private and spare point code (*prefix-zone-area-id*).

**Range:** **s-, p-, ps-, 0-255**  
Specify a valid value for each subfield of the point code, and separate the subfields with a dash (-).  
*prefix—s-, p-, ps-*  
*zone—0-7*  
*area—000-255*  
*id—0-7*  
The point code **0-000-0** is not a valid point code.

**:dpcn=** (optional)

ITU national point code in the format of a 5-digit number (*nnnnn*); or 2, 3, or 4 numbers (members) separated by dashes (*m1-m2-m3-m4*) as defined by the **chg-stpopts:npcfmti** flexible point code option. A group code must be specified when the ITUDUPPC feature is turned on (*nnnnn-gc*, *m1-m2-m3-m4-gc*). The *prefix* subfield indicates a spare point code, private point code, or private and spare point code (*prefix-nnnnn*, *prefix-nnnnn-gc*, *prefix-m1-m2-m3-m4*, *prefix-m1-m2-m3-m4-gc*).

**Range:** **s-, p-, ps-, 0-16383, aa-zz**

Specify a valid value for each subfield of the point code, and separate the subfields with a dash (-).

*prefix*—**s-, p-, ps-**

*nnnnn*—**0-16383**

*gc*—**aa-zz**

*m1-m2-m3-m4*—**0-14** for each member; values must sum to 14

**:dpcn24=** (optional)

24-bit ITU national destination point code with subfields *main signaling area-sub signaling area-signaling point* (*msa-ssa-sp*). The *prefix* subfield indicates a private point code.

**Range:** **p-, 000-255**

Specify a valid value for each subfield of the point code, and separate the subfields with a dash (-).

*prefix*—**p-**

*msa*—**000-255**

*ssa*—**000-255**

*sp*—**000-255**

**:nlsn=** (optional)

New linkset name. This parameter specifies the new linkset name associated with the route.

**Range:** *ayyyyyyyyy*

1 alphabetic character followed by 9 alphanumeric characters

**Default:** The current value

**:rc=** (optional)

The relative cost (priority) for this route. Zero (**0**) is the highest priority, **99** the lowest.

**Range:** **0-99**

**Default:** The current value

**Example**

```
chg-rte:lsn=rlgh03:rc=0:dpc=244-003-001
```

```
chg-rte:dpc=25-*-*:lsn=myls:rc=10
```

The following example changes route for dpcn 4085-aa using linkset e1m2itun to relative cost of 30:

```
chg-rte:dpcn=4085-aa:lsn=e1m2itun:rc=30
```

The following example changes route for dpcn2410-100-14 using linkset we123624 to a relative cost of 25:

```
chg-rte:dpcn24=10-100-14:lsn=we123624:rc=25
```

The following example changes route for private point code dpcp-1-1-1 using linkset we123642 to relative cost of 50:

```
chg-rte:dpc=p-1-1-1:lsn=we123642:rc=50
```

The following example changes route for spare point code dpcns-4085-aa using linkset e1m2itun to relative cost of 30:

**chg-rte:dpc=s-4085-aa:lsn=e1m2itun:rc=30**

The following example changes route for private point code dpcn24p-1-100-1 using linkset we123624 to relative cost of 25:

**chg-rte:dpcn24=p-1-100-1:lsn=we123624:rc=25**

The following example changes route for private and spare point code dpcips-1-104-1 using linkset e1m2itui to relative cost of 30:

**chg-rte:dpci=ps-1-104-1:lsn=e1m2itui:rc=30**

## Dependencies

The 6-Way Loadsharing on Routesets feature must be turned on before more than 2 routes can be provisioned with the same relative cost.

If the value specified for the **dpc** parameter refers to a Proxy Point Code in the Destination table, then the **lsn** parameter cannot be specified.

If the **ipgwapc=yes** parameter is specified, then the associated **dpc/dpca/dpci/dpcn/dpcn24** parameter cannot have a cluster route assigned.

The same value of the **rc** parameter cannot be specified for linksets destined for X.215 destinations.

If the identity of a route is being changed because of a change in the linkset name, the database must not already contain the new linkset name and destination address.

If the **lsn** parameter is specified, the link set must already exist in the database and at least one link must be assigned to the link set.

If a new linkset name (the **lsn** parameter) is specified for an existing destination network address (*ni-\*-\**), or destination network cluster address (*ni-nc-\**), the linkset type used in the route (see the **chg-ls** command) must be either **b**, **c**, or **d**.

If the specified destination address is a full point code address (*ni-nc-ncm*) and is a member of a provisioned cluster (*ni-nc-\**), whether the attributes of the ordered routes assigned to the cluster can be changed is determined by the destination address's NCAI (Nested Cluster Allowed Indicator). The NCAI is set with the **ncai** parameter of the **ent/chg-dstn** commands.

- If the **ncai=no** parameter is specified, the cluster point code is not a nested cluster point code and the attributes of the ordered routes assigned to the cluster cannot be changed.
- If the **ncai=yes** parameter is specified, the specified destination address is a member of a provisioned nested cluster where the attributes of the ordered routes assigned to the cluster can be changed.

If the specified destination address is a network cluster address (*ni-nc-\**), how the attributes of the specified ordered route are changed is determined by the setting of the destination address's NCAI.

- If the **ncai=no** parameter is specified, the attributes of the specified ordered route are changed for each signaling point code having the same network identifier (*ni*) and network cluster (*nc*) codes.
- If the **ncai=yes** parameter is specified, the specified destination address is a nested cluster where changing the attributes of the ordered routes for the cluster does not affect the attributes of the ordered routes of the provisioned members.

The route destination's type must match the route's linkset adjacent point code or the route's linkset secondary adjacent point code type.

Only IPGW routes are allowed for private point codes.

If the **dpcn** parameter is specified, its format must match the format that was assigned with the **chg-stpopts:npfmti** parameter.

Network routing is valid only if the NRT feature is on. The NRT feature is turned on with the **chg-feat** command.

When using network routing, if the destination point code has a value of \* in the *nc* field, the *ncm* field must also be \* (for example, **dpc=21-\*-\***).

At least one of the following optional parameters must be specified: **nda**, **nz nlsn**, and **nrc**.

The current destination address must be a full or a cluster point code.

All linksets that are currently assigned to a route set must still be equipped.

The linkset specified by the **lsn** parameter must exist in the routeset of the destination table entry.

If a new link set (**nlsn** parameter) is specified in the command, that link set name must exist in the active LINK SET entity.

The specified DPC must be in the database.

Only a single route is allowed for an APC or SAPC for an IPGWx linkset. The changed route must include the APC or SAPC's IPGWx linkset with the destination equal to the APC or SAPC.

Adjacent point code must match destination point code type (Obsolete in IP7 3.0)

If DPCN is specified then the format of DPCN must match the format dictated by the **NPCFMTI** parameter via the **CHG-STPOPTS** command.

The STP shall ensure that the ITU-N ordered route destination's group code must match the route's Link Set Adjacent PC's group code for all linksets other than IPGWI and IPLIMI. (obsolete in IP7 4.0)

If a proxy linkset is used, then the **nlsn** parameter cannot be specified.

If a proxy linkset is used, then the value specified for the **dpc** parameter cannot be a network cluster address (*ni-nc-\**) or network address (*ni-\*-\**).

The network type of the routeset must be same as the network type of the destination point code.

The value specified for the **rc** parameter must differ from the original routing cost of the associated linkset.

### Notes

In this command, only ITU-international and ITU national point codes support the spare point code subtype prefix (**s-**) and the private and spare point code subtype prefix (**ps-**). All of the point code types support the private (internal) point code subtype prefix (**p-**).

### Output

```
chg-rte:lsn=rlgh03:rc=0:dpc=244-003-001
  rlghncxa03w 04-01-07 11:43:04 EST EAGLE 31.3.0
  CHG-RTE: MASP A - COMPLTD
;
```

## chg-rtx

### Change Exception Route

Use this command to change an exception route entry in the Routing table.

**Keyword:** **chg-rtx**

**Related Commands:** **dlt-rtx**, **ent-rtx**, **rept-stat-rtx**, **rtrv-rtx**

**Command Class:** Database Administration

## Parameters

At least one of the following optional parameters must be specified: **opc**, **ilsn**, **si**, or **cic**.

### **:dpc=** (mandatory)

ANSI destination point code with subfields *network indicator-network cluster-network cluster member (ni-nc-ncm)*. The *prefix* subfield indicates a private point code (*prefix-ni-nc-ncm*).

**Synonym:** **dpca**

**Range:** **p-**, **000-255**

Specify a valid value for each subfield of the point code, and separate the subfields with a dash (-).

*prefix*—**p-**

When **chg-sid:pctype=ansi** is specified, *ni* = **000** is not valid.

When **chg-sid:pctype=ansi** is specified, *nc* = **000** is not valid if *ni* = **001-005**.

When **chg-sid:pctype=ansi** is specified, *nc* = **000** is valid if *ni* = **006-255**.

The point code **000-000-000** is not a valid point code.

### **:dpc/dpca/dpci/dpcn/dpcn24=** (mandatory)

Destination point code.

### **:dpci=** (mandatory)

Destination Point Code. ITU international point code with subfields *zone-area-id*. The *prefix* subfield indicates a spare point code, private point code, or private and spare point code (*prefix-zone-area-id*).

**Range:** **s-**, **p-**, **ps-**, **0-255**

Specify a valid value for each subfield of the point code, and separate the subfields with a dash (-).

*prefix*—**s-**, **p-**, **ps-**

*zone*—**0-7**

*area*—**000-255**

*id*—**0-7**

The point code **0-000-0** is not a valid point code.

### **:dpcn=** (mandatory)

Destination Point Code. ITU national point code in the format of a 5-digit number (*nnnnn*); or 2, 3, or 4 numbers (members) separated by dashes (*m1-m2-m3-m4*) as defined by the **chg-stpopts:npcfmti** flexible point code option. A group code must be specified when the ITUPUPPC feature is turned on (*nnnnn-gc*, *m1-m2-m3-m4-gc*). The *prefix* subfield indicates a spare point code, private point code or private and spare point code (*prefix-nnnnn*, *prefix-nnnnn-gc*, *prefix-m1-m2-m3-m4*, *prefix-m1-m2-m3-m4-gc*).

**Range:** **s-**, **p-**, **ps-**, **0-16383**, **aa-zz**

Specify a valid value for each subfield of the point code, and separate the subfields with a dash (-).

*prefix*—**s-**, **p-**, **ps-**

*nnnnn*—**0-16383**

*gc*—**aa-zz**

*m1-m2-m3-m4*—**0-14** for each member; values must sum to 14

**:dpcn24=** (mandatory)

Destination Point Code. 24-bit ITU national point code with subfields *main signaling area-subsignaling area-signaling point (msa-ssa-sp)*. The *prefix* subfield indicates a private point code (*prefix-msa-ssa-sp*).

**Range:** **p-, 000-255**

Specify a valid value for each subfield of the point code, and separate the subfields with a dash (-).

*prefix*—**p-**

*msa*—**000-255**

*ssa*—**000-255**

*sp*—**000-255**

**:lsn=** (mandatory)

Linkset name. This parameter specifies the name of the linkset associated with the specified exception route.

**Range:** *ayyyyyyyyy*

1 alphabetic character followed by up to 9 alphanumeric characters.

**:cic=** (optional)

Starting Circuit Identification Code. This parameter is used alone or together with the **ecic** parameter as exception routing criteria for the specified exception route.

**Range:** **1-16383**

**:ecic=** (optional)

Ending Circuit Identification Code. This parameter, together with the **cic** parameter, defines the CIC range that is used as exception routing criteria for the specified exception route.

**Range:** **0-16383**

**:force=** (optional)

The **force=yes** parameter must be specified when the **ilsn** parameter value is the same as the **nlsn** parameter value.

**Range:** **yes**

**:ilsn=** (optional)

Incoming linkset name. This parameter specifies the name of the originating linkset. The parameter value is used as part of the exception routing criteria for the specified exception route.

**Range:** *ayyyyyyyyy*

1 alphabetic character followed by up to 9 alphanumeric characters.

**:nlsn=** (optional)

New linkset name. This parameter specifies the linkset name that replaces the linkset name associated with the specified exception route.

**Range:** *ayyyyyyyyy*

1 alphabetic character followed by up to 9 alphanumeric characters.

**:opc=** (optional)

ANSI origination point code with subfields *network indicator-network cluster-network cluster member (ni-nc-ncm)*. The *prefix* subfield indicates a private point code (*prefix-ni-nc-ncm*).

**Range:** **p-, 000-255**

Specify a valid value for each subfield of the point code, and separate the subfields with a dash (-).

*prefix*—**p-**

When **chg-sid:pctype=ansi** is specified, *ni = 000* is not valid.



When **chg-sid:pctype=ansi** is specified, *nc* = **000** is not valid if *ni* = **001-005**.

When **chg-sid:pctype=ansi** is specified, *nc* = **000** is valid if *ni* = **006-255**.

The point code **000-000-000** is not a valid point code.

**:opci=** (optional)

ITU international point code with subfields *zone-area-id*. The *prefix* subfield indicates a spare point code, private point code, or private and spare point code (*prefix-zone-area-id*).

**Range:** **s-, p-, ps-, 0-255**

Specify a valid value for each subfield of the point code, and separate the subfields with a dash (-).

*prefix*—**s-, p-, ps-**

*zone*—**0-7**

*area*—**000-255**

*id*—**0-7**

The point code **0-000-0** is not a valid point code.

**:open=** (optional)

ITU national point code in the format of a 5-digit number (*nnnnn*); or 2, 3, or 4 numbers (members) separated by dashes (*m1-m2-m3-m4*) as defined by the **chg-stpopts:npcfmti** flexible point code option. A group code must be specified when the ITUPUPPC feature is turned on (*nnnnn-gc*, *m1-m2-m3-m4-gc*). The *prefix* subfield indicates a spare point code, private point code or private and spare point code (*prefix-nnnnn*, *prefix-nnnnn-gc*, *prefix-m1-m2-m3-m4*, *prefix-m1-m2-m3-m4-gc*).

**Range:** **s-, p-, ps-, 0-16383, aa-zz**

Specify a valid value for each subfield of the point code, and separate the subfields with a dash (-).

*prefix*—**s-, p-, ps-**

*nnnnn*—**0-16383**

*gc*—**aa-zz**

*m1-m2-m3-m4*—**0-14** for each member; values must sum to 14

**:open24=** (optional)

24-bit ITU national point code with subfields *main signaling area-subsignaling area-signaling point* (*msa-ssa-sp*). The *prefix* subfield indicates a private point code (*prefix-msa-ssa-sp*).

**Range:** **p-, 000-255**

Specify a valid value for each subfield of the point code, and separate the subfields with a dash (-).

*prefix*—**p-**

*msa*—**000-255**

*ssa*—**000-255**

*sp*—**000-255**

**:rc=** (optional)

Relative cost. This parameter specifies the relative cost associated with the specified exception route.

**Range:** **0-99**

**:si=** (optional)

Service indicator. This parameter is used as part of the exception routing criteria for the specified exception route.

**Range:** **3-15**

### Example

This example changes the relative cost of an existing exception route.

```
chg-rtx:dpca=1-1-1:opca=2-3-3:lsn=1set1:rc=30
```

This example changes the linkset associated with the exception route.

```
chg-rtx:dpca=1-2-1:si=3:lsn=1set2:nlsn=1set3
```

This example changes the linkset and relative cost of the exception route.

```
chg-rtx:dpca=1-3-1:ilsn=1set2:lsn=1set3:nlsn=1set4:rc=20
```

```
chg-rtx:dpci=2-100-1:ilsn=1set2:lsn=1set4:rc=10
```

```
chg-rtx:dpci=2-100-1:si=5:lsn=1set5:rc=50
```

### Dependencies

Only one of the **opc**, **ilns**, **cic**, or **si** parameters can be specified for a exception route entry.

If the **ecic** parameter is specified, the **cic** parameter must be specified.

The **ecic** parameter value cannot be less than the **cic** parameter value.

The **opc** parameter value cannot be the same as the **dpc** parameter value.

The Origin-Based MTP Routing feature must be turned on before this command can be entered.

The specified combination of exception route parameter conditions must already exist.

The linkset name, as defined by the **ilsn**, **lsn**, or **nlsn** parameter, must exist.

The 6-Way Loadsharing on Routesets feature must be turned on before more than 2 routes can be provisioned with the same relative cost for a given exception route criteria.

The network domain of the adjacent point code in the linkset or in the routes in the specified routeset must be the same as the network domain of the specified destination point code or its alias.

The APC/SAPC type and group code in the linkset specified by the **lsn** parameter must match the value specified by the **dpc**, **dpca**, **dpci**, **dpcn** or **dpcn24** parameter.

The **nlsn** parameter value cannot be the same as the **lsn** parameter value.

Either the **nlsn** parameter, the **rc** parameter, or both parameters must be specified.

The **force=yes** parameter must be specified in the following cases:

- The value specified for the **ilsn** parameter is the same as the value specified for the **nlsn** parameter.
- The value specified for the **opc** parameter is the same as the APC of the linkset specified by the **nlsn** parameter

The value specified for the destination point code must be a full point code and not a cluster or network point code.

The point code specified by the **dpc**, **dpca**, **dpci**, **dpcn**, or **dpcn24** parameter must exist in the destination table.

The value specified for the **opc** parameter cannot be the same as the adjacent point code of the linkset specified by the **lsn** parameter.

The route associated with the linkset specified by the **lsn** parameter must already exist in the specified exception route.

The route associated with the linkset specified by the **nlsn** parameter cannot already exist in the specified exception route.

The value specified for the **rc** parameter must differ from the original routing cost of the associated linkset.

## Output

```
chg-rtx:dpca=1-1-1:opc=2-3-3:lsn=1set1:rc=30
stdcfq2b 06-05-19 18:20:11 EST EAGLE 35.0.0
CHG-RTX: MASP A - COMPLTD
```

## chg-sccp-msg

## Change SCCP Message

Use this command to revise an SCCP message.

**NOTE: The Flexible Linkset Optional Based Routing (FLOBR) feature must be turned on before this command can be entered.**

**Keyword:** chg-sccp-msg

**Related Commands:** rtrv-sccp-msg, tst-msg

**Command Class:** Database Administration

## Parameters

**NOTE: The nature of address indicator can be specified by a mnemonic value (nai parameter) or a numeric value (naiv parameter).**

**NOTE: The numbering plan can be specified by a mnemonic value (np parameter) or a numeric value (npv parameter).**

**NOTE: The TCAP package type can be specified by a mnemonic value (tcappkg parameter) or a numeric value (tcappkgv parameter).**

**NOTE: A TOBR quantity feature must be turned on before the tcapfamily, tcapopcode, tcapacn, tcappkg, or tcappkgv parameter can be specified.**

**:msgn=** (mandatory)

Message number. This parameter specifies the number of the SCCP message.

**Range:** 1-10

**:active=** (optional)

This parameter specifies whether the SCCP message should be sent to the network card for processing.

**Range:** yes, no

**yes** — The message is sent to the network card.

**no** — The message is not sent to the network card.

**Default:** no

**:cdgta=** (optional)

CdPA GTA. This parameter specifies the Called Party Address for the SCCP message.

**Range:** 1-15 digits

1 - 15 hexadecimal digits. Valid digits are **0-9, a-f, A-F**.

**Default:** 1234567890

**:cdgti=** (optional)

CdPA GTI. This parameter specifies the Called Party Global Title Indicator for the SCCP message.

**Range:** 1-4

- :cdnai=** (optional)  
CdPA NAI. This parameter specifies the Called Party Nature of Address Indicator for the SCCP message.  
**Range:** **sub, rsvd, natl, intl**  
**Default:** **sub**
- :cdnaiv=** (optional)  
CdPA NAIV. This parameter specifies the Called Party Nature of Address Indicator Value for the SCCP message.  
**Range:** **0-127**  
**Default:** **1**
- :cdnp=** (optional)  
CdPA NP. This parameter specifies the Called Party Numbering Plan for the SCCP message.  
**Range:** **e164, generic, x121, f69, e210, e212, e214, private, dflt**  
**Default:** **e164**
- :cdnpv=** (optional)  
CdPA NPV. This parameter specifies the Called Party Numbering Plan Value for the SCCP message.  
**Range:** **0-15**  
**Default:** **1**
- :cdpc=** (optional)  
ANSI Called Party point code with subfields *network indicator-network cluster-network cluster member (ni-nc-ncm)*.  
**Range:** **p-, 000-255**  
Specify a valid value for each subfield of the point code, and separate the subfields with a dash (-).  
*prefix—p-*  
When **chg-sid:pctype=ansi** is specified, *ni = 000* is not valid.  
When **chg-sid:pctype=ansi** is specified, *nc = 000* is not valid if *ni = 001-005*.  
When **chg-sid:pctype=ansi** is specified, *nc = 000* is valid if *ni = 006-255*.  
The point code **000-000-000** is not a valid point code.  
**Default:** **10-10-10** - ANSI 10-10-10
- :cdpci=** (optional)  
ITU international destination point code with subfields *zone-area-id*. The *prefix* subfield indicates a spare point code, private point code, or private and spare point code (*prefix-zone-area-id*).  
**Range:** **s-, p-, ps-, 0-255**  
Specify a valid value for each subfield of the point code, and separate the subfields with a dash (-).  
*prefix—s-, p-, ps-*  
*zone—0-7*  
*area—000-255*  
*id—0-7*  
The point code **0-000-0** is not a valid point code.
- :cdpcn=** (optional)  
ITU national point code in the format of a 5-digit number (*nnnnn*); or 2, 3, or 4 numbers (members) separated by dashes (*m1-m2-m3-m4*) as defined by the **chg-stpopts:npcfmti** flexible point code option. A group code must be specified when the ITUDUPPC feature is turned on (*nnnnn-gc, m1-*

*m2-m3-m4-gc*). The *prefix* subfield indicates a spare point code, private point code, or private and spare point code (*prefix-nnnnn*, *prefix-nnnnn-gc*, *prefix-m1-m2-m3-m4*, *prefix-m1-m2-m3-m4-gc*).

**Range:** **s-, p-, ps-, 0-16383, aa-zz**

Specify a valid value for each subfield of the point code, and separate the subfields with a dash (-).

*prefix*—**s-, p-, ps-**

*nnnnn*—**0-16383**

*gc*—**aa-zz**

*m1-m2-m3-m4*—**0-14** for each member; values must sum to 14

**:cdpcn24=** (optional)

24-bit ITU national CdPA point code with subfields *main signaling area-sub signaling area-signaling point* (*msa-ssa-sp*).

**Range:** **p-, 000-255**

Specify a valid value for each subfield of the point code, and separate the subfields with a dash (-).

*prefix*—**p-**

*msa*—**000-255**

*ssa*—**000-255**

*sp*—**000-255**

**:cdssn=** (optional)

CdPA SSN. This parameter specifies the Called Party Subsystem Number for the SCCP message.

**Range:** **0-255 none**

**Default:** **6**

**:cdtt=** (optional)

CdPA TT. This parameter specifies the Called Party Translation Type for the SCCP message.

**Range:** **0-255**

**Default:** **0**

**:cggtta=** (optional)

CgPA GTA. This parameter specifies the Calling Party Address for the SCCP message.

**Range:** 1-15 digits

Range is 1 - 15 hexadecimal digits. Valid digits are **0-9, a-f, A-F**.

**Default:** **1234567890**

**:cggti=** (optional)

CgPA GTI. This parameter specifies the Calling Party Global Title Indicator for the SCCP message.

**Range:** **0-4**

**:cgnai=** (optional)

CgPA NAI. This parameter specifies the Calling Party Nature of Address Indicator for the SCCP message.

**Range:** **sub, rsvd, natl, intl**

**:cgnaiv=** (optional)

CgPA NAIV. This parameter specifies the Calling Party Nature of Address Indicator Value for the SCCP message.

**Range:** **0-127**

**Default:** **1**

**:cgnp=** (optional)

CgPA NP. This parameter specifies the Calling Party Numbering Plan for the SCCP message.

**Range:** e164, generic, x121, f69, e210, e212, e214, private, dflt

**:cgnpv=** (optional)

CgPA NPV. This parameter specifies the Calling Party Numbering Plan Value for the SCCP message.

**Range:** 0-15

**Default:** 1

**:cgpc=** (optional)

ANSI CGPA point code with subfields *network indicator-network cluster-network cluster member* (*ni-nc-ncm*).

**Range:** p-, 000-255

Specify a valid value for each subfield of the point code, and separate the subfields with a dash (-).

*prefix*—p-

When **chg-sid:pctype=ansi** is specified, *ni* = 000 is not valid.

When **chg-sid:pctype=ansi** is specified, *nc* = 000 is not valid if *ni* = 001-005.

When **chg-sid:pctype=ansi** is specified, *nc* = 000 is valid if *ni* = 006-255.

The point code 000-000-000 is not a valid point code.

**Default:** 20-20-20 - ANSI 20-20-20

**:cgpci=** (optional)

ITU international CgPA point code with subfields *zone-area-id*. The *prefix* subfield indicates a spare point code (*prefix-zone-area-id*).

**Range:** s-, p-, ps-, 0-255

Specify a valid value for each subfield of the point code, and separate the subfields with a dash (-).

*prefix*—s-, p-, ps-

*zone*—0-7

*area*—000-255

*id*—0-7

The point code 0-000-0 is not a valid point code.

**:cgpcn=** (optional)

ITU national CgPA point code in the format of a 5-digit number (*nnnnn*); or 2, 3, or 4 numbers (members) separated by dashes (*m1-m2-m3-m4*) as defined by the **chg-stpopts:npfnti** flexible point code option. A group code must be specified when the ITUDUPPC feature is turned on (*nnnnn-gc*, *m1-m2-m3-m4-gc*). The *prefix* subfield indicates a spare point code (*prefix-nnnnn*, *prefix-nnnnn-gc*, *prefix-m1-m2-m3-m4*, *prefix-m1-m2-m3-m4-gc*).

**Range:** s-, p-, ps-, 0-16383, aa-zz

Specify a valid value for each subfield of the point code, and separate the subfields with a dash (-).

*prefix*—s-, p-, ps-

*nnnnn*—0-16383

*gc*—aa-zz

*m1-m2-m3-m4*—0-14 for each member; values must sum to 14

**:cgpcn24=** (optional)

24-bit ITU national CgPA point code with subfields *main signaling area-sub signaling area-signaling point* (*msa-ssa-sp*).

**Range:** p-, 000-255

Specify a valid value for each subfield of the point code, and separate the subfields with a dash (-).

*prefix*—**p**  
*msa*—**000-255**  
*ssa*—**000-255**  
*sp*—**000-255**

**:cgssn=** (optional)

CgPA SSN. This parameter specifies the Calling Party Subsystem Number for the SCCP message.

**Range:** **0-255 none**  
**Default:** **8**

**:cgtt=** (optional)

CgPA TT. This parameter specifies the Calling Party Translation Type for the SCCP message.

**Range:** **0-255**  
**Default:** **0**

**:eaglegen=** (optional)

This parameter specifies whether the message is an EAGLE 5 ISS generated message.

**Range:** **no, yes**  
**no** — the message is not an EAGLE 5 ISS generated message  
**yes** — the message is an EAGLE 5 ISS generated message

**:lsn=** (optional)

Linkset name. This parameter specifies the incoming linkset name for the SCCP message.

**Range:** *ayyyyyyyyy*  
 1 alphabetic character followed by up to 9 alphanumeric characters

**:opc=** (optional)

ANSI originating point code with subfields *network indicator-network cluster-network cluster member (ni-nc-ncm)*.

**Range:** **p-, 000-255**  
 Specify a valid value for each subfield of the point code, and separate the subfields with a dash (-).  
*prefix*—**p**  
 When **chg-sid:pctype=ansi** is specified, *ni* = **000** is not valid.  
 When **chg-sid:pctype=ansi** is specified, *nc* = **000** is not valid if *ni* = **001-005**.  
 When **chg-sid:pctype=ansi** is specified, *nc* = **000** is valid if *ni* = **006-255**.  
 The point code **000-000-000** is not a valid point code.  
**Default:** **10-10-10 - ANSI 10-10-10**

**:opci=** (optional)

ITU international originating point code with subfields *zone-area-id*. The *prefix* subfield indicates a spare point code (*prefix-zone-area-id*).

**Range:** **s-, p-, ps-, 0-255**  
 Specify a valid value for each subfield of the point code, and separate the subfields with a dash (-).  
*prefix*—**s-, p-, ps-**  
*zone*—**0-7**  
*area*—**000-255**  
*id*—**0-7**

The point code **0-000-0** is not a valid point code.

**:opcn=** (optional)

ITU national originating point code in the format of a 5-digit number (*nnnnn*); or 2, 3, or 4 numbers (members) separated by dashes (*m1-m2-m3-m4*) as defined by the **chg-stpopts:npcfmti** flexible point code option. A group code must be specified when the ITUDUPPC feature is turned on (*nnnnn-gc*, *m1-m2-m3-m4-gc*). The *prefix* subfield indicates a spare point code (*prefix-nnnnn*, *prefix-nnnnn-gc*, *prefix-m1-m2-m3-m4*, *prefix-m1-m2-m3-m4-gc*).

**Range:** **s-, p-, ps-, 0-16383, aa-zz**

Specify a valid value for each subfield of the point code, and separate the subfields with a dash (-).

*prefix*—**s-, p-, ps-**

*nnnnn*—**0-16383**

*gc*—**aa-zz**

*m1-m2-m3-m4*—**0-14** for each member; values must sum to 14

**:opcn24=** (optional)

24-bit ITU national originating point code with subfields *main signaling area-sub signaling area-signaling point* (*msa-ssa-sp*).

**Range:** **p-, 000-255**

Specify a valid value for each subfield of the point code, and separate the subfields with a dash (-).

*prefix*—**p-**

*msa*—**000-255**

*ssa*—**000-255**

*sp*—**000-255**

**:tcapacn=** (optional)

TCAP application context name. This parameter specifies the ITU TCAP *acn* field in the incoming MSU.

**Range:** **0-255 none**

The *acn* field supports up to 7 subfields separated by a dash (e.g., *1-202-33-104-54-26-007*).

**none**—there is no ITU TCAP *acn* field in the incoming MSU

**:tcapfamily=** (optional)

This parameter specifies the ANSI TCAP *family* field in the incoming MSU.

**Range:** **0-255 none**

**none**—there is no ANSI TCAP *family* field in the incoming MSU

**:tcapopcode=** (optional)

This parameter specifies the TCAP *opcode* field in the incoming MSU.

**Range:** **0-255 none**

**none**—there is no TCAP *opcode* field in the incoming MSU

**:tcappkg=** (optional)

TCAP package. This parameter specifies the ANSI TCAP and ITU TCAP package type.

**Range:** **ituuni, qwop, qwop, resp, cwp, cwop, any, bgn, end, cnt, ituabort, ansiabort, ansiuni**

**ituuni**—ITU unidirectional

**qwop**—Query with Permission

**qwop**—Query without Permission

**resp**—Response



**cwp** — Conversation with Permission  
**cwop** — Conversation without Permission  
**any** — Wildcard value  
**bgn** — Begin  
**end** — End  
**cnt** — Continue  
**ituabort** — ITU abort  
**ansiabort** — ANSI abort  
**ansiuni** — ANSI unidirectional  
 ANSI TCAP Package Types—**ansiuni, qwp, qwop, resp, cwp, cwop, ansiabort, any**  
 ITU TCAP Package Types—**bgn, ituabort, ituuni, any, end, cnt**

**:tcappkgv=** (optional)

TCAP package value. This parameter specifies the TCAP package type value.

**Range: 0-255**

### Example

```

chg-sccp-msg:msgn=1:cgtt=4:cdnp=generic:eaglegen=yes:cdpc=2-2-2
chg-sccp-msg:msgn=3:cdgta=324ab12:cddt=6:cdnaiv=3:cgnai=rsvd
chg-sccp-msg:msgn=5:cddt=10:opc=4-5-6:cgpcn=1234
chg-sccp-msg:msgn=1:tcappkg=bgn:tcapopcode=34
  
```

### Dependencies

The FLOBR feature must be turned on before this command can be entered.

At least one optional parameter must be specified.

The **cdnp** and **cdnpv** parameters and the **cgnp** and **cgnpv** parameters cannot be specified together in the command.

The **cdnai** and **cdnaiv** parameters and the **cgnai** and **cgnaiv** parameters cannot be specified together in the command.

A TOBR quantity feature must be turned on before the **tcapacn**, **tcappkg**, **tcappkgv**, **tcapopcode**, or **tcapfamily** parameter can be specified.

The **tcappkg** and **tcappkgv** parameters cannot be specified together in the command.

The values **1** and **3** cannot be specified for the **cdgti** and **cggti** parameters.

The **tcapacn=\*** parameter cannot be specified.

### Output

```

chg-sccp-msg:msgn=1:tcapacn=7-8-9-0
tekelecstp 09-03-02 16:07:33 EST EAGLE 41.0.0
Command entered at terminal #4.
CHG-SCCP-MSG: MASP A - COMPLTD
;
  
```

## chg-sccp-serv

## Change SCCP Service

Use this command to:

- Change the state of G-Flex and G-Port services to online or offline. Taking a service offline shifts the processing load to designated nodes.
- Add PCs to an existing service group for service re-route assignment, or change the relative cost (RC) of existing point codes in a group.

**Keyword:** chg-sccp-serv  
**Related Commands:** dlt-sccp-serv, rtrv-sccp-serv  
**Command Class:** Database Administration

### Parameters

**NOTE:** See "Point Code Formats and Conversion" for a detailed description of point code formats, rules for specification, and examples.

**:serv=** (mandatory)

Service. This parameter specifies the name of the service.

**Range:** **gflex, gport, mnp**  
**gflex** — G-Flex (GSM Flexible Numbering)  
**gport** — G-Port (GSM Mobile Number Portability)  
**mnp** — Mobile Number Portability

**:gtt=** (optional)

GTT option indicator. This parameter specifies whether to use GTT as part of the re-routing procedure when the service is offline, and alternate PCs are not defined or not available.

**Range:** **no, yes**  
**no** — Do not use GTT as part of the re-routing procedure.  
**yes** — Use GTT as part of the re-routing procedure.

**Default:** **yes**

**:pc1=** (optional)

ANSI point code with subfields *network indicator-network cluster-network cluster member (ni-nc-ncm)*.

**Synonym:** **pca1**

**Range:** **000-255**  
Specify a valid value for each subfield of the point code, and separate the subfields with a dash (-).  
When **chg-sid:pctype=ansi** is specified, **ni = 000** is not valid.  
When **chg-sid:pctype=ansi** is specified, **nc = 000** is not valid if **ni = 001-005**.  
When **chg-sid:pctype=ansi** is specified, **nc = 000** is valid if **ni = 006-255**.  
The point code **000-000-000** is not a valid point code.

**:pc1/pca1/pci1/pcn1/pcn241=** (optional)

Alternate post-GTT-translated point code.

**:pc2=** (optional)

ANSI point code with subfields *network indicator-network cluster-network cluster member (ni-nc-ncm)*.

**Synonym:** **pca2**

**Range:** **000-255**  
Specify a valid value for each subfield of the point code, and separate the subfields with a dash (-).  
When **chg-sid:pctype=ansi** is specified, **ni = 000** is not valid.  
When **chg-sid:pctype=ansi** is specified, **nc = 000** is not valid if **ni = 001-005**.  
When **chg-sid:pctype=ansi** is specified, **nc = 000** is valid if **ni = 006-255**.  
The point code **000-000-000** is not a valid point code.

**:pc2/pca2/pci2/pcn2/pcn242=** (optional)

Alternate post-GTT-translated point code.

**:pc3=** (optional)

ANSI point code with subfields *network indicator-network cluster-network cluster member (ni-nc-ncm)*.

**Synonym:** **pca3**

**Range:** **000-255**

Specify a valid value for each subfield of the point code, and separate the subfields with a dash (-).

When **chg-sid:pctype=ansi** is specified, *ni = 000* is not valid.

When **chg-sid:pctype=ansi** is specified, *nc = 000* is not valid if *ni = 001-005*.

When **chg-sid:pctype=ansi** is specified, *nc = 000* is valid if *ni = 006-255*.

The point code **000-000-000** is not a valid point code.

**:pc3/pca3/pci3/pcn3/pcn243=** (optional)

Alternate post-GTT-translated point code.

**:pc4=** (optional)

ANSI point code with subfields *network indicator-network cluster-network cluster member (ni-nc-ncm)*.

**Synonym:** **pca4**

**Range:** **000-255**

Specify a valid value for each subfield of the point code, and separate the subfields with a dash (-).

When **chg-sid:pctype=ansi** is specified, *ni = 000* is not valid.

When **chg-sid:pctype=ansi** is specified, *nc = 000* is not valid if *ni = 001-005*.

When **chg-sid:pctype=ansi** is specified, *nc = 000* is valid if *ni = 006-255*.

The point code **000-000-000** is not a valid point code.

**:pc4/pca4/pci4/pcn4/pcn244=** (optional)

Alternate post-GTT-translated point code.

**:pci1=** (optional)

ITU international point code with subfields *zone-area-id*. The *prefix* subfield indicates a spare point code (*prefix-zone-area-id*).

**Range:** **s-, 0-255**

Specify a valid value for each subfield of the point code, and separate the subfields with a dash (-).

*prefix*—**s-**

*zone*—**0-7**

*area*—**000-255**

*id*—**0-7**

The point code **0-000-0** is not a valid point code.

**:pci2=** (optional)

ITU international point code with subfields *zone-area-id*. The *prefix* subfield indicates a spare point code (*prefix-zone-area-id*).

**Range:** **s-, 0-255**  
 Specify a valid value for each subfield of the point code, and separate the subfields with a dash (-).  
*prefix*—**s-**  
*zone*—**0-7**  
*area*—**000-255**  
*id*—**0-7**  
 The point code **0-000-0** is not a valid point code.

**:pci3=** (optional)  
 ITU international point code with subfields *zone-area-id*. The *prefix* subfield indicates a spare point code (*prefix-zone-area-id*).

**Range:** **s-, 0-255**  
 Specify a valid value for each subfield of the point code, and separate the subfields with a dash (-).  
*prefix*—**s-**  
*zone*—**0-7**  
*area*—**000-255**  
*id*—**0-7**  
 The point code **0-000-0** is not a valid point code.

**:pci4=** (optional)  
 ITU international point code with subfields *zone-area-id*. The *prefix* subfield indicates a spare point code (*prefix-zone-area-id*).

**Range:** **s-, 0-255**  
 Specify a valid value for each subfield of the point code, and separate the subfields with a dash (-).  
*prefix*—**s-**  
*zone*—**0-7**  
*area*—**000-255**  
*id*—**0-7**  
 The point code **0-000-0** is not a valid point code.

**:pcn1=** (optional)  
 ITU national point code in the format of a 5-digit number (*nnnnn*); or 2, 3, or 4 numbers (members) separated by dashes (*m1-m2-m3-m4*) as defined by the **chg-stpopts:npcfmti** flexible point code option. A group code must be specified when the ITUDUPPC feature is turned on (*nnnnn-gc*, *m1-m2-m3-m4-gc*). The *prefix* subfield indicates a spare point code (*prefix-nnnnn*, *prefix-nnnnn-gc*, *prefix-m1-m2-m3-m4*, *prefix-m1-m2-m3-m4-gc*).

**Range:** **s-, 0-16383, aa-zz**  
 Specify a valid value for each subfield of the point code, and separate the subfields with a dash (-).  
*prefix*—**s-**  
*nnnnn*—**0-16383**  
*gc*—**aa-zz**  
*m1-m2-m3-m4*—**0-14** for each member; values must sum to 14

**:pcn2=** (optional)

ITU national point code in the format of a 5-digit number (*nnnnn*); or 2, 3, or 4 numbers (members) separated by dashes (*m1-m2-m3-m4*) as defined by the **chg-stpopts:npcfmti** flexible point code option. A group code must be specified when the ITUDUPPC feature is turned on (*nnnnn-gc*, *m1-m2-m3-m4-gc*). The *prefix* subfield indicates a spare point code (*prefix-nnnnn*, *prefix-nnnnn-gc*, *prefix-m1-m2-m3-m4*, *prefix-m1-m2-m3-m4-gc*).

**Range:** **s-, 0-16383, aa-zz**

Specify a valid value for each subfield of the point code, and separate the subfields with a dash (-).

*prefix*—**s-**

*nnnnn*—**0-16383**

*gc*—**aa-zz**

*m1-m2-m3-m4*—**0-14** for each member; values must sum to 14

**:pcn241=** (optional)

24-bit ITU national point code with subfields *main signaling area-sub signaling area-signaling point* (*msa-ssa-sp*).

**Range:** **000-255**

Specify a valid value for each subfield of the point code, and separate the subfields with a dash (-).

*msa*—**000-255**

*ssa*—**000-255**

*sp*—**000-255**

**:pcn242=** (optional)

24-bit ITU national point code with subfields *main signaling area-sub signaling area-signaling point* (*msa-ssa-sp*).

**Range:** **000-255**

Specify a valid value for each subfield of the point code, and separate the subfields with a dash (-).

*msa*—**000-255**

*ssa*—**000-255**

*sp*—**000-255**

**:pcn243=** (optional)

24-bit ITU national point code with subfields *main signaling area-sub signaling area-signaling point* (*msa-ssa-sp*).

**Range:** **000-255**

Specify a valid value for each subfield of the point code, and separate the subfields with a dash (-).

*msa*—**000-255**

*ssa*—**000-255**

*sp*—**000-255**

**:pcn244=** (optional)

24-bit ITU national point code with subfields *main signaling area-sub signaling area-signaling point* (*msa-ssa-sp*).

**Range:** **000-255**

Specify a valid value for each subfield of the point code, and separate the subfields with a dash (-).

*msa*—000–255

*ssa*—000–255

*sp*—000–255

**:pcn3=** (optional)

ITU national point code in the format of a 5-digit number (*nnnnn*); or 2, 3, or 4 numbers (members) separated by dashes (*m1-m2-m3-m4*) as defined by the **chg-stpopts:npcfmti** flexible point code option. A group code must be specified when the ITUDUPPC feature is turned on (*nnnnn-gc*, *m1-m2-m3-m4-gc*). The *prefix* subfield indicates a spare point code (*prefix-nnnnn*, *prefix-nnnnn-gc*, *prefix-m1-m2-m3-m4*, *prefix-m1-m2-m3-m4-gc*).

**Range:** **s-, 0-16383, aa-zz**

Specify a valid value for each subfield of the point code, and separate the subfields with a dash (-).

*prefix*—s-

*nnnnn*—0-16383

*gc*—aa-zz

*m1-m2-m3-m4*—0-14 for each member; values must sum to 14

**:pcn4=** (optional)

ITU national point code in the format of a 5-digit number (*nnnnn*); or 2, 3, or 4 numbers (members) separated by dashes (*m1-m2-m3-m4*) as defined by the **chg-stpopts:npcfmti** flexible point code option. A group code must be specified when the ITUDUPPC feature is turned on (*nnnnn-gc*, *m1-m2-m3-m4-gc*). The *prefix* subfield indicates a spare point code (*prefix-nnnnn*, *prefix-nnnnn-gc*, *prefix-m1-m2-m3-m4*, *prefix-m1-m2-m3-m4-gc*).

**Range:** **s-, 0-16383, aa-zz**

Specify a valid value for each subfield of the point code, and separate the subfields with a dash (-).

*prefix*—s-

*nnnnn*—0-16383

*gc*—aa-zz

*m1-m2-m3-m4*—0-14 for each member; values must sum to 14

**:rc1=** (optional)

Relative cost 1. This parameter specifies the relative cost of the route for alternate post-GTT-translated point code 1.

**Range:** **0-99**

**:rc2=** (optional)

Relative cost 2. This parameter specifies the relative cost of the route for alternate post-GTT-translated point code 2.

**Range:** **0-99**

**:rc3=** (optional)

Relative cost 3. This parameter specifies the relative cost of the route for alternate post-GTT-translated point code 3.

**Range:** **0-99**

**:rc4=** (optional)

Relative cost 4. This parameter specifies the relative cost of the route for alternate post-GTT-translated point code 4.

**Range:** **0-99**

**:state=** (optional)

This parameter specifies the state of the service.

Re-routing is performed when the service state is **offline**.

**Range:** **offline, online**

**Default:** **offline**

### Example

```
chg-sccp-serv: serv=gport: state=online
chg-sccp-
serv: serv=gport: pca1=1-1-1: rc1=10: pca2=2-2-2: rc2=20: pca3=3-3-3: rc
3=30: pca4=4-4-4: rc4=40
chg-sccp-serv: serv=gport: pci1=2-2-2: rc1=10: pci2=3-3-3: rc2=10
chg-sccp-serv: serv=gport: state=online: gtt=yes
```

### Dependencies

The specified point code network type must match an existing point code network type.

The point code and relative cost parameter values must be specified together as a pair in the command.

The point code cannot match the existing site identification true point code.

The mate remote point code must already exist as destination in the Ordered Route entity set or reside in a cluster destination for which ordered routes are specified.

The SCCP Service table cannot be full when the command is entered. For each supported service (G-Port and G-Flex), up to 7 point codes can be specified for each network type (ANSI, ITU-I, S-ITU-I, ITU-N, S-ITU-N, and ITU-N24).

A maximum of 7 point codes can be allocated to a group or SCCP Service set.

- The A-Port or IGM feature must be enabled before the **serv=mnnp** parameter can be specified.
- The G-Flex feature must be enabled before the **serv=gflex** parameter can be specified.
- The G-Port feature must be enabled before the **serv=gport** parameter can be specified.

If the A-Port or IS41 GSM Migration (IGM) feature is enabled, the **serv=gport** parameter cannot be specified.

The A-Port or IGM feature must be enabled before the **serv=mnnp** parameter can be specified.

At least one optional parameter must be specified.

At least one PC/RC pair (for example, the **pc1** and **rc1** parameters) must be specified.

The mated point code must be a full point code.

Each new point code (specified by the **pc1**, **pc2**, **pc3** or **pc4** parameter) must already exist in the destination table. See the **ent-dstn** command.

The same point code value cannot be entered more than once in the SCCP-SERV table.

New and existing point codes cannot be entered together in the same command.

The specified MRN set must already exist in the MRN table for the SCCP-SERV table.

If the Flexible GTT Loadsharing feature is enabled, the specified point code must already exist in the specified SCCP-SERV set in the MRN table.

### Notes

The SCCP Service table is part of the MRN table.

When using **chg-sccp-serv** to modify relative cost values, all of the point codes that are specified in one command must exist in the same group in the SCCP-SERV table.

In this command, only ITU-international and ITU national point codes support the spare point code subtype prefix (s-).

This command supports the assignment of point codes to SCCP Service point code groups used for service re-route assignment. It is used to add point codes to a service group or to change the relative cost (RC) of existing point codes in a service group.

SCCP Service groups are organized by service (G-Flex or G-Port) and PC network type (ANSI, ITU-I, Spare ITU-I, ITU-N, Spare ITU-N, or ITUN-24). Up to 7 point codes can be in a network type grouping for service re-route load sharing. Up to 4 point codes can be added or modified in one command.

The **-sccp-serv** commands differ from the **-mrn** commands in that the service name (**serv** parameter) is required instead of an existing PC in the set serving as the key.

When using **chg-sccp-serv** to add new point codes, none of the point codes that are specified in one command can exist in the group in the SCCP-SERV table and must all be added to the same SCCP-SERV group.

### Output

The following example changes the SCCP service for G-Port to provision the point code and relative cost values:

```
chg-sccp-serv: serv=gport : pca1=1-1-1 : rc1=10 : pc2=1-1-2 : rc2=20
tekelecstp 05-12-20 08:35:15 EST 35.0.0
CHG-SCCP-SRV : MASP A - COMPLTD
;
```

## chg-sccpopts

### Change SCCP Options

Use this command to change the values of one or more of the SCCP option indicators maintained in the STP options table.

**Keyword:** **chg-sccpopts**

**Related Commands:** **rtrv-sccpopts**

**Command Class:** Database Administration

### Parameters

**:aclen=** (optional)

Area code length. This parameter specifies the length of the area code.

This parameter is used with the CgPN.

**Range:** **0-8**

**Default:** No change to the current value

**System** **0** - If the **aclen** parameter was provisioned in the **chg-tifo** command, then the value

**Default:** from the **chg-tifo** command is used as the initial value for the **aclen** parameter in the **chg-sccpopts** command.

**:cclen=** (optional)

Country code length. This parameter specifies the length of the country code.

This parameter is used with the CgPN.

**Range:** **0-3**

**Default:** No change to the current value

**System**

**Default:** **0**



**:class1seq=** (optional)

This parameter enables or disables Class 1 message sequencing.

**Range:** **on, off**

**on**—Enabled; Class 1 messages are guaranteed to be sequenced, but the messages are not load shared.

**off**—Disabled; Class 1 message sequencing is not guaranteed, but the messages might be load shared (if appropriate configuration exists).

**Default:** Current value

**System**

**Default:** **off**

**:cnvainat=** (optional)

This parameter specifies the value of the called party/calling party address Reserved for National Use bit during SCCP conversion when global title translation routes the message to the ITU national network.

The ANSI-ITU-China SCCP Conversion feature must be turned on before this parameter can be specified.

**Range:** **0, 1**

**0**— The Reserved for National Use bit is not reserved for national use.

**1**— The Reserved for National Use bit is reserved for national use.

**Default:** No change to the current value

**System**

**Default:** **1**

**:dfltgcpcasn=** (optional)

Default calling party ANSI point code set name. This parameter specifies the system default of the GTT calling party point code set for ANSI when the **gti=0** parameter is in the incoming MSU.

**Range:** *aaaaaaaa*, **none**

**none**—Removes the provisioned CgPA PC set.

**:dfltgcpcisn=** (optional)

Default calling party ITU point code set name. This parameter specifies the system default of the GTT calling party point code set for ITU when the **gti=0** parameter is in the incoming MSU.

**Range:** *aaaaaaaa*, **none**

1 leading alphabetic character and up to 8 following alphanumeric characters.

**none**—Removes the provisioned CgPA PC set.

**:dfltfallback=** (optional)

Default fallback option. This parameter specifies the action that is taken if the last translation doesn't match when performing GTT using a FLOBR-specific GTT mode.

**Range:** **no, yes**

**no**— GTT fails and the MSU is discarded

**yes**— GTT is performed based on the last matched entry

**Default:** No change to the current value

**System**

**Default:** **no**

**:dflgttmode=** (optional)

Default GTT mode. This parameter specifies the system default value of the GTT mode hierarchy used by the EAGLE 5 ISS when performing GTT.

**Range:** **acdcd, acdcgcd, acdcdeg, cd, cdcg, cg, cged, cgacdcd, fcd, fcg, fcgfd, fcdfcg**

**acdcd**— Advanced CdPA GTT, CdPA GTT

**acdcgcd**— Advanced CdPA GTT, CgPA GTT, CdPA GTT

**acdcdeg**— Advanced CdPA GTT, CdPA GTT, CgPA GTT

**cd** — CdPA GTT only  
**cdcg** — CdPA GTT, CgPA GTT  
**cg** — CgPA GTT only  
**cgcd** — CgPA GTT, CdPA GTT  
**cgacdcd** — CgPA GTT, Advanced CdPA GTT, CdPA GTT  
**fed** — FLOBR CdPA only  
**fcg** — FLOBR CgPA only  
**fcgfd** — FLOBR CgPA, FLOBR CdPA  
**fedfcg** — FLOBR CdPA, FLOBR CgPA

**:gmstcapce=** (optional)

This parameter enables and disables the processing of GSM Map Screening for TCAP\_Continue and TCAP\_End messages.

**Range:** **on, off**

**on** — Enables GSM Map Screening for TCAP\_Continue and TCAP\_End messages

**off** — Disables GSM Map Screening for TCAP\_Continue and TCAP\_End messages

**:intlunknai=** (optional)

This parameter specifies whether International NAIs (**nai=intl**) are included in Unknown NAIs (**nai=unkn**) and should be considered for country code CgPN (**cccgpn**) conditioning.

**Range:** **no, yes**

**Default:** No change to the current value

**System**

**Default:** **no**

**:mobrscpopc=** (optional)

This parameter specifies the OPC that is derived from the SCCP message that is used as an exception class.

**Range:** **sccp, mtp, tpc**

**sccp** — The OPC exception class uses the point code within the CGPA, if the CGPA portion of the message is "route-on-dpcssn". If the option is "route-on-gt", the **sccp** option is not used and defaults to the **mtp** option.

**mtp** — The OPC exception class uses the original MTP OPC value as its criteria.

**tpc** — The OPC exception class uses the EAGLE 5 ISS true point code for the criteria.

**:tgtt0=** (optional)

This parameter enables or disables transaction-based GTT loadsharing for SCCP Class0 UDT, Class0 XUDT, UDTS, and XUDTS messages.

**Range:** **udt, xudt, both, none**

**udt, none** — Enables transaction-based GTT loadsharing for UDTS and Class0 UDT messages.

**xudt, none** — Enables transaction-based GTT loadsharing for XUDTS and Class0 XUDT messages.

**both, none** — Enables transaction-based GTT loadsharing for UDTS, XUDTS, Class0 UDT, and Class0 XUDT messages.

**none** — Disables transaction-based GTT loadsharing for UDTS, XUDTS, Class0 UDT, and Class0 XUDT messages.

**Default:** No change to current value

**System**

**Default:** **none**

**:tgtt1=** (optional)

This parameter enables or disables transaction-based GTT loadsharing for SCCP Class1 UDT, Class1 XUDT, UDTS, and XUDTS messages.

**Range:** **udt, xudt, both, none**

**udt, none**— Enables transaction-based GTT loadsharing for UDTS and Class1 UDT messages.

**xudt, none**— Enables transaction-based GTT loadsharing for XUDTS and Class1 XUDT messages.

**both, none**— Enables transaction-based GTT loadsharing for UDTS, XUDTS, Class1 UDT, and Class1 XUDT messages.

**none**—Disables transaction-based GTT loadsharing for UDTS, XUDTS, Class1 UDT, and Class1 XUDT messages.

**Default:** No change to current value

**System**

**Default:** none

**:tgttudtkey=** (optional)

This parameter specifies the transaction parameter for incoming UDT(S) messages. Messages with this parameter are routed to the same load-shared PC within a MAPGROUP or MRNGROUP.

**Range:** **mtp, tcap, sccp, enhmtp**

**mtp**— Transaction-based GTT loadsharing is performed using the mtp algorithm for UDT and UDTS messages.

**tcap**— Transaction-based GTT loadsharing is performed using the tcap algorithm for UDT and UDTS messages.

**sccp**— Transaction-based GTT loadsharing is performed using the sccp algorithm for UDT and UDTS messages.

**enhmtp**— Transaction-based GTT loadsharing is performed using the enhanced mtp algorithm for UDT and UDTS messages.

**Default:** No change to current value

**System**

**Default:** mtp

**:tgtxudtkey=** (optional)

This parameter specifies the transaction parameter for incoming XUDT(S) messages. Messages with this parameter are routed to the same load-shared PC within a MAPGROUP or MRNGROUP.

**Range:** **mtp, sccp, enhmtp**

**mtp**— Transaction-based GTT loadsharing is performed using the mtp algorithm for XUDT and XUDTS messages.

**sccp**— Transaction-based GTT loadsharing is performed using the sccp algorithm for XUDT and XUDTS messages.

**enhmtp**— Transaction-based GTT loadsharing is performed using the enhanced mtp algorithm for XUDT and XUDTS messages.

**Default:** No change to current value

**System**

**Default:** mtp

### Example

```
chg-sccpopts:class1seq=on
chg-sccpopts:mobrscpopc=sccp
chg-sccpopts:tgtt0=udt
chg-sccpopts:tgtt1=xudt
chg-sccpopts:tgttudtkey=mtp
chg-sccpopts:tgtxudtkey=sccp
chg-sccpopts:cclen=1:aclen=3
chg-sccpopts:dfltfallback=yes
```

**chg-sccpopts:dfltgttmode=fcd**

### Dependencies

At least one optional parameter must be specified.

The Origin-based MTP Routing feature must be turned on before the **mobrscpopc** parameter can be specified.

The Origin-based SCCP Routing feature must be turned on before the **dfltgttmode** parameter can have a value of **acdcd**, **cgacdcd**, **acdcdcg**, **acdcdcg**, **cgcd**, **cdcg**, or **cg**.

The GTT set specified for the **dfltcgpcasn** and **dfltcgpcisn** parameters must exist in the GTTSET table.

The GTT set specified for the **dfltcgpcasn** and **dfltcgpcisn** parameters must have a set type of **cgpc** in the GTTSET table.

The GTT set domain for the **dfltcgpcasn** parameter must be an ANSI network domain, and the GTT set domain for the **dfltcgpcisn** parameter must be an ITU (including ITU-I, ITU-N, ITU-N24) network domain.

The Transaction-based GTT Loadsharing feature must be enabled before the **tgtt0**, **tgtt1**, **tgttudtkey**, or **tgtxudkey** parameters can be specified.

The GSM Map Screening feature must be turned on before the **gmstcapce** parameter can be specified.

The SCCP Conversion feature must be enabled before the **cnvainat** parameter can be specified.

The FLOBR feature must be turned on before the **dfltgttmode** parameter can have a value of **fed**, **fcg**, **fcgfd**, or **fcdfcg** and before the **dfltfallback** parameter can be specified.

The Origin-based SCCP Routing feature must be enabled before the **dfltcgpcasn** or **dfltcgpcisn** parameters can be specified.

### Notes

None.

### Output

The following example displays the command output when FLOBR feature is ON.

```
chg-sccpopts:dfltfallback=yes
rlghncxa03w 09-03-16 05:23:11 EST EAGLE 41.0.0
chg-sccpopts:dfltfallback=yes
CHG-SCCPOPTS: MASP A - COMPLTD
;
```

## chg-scr-aftpc

### Change Allowed Affected Point Code

Use this command to change the attributes of a specific screening reference in the allowed affected point code category. Attributes that can be changed are the point code and the subsystem number.

**Keyword:** **chg-scr-aftpc**

**Related Commands:** **dlt-scr-aftpc**, **ent-scr-aftpc**, **rtrv-scr-aftpc**

**Command Class:** Database Administration

### Parameters

**NOTE:** See "Point Code Formats and Conversion" for a detailed description of point code formats, rules for specification, and examples.

**:sr=** (mandatory)

Screening reference. This parameter specifies the point code's unique screening reference name.

**Range:** *ayyy*

1 alphabetic character followed by up to 3 alphanumeric characters

**:ssn=** (mandatory)

Subsystem number. An asterisk (\*) indicates the full range of values from **1-255**.

**Range:** **1-255 \***

**:actname=** (optional)

Action name. This parameter specifies the name of the gateway screening stop action set. Stop actions must be administered using the **actname** parameter in conjunction with the gateway screening stop action table (see the **chg-gws-actset** and **rtrv-gws-actset** commands).

**Range:** *ayyyyy*, **none**

1 alphabetic character followed by up to 5 alphanumeric characters.

**none**—Remove an existing gateway screening stop action set from a gateway screening rule.

**:area=** (optional)

ITU international area. The area is specified in the point code. The format of the point code is *zone-area-id*. An asterisk (\*) indicates the full range of values from **000-255**.

**Range:** **000-255 \***

**:id=** (optional)

ITU international ID. This parameter specifies the ID in the point code represented by format *zone-area-id*. An asterisk (\*) indicates the full range of values from **0-7**.

**Range:** **0-7, \***

**:msa=** (optional)

24-bit ITU-national main signaling area (*msa*) value. This parameter specifies the *msa* of the point code represented by *msa-ssa-spt*. An asterisk (\*) indicates the full range of values from **000-255**.

**Range:** **000-255 \***

**:narea=** (optional)

New ITU-international area value. An asterisk (\*) indicates the full range of values from **000-255**.

**Range:** **000-255 \***

**Default:** Current value

**:nc=** (optional)

Network cluster (*nc*) value. This parameter specifies one or more *nc* values for the network indicator (*ni*) and network cluster member (*ncm*) values specified in the **ni** and **ncm** parameters. It specifies the *nc* of the point code represented by *ni-nc-ncm*. A single value or a range of values can be specified. An asterisk (\*) indicates the full range of values from **000-255**.

**Range:** **000-255 \***

**:ncm=** (optional)

Network cluster member (*ncm*) value. This parameter specifies one or more *ncm* values for the network indicator (*ni*) and network cluster (*nc*) values identified in the **ni** and **nc** parameters. It specifies the *ncm* of the point code represented by *ni-nc-ncm*. A single value or a range of values can be specified. An asterisk (\*) indicates the full range of values from **000-255**.

**Range:** **0-255 \***

**:ni=** (optional)

Network indicator (*ni*) value. This parameter specifies one or more *ni* values for the network cluster (*nc*) and network cluster member (*ncm*) values identified in the **nc** and **ncm** parameters. It specifies the *ni* of the point code represented by *ni-nc-ncm*. A single value or a range of values can be specified. An asterisk (\*) indicates the full range of values from **000-255**.

**Range:** **0-255 \***

**:nid=** (optional)

New ITU-international ID value. An asterisk (\*) indicates the full range of values from **0-7**.

**Range:** **0-7, \***

**Default:** Current value

**:nmsa=** (optional)

New 24-bit ITU-national main signaling area (*nmsa*) value. It specifies the new *msa* of the point code represented by *msa-ssa-sp*. An asterisk (\*) indicates the full range of values from **000-255**.

**Range:** **000-255 \***

**:nnc=** (optional)

New network cluster (*nnc*). This parameter specifies one or more *nnc* values for the screening reference specified in the **sr** parameter. It specifies the new network cluster (*nc*) of the point code represented by *ni-nc-ncm*. A single value or a range of values can be specified. An asterisk (\*) indicates the full range of values from **000-255**.

**Range:** **000-255 \***

**Default:** Current value

**:nncm=** (optional)

New network cluster member (*nncm*). This parameter specifies one or more *ncm* values for the screening reference specified in the **sr** parameter. It specifies the new network cluster member (*ncm*) of the point code represented by *ni-nc-ncm*. A single value or a range of values can be specified. An asterisk (\*) indicates the full range of values from **0-255**.

**Range:** **0-255 \***

**Default:** Current value

**:nni=** (optional)

New network identifier (*nni*). This parameter specifies one or more *nni* values for the screening reference specified in the **sr** parameter. It specifies the new network indicator (*ni*) of the point code represented by *ni-nc-ncm*. A single value or a range of values can be specified. An asterisk (\*) indicates the full range of values from **000-255**.

**Range:** **0-255 \***

**Default:** Current value

**:nnpc=** (optional)

New ITU-national point code. An asterisk (\*) indicates the full range of values from **00000-16383**.

**NOTE: Gateway screening allows the ITU national point code to be displayed and entered in the database only as a single number. If you use multiple-part ITU national point codes, see "Converting ITU National Point Code Formats" in Appendix A for information on converting the point code format.**

**Range:** **00000-16383 \***

**Default:** Current value

**:npc=** (optional)

ITU national point code. An asterisk (\*) indicates the full range of values from **00000-16383**.

**Range:** **00000-16383 \***

**:npcst=** (optional)

New point code subtype. This parameter indicates whether the specified new ITU international or ITU national point code has no subtype prefix or has the spare point code prefix (**s-**).

**Range:** **none, s**

**Default:** **none**

**:nsfi=** (optional)

This parameter specifies the next screening category that is used in the gateway screening process. If specified, the parameter value must be **stop**. This halts the gateway screening process, and the message then proceeds through normal routing.

**Range:** **stop**

**Default:** Current value

**:nsp=** (optional)

New 24-bit ITU national signaling point (*nsp*). This parameter specifies the new *sp* of the point code represented by *msa-ssa-sp*. An asterisk (\*) indicates the full range of values from **000-255**.

**Range:** **000-255 \***

**:nsr=** (optional)

Next screening reference (*nsr*). This parameter specifies which screening reference in the specified screening category (**nsfi**) is to be used in the screening process. If the **nsfi=stop** parameter is specified, the **nsr** parameter cannot be specified.

**Range:** *ayyy*

1 alphabetic character followed by up to 3 alphanumeric characters

**Default:** Current value

**:nssa=** (optional)

New 24-bit ITU national sub signaling area (*nssa*). This parameter specifies the new sub signaling area (*ssa*) of the point code represented by *msa-ssa-sp*. An asterisk (\*) indicates the full range of values from **000-255**.

**Range:** **000-255 \***

**:nssn=** (optional)

New subsystem number. An asterisk (\*) indicates the full range of values from **000-255**.

**Range:** **000-255 \***

**Default:** Current value

**:nzone=** (optional)

New ITU-international zone. This parameter specifies a new zone for the point code represented by *zone-area-id*. An asterisk (\*) indicates the full range of values from **0-7**.

**Range:** **0-7, \***

**Default:** Current value

**:pcst=** (optional)

Point code subtype. This parameter specifies whether the specified ITU international or ITU national point code has no subtype prefix or has the spare point code prefix (s-).

**Range:** **none, s**

**Default:** **none**

**:sp=** (optional)

24-bit ITU national signaling point (*sp*). This parameter specifies the signaling point (*sp*) in the point code represented by *msa-ssa-sp*. An asterisk (\*) indicates the full range of values from **000-255**.

**Range:** **000-255 \***

**:ssa=** (optional)

24-bit ITU national sub signaling area (*ssa*). This parameter specifies the sub signaling area (*ssa*) in the point code represented by the format *msa-ssa-sp*. An asterisk (\*) indicates the full range of values from **000-255**.

**Range:** **000-255 \***

**:zone=** (optional)

ITU international zone. This parameter specifies the zone in the point code represented by format *zone-area-id*. An asterisk (\*) indicates the full range of values from **0-7**.

**Range:** **0-7,\***

### Example

```
chg-scr-
aftpc:sr=iec:ni=240:nc=010:ncm=010:ssn=254:nni=240:nnc=003:nncm=0
30 :nssn=253

chg-scr-
aftpc:sr=iec:ni=240:nc=008:ncm=203:nssn=253:nsfi=stop:actname=cop
y

chg-scr-
aftpc:sr=aft1:zone=1:area=2:id=3:nsfi=stop:ssn=1:pcst=s:npcst=non
e
```

### Dependencies



**CAUTION:** Even though gateway screening is in the screen test mode, as defined by the parameters **gwsa=off** and **andgws=on**, the gateway screening action in the stop action set specified by the **actname** parameter of the screen set *will* be performed at the end of the screening process.

A complete point code must be specified, and must be one, and only one of the four point code parameter combinations: **ni-nc-ncm**; **zone-area-id**; **msa-ssa-sp**; or **npc**.

ANSI point code value **000-000-000** and ITU-International point code value **0-000-0** are not allowed.

At least one optional parameter must be specified.

The new affected point code and subsystem number to be changed cannot already exist in the affected point code entity set.

The **actname** parameter value must already be defined in the Gateway Screening Stop Action table with the **chg-gws-actset** command. These values are shown in the *ACT NAME* field of the **rtrv-gws-actset** command output.

If the **zone=\*** parameter is specified, the **area=\*** and **id=\*** parameters must be specified.

If the **area=\*** parameter is specified, the **id=\*** parameter must be specified.

If the **msa=\*** parameter is specified, the **ssa=\*** and **sp=\*** parameters must be specified.

If the **ssa=\*** parameter is specified, the **sp=\*** parameter must be specified.

If the **nc** parameter is specified as a range, the **ncm** parameter must be specified as an asterisk or as the full range **000-255**

If the **nc** parameter is specified as a single value or a range, a single value must be specified for the **ni** parameter.

If the **nc=\*** parameter is specified, the **ncm** parameter must be specified as an asterisk or as the full range **000-255**.

If the **ncm** parameter is specified as a single value, or a range other than the full range of **000-255**, the **ni** and the **nc** parameters must be specified with a single value.

If the **ni** parameter is specified as an asterisk (**ni=\***) or as a range, the **nc** and **ncm** parameters must be specified as an asterisk or as the full range **000-255**.

If the **nsfi** parameter is specified, the parameter value must be **stop**.

If the **nsfi=stop** parameter is specified, the **nsr** parameter cannot be specified.



The character **c** is not a valid value for the **ni**, **nc**, **ncm**, **zone**, **area**, **id**, **msa**, **ssa**, **sp**, and **npc** parameters.

The Gateway Screening Rules table can contain a maximum of 372,600 rules.

The specified screening reference (**sr**) must already exist in the database.

The Spare Point Code Support feature must be enabled before the **pcst** parameter can be specified.

The spare point code subtype prefix (**s-**) is not supported for ANSI point codes (parameters **ni**, **nc**, **ncm**) or for 24-bit ITU national point codes (parameters **msa**, **ssa**, **sp**). The **pcst** and **npcst** parameters cannot be specified for ANSI and ITU-N24 point codes.

The affected point code and subsystem number to be changed must already exist in the affected point code entity set.

## Notes

A range of values is specified by separating the values that define the range by two ampersands (**&&**); for example, **:ni=025&&100** specifies all network indicators for ANSI point codes from **25** to **100**.

An asterisk cannot be specified for a parameter value in this command unless an asterisk was specified for the parameter value in the original **ent-scr-aftpc** command.

If the screen set reaches 100% capacity (indicated by the “100% full” message), the system will allow subsequent entries. An error will occur, however, when downloading the screen set to the card. Screen sets should not exceed 100% capacity. Remove screen set entries until the capacity is below 100%.

A screening reference is assigned to screen sets using the **ent-scrset** command. A screening reference can belong to multiple screen sets.

The spare point code subtype prefix **s-** is supported only for ITU international and ITU national point codes. The **pcst** parameter indicates whether the specified point code has no subtype prefix or has the spare point code prefix.

## Output

**chg-scr-**

```
aftpc:sr=iec:ni=240:nc=010:ncm=010:ssn=254:nni=240:nnc=003:nncm=0
30 :nssn=253
```

```
rlghncxa03w 04-01-07 11:43:04 EST EAGLE 31.3.0
CHG-SCR-AFTPC: SCREEN SET AFFECTED - IEC 25% FULL
CHG-SCR-AFTPC: MASP A - COMPLTD
```

```
;
```

### Legend

**CHG-SCR-AFTPC**—The command entered that caused this output. This is echoed to the printer as a reference.

**SCREEN SET AFFECTED**—Identifies the screen set that was affected by the command. The screen set name is shown.

**% FULL**—Indicates the relative size of the screen set.

## chg-scr-blkdp

## Change Blocked DPC

Use this command to change the attributes of a specific screening reference in the blocked DPC category. Attributes that can be changed are the blocked destination point code, next screening function identifier, and the next screening reference.

**Keyword:** chg-scr-blkdpc

**Related Commands:** dlt-scr-blkdpc, ent-scr-blkdpc, rtrv-scr-blkdpc

**Command Class:** Database Administration

### Parameters

**NOTE:** See "Point Code Formats and Conversion" for a detailed description of point code formats, rules for specification, and examples.

**:sr=** (mandatory)

Screening reference. This parameter specifies the point code's unique screening reference name.

**Range:** *ayyy*  
1 alphabetic character followed by up to 3 alphanumeric characters

**:actname=** (optional)

Action name. This parameter specifies the name of the gateway screening stop action set. Stop actions must be administered using the **actname** parameter in conjunction with the gateway screening stop action table (see **chg-gws-actset** and **rtrv-gws-actset**).

**Range:** *ayyyyy*, **none**  
1 alphabetic character followed by up to 5 alphanumeric characters.  
**none**—Remove an existing gateway screening stop action set from a gateway screening rule.

**:area=** (optional)

ITU international area. The area is specified in the point code. The format of the point code is *zone-area-id*. An asterisk (\*) indicates the full range of values from **000–255**.

**Range:** **000-255** \*, C

**:id=** (optional)

ITU international ID. This parameter specifies the ID in the point code represented by format *zone-area-id*. An asterisk (\*) indicates the full range of values from **0–7**.

**Range:** **0-7**, \*, C

**:msa=** (optional)

24-bit ITU-national main signaling area (*msa*) value. This parameter specifies the main signaling area (*msa*) of the point code represented by *msa-ssa-spt*. An asterisk (\*) indicates the full range of values from **000–255**.

**Range:** **000-255** \*, C

**:narea=** (optional)

New ITU-international area value. An asterisk (\*) indicates the full range of values from **000–255**.

**Range:** **000-255** \*, C

**Default:** Current value

**:nc=** (optional)

Network cluster (*nc*) value. This parameter specifies one or more *nc* values for the network indicator (*ni*) and network cluster member (*ncm*) values specified in the **ni** and **ncm** parameters. It specifies the *nc* of the point code represented by *ni-nc-ncm*. A single value or a range of values can be specified. An asterisk (\*) indicates the full range of values from **000–255**.

**Range:** **000-255** \*, C

**:ncm=** (optional)

Network cluster member (*ncm*) value. This parameter specifies one or more *ncm* values for the network indicator (*ni*) and network cluster (*nc*) values identified in the **ni** and **nc** parameters. It specifies the *ncm* of the point code represented by *ni-nc-ncm*. A single value or a range of values can be specified. An asterisk (\*) indicates the full range of values from **000–255**.

**Range:** 0-255 \*, C

**:ni=** (optional)

Network indicator (*ni*) value. This parameter specifies one or more *ni* values for the network cluster (*nc*) and network cluster member (*ncm*) values identified in the **nc** and **ncm** parameters. It specifies the *ni* of the point code represented by *ni-nc-ncm*. A single value or a range of values can be specified. An asterisk (\*) indicates the full range of values from **000–255**.

**Range:** 0-255 \*, C

**:nid=** (optional)

New ITU-international ID value. An asterisk (\*) indicates the full range of values from **0–7**.

**Range:** 0-7 \*, C

**Default:** Current value

**:nmsa=** (optional)

New 24-bit ITU-national main signaling area (*nmsa*) value. This parameter specifies the new main signaling area (*msa*) of the point code represented by *msa-ssa-sp*. An asterisk (\*) indicates the full range of values from 000-255.

**Range:** 000-255 \*, C

**:nnc=** (optional)

New network cluster (*nnc*). This parameter specifies one or more *nnc* values for the screening reference specified in the **sr** parameter. It specifies the new network cluster (*nc*) of the point code represented by *ni-nc-ncm*. A single value or a range of values can be specified. An asterisk (\*) indicates the full range of values from **000–255**.

**Range:** 000-255 \*, C

**Default:** Current value

**:nncm=** (optional)

New network cluster member (*nncm*). This parameter specifies one or more *ncm* values for the screening reference specified in the **sr** parameter. It specifies the new network cluster member (*ncm*) of the point code represented by *ni-nc-ncm*. A single value or a range of values can be specified. An asterisk (\*) indicates the full range of values from **0–255**.

**Range:** 0-255 \*, C

**Default:** Current value

**:nni=** (optional)

New network identifier (*nni*). This parameter specifies one or more *nni* values for the screening reference specified in the **sr** parameter. It specifies the new network indicator (*ni*) of the point code represented by *ni-nc-ncm*. A single value or a range of values can be specified. An asterisk (\*) indicates the full range of values from **000–255**.

**Range:** 0-255 \*, C

**Default:** Current value

**:nnpc=** (optional)

New ITU-national point code. An asterisk (\*) indicates the full range of values from **00000–16383**.

**NOTE: Gateway screening allows the ITU national point code to be displayed and entered in the database only as a single number. If you use multiple-part ITU national point codes, see "Converting ITU National Point Code Formats" in Appendix A for information on converting the point code format.**

**Range:** 00000-16383 \*, C

**Default:** Current value

**:npc=** (optional)

The ITU national point code. An asterisk (\*) indicates the full range of values from **00000–16383**.

**Range:** 00000-16383 \*, C

**:npcst=** (optional)

New point code subtype. This parameter indicates whether the specified new ITU international or ITU national point code has no subtype prefix or has the spare point code prefix (s-).

**Range:** none, s

**Default:** none

**:nsfi=** (optional)

This parameter specifies the next screening category that is used in the gateway screening process, or it indicates that the gateway screening process should stop.

**Range:** cgpa, destfld, fail, isup, stop

**cgpa**—Allowed CGPA is the next screening category.

**destfld**—Allowed destination field (DESTFLD) is the next screening category.

**fail**—Discard the received message.

**isup**—ISUP message type (ISUP) is the next screening category.

**stop**—The gateway screening process ends and the message proceeds through normal routing.

**Default:** Current value

**:nsp=** (optional)

The new 24-bit ITU national signaling point (*nsp*). It specifies the new signaling point (*sp*) of the point code represented by *msa-ssa-sp*. An asterisk (\*) indicates the full range of values from **000-255**.

**Range:** 000-255 \*, C

**:nsr=** (optional)

Next screening reference (*nsr*). This parameter specifies which screening reference in the specified screening category (**nsfi**) is to be used in the screening process. If the **nsfi=stop** parameter is specified, the **nsr** parameter cannot be specified.

**Range:** ayyy

1 alphabetic character followed by up to 3 alphanumeric characters

**Default:** Current value

**:nssa=** (optional)

New 24-bit ITU national sub signaling area (*nssa*). This parameter specifies the new sub signaling area (*ssa*) of the point code represented by *msa-ssa-sp*. An asterisk (\*) indicates the full range of values from **000-255**.

**Range:** 000-255 \*, C

**:nzone=** (optional)

New ITU-international zone. This parameter specifies a new zone for the point code represented by *zone-area-id*. An asterisk (\*) indicates the full range of values from **0-7**.

**Range:** 0-7, \*, C

**Default:** Current value

**:pcst=** (optional)

Point code subtype. This parameter specifies whether the specified ITU international or ITU national point code has no subtype prefix or has the spare point code prefix (s-).

**Range:** none, s

**Default:** none

**:sp=** (optional)

24-bit ITU national signaling point (*sp*). This parameter specifies the signaling point (*sp*) in the point code represented by *msa-ssa-sp*. An asterisk (\*) indicates the full range of values from **000-255**.

**Range:** 000-255 \*, C

**:ssa=** (optional)

24-bit ITU national sub signaling area (*ssa*). This parameter specifies the sub signaling area (*ssa*) in the point code represented by the format *msa-ssa-sp*. An asterisk (\*) indicates the full range of values from **000-255**.

**Range:** 000-255 \*, C

**:zone=** (optional)

ITU international zone. This parameter specifies the zone in the point code represented by format *zone-area-id*. An asterisk (\*) indicates the full range of values from **0-7**.

**Range:** 0-7 \*, C

### Example

```
chg-scr-
blkdpc:sr=iec:ni=240:nc=010:ncm=010:nni=240:nnc=003:nncm=030
chg-scr-blkdpc:sr=iec:ni=c:nc=c:ncm=c:nsfi=cgpa:nsr=wrld2
chg-scr-blkdpc:sr=iec:ni=240:nc=010:ncm=010:nsfi=stop:actname=cr
chg-scr-blkdpc:sr=bdpl:npc=128:nsfi=fail:pcst=s:npcst=none
```

### Dependencies



**CAUTION:** Even though gateway screening is in the screen test mode, as defined by the parameters **gwsa=off** and **andgws=on**, the gateway screening action in the stop action set specified by the **actname** parameter of the screen set *will* be performed at the end of the screening process.

The Gateway Screening Rules table can contain a maximum of 362,700 rules.

A complete point code must be specified, using the **ni-nc-ncm**, **zone-area-id**, **msa-ssa-sp**, or **npc** combination unless a value of **c** for “continue” is specified.

A new point code entry must be specified by one, and only one of the four point code parameter combinations: **nni-nnc-nncm**, **nzone-narea-nid**, **nmsa-nssa-nsp**, or **nnpc**. If the new point code entry is a different point code type than the existing point code entry, all subfields of the new point code type must be specified.

ANSI point code value **000-000-000** and ITU-International point code value **0-000-0** are not allowed.

At least one optional parameter must be specified.

The blocked DPC specified by **ni-nc-ncm**; **zone-area-id**; **msa-ssa-sp**; or the **npc** parameter must already exist in the screening reference or within an existing range of DPCs.

The new blocked DPC or DPC range defined by **ni-nc-ncm**; **zone-area-id**, **msa-ssa-sp**, or the **npc** parameter must not already exist in the screening reference or within an existing range of DPCs.

If an asterisk (\*) is specified for the new blocked DPC, nothing that matches the specified range of DPCs can already exist in the DPC screening table for the screening reference.

If the **actname** parameter is specified, the **nsfi-stop** parameter must be specified.

If the **actname** parameter is specified, the **nsr** parameter cannot be specified.

The value of the **actname** parameter must already be defined in the Gateway Screening Stop Action table with the **chg-gws-actset** command. These values are shown in the *ACTNAME* field of the **rtrv-gws-actset** command output.

If the **area=\*** parameter is specified, then the **id=\*** parameter must be specified.

If the **msa=\*** parameter is specified, then the **ssa=\*** and the **sp=\*** parameters must be specified.

If the **msa=c** parameter is specified, then the **ssa** and the **sp** parameters must have a value of **c** or must not be specified. If the **msa=c** parameter is specified, and the **ssa** and the **sp** parameters are not specified, then the **ssa** and **sp** parameters default to a value of **c**.

If the **nc** parameter is specified as a range, the **ncm** parameter must be specified as an asterisk or as the full range **000–255**.

If the **nc** parameter is specified as a single value or a range, a single value must be specified for the **ni** parameter.

If the **nc** parameter is specified as an asterisk (**nc=\***), the **ncm** parameter must be specified as an asterisk or as the full range **000–255**.

If the **ncm** parameter is specified as a single value, or a range other than the full range of **000–255**, the **ni** and the **nc** parameters must be specified with a single value.

If the **ni** parameter is specified as an asterisk (**ni=\***) or as a range, the **nc** and **ncm** parameters must be specified as an asterisk or as the full range **000–255**.

If the **ni=c** parameter is specified, then the **nc** and the **ncm** parameters must have a value of **c** or must not be specified. If the **ni=c** parameter is specified, and the **nc** and the **ncm** parameters are not specified, then the **nc** and **ncm** parameters default to a value of **c**.

If the specified **ni-nc-ncm**, **zone-area-id**, or **msa-ssa-sp** is not equal to **c-c-c**, or if the **npc=c** parameter is not specified, then the **nsfi=fail** parameter must be specified, and the **nsr** parameter cannot be specified.

If the **nnc** parameter is specified as a range, the **nncm** parameter must be specified as an asterisk or as the full range **000–255**.

If the **nnc** parameter is specified as a single value or a range, a single value must be specified for the **nni** parameter.

If the **nnc** parameter is specified as an asterisk (**nnc=\***), the **nncm** parameter must be specified as an asterisk or as the full range **000–255**.

If the **nncm** parameter is specified as a single value, or a range other than the full range of **000–255**, the **nni** and the **nnc** parameters must be specified with a single value.

If the **nni** parameter is specified as an asterisk (**nni=\***) or as a range, the **nnc** and **nncm** parameters must be specified as an asterisk or as the full range **000–255**.

If the value of the **nsfi** parameter is not **stop** or **fail**, then the **nsr** parameter must be specified.

If the **nsfi=fail** parameter is specified, then the **nni**, **nc**, **nncm**, **narea**, **nzone**, **nid**, **nmsa**, **nssa**, **nsp**, and **npc** parameters cannot have a value of **c**.

The specified screening reference (**sr**) must already exist in the database.

The Spare Point Code Support feature must be enabled before the **pcst** parameter can be specified.

The **pcst** and **npcst** parameters cannot be specified with **c** for a blocked screen reference (**sr**).

The spare point code subtype prefix (**s-**) is not supported for ANSI point codes (parameters **ni**, **nc**, **ncm**) or for 24-bit ITU national point codes (parameters **msa**, **ssa**, **sp**). The **pcst** and **npcst** parameters cannot be specified for ANSI and ITU-N24 point codes.

If the **ssa=\*** parameter is specified, then the **sp=\*** parameter must be specified.

If the **zone=\*** parameter is specified, then the **area=\*** and the **id=\*** parameters must be specified.

If the **zone=c** parameter is specified, then the **area** and the **id** parameters must have a value of **c** or must not be specified. If the **zone=c** parameter is specified, and the **area** and the **id** parameters are not specified, then the **area** and **id** parameters default to a value of **c**.

The **nsfi=fail** parameter cannot be specified when changing a continue entry.

The **nsfi** and **nsr** parameters cannot be specified when changing a screening entry that is other than the continue entry (**c-c-c**).

The value of the **nsfi** parameter must be valid for the BLKDPC entity type.

If the specified **ni-nc-ncm** or **zone-area-id** or **msa-ssa-sp** is equal to **c-c-c** or if the **npc=c** parameter is specified, the **nsfi=fail** parameter cannot be specified, and the **nmi**, **nnc**, **nncm**, **nzone**, **narea**, **nid**, **nmsa**, **nssa**, **nsp**, and **npc** parameters cannot be specified. Point code **c-c-c** and **npc=c** cannot be changed to a numbered point code.

The **nsfi** and **nsr** parameters must point to an existing screen, or the **nsfi=stop** parameter must be specified, and the **nsr** parameter cannot be specified.

## Notes

When a blocked DPC screening reference is created, the first entry for a point code must be **c-c-c**, or **c** for the **npc** parameter. Subsequent entries must be specific point codes.

The character **c** is used in the blocked DPC screens to allow the screening process to continue for messages with point codes that do not match any point codes in the blocked DPC screens. When screening for a blocked DPC and the point code being screened does not match any of the point codes in the blocked DPC screens, the message is not rejected and the screening process continues.

There must be an entry in the blocked DPC screens to allow the screening process to continue. This entry consists of a screening reference, point code, **nsfi**, and **nsr**. The point code is **npc=c** or subfields equal to **c-c-c**. When the character **c** is specified, the **nsfi** and **nsr** parameters must be specified.

If the character **c** is specified for the parameters **ni-nc-ncm** or **zone-area-id** or **msa-ssa-sp**, the character **c** is the only value that can be specified for all three parameters. No other values can be used. For example, a point code **c-c-255** is not allowed. The point code must be **c-c-c**. The asterisk (\*) value cannot be used with the character **c** (for example, a point code **c-c-\*** is not allowed).

When the point code does not match any entries in the blocked DPC screens, the screening process is directed to the screening reference with the point code **c-c-c** or **npc=c**. The **nsfi** and **nsr** in this entry are examined to determine the next step in the screening process.

If the current **ni-nc-ncm** or **zone-area-id** or **msa-ssa-sp** is equal to **c-c-c** or **npc=c**, only the **nsfi** and **nsr** can be changed. Otherwise, only the blocked DPC can be changed.

A range of values is specified by separating the values that define the range by two ampersands (&&); for example, **: ni=025&&100** specifies all network indicators for ANSI point codes from **25** to **100**.

An asterisk cannot be specified for a parameter value in this command unless an asterisk was specified for the parameter value in the **ent-scr-blkdpc** command.

If the screen set reaches 100% capacity (indicated by the 100% Full message), the system allows subsequent entries. An error occurs, however, when downloading the screen set to an LIM. Ensure that screen sets do not exceed 100% capacity. Remove screen set entries until the capacity is below 100%.

The spare point code subtype prefix **s-** is supported only for ITU international and ITU national point codes. The **pcst** and **npcst** parameters indicate whether the specified point code has no subtype prefix or has the spare point code prefix.

**Output**

```

chg-scr-
blkdpc: sr=ss01: ni=240: nc=010: ncm=010: nni=240: nnc=003: nncm=030
rlghncxa03w 04-01-07 11:43:04 EST EAGLE 31.3.0
CHG-SCR-BLKDPC: SCREEN SET AFFECTED - SS01 25% FULL
CHG-SCR-BLKDPC: MASP A - COMPLTD
;

```

**Legend**

**CHG-SCR-BLKDPC**—The command entered that caused this output. This is echoed to the printer as a reference.

**SCREEN SET AFFECTED**—Identifies the screen set that was affected by the command. The screen set name is shown.

**% FULL**—Indicates the relative size of the screen set.

**chg-scr-blkopc****Change Blocked OPC**

Use this command to change the attributes associated with a screening reference in the blocked OPC category. Attributes that can be changed are the point code, next screening function identifier, and next screening reference.

**Keyword:** **chg-scr-blkopc**

**Related Commands:** **dlt-scr-blkopc**, **ent-scr-blkopc**, **rtrv-scr-blkopc**

**Command Class:** Database Administration

**Parameters**

**:sr=** (mandatory)

Screening reference. This parameter specifies the point code's unique screening reference name.

**Range:** *ayyy*

1 alphabetic character followed by up to 3 alphanumeric characters

**:actname=** (optional)

The name of the gateway screening stop action set. Stop actions must be administered using the **actname** parameter in conjunction with the gateway screening stop action table (see **chg-gws-actset** and **rtrv-gws-actset**).

**Range:** *ayyyyy*, **none**

1 alphabetic character followed by up to 5 alphanumeric characters.

**none**—Remove an existing gateway screening stop action set from a gateway screening rule.

**:area=** (optional)

The ITU international area. The area is specified in the point code. The format of the point code is *zone-area-id*. An asterisk (\*) indicates the full range of values from **000–255**.

**Range:** **000-255** \*, C

**:id=** (optional)

The ITU international ID. The parameter specifies the ID in the point code represented by format *zone-area-id*. An asterisk (\*) indicates the full range of values from **0–7**.

**Range:** **0-7** \*, C



**:msa=** (optional)

The 24-bit ITU-national main signaling area (*msa*) value. It specifies the main signaling area (*msa*) of the point code represented by *msa-ssa-spt*. An asterisk (\*) indicates the full range of values from **000-255**.

**Range:** 000-255 \*, C

**:narea=** (optional)

The new ITU-international area value. An asterisk (\*) indicates the full range of values from **000-255**.

**Range:** 000-255 \*, C

**Default:** Current value

**:nc=** (optional)

The network cluster (*nc*) value. This parameter specifies one or more *nc* values for the network indicator (*ni*) and network cluster member (*ncm*) values specified in the **ni** and **ncm** parameters. It specifies the *nc* of the point code represented by *ni-nc-ncm*. A single value or a range of values can be specified. An asterisk (\*) indicates the full range of values from **000-255**.

**Range:** 000-255 \*, C

**:ncm=** (optional)

The network cluster member (*ncm*) value. This parameter specifies one or more *ncm* values for the network indicator (*ni*) and network cluster (*nc*) values identified in the **ni** and **nc** parameters. It specifies the *ncm* of the point code represented by *ni-nc-ncm*. A single value or a range of values can be specified. An asterisk (\*) indicates the full range of values from **000-255**.

**Range:** 0-255 \*, C

**:ni=** (optional)

The network indicator (*ni*) value. This parameter specifies one or more *ni* values for the network cluster (*nc*) and network cluster member (*ncm*) values identified in the **nc** and **ncm** parameters. It specifies the *ni* of the point code represented by *ni-nc-ncm*. A single value or a range of values can be specified. An asterisk (\*) indicates the full range of values from **000-255**.

**Range:** 0-255 \*, C

**:nid=** (optional)

The new ITU-international ID value. An asterisk (\*) indicates the full range of values from **0-7**.

**Range:** 0-7, \*, C

**Default:** Current value

**:nmsa=** (optional)

The new 24-bit ITU-national main signaling area (*nmsa*) value. It specifies the new main signaling area (*msa*) of the point code represented by *msa-ssa-spt*. An asterisk (\*) indicates the full range of values from **000-255**.

**Range:** 000-255 \*, C

**:nnc=** (optional)

The new network cluster (*nnc*). This parameter specifies one or more *nnc* values for the screening reference specified in the **sr** parameter. It specifies the new network cluster (*nc*) of the point code represented by *ni-nc-ncm*. A single value or a range of values can be specified. An asterisk (\*) indicates the full range of values from **000-255**.

**Range:** 000-255 \*, C

**Default:** Current value

**:nncm=** (optional)

The new network cluster member (*nncm*). This parameter specifies one or more *ncm* values for the screening reference specified in the **sr** parameter. It specifies the new network cluster member

(*ncm*) of the point code represented by *ni-nc-ncm*. A single value or a range of values can be specified. An asterisk (\*) indicates the full range of values from **0–255**.

**Range:** 0-255 \*, C

**Default:** Current value

**:nmi=** (optional)

The new network identifier (*nmi*). This parameter specifies one or more *nmi* values for the screening reference specified in the **sr** parameter. It specifies the new network indicator (*ni*) of the point code represented by *ni-nc-ncm*. A single value or a range of values can be specified. An asterisk (\*) indicates the full range of values from **000–255**.

**Range:** 0-255 \*, C

**Default:** Current value

**:nnpc=** (optional)

The new ITU-national point code. An asterisk (\*) indicates the full range of values from **00000–16383**.

**NOTE: Gateway screening allows the ITU national point code to be displayed and entered in the database only as a single number. If you use multiple-part ITU national point codes, see "Converting ITU National Point Code Formats" in Appendix A for information on converting the point code format.**

**Range:** 00000-16383 \*, C

**Default:** Current value

**:npc=** (optional)

The ITU national point code. An asterisk (\*) indicates the full range of values from **00000–16383**.

**Range:** 00000-16383 \*, C

**:npct=** (optional)

New point code subtype. This parameter indicates whether the specified new ITU international or ITU national point code has no subtype prefix or has the spare point code prefix (s-).

**Range:** none, s

**Default:** none

**:nsfi=** (optional)

This parameter specifies the next screening category that is used in the gateway screening process, or it indicates that the gateway screening process should stop.

**Range:** cgpa, fail, stop, sio, dpc, blkdpc

**cgpa** — Allowed CGPA

**fail** — Discard the received message.

**stop** — The gateway screening process ends and the message proceeds through normal routing.

**sio** — Allowed SIO

**dpc** — Allowed DPC

**blkdpc** — Blocked DPC

**Default:** Current value

**:nsp=** (optional)

New 24-bit ITU national signaling point (*nsp*). This parameter specifies the new signaling point (*sp*) of the point code represented by *msa-ssa-sp*. An asterisk (\*) indicates the full range of values from **000-255**.

**Range:** 000-255 \*, C

**:nsr=** (optional)

Next screening reference (*nsr*). The parameter indicates which screening reference in the specified screening category (**nsfi**) is to be used in the screening process. If **nsfi=stop**, the **nsr** parameter cannot be specified.

**Range:** *ayyy*

1 alphabetic character followed by up to 3 alphanumeric characters

**Default:** Current value

**:nssa=** (optional)

The new 24-bit ITU national sub signaling area (*nssa*). It specifies the new sub signaling area (*ssa*) of the point code represented by *msa-ssa-sp*. An asterisk (\*) indicates the full range of values from **000-255**.

**Range:** **000-255** \*, C

**:nzone=** (optional)

The new ITU-international zone. The parameter specifies a new zone for the point code represented by *zone-area-id*. An asterisk (\*) indicates the full range of values from **0-7**.

**Range:** **0-7** \*, C

**Default:** Current value

**:pcst=** (optional)

Point code subtype. This parameter indicates whether the specified ITU international or ITU national point code has no subtype prefix or has the spare point code prefix (s-).

**Range:** **none, s**

**Default:** **none**

**:sp=** (optional)

The 24-bit ITU national signaling point (*sp*). This parameter specifies the signaling point (*sp*) in the point code represented by *msa-ssa-sp*. An asterisk (\*) indicates the full range of values from **000-255**.

**Range:** **000-255** \*, C

**:ssa=** (optional)

The 24-bit ITU national sub signaling area (*ssa*). This parameter specifies the sub signaling area (*ssa*) in the point code represented by the format *msa-ssa-sp*. An asterisk (\*) indicates the full range of values from **000-255**.

**Range:** **000-255** \*, C

**:zone=** (optional)

The ITU international zone. The parameter specifies the zone in the point code represented by format *zone-area-id*. An asterisk (\*) indicates the full range of values from **0-7**.

**Range:** **0-7** \*, C

**Example**

```
chg-scr-
blkopc:sr=iec:ni=240:nc=010:ncm=010:nni=240:nnc=010:nncm=020
chg-scr-blkopc:sr=iec:ni=c:nc=c:ncm=c:nsfi=dpc:nsr=wrld
chg-scr-blkopc:sr=iec:ni=c:nc=c:ncm=c:nsfi=stop:actname=none
chg-scr-blkopc:sr=bop1:npc=128:nsfi=fail:pcst=s:npcst=none
```

## Dependencies



**CAUTION:** Even though gateway screening is in the screen test mode, as defined by the parameters **gwsa=off** and **gws=on**, the gateway screening action in the stop action set specified by the **actname** parameter of the screen set *will* be performed at the end of the screening process.

A complete point code must be specified, using the **ni-nc-ncm**, **zone-area-id**, **msa-ssa-sp**, or **npc** combination unless a value of **c** for “continue” is specified.

A new point code entry must be specified by one, and only one of the four point code parameter combinations: **nni-nnc-ncm**, **nzone-narea-nid**, **nmsa-nssa-nsp**, or **nnpc**. If the new point code entry is a different point code type than the existing point code entry, all subfields of the new point code type must be specified.

ANSI point code value **000-000-000** and ITU-International point code value **0-000-0** are not allowed.

At least one optional parameter must be specified.

The blocked OPC specified by **ni-nc-ncm**; **zone-area-id**; **msa-ssa-sp**; or the **npc** parameter must already exist in the screening reference or within an existing range of OPCs.

The new blocked OPC or OPC range defined by **ni-nc-ncm**; **zone-area-id**, **msa-ssa-sp**, or the **npc** parameter must not already exist in the screening reference or within an existing range of OPCs.

If the **actname** parameter is specified, the **nsr** parameter cannot be specified.

The **actname** parameter value must already be defined in the Gateway Screening Stop Action table with the **chg-gws-actset** command. These values are shown in the *ACTNAME* field of the **rtrv-gws-actset** command output.

If the **area=\*** parameter is specified, then the **id=\*** parameter must be specified.

If the **msa=\*** parameter is specified, then the **ssa=\*** and **sp=\*** parameters must be specified.

If the **msa=c** parameter is specified, then the **ssa** and the **sp** parameters must have a value of **c** or must not be specified. If the **msa=c** parameter is specified, and the **ssa** and the **sp** parameters are not specified, then the **ssa** and **sp** parameters default to a value of **c**.

The **nsfi** and **nsr** parameters must point to an existing screen, or the **nsfi=stop** parameter must be specified, and the **nsr** parameter cannot be specified.

If the **nc** parameter is specified as a range, the **ncm** parameter must be specified as an asterisk or as the full range **000–255**

If the **nc** parameter is specified as a single value or a range, a single value must be specified for the **ni** parameter.

If the **nc=\*** parameter is specified, the **ncm** parameter must be specified as an asterisk or as the full range **000–255**.

If the **ncm** parameter is specified as a single value, or a range other than the full range of **000–255**, the **ni** and the **nc** parameters must be specified with a single value.

If the **ni** parameter is specified as an asterisk (**ni=\***) or as a range, the **nc** and **ncm** parameters must be specified as an asterisk or as the full range **000–255**.

If the **ni=c** parameter is specified, then the **nc** and the **ncm** parameters must have a value of **c** or must not be specified. If the **ni=c** parameter is specified, and the **nc** and the **ncm** parameters are not specified, then the **nc** and **ncm** parameters default to a value of **c**.

If the **nnc** parameter is specified as a range, the **nncm** parameter must be specified as an asterisk or as the full range **000–255**.

If the **nnc** parameter is specified as a single value or a range, a single value must be specified for the **nni** parameter.

If the **nnc=\*** parameter is specified, the **nnm** parameter must be specified as an asterisk or as the full range **000–255**.

If the **nncm** parameter is specified as a single value, or a range other than the full range of **000–255**, the **nni** and the **nnc** parameters must be specified with a single value.

If the **nni** parameter is specified as an asterisk (**nni=\*** ) or as a range, the **nnc** and **nncm** parameters must be specified as an asterisk or as the full range **000–255**.

If the **nsfi=fail** parameter is specified, then the **nni**, **nc**, **nncm**, **narea**, **nzone**, **nid**, **nmsa**, **nssa**, **nsp**, and **npc** parameters cannot have a value of **c**.

When changing a screening entry, and the **nsfi=fail** parameter is specified, the **nni**, **nnc**, **nncm**, **narea**, **nzone**, **nid**, **nmsa**, **nssa**, **nsp**, and **npc** parameters cannot have a value of **c**.

If the specified **ni-nc-ncm** or **zone-area-id** or **msa-ssa-sp** is equal to **c-c-c** or if the **npc=c** parameter is specified, the **nsfi=fail** parameter cannot be specified, and the **nni**, **nnc**, **nncm**, **nzone**, **narea**, **nid**, **nmsa**, **nssa**, **nsp**, and **npc** parameters cannot be specified. Point code **c-c-c** and **npc=c** cannot be changed to a numbered point code.

If the specified **ni-nc-ncm**, **zone-area-id**, or **msa-ssa-sp** is not equal to **c-c-c**, or the **npc=c** parameter is not specified, the **nsfi=fail** parameter must be specified, and the **nsr** parameter cannot be specified.

If the **ssa=\*** parameter is specified, then the **sp=\*** parameter must be specified.

The specified screening reference (**sr**) must already exist in the database.

The Spare Point Code Support feature must be enabled before the **pcst** and **npcst** parameters can be specified.

The **pcst** and **npcst** parameters cannot be specified with **c** for a blocked screen reference (**sr**).

The spare point code subtype prefix (**s-**) is not supported for ANSI point codes (parameters **ni**, **nc**, **ncm**) or for 24-bit ITU national point codes (parameters **msa**, **ssa**, **sp**). The **pcst** and **npcst** parameters cannot be specified for ANSI and ITU-N24 point codes.

If the **zone=\*** parameter is specified, then the **area=\*** and **id=\*** parameters must be specified.

If the **zone=c** parameter is specified, then the **area** and the **id** parameters must have a value of **c** or must not be specified. If the **zone=c** parameter is specified, and the **area** and the **id** parameters are not specified, then the **area** and **id** parameters default to a value of **c**.

If the **actname** parameter is specified, then the **nsfi=stop** parameter must be specified.

The value of the **nsfi** parameter must be valid for the BLKOPC entity type.

**nsr** can not be specified if a stop action is specified.

If the specified **ni-nc-ncm**, **zone-area-id**, or **msa-ssa-sp** equals **c-c-c**, then the **nsfi=fail** parameter cannot be specified.

If the specified **ni-nc-ncm**, **zone-area-id**, or **msa-ssa-sp** is not equal to **c-c-c**, or if the **npc=c** parameter is not specified, then the **nsfi=fail** parameter must be specified, and the **nsr** parameter cannot be specified.

The **nsfi** and **nsr** parameters cannot be specified when changing a screening entry that is other than (**c-c-c**).

The the next screening reference (**nsr**) must be specified when the next screening function identifier (**nsfi**) is not equal to **stop** or **fail**.

## Notes

When a blocked OPC screening reference is created, the first entry for a point code must be **c-c-c**, or **c** for the **npc** parameter. Subsequent entries must be specific point codes.

The character **c** is used in the blocked OPC screens to allow the screening process to continue for messages with point codes that do not match any point codes in the blocked OPC screens. When

screening for a blocked OPC and the point code being screened does not match any of the point codes in the blocked OPC screens, the message is not rejected and the screening process continues. There must be an entry in the blocked OPC screens to allow the screening process to continue.

This entry consists of a screening reference, point code, **nsfi**, and **nsr**. The point code is **npc=c** or subfields equal to **c-c-c**. When the character **c** is specified, the **nsfi** and **nsr** parameters must be specified.

If the character **c** is specified for the parameters **ni-nc-ncm** or **zone-area-id** or **msa-ssa-sp**, the character **c** is the only value that can be specified for all three parameters. No other values can be used. For example, a point code **c-c-255** is not allowed. The point code must be **c-c-c**. The asterisk (\*) value cannot be used with the character **c** (for example, a point code **c-c-\*** is not allowed).

When the point code does not match any entries in the blocked OPC screens, the screening process is directed to the screening reference with the point code **c-c-c** or **npc=c**. The **nsfi** and **nsr** in this entry are examined to determine the next step in the screening process.

If the current **ni-nc-ncm** or **zone-area-id** or **msa-ssa-sp** is equal to **c-c-c** or **npc=c**, only the **nsfi** and **nsr** can be changed. Otherwise, only the blocked OPC can be changed.

A range of values is specified by separating the values that define the range by two ampersands (&&); for example, **:ni=025&&100** specifies all network indicators for ANSI point codes from **25** to **100**.

An asterisk cannot not be specified for a parameter value in this command unless an asterisk was specified for the parameter value in the original **ent-scr-blkopc** command.

If the screen set reaches 100% capacity (indicated by the “100% full” message), the system will allow subsequent entries. An error will occur, however, when downloading the screen set to the card. Screen sets should not exceed 100% capacity. Remove screen set entries until the capacity is below 100%.

The spare point code subtype prefix **s-** is supported only for ITU international and ITU national point codes. The **pcst** and **npcst** parameters indicate whether the specified point code has no subtype prefix or has the spare point code prefix.

## Output

**chg-scr-**

**blkopc:sr=iec:ni=240:nc=010:ncm=010:nni=240:nnc=010:nncm=020**

```
rlghncxa03w 04-01-07 11:43:04 EST EAGLE 31.3.0
CHG-SCR-BLKOPC: SCREEN SET AFFECTED - IEC 25% FULL
CHG-SCR-BLKOPC: MASP A - COMPLTD
```

;

### Legend

**CHG-SCR-BLKOPC**—The command entered that caused this output. This is echoed to the printer as a reference.

**SCREEN SET AFFECTED**—Identifies the screen set that was affected by the command. The screen set name is provided.

**% FULL**—Indicates the relative size of the screen set.

## chg-scr-cdpa

### Change Allowed Called Party Address

Use this command to change the attributes associated with a specific screening reference in the allowed called party address category. Attributes that can be changed are the point code, subsystem number, next screening function identifier, and next screening reference.

**Keyword:** chg-scr-cdpa

**Related Commands:** dlt-scr-cdpa, ent-scr-cdpa, rtrv-scr-cdpa

**Command Class:** Database Administration

## Parameters

**:sr=** (mandatory)

Screening reference. This parameter specifies the point code's unique screening reference name.

**Range:** *ayyy*

1 alphabetic character followed by up to 3 alphanumeric characters

**:ssn=** (mandatory)

Subsystem number. An asterisk (\*) indicates the full range of values from **1-255**.

**Range:** **1-255 \***

**:actname=** (optional)

Action name. This parameter specifies the name of the gateway screening stop action set. Stop actions must be administered using the **actname** parameter in conjunction with the gateway screening stop action table (see **chg-gws-actset** and **rtrv-gws-actset**).

**Range:** *ayyyyy*, **none**

1 alphabetic character followed by up to 5 alphanumeric characters.

**none**—Remove an existing gateway screening stop action set from a gateway screening rule.

**:area=** (optional)

ITU international area. The area is specified in the point code. The format of the point code is *zone-area-id*. An asterisk (\*) indicates the full range of values from **000-255**.

**Range:** **000-255 \***

**:id=** (optional)

ITU international ID. This parameter specifies the ID in the point code represented by format *zone-area-id*. An asterisk (\*) indicates the full range of values from **0-7**.

**Range:** **0-7, \***

**:msa=** (optional)

24-bit ITU-national main signaling area (*msa*) value. This parameter specifies the main signaling area (*msa*) of the point code represented by *msa-ssa-sp*. An asterisk (\*) indicates the full range of values from **000-255**.

**Range:** **000-255 \***

**:narea=** (optional)

New ITU-international area value. An asterisk (\*) indicates the full range of values from **000-255**.

**Range:** **000-255 \***

**Default:** Current value

**:nc=** (optional)

Network cluster (*nc*) value. This parameter specifies one or more *nc* values for the network indicator (*ni*) and network cluster member (*ncm*) values specified in the **ni** and **ncm** parameters. It specifies the *nc* of the point code represented by *ni-nc-ncm*. A single value or a range of values can be specified. An asterisk (\*) indicates the full range of values from **000-255**.

**Range:** **000-255 \***

**:ncm=** (optional)

Network cluster member (*ncm*) value. This parameter specifies one or more *ncm* values for the network indicator (*ni*) and network cluster (*nc*) values identified in the **ni** and **nc** parameters. It

specifies the *ncm* of the point code represented by *ni-nc-ncm*. A single value or a range of values can be specified. An asterisk (\*) indicates the full range of values from **000–255**.

**Range:**     **0-255 \***

**:ni=** (optional)

Network indicator (*ni*) value. This parameter specifies one or more *ni* values for the network cluster (*nc*) and network cluster member (*ncm*) values identified in the **nc** and **ncm** parameters. It specifies the *ni* of the point code represented by *ni-nc-ncm*. A single value or a range of values can be specified. An asterisk (\*) indicates the full range of values from **000–255**.

**Range:**     **0-255 \***

**:nid=** (optional)

New ITU-international ID value. An asterisk (\*) indicates the full range of values from **0–7**.

**Range:**     **0-7 \***

**Default:**    Current value

**:nmsa=** (optional)

New 24-bit ITU-national main signaling area (*nmsa*) value. This parameter specifies the new main signaling area (*msa*) of the point code represented by *msa-ssa-sp*. An asterisk (\*) indicates the full range of values from **000-255**.

**Range:**     **000-255 \***

**:nnc=** (optional)

New network cluster (*nnc*). This parameter specifies one or more *nnc* values for the screening reference specified in the **sr** parameter. It specifies the new network cluster (*nc*) of the point code represented by *ni-nc-ncm*. A single value or a range of values can be specified. An asterisk (\*) indicates the full range of values from **000–255**.

**Range:**     **000-255 \***

**Default:**    Current value

**:nncm=** (optional)

New network cluster member (*nncm*). This parameter specifies one or more *ncm* values for the screening reference specified in the **sr** parameter. It specifies the new network cluster member (*ncm*) of the point code represented by *ni-nc-ncm*. A single value or a range of values can be specified. An asterisk (\*) indicates the full range of values from **0–255**.

**Range:**     **0-255 \***

**Default:**    Current value

**:nni=** (optional)

New network identifier (*nni*). This parameter specifies one or more *nni* values for the screening reference specified in the **sr** parameter. It specifies the new network indicator (*ni*) of the point code represented by *ni-nc-ncm*. A single value or a range of values can be specified. An asterisk (\*) indicates the full range of values from **000–255**.

**Range:**     **0-255 \***

**Default:**    Current value

**:nnpc=** (optional)

New ITU-national point code. An asterisk (\*) indicates the full range of values from **00000–16383**.

**NOTE: Gateway screening allows the ITU national point code to be displayed and entered in the database only as a single number. If you use multiple-part ITU national point codes, see "Converting ITU National Point Code Formats" in Appendix A for information on converting the point code format.**

**Range:**     **00000-16383 \***

**Default:**    Current value



**:npc=** (optional)

ITU national point code. An asterisk (\*) indicates the full range of values from **00000–16383**.

**Range:** **00000-16383 \***

**:npcst=** (optional)

New point code subtype. This parameter indicates whether the specified new ITU international or ITU national point code has no subtype prefix or has the spare point code prefix (s-).

**Range:** **none, s**

**Default:** **none**

**:nscmgfid=** (optional)

New SCMG format ID. A single value or a range of values can be specified. An asterisk (\*) indicates the full range of values from **1–255**.

**Range:** **1-255 \***

**Default:** Current value

**:nsfi=** (optional)

This parameter specifies the next screening category that is used in the gateway screening process, or it indicates that the gateway screening process should stop.

**Range:** **aftpc, stop**

**aftpc**—Allowed affected point code is the next screening category.

**stop**—The gateway screening process ends and the message proceeds through normal routing.

**Default:** Current value

**:nsp=** (optional)

New 24-bit ITU national signaling point (*nsp*). This parameter specifies the new signaling point (*sp*) of the point code represented by *msa-ssa-sp*. An asterisk (\*) indicates the full range of values from **000-255**.

**Range:** **000-255 \***

**:nsr=** (optional)

Next screening reference (*nsr*). The parameter indicates which screening reference in the specified screening category (**nsfi**) is to be used in the screening process. If **nsfi=stop**, the **nsr** parameter cannot be specified.

**Range:** *ayyy*

1 alphabetic character followed by up to 3 alphanumeric characters

**Default:** Current value

**:nssa=** (optional)

New 24-bit ITU national sub signaling area (*nssa*). This parameter specifies the new sub signaling area (*ssa*) of the point code represented by *msa-ssa-sp*. An asterisk (\*) indicates the full range of values from **000-255**.

**Range:** **000-255 \***

**:nssn=** (optional)

New subsystem number. An asterisk (\*) indicates the full range of values from **000–255**.

**Range:** **000-255 \***

**Default:** Current value

**:nzone=** (optional)

New ITU-international zone. This parameter specifies a new zone for the point code represented by *zone-area-id*. An asterisk (\*) indicates the full range of values from **0–7**.

**Range:** **0-7, \*, C**

**Default:** Current value

**:pcst=** (optional)

Point code subtype. This parameter indicates whether the specified ITU international or ITU national point code has no subtype prefix or has the spare point code prefix (s-).

**Range:** none, s

**Default:** none

**:scmgfid=** (optional)

The SCCP management (SCMG) format ID, which consists of a one-octet field and uniquely defines the function and format of each SCMG message. A single value or a range of values can be specified. An asterisk (\*) indicates the full range of values from **1-255**. The following SCCP message types are screened against the Allowed CDPA table and all others are passed: UDT, UDTS, XUdT, XUdTS.

**Range:** 1-255 \*

**:sp=** (optional)

24-bit ITU national signaling point (*sp*). This parameter specifies the signaling point (*sp*) in the point code represented by *msa-ssa-sp*. An asterisk (\*) indicates the full range of values from **000-255**.

**Range:** 000-255 \*

**:ssa=** (optional)

24-bit ITU national sub signaling area (*ssa*). This parameter specifies the sub signaling area (*ssa*) in the point code represented by the format *msa-ssa-sp*. An asterisk (\*) indicates the full range of values from **000-255**.

**Range:** 000-255 \*

**:zone=** (optional)

ITU international zone. This parameter specifies the zone in the point code represented by format *zone-area-id*. An asterisk (\*) indicates the full range of values from **0-7**.

**Range:** 0-7 \*

**Example**

```
chg-scr-
cdpa:sr=cdp1:ni=5:nc=5:ncm=5:ssn=1:scmgfid=4:nsfi=stop:nni=6:nncm
=3 :nssn=*

chg-scr-
cdpa:sr=cdp1:ni=c:nc=c:ncm=c:ssn=1:scmgfid=3:nsfi=stop:actname=co
PY

chg-scr-
cgpa:sr=cgpa:zone=1:area=2:id=3:ssn=1:sccpmt=9:ri=*:nsfi=stop:pcs
t=s :npcst=none
```

**Dependencies**

**CAUTION:** Even though gateway screening is in the screen test mode, as defined by the parameters *gwsa=off* and *gwsm=on*, the gateway screening action in the stop action set specified by the *actname* parameter of the screen set *will* be performed at the end of the screening process.

A complete point code must be specified, and must be one and only one of the four point code parameter combinations: **ni-nc-ncm**; **zone-area-id**; **msa-ssa-sp**; or **npc**, except in the special case of entering *c* for "continue."

ANSI point code value **000-000-000** and ITU-International point code value **0-000-0** are not allowed.

At least one optional parameter must be specified.

The CDPA point code, **scmgfid**, and **ssn** to be changed must already exist in the CDPA entity set.

The new CDPA point code, **scmgfid**, and **ssn** cannot already exist in the CDPA entity set.

If the **actname** parameter is specified, the **nsfi=stop** parameter must be specified.

If the **actname** parameter is specified, the **nsr** parameter cannot be specified.

The **actname** parameter value must already be defined in the Gateway Screening Stop Action table with the **chg-gws-actset** command. These values are shown in the *ACT NAME* field of the **rtrv-gws-actset** command output.

If the **nc** parameter is specified as a range, the **ncm** parameter must be specified as an asterisk or as the full range **000–255**.

If the **nc** parameter is specified as a single value or a range, a single value must be specified for the **ni** parameter.

If the **nc=\*** parameter is specified, the **ncm** parameter must be specified as an asterisk or as the full range **000–255**.

If the **ncm** parameter is specified as a single value, or a range other than the full range of **000–255**, the **ni** and the **nc** parameters must be specified with a single value.

If the **ni** parameter is specified as an asterisk (**ni=\***) or as a range, the **nc** and **ncm** parameters must be specified as an asterisk or as the full range **000–255**.

If the **nnc** parameter is specified as a range, the **nncm** parameter must be specified as an asterisk or as the full range **000–255**.

If the **nnc** parameter is specified as a single value or a range, a single value must be specified for the **nni** parameter.

If the **nnc=\*** parameter is specified, the **nncm** parameter must be specified as an asterisk or as the full range **000–255**.

If the **nncm** parameter is specified as a single value, or a range other than the full range of **000–255**, the **nni** and the **nnc** parameters must be specified with a single value.

If the **nni** parameter is specified as an asterisk (**nni=\***) or as a range, the **nnc** and **nncm** parameters must be specified as an asterisk or as the full range **000–255**.

If the **nsfi=aftpc** parameter is specified, the **ssn=1** parameter must be specified.

If the **nsfi=stop** parameter is specified, the **nsr** parameter cannot be specified.

If the **nsfi** parameter is specified with a value other than **stop**, the **nsr** parameter must be specified.

The next screening function identifier (**nsfi**) and the next screening reference (**nsr**) must point to an existing screen, or the **nsfi** must be equal to **stop** and the **nsr** must not be specified.

The specified screening reference (**sr**) must already exist in the database.

The Spare Point Code Support feature must be enabled before the **pcst** parameter can be specified.

The spare point code subtype prefix (**s-**) is not supported for ANSI point codes (parameters **ni**, **nc**, **ncm**) or for 24-bit ITU national point codes (parameters **msa**, **ssa**, **sp**). The **pcst** and **npcst** parameters cannot be specified for ANSI and ITU-N24 point codes.

If the **ssn** parameter is specified with a value other than **1**, the **scmgfid** parameter cannot be specified.

If the **ssn=1** parameter is specified, the **scmgfid** parameter must be specified.

The specified value for the **nsfi** parameter is not valid for **cdpa** screen.

## Notes

A range of values is specified by separating the values that define the range by two ampersands (**&&**); for example, **:ni=025&&100** specifies all network indicators for ANSI point codes from **25** to **100**.

If the screen set reaches 100% capacity (indicated by the 100% Full message), the system will allow subsequent entries. An error will occur, however, when downloading the screen set to a LIM. Screen sets should not exceed 100% capacity. Remove screen set entries until the capacity is below 100%.

An asterisk can be specified for a parameter value in the **chg-scr-cdpa** and **dlt-scr-cdpa** commands *only* if that parameter value was specified as an asterisk in the **ent-scr-cdpa** command to define the parameter value.

The Spare Point Code Support feature must be enabled before the **pcst** parameter can be specified.

The spare point code subtype prefix **s-** is supported only for ITU international and ITU national point codes. The **pcst** parameter indicates whether the specified point code has no subtype prefix or has the spare point code prefix.

## Output

```
chg-scr-
cdpa:sr=cdp1:ni=5:nc=5:ncm=5:ssn=1:scmgfid=4:nsfi=stop:nni=6:nncm
=3 :nssn=*
```

```
rlghncxa03w 04-01-14 15:35:30 EST EAGLE 31.3.0
CHG-SCR-CDPA: MASP A - COMPLTD
```

```
;
```

## chg-scr-cgpa

### Change Allowed Calling Party Address

Use this command to change the attributes associated with a specific screening reference in the allowed calling party address category. Attributes that can be changed are the point code, subsystem number, routing indicator, next screening function identifier, and next screening reference.

**Keyword:** **chg-scr-cgpa**

**Related Commands:** **dlt-scr-cgpa**, **ent-scr-cgpa**, **rtrv-scr-cgpa**

**Command Class:** Database Administration

## Parameters

**NOTE:** At least one of these parameters must be specified: **nsfi**.

**:ri=** (mandatory)

Routing indicator. This parameter specifies routing instructions to the receiving signaling point. In gateway screening, messages may be screened based on the value of the routing indicator.

**Range:** **dpc**, **gt**, \*

**dpc**—Allow a called party address with a routing indicator value of “DPC/SSN.”

**gt**—Screening stops and gateway screening is bypassed as a forced pass.

\*—Allow both routing indicator values.

**:sccpmt=** (mandatory)

SCCP message type. A single value or a range of values can be specified. An asterisk (\*) indicates the full range of values.

**Range:** **9**, **10**, **17**, **18**, \*

**9**, \* — UDT

**10**, \* — UDTS

**17**, \* — XUDT

**18**, \* — XUDTS

**:sr=** (mandatory)

Screening reference. This parameter specifies the point code’s unique screening reference name.

**Range:** *ayyy*

1 alphabetic character followed by up to 3 alphanumeric characters

**:ssn=** (mandatory)

Subsystem number. An asterisk (\*) indicates the full range of values from **1-255**.

**Range:** **1-255 \***

**:actname=** (optional)

Action name. This parameter specifies the name of the gateway screening stop action set. Stop actions must be administered using the **actname** parameter in conjunction with the gateway screening stop action table (see **chg-gws-actset** and **rtrv-gws-actset**).

**Range:** *ayyyyy*, **none**

1 alphabetic character followed by up to 5 alphanumeric characters.

**none**—remove an existing gateway screening stop action set from a gateway screening rule.

**:area=** (optional)

ITU international area. The area is specified in the point code. The format of the point code is *zone-area-id*. An asterisk (\*) indicates the full range of values from **000-255**.

**Range:** **000-255 \***

**:id=** (optional)

ITU international ID. This parameter specifies the ID in the point code represented by format *zone-area-id*. An asterisk (\*) indicates the full range of values from **0-7**.

**Range:** **0-7, \***

**:msa=** (optional)

24-bit ITU-national main signaling area (*msa*) value. It specifies the main signaling area (*msa*) of the point code represented by *msa-ssa-spt*. An asterisk (\*) indicates the full range of values from **000-255**.

**Range:** **000-255 \***

**:narea=** (optional)

New ITU-international area value. An asterisk (\*) indicates the full range of values from **000-255**.

**Range:** **000-255 \***

**Default:** Current value

**:nc=** (optional)

Network cluster (*nc*) value. This parameter specifies one or more *nc* values for the network indicator (*ni*) and network cluster member (*ncm*) values specified in the **ni** and **ncm** parameters. It specifies the *nc* of the point code represented by *ni-nc-ncm*. A single value or a range of values can be specified. An asterisk (\*) indicates the full range of values from **000-255**.

**Range:** **000-255 \***

**:ncm=** (optional)

Network cluster member (*ncm*) value. This parameter specifies one or more *ncm* values for the network indicator (*ni*) and network cluster (*nc*) values identified in the **ni** and **nc** parameters. It specifies the *ncm* of the point code represented by *ni-nc-ncm*. A single value or a range of values can be specified. An asterisk (\*) indicates the full range of values from **000-255**.

**Range:** **0-255 \***

**:ni=** (optional)

Network indicator (*ni*) value. This parameter specifies one or more *ni* values for the network cluster (*nc*) and network cluster member (*ncm*) values identified in the **nc** and **ncm** parameters. It specifies the *ni* of the point code represented by *ni-nc-ncm*. A single value or a range of values can be specified. An asterisk (\*) indicates the full range of values from **000-255**.

**Range:** **0-255 \***

**:nid=** (optional)

New ITU-international ID value. An asterisk (\*) indicates the full range of values from **0–7**.

**Range:** **0-7, \***

**Default:** Current value

**:nmsa=** (optional)

New 24-bit ITU-national main signaling area (*nmsa*) value. This parameter specifies the new main signaling area (*msa*) of the point code represented by *msa-ssa-spt*. An asterisk (\*) indicates the full range of values from **000–255**.

**Range:** **000-255 \***

**:nnc=** (optional)

New network cluster (*nnc*). This parameter specifies one or more *nnc* values for the screening reference specified in the **sr** parameter. It specifies the new network cluster (*nc*) of the point code represented by *ni-nc-ncm*. A single value or a range of values can be specified. An asterisk (\*) indicates the full range of values from **000–255**.

**Range:** **000-255 \***

**Default:** Current value

**:nncm=** (optional)

New network cluster member (*nncm*). This parameter specifies one or more *ncm* values for the screening reference specified in the **sr** parameter. It specifies the new network cluster member (*ncm*) of the point code represented by *ni-nc-ncm*. A single value or a range of values can be specified. An asterisk (\*) indicates the full range of values from **0–255**.

**Range:** **0-255 \***

**Default:** Current value

**:nni=** (optional)

New network identifier (*nni*). This parameter specifies one or more *nni* values for the screening reference specified in the **sr** parameter. It specifies the new network indicator (*ni*) of the point code represented by *ni-nc-ncm*. A single value or a range of values can be specified. An asterisk (\*) indicates the full range of values from **000–255**.

**Range:** **0-255 \***

**Default:** Current value

**:nnpc=** (optional)

New ITU-national point code. An asterisk (\*) indicates the full range of values from **00000–16383**.

**NOTE: Gateway screening allows the ITU national point code to be displayed and entered in the database only as a single number. If you use multiple-part ITU national point codes, see "Converting ITU National Point Code Formats" in Appendix A for information on converting the point code format.**

**Range:** **00000-16383 \***

**Default:** Current value

**:npc=** (optional)

ITU national point code. An asterisk (\*) indicates the full range of values from **00000–16383**.

**Range:** **00000-16383 \***

**:npcst=** (optional)

New point code subtype. This parameter indicates whether the specified new ITU international or ITU national point code has no subtype prefix or has the spare point code prefix (**s-**).

**Range:** **none, s**

**Default:** **none**

**:nri=** (optional)

New routing indicator that provides routing instructions to the receiving signaling point. In gateway screening, messages may be screened based on the value of the routing indicator. An asterisk (\*) indicates that both routing indicator values (**gt** and **dpc**) will be accepted in the gateway screening process.

**Range:** **dpc, gt, \***

**dpc**—Allow a called party address with a routing indicator value of “DPC/SSN.”

**gt**—Screening stops and gateway screening is bypassed as a forced pass.

**Default:** Current value

**:nscpmt=** (optional)

New SCCP message type. A single value or a range of values can be specified. An asterisk (\*) indicates the full range of values.

**Range:** **9, 10, 17, 18, \***

**Default:** Current value

**:nsfi=** (optional)

This parameter specifies the next screening category that is used in the gateway screening process, or it indicates that the gateway screening process should stop.

**Range:** **cdpa, stop, tt**

**cdpa**—Allowed called party address is the next screening category.

**stop**—The gateway screening process ends and the message proceeds through normal routing.

**tt**—Allowed translation type is the next screening category.

**Default:** Current value

**:nsp=** (optional)

New 24-bit ITU national signaling point (*nsp*). This parameter specifies the new signaling point *sp* of the point code represented by *msa-ssa-sp*. An asterisk (\*) indicates the full range of values from **000-255**.

**Range:** **000-255 \***

**:nsr=** (optional)

Next screening reference (*nsr*). This parameter specifies which screening reference in the specified screening category (**nsfi**) is to be used in the screening process. If **nsfi=stop**, the **nsr** parameter cannot be specified.

**Range:** *ayyy*

1 alphabetic character followed by up to 3 alphanumeric characters

**Default:** Current value

**:nssa=** (optional)

New 24-bit ITU national sub signaling area (*nssa*). This parameter specifies the new sub signaling area (*ssa*) of the point code represented by *msa-ssa-sp*. An asterisk (\*) indicates the full range of values from **000-255**.

**Range:** **000-255 \***

**:nssn=** (optional)

New subsystem number. An asterisk (\*) indicates the full range of values from **000-255**.

**Range:** **000-255 \***

**Default:** Current value

**:nzone=** (optional)

New ITU-international zone. This parameter specifies a new zone for the point code represented by *zone-area-id*. An asterisk (\*) indicates the full range of values from **0-7**.

**Range:** **0-7, \*, C**

**Default:** Current value

**:pcst=** (optional)

Point code subtype. This parameter specifies whether the specified ITU international or ITU national point code has no subtype prefix or has the spare point code prefix (s-).

**Range:** none, s

**Default:** none

**:sp=** (optional)

24-bit ITU national signaling point (*sp*). This parameter specifies the signaling point (*sp*) in the point code represented by *msa-ssa-sp*. An asterisk (\*) indicates the full range of values from **000-255**.

**Range:** 000-255 \*

**:ssa=** (optional)

24-bit ITU national sub signaling area (*ssa*). This parameter specifies the sub signaling area (*ssa*) in the point code represented by the format *msa-ssa-sp*. An asterisk (\*) indicates the full range of values from **000-255**.

**Range:** 000-255 \*

**:zone=** (optional)

ITU international zone. This parameter specifies the zone in the point code represented by format *zone-area-id*. An asterisk (\*) indicates the full range of values from **0-7**.

**Range:** 0-7, \*

### Example

```
chg-scr-cgpa:sr=iec:ni=240:nc=010:ncm=010:ssn=3:ri=dpc
```

```
chg-scr-
```

```
cgpa:sr=iec:ni=240:nc=010:ncm=010:ssn=3:ri=dpc:nsfi=stop:actname=copy
```

```
chg-scr-
```

```
cgpa:sr=cdpl:ni=5:nc=5:ncm=5:ssn=1:ri=dpc:sccpmt=009:nsfi=sdpa:nsr=cdpl
```

```
chg-scr-
```

```
cgpa:sr=cgpa:zone=1:area=2:id=3:ssn=1:sccpmt=9:ri=*:nsfi=stop:pcst=s :npcst=none
```

### Dependencies



**CAUTION:** Even though gateway screening is in the screen test mode, as defined by the parameters **gwsa=off** and **gws=on**, the gateway screening action in the stop action set specified by the **actname** parameter of the screen set *will* be performed at the end of the screening process.

A complete point code must be specified, and must be one, and only one of the four point code parameter combinations: **ni-nc-ncm**; **zone-area-id**; **msa-ssa-sp**; or **npc**.

ANSI point code value **000-000-000** and ITU-International point code value **0-000-0** are not allowed.

At least one optional parameter must be specified.

The CGPA point code or range of point codes, **ri**, **sccpmt**, and subsystem number or numbers to be changed must exist in the CGPA entity set.

The new CGPA point code and subsystem number cannot already exist in the CGPA entity set.

If the **actname** parameter is specified, the **nsfi=stop** parameter must be specified.

If the **actname** parameter is specified, the **nsr** parameter cannot be specified.



The value of the **actname** parameter must already be defined in the Gateway Screening Stop Action table with the **chg-gws-actset** command. These values are shown in the *ACTNAME* field of the **rtrv-gws-actset** command output.

The next screening function identifier (**nsfi**) and the next screening reference (**nsr**) must point to an existing screen, or the **nsfi** must be equal to **stop** and the **nsr** must not be specified.

If the **nc** parameter is specified as a range, the **ncm** parameter must be specified as an asterisk or as the full range **000–255**.

If the **nc** parameter is specified as a single value or a range, a single value must be specified for the **ni** parameter.

If the **nc** parameter is specified as an asterisk (**nc=\***), the **ncm** parameter must be specified as an asterisk or as the full range **000–255**.

If the **ncm** parameter is specified as a single value, or a range other than the full range of **000–255**, the **ni** and the **nc** parameters must be specified with a single value.

If the **ni** parameter is specified as an asterisk (**ni=\***) or as a range, the **nc** and **ncm** parameters must be specified as an asterisk or as the full range **000–255**.

If the **nnc** parameter is specified as a range, the **nncm** parameter must be specified as an asterisk or as the full range **000–255**.

If the **nnc** parameter is specified as a single value or a range, a single value must be specified for the **nni** parameter.

If the **nnc** parameter is specified as an asterisk (**nnc=\***), the **nncm** parameter must be specified as an asterisk or as the full range **000–255**.

If the **nncm** parameter is specified as a single value, or a range other than the full range of **000–255**, the **nni** and the **nnc** parameters must be specified with a single value.

If the **nni** parameter is specified as an asterisk (**nni=\***) or as a range, the **nnc** and **nncm** parameters must be specified as an asterisk or as the full range **000–255**.

The **nsfi=cdpa** parameter can be specified only when the **ri=\*** or the **ri=dpc** parameter is specified.

The **nsfi=tt** parameter can be specified only when the **ri=\*** or the **ri=gt** parameter is specified.

If the **nsfi=stop** parameter is specified, the **nsr** parameter cannot be specified.

If the **nsfi** parameter has a value other than **stop**, the **nsr** parameter must be specified.

The specified screening reference (**sr**) must already exist in the database.

The Spare Point Code Support feature must be enabled before the **pcst** parameter can be specified.

The spare point code subtype prefix (**s-**) is not supported for ANSI point codes (parameters **ni**, **nc**, **ncm**) or for 24-bit ITU national point codes (parameters **msa**, **ssa**, **sp**). The **pcst** and **npcst** parameters cannot be specified for ANSI and ITU-N24 point codes.

The **nsccpmt** and **sccpmt** parameter value must be specified in the range of {**9, 10, 17, 18, and \***}.

The specified value for the **nsfi** parameter is not valid for **cgpa** screen.

The new CGPA point code, **ri**, **sccpmt**, and subsystem number (**ssn**) to be added can not already exist in the CGPA entity set.

## Notes

A range of values is specified by separating the values that define the range by two ampersands (**&&**); for example, **:ni=025&&100** specifies all network indicators for ANSI point codes from **25** to **100**.

If the screen set reaches 100% capacity (indicated by the 100% Full message), the system will allow subsequent entries. An error will occur, however, when downloading the screen set to a LIM. Screen sets should not exceed 100% capacity. Remove screen set entries until the capacity is below 100%.

An asterisk can be specified for a parameter value in the **chg-scr-cgpa** and **dlt-scr-cgpa** commands *only* if that parameter value was specified as an asterisk in the **ent-scr-cgpa** command to define the parameter value.

The spare point code subtype prefix **s-** is supported only for ITU international and ITU national point codes. The **pcst** parameter indicates whether the specified point code has no subtype prefix or has the spare point code prefix.

## Output

```
chg-scr-cgpa:sr=iec:ni=240:nc=010:ncm=010:ssn=3:ri=dpc
rlghncxa03w 04-01-07 11:43:04 EST EAGLE 31.3.0
CHG-SCR-CGPA: SCREEN SET AFFECTED - IEC 25% FULL
CHG-SCR-CGPA: MASP A - COMPLTD
;
```

### Legend

**CHG-SCR-CGPA**—The command entered that caused this output. This is echoed to the printer as a reference.

**SCREEN SET AFFECTED**—Identifies the screen set that was affected by the command. The screen set name is shown.

**% FULL**—Indicates the relative size of the screen set.

## chg-scr-destfld

### Change an Allowed DESTFLD

Use this command to change the attributes of a specific screening reference in the allowed affected destination field (DESTFLD) category. Attributes that can be changed are the allowed affected destination point codes.

**Keyword:** **chg-scr-destfld**

**Related Commands:** **dlt-scr-destfld**, **ent-scr-destfld**, **rtrv-scr-destfld**

**Command Class:** Database Administration

### Parameters

**:sr=** (mandatory)

Screening reference. This parameter specifies the point code's unique screening reference name.

**Range:** *ayyy*

1 alphabetic character followed by up to 3 alphanumeric characters

**:actname=** (optional)

Action name. This parameter specifies the name of the gateway screening stop action set. Stop actions must be administered using the **actname** parameter in conjunction with the gateway screening stop action table (see **chg-gws-actset** and **rtrv-gws-actset**).

**Range:** *ayyyyy*, **none**

1 alphabetic character followed by up to 5 alphanumeric characters.

**none**—remove an existing gateway screening stop action set from a gateway screening rule.

**:area=** (optional)

ITU international area. The area is specified in the point code. The format of the point code is *zone-area-id*. An asterisk (\*) indicates the full range of values from **000–255**.

**Range:** 000-255 \*

**:id=** (optional)

ITU international ID. This parameter specifies the ID in the point code represented by format *zone-area-id*. An asterisk (\*) indicates the full range of values from 0-7.

**Range:** 0-7, \*

**:msa=** (optional)

24-bit ITU-national main signaling area (*msa*) value. This parameter specifies the main signaling area (*msa*) of the point code represented by *msa-ssa-sp*. An asterisk (\*) indicates the full range of values from 000-255.

**Range:** 000-255 \*

**:narea=** (optional)

New ITU-international area value. An asterisk (\*) indicates the full range of values from 000-255.

**Range:** 000-255 \*

**Default:** Current value

**:nc=** (optional)

Network cluster (*nc*) value. This parameter specifies one or more *nc* values for the network indicator (*ni*) and network cluster member (*ncm*) values specified in the **ni** and **ncm** parameters. It specifies the *nc* of the point code represented by *ni-nc-ncm*. A single value or a range of values can be specified. An asterisk (\*) indicates the full range of values from 000-255.

**Range:** 000-255 \*

**:ncm=** (optional)

Network cluster member (*ncm*) value. This parameter specifies one or more *ncm* values for the network indicator (*ni*) and network cluster (*nc*) values identified in the **ni** and **nc** parameters. It specifies the *ncm* of the point code represented by *ni-nc-ncm*. A single value or a range of values can be specified. An asterisk (\*) indicates the full range of values from 000-255.

**Range:** 0-255 \*

**:ni=** (optional)

Network indicator (*ni*) value. This parameter specifies one or more *ni* values for the network cluster (*nc*) and network cluster member (*ncm*) values identified in the **nc** and **ncm** parameters. It specifies the *ni* of the point code represented by *ni-nc-ncm*. A single value or a range of values can be specified. An asterisk (\*) indicates the full range of values from 000-255.

**Range:** 0-255 \*

**:nid=** (optional)

New ITU-international ID value. An asterisk (\*) indicates the full range of values from 0-7.

**Range:** 0-7, \*

**Default:** Current value

**:nmsa=** (optional)

New 24-bit ITU-national main signaling area (*nmsa*) value. This parameter specifies the new main signaling area (*msa*) of the point code represented by *msa-ssa-sp*. An asterisk (\*) indicates the full range of values from 000-255.

**Range:** 000-255 \*

**:nnc=** (optional)

New network cluster (*nnc*). This parameter specifies one or more *nnc* values for the screening reference specified in the **sr** parameter. It specifies the new network cluster (*nc*) of the point code represented by *ni-nc-ncm*. A single value or a range of values can be specified. An asterisk (\*) indicates the full range of values from 000-255.

**Range:** 000-255 \*

**Default:** Current value

**:nncm=** (optional)

New network cluster member (*nncm*). This parameter specifies one or more *nncm* values for the screening reference specified in the **sr** parameter. It specifies the new network cluster member (*nncm*) of the point code represented by *ni-nc-nncm*. A single value or a range of values can be specified. An asterisk (\*) indicates the full range of values from **0-255**.

**Range:** 0-255 \*

**Default:** Current value

**:nni=** (optional)

New network identifier (*nni*). This parameter specifies one or more *nni* values for the screening reference specified in the **sr** parameter. It specifies the new network indicator (*ni*) of the point code represented by *ni-nc-nncm*. A single value or a range of values can be specified. An asterisk (\*) indicates the full range of values from **000-255**.

**Range:** 0-255 \*

**Default:** Current value

**:nnp=** (optional)

New ITU-national point code. An asterisk (\*) indicates the full range of values from **00000-16383**.

**NOTE: Gateway screening allows the ITU national point code to be displayed and entered in the database only as a single number. If you use multiple-part ITU national point codes, see "Converting ITU National Point Code Formats" in Appendix A for information on converting the point code format.**

**Range:** 00000-16383 \*

**Default:** Current value

**:npc=** (optional)

ITU national point code. An asterisk (\*) indicates the full range of values from **00000-16383**.

**Range:** 00000-16383 \*

**:npcst=** (optional)

New point code subtype. This parameter indicates whether the specified new ITU international or ITU national point code has no subtype prefix or has the spare point code prefix (**s-**).

**Range:** none, s

**Default:** none

**:nsfi=** (optional)

This parameter specifies the next screening category that is used in the gateway screening process. If specified, the parameter value must be **stop**.

**Range:** stop

**stop**—The gateway screening process ends and the message proceeds through normal routing.

**Default:** Current value

**:nsp=** (optional)

New 24-bit ITU national signaling point (*nsp*). This parameter specifies the new signaling point (*sp*) of the point code represented by *msa-ssa-sp*. An asterisk (\*) indicates the full range of values from **000-255**.

**Range:** 000-255 \*

**:nssa=** (optional)

New 24-bit ITU national sub signaling area (*nssa*). This parameter specifies the new sub signaling area (*ssa*) of the point code represented by *msa-ssa-sp*. An asterisk (\*) indicates the full range of values from **000-255**.

**Range:** 000-255 \*

**:nzone=** (optional)

New ITU-international zone. This parameter specifies a new zone for the point code represented by *zone-area-id*. An asterisk (\*) indicates the full range of values from **0-7**.

**Range:** **0-7, \*, C**

**Default:** Current value

**:pcst=** (optional)

Point code subtype. This parameter specifies whether the specified ITU international or ITU national point code has no subtype prefix or has the spare point code prefix (**s-**).

**Range:** **none, s**

**Default:** **none**

**:sp=** (optional)

24-bit ITU national signaling point (*sp*). This parameter specifies the signaling point (*sp*) in the point code represented by *msa-ssa-sp*. An asterisk (\*) indicates the full range of values from **000-255**.

**Range:** **000-255 \***

**:ssa=** (optional)

24-bit ITU national sub signaling area (*ssa*). This parameter specifies the sub signaling area (*ssa*) in the point code represented by the format *msa-ssa-sp*. An asterisk (\*) indicates the full range of values from **000-255**.

**Range:** **000-255 \***

**:zone=** (optional)

ITU international zone. This parameter specifies the zone in the point code represented by format *zone-area-id*. An asterisk (\*) indicates the full range of values from **0-7**.

**Range:** **0-7, \***

**Example**

```
chg-scr-destfld:sr=iec:ni=240:nc=010:ncm=019&&020:nncm=021
```

```
chg-scr-
```

```
destfld:sr=iec:ni=240:nc=010:ncm=019&&020:nsfi=stop:actname=none
```

```
chg-scr-
```

```
destfld:sr=dst1:zone=1:area=2:id=3:nsfi=stop:pcst=s:npcst=none
```

**Dependencies**

**CAUTION:** Even though gateway screening is in the screen test mode, as defined by the parameters **gwsa=off** and **andgws=on**, the gateway screening action in the stop action set specified by the **actname** parameter of the screen set *will* be performed at the end of the screening process.

A complete point code must be specified, using the **ni-nc-ncm**, **zone-area-id**, **msa-ssa-sp**, or **npc** combination unless a value of **c** for “continue” is specified.

A new point code entry must be specified by one, and only one of the four point code parameter combinations: **nni-nnc-ncm**, **nzone-narea-nid**, **nmsa-nssa-nsp**, or **nnpc**. If the new point code entry is a different point code type than the existing point code entry, all subfields of the new point code type must be specified.

ANSI point code value **000-000-000** and ITU-International point code value **0-000-0** are not allowed.

At least one optional parameter must be specified.

The new DESTFLD defined by **ni-nc-ncm**, **zone-area-id**, **msa-ssa-sp**, or the **npc** parameter must not already exist in the screening reference.

If the **actname** parameter is specified, the **nsfi=stop** parameter must be specified.

If the **actname** parameter is specified, the **nsr** parameter cannot be specified.

The value of the **actname** parameter must already be defined in the Gateway Screening Stop Action table with the **chg-gws-actset** command. These values are shown in the *ACTNAME* field of the **rtrv-gws-actset** command output.

If the **zone=\*** parameter is specified, then the **area=\*** and the **id=\*** parameters must be specified.

If the **area=\*** parameter is specified, then the **id=\*** parameter must be specified.

If the **msa=\*** parameter is specified, then the **ssa=\*** and the **sp=\*** parameters must be specified.

If the **ssa=\*** parameter is specified, then the **sp=\*** parameter must be specified.

If the **nsfi=stop** parameter is specified, then the **nsr** parameter cannot be specified.

If the **nc** parameter is specified as a range, the **ncm** parameter must be specified as an asterisk or as the full range **000–255**.

If the **nc** parameter is specified as a single value or a range, a single value must be specified for the **ni** parameter.

If the **nc=\*** parameter is specified, the **ncm** parameter must be specified as an asterisk or as the full range **000–255**.

If the **ncm** parameter is specified as a single value, or a range other than the full range of **000–255**, the **ni** and the **nc** parameters must be specified with a single value.

If the **ni** parameter is specified as an asterisk (**ni=\*** ) or as a range, the **nc** and **ncm** parameters must be specified as an asterisk or as the full range **000–255**.

If the **nnc** parameter is specified as a range, the **nncm** parameter must be specified as an asterisk or as the full range **000–255**.

If the **nnc** parameter is specified as a single value or a range, a single value must be specified for the **nni** parameter.

If the **nnc** parameter is specified as an asterisk (**nnc=\*** ), the **nncm** parameter must be specified as an asterisk or as the full range **000–255**.

If the **nncm** parameter is specified as a single value, or a range other than the full range of **000–255**, the **nni** and the **nnc** parameters must be specified with a single value.

If the **nni** parameter is specified as an asterisk (**nni=\*** ) or as a range, the **nnc** and **nncm** parameters must be specified as an asterisk or as the full range **000–255**.

The **nsfi=stop** parameter must be specified in the command

The entry specified by **ni-nc-ncm**, **zone-area-id**, **msa-ssa-sp**, or the **npc** parameter must already exist in the screening reference.

The specified screening reference (**sr**) must already exist in the database.

The Spare Point Code Support feature must be enabled before the **pcst** parameter can be specified.

The spare point code subtype prefix (**s-**) is not supported for ANSI point codes (parameters **ni**, **nc**, **ncm**) or for 24-bit ITU national point codes (parameters **msa**, **ssa**, **sp**). The **pcst** and **npcst** parameters cannot be specified for ANSI and ITU-N24 point codes.

If the **nsfi=fail** parameter is specified, then the **nni**, **nc**, **nncm**, **narea**, **nzone**, **nid**, **nmsa**, **nssa**, **nsp**, and **npc** parameters cannot have a value of **c**.

## Notes

A range of values is specified by separating the values that define the range by two ampersands (**&&**); for example, **:ni=025&&100** specifies all network indicators for ANSI point codes from **25** to **100**.

An asterisk can be specified for a parameter value in the **chg-scr-destfld** and **dlt-scr-destfld** commands *only* if that parameter value was specified as an asterisk in the **ent-scr-destfld** command to define the parameter value.

The spare point code subtype prefix **s-** is supported only for ITU international and ITU national point codes. The **pcst** and **npcst** parameters indicate whether the specified point code has no subtype prefix or has the spare point code prefix.

## Output

```
chg-scr-destfld:sr=iec:ni=240:nc=010:ncm=019&&020:nncm=021
```

```
rlghncxa03w 04-01-13 11:49:47 EST EAGLE 31.3.0
CHG-SCR-DESTFLD: SCREEN SET AFFECTED - SS01 25% FULL
CHG-SCR-DESTFLD: MASP A - COMPLTD
```

```
;
```

## chg-scr-dpc

## Change Allowed DPC

Use this command to change the attributes of a specific screening reference in the allowed DPC category. Attributes that may be changed are the point code, next screening function identifier, and the next screening reference.

**Keyword:** **chg-scr-dpc**

**Related Commands:** **dlt-scr-dpc**, **ent-scr-dpc**, **rtrv-scr-dpc**

**Command Class:** Database Administration

## Parameters

**NOTE: At least one of these parameters must be specified: nsfi.**

**:sr=** (mandatory)

Screening reference. This parameter specifies the point code's unique screening reference name.

**Range:** *ayyy*

1 alphabetic character followed by up to 3 alphanumeric characters

**:actname=** (optional)

Action name. This parameter specifies the name of the gateway screening stop action set. Stop actions must be administered using the **actname** parameter in conjunction with the gateway screening stop action table (see **chg-gws-actset** and **rtrv-gws-actset**).

**Range:** *ayyyyy*, **none**

1 alphabetic character followed by up to 5 alphanumeric characters.

**none**—remove an existing gateway screening stop action set from a gateway screening rule.

**:area=** (optional)

ITU international area. The area is specified in the point code. The format of the point code is *zone-area-id*. An asterisk (\*) indicates the full range of values from **000–255**.

**Range:** **000-255 \***

**:id=** (optional)

ITU international ID. The parameter specifies the ID in the point code represented by format *zone-area-id*. An asterisk (\*) indicates the full range of values from **0–7**.

**Range:** **0-7, \***

- :msa=** (optional)  
24-bit ITU-national main signaling area (*msa*) value. This parameter specifies the main signaling area (*msa*) of the point code represented by *msa-ssa-spt*. An asterisk (\*) indicates the full range of values from **000-255**.  
**Range:**     **000-255** \*
- :narea=** (optional)  
New ITU-international area value. An asterisk (\*) indicates the full range of values from **000-255**.  
**Range:**     **000-255** \*  
**Default:**    Current value
- :nc=** (optional)  
Network cluster (*nc*) value. This parameter specifies one or more *nc* values for the network indicator (*ni*) and network cluster member (*ncm*) values specified in the **ni** and **ncm** parameters. It specifies the *nc* of the point code represented by *ni-nc-ncm*. A single value or a range of values can be specified. An asterisk (\*) indicates the full range of values from **000-255**.  
**Range:**     **000-255** \*
- :ncm=** (optional)  
Network cluster member (*ncm*) value. This parameter specifies one or more *ncm* values for the network indicator (*ni*) and network cluster (*nc*) values identified in the **ni** and **nc** parameters. It specifies the *ncm* of the point code represented by *ni-nc-ncm*. A single value or a range of values can be specified. An asterisk (\*) indicates the full range of values from **000-255**.  
**Range:**     **0-255** \*
- :ni=** (optional)  
Network indicator (*ni*) value. This parameter specifies one or more *ni* values for the network cluster (*nc*) and network cluster member (*ncm*) values identified in the **nc** and **ncm** parameters. It specifies the *ni* of the point code represented by *ni-nc-ncm*. A single value or a range of values can be specified. An asterisk (\*) indicates the full range of values from **000-255**.  
**Range:**     **0-255** \*
- :nid=** (optional)  
New ITU-international ID value. An asterisk (\*) indicates the full range of values from **0-7**.  
**Range:**     **0-7**, \*  
**Default:**    Current value
- :nmsa=** (optional)  
New 24-bit ITU-national main signaling area (*nmsa*) value. This parameter specifies the new main signaling area (*msa*) of the point code represented by *msa-ssa-sp*. An asterisk (\*) indicates the full range of values from **000-255**.  
**Range:**     **000-255** \*
- :nnc=** (optional)  
New network cluster (*nnc*). This parameter specifies one or more *nnc* values for the screening reference specified in the **sr** parameter. It specifies the new network cluster (*nc*) of the point code represented by *ni-nc-ncm*. A single value or a range of values can be specified. An asterisk (\*) indicates the full range of values from **000-255**.  
**Range:**     **000-255** \*  
**Default:**    Current value
- :nncm=** (optional)  
New network cluster member (*nncm*). This parameter specifies one or more *ncm* values for the screening reference specified in the **sr** parameter. It specifies the new network cluster member (*ncm*) of the point code represented by *ni-nc-ncm*. A single value or a range of values can be specified. An asterisk (\*) indicates the full range of values from **0-255**.



**Range:** 0-255 \*  
**Default:** Current value

**:nmi=** (optional)

New network identifier (*nmi*). This parameter specifies one or more *nmi* values for the screening reference specified in the **sr** parameter. It specifies the new network indicator (*ni*) of the point code represented by *ni-nc-ncm*. A single value or a range of values can be specified. An asterisk (\*) indicates the full range of values from **000–255**.

**Range:** 0-255 \*  
**Default:** Current value

**:nnp=** (optional)

New ITU-national point code. An asterisk (\*) indicates the full range of values from **00000–16383**.

**NOTE: Gateway screening allows the ITU national point code to be displayed and entered in the database only as a single number. If you use multiple-part ITU national point codes, see "Converting ITU National Point Code Formats" in Appendix A for information on converting the point code format.**

**Range:** 00000-16383 \*  
**Default:** Current value

**:npc=** (optional)

ITU national point code. An asterisk (\*) indicates the full range of values from **00000–16383**.

**Range:** 00000-16383 \*

**:npct=** (optional)

New point code subtype. This parameter indicates whether the specified new ITU international or ITU national point code has no subtype prefix or has the spare point code prefix (s-).

**Range:** none, s  
**Default:** none

**:nsfi=** (optional)

This parameter specifies the next screening category that is used in the gateway screening process, or it indicates that the gateway screening process should stop.

**Range:** **blkdpc, cgpa, destfld, isup, stop**  
**blkdpc**—Blocked DPC is the next screening category.  
**cgpa**—Allowed CGPA is the next screening category.  
**destfld**—Allowed destination field (DESTFLD) is the next screening category.  
**isup**—ISUP message type (ISUP) is the next screening category.  
**stop**—The gateway screening process ends and the message proceeds through normal routing.

**Default:** Current value

**:nsp=** (optional)

The new 24-bit ITU national signaling point (*nsp*). It specifies the new signaling point (*sp*) of the point code represented by *msa-ssa-sp*. An asterisk (\*) indicates the full range of values from **000-255**.

**Range:** 000-255 \*

**:nsr=** (optional)

Next screening reference (*nsr*). The parameter indicates which screening reference in the specified screening category (**nsfi**) is to be used in the screening process. If **nsfi=stop**, the **nsr** parameter cannot be specified.

**Range:** *ayyy*  
 1 alphabetic character followed by up to 3 alphanumeric characters  
**Default:** Current value

**:nssa=** (optional)

New 24-bit ITU national sub signaling area (*nssa*). This parameter specifies the new sub signaling area (*ssa*) of the point code represented by *msa-ssa-sp*. An asterisk (\*) indicates the full range of values from **000-255**.

**Range:** **000-255 \***

**:nzone=** (optional)

New ITU-international zone. This parameter specifies a new zone for the point code represented by *zone-area-id*. An asterisk (\*) indicates the full range of values from **0-7**.

**Range:** **0-7, \*, C**

**Default:** Current value

**:pcst=** (optional)

Point code subtype. This parameter indicates whether the specified ITU international or ITU national point code has no subtype prefix or has the spare point code prefix (s-).

**Range:** **none, s**

**Default:** **none**

**:sp=** (optional)

24-bit ITU national signaling point (*sp*). This parameter specifies the signaling point (*sp*) in the point code represented by *msa-ssa-sp*. An asterisk (\*) indicates the full range of values from **000-255**.

**Range:** **000-255 \***

**:ssa=** (optional)

24-bit ITU national sub signaling area (*ssa*). This parameter specifies the sub signaling area (*ssa*) in the point code represented by the format *msa-ssa-sp*. An asterisk (\*) indicates the full range of values from **000-255**.

**Range:** **000-255 \***

**:zone=** (optional)

The ITU international zone. The parameter specifies the zone in the point code represented by format *zone-area-id*. An asterisk (\*) indicates the full range of values from **0-7**.

**Range:** **0-7, \***

**Example**

```
chg-scr-dpc:sr=iec:ni=240:nc=010:ncm=010:nni=240:nnc=003:nncm=030
chg-scr-
dpc:sr=iec:ni=240:nc=010:ncm=010:nni=240:nnc=003:nncm=030:nsfi=st
op:actname=none
chg-scr-dpc:sr=dpc1:npc=128:nsfi=fail:pcst=s:npcst=none
```

**Dependencies**

**CAUTION:** Even though gateway screening is in the screen test mode, as defined by the parameters **gwsa=off** and **andgws=on**, the gateway screening action in the stop action set specified by the **actname** parameter of the screen set *will* be performed at the end of the screening process.

A complete point code must be specified, using the **ni-nc-ncm**, **zone-area-id**, **msa-ssa-sp**, or **npc** combination unless a value of **c** for “continue” is specified.

A new point code entry must be specified by one, and only one of the four point code parameter combinations: **nmi-nnc-nncm**, **nzone-narea-nid**, **nmsa-nssa-nsp**, or **nnpc**. If the new point code entry is a different point code type than the existing point code entry, all subfields of the new point code type must be specified.

ANSI point code value **000-000-000** and ITU-International point code value **0-000-0** are not allowed.

At least one optional parameter must be specified.

The DPC specified by **ni-nc-ncm**, **zone-area-id**, **msa-ssa-sp**, or the **npc** parameter must already exist in the screening reference or within an existing range of DPCs.

The new DPC or DPC range defined by **ni-nc-ncm**, **zone-area-id**, **msa-ssa-sp**, or the **npc** parameter must not already exist in the screening reference or within an existing range of DPCs.

If the **actname** parameter is specified, then the **nsfi=stop** parameter must be specified.

If the **actname** parameter is specified, the **nsr** parameter cannot be specified.

The **actname** parameter value must already be defined in the Gateway Screening Stop Action table with the **chg-gws-actset** command. These values are shown in the *ACT NAME* field of the **rtrv-gws-actset** command output.

If the **zone=\*** parameter is specified, then the **area=\*** and the **id=\*** parameters must be specified.

If the **area=\*** parameter is specified, then the **id=\*** parameter must be specified.

If the **msa=\*** parameter is specified, then the **ssa=\*** and the **sp=\*** parameters must be specified.

If the **ssa=\*** parameter is specified, then the **sp=\*** parameter must be specified.

The **nsfi** and **nsr** parameters must point to an existing screen, or the **nsfi=stop** parameter must be specified, and the **nsr** parameter cannot be specified.

If the **nc** parameter is specified as a range, the **ncm** parameter must be specified as an asterisk or as the full range **000-255**

If the **nc** parameter is specified as a single value or a range, a single value must be specified for the **ni** parameter.

If the **nc=\*** parameter is specified, the **ncm** parameter must be specified as an asterisk or as the full range **000-255**.

If the **ncm** parameter is specified as a single value, or a range other than the full range of **000-255**, the **ni** and the **nc** parameters must be specified with a single value.

If the **ni** parameter is specified as an asterisk (**ni=\***) or as a range, the **nc** and **ncm** parameters must be specified as an asterisk or as the full range **000-255**.

If the **nnc** parameter is specified as a range, the **nncm** parameter must be specified as an asterisk or as the full range **000-255**

If the **nnc** parameter is specified as a single value or a range, a single value must be specified for the **nni** parameter.

If the **nnc=\*** parameter is specified, the **nncm** parameter must be specified as an asterisk or as the full range **000-255**.

If the **nncm** parameter is specified as a single value, or a range other than the full range of **000-255**, the **nni** and the **nnc** parameters must be specified with a single value.

If the **nni** parameter is specified as an asterisk (**nni=\***) or as a range, the **nnc** and **nncm** parameters must be specified as an asterisk or as the full range **000-255**.

If the **nsfi=stop** parameter is not specified, then the **nsr** parameter must be specified.

The value of the **sr** parameter must already exist in the BLKDPC entity set.

The Spare Point Code Support feature must be enabled before the **pcst** parameter can be specified.

The spare point code subtype prefix (**s-**) is not supported for ANSI point codes (parameters **ni**, **nc**, **ncm**) or for 24-bit ITU national point codes (parameters **msa**, **ssa**, **sp**). The **pcst** and **npcst** parameters cannot be specified for ANSI and ITU-N24 point codes.

If the **nsfi=fail** parameter is specified, then the **nni**, **nc**, **nncm**, **narea**, **nzone**, **nid**, **nmsa**, **nssa**, **nsp**, and **npc** parameters cannot have a value of **c**.

**Notes**

A range of values is specified by separating the values that define the range by two ampersands (&&); for example, **:ni=025&&100** specifies all network indicators for ANSI point codes from **25** to **100**.

An asterisk cannot not be specified for a parameter value in this command unless an asterisk was specified for the parameter value in the original **ent-scr-dpc** command.

If the screen set reaches 100% capacity (indicated by the “100% full” message), the system will allow subsequent entries. An error will occur, however, when downloading the screen set to the card. Screen sets should not exceed 100% capacity. Remove screen set entries until the capacity is below 100%.

The spare point code subtype prefix **s-** is supported only for ITU international and ITU national point codes. The **pcst** and **npcst** parameters indicate whether the specified point code has no subtype prefix or has the spare point code prefix.

**Output**

```
chg-scr-dpc:sr=iec:ni=240:nc=010:ncm=010:nni=240:nnc=003:nncm=030
rlghncxa03w 04-01-07 11:43:04 EST EAGLE 31.3.0
CHG-SCR-DPC: SCREEN SET AFFECTED - IEC 25% FULL
CHG-SCR-DPC: MASP A - COMPLTD
;
```

**Legend**

**CHG-SCR-DPC**—The command entered that caused this output. This is echoed to the printer as a reference.

**SCREEN SET AFFECTED**—Identifies the screen set that was affected by the command. The screen set name is provided.

**% FULL**—Indicates the relative size of the screen set.

**chg-scr-isup****Change Allowed ISUP Screening Reference**

Use this command to change the attributes associated with a specific allowed ISUP screening reference in the Allowed ISUP entity set.

**Keyword:** **chg-scr-isup**

**Related Commands:** **dlt-scr-isup**, **ent-scr-isup**, **rtrv-scr-isup**

**Command Class:** Database Administration

**Parameters**

**:isupmt/tupmt=** (mandatory)

ISUP message type or TUP message type. A single value or a range of values can be specified. An asterisk (\*) indicates the full range of values from **000–255**. The **tupmt** parameter is not valid for SEAS.

**Range:** **000-255 \***

**:sr=** (mandatory)

Screening reference. This parameter specifies the point code's unique screening reference name.

**Range:** *ayyy*

1 alphabetic character followed by up to 3 alphanumeric characters

**:actname=** (optional)

Action name. This parameter specifies the stop action set name.

**Range:** *ayyyyy*  
1 alphabetic character followed by up to 5 alphanumeric characters.

**Default:** Current value

**:nisupmt/ntupmt=** (optional)

New ISUP message type or new TUP message type. A single value or a range of values can be specified. An asterisk (\*) indicates the full range of values from **000–255**. The **ntupmt** parameter is not valid for SEAS.

**Range:** **000-255 \***

**:nsfi=** (optional)

This parameter specifies the next screening category that is used in the gateway screening process. If specified, the parameter value must be **stop**.

**Range:** **stop**  
**stop**—The gateway screening process ends and the message proceeds through normal routing.

**Default:** Current value

**:nsr=** (optional)

Next screening reference (*nsr*). The parameter specifies which screening reference in the specified screening category (**nsfi**) is to be used in the screening process. If the **nsfi=stop** parameter is specified, the **nsr** parameter cannot be specified.

**Range:** *ayyy*  
1 alphabetic character followed by up to 3 alphanumeric characters

**Default:** Current value

### Example

```
chg-scr-isup:sr=iec:isupmt=1:nisupmt=1&&2
```

```
chg-scr-isup:tupmt=20:ntupmt=1:sr=tu01
```

### Dependencies

At least one optional parameter must be specified.

If the **actname** parameter is specified, the **nsfi=stop** parameter must be specified.

The value of the **actname** parameter must already be defined in the Gateway Screening Stop Action table with the **chg-gws-actset** command. These values are shown in the *ACTNAME* field of the **rtrv-gws-actset** command output.

The specified **isupmt** or **tupmt** parameter value must already exist in the specified **sr**.

The specified **nisupmt** or **ntupmt** parameter value must not already exist in the specified **sr**.

If the **nsfi** parameter is specified, the parameter value must be **stop**.

If the **nsfi=stop** parameter is specified, the **nsr** parameter cannot be specified.

### Notes

An asterisk can be specified for a parameter value in the **chg-scr-isup** and **dlt-scr-isup** commands *only* if that parameter value was specified as an asterisk in the **ent-scr-isup** command to define the parameter value.

A range of values can be specified for the **isupmt** parameter or **tupmt** parameter, by separating the values that define the range by two ampersands (&&); for example, **:isupmt=025&&100** specifies all ISUP message types from **25** to **100**. The value to the left of the && must be less than the value to the right of the && in the range.

TUP does not apply to SEAS. ISUP Message Type is the default.

To use TUP message type screening, an SIO screening reference with **si=04** (TUP) must exist in the SIO table. The TUP screening reference specifies the SIO screening reference as the next screening reference parameter (**nsr**) value.

To use ISUP message type screening, an SIO screening reference with **si=05** (ISUP) must exist in the SIO table. The ISUP screening reference specifies the ISUP SIO screening reference as the next screening reference parameter (**nsr**) value.

To screen for TUP and ISUP message types using a combined ISUP/TUP screen set, the SIO screening reference with **si=4** and the SIO screening reference with **si=5** must be two different screening references. The TUP screening reference specifies the SIO screening reference as the next screening reference parameter (**nsr**) value, and the ISUP screening reference specifies the SIO ISUP screening reference as the next screening reference parameter (**nsr**) value.

## Output

When a screening reference is specified that is not yet associated with a screen set, the following output appears:

```
chg-scr-isup:sr=is01:isupmt=2:nsfi=stop:nisupmt=4
  rlgncxa03w 04-01-14 16:45:50 EST EAGLE 31.3.0
  CHG-SCR-ISUP: MASP A - COMPLTD
;
```

When a screening reference is specified that is already associated with one or more screen sets, the following output appears:

```
chg-scr-isup:sr=is02:isupmt=9:nsfi=stop:nisupmt=8
  tekelecstp 04-02-17 16:35:56 EST EAGLE 31.4.0
  Extended Processing Time Required -- Please Wait
  Notice: The number of screensets affected is 2.
  CHG-SCR-ISUP: SCREEN SET AFFECTED - ist1 1% FULL
  CHG-SCR-ISUP: SCREEN SET AFFECTED - ist2 1% FULL
  CHG-SCR-ISUP: MASP A - COMPLTD
;
```

## chg-scr-opc

## Change Allowed OPC

Use this command to change the attributes associated with a specific screening reference in the allowed OPC category. Attributes that can be changed are the point code, next screening function identifier and, next screening reference.

**Keyword:** **chg-scr-opc**

**Related Commands:** **dlt-scr-opc**, **ent-scr-opc**, **rtrv-scr-opc**

**Command Class:** Database Administration

## Parameters

**NOTE: At least one of these parameters must be specified: nnc, nncm, nni, nsfi, nsr.**

**:sr=** (mandatory)

Screening reference. This parameter specifies the point code's unique screening reference name.

**Range:** *ayyy*

1 alphabetic character followed by up to 3 alphanumeric characters

**:actname=** (optional)

Action name. This parameter specifies the name of the gateway screening stop action set. Stop actions must be administered using the **actname** parameter in conjunction with the gateway screening stop action table (see **chg-gws-actset** and **rtrv-gws-actset**).

**Range:** *ayyyyy*, **none**  
 1 alphabetic character followed by up to 5 alphanumeric characters.  
**none**—Remove an existing gateway screening stop action set from a gateway screening rule.

**:area=** (optional)

ITU international area. The area is specified in the point code. The format of the point code is *zone-area-id*. An asterisk (\*) indicates the full range of values from **000–255**.

**Range:** **000-255** \*

**:id=** (optional)

ITU international ID. This parameter specifies the ID in the point code represented by format *zone-area-id*. An asterisk (\*) indicates the full range of values from **0–7**.

**Range:** **0-7** \*

**:msa=** (optional)

24-bit ITU-national main signaling area (*msa*) value. This parameter specifies the main signaling area (*msa*) of the point code represented by *msa-ssa-sp*. An asterisk (\*) indicates the full range of values from **000–255**.

**Range:** **000-255** \*

**:narea=** (optional)

New ITU-international area value. An asterisk (\*) indicates the full range of values from **000–255**.

**Range:** **000-255** \*

**Default:** Current value

**:nc=** (optional)

Network cluster (*nc*) value. This parameter specifies one or more *nc* values for the network indicator (*ni*) and network cluster member (*ncm*) values specified in the **ni** and **ncm** parameters. It specifies the *nc* of the point code represented by *ni-nc-ncm*. A single value or a range of values can be specified. An asterisk (\*) indicates the full range of values from **000–255**.

**Range:** **000-255** \*

**:ncm=** (optional)

Network cluster member (*ncm*) value. This parameter specifies one or more *ncm* values for the network indicator (*ni*) and network cluster (*nc*) values identified in the **ni** and **nc** parameters. It specifies the *ncm* of the point code represented by *ni-nc-ncm*. A single value or a range of values can be specified. An asterisk (\*) indicates the full range of values from **000–255**.

**Range:** **0-255** \*

**:ni=** (optional)

Network indicator (*ni*) value. This parameter specifies one or more *ni* values for the network cluster (*nc*) and network cluster member (*ncm*) values identified in the **nc** and **ncm** parameters. It specifies the *ni* of the point code represented by *ni-nc-ncm*. A single value or a range of values can be specified. An asterisk (\*) indicates the full range of values from **000–255**.

**Range:** **0-255** \*

**:nid=** (optional)

New ITU-international ID value. An asterisk (\*) indicates the full range of values from **0–7**.

**Range:** **0-7** \*

**Default:** Current value

**:nmsa=** (optional)

New 24-bit ITU-national main signaling area (*nmsa*) value. This parameter specifies the new main signaling area (*msa*) of the point code represented by *msa-ssa-sp*. An asterisk (\*) indicates the full range of values from **000–255**.

**Range:** 000-255 \*

**:nnc=** (optional)

New network cluster (*nnc*). This parameter specifies one or more *nnc* values for the screening reference specified in the **sr** parameter. It specifies the new network cluster (*nc*) of the point code represented by *ni-nc-ncm*. A single value or a range of values can be specified. An asterisk (\*) indicates the full range of values from **000–255**.

**Range:** 000-255 \*

**Default:** Current value

**:nncm=** (optional)

New network cluster member (*nncm*). This parameter specifies one or more *ncm* values for the screening reference specified in the **sr** parameter. It specifies the new network cluster member (*ncm*) of the point code represented by *ni-nc-ncm*. A single value or a range of values can be specified. An asterisk (\*) indicates the full range of values from **0–255**.

**Range:** 0-255 \*

**Default:** Current value

**:nni=** (optional)

New network identifier (*nni*). This parameter specifies one or more *nni* values for the screening reference specified in the **sr** parameter. It specifies the new network indicator (*ni*) of the point code represented by *ni-nc-ncm*. A single value or a range of values can be specified. An asterisk (\*) indicates the full range of values from **000–255**.

**Range:** 0-255 \*

**Default:** Current value

**:nnpc=** (optional)

New ITU-national point code. An asterisk (\*) indicates the full range of values from **00000–16383**.

**NOTE: Gateway screening allows the ITU national point code to be displayed and entered in the database only as a single number. If you use multiple-part ITU national point codes, see "Converting ITU National Point Code Formats" in Appendix A for information on converting the point code format.**

**Range:** 00000-16383 \*

**Default:** Current value

**:npc=** (optional)

ITU national point code. An asterisk (\*) indicates the full range of values from **00000–16383**.

**Range:** 00000-16383 \*

**:npct=** (optional)

New point code subtype. This parameter indicates whether the specified new ITU international or ITU national point code has no subtype prefix or has the spare point code prefix (s-).

**Range:** none, s

**Default:** none

**:nsfi=** (optional)

This parameter specifies the next screening category that is used in the gateway screening process, or it indicates that the gateway screening process should stop.

**Range:** blkdpc, blkopc, cgpa, dpc, sio, stop

**blkdpc**—Blocked DPC is the next screening category.

**blkopc**—Blocked OPC is the next screening category.

**cgpa**—Allowed CGPA is the next screening category.

**dpc**—Allowed DPC is the next screening category.

**sio**—Allowed SIO is the next screening category.



**stop**—The gateway screening process ends and the message proceeds through normal routing.

**Default:** Current value

**:nsp=** (optional)

New 24-bit ITU national signaling point (*nsp*). This parameter specifies the new signaling point (*sp*) of the point code represented by *msa-ssa-sp*. An asterisk (\*) indicates the full range of values from **000-255**.

**Range:** **000-255 \***

**:nsr=** (optional)

Next screening reference (*nsr*). This parameter indicates which screening reference in the specified screening category (**nsfi**) is to be used in the screening process. If the **nsfi=stop** parameter is specified, the **nsr** parameter cannot be specified.

**Range:** *ayyy*

1 alphabetic character followed by up to 3 alphanumeric characters

**Default:** Current value

**:nssa=** (optional)

New 24-bit ITU national sub signaling area (*nssa*). This parameter specifies the new sub signaling area (*ssa*) of the point code represented by *msa-ssa-sp*. An asterisk (\*) indicates the full range of values from **000-255**.

**Range:** **000-255 \***

**:nzone=** (optional)

New ITU-international zone. This parameter specifies a new zone for the point code represented by *zone-area-id*. An asterisk (\*) indicates the full range of values from **0-7**.

**Range:** **0-7, \*, C**

**Default:** Current value

**:pcst=** (optional)

Point code subtype. This parameter specifies whether the specified ITU international or ITU national point code has no subtype prefix or has the spare point code prefix (**s-**).

**Range:** **none, s**

**Default:** **none**

**:sp=** (optional)

24-bit ITU national signaling point (*sp*). This parameter specifies the signaling point (*sp*) in the point code represented by *msa-ssa-sp*. An asterisk (\*) indicates the full range of values from **000-255**.

**Range:** **000-255 \***

**:ssa=** (optional)

24-bit ITU national sub signaling area (*ssa*). This parameter specifies the sub signaling area (*ssa*) in the point code represented by the format *msa-ssa-sp*. An asterisk (\*) indicates the full range of values from **000-255**.

**Range:** **000-255 \***

**:zone=** (optional)

ITU international zone. This parameter specifies the zone in the point code represented by format *zone-area-id*. An asterisk (\*) indicates the full range of values from **0-7**.

**Range:** **0-7, \***

### Example

```
chg-scr-opc:sr=iec:ni=240:nc=010:ncm=010:nni=240:nnc=010:nncm=020
```

```
chg-scr-
opc:sr=iec:ni=240:nc=010:ncm=010:nnc=010:nncm=020:nsfi=st
op :actname=cncf
chg-scr-opc:sr=iec:nsfi=dpc:nsr=wr2
chg-scr-opc:sr=opc1:npc=128:nsfi=fail:pcst=s:npcst=none
```

### Dependencies



**CAUTION:** Even though gateway screening is in the screen test mode, as defined by the parameters **gwsa=off** and **gws=on**, the gateway screening action in the stop action set specified by the **actname** parameter of the screen set *will* be performed at the end of the screening process.

A complete point code must be specified, using the **ni-nc-ncm**, **zone-area-id**, **msa-ssa-sp**, or **npc** combination unless a value of **c** for “continue” is specified.

A new point code entry must be specified by one, and only one of the four point code parameter combinations: **nnc-nnc-ncm**, **nzone-narea-nid**, **nmsa-nssa-nsp**, or **nnpc**. If the new point code entry is a different point code type than the existing point code entry, all subfields of the new point code type must be specified.

ANSI point code value **000-000-000** and ITU-International point code value **0-000-0** are not allowed. At least one optional parameter must be specified.

The current OPC specified by **ni-nc-ncm**; **zone-area-id**, **msa-ssa-sp**, or the **npc** parameter must already exist in the screening reference or within an existing range of OPCs.

The new OPC or OPC range defined by **ni-nc-ncm**, **zone-area-id**, **msa-ssa-sp**, or the **npc** parameter must not already exist in the screening reference or within an existing range of OPCs.

If the **actname** parameter is specified, then the **nsfi=stop** parameter must be specified.

If the **nsr** parameter is specified, then the **actname** parameter cannot be specified.

The **actname** parameter value must already be defined in the Gateway Screening Stop Action table with the **chg-gws-actset** command. These values are shown in the *ACT NAME* field of the **rtrv-gws-actset** command output.

If **zone=\*** is specified, **area=\*** and **id=\*** must be specified.

If the **area=\*** parameter is specified, the **id=\*** parameter must be specified.

If the **msa=\*** parameter is specified, the **ssa=\*** and **sp=\*** parameters must be specified.

If the **ssa=\*** parameter is specified, the **sp=\*** parameter must be specified.

The **nsfi** and **nsr** parameters must point to an existing screen, or the **nsfi=stop** parameter must be specified, and the **nsr** parameter cannot be specified.

If the **nc** parameter is specified as a range, the **ncm** parameter must be specified as an asterisk or as the full range **000-255**

If the **nc** parameter is specified as a single value or a range, a single value must be specified for the **ni** parameter.

If the **nc=\*** parameter is specified, the **ncm** parameter must be specified as an asterisk or as the full range **000-255**.

If the **ncm** parameter is specified as a single value, or a range other than the full range of **000-255**, the **ni** and the **nc** parameters must be specified with a single value.

If the **ni** parameter is specified as an asterisk (**ni=\***) or as a range, the **nc** and **ncm** parameters must be specified as an asterisk or as the full range **000-255**.

If the **nnc** parameter is specified as a range, the **nncm** parameter must be specified as an asterisk or as the full range **000-255**

If the **nnc** parameter is specified as a single value or a range, a single value must be specified for the **nni** parameter.

If the **nnc=\*** parameter is specified, the **nnm** parameter must be specified as an asterisk or as the full range **000–255**.

If the **nncm** parameter is specified as a single value, or a range other than the full range of **000–255**, the **nni** and the **nnc** parameters must be specified with a single value.

If the **nni** parameter is specified as an asterisk (**nni=\***) or as a range, the **nnc** and **nncm** parameters must be specified as an asterisk or as the full range **000–255**.

If the **nsfi=stop** parameter is not specified, then the **nsr** parameter must be specified.

The value of the **sr** parameter must already exist in the BLKOPC entity set.

The Spare Point Code Support feature must be enabled before the **pcst** parameter can be specified.

The spare point code subtype prefix (**s-**) is not supported for ANSI point codes (parameters **ni**, **nc**, **nncm**) or for 24-bit ITU national point codes (parameters **msa**, **ssa**, **sp**). The **pcst** parameter cannot be specified for ANSI and ITU-N24 point codes.

## Notes

A range of values is specified by separating the values that define the range by two ampersands (**&&**); for example, **:ni=025&&100** specifies all network indicators for ANSI point codes from **25** to **100**.

An asterisk cannot not be specified for a parameter value in this command unless an asterisk was specified for the parameter value in the original **ent-scr-opc** command.

If the screen set reaches 100% capacity (indicated by the “100% full” message), the system will allow subsequent entries. An error will occur, however, when downloading the screen set to the card. Screen sets should not exceed 100% capacity. Remove screen set entries until the capacity is below 100%.

The spare point code subtype prefix **s-** is supported only for ITU international and ITU national point codes. The **pcst** and **npcst** parameters indicate whether the specified point code has no subtype prefix or has the spare point code prefix.

## Output

```
chg-scr-opc:sr=iec:ni=240:nc=010:nncm=010:nni=240:nnc=010:nncm=020
rlghncxa03w 04-01-07 12:05:33 EST EAGLE 31.3.0
CHG-SCR-OPC: SCREEN SET AFFECTED - IEC 25% FULL
CHG-SCR-OPC: MASP A - COMPLTD
;
```

### Legend

**CHG-SCR-OPC**—The command entered that caused this output. This is echoed to the printer as a reference.

**SCREEN SET AFFECTED**—Identifies the screen set that was affected by the command. The screen set name is provided.

**% FULL**—Indicates the relative size of the screen set.

## chg-scr-sio

### Change Allowed SIO

Use this command to change a specific screening reference in the allowed service indicator octet category. Attributes that may be changed are the network indicator, service indicator, message priority, heading codes, next screening function identifier, and next screening reference.

**NOTE: To use TUP message type screening, an SIO screening reference with si=04 (TUP) must be defined in the SIO table. This SIO screening reference is specified as the next screening reference (nsr) value in an ISUP screening reference for screening TUP message types.**

**Keyword:** chg-scr-sio

**Related Commands:** dlt-scr-sio, ent-scr-sio, rtrv-scr-sio

**Command Class:** Database Administration

### Parameters

At least one of these parameters must be specified: **nh0** , **nh1**, **nnic**, **npri**, **nsfi**, **nsi**, **nsr**.

**:nic=** (mandatory)

Network indicator code. This parameter specifies whether the message originated from an international (0) or national (2) network. A single value or a range of values can be specified. An asterisk (\*) indicates the full range of values from 0–3.

**Range:** 0-3 \*

**:pri=** (mandatory)

Message priority. This parameter specifies the new message priority in the SIO. A single value or a range of values can be specified. An asterisk (\*) indicates the full range of values from 0–3.

**Range:** 0-3 \*

**Default:** Current value

**:si=** (mandatory)

Service indicator. This parameter specifies the type of message. The values are defined in Telcordia TR-NWT-000246.

**Range:** 00, 01- 15

**:sr=** (mandatory)

Screening reference. This parameter specifies the point code's unique screening reference name.

**Range:** ayyy

1 alphabetic character followed by up to 3 alphanumeric characters

**:actname=** (optional)

Action name. This parameter specifies the name of the gateway screening stop action set. Stop actions must be administered using the **actname** parameter in conjunction with the gateway screening stop action table (see **chg-gws-actset** and **rtrv-gws-actset**).

**Range:** ayyyyy

1 alphabetic character followed by up to 5 alphanumeric characters.

**none**—remove an existing gateway screening stop action set from a gateway screening rule.

**:h0=** (optional)

This parameter is mandatory if the service indicator (**si**) value is **00**, **01**, **02**, or **03**. Otherwise, the **h0** parameter is undefined.

**Range:** 0-15 \*

**Default:** Current value or undefined

**:h1=** (optional)

This parameter is mandatory if the service indicator (**si**) value is **00**, **01**, **02**, or **03**. Otherwise, the **h1** parameter is undefined.

**Range:** 0-15 \*

**Default:** Current value or undefined

**:nh0=** (optional)

New H0 heading code. This parameter specifies a new H0 heading code for the screening reference specified in the **sr** parameter. A single value or a range of values can be specified. An asterisk (\*) indicates the full range of values from **0–15**.

**Range:** **0-15 \***

**Default:** Current value

**:nh1=** (optional)

New H1 heading code. This parameter specifies a new H1 heading code for the screening reference specified in the **sr** parameter. A single value or a range of values can be specified. An asterisk (\*) indicates the full range of values from **0–15**.

**Range:** **0-15 \***

**Default:** Current value

**:nnic=** (optional)

New network indicator code. This parameter specifies the new **nic** for the screening reference specified. A single value or a range of values can be specified. An asterisk (\*) indicates the full range of values from **0–3**.

**Range:** **0-3 \***

**Default:** Current value

**:npri=** (optional)

New message priority. This parameter specifies the new message priority in the SIO. A single value or a range of values can be specified. An asterisk (\*) indicates the full range of values from **0–3**.

**Range:** **0-3 \***

**Default:** Current value

**:nsfi=** (optional)

This parameter specifies the next screening category that is used in the gateway screening process, or it indicates that the gateway screening process should stop.

**Range:** **blkdpc, cdpa, cgpa, destfld, isup, stop, dpc**

**blkdpc** — Blocked DPC

**cdpa** — Allowed CDPA

**cgpa** — Allowed CGPA

**destfld** — Allowed destination field (DESTFLD)

**isup** — ISUP message type (ISUP)

**stop** — The gateway screening process ends and the message proceeds through normal routing.

**dpc** — Allowed DPC

**Default:** Current value

**:nsi=** (optional)

New service indicator. This parameter specifies the type of message for the specified screening reference. The values are defined in Telcordia TR-NWT-000246.

**Range:** **0-15**

**Default:** Current value

**:nsr=** (optional)

Next screening reference (*nsr*). This parameter specifies which screening reference in the specified screening category (**nsfi**) is to be used in the screening process. If the **nsfi=stop** parameter is specified, the **nsr** parameter cannot be specified.

**Range:** *ayyy*

1 alphabetic character followed by up to 3 alphanumeric characters

**Default:** Current value

**Example**

```
chg-scr-sio:sr=iec:nic=1:si=1:h0=02:h1=03:pri=*:nh0=03&&04
chg-scr-sio:sr=iec:nic=1:si=3:pri=2:npri=1
chg-scr-sio:sr=iec:nic=1:si=3:pri=3:nnic=2:nsfi=stop:actname=copy
```

**Dependencies**



**CAUTION:** Even though gateway screening is in the screen test mode, as defined by the parameters `gwsa=off` and `gws=on`, the gateway screening action in the stop action set specified by the `actname` parameter of the screen set *will* be performed at the end of the screening process.

At least one attribute must be changed.

If asterisk values or ranges are specified for the new heading codes, nothing that matches the entire combination of `nic/nnic`, `si/nsi`, and the specified new heading codes and priorities can already exist in the allowed SIO category for the screening reference.

An asterisk cannot be specified for a parameter value in this command unless an asterisk was specified for the parameter value in the original `ent-scr-sio` command.

If the `actname` parameter is specified, then the `nsfi=stop` parameter must be specified.

If the `actname` parameter is specified, the `nsr` parameter cannot be specified.

The `actname` parameter value must already be defined in the Gateway Screening Stop Action table with the `chg-gws-actset` command. These values are shown in the `ACTNAME` field of the `rtrv-gws-actset` command output.

The `nsfi` and `nsr` parameters must point to an existing screen, or the `nsfi=stop` parameter must be specified, and the `nsr` parameter cannot be specified.

Use Table 5-28 to determine an acceptable combination of the `nsfi` (new entries) and `si` parameters:

**Table 5-28.** Acceptable `nsfi` and `si` parameter combinations (`chg-scr-sio`)

If the <code>nsfi</code> parameter is...	...the <code>si</code> parameter must be:
destfld	00
cdpa	03
cgpa	03
isup	05

If the `si` parameter value is greater than 2, and the `nsi` parameter value is greater than 3, the `nh0` and `nh1` parameters are used to enter the required `h0` and `h1` parameter values.

Table 5-29 shows the valid combinations of the `h0/h1` and `nh0/nh1` parameters

**Table 5-29.** Valid combinations for the `h0/h1` and `nh0/nh1` parameters (`chg-scr-sio`)

If the <code>h0</code> ( <code>nh0</code> ) parameter is specified as:	The <code>h1</code> ( <code>nh1</code> ) parameter can be specified as:
A single value	A single value
A single value	A range

**Table 5-29.** Valid combinations for the **h0/h1** and **nh0/nh1** parameters (**chg-scr-sio**)

<b>If the h0 (nh0) parameter is specified as:</b>	<b>The h1 (nh1) parameter can be specified as:</b>
A single value	An asterisk (*) entry
A range	An asterisk (*) entry
An asterisk (*) entry	An asterisk (*) entry

The **nh0** and **nh1** parameters cannot be specified if the **nsi** parameter is specified and is not equal to **00**, **01**, or **02**.

Use Table 5-30 to determine additional acceptable combinations of specified parameter values

**Table 5-30.** Additional Valid chg-scr-sio Parameter Combinations

<b>si value:</b>	<b>nic value</b>	<b>pri value</b>	<b>h0 value:</b>	<b>h1 value:</b>
0	s, *	s, *, r	s	s, *, r
0	s, *	s, *, r	*, r	*
1, 2	s, *	s, *, r	s	s, *, r
1, 2	s, *	s, *, r	*, r	*
3-15	s, *	s, *, r	u	u
<p><b>Legend</b></p> <p>s = single value</p> <p>r = range</p> <p>* = asterisk</p> <p>u = unspecified</p>				

If the **nh0** or **nh1** parameters are specified, the parameter values must be valid with the **h0** or **h1** values currently in the database.

The **h0**, **h1**, **nh0**, and **nh1** parameters cannot be specified if the **si** parameter is not equal to **00**, **01**, or **02**, and the **nsi** parameter is not specified.

The **nnic**, **nsi**, **pri**, and **nh0/nh1** parameters must not already exist in the allowed SIO category.

The **sr**, **nic**, **si**, **pri**, and **h0/h1** parameters for which attributes are to be changed must be in the allowed SIO category.

If **nsfi=stop** parameter is specified, the **nsr** parameter cannot be specified.

If the **nsfi=stop** parameter is not specified, then the **nsr** parameter must be specified.

If the **si** parameter is equal to **00**, **01**, or **02**, the **h0** and **h1** parameters must be specified. Otherwise, the **h0** parameter cannot be specified.

The specified screening reference (**sr**) must already exist in the database.

**Notes**

If the screen set reaches 100% capacity (indicated by the “100% full” message), the system allows subsequent entries. An error occurs, however, when downloading the screen set to the card. Ensure that screen sets do not exceed 100% capacity. Remove screen set entries until the capacity is below 100%.

To use TUP message type screening, an SIO screening reference with **si=04** (TUP) must be defined in the SIO table. To use ISUP message type screening, a rule with **si=05** (ISUP) must be defined in the SIO table. To use a combined ISUP/TUP screen set for TUP and ISUP message screening, the SIO screening reference with **si=4** and the SIO screening reference with **si=5** must be two different screening references.

A network indicator value of **1** or **3** can be used in private networks.

A network indicator value of **3** can be used in some national networks to broaden the identity of a national network, but is usually spare.

**Output**

```
chg-scr-sio:sr=iec:nic=1:si=3:pri=2:npri=1
```

```

r1ghncxa03w 04-01-14 16:45:50 EST EAGLE 31.3.0
CHG-SCR-SIO: SCREEN SET AFFECTED - SS01 25% FULL
CHG-SCR-SIO: SCREEN SET AFFECTED - SS04 35% FULL
CHG-SCR-SIO: MASP A - COMPLTD
;

```

**Legend**

**CHG-SCR-SIO**—The command entered that caused this output. This is echoed to the printer as a reference.

**SCREEN SET AFFECTED**—Identifies the screen set that was affected by the command. The screen set name is provided.

**% FULL**—Indicates the relative size of the screen set.

**chg-scr-tt****Change Allowed Translation Type**

Use this command to change the attributes of a specific screening reference in the allowed translation type category. Attributes that can be changed are the translation type, next screening function identifier and next screening reference.

**Keyword:** **chg-scr-tt**

**Related Commands:** **dlt-scr-tt**, **ent-scr-tt**, **rtrv-scr-tt**

**Command Class:** Database Administration

**Parameters**

**:sr=** (mandatory)

Screening reference. This parameter specifies the point code's unique screening reference name.

**Range:** *ayyy*

1 alphabetic character followed by up to 3 alphanumeric characters

**:type=** (mandatory)

Translation type. This parameter specifies the global title translation type value in the called party address. A single value or a range of values can be specified. An asterisk (\*) indicates the full range of values from **0-255**.

**Range:** **000-255\***



**:actname=** (optional)

Action name. This parameter specifies the name of the gateway screening stop action set. Stop actions must be administered using the **actname** parameter in conjunction with the gateway screening stop action table (see **chg-gws-actset** and **rtrv-gws-actset**).

**Range:** *ayyyyy*, **none**

1 alphabetic character followed by up to 5 alphanumeric characters.

**none**—remove an existing gateway screening stop action set from a gateway screening rule.

**:nsfi=** (optional)

This parameter specifies the next screening category that is used in the gateway screening process, or it indicates that the gateway screening process should stop.

**Range:** **cdpa**, **stop**

**cdpa**—Allowed called party address is the next screening category.

**stop**—The gateway screening process ends and the message proceeds through normal routing.

**Default:** Current value

**:nsr=** (optional)

Next screening reference (*nsr*). This parameter specifies which screening reference in the specified screening category (**nsfi**) is to be used in the screening process. If the **nsfi=stop** parameter is specified, the **nsr** parameter cannot be specified.

**Range:** *ayyy*

1 alphabetic character followed by up to 3 alphanumeric characters

**Default:** Current value

**:ntype=** (optional)

New translation type. The translation type identifies the global title translation type value in the called party address. A single value or a range of values can be specified. An asterisk (\*) indicates the full range of values from **0–255**.

**Range:** **000-255 \***

**Default:** Current value

**Example**

```
chg-scr-tt:sr=iec:type=012:ntype=014
```

```
chg-scr-tt:sr=iec:type=012:ntype=014:nsfi=stop:actname=none
```

**Dependencies**

**CAUTION:** Even though gateway screening is in the screen test mode, as defined by the parameters **gwsa=off** and **gws=on**, the gateway screening action in the stop action set specified by the **actname** parameter of the screen set *will* be performed at the end of the screening process.

At least one attribute must be changed.

The new translation type cannot already exist.

If an asterisk is specified for the new allowed **type**, no other translation types can exist in the screening table.

If the **actname** parameter is specified, the **nsfi=stop** parameter must be specified.

If the **actname** parameter is specified, the **nsr** parameter cannot be specified.

The **actname** parameter value must already be defined in the Gateway Screening Stop Action table with the **chg-gws-actset** command. These values are shown in the *ACT NAME* field of the **rtrv-gws-actset** command output.

The next screening function identifier and the next screening to be added must point to one or more existing screening references.

If the **nsfi=stop** parameter is specified, the **nsr** parameter cannot be specified.

If the **nsfi** parameter has a value other than **stop**, the **nsr** parameter must be specified.

If the screening reference exists, the single value or range specified for the allowed **type** to be added to the TT screen for the allowed TT screening reference must not already exist in that TT screen.

The screening reference and translation type for which the attributes are to be changed must exist.

The current translation type must already exist.

## Notes

If the screen set reaches 100% capacity (indicated by the “100% full” message), the system allows subsequent entries. An error occurs, however, when downloading the screen set to the card. Ensure that screen sets do not exceed 100% capacity. Remove screen set entries until the capacity is below 100%.

An asterisk can be specified for a parameter value in the **chg-scr-tt** and **dlt-scr-tt** commands *only* if that parameter value was specified as an asterisk in the **ent-scr-tt** command to define the parameter value.

## Output

**chg-scr-tt:sr=iec:type=012:ntype=014**

```
rlghncxa03w 04-01-07 12:05:33 EST EAGLE 31.3.0
CHG-SCR-TT:  SCREEN SET AFFECTED - IEC 25% FULL
CHG-SCR-TT:  MASP A - COMPLTD
;
```

## Legend

**CHG-SCR-TT**—The command entered that caused this output. This is echoed to the printer.

**SCREEN SET AFFECTED**—Identifies the screen set that was affected by the command. The screen set name is provided.

**% FULL**—Indicates the relative size of the screen set.

## chg-scrset

## Change Screen Set

Use this command to change the attributes of a screen set. A screen set is a group of screening references that can be assigned to a linkset. It is defined by a name and a pointer to the first screening reference of a screen set.

**Keyword:** **chg-scrset**

**Related Commands:** **dlt-scrset**, **ent-scrset**, **rtrv-scrset**

**Command Class:** Database Administration

## Parameters

At least one of these parameters must be specified: **nscrn**, **nsfi**, **nsr**.

**:scrn=** (mandatory)

Screen set name. Each screening reference must have a unique name.

**Range:** *ayyy*

1 alphabetic character followed by up to 3 alphanumeric characters

**:actname=** (optional)

Action name. This parameter specifies the name of the gateway screening stop action set. Stop actions must be administered using the **actname** parameter in conjunction with the gateway screening stop action table (see **chg-gws-actset** and **rtrv-gws-actset**).

**Range:** *ayyyyy*

1 alphabetic character followed by up to 5 alphanumeric characters.

**none**—remove an existing gateway screening stop action set from a gateway screening rule.

**:destfld=** (optional)

This parameter turns on and off the automatic allowed affected destination screening for network management messages against the routing table, self point codes, and capability point codes. When this parameter is **on**, the automatic screening is applied at the end of the provisioned screen set.

**Range:** **yes, no**

**Default:** Current value

**:nscrn=** (optional)

New screen set name.

**Range:** *ayyy*

1 alphabetic character followed by up to 3 alphanumeric characters

**Default:** Current value

**:nsfi=** (optional)

This parameter specifies the next screening category that is used in the gateway screening process, or it indicates that the gateway screening process should stop.

**Range:** **blkdpc, blkopc, dpc, opc, sio, stop**

**blkdpc**—Blocked DPC is the next screening category.

**blkopc**—Blocked OPC is the next screening category.

**dpc**—Allowed DPC is the next screening category.

**opc**—Allowed OPC is the next screening category.

**sio**—Allowed SIO is the next screening category.

**stop**—The gateway screening process ends and the message proceeds through normal routing.

**Default:** Current value

**:nsr=** (optional)

Next screening reference. The parameter indicates which screening reference in the specified screening category (**nsfi**) is to be used in the screening process. If **nsfi=stop**, the **nsr** parameter cannot be specified.

**Range:** *ayyy*

1 alphabetic character followed by up to 3 alphanumeric characters

**Default:** Current value

**Example**

```
chg-scrset:scrn=ss01:nsfi=opc:nsr=iec
```

```
chg-scrset:scrn=ss02:nsfi=stop:nscrn=ss03
```

```
chg-scrset:scrn=ss02:nscrn=ss03:nsfi=stop:actname=copy
```

```
chg-scrset:scrn=ss02:nsfi=stop:nscrn=ss03:destfld=no
```

**Dependencies**

The value of the **nscrn** parameter cannot be assigned to another screen set.

If the **actname** parameter is specified, the **nsfi=stop** parameter must be specified.

If the **actname** parameter is specified, the **nsr** parameter cannot be specified.

The **actname** parameter value must already be defined in the Gateway Screening Stop Action table with the **chg-gws-actset** command. These values are shown in the *ACTNAME* field of the **rtrv-gws-actset** command output.

The **nsfi** and **nsr** parameters must point to one or more existing entities in another entity set, or the **nsfi=stop** parameter must be specified, and the **nsr** parameter cannot be specified.

If the **nsfi=stop** parameter is not specified, then the **nsr** parameter must be specified.

An existing screen set must be removed from all linksets before it can be changed.

If the **nsrnm** parameter is specified, the **scrn** parameter value cannot be referenced by a linkset.

If the next screening function identifier (**nsfi**) and the next screening reference (**nsr**) does not point to an existing screen, the **nsfi** must be equal to **stop** and the **nsr** parameter must not be specified.

At least one optional parameter must be specified.

### Notes

If the screen set reaches 100% capacity (indicated by the “100% full” message), the system allows subsequent entries. An error occurs, however, when downloading the screen set to the card. Screen sets should not exceed 100% capacity. Remove screen set entries until the capacity is below 100%.

The system validates the command to verify that the specified screen set name is in use.

### Output

```
chg-scrset:scrn=ss01:nsfi=opc:nsr=iec
rlghncxa03w 04-01-07 09:35:10 EST EAGLE 31.3.0
CHG-SCRSET:  SCREEN SET AFFECTED - SS01  25% FULL
CHG-SCRSET:  MASP A - COMPLTD
;
```

### Legend

**CHG-SCRSET**—The command entered that caused this output. This is echoed to the printer as a reference.

**SCREEN SET AFFECTED**—Identifies the screen set that was affected by the command. The screen set name is shown.

**% FULL**—Indicates the relative size of the screen set.

## chg-seas-config

## Changes CCMR Configuration

Use this command to configure information for the CCS Message Router (CCS MR) in the EAGLE 5 ISS database.

**NOTE: The CCS MR is a stand-alone, self-contained system that provides a centralized mechanism for routing CCS network operations traffic between STPs/SCPs and existing and new OSS.**

**Keyword:** **chg-seas-config**

**Related Commands:** **rtrv-seas-config**

**Command Class:** System Maintenance

### Parameters

**:authmode=** (optional)

Authentication mode. This parameter specifies the authentication mode for the EAGLE 5 ISS. Password-based authentication is the only authentication mode that is supported currently.

**Range:** password

**:conn=** (optional)

Connection. This parameter specifies the CCS MR where the SEAS terminal is connected.

**Range:** ipmr1, ipmr2

**:hname=** (optional)

Host name. This parameter specifies the name of the remote host machine.

**Range:** zzzzzzzzzzzzzzzzzzzzz

1-15 alphanumeric characters

The **hname** parameter allows quotation marks (""") to be entered as part of the value. If the value of the **hname** parameter contains quotation marks, then a hyphen (-) can also be used.

**:ipaddr=** (optional)

IP address. This parameter specifies the IP address of the CCS MR.

**Range:** 4 numbers separated by dots, with each number in the range of 0-255.

**:login=** (optional)

This parameter specifies the login name that is used to create an SSH connection between the CCS MR and the EAGLE 5 ISS.

**Range:** zzzzzzzzzzzzzzzzzzzzz

1-15 alphanumeric characters.

**:port=** (optional)

This parameter specifies the port number of the CCS MR.

**Range:** 1024-5000

**:seascli=** (optional)

This parameter specifies the SEASCLI portion of the EAGLE 5 ISS node name that is sent in SR-5129 messages.

The **seascli** value is different from the EAGLE 5 ISS **cli** value that is configured with the **chg-sid** command.

The corresponding SEASCLI name must be configured on the CCS MR. Refer to Telecordia Configuration Specification "Telcordia Technologies System Documentation", *BD-SNAM-ADMIN-4 Issue 14, November 2006*.

**Range:** ayyyyyyyyyyyyyyyyyy

1 alphabetic character followed by up to 15 alphanumeric characters; the first character must be a letter.

## Example

```
chg-seas-
config:seascli=eaglestp001:conn=ipmr1:ipaddr=198.168.25.10:port=
1500
chg-seas-config:conn=ipmr2:port=3000
chg-seas-config:conn=ipmr2:ipaddr=10.203.63.23
```

## Dependencies

The SEAS Over IP feature must be enabled before this command can be entered.

The SEAS terminal must be inhibited before the **seascli**, **ipaddr**, **port**, **login**, **hname**, or **authmode** parameters can be specified.

The **conn** parameter must be specified before the **port**, **ipaddr**, **login**, or **hname** parameters can be specified.

The value of the password requested by the **login** parameter must be from 1 - 15 alphanumeric characters in length.

The **port** and **ipaddr** parameters must have unique values for each CCS MR.

### Output

```
chg-seas-
config:seasc1li=eaglestp001:conn=ipmr1:ipaddr=198.168.25.10:port=
1500
  tekelecstp 07-06-16 22:34:11 IST EAGLE 37.5.0
  CHG-SEAS-CONFIG: MASP A - COMPLTD
;

chg-seas-config:conn=ipmr2:port=3000
  tekelecstp 07-06-16 22:34:11 IST EAGLE 37.5.0
  CHG-SEAS-CONFIG: MASP A - COMPLTD
;
```

## chg-secu-dflt

### Change System-Wide Security-Related Defaults

Use this command to change various system-wide, security-related defaults, such as:

- The default password aging interval
- The default user ID aging interval
- Whether to allow or prohibit multiple simultaneous logins with the same user ID
- Control of the password-complexity checking algorithm
- Login warning message text
- Clear the warning message text displayed during login to the EAGLE 5 ISS

**Keyword:** **chg-secu-dflt**

**Related Commands:** **ent-user**, **login**, **rtrv-secu-dflt**

**Command Class:** Security Administration

### Parameters

**:alpha=** (optional)

This parameter specifies the minimum number of alphabetic characters (a–z) required in a new password.

**Range:** **0-12**

**Default:** Current value

**System**

**Default:** **1**

**:clwrntx=** (optional)

Clear warning text. This parameter deletes warning message text.

**Range:** **no, yes, all**

**no** — Does not delete any warning message text.

**yes** — Deletes warning message text for the line specified by the **wrnln** parameter.

**all** — Deletes warning message text for all lines.

**Default:** No change to current value.

**:minlen=** (optional)

Minimum password length. This parameter specifies the minimum number of characters that must be in a user password.

**Range:** 1-12  
**Default:** Current value  
**System**  
**Default:** 8

**:multlog=** (optional)

This parameter specifies whether multiple simultaneous logins can be performed with a user ID.

**Range:** yes, no  
**yes** — A user ID can be logged in to more than one terminal at the same time.  
**no** — A user ID can be logged in to only one terminal at a time.

**Default:** Current value  
**System**  
**Default:** no

**:num=** (optional)

Number. This parameter specifies the minimum number of numeric characters (0–9) required in a new password.

**Range:** 0-12  
**Default:** Current value  
**System**  
**Default:** 1

**:page=** (optional)

Password age. This parameter specifies the default password aging interval for newly created user IDs. If the **page** parameter is specified in the **ent-user** command, the system uses that value; otherwise, the system uses the value specified here.

**Range:** 0-999  
**Default:** Current value  
**System**  
**Default:** 90

**:punc=** (optional)

Punctuation. This parameter specifies the minimum number of punctuation characters required in a new password. A punctuation character is any character that is not an alphabetic or numeric character, including spaces.

**Range:** 0-12  
**Default:** Current value  
**System**  
**Default:** 1

**:uout=** (optional)

User ID aging interval. This parameter specifies the number of successive days a user ID can go unused (no successful login) before the system denies login. If the **uout** parameter is specified in the **ent-user** command, the system uses that value; otherwise, the system uses the value specified here.

**Range:** 0-999  
**Default:** Current value  
**System**  
**Default:** 90

**:wrnln=** (optional)

Warning message line number. This parameter specifies the line number within the warning message to receive the new text specified by the **wrn tx** parameter.

**Range:** 1-20  
**Default:** Current value

**:wrntx=** (optional)

New message text for the warning message. This parameter specifies the text that replaces the current text of the warning message line specified by the **wrnln** parameter.

**Range:** ~~~~~  
Any quoted alphanumeric string from 0-70 characters in length; for example, "abc123".

**Default:** Current value

### Example

```
chg-secu-dflt:minlen=5
```

The following example input shows how to add a blank line to the display after a successful login and how to cause lines not to display as part of the message after a successful login.

```
chg-secu-
dflt:wrnln=1:wrntx="*****"
*****"

chg-secu-dflt:wrnln=1:clrwrntx=yes
chg-secu-dflt:wrnln=3:wrntx="* unauthorized access or use may lead
to *"
chg-secu-dflt:wrnln=4:wrntx="* prosecution. *"
chg-secu-dflt:wrnln=5:wrntx="* 05-07-01 notice!!! eagle will be
upgraded between `*"
chg-secu-dflt:wrnln=6:wrntx="* the hours of 2am-3am on 05-07-01. *"
chg-secu-dflt:wrnln=7:wrntx="* *"
chg-secu-dflt:wrnln=8:wrntx="* today's happy message: go with
tekelec!! *"
chg-secu-
dflt:wrnln=9:wrntx="*****"
*****"

chg-secu-dflt:wrnln=10:wrntx=" " (set to 1 space to insert a blank
line)
chg-secu-dflt:wrnln=10:clrwrntx=yes
chg-secu-dflt:clrwrntx=all
chg-secu-dflt:clrwrntx=no:multilog=yes
```

### Dependencies

At least one optional parameter must be specified.

The sum of the values specified for the **alpha**, **num**, and **punc** parameters must not be greater than 12.

The **wrnln** and **wrntx** parameters must be specified together in this command.

### Notes

The warning message lines are displayed in the scroll area in order after a successful login; that is, line 1, line 2, and so on.

Any warning message line deleted with **clrwrntx=yes** parameter is not displayed in the scroll area during login.

The following message is the default message delivered with every system:

```
NOTICE: This is a private computer system.
Unauthorized access or use may lead to prosecution.
```



Even though the minimum number of characters allowed in a password is specified using the **minlen** parameter, the password also must satisfy the minimum value requirements specified on the **alpha**, **num**, and **punc** parameters. The actual minimum password length is the greater of either the value specified on the **minlen** parameter or the total number of characters specified on the **alpha**, **num**, and **punc** parameters.

For example, if **chg-secu-dflt:minlen=5:alpha=2:num=2:punc=2** is entered, the minimum number of password characters specified on the **minlen** parameter is 5. But the total number of characters specified in the **alpha**, **num**, and **punc** parameters is 6 (**alpha+num+punc**). The effective minimum number of characters is actually 6 rather than the 5 specified on the **minlen** parameter.

If the **clwrntx=yes** parameter is specified, then at least one line number must be specified.

## Output

The following commands create the warning message that is shown in the output after the commands. The notes that are not bold in parentheses after some commands explain the displayed output. The warning message is displayed after the user enters the **login** command and a password. The output example shows the command output, a **login** command and password prompt, and the warning message that was created with these commands. See the Notes section for this command for additional information about entering this command.

```

chg-secu-
dflt:wrnln=1:wrntx="*****"
chg-secu-dflt:wrnln=2:wrntx="* NOTICE: This is a private computer system. *"
chg-secu-dflt:wrnln=3:wrntx="* Unauthorized Access or use may lead to *"
chg-secu-dflt:wrnln=4:wrntx="* prosecution. *"
chg-secu-dflt:wrnln=5:wrntx="* 08/03/01 Notice!!! Eagle will be upgraded between *"
chg-secu-dflt:wrnln=6:wrntx="*           the hours of 2am-3am on 08/03/15. *"
chg-secu-dflt:wrnln=7:wrntx="* *"
chg-secu-dflt:wrnln=8:wrntx="* Today's happy message: Go with Tekelec!! *"
chg-secu-
dflt:wrnln=9:wrntx="*****"
chg-secu-dflt:wrnln=10:wrntx=" " (set to 1 space to cause blank line before login history is displayed)
chg-secu-dflt:wrnln=11:clrwrntx=yes
chg-secu-dflt:wrnln=12:clrwrntx=yes
chg-secu-dflt:wrnln=13:clrwrntx=yes
chg-secu-dflt:wrnln=14:clrwrntx=yes (remaining lines are provisioned to cause
chg-secu-dflt:wrnln=15:clrwrntx=yes them not to display as part of the message
chg-secu-dflt:wrnln=16:clrwrntx=yes after successful login)
chg-secu-dflt:wrnln=17:clrwrntx=yes
chg-secu-dflt:wrnln=18:clrwrntx=yes
chg-secu-dflt:wrnln=19:clrwrntx=yes
chg-secu-dflt:wrnln=20:clrwrntx=yes
  rlghncxa03w 08-03-10 11:43:04 EST  EAGLE 38.0.0
  CHG-SECU-DFLT: MASP A - COMPLTD
;

LOGIN:UID=eagle
PASSWORD:<password is not displayed>

*****
* NOTICE: This is a private computer system.      *
* Unauthorized Access or use may lead to          *
* prosecution.                                    *
* 08/03/01 Notice!!! Eagle will be upgraded between *
*           the hours of 2am-3am on 08/03/15.    *
*

```

```
* Today's happy message: Go with Tekelec!! *
*****
0 LOGIN failures since last successful LOGIN
Last successful LOGIN was on port 3 on 08-03-09 @ 12:12:35
;
```

The following command clears all of the warning messages.

```
chg-secu-dflt:clrwrtx=all
tekelecstp 08-03-02 17:53:13 EST EAGLE 38.0.0
CHG-SECU-DFLT: MASP A - COMPLTD
;

LOGIN:UID=eagle
PASSWORD:<password is not displayed>
```

```
0 LOGIN failures since last successful LOGIN
Last successful LOGIN was on port 3 on 08-02-26 @ 12:12:35
;
```

The following commands set the warning message text that is shown in the output. The parameter **clrwrtx=no** has no impact on the command output.

```
chg-secu-dflt:wrnln=1:wrntx="*****":clrwrtx=no
chg-secu-dflt:wrnln=2:wrntx="* NOTICE: This is a private computer system.*":clrwrtx=no
```

```
chg-secu-dflt:wrnln=3:wrntx="*****
*****":clrwrtx=no
tekelecstp 08-03-02 17:53:31 EST EAGLE 38.0.0
CHG-SECU-DFLT: MASP A - COMPLTD
;

LOGIN:UID=eagle
PASSWORD:<password is not displayed>
```

```
*****
* NOTICE: This is a private computer system. *
*****

0 LOGIN failures since last successful LOGIN
Last successful LOGIN was on port 3 on 08-02-26 @ 17:12:35
;
```

## chg-secu-trm

## Change Terminal Access Rights

Use this command to configure the access rights for a terminal. Only a user with system security administration authority can change a terminal's access rights. Access rights determine whether a terminal or port has command access to the system for the different command classes.

**Keyword:** chg-secu-trm  
**Related Commands:** rtrv-secu-trm  
**Command Class:** Security Administration

## Parameters

**NOTE: As of Release 40.1 the `lnpbas` parameter is no longer available.**

**:trm=** (mandatory)

Terminal ID. This parameter specifies the port to be configured.

**Range:** 1-16

**:all=** (optional)

All non-configurable command classes. This parameter specifies whether to configure all of the command classes.

**Range:** yes, no

**Default:** Current value

**System**

**Default:** no

**:cc1=** (optional)

This parameter specifies a configurable command class name (*ayy*), and an indicator (**-yes** or **-no**) stating whether the command class is allowed for the specified terminal. The parameter value is specified in the format *ayy -yes* or *ayy -no*.

**Range:** *ayy*

1 alphabetic character followed by 2 alphanumeric characters.

A dash and the indicator value follow the command class name:

**-no**—This command is not allowed for the specified terminal.

**-yes**—This command is allowed for the specified terminal.

**:cc2=** (optional)

Configurable command class name (*ayy*), and an indicator **-yes** or **-no** to specify whether the command class is allowed or not allowed for the specified terminal. The parameter value is specified in the format *ayy -yes* or *ayy -no*.

**Range:** *ayy*

1 alphabetic character followed by 2 alphanumeric characters.

A dash and the indicator value follow the command class name:

**-no**—This command is not allowed for the specified terminal.

**-yes**—This command is allowed for the specified terminal.

**:cc3=** (optional)

Configurable command class name (*ayy*), and an indicator **-yes** or **-no** to specify whether the command class is allowed or not allowed for the specified terminal. The parameter value is specified in the format *ayy -yes* or *ayy -no*.

**Range:** *ayy*

1 alphabetic character followed by 2 alphanumeric characters.

A dash and the indicator value follow the command class name:

**-no**—This command is not allowed for the specified terminal.

**-yes**—This command is allowed for the specified terminal.

**:cc4=** (optional)

Configurable command class name (*ayy*), and an indicator **-yes** or **-no** to specify whether the command class is allowed or not allowed for the specified terminal. The parameter value is specified in the format *ayy -yes* or *ayy -no*.

**Range:** *ayy*

1 alphabetic character followed by 2 alphanumeric characters.

A dash and the indicator value follow the command class name:

**-no**—This command is not allowed for the specified terminal.

**-yes**—This command is allowed for the specified terminal.

**:cc5=** (optional)

Configurable command class name (*ayy*), and an indicator **-yes** or **-no** to specify whether the command class is allowed or not allowed for the specified terminal. The parameter value is specified in the format *ayy -yes* or *ayy -no*.

**Range:** *ayy*

1 alphabetic character followed by 2 alphanumeric characters.

A dash and the indicator value follow the command class name:

**-no**—This command is not allowed for the specified terminal.

**-yes**—This command is allowed for the specified terminal.

**:cc6=** (optional)

Configurable command class name (*ayy*), and an indicator **-yes** or **-no** to specify whether the command class is allowed or not allowed for the specified terminal. The parameter value is specified in the format *ayy -yes* or *ayy -no*.

**Range:** *ayy*

1 alphabetic character followed by 2 alphanumeric characters.

A dash and the indicator value follow the command class name:

**-no**—This command is not allowed for the specified terminal.

**-yes**—This command is allowed for the specified terminal.

**:cc7=** (optional)

Configurable command class name (*ayy*), and an indicator **-yes** or **-no** to specify whether the command class is allowed or not allowed for the specified terminal. The parameter value is specified in the format *ayy -yes* or *ayy -no*.

**Range:** *ayy*

1 alphabetic character followed by 2 alphanumeric characters.

A dash and the indicator value follow the command class name:

**-no**—This command is not allowed for the specified terminal.

**-yes**—This command is allowed for the specified terminal.

**:cc8=** (optional)

Configurable command class name (*ayy*), and an indicator **-yes** or **-no** to specify whether the command class is allowed or not allowed for the specified terminal. The parameter value is specified in the format *ayy -yes* or *ayy -no*.

**Range:** *ayy*

1 alphabetic character followed by 2 alphanumeric characters.

A dash and the indicator value follow the command class name:

**-no**—This command is not allowed for the specified terminal.

**-yes**—This command is allowed for the specified terminal.

**:db=** (optional)

Database Administration class. Specifies whether the Database Administration class of commands is allowed.

**Range:** **yes, no**

**Default:** Current value

**System****Default:** no**:dbg=** (optional)

Debug class. Specifies whether the Debug class of commands is allowed.

**Range:** yes, no**Default:** Current value**System****Default:** no**:link=** (optional)

Link Maintenance class. Specifies whether the Link Maintenance class of commands is allowed.

**Range:** yes, no**Default:** Current value**System****Default:** no**:pu=** (optional)

Program Update class. Specifies whether the Program Update class of commands is allowed.

**Range:** yes, no**Default:** Current value**System****Default:** no**:sa=** (optional)

Security Administration class. Specifies whether the Security Administration class of commands is allowed.

**Range:** yes, no**Default:** Current value**System****Default:** no**:sys=** (optional)

System Maintenance class. Specifies whether the System Maintenance class of commands is allowed.

**Range:** yes, no**Default:** Current value**System****Default:** no**:lnpbas=** (obsolete)

LNP Basic class. Specifies whether the LNP Basic class of commands is allowed.

**Range:** yes, no**Default:** Current value**System****Default:** no**Example****chg-secu-trm:trm=3:all=yes****chg-secu-trm:trm=3:sys=yes:cc1=u04-no:cc3=u11=yes****Dependencies**

This command is not supported on telnet terminals (terminal IDs 17-40).

At least one optional parameter must be specified.

Access rights for a terminal cannot be changed while a user is logged on to that terminal.

At least two terminal ports must be configured to have security administration authority.

The Command Class Management feature must be enabled before configurable command class name parameters (**cc1**, **cc2**, **cc3**, **cc4**, **cc5**, **cc6**, **cc7**, **cc8**) can be specified.

The value specified for a configurable command class name must be a default or provisioned command class name in the CCNAMES table.

If the **all** parameter is specified and any of the individual command classes are also specified, the individual command classes take precedence.

If the **all=yes** parameter is specified, but the LNP feature is not turned on, the **lnpbas** parameter defaults to a **no** value.

**Notes**

Up to 8 configurable command class name parameters can be entered in one command. Additional commands can be entered to change access rights for more than 8 names. To change access rights for all 32 available configurable command class names, four commands could be entered with 8 names specified in each command.

Security Administration ports whose terminal port type has been configured with a value of **oap**, **none**, or **printer** do not allow commands to be entered. Because commands cannot be entered from terminals attached to these ports, they are not considered as ports configured for security administration authority.

**Output**

```

chg-secu-trm:trm=3:all=yes
rlghncxa03w 04-01-15 12:30:04 EST EAGLE 31.3.0
Command entered at terminal #13.

rlghncxa03w 04-01-15 12:30:07 EST EAGLE 31.3.0
CHG-SECU-TRM: MASP A - COMPLTD
;
    
```

**chg-sg-opts**

**Change IP**

Use this command to change the IP<sup>7</sup> Secure Gateway protocol options.

**Keyword:** chg-sg-opts  
**Related Commands:** rtrv-sg-opts  
**Command Class:** Database Administration

**Parameters**

**:getcomm=** (optional)  
 This parameter specifies the community name to use for SNMP Get and GetNext request validations. This value applies for each SSED CM SNMP agent in the system.

**Range:** ~~~~~  
 Any string up to 32 characters in length  
 If the string contains characters other than alphanumeric characters, the entire string must be enclosed in single quotes ( ' ').  
 The string can be entered in upper and lower case; the system converts upper case alphabetic characters to lower case.

**Default:** Current value  
**System**  
**Default:** public

**:ipgwabate=** (optional)

Enable or disable IPGWx SS7 congestion abatement procedures. This parameter specifies whether the TFC is forwarded to the system's true point code, to allow MSUs to be discarded as part of abatement procedures on all cards running the IPGWx application. When set to **yes**, the system will maintain and abate congestion on behalf of IPGWx-connected nodes.

**Range:** **yes, no**

**Default:** Current value

**System**

**Default:** **no**

**:iplimabate=** (optional)

Enable or disable IPLIMx SS7 congestion abatement procedures. This parameter specifies whether the TFC is forwarded to the system's true point code, to allow MSUs to be discarded as part of abatement procedures on all cards running the IPLIMx application. When set to **yes**, the system will maintain and abate congestion on behalf of IPLIMx/M3UA signaling links.

**:setpcsum=** (optional)

This parameter specifies the configured SCTP checksum algorithm for the node.

**Range:** **adler32, crc32c, percard**

**percard**—The system-wide SCTP checksum algorithm type is turned off, and the SCTP checksum algorithm can be configured on a per-card basis.

**Default:** Current value

**System**

**Default:** **percard**

**:setcomm=** (optional)

This parameter specifies the community name to use for SNMP set request validations. This value applies for each SSED CM SNMP agent in the system.

**Range:** ~~~~~

Any string up to 32 characters in length.

If the string contains characters other than alphanumeric characters, the entire string must be enclosed in single quotes ( ' ').

The string can be entered in upper and lower case; the system converts upper case alphabetic characters to lower case.

**Default:** Current value

**System**

**Default:** **private**

**:snmpcont=** (optional)

This parameter specifies the system contact information for each DCM SNMP agent in the Secure Gateway. This value is used to define the sysContact object in the SNMP MIB II System Group (OID 1.3.6.1.2.1.1.4).

**Range:** ~~~~~

Any string of up to 64 characters.

If the string contains characters other than alphanumeric characters, the entire string must be enclosed in single quotes ( ' -TO ).

The string can be entered in upper and lower case; the system converts upper case alphabetic characters to lower case.

**Default:** Current value

**System**

**Default:** **tekelec**





The **srkq** parameter value must be greater than or equal to the current number of static routing key entries. Attempts to decrease the **srkq** value below the actual current number of static routing key entries are not allowed.

The total number of the **srkq** value cannot exceed 2500 for SSEDCEM or E5-ENET cards running the **ss7ipgw** or **ipgwi** application.

The total number of actual routing keys cannot not exceed 2500 per card.

### Notes

The following conditions must be satisfied when changing routing key quantity assignments.

1. Total number if **srkq** cannot exceed 2500. The total number of routing keys per card on any SS7IPGW card (as reported by the **rept-stat-rtkey** command) cannot exceed 2500.
2. If **s** is the current maximum number of actual static routing keys, then **srkq** must be  $\geq s$ . Attempts to decrease **srkq** below **s** are not allowed.

The SCTP checksum algorithm affects the IPLIMx, IPGWx, and IPSG cards under the following conditions:

- All associations on the card are in the **open=no** state.
- No associations are provisioned on the card

If neither condition is true, the card raises minor alarm (UAM 298) under the following scenarios:

- The system-wide SCTP checksum algorithm is configured to a different value than the active SCTP checksum algorithm on the card.
- The system-wide SCTP checksum algorithm is set to **percard**, and the per-card setting is different than the active SCTP checksum algorithm on the card.

The alarm is cleared (UAM 299), and the SCTP checksum algorithm takes effect when all associations on the card are set to **open=no** or when the card is reset.

### Output

```
chg-sg-opts:sctpcsum=percard
tekelecstp 08-02-22 17:56:31 EST EAGLE 38.0.0
CHG-SG-OPTS: MASP A - COMPLTD
;
```

## chg-sid

### Change Self Identification

Use this command to change the self-identification of the system. The self-identification identifies the system to the other signaling points in the network.



**CAUTION:** Use this command only during periods of low traffic. If you use the **chg-sid** command to change the point code, then the change does not become enabled until you initialize (**init-sys**) the system.

**NOTE:** If you use the **chg-sid** command to change the capability point code, then you do not need to initialize the system for the change to become enabled.



**CAUTION:** Changing a SID impacts all adjacent nodes that reference the SID. Both sides must be changed at the same time, or the signaling link test messaging will fail, and the links will go down.

**Keyword:** chg-sid  
**Related Commands:** ent-sid, rtrv-sid  
**Command Class:** Database Administration

### Parameters

**NOTE:** See "Point Code Formats and Conversion" for a detailed description of point code formats, rules for specification, and examples.



**CAUTION:** If there are STC cards in the system for the EAGLE 5 Integrated Monitoring Support (E5IS) feature, you must turn off the EIS copy function (see the chg-eisopts command) before you change the system CLLI. When the CLLI change is complete, use the chg-eisopts command to turn on the EIS copy function again.

**:cli=** (optional)

Common language location identifier. This parameter, which must be unique, identifies the system in terms of its physical location:

- The first four characters identify the city, town, or locality.
- The fifth and sixth characters identify state or province.
- The seventh and eighth characters identify the building.
- The last three characters identify the traffic unit.

**Range:** ayyyyyyyyyy  
 1 alphabetic character followed by up to 10 alphanumeric characters  
 The value **none** is invalid for the CLLI.

**Default:** Current value.

**:cpc=** (optional)

ANSI capability point code with subfields *network indicator-network cluster-network cluster member (ni-nc-ncm)*.

**Synonym:** cpc

**Range:** 000-255  
 Specify a valid value for each subfield of the point code, and separate the subfields with a dash (-).  
 When **chg-sid:pctype=ansi** is specified, *ni* = 000 is not valid.  
 When **chg-sid:pctype=ansi** is specified, *nc* = 000 is not valid if *ni* = 001–005.  
 When **chg-sid:pctype=ansi** is specified, *nc* = 000 is valid if *ni* = 006–255.  
 The point code 000-000-000 is not a valid point code.

**:cpc/cpca/cpci/cpcn/cpcn24=** (optional)

Capability point code. The code used by the SS7 protocol to identify a group of functionally related STPs in the signaling network to which the STP belongs.

**:cpci=** (optional)

ITU international point code with subfields *zone-area-id*. The *prefix* subfield indicates a spare point code (*prefix-zone-area-id*).

**Range:** s-, 0-255  
 Specify a valid value for each subfield of the point code, and separate the subfields with a dash (-).  
*prefix—s-*

*zone*—**0-7**

*area*—**000-255**

*id*—**0-7**

The point code **0-000-0** is not a valid point code.

**Default:** No change to existing point code value.

**:cpcn=** (optional)

ITU national point code in the format of a 5-digit number (*nnnnn*); or 2, 3, or 4 numbers (members) separated by dashes (*m1-m2-m3-m4*) as defined by the **chg-stpopts:npcfmti** flexible point code option. A group code must be specified when the ITUDUPPC feature is turned on (*nnnnn-gc*, *m1-m2-m3-m4-gc*). The *prefix* subfield indicates a spare point code (*prefix-nnnnn*, *prefix-nnnnn-gc*, *prefix-m1-m2-m3-m4*, *prefix-m1-m2-m3-m4-gc*).

**Range:** **s-, 0-16383, aa-zz**

Specify a valid value for each subfield of the point code, and separate the subfields with a dash (-).

*prefix*—**s-**

*nnnnn*—**0-16383**

*gc*—**aa-zz**

*m1-m2-m3-m4*—**0-14** for each member; values must sum to 14

**Default:** No change to existing point code value.

**:cpcn24=** (optional)

24-bit ITU national point code with subfields *main signaling area-sub signaling area-signaling point* (*msa-ssa-sp*).

**Range:** **000-255**

Specify a valid value for each subfield of the point code, and separate the subfields with a dash (-).

*msa*—**000-255**

*ssa*—**000-255**

*sp*—**000-255**

**Default:** No change to existing point code value.

**:cpctype=** (optional)

Capability point code type. Specify whether the capability point code is for the STP or for the LNP, INP, EIR (Equipment Identity Register), G-Port, G-Flex, V-Flex, MNP, or ATINPQ service.

The **cpctype** parameter is used to associate a specific service or capability (for example, Local Number Portability Query Response and Message Relay service) with one or more of the capability point codes. This parameter cannot be changed after it is assigned.

**Range:** **lnp, stp, inp, eir, gport, gflex, mnp, atinpq, vflex**

**lnp**— Local Number Portability

**stp**— EAGLE 5 ISS

**inp**— INAP-based Number Portability

**eir**— Equipment Identity Register

**gport**— G-Port (GSM Mobile Number Portability)

**gflex**— G-Flex (GSM Flexible Numbering)

**mnp**— Mobile Number Portability

**atinpq**— ATI Number Portability Query

**vflex**— Voice Mail Router

**Default:** **stp**

**:npc=** (optional)

New ANSI capability point code with subfields *network indicator-network cluster-network cluster member* (*ni-nc-ncm*).

**Synonym:** **npca**

**Range:** **000-255, none**

Specify a valid value for each subfield of the point code, and separate the subfields with a dash (-).

When **chg-sid:pctype=ansi** is specified, *ni* = **000** is not valid.

When **chg-sid:pctype=ansi** is specified, *nc* = **000** is not valid if *ni* = **001-005**.

When **chg-sid:pctype=ansi** is specified, *nc* = **000** is valid if *ni* = **006-255**.

Enter **none** to delete the point code.

The point code **000-000-000** is not a valid point code.

**Default:** No change to existing point code value.

**:npc/npc/npci/npcn/npcn24=** (optional)

New capability point code. Use new CPCs to replace or delete existing CPCs.

**:npci=** (optional)

ITU international point code with subfields *zone-area-id*. The *prefix* subfield indicates a spare point code (*prefix-zone-area-id*).

**Range:** **s-, 0-255, none**

Specify a valid value for each subfield of the point code, and separate the subfields with a dash (-).

*prefix*—**s-**

*zone*—**0-7**

*area*—**000-255**

*id*—**0-7**

Enter **none** to delete the point code.

The point code **0-000-0** is not a valid point code.

**Default:** No change to existing point code value.

**:npcn=** (optional)

New ITU national point code in the format of a 5-digit number (*nnnnn*); or 2, 3, or 4 numbers (members) separated by dashes (*m1-m2-m3-m4*) as defined by the **chg-stpopts:npcfnti** flexible point code option. A group code must be specified when the ITUDUPPC feature is turned on (*nnnnn-gc*, *m1-m2-m3-m4-gc*). The *prefix* subfield indicates a spare point code (*prefix-nnnnn*, *prefix-nnnnn-gc*, *prefix-m1-m2-m3-m4*, *prefix-m1-m2-m3-m4-gc*).

**Range:** **s-, 0-16383, aa-zz, none**

Specify a valid value for each subfield of the point code, and separate the subfields with a dash (-).

*prefix*—**s-**

*nnnnn*—**0-16383**

*gc*—**aa-zz**

*m1-m2-m3-m4*—**0-14** for each member; values must sum to 14

Enter **none** to delete the point code.

**Default:** No change to existing point code value.

**:npcn24=** (optional)

New 24-bit ITU national point code with subfields *main signaling area-sub signaling area-signaling point (msa-ssa-sp)*.

**Range:** 000-255, none

Specify a valid value for each subfield of the point code, and separate the subfields with a dash (-).

*msa*—000-255

*ssa*—000-255

*sp*—000-255

Enter **none** to delete the point code.

**Default:** No change in point code value.

**:npci=** (optional)

New STP ITU international point code with subfields *zone-area-id*. The *prefix* subfield indicates a spare point code (*prefix-zone-area-id*).

**Range:** s-, 0-255, none

Specify a valid value for each subfield of the point code, and separate the subfields with a dash (-).

*prefix*—s-

*zone*—0-7

*area*—000-255

*id*—0-7

Enter **none** to delete the point code.

The point code **0-000-0** is not a valid point code.

**none**—deletes the existing spare ITU-I self ID point code

**Default:** No change to existing point code value.

**:npci/npcn=** (optional)

New STP ITU national or international point code.

**:npcn=** (optional)

New STP ITU national point code in the format of a 5-digit number (*nnnnn*); or 2, 3, or 4 numbers (members) separated by dashes (*m1-m2-m3-m4*) as defined by the **chg-stpopts:npcfnti** flexible point code option. A group code must be specified when the ITUDUPPC feature is turned on (*nnnnn-gc*, *m1-m2-m3-m4-gc*). The *prefix* subfield indicates a spare point code (*prefix-nnnnn*, *prefix-nnnnn-gc*, *prefix-m1-m2-m3-m4*, *prefix-m1-m2-m3-m4-gc*).

**Range:** s-, 0-16383, aa-zz, none

Specify a valid value for each subfield of the point code, and separate the subfields with a dash (-).

*prefix*—s-

*nnnnn*—0-16383

*gc*—aa-zz

*m1-m2-m3-m4*—0-14 for each member; values must sum to 14

Enter **none** to delete the point code.

**none**—deletes the existing spare ITU-N self ID point code

**Default:** No change to existing point code value.

**:pc=** (optional)

ANSI STP point code with subfields *network indicator-network cluster-network cluster member (ni-nc-ncm)*.

**Synonym:** *pca***Range:** 000-255

Specify a valid value for each subfield of the point code, and separate the subfields with a dash (-).

When **chg-sid:pctype=ansi** is specified, *ni = 000* is not valid.

When **chg-sid:pctype=ansi** is specified, *nc = 000* is not valid if *ni = 001-005*.

When **chg-sid:pctype=ansi** is specified, *nc = 000* is valid if *ni = 006-255*.

The point code **000-000-000** is not a valid point code.

**:pc/pca/pci/pcn/pcn24=** (optional)

STP point code.

**:pci=** (optional)

ITU international point code with subfields *zone-area-id*. The *prefix* subfield indicates a spare point code (*prefix-zone-area-id*).

**Range:** s-, 0-255

Specify a valid value for each subfield of the point code, and separate the subfields with a dash (-).

*prefix*—s-*zone*—0-7*area*—000-255*id*—0-7

The point code **0-000-0** is not a valid point code.

**Default:** No change in point code value.**:pcn=** (optional)

ITU national point code in the format of a 5-digit number (*nnnnn*); or 2, 3, or 4 numbers (members) separated by dashes (*m1-m2-m3-m4*) as defined by the **chg-stpopts:npcfmti** flexible point code option. A group code must be specified when the ITUDUPPC feature is turned on (*nnnnn-gc*, *m1-m2-m3-m4-gc*). The *prefix* subfield indicates a spare point code (*prefix-nnnnn*, *prefix-nnnnn-gc*, *prefix-m1-m2-m3-m4*, *prefix-m1-m2-m3-m4-gc*).

**Range:** s-, 0-16383, aa-zz

Specify a valid value for each subfield of the point code, and separate the subfields with a dash (-).

*prefix*—s-*nnnnn*—0-16383*gc*—aa-zz*m1-m2-m3-m4*—0-14 for each member; values must sum to 14**Default:** No change in point code value.**:pcn24=** (optional)

24-bit ITU national point code with subfields *main signaling area-sub signaling area-signaling point* (*msa-ssa-sp*).

**Range:** 000-255

Specify a valid value for each subfield of the point code, and separate the subfields with a dash (-).

*msa*—000-255*ssa*—000-255*sp*—000-255

**Default:** No change in point code value.

**:pctype=** (optional)

The type of point code. The **pctype** parameter does not affect ITU destinations.

**Range:** **ansi, other**

**ansi**—Supports point codes that meet the ANSI standard

**other**—Supports point codes that do not meet the ANSI standard.

**Default:** The point code type is not changed.

### Example

To change the site identification PCTYPE to ANSI:

```
chg-sid:pctype=ANSI
```

To change the site identification CLLI to rlghncxa03w:

```
chg-sid:clli=rlghncxa03w
```

To add a new ANSI capability point code:

```
chg-sid:cpc=002-002-002
```

To delete an ITU-I capability point code:

```
chg-sid:cpci=2-003-4:ncpci=none
```

To change an existing ITU-N capability point code, 01234, to 02092: (The existing CPC is replaced with the new CPC.)

```
chg-sid:cpcn=01234:ncpcn=02092
```

To add a new ANSI LNP CPC:

```
chg-sid:cpc=002-002-002:cpctype=lnp
```

To change an existing ITU-N capability point code with a group code of 01234-aa to 02092-si: (The existing CPC is replaced with the new CPC.)

```
chg-sid:cpcn=01234-aa:ncpcn=02092-si:cpctype=stp
```

To add an ITU national INP CPC:

```
chg-sid:cpcn=04567:cpctype=inp
```

To change the ITU-N 24-bit site identification STP Point Code when no previous ITU-N site identification STP point code exists:

```
chg-sid:pcn24=1-101-1
```

To change the ITU-N site identification STP Point Code when a previous ITU-N site identification STP point code exists:

```
chg-sid:pcn=11111:ncpcn=none
```

```
chg-sid:pcn24=1-101-1
```

To add a new ITU-N 24-bit Capability Point Code:

```
chg-sid:cpcn24=22-22-22
```

To change an existing 24-bit ITN-N Capability Point Code 22-22-22 to 33-33-33.

```
chg-sid:cpcn24=22-22-22:ncpcn24=33-33-33
```

To add a new EIR-type Capability Point Code:

```
chg-sid:cpctype=eir:cpci=2-30-1
```

```
chg-sid:cpctype=eir:cpcn=123
```

To delete an existing ITUI Capability Spare Point Code:

```
chg-sid:cpci=s-2-003-4:ncpci=none
```



To change an existing node ITU-I spare true point code from an assigned point code value to none:

```
chg-sid:pci=s-1-234-5:npci=none
```

To change an existing ITU-N spare capability point code from s-01234 to s-02092. The existing CPC is replaced with the new CPC:

```
chg-sid:cpcn=s-01234:ncpcn=s-02092:cpctype=stp
```

To change or add new node true point codes simultaneously, for multiple point code types:

```
chg-sid:pca=111-111-111:pci=1-234-5:pcn=12345
```

```
chg-sid:pca=111-111-111:pci=1-234-5:pcn24=233-255-255
```

To change or add new node true point codes simultaneously, for ITU-I spare and ITU-N spare point code types.

```
chg-sid:pci=s-1-234-5:pcn=s-12345
```

To change an existing node ITU-N spare true point code from an assigned point code value to none:

```
chg-sid:pcn=s-12345:npcn=none
```

To change the CPC list to include an ANSI CPC for the G-Port service:

```
chg-sid:cpc=1-2-3:cpctype=gport
```

To change the CPC list to include an ITU-I CPC for the G-Flex service:

```
chg-sid:cpci=2-3-4:cpctype=gflex
```

To change the ITU-N site identification STP Point Code when a previous ITU-N site identification STP point code does not exist:

```
chg-sid:pcn=11112
```

To change the CPC list to include an ANSI CPC for the ATINPQ service:

```
chg-sid:cpc=3-4-6:cpctype=atinpq
```

To change the CPC list to include an ITU-I CPC for the ATINPQ service:

```
chg-sid:cpci=1-2-4:cpctype=atinpq
```

## Dependencies

At least one optional parameter must be specified.

The Spare Point Code Support feature must be enabled before a spare point code (prefix **s-**) can be specified in the command.

The value specified for the **pcn**, **cpcn**, or **npcn** parameter must be a full point code.

The STP destination and capability point codes can be specified only as full point codes or **none**.

If the **npci**, **npcpa**, **npci**, **npcn**, or **npcn24** parameter is specified, a corresponding existing **cpc**, **cpcpa**, **cpci**, **cpcn**, or **cpcn24** parameter must be specified.

If the **npci** parameter or the **npcn** parameter is specified, a corresponding existing **pci** parameter value or **pcn** parameter value must be specified.

If the **cpctype** parameter is specified, the **cpc**, **cpcpa**, **cpci**, **cpcn**, or **cpcn24** parameter must be specified.

If the **cpctype** parameter is specified, an **npci**, **npcpa**, **npci**, **npcn**, or **npcn24** parameter cannot be specified in the command.

The values of the **pc/pca/pci/pcn/pcn24**, **cpc/cpcpa/cpci/cpcn/cpcn24**, and **npc/npcpa/npci/npcn/npcn24** parameters cannot be equal.

The STP capability point code type (domain) must match the new STP capability point code type (domain).

If the **cpctype=lnp** parameter is specified, then the **cpc/cpca** parameter must be specified with an ANSI point code value.

If the **cpctype=inp** parameter or the **cpctype=eir** parameter is specified, the **cpc** parameter and the **cpca** parameter cannot be specified for the point code. An ANSI point code cannot be specified.

The LNP feature must be on before the **cpctype=lnp** parameter can be specified (see the **enable-ctrl-feat** command).

**NOTE: The LNP feature is "turned on" when a value is shown for the LNP ported TNs quantity in the rtrv-ctrl-feat command output.**

The INP feature must be on before the **cpctype=inp** parameter can be specified.

The EIR feature must be on before the **cpctype=eir** parameter can be specified.

Only the **pcn** parameter or the **pcn24** parameter can be specified; however, both parameters cannot be specified in the same command.

If a 14-bit ITU-N site ID exists, then a 24-bit ITU-N site ID cannot be assigned. If a 24-bit ITU-N site ID exists, then a 14-bit ITU-N site ID cannot be assigned.

Only one new point code parameter (**npc**, **npcp**, **npcpa**, **npci**, **npcn**, or **npcn24**) can be specified.

If the **pcn**, **npcn**, **cpca**, or **npcn** parameter is specified, the format must match the format that was assigned with the **chg-stpopts:npfmt** parameter.

The site CLLI code that is specified in the command cannot be the same as an existing route destination CLLI code.

The STP capability point code that is specified in the command cannot be the same as an existing STP capability point code.

The new STP capability point code that is specified in the command cannot be the same as an existing STP capability point code.

If the system is configured for ANSI format point codes, the specified network indicator value (*ni*) of the **pc**, **cpc**, or **npc** parameter must be **6** or greater when the specified cluster value (*nc*) is **0**.

The true point code and capability point codes cannot be the same as existing secondary point codes.

The existing true point code cannot be changed if it is in the MAP table.

The maximum number of capability point codes that can be provisioned is 96.

If the existing spare ITU-I or spare ITU-N point code is an STP destination point code, then the **npci=none** or **npcn=none** parameter (respectively) cannot be specified.

The parameter value **none** cannot be specified for the **cpc**, **cpca**, **npci**, **npcn**, and **npcn24** parameters.

The STP destination point code that is specified in the command cannot be the same as an existing route **dpc** or **cpc**.

The new STP capability point code that is specified in the command cannot be the same as the STP destination point code.

The specified **npci** or **npcn** parameter value must already exist as an STP destination point code.

If the **npc/npcpa/npci/npcn/npcn24** parameter is specified, then the **cpc/cpca/npci/npcn/npcn24** must be specified.

The G-Flex feature must be turned on to change the capability point code if the **cpctype=gflex** parameter is specified.

The G-Port feature must be enabled before the **cpctype=gport** parameter can be specified.

If the A-Port or the IS41 GSM Migration (IGM) feature is not enabled, the **cpctype=mnp** parameter cannot be specified.

If the A-Port or IGM feature is enabled, the **cpctype=gport** parameter cannot be specified.

Could not add or change the (new) capability point code to the list due to software error.

The ATINP feature must be enabled before the **cpctype= atinpq** parameter can be specified.

If the **cpctype=atinpq** parameter is specified, then the **pcpn24** parameter cannot be specified.

The V-Flex feature must be turned on before the **cpctype=vflex** parameter can be specified.

## Notes

If one of the **pc/pca/pci/pcn/pcn24** parameters is specified to change the point code, the following message is displayed:

```
CAUTION: SYSTEM SITE ID HAS BEEN CHANGED, MANUAL RE-INITIALIZATION IS  
NEEDED
```

If the redirect function refers to any of the **pc/pca** or **cpc/cpca** parameters, the following message is displayed:

```
CAUTION: SYSTEM SITE ID WAS REFERENCED BY THE REDIRECT FUNCTION'S DPC
```

To update the OAP configuration, use the **act-oap-config** command.

In order for the change to be fully implemented, you must enter the **init-sys** command. This initializes the entire system system, and reloads all LIMs with the new self ID.

Only one ITU-N Site ID point code can be defined at one time (**pcn** or **pcn24**). To change from one to the other, the current Site ID must be disabled before the new one can be defined.

When the **cpctype=lnp** parameter is specified, it associates a specific service or capability (for example, local number portability query response and message relay service) with one or more of the capability point codes.

After the **cpctype** is defined, it cannot be changed.

For initial installation of a system, the self point code must be entered before any destination is entered.

In this command, only ITU-international and ITU national point codes support the spare point code subtype prefix (**s-**).

When the Site ID is changed, manual initialization is required because an MSU can be in transition between a link card and an SCCP card at the time the SID table is changed. In that case, it is possible for the Destination True Point Code to no longer appear to belong to the STP node, and SCCP would not know what to do with it. The following message is displayed:

```
CAUTION: SYSTEM SITE ID HAS BEEN CHANGED, MANUAL RE-INITIALIZATION IS  
NEEDED
```

The **chg-sid** command is used to identify the STP in the signaling network. STP identity is determined by the Common Language (CLLI) code and the SS7 Destination/True Point Code (DPC). For MTP message discrimination, the STP can also be identified by one or more optional capability codes representing service-related SCCP capabilities resident at the STP.

The CLLI and DPC are used as paired key fields in SEAS to uniquely identify the STP and all SEAS interactions with that STP. This command is viewed as the first command to be used in provisioning a newly commissioned STP or an STP that is being reactivated in a new location or at a new network address.

The **chg-sid** command can also be used to add capability codes to the existing set for that STP after the CLLI and DPC have been initialized. Alternatively, the STP CLLI and DPC can be provisioned locally during installation, and the command used only to add new capability codes. The STP's own CLLI must be provisioned before SEAS-STP communication, in order to support UAL-level interactions.

If the **chg-sid** command is used to change only the capability point code, then the system does not need to be initialized to enable the change.

The **cpctype=vflex** parameter is used to support incoming messages (DPC = CPC) that are routed through Final GTT to the EAGLE 5 ISS V-Flex subsystem.

If the CLI of the system is entered or changed with the **chg-sid** command, and the SEAS Over IP feature is turned on, then the CCS MR configuration must be changed to include the new EAGLE 5 ISS CLI value. The following warning message appears:

CAUTION: System CLI has changed, CCSMR re-configuration required

The **cpctype=vflex** parameter is used to support incoming messages (DPC = CPC) that are routed through Final GTT to the EAGLE 5 ISS V-Flex subsystem.

## Output

```
chg-sid:pc=10-20-30
rlghncxa03w 04-01-07 09:17:40 EST EAGLE 31.3.0
CHG-SID: MASP A - COMPLTD
;
```

## chg-slt

## Change Signaling Link Test Message

Use this command to change the fields of a signaling link test message (SLTM) record in the SLTM table.

**Keyword:** **chg-slt**

**Related Commands:** **chg-l3t, ent-ls, rtrv-ls, rtrv-slt**

**Command Class:** Database Administration

## Parameters

**:sltset=** (mandatory)

The signaling link test message record number in the SLTM table.

**Range:** **1-20**

**:enabled=** (optional)

Enables the signaling link test message.

**Range:** **on, off**

**Default:** Current value.

**:mode=** (optional)

The *SLTM* mode to be used when sending test messages.

**Range:** **special, regular**

**special**—All SLTMs generated by the links in the linkset associated with this SLTM record are designated “special” maintenance messages.

**regular**—All SLTMs generated by the links in the linkset associated with this SLTM record are designated “regular” maintenance messages.

**Default:** Current value.

**:pattern=** (optional)

The test pattern to be sent with a signaling link test message.

**Range:** *aaaaaaaaaaaaaaaaaaaaaaaaaaaaaaaa*

2 to 30 alphanumeric characters; valid characters are **0-9, a-f, A-F**.

An even number of characters must be used in the pattern. The first two characters of the pattern must be letters.

**Default:** Current value.

**:t1=** (optional)

Timer 1. After an SLTM test fails, this parameter specifies the amount of time, in milliseconds, to wait before running the SLTM test again.

**Range:** 4000-12000

**Default:** Current value.

**:t2=** (optional)

Timer 2. This parameter specifies the amount of time, in milliseconds, that should pass between running SLTM tests for a normally functioning signaling link.

**Range:** 30000-90000

**Default:** Current value.

### Example

```
chg-slt:sltset=1:t1=4000:t2=39000:enabled=off:pattern=aabbccdd
```

### Dependencies

The value of **t1** should be greater than the level 3 timer **t6**. The level 3 timer **t6** can be **100 to 2000** milliseconds. Enter the **rtrv-l3t** command to verify the value of the level 3 timer **t6**.

### Notes

None

### Output

```
chg-slt:sltset=1:t1=4000:t2=39000:enabled=off:pattern=aabbccdd
```

```
rlghncxa03w 04-01-07 00:21:41 EST EAGLE 31.3.0
```

```
CHG-SLT: MASP A - COMPLTD
```

```
;
```

## chg-srvsel

## Change Service Selector

Use this command to assign the applicable service selectors required to change a service entry for DSM services.

**Keyword:** chg-srvsel

**Related Commands:** dlt-srvsel, ent-srvsel, rtrv-srvsel

**Command Class:** Database Administration

### Parameters

**:gti/gtia/gtii/gtin/gtin24=** (mandatory)

Global title indicator. For all service selector commands, the domain is defined as **gti** and **gtia** (ANSI), **gtii** (ITU international), **gtin** (ITU national) and **gtin24** (24-bit ITU national). For the service selector commands, **gti** and **gtia** are equivalent.

**Range:** Supported value for ANSI: **gti=2** and **gtia=2**

Supported values for ITU: **gtii=2, 4; gtin=2, 4; gtin24=2, 4**

**:ssn=** (mandatory)

Subsystem number.

**Range:** 0-255 \*

**:tt=** (mandatory)

Translation type.

**Range:** 0-255

**:nai=** (optional)

Nature of address indicator. The nature of address indicator can be specified by a mnemonic value (**nai** parameter) or an explicit numeric value (**naiv** parameter). Either the **nai** parameter or the **naiv** parameter, but not both, can be specified. Table A-5 shows the mapping between the **naiv** and the **nai** parameter values.

**Range:** sub, rsvd, natl, intl

**Default:** Current value

**:naiv=** (optional)

Nature of address indicator value.

**Range:** 0-127

The Nature of Address Indicator parameters (**naiv** or **nai**) can be specified by supplying either a mnemonic or an explicit value. At no time can both the mnemonic and the explicit value be specified at the same time in the same command. Either the **naiv** or **nai** parameter can be specified. Table x shows the mapping between the **naiv** and **nai** parameters.

**Table 5-31.** NAIV/NAI Mapping

NAIV	NAI	Description
0	–	Unknown
1	sub	Subscriber Number
2	rsvd	Reserved for national use
3	natl	National significant number
4	intl	International number
5-127	–	Spare

**:naiv=** (optional)

Nature of address indicator value. The nature of address indicator can be specified by a mnemonic value (**nai** parameter) or an explicit numeric value (**naiv** parameter). Either the **nai** parameter or the **naiv** parameter, but not both, can be specified. Table A-5 shows the mapping between the **naiv** and the **nai** parameter values.

**Range:** 0-127

**Default:** Current value.

**:np=** (optional)

Numbering plan. The numbering plan can be specified by a mnemonic value (**np** parameter) or an explicit numeric value (**npv** parameter). Either the **np** parameter or the **npv** parameter, but not both, can be specified. Table A-6 shows the mapping between the **npv** and the **np** parameter values.

**Range:** e164, generic, x121, f69, e210, e212, e214, private

**Default:** Current value

**:npv=** (optional)

Numbering plan value.

**Range:** 0-15

The numbering plan parameters (**npv** or **np**) can be specified by supplying either a mnemonic or an explicit value. At no time can both the mnemonic and the explicit value

be specified at the same time in the same command. Either the **npv** or **np** parameter can be specified. Table A-6 shows the mapping between the **npv** and the **np** parameters.

**Table 5-32. NP/NPV Mapping**

NPV	NP	Description
0	–	Unknown
1	E164	ISDN/telephony numbering plan
2	Generic	Generic numbering plan
3	X121	Data numbering plan
4	F69	Telex numbering plan
5	E210	Maritime mobile numbering plan
6	E212	Land mobile numbering plan
7	E215	ISDN/mobile numbering plan
8	Private	Private network or network-specific numbering plan
9-15	–	Spare

**:npv=** (optional)

Numbering plan value. The numbering plan can be specified by a mnemonic value (**np** parameter) or an explicit numeric value (**npv** parameter). Either the **np** parameter or the **npv** parameter, but not both, can be specified. Table A-6 shows the mapping between the **npv** and the **np** parameters.

**Range:** 0-15

**Default:** Current value.

**:nserv=** (optional)

New DSM service.

**NOTE: The gport service cannot be used for the Prepaid SMS Intercept Phase 1 (PPSMS) or the Portability Check for Mobile Originated SMS feature; use the smsmr service. The mnp service includes the G-Port, A-Port, and IS41-to-GSM Migration services.**

**Range:** **eir, gflex, gport, inpq, inpmr, smsmr, idpr, idps, mnp, vflex, atinp, ttr**

**eir** — Equipment Identity Register

**gflex** — GSM flexible numbering

**gport** — GSM number portability

**inpq** — INP query

**inpmr** — INP message relay

**smsmr** — Prepaid SMS Intercept Phase 1, Portability Check for Mobile Originated SMS, MO-based GSM SMS NP, MO-based IS41 SMS NP, MO SMS IS41-to-GSM Migration, MO SMS ASD, MO SMS GRN, MO SMS B-Party Routing.

**idpr** — Prepaid IDP Query Relay

**idps** — IDP Screening for Prepaid

**mnp** — Mobile Number Portability

**vflex** — V-Flex

**atinp** — ATI Number Portability Query (ATINP)

**ttr** — Triggerless TCAP Relay

**Default:** No change to existing value.

**:nsnai=** (optional)

New service nature of address indicator.

**Range:** **sub, natl, intl, rnidn, rnrndn, rnsdn, none, ccrndn**

**sub** — Subscriber number

**natl** — National significant number

**intl** — International number

**rnidn** — Routing number prefix and international dialed/directory number

**rnrndn** — Routing number prefix and national dialed/directory number

**rnsdn** — Routing number prefix and subscriber dialed/directory number

**none** — The **nsnai** is not associated with the new DSM service.

**ccrndn** — Country code, routing number, and national directory number

**Default:** No change to existing value.

**:nsnp=** (optional)

New service numbering plan.

**Range:** **e164, e212, e214, none**

**e164** — E.164 numbering plan

**e212** — E.212 numbering plan

**e214** — E.214 numbering plan

**none** — The **nsnp** is not associated with the new DSM service.

**Default:** No change to existing value.

### Example

```
chg-srvsel:gti=2:tt=10:ssn=250:nserv=gflex
```

```
chg-
```

```
srvsel:gtin=4:tt=0:ssn=100:np=e164:nai=intl:nsnp=e164:nsnai=rnidn
```

```
chg-srvsel:gtin24=4:tt=4:np=e164:ssn=50:nai=intl:nsnai=rnidn
```

```
chg-srvsel:gtii=4:tt=4:np=e164:nai=intl:ssn=10:nserv=eir
```

```
chg-srvsel:gtii=4:tt=4:np=e164:nai=intl:ssn=11:nserv=vflex
```

```
chg-srvsel:gtii=4:tt=4:np=e164:nai=intl:ssn=12:nserv=atinp
```

### Dependencies

The G-Flex feature must be turned on before the **nserv=gflex** parameter can be specified.

The INP feature must be turned on before the **nserv=inpqr** or **nserv=inpq** parameter can be specified.

The G-Port feature must be turned on before the **nserv=gport** parameter can be specified.

The Equipment Identity Register (EIR) feature must be turned on before the **nserv=eir** parameter can be specified.

At least one of the following parameters must be specified: **nsnp**, **nsnai**, or **nserv**.

The values **1** and **3** are not valid for the **gti/gtia/gtii/gtin/gtin24** parameters.

The **gtia=4** parameter cannot be specified. The value **4** is not valid for the **gtia** parameter.

If the **gti/gtia/gtii/gtin/gtin24=2** parameter is specified, then the **np(v)** and **nai(v)** parameter combinations cannot be specified.

If the **gtii/gtin/gtin24=4** parameter is specified, then an **np(v)** and **nai(v)** parameter combination must be specified. The parameters can be specified in these combinations: **np** and **naiv**, **npv** and **nai**, **np** and **nai**, or **npv** and **naiv**.

The **np** and **npv** parameters cannot be specified together in the command.



The **nai** and **naiv** parameters cannot be specified together in the command.

If the **nserv** parameter has a value of **inpmr**, **inpq**, **gport**, or **eir**, then the **gtia** and **gti** parameters cannot be specified.

If the **nserv=inpmr** parameter is specified, then the **nsnp=e164** parameter must be specified.

If the value specified for the **nsnai** parameter is **rnidn**, **rnndn**, or **rnsdn**, then the value specified for the **nserv** parameter must be **inpmr**, **gport** or **smsmr**.

If the **nserv=inpq** parameter is specified, then the **gtii** parameter cannot be specified.

If a value of **atinp**, **eir**, **idpr**, **idps**, **inpq**, **ttr**, or **vflex** is specified for the **nserv** parameter, then only a value of **none** can be specified for the **nsnai** or **nsnp** parameter.

If the **nserv=gflex** parameter is specified, then the **nsnai=none** and **nsnp=none** parameters cannot be specified.

If the **nserv=inpmr** parameter is specified, then the **nsnai** parameter must be specified.

An entry must already exist that exactly matches the **gti/gtii/gtin/gtin24**, **tt**, **ssn**, **np(v)**, and **nai(v)** combination of parameters.

If the **nsnai=ccrndn** parameter is specified, then the value specified for the **nserv** parameter must be **gport** or **smsmr**.

If the value specified for the **nserv** parameter is **inpmr**, **smsmr** or **gport**, then the **nsnp=e164** parameter must be specified.

If the value specified for the **nserv** parameter is **gflex**, **gport**, **inpmr**, or **smsmr**, then the **nsnai** and **nsnp** parameters must be specified.

The **nsnai=none** parameter can be specified only if the value specified for the **nserv** parameter is **atinp**, **eir**, **idps**, **inpq**, **idpr**, **ttr**, or **vflex**.

If the **ansigflex** STP option is enabled (see the **chg-stpotps** command), then an ITU Service Selector cannot be entered.

The Prepaid IDP Query Relay feature must be turned on or the IAR Base feature must be enabled before the **nserv=ttr** parameter can be specified.

If a value of **idpr** or **ttr** is specified for the **nserv** parameter, then the only valid mandatory service parameters are **gtii**, **gtin**, **ssn**, and **tt**, and the only valid optional parameters are **np** and **nai**.

The IDP Screening for Prepaid feature must be turned on before the **nserv=idps** parameter can be specified.

When the **nserv=idps** parameter is specified, the only valid optional service parameters are **np** and **nai**.

If the **nserv=idps** parameter is specified, then the only valid mandatory service parameters are **tt**, **serv**, **ssn**, **gtin**, and **gtii**.

The V-Flex feature must be turned on before the **nserv=vflex** parameter can be specified.

The PPSMS or Portability Check for MO SMS feature must be turned on, or the MO SMS ASD, MO SMS GRN, MO SMS IS41-to-GSM Migration, MO SMS B-party Routing, MO-based GSM SMS NP, or MO-based IS41 SMS NP feature must be enabled before the **nserv=smsmr** parameter can be specified.

The ATINP feature must be enabled before the **nserv=atinp** parameter can be specified.

If the **nserv=atinp** parameter is specified, then the **gtin24** parameter cannot be specified.

If the A-Port or IGM feature is enabled, then the **nserv=gport** parameter cannot be specified.

The Prepaid IDP Query Relay feature must be turned on before the **nserv=idpr** parameter can be specified.

The A-Port or IGM feature must be turned on, or the A-Port or IGM feature must be enabled and the G-Port feature must be turned on before the **nserv=mnp** parameter can be specified.

### Notes

None

### Output

```
chg-srvsel:gti=2:tt=10:ssn=250:nserv=gflex
rlghncxa03w 07-08-05 16:40:40 EST EAGLE 37.5.0
Service Selector table is (114 of 1024) 11% full
CHG-SRVSEL: MASP A - COMPLTD
;
```

## chg-ss-appl

## Change Subsystem Application

Use this command to change the application status in the database.

**Keyword:** chg-ss-appl

**Related Commands:** dlt-ss-appl, ent-ss-appl, rtrv-ss-appl

**Command Class:** Database Administration

### Parameters

**:appl=** (mandatory)

Application type.

**Range:** **lnp, inp, eir, vflex, atinpq**

**:nstat=** (mandatory)

Status.

**Range:** **offline, online**

### Example

```
chg-ss-appl:appl=lnp:nstat=offline
chg-ss-appl:appl=inp:nstat=online
chg-ss-appl:appl=vflex:nstat=online
chg-ss-appl:appl=atinpq:nstat=online
```

### Dependencies

The INP feature must be turned on before the **chg-ss-appl:appl=inp** command can be entered.

The Equipment Identity Register (EIR) feature must be turned on before the **chg-ss-appl:appl=eir** command can be entered.

The application type (**appl** parameter) must already exist in the SS-APPL table.

The subsystem must be in the opposite state of the requested change.

The subsystem must be inhibited before **status=offline** can be specified.

Application type must exist in the LNP database

Application type not in SS-APPL table

The V-Flex feature must be turned on before the **appl=vflex** parameter can be specified.

The ATINP feature must be enabled before the **appl=atinpq** parameter can be specified.

**Notes**

After the LNP subsystem is inhibited before performing an LNP ELAP bulk download, **chg-ss-appl:appl=lnp:nstat=offline** must be entered to ensure that the subsystem remains down through Service Module card replacements and reloads.

**Output**

```
chg-ss-appl:appl=vflex:nstat=offline
r1ghncxa03w 08-05-05 13:35:40 EST EAGLE 39.0.0
CHG-SS-APPL: MASP A - COMPLTD
;
```

**chg-ss7opts****Change SS7 Options**

Use this command to update (change by simple replacement) the values of one or more of the SS7 option indicators maintained in the STP Options table. SS7 options can modify normal handling of SS7 traffic.

**Keyword:** **chg-ss7opts**

**Related Commands:** **rtrv-ss7opts**

**Command Class:** Database Administration

**Parameters**

**:ddbaudtimer=** (optional)

Dynamic database audit timer. This parameter specifies the amount of time, in minutes, between the end of an automatic dynamic database audit and the beginning of the next automatic dynamic database audit.

**Range:** **5-1440 none**  
**none**—disables the automatic dynamic database audit

**Default:** No change to the current value

**System**

**Default:** **10**

**:discardtfc=** (optional)

This parameter enables and disables the handling of TFC traffic from ITU-I networks. If enabled, TFC traffic from ITU-I networks will be discarded.

**Range:** **on, off**  
**on**— Discard TFC ITU-I traffic  
**off**— Do not discard TFC ITU-I traffic

**System**

**Default:** **off**

**:discardtfcn=** (optional)

This parameter enables and disables the handling of TFC traffic from ITU-N networks. If enabled, TFC traffic from ITU-N networks will be discarded.

**Range:** **on, off**  
**on**— Discard TFC ITU-N traffic  
**off**— Do not discard TFC ITU-N traffic

**System**

**Default:** **off**

**:lsrestrict=** (optional)

Use the restricted linkset routing determination algorithm. This parameter enables and disables the restricted linkset routing determination algorithm on a system-wide basis.

**Range:** **on, off**  
**on**—Restrictive linkset routing enabled; route traffic on the least restrictive available route with the lowest cost.  
**off**—Restrictive linkset routing disabled; route traffic on the lowest cost route.

**Default:** Current value in the database.

**System**

**Default:** **off**

**:msgpri2itui=** (optional)

Message Priority to ITUI. This parameter specifies the priority for messages that cross to an ITUI network.

**Range:** **0-3 dflt**  
**dflt**—Messages retain their original functionality.  
**0-3**—The priority for any MSU crossing to an ITUI network is set to the provisioned value. MSUs crossing to ANSI networks are not affected.

**Default:** No change to the current value

**System**

**Default:** **dflt**

**:msgpri2itun=** (optional)

Message Priority to ITUN. This parameter specifies the priority for messages that cross to an ITUN or ITUN-24 network.

**Range:** **0-3 dflt**  
**dflt**—Messages retain their original functionality.  
**0-3**—The priority for any MSU crossing to an ITUN or ITUN-24 network is set to the provisioned value. MSUs crossing to ANSI networks are not affected.

**Default:** No change to the current value

**System**

**Default:** **dflt**

**:slanporgopc=** (optional)

This parameter specifies whether to copy the originating point code (OPC) from the incoming MSU to the **stplan** application.

**Range:** **on, off**  
**on**— Copy the OPC from the incoming MSU to the **stplan** application.  
**off**— Do not copy the OPC from the incoming MSU to the **stplan** application.

**System**

**Default:** **off**

**:slanlsn=** (optional)

SLAN linkset name. This parameter specifies whether to copy the incoming and outgoing linkset names into the STPLAN message format.

**Range:** **on, off**  
**on**— Copy the incoming and outgoing linkset names into the STPLAN message format.  
**off**— Do not copy the incoming and outgoing linkset names into the STPLAN message format.

**Default:** No change to the current value

**System**

**Default:** **off**

**:slsreplace=** (optional)

Signaling link selector replace. This parameter enables the EAGLE 5 ISS to replace the SLS for an ANSI message.

The **randsls=perls** parameter must be specified in the **chg-stpopts** command before the SLS can be replaced.

**Range:** **no, yes**  
**no**— Do not replace the SLS in an outgoing message with a randomly generated SLS.  
**yes**— Replace the SLS in an outgoing message with a randomly generated SLS.

**Default:** No change to the current value.

**System**

**Default:** **no**

**Example**

```
chg-ss7opts:lsrestrict=on
chg-ss7opts:slanporgopc=on
chg-ss7opts:slsreplace=yes
chg-ss7opts:ddbbaudtimer=5
chg-ss7opts:ddbbaudtimer=none
chg-ss7opts:slanlsn=on
```

**Dependencies**

At least one optional parameter must be specified.

When the **lsrestrict** option is **on**, the **tfatcabmlq** parameter value for C linksets can be changed to a non-zero value (see the **chg-ls** command). If the **tfatcabmlq** parameter in any C linkset has been changed to a non-zero value, the **tfatcabmlq** value must be set back to **0** for all C linksets before the **lsrestrict** option can be turned off.

The STP LAN feature must be turned on (see the **chg-feat** command) before the **slanporgopc** or **slanlsn** parameter can be specified.

**Notes**

None

**Output**

```
chg-ss7opts:slanporgopc=on
tekelecstp 08-09-26 15:22:38 EST EAGLE 39.2.0
CHG-SS7OPTS: MASP B - COMPLTD
;
chg-ss7opts:slanlsn=on
tekelecstp 09-01-05 13:19:42 EST EAGLE 40.1.0
CHG-SS7OPTS: MASP B - COMPLTD
;
```

**chg-stpopts****Change STP Options**

Use this command to change the values of one or more of the STP node level processing option indicators maintained in the STP's options table. All values are assigned initially to system defaults at STP installation time, and they may be updated subsequently using this command.

**NOTE: For those STP option attributes supporting STP event message throttling, the values for the indicated parameters shall become effective in the next event-message output interval following their activation. All other updates shall be effective immediately, as of the time of activation.**

**Keyword:** **chg-stpopts**

**Related Commands:** **rtrv-stpopts**

**Command Class:** Database Administration

**Parameters**

**NOTE: As of Release 40.1, the hselksrc, hselkll, and force parameters are obsolete.**

**:ansigflex=** (optional)

This parameter enables ANSI G-Flex to execute at 1700 TPS per DSM card.

**Range:**     **yes, no**  
               **yes**— Enabled  
               **no**— Disabled

**Default:**   Current value

**System**

**Default:**   **no**

**:archbldid=** (optional)

Archive build ID. This parameter specifies whether the database archive file name contains the EAGLE 5 ISS build number instead of the release number.

**Range:**     **on, off**  
               **on**— The file name contains the build number.  
               **off**— The file name contains the release number.

**:cnvcgda=** (optional)

This parameter enables discarding of the CGPA point code in SCCP messages if the destination network type is ANSI, and the point code or alias point code of the destination network type is not defined.

**Range:**     **yes, no**  
               **yes**—Enabled  
               **no**—Disabled

**Default:**   Current value

**System**

**Default:**   **no**

**:cnvcgdi=** (optional)

This parameter enables discarding of the CGPA point code in SCCP messages if the destination network type is ITU-I, and the point code or alias point code of the destination network type is not defined.

**Range:**     **yes, no**  
               **yes**— Enabled  
               **no**— Disabled

**Default:**   Current value

**System**

**Default:**   **no**

**:cnvcgdn=** (optional)

This parameter enables discarding of the CGPA point code in SCCP messages if the destination network type is ITU-N, and the point code or alias point code of the destination network type is not defined.

**Range:**     **yes, no**  
               **yes**— Enabled  
               **no**— Disabled

**Default:**   Current value

**System**

**Default:**   **no**

**:cnvcgdn24=** (optional)

This parameter enables discarding of the CGPA point code in SCCP messages if the destination network type is ITU-N24, and the point code or alias point code of the destination network type is not defined.

**Range:**     **yes, no**  
               **yes** — Enabled  
               **no** — Disabled

**Default:**    Current value

**System**

**Default:**    **no**

**:critalminh=** (optional)

Critical alarm inhibit. This parameter enables inhibiting of critical alarms.

**Range:**     **yes, no**  
               **yes** — Enabled  
               **no** — Disabled

**Default:**    Current value

**System**

**Default:**    **no**

**:defcc=** (optional)

Default country code.

**Range:**     1-3 digits, **none**  
               Valid digits are **0-9, A-F, a-f**.  
               **none**—Deletes the current value.

**Default:**    Current value

**:defndc=** (optional)

The default network destination code.

**Range:**     Valid digits are **0-9, A-F, a-f**.

**:defndc=** (optional)

Default network destination code.

**Range:**     1-5 digits, **none**  
               Valid digits are **0-9, A-F, a-f**.  
               **none**—Deletes the current value.

**Default:**    Current value

**:dispactalms=** (optional)

Display active alarms. This parameter displays active or total alarms in the alarm status area of the VT320 screen (see Figure 4-1). The alarm status area comprises four boxes to show counts for critical, major, minor, and inhibited alarms. When total alarms are displayed (**dispactalms=no**), the counts for critical, major, and minor alarms include any temporarily or permanently inhibited alarms. The alarm status area is labeled *Total Alarm Status*. When active alarms are displayed (**dispactalms=yes**), the counts for critical, major, and minor alarms do not include any temporarily or permanently inhibited alarms. The alarm status area is labeled *Active Alarm Status*. This parameter does not affect the count displayed in the inhibited box; the number of inhibited alarms is always displayed.

**Range:**     **yes, no**  
               **yes** — Enabled; active alarm status is displayed  
               **no** — Disabled; total alarm status is displayed

**Default:**    Current value

**System**

**Default:**    **no**

**:dsmaud=** (optional)

Service Module card audit running state. Refer to the *EPAP Administration Manual* for more information about the Service Module card checksum audit.

**Range:** **on, off, ccc**

**on**— Running

**off**— Not running

**ccc**— Running with Corruption Cross Correction enabled. EAGLE 5 ISS LNP, G-Flex, G-Port, INP, or V-Flex systems contain  $n+1$  Service Module cards (maximum 25) running the VSCCP application. Each of the Service Module cards contains a full image of the RTDB database. If a record within the RTDB database on any card should become corrupted, a mate Service Module card can supply the corrected data. The **dsmaud=ccc** parameter enables the Corruption Cross Correction function used by the system to obtain the correct data from a mate Service Module card.

**Default:** Current value

**:gsmdecerr=** (optional)

GSM MAP screening decode error action.

**Range:** **pass, discard**

**Default:** Current value

**System**

**Default:** **pass**

**:gsmdfilt=** (optional)

GSM MAP screening default action.

**Range:** **pass, discard**

**Default:** Current value

**System**

**Default:** **pass**

**:gtcnvdfilt=** (optional)

This parameter enables routing of SCCP messages using system defaults when an appropriate entry is not found in the Default GT Conversion Table.

**Range:** **yes, no**

**yes**— Enabled

**no**— Disabled

**Default:** Current value

**System**

**Default:** **no**

**:mtpdpcq=** (optional)

MTP destination point code quantity. This parameter specifies the maximum number of DPCs that can be provisioned from the STP. The value of this parameter is dependent directly on the number of x-list entries that can be provisioned using the **mtpxlq** parameter. If the number of destinations that can be provisioned is increased, the number of x-list entries that can be maintained is decreased.

**Range:** **500-8000**

**500-2000**—if DSTN5000 feature is not turned on

**500-5000**—if DSTN5000 feature is turned on

**500-6000**—if 6000 Routesets feature is enabled

**500-7000**—if 7000 Routesets feature is enabled

**500-8000**—if 8000 Routesets feature is enabled

**Default:** Current value

**System**

**Default:** **2000**



**:mtplprst=** (optional)

MTP low priority route set test. This parameter specifies whether low priority route set polling is enabled or disabled at the STP.

**Range:**     **yes, no**  
              **yes** — Enabled  
              **no** — Disabled

**Default:**   Current value

**System**

**Default:**   **yes**

**:mpltctdpcq=** (optional)

MTP loop test congestion trigger DPC quantity. This parameter specifies the number of most frequently occurring DPCs to which the MTP loop test messages are to be sent when the MTP loop test is triggered by congestion.

**Range:**     **3-10**  
**Default:**   Current value

**:mplti=** (optional)

MTP loop test indicator. This parameter specifies whether the MTP loop detection procedures are enabled or disabled at the STP.

**Range:**     **yes, no**  
              **yes** — Enabled  
              **no** — Disabled

**Default:**   Current value

**System**

**Default:**   **yes**

**:mpltst=** (optional)

MTP loop test supervision timer. This parameter specifies the amount of time, in milliseconds, that the MTP loop test detection procedures run when started.

**Range:**     **10000-20000**  
**Default:**   Current value

**System**

**Default:**   **10000**

**:mtparsi=** (optional)

MTP Restart indicator. This parameter specifies whether MTP Restart procedures (both ANSI and ITU) are enabled or disabled at the STP.

**Default:**   Current value

**System**

**Default:**   **no**

**:mtprsit=** (optional)

ANSI MTP Restart isolation timer. This parameter specifies the minimum duration of node isolation, in milliseconds, before the ANSI MTP Restart procedure is deemed necessary.

**Range:**     **2000-900000**  
**Default:**   Current value

**System**

**Default:**   **5000**

**:mpt10alt=** (optional)

MTP T10 alternate timer, in milliseconds. This parameter specifies the interval at which the STP performs a route set test on low priority routes. The value of the **mpt10alt** parameter must be equal to or greater than the value of the level 3 T10 timer.

**Range:**     **20000-1000000**

**Default:** Current value  
**System**  
**Default:** 30000

**:mtp31ctl=** (optional)

MTP T31 congestion trigger level. This parameter specifies the signaling link congestion level at which the system starts the level 3 t31 timer. When the level 3 t31 timer expires, the associated signaling link is removed from service for realignment.

**Range:** 1-2  
**Default:** Current value

**:mtpxlet=** (optional)

MTP x-list expiration time. This parameter specifies the maximum amount of time the system maintains an unreferenced dynamic status exception list (x-list) entry. This parameter must be specified in one of the following formats: *mm*, *hmm*, *hhmm*, where *m* is minutes and *h* is hours. For example, **43** is 43 minutes, **138** is 1 hour 38 minutes, and **2400** is 24 hours.

**Range:** 0020-2400  
**Default:** Current value  
**System**  
**Default:** 0100

**:mtpxlot=** (optional)

MTP x-list occupancy threshold. This parameter specifies the dynamic status exception list (x-list) occupancy threshold at which the system raises a minor alarm. The threshold is expressed as a percentage of space available.

**Range:** 0-100  
**Default:** Current value

**:mtpxlq=** (optional)

MTP x-list quantity. This parameter specifies the number of dynamic status exception list (x-list) entries the system maintains. The value of this parameter is dependent directly on the number of destinations that are provisioned using the **mtpdpcq** parameter.

**Range:** 500-6000  
 500-2000—if DSTN5000 feature is not turned on  
 500-5000—if DSTN5000 feature is turned on  
 500-6000—if 6000, 7000, or 8000 Routesets feature is enabled  
**Default:** Current value  
**System**  
**Default:** 500

**:npcfnti=** (optional)

The ITU National Point Code Format Identifier. This parameter specifies how the ITU national point code is entered into the database and how it is displayed in any outputs from the system. The ITU national point code is a 14-bit integer. The point codes can be a single number up to five digits, or two, three, or four numbers separated by dashes. This parameter specifies the number of bits to allow in each position of the four members.

**Range:** *m1-m2-m3-m4*  
 Four members where each member represents the number of bits allowed in the corresponding position for a flexible ITU national point code. The range of each member (*m1-m4*) is from **0** to **14**. Each member must be specified no matter how many numbers the point code format contains, and the sum of *m1+m2+m3+m4* must equal 14 (for example, **npcfnti=7-7-0-0**, or **npcfnti=0-6-8-0**). Table 5-33 defines the values of the parts of the ITU national point code.

**Table 5-33. NPCFMTI Parameter - ITU National Point Code Values**

Number of Bits in Point Code Section								
Bit	0	1	2	3	4	5	6	7
Range of Values	Not Used	0-1	0-3	0-7	0-15	0-31	0-63	0-127
Bit	8	9	10	11	12	13	14	
Range of Values	0-255	0-511	0-1023	0-2047	0-4095	0-8191	0-16383	

**Table 5-34. Point Code Format Examples**

NPCFMTI Value	Range of Point Code Values
7-7-0-0	0-0 to 127-127
0-6-8-0	0-0 to 63-255
0-0-4-10	0-0 to 15-1023
3-8-3-0	0-0-0 to 7-255-7
2-9-2-1	0-0-0-0 to 3-511-3-1
4-4-4-2	0-0-0-0 to 15-15-15-3
14-0-0-0	00000 to 16385

**Default:** Current value

**System**

**Default:** 14-0-0-0

**:randsls=** (optional)

Random SLS (signaling link selection) option. This parameter enables the EAGLE 5 ISS to ignore the incoming SLS value and randomly generate a new SLS value to select an outgoing linkset and a link. This parameter is implemented independently of the ITU SLS Enhancement feature settings for individual linksets, which are defined by the **slsocbit** and **slsrsb** parameters of the **ent-ls** and **chg-ls** commands. The value specified for the **randsls** parameter in the **chg-stpopts** command will override the value specified for the **randsls** parameter for each individual linkset.

To enable random SLS generation per linkset, the **randsls=perls** parameter must be specified. When this parameter is specified, the SLS Bit Rotation capability (set with the **slsrsb** parameter of the **ent-ls** or **chg-ls** commands) is overridden, and cannot be used on individual linksets. The **ent-ls** or **chg-ls** commands do not prevent the user from provisioning with the parameter also enables the user to restrict Random SLS generation to Class 0 messages only.

This parameter is implemented independently of the ITU SLS Enhancement feature settings for individual linksets. These settings are specified by the **slsocbit** (Use of the Other CIC BIT capability) and **slsrsb** (SLS Bit Rotation capability) parameters of the **ent-ls** and **chg-ls** commands. When the ITU SLS Enhancement is turned on with either the **randsls=all** or **randsls=class0** parameters, the

SLS Bit Rotation capability (set with the **slsru** parameter of the **ent-ls** or **chg-ls** commands) is overridden, and cannot be used on individual linksets. The **ent-ls** and **chg-ls** commands do not prevent the user from provisioning with the **slsru** parameter.

This parameter applies only to ITU SCCP messages.

**Range:** **class0, all, off, perls**  
**class0**— Enables random SLS generation for Class0 SCCP traffic.  
**all**— Enables random SLS generation for all SCCP traffic.  
**off**— Disables random SLS generation.  
**perls**— Enables random SLS generation on a per-linkset basis instead of a system-wide basis.

**Default:** Current value

**System**

**Default:** **off**

**:rptlnpmr**= (optional)

Report LNP MR SS unequipped. This parameter specifies whether to generate UIN 1049 for LNP message relay (MR) messages with missing subsystems. If no MAP entry is found from a GTT done on an LNP MR message, the UIM is either displayed (**rptlnpmr=yes**) or suppressed (**rptlnpmr=no**). This setting applies only to LNP MR messages. All other messages display UIM 1049 when no MAP entry is found, regardless of this setting.

**Range:** **yes, no**  
**yes**— Display UIM 1049 for all messages.  
**no**— Do not display UIM 1049 for LNP MR with missing subsystems.

**Default:** Current value

**:rstrdev**= (optional)

Restore device state. This parameter enables restoration of device states when the **init-sys** command is executed and when an OAM role change occurs and maintains the inhibited state of terminals, links, and cards through an **init-sys** execution, OAM role change, and card reload.

**CAUTION: An init-sys command causes the system to go down.**



**Range:** **on, off**  
**Default:** Current value

**:secmtpmate**= (optional)

This parameter enables security screening for MTP messages received by an STP on a non-C-Link, with an OPC equal to the SID (True, Adjacent, or Capability) point code of its mate.

**Range:** **off, notify, silent, test**  
**off**— Screening is disabled; message is processed normally.  
**notify**— Screening is enabled; UIM is generated and message is discarded.  
**silent**— Screening is enabled; message is discarded. No UIM is generated.  
**test**— Screening is enabled; UIM is generated and message is processed normally.

**Default:** Current value

**System**

**Default:** **off**

**:secmtpsid**= (optional)

This parameter enables security screening for MTP messages received at MTP3 containing an OPC equal to its own SID (OPC that is the True, Secondary, or Capability point code entered in the **chg-sid** command) that is not a route-set-congestion-message. The EAGLE 5 ISS should not receive a message with its own OPC unless the message is a result of a circular route test or is an SLTM when the far end is in loopback. (SLTM messages are not checked.)

**Range:** **off, notify, silent, test**  
**off**— Screening is disabled; message is processed normally.  
**notify**— Screening is enabled; UIM is generated and message is discarded.  
**silent**— Screening is enabled; message is discarded. No UIM is generated.  
**test**— Screening is enabled; UIM is generated and message is processed normally.

**Default:** Current value

**System**

**Default:** **off**

**:secmtpsnm=** (optional)

This parameter enables security screening for MTP SNM messages. The EAGLE 5 ISS should not receive an MTP network management message unless:

- The OPC is an adjacent point code. (For all link types, this rule does not apply to UPU, TFC, and RCT messages.)
- The EAGLE 5 ISS has a route to the OPC of the MTP network management message on the linkset which the message was received.
- The EAGLE 5 ISS has a route to the destination field in the message (if applicable to the concerned message) on the linkset which the message was received. (For all link types, this rule does not apply to RST messages.)

**Range:** **off, notify, silent, test**  
**off**— Screening is disabled; message is processed normally.  
**notify**— Screening is enabled; UIM is generated and message is discarded.  
**silent**— Screening is enabled; message is discarded. No UIM is generated.  
**test**— Screening is enabled; UIM is generated and message is processed normally.

**Default:** Current value

**System**

**Default:** **off**

**:secscpcsmg=** (optional)

This parameter enables security screening for SCCP SCMG messages. The EAGLE 5 ISS should not receive an SCCP network management message unless:

- The EAGLE 5 ISS has a route to the OPC of the SCMG message on the linkset on which the message was received.
- The EAGLE 5 ISS has a route to the Affected Point Code (also called the Concerned Point Code in EAGLE 5 ISS) in the message on the linkset on which the message was received.

This parameter applies only to SSP and SOR messages. SSA, SST, SOG, SBR, SNR and SRT messages are not affected.

**Range:** **off, notify, silent, test**  
**off**— Screening is disabled; message is processed normally.  
**notify**— Screening is enabled; UIM is generated and message is discarded.  
**silent**— Screening is enabled; message is discarded. No UIM is generated.  
**test**— Screening is enabled; UIM is generated and message is processed normally.

**Default:** Current value

**System**

**Default:** **off**

**:slscnv=** (optional)

Per node SLS conversion indicator.

**Range:** **on, off, perls**  
**on**— SLS conversion is enabled on all linksets.

**off**— SLS conversion is disabled on all linksets.  
**perls**— SLS conversion is enabled on a per linkset basis.

**Default:** Current value

**:tfatfrpr=** (optional)

TFA/TFR pacing rate. This parameter specifies the amount of time, in milliseconds, between partial broadcasts of up to 20 percent increments of the number of TFAs/TCAs or TFRs/TCRs to be broadcast by the STP when an affected destination becomes accessible using its primary route rather than an alternate route. The STP uses this pacing to prevent congestion on the newly recovered linksets.

**Range:** **0-1000**  
Set in increments of 100.

**Default:** Current value

**System**

**Default:** **1000**

**:uimrd=** (optional)

Unsolicited Information Message (UIM) redirect indicator. This parameter specifies whether the UIMs are to be routed to the specified output group.

**Range:** **yes, no**  
**yes**— Enabled  
**no**— Disabled

**Default:** Current value

**System**

**Default:** **no**

**:force=** (obsolete)

Specify **force=yes** to change the **hscsksrc** parameter value when the TDMs are reporting that the high speed system clocks are currently valid.

**NOTE: This parameter is obsolete**

**Range:** **yes**

**:hskll=** (obsolete)

High speed master clock line length.

**NOTE: This parameter is obsolete.**

**Range:** **longhaul, shorthaul**  
**longhaul**— Gain is high for long haul  
**shorthaul**— Gain is low for short haul

**Default:** Current value

**System**

**Default:** **longhaul**

**:hscsksrc=** (obsolete)

High speed master clock source. The **force=yes** parameter must be specified with this parameter to change the clock source when the TDMs are reporting that the high speed system clocks are currently valid.

**NOTE: This parameter is obsolete.**

**Range:** **rs422, e1framed, e1unframed, t1framed, t1unframed**  
**rs422**— RS-422 clock source  
**e1framed**— E1 Framed clock source  
**e1unframed**— E1 Unframed clock source  
**t1framed**— T1 Framed clock source

**t1unframed** — T1 Unframed clock source  
**Default:** Current value  
**System**  
**Default:** rs422

**Example**

```
chg-stpopts:mtpt31ctl=2:uimrd=yes
chg-stpopts:mtpxlq=1000:mtpxlet=0200:mtpxlot=75
chg-stpopts:npcfmti=4-4-4-2
chg-stpopts:rptlnpmrssi=no
chg-stpopts:rstrdev=on
chg-stpopts:hscclksrc=t1framed
chg-stpopts:hscclksrc=e1unframed:force=yes
chg-stpopts:hscclk11=shorthaul
chg-stpopts:cnvcgda=yes
chg-stpopts:randsls=perls
```

**Dependencies**

The values of the **mtpdpcq** and **mtpxlq** parameters are interdependent; that is, to increase the number of DPCs that can be provisioned, the number of x-list entries that the STP is to maintain must be decreased. Conversely, to increase the number of x-list entries that the STP maintains, the number of DPCs that can be provisioned must be decreased.

At least one optional parameter must be specified.

The ANSI-ITU-China SCCP Conversion feature must be enabled before the **cnvcgda**, **cnvcgdi**, **cnvcgdn**, **cnvcgdn24** or **gtcnvdfit** parameters can be specified.

The **ansigflex** option cannot be enabled if any of the following features is enabled:

- 1100 TPS/DSM for ITU NP
- A-Port
- AINPQ
- ATINP
- EIR
- G-Flex MAP Layer Routing
- G-Port
- Info Analyzed Relay Base
- INP
- IS41 GSM Migration
- Prepaid Short Message Intercept Phase 1 (PPSMS)
- MO SMS ASD
- MO SMS GRN
- MO SMS IS41-to-GSM Migration
- MO-based GSM SMS NP

- MO-based IS41 SMS NP
- Portability Check for MO SMS
- TIF Number Portability
- TIF Number Substitution
- V-Flex

The G-Flex feature must be on before the **ansigflex** option can be enabled.

The **ansigflex** option cannot be enabled when Service Selector table contains an ITU entry. (See the **chg-srvsel** command.)

When the **mtpxlet** parameter is specified, the value for minutes (*mm*) must be in the range **00-59**.

The DSTN5000 (5000 Routes) feature must be turned on before the **mtpdpcq** parameter value can be increased to more than **2000**.

When the number of x-list entries (the **mtpxlq** parameter) is specified, the total number of DPCs (the **mtpdpcq** parameter) and x-list entries provisioned cannot exceed the space available in the Route table.

When the number of DPCs (the **mtpdpcq** parameter) is specified, the total number of DPCs and x-list entries (the **mtpxlq** parameter) provisioned cannot exceed the space available in the Route table.

The number of DPCs provisioned (the **mtpdpcq** parameter) cannot be increased if space allocated for maintaining x-list entries becomes full.

The value for the **mtpdpcq** parameter cannot be less than the number of DPCs provisioned.

The Cluster Routing and Management Diversity (CRMD) feature must be turned on before the **mtpxlq**, **mtpxlet**, and **mtpxlot** parameters can be specified.

The ANSI MTP restart (MTPRS) feature must be turned on before the **mtprsit** parameter can be specified.

The ANSI MTP restart (MTPRS) or ITU MTP restart (ITUMTPRS) feature must be turned on before the **mtparsi** parameter can be specified.

The value for the **tfatfrpr** parameter must be specified in increments of 100 milliseconds (0.1 seconds).

If critical alarms are inhibited in the system, then the **criticalminh=no** parameter cannot be specified.

If the **npcfnti** parameter is specified, it must be in the format *m1-m2-m3-m4* and all members must be specified. If the ITU national point code format is to only have two members, then two members of the **npcfnti** parameter must be specified as greater than zero, while the other two members must be specified as 0 (for example, **npcfnti=7-7-0-0**, **npcfnti=0-6-8-0**, or **npcfnti=0-0-4-10**).

If the **npcfnti** parameter is specified, the sum of the values specified for *m1+m2+m3+m4* must be equal to 14.

The **defcc** parameter value cannot already exist as an entry in the GSM Options Multiple Country Code (the **multcc** parameter) list.

If a GSM Options Multiple Country Code (the **multcc** parameter) has been defined, the **defcc=none** parameter cannot be specified.

The GSM Map Screening feature must be turned on (see the **enable-ctrl-feat** and **chg-ctrl-feat** commands) before the **gsmdflt** or **gsmdecerr** parameter can be specified.

The Network Security Enhancements feature must be turned on before the **secmtpmate**, **secmtpsid**, **secmtpsnm**, and **secscpcsmg** parameters can be specified.

If the Origin-based MTP Routing feature is enabled, then the **mtpmprst=no** parameter cannot be specified.



The AINPQ, EIR, G-Flex, G-PORT, INP, LNP ELAP Configuration, Prepaid SMS Intercept Ph1, or V-Flex feature must be turned on before the **dsmaud** parameter can be specified.

The value of the **mtprsit** parameter must be in the range of **2000 – 900000** milliseconds.

The value specified for **mtpt10alt** parameter cannot be less than Level3-T10 timer value.

If the MT-Based GSM SMS NP feature is turned on, then the **defcc=none** parameter cannot be specified.

If the MT-Based IS41 SMS NP feature is turned on, then the **defcc=none** parameter cannot be specified.

If the ATINP feature is turned on, then the **defcc=none** parameter cannot be specified.

If the TN quantity key is above 228M, or if ELAP version 8.0 or above is provisioned, then the **dsmaud=ccc** parameter cannot be specified.

If the Prepaid IDP Relay feature is turned on or the IAR Base feature is enabled, then the **defcc=none** parameter cannot be specified.

## Notes

If the database contains ITU national point codes of a particular format, and the format is changed with the **npcfmti** parameter of the **chg-stpopts** command, the format of the ITU national point codes in the database will be changed to the new format.

The format defined by the **npcfmti** parameter applies to all database entities that use ITU national point codes except gateway screening. Gateway screening allows the ITU national point code to be displayed and entered in the database only as a single number. If the system is using a format for the ITU national point code other than a single number, the point code will have to be converted from its current format to a single number in order to be used by gateway screening. The conversion is explained in “Converting ITU National Point Code Formats”.

For the STP option attributes supporting STP event message throttling, the values for the indicated parameters become effective in the next event-message output interval following their activation. All other updates become effective at the time of activation (immediately).

When the **slscnv=on** parameter is specified with the **chg-stpopts** command, the node acts as if the 5-bit to 8-bit SLS conversion is being performed on every linkset in the database, even those linksets that have the **slsci=no** parameter specified for them.

When the **slscnv=off** parameter is specified with the **chg-stpopts** command, the node acts as if the 5-bit to 8-bit SLS conversion has been turned off for every linkset in the database, even those linksets that have the **slsci=yes** parameter specified for them.

When the **slscnv=perls** parameter is specified with the **chg-stpopts** command, the 5-bit to 8-bit SLS conversion is performed only on the linksets that have the **slsci=yes** parameter specified for them.

When the value of the **dispactalms** parameter is changed, there could be a delay of up to five seconds as the VT320 screen refreshes to the selected display.

The maximum allowed number of destination point codes can be changed by the **mtpdpcq** parameter. The maximum value of the **mtpdpcq** parameter is one of the following values:

- **5000** if the DSTN5000 feature is on
- **6000, 7000, or 8000** if the respective 6000, 7000, or 8000 Routesets feature is enabled
- **2000** if no Routes or Routesets feature is on

If the Cluster Routing and Management Diversity feature is turned on, the maximum number of destination point codes contained in the exception list can be changed by the **mtpxlq** parameter. The maximum value of the **mtpxlq** parameter is one of the following values:

- **5000** if the DSTN5000 feature is on
- **6000** if the 6000, 7000, or 8000 Routesets feature is enabled
- **2000** if no Routes or Routesets feature is on

The sum of the values of the **mtpdpcq** and **mtpxlq** parameters can be increased beyond **2500** only if one or more of the following features is turned on:

- If the DSTN5000 feature is turned on (**chg-feat:dstn5000=on**), the **mtpdpcq** and **mtpxlq** parameters cannot exceed **5500**.
- If the 6000 Routesets feature is enabled (see the **enable-ctrl-feat** command), the **mtpdpcq** and **mtpxlq** parameters cannot exceed **6500**.
- If the 7000 Routesets feature is enabled (see the **enable-ctrl-feat** command), the **mtpdpcq** and **mtpxlq** parameters cannot exceed **7500**.
- If the 8000 Routesets feature is enabled (see the **enable-ctrl-feat** command), the **mtpdpcq** and **mtpxlq** parameters cannot exceed **8500**.

To enter seconds (instead of milliseconds) for the timer values, the timer value must contain at least one decimal place, and can contain up to three decimal places. If no decimal places are entered, the system accepts the value as milliseconds. The **rtrv-stpopts** command always displays the output in milliseconds, not seconds.

## Output

```
chg-stpopts:randsls=all
tekelecstp 06-07-26 12:03:28 EST EAGLE 36.0.0
CHG-STPOPTS: MASP A - COMPLTD
;
```

## chg-t1

## Change T1 Interface

Use this command to change an interface for a T1 card in the system:

- An E1/T1 MIM card
- An HC-MIM card used as a T1 card or an ST-HSL-A card
- An E5-E1T1 card used as a T1 card or an ST-HSL-A card

**NOTE: On HC-MIM and E5-E1T1 cards, T1 ports 1, 3, 5, and 7 (master ports) can be independently channel bridged with their adjacent even-numbered T1 ports 2, 4, 6, and 8 (slave ports) to allow non-signaling data pass-through.**

**Keyword:** **chg-t1**

**Related Commands:** **dlt-t1, ent-t1, rtrv-t1, tst-t1**

**Command Class:** Database Administration

## Parameters

**:loc=** (mandatory)

The card location as stenciled on the shelf of the system.

**Range:** 1101-1108, 1111-1112, 1201-1208, 1211-1218, 1301-1308, 1311-1318, 2101-2108, 2111-2118, 2201-2208, 2211-2218, 2301-2308, 2311-2318, 3101-3108, 3111-3118, 3201-3208, 3211-3218, 3301-3308, 3311-3318, 4101-4108, 4111-4118, 4201-4208, 4211-4218, 4301-4308, 4311-4318, 5101-5108, 5111-5118, 5201-5208, 5211-5218, 5301-5308, 5311-5318, 6101-6108, 6111-6118

**:t1port=** (mandatory)

T1 port number

The value must be a T1 port that has already been configured with a T1 interface on the specified T1 card.

**Range:** 1-8

Ports 3 - 8 can be specified only for HC-MIM cards and E5-E1T1 cards.

Any 2 of the 8 ports on an HC-MIM card can be specified when the card is used as an ST-HSL-A card.

Any 1 of the 8 ports on an E5-E1T1 card can be specified when the card is used as an ST-HSL-A card.

**:chanbrdg=** (optional)

Port bridging status. This parameter specifies whether an odd-numbered T1 port on an HC-MIM or E5-E1T1 card is channel bridged with its adjacent even-numbered T1 port for non-signaling data pass through.

**Range:** on, off

**Default:** No change to the current value

**:encode=** (optional)

Indicator for use of B8ZS or AMI encoding/decoding.

**Range:** b8zs, ami

**Default:** No change to the current value

**:force=** (optional)

This parameter specifies to provision an odd-numbered T1 port to channel bridging mode even if the adjacent next higher even-numbered port is already provisioned with a T1 interface.

**Range:** yes, no

**:framing=** (optional)

Indicator for framing format.

**Range:** sf, esf, esfperf

**esfperf**— **esf** framing format with performance monitoring.

**Default:** No change to the current value

**:ll=** (optional)

T1 cable length in feet between the EAGLE 5 ISS and the connecting node.

**Range:** 0 - 655

**Default:** No change to the current value

**:minsurate=** (optional)

Minimum signal unit rate. This parameter specifies the minimum number of SUs present on a link that are uniformly distributed.

The **linkclass=unchan** parameter (see the **ent-t1** command) must be specified in the T1 interface before this parameter can be specified.

**Range:** 400-1600

**Default:** No change to the current value

**:t1tsel=** (optional)

This parameter specifies the timing source for a T1 card.

**Range:** **line**, **external**, **recovered**  
**line** — slave timing source  
**external** — master timing source  
**recovered** — timing source recovered from the paired master port for channel bridged slave ports

**Default:** No change to the current value

### Example

```
chg-t1:loc=1205:t1port=1:encode=ami:t1tsel=external
chg-t1:loc=1205:t1port=2:encode=b8z:ll=250s
chg-t1:loc=1205:t1port=3:chanbrdg=on:t1tsel=recovered
chg-t1:loc=1205:t1port=1:minsrate=1000
```

### Dependencies

At least one optional parameter must be specified.

The specified card location (**loc** parameter) must be equipped.

The card specified by the **loc** parameter must be a **limt1** card type.

The port specified by the **t1port** parameter must have already been configured with a T1 interface on the specified T1 card.

All signaling links that are serviced by the specified T1 card (**loc** parameter) must be deactivated before the values for the **encode**, **t1tsel**, **ll**, and **framing** parameters can be changed. See the **dlt-slk** command to delete the signaling links.

If an even-numbered T1 port on an HC-MIM or E5-E1T1 card is used, then the **chanbrdg=on** parameter cannot be specified.

If the **chanbrdg=on** parameter is specified, then the **t1tsel** parameter must be specified.

The **t1tsel=line** parameter cannot be specified when the specified T1 port (**t1port** parameter) on the HC-MIM card or E5-E1T1 card is in channel bridging mode.

The **t1tsel=recovered** parameter can be specified only when the specified T1 port (**t1port** parameter) on the HC-MIM card or E5-E1T1 card is in channel bridging mode.

The **force=yes** parameter must be specified to provision an odd-numbered T1 port to channel bridging mode on an HC-MIM card or an E5-E1T1 card if the adjacent next higher even-numbered port is already provisioned with a T1 interface.

Parameter values cannot be changed for the even-numbered T1 port interface (**t1port** parameter) in a channel bridged pair. The values must be changed in the odd-numbered port interface.

Before an odd-numbered T1 port (**t1port** parameter) on an HC-MIM card or E5-E1T1 card can be provisioned into channel bridging mode (**chanbrdg=on** parameter), all signaling links assigned to its next higher even-numbered adjacent T1 port must be deleted. See the **dlt-slk** command to delete the signaling links.

The fan feature bit must be on before HC-MIM cards can be used in an EAGLE 5 ISS shelf (see the **chg-feat** command). The system checks the fan feature bit when an HC-MIM card is present in the specified odd card location (**loc** parameter) and the **chanbrdg=on** parameter is specified.

HIPR cards must be equipped in card locations *xy09* and *xy10* (*x* is the frame, *y* is the shelf) on each EAGLE 5 ISS shelf that contains one or more HC-MIM cards or E5-E1T1 cards. The system checks for HIPR cards when the **chanbrdg=on** parameter is specified for HC-MIM cards and E5-E1T1 cards.

The following card locations cannot be specified in the **loc** parameter: 1113, 1114, 1115, 1116, 1117, 1118 (OAM, TDM, MDAL cards), or *xy09* and *xy10* where *x* is the shelf and *y* is the slot (HMUX or HIPR cards).

The **chanbrdg** parameter can be specified only for HC-MIM cards and E5-E1T1 cards that are used as T1 cards. The parameter cannot be specified if the cards are used as ST-HSL-A cards.

If the value specified by the **loc** parameter refers to a T1 card, then the **chanbrdg=on** parameter cannot be specified.

The **t1tsel=recovered** parameter cannot be specified for a T1 port (**t1port** parameter) on the HC-MIM or E5-E1T1 card if the T1 port status is channel bridged slave without specifying the **chanbrdg=on** parameter. The **chanbrdg=off** parameter cannot be specified for a T1 port (**t1port** parameter) on the HC-MIM or E5-E1T1 card if the T1 port timing is recovered without specifying the **t1tsel=line** parameter.

Line (slave) timing cannot be used with channel bridging. If the **t1tsel=line** parameter is specified for a T1 port (**t1port** parameter) on an HC-MIM card or E5-E1T1 card with T1 port status of channel bridged with external (master) timing, the **chanbrdg=off** parameter must also be specified. If the **chanbrdg=on** parameter is specified for a T1 port (**t1port** parameter) on an HC-MIM card or E5-E1T1 card that uses T1 port line (slave) timing, the **t1tsel=recovered** parameter or the **t1tsel=external** parameter must also be specified.

The **linkclass=unchan** parameter must be specified (see the **ent-t1** command) before the **minsurate** parameter can be specified. If the **linkclass=unchan** parameter is specified, then the **chanbrdg=on** parameter cannot be specified.

The ST-HSL-A feature must be turned on before the **framing=esfperf** parameter can be specified.

## Notes

External timing is derived from the EAGLE 5 ISS High-Speed Master Clock (1.544 MHz for T1 or 2.048 MHz for E1); therefore, the Master Timing feature is required. Line timing is derived from its received data stream, if present.

## Output

```
chg-t1:loc=1205:t1port=1:encode=ami:t1tsel=external
rlghncxa03w 04-01-20 09:07:58 EST EAGLE 31.3.0
CHG-T1: MASP A - COMPLTD
;
```

## chg-tatr-msg

### Change Triggerless ANSI TCAP Relay Message

Use this command to revise a Triggerless ANSI TCAP Relay message.

**Keyword:** **chg-tatr-msg**

**Related Commands:** **rtrv-tatr-msg**, **tst-msg**

**Command Class:** Database Administration

## Parameters

**:msgn=** (mandatory)

Message number. This parameter specifies the number of the TATR message.

**Range:** 1-10

**:active=** (optional)

This parameter specifies whether the TATR message is sent to the network card for processing.

**Range:** **yes**, **no**

**yes** — The message is sent to the network card.

**no** — The message is not sent to the network card.

**Default:** No change to the current value

**System**

**Default:** **no**

- :cdpadgts=** (optional)  
Called party address digits. This parameter specifies the SCCP CdPA digits for the IAR message.  
**Range:** 1-15 digits  
1 - 15 hexadecimal digits. Valid digits are **0-9, a-f, A-F**.  
**Default:** No change to the current value
- :cdpagt=** (optional)  
Called party address global title. This parameter specifies the SCCP CdPA GT for the IAR message.  
**Range:** **0-15**  
**Default:** No change to the current value
- :cdpagtnai=** (optional)  
Called party address global title nature of address indicator. This parameter specifies the SCCP CdPA GT NAI for the IAR message.  
**Range:** **0-127**  
**Default:** No change to the current value
- :cdpndgts=** (optional)  
Called party number digits. This parameter specifies the TCAP CdPN digits for the IAR message.  
**Range:** 1-32 digits  
1 - 32 hexadecimal digits. Valid digits are **0-9, a-f, A-F**.  
**Default:** No change to the current value
- :cdpnnai=** (optional)  
Called party number Nature of Address Indicator. This parameter specifies the value for TCAP CdPN NAI value for the IAR message.  
**Range:** **0-255**  
**Default:** No change to the current value
- :cgpadgts=** (optional)  
Calling party address digits. This parameter specifies the SCCP CgPA digits for the IAR message.  
**Range:** 1-15 digits  
Range is 1 - 15 hexadecimal digits. Valid digits are **0-9, a-f, A-F**.  
**Default:** No change to the current value
- :cgpagt=** (optional)  
Calling party address global title. This parameter specifies the SCCP CgPA GT for the IAR message.  
**Range:** **0-15**  
**Default:** No change to the current value
- :cgpagtnai=** (optional)  
Calling party address global title nature of address indicator. This parameter specifies the SCCP CgPA GT NAI for the IAR message.  
**Range:** **0-127**  
**Default:** No change to the current value
- :cgpndgts=** (optional)  
Calling party number digits. This parameter specifies the TCAP CgPN digits in the IAR message.  
**Range:** 1-32 digits  
1 - 32 hexadecimal digits. Valid digits are **0-9, a-f, A-F**.  
**Default:** No change to the current value
- :cgpnnai=** (optional)  
Calling party number nature of address indicator. This parameter specifies the TCAP CgPN NAI in the IAR message.  
**Range:** **0-255**

**Default:** No change to the current value

**:reset=** (optional)

This parameter resets all of the parameters to their default values.

**Range:** **yes**

**yes** — Resets all message parameters to their default values

**Default:** No change to the current value

**:trigtype=** (optional)

Trigger Type. This parameter specifies the value for the *TrigType* field of the IAR message.

**Range:** **0-255**

The value for the **trigtype** parameter can be entered as a decimal value (**0-255**) or as 2 hexadecimal digits. Valid digits are **0-9, a-f, A-F**.

If hexadecimal digits are used, then the digits must be preceded by *h'*. Table 5-47 lists valid hexadecimal values.

**Default:** No change to the current value

### Example

```
chg-tatr-
msg:msgn=1:trigtype=h'26:cdpnai=4:cdpadgts=12457896abcd:cgpnai=
4
```

```
chg-tatr-
msg:msgn=1:trigtype=12:cdpnai=2:cdpndgts=981123456:active=yes
```

### Dependencies

The IAR Base feature must be enabled before this command can be entered.

If the **reset** parameter is specified, then no other parameters can be specified.

At least one optional parameter must be specified.

### Output

```
chg-tatr-
msg:msgn=1:trigtype=37:cdpnai=4:cdpndgts=987654321:cgpnai=4
tekelecstp 09-07-07 15:58:08 EST EAGLE 41.1.0
CHG-TATR-MSG: MASP A - COMPLTD
;
```

## chg-tatropts

### Change TATR Options

Use this command to enter Triggerless ANSI TCAP Relay (TATR)-specific options in the database. This command updates the TATROPTS table.

**Keyword:** **chg-tatropts**

**Related Commands:** **rtrv-tatropts**

**Command Class:** Database Administration

### Parameters

**:cdnptype=** (optional)

Entity type for CdPN RTDB lookup. This parameter specifies the entity type that is considered a success when used for RTDB lookup.

**Range:** **sp, rn, rns, anymatch, always, rnsdn**

**sp** — Service provider

**rn** — Routing number

**rns** — **rn** or **sp**

**anymatch** — **rn, sp**, or no match with any entity

**always**— Lookup is always considered successful

**rnspsdn**— **rn**, **sp**, or **dn**

If the **cdnptype=anymatch** parameter is specified, then the value is also used as the RN for the outgoing CdPN.

**Default:** No change to the current value

**System**

**Default:** **rnsps**

**:cgnptype =** (optional)

CgPN database lookup type. This parameter specifies the entity type that is considered a success when used for RTDB lookup.

**Range:** **sp**, **rn**, **rnsps**, **anymatch**, **always**, **rnspsdn**

**sp**— Service Provider

**rn**— Routing Number

**rnsps**— **rn** or **sp**

**anymatch**— **rn**, **sp**, or no match with any entity

**always**— Lookup is always considered successful

**rnspsdn**— **rn**, **sp**, or **dn**

If the **cgnptype=anymatch** parameter is specified, then the value is also used as the RN for the outgoing CgPN.

**Default:** No change to the current value

**System**

**Default:** **rnsps**

**:cgpaccck=** (optional)

CgPA country code check. This parameter specifies whether a DEFCC check is performed on the incoming CgPA.

**Range:** **always**, **nonintl**, **off**

**always**— The DEFCC check is always performed.

**nonintl**— The DEFCC check is performed if the CdPN NAI is not 'International'.

**off**— The DEFCC check is not performed.

**Default:** No change to the current value

**System**

**Default:** **nonintl**

**:dfiltrn=** (optional)

Default routing number. This parameter specifies the default RN that is used when a value of **sp** or **rnsps** is specified for the **cdnptype** or **cgnptype** parameter, and the CdPN or CgPN RTDB lookup returns entity type SP.

**Range:** 1-15 digits, **none**

1-15 hexadecimal digits. Valid digits are **0-9**, **a-f**, **A-F**.

**none**—a default RN is not used

**Default:** No change to the current value

**System**

**Default:** **none**

**:sporttype=** (optional)

Service Portability type. This parameter specifies whether Service Portability is performed for the Info Analyzed Relay (IAR) NP feature.

**Range:** **gsm**, **is41**, **all**, **none**

**gsm**— Apply Service Portability prefix (RTDB 'GRN' entity id ) for own-network GSM subscribers

**is41**— Apply Service Portability prefix (RTDB 'GRN' entity id) for own-network IS41 subscribers



**all**— Apply Service Portability prefix (RTDB 'GRN' entity id) for all own-network (IS41 and GSM) subscribers  
**none**— Service Portability is not performed for the feature.

**Default:** No change to the current value

**System**

**Default:** none

### Example

```
chg-tatropts:cdnptype=always:sporttype=is41
chg-tatropts:cgnptype=sp
chg-tatropts:cgpaccck=always
chg-tatropts:df1trn=123456789012345
```

### Dependencies

At least one optional parameter must be specified.

The IAR Base feature must be enabled before this command can be entered.

The IAR Number Portability and the Service Portability features must be enabled before the **sporttype** parameter can be specified.

### Output

```
chg-tatropts:cdnptype=sp
tekelecstp 09-07-05 13:34:22 EST EAGLE 41.1.0
CHG-TATROPTS: MASP A - COMPLTD
;
```

## chg-th-alm

## Change Alarm Thresholds

Use this command to change the alarm thresholds and associated values. For additional information on these values, refer to the *Database Administration-SS7 Manual* in your EAGLE 5 ISS documentation set.

**Keyword:** chg-th-alm

**Related Commands:** rept-stat-sccp, rtrv-th-alm

**Command Class:** Database Administration

### Parameters

**:gttservlv1=** (optional)

The percentage for the SCCP GTT Service error ratio level 1 (lower) Threshold Alarm.

**Range:** 1-100

**Default:** 10

**:gttservlv2=** (optional)

The percentage for the SCCP GTT Service error ratio level 2 (upper) Threshold Alarm.

**Range:** 1-100

The value for the **gttservlv2** parameter must be greater than the value for the **gttservlv1** parameter.

**Default:** 20

**:imtbusutilvl1=** (optional)

The percentage for the IMT Bus Combined utilization level 1 Threshold Alarm (reported on IMT System).

**Range:** 35-70

**Default:** 70

**:imtbodyutllv2=** (optional)

The percentage for the IMT Bus Combined utilization level 2 Threshold Alarm (reported on IMT System).

**Range:** 40-80

This value must be greater than the value specified for the **imtbodyutllv1** parameter.

**Default:** 80

**:imtbodyestlv1=** (optional)

The percentage for the IMT Bus Congestion level 1 Threshold Alarm (reported on HIPR2 card).

**Range:** 35-70

**Default:** 70

**:imtbodyestlv2=** (optional)

The percentage for the IMT Bus Congestion level 2 Threshold Alarm (reported on HIPR2 card).

**Range:** 40-80

This value must be greater than the value specified for the **imtbodyestlv1** parameter.

**Default:** 80

**:lnptndblv1=** (optional)

The percentage for the TN Database provisioned level 1 (lower) Capacity Threshold Alarm.

**Range:** 1-100

**Default:** 80

**:lnptndblv2=** (optional)

The percentage for the LNP TN Database provisioned level 2 (upper) Capacity Threshold Alarm.

**Range:** 1-100

The specified value must be greater than the **lnptndblv1** parameter value.

**Default:** 95

**:nongttservlv1=** (optional)

The percentage for the SCCP Non-GTT Service (ATINPQ, GPORT, GFLEX, EIR, INPMR, INPQS, LNPMR, LNPQS, LRNQT, PLNPQS, TLNP, V-Flex, WNPQS) error ratio level 1 (lower) Threshold Alarm.

**Range:** 1-100

**Default:** 10

**:nongttservlv2=** (optional)

The percentage for the SCCP Non-GTT Service (ATINPQ, GPORT, GFLEX, EIR, INPMR, INPQS, LNPMR, LNPQS, LRNQT, PLNPQS, TLNP, V-Flex, WNPQS) error ratio level 2 (upper) Threshold Alarm.

**Range:** 1-100

**Default:** 20

**:sccpcalcmtbd=** (optional)

The TPS calculation method used to determine if the TPS Threshold Alarm levels have been exceeded or not.

**Range:** n, nplus1

n — All In Service Normal cards are used in the TPS calculation.

nplus1 — All In Service Normal cards minus 1 card are used in the TPS calculation.

**Default:** n

**:sccpthlv1intvl=** (optional)

The number of minutes during which the SCCP threshold level 1 alarm cannot be raised more than once.

**Range:** 0-1440

**Default:** 0

**:sccpthlv2intvl=** (optional)

The number of minutes during which the SCCP threshold level 2 alarm cannot be raised more than once.

**Range:** 0-1440

**Default:** 0

**:sccptpscap=** (optional)

The percentage for the SCCP Load Capacity Threshold Alarm.

**Range:** 1-100

**Default:** 80

**:thermallv1=** (optional)

Thermal Alarm Level 1 as a percentage of a card's thermal limit.

**Range:** 73-92

**:thermallv2=** (optional)

Thermal Alarm Level 2 as a percentage of a card's thermal limit.

**Range:** 74-100

### Example

```
chg-th-alm:lnptndblv1=85
chg-th-alm:sccptpscap=85
chg-th-alm:sccpalcmtld=nplus1
chg-th-alm:gttserlvl1=25:gttserlvl2=28
chg-th-alm:sccpthlv1intvl=20:sccpthlv2intvl=50
chg-th-alm:nongttserlvl1=30:nongttserlvl2=60
```

### Dependencies

Each Level 1 parameter value must be less than its corresponding Level 2 parameter value.

### Notes

To display the currently configured values for the Thermal Alarm Levels, use the **rtrv-th-alm** command.

HC MIM cards have a thermal operating limit of 82 degrees Celsius. The E5-E1T1, E5-ATM, E5-ENET, E5-IPSM, and E5-TSM cards have a thermal operating limit of 99 degrees Celsius.

The thermal threshold values represent a percentage of the thermal operating limit of a card.

### Output

```
chg-th-alm:thermallv1=85
rlghncxa03w 06-05-07 11:43:04 EST EAGLE 35.0.0
CHG-TH-ALM: MASP A - COMPLTD
;
```

## chg-tifopts

### Change TIF Options

Use this command to update the TIF Options table.

**NOTE: Values other than none that are entered for the dlma - dlmc parameters for the TIF services (TIF, TIF2, TIF3) using this command will overwrite values entered for those parameters using the chg-npp-serv command.**

**Keyword:** chg-tifopts

**Related Commands:** rtrv-tifopts

**Command Class:** Database Administration

### Parameters

**NOTE: As of Release 41.1, the acen parameter is no longer supported.**

**:condcgpn=** (optional)

This parameter indicates the preconditioning that is required when a CgPN lookup is needed.

**Range:** **addcc, none**  
**addcc, none** — The country code is added.

**Default:** **none**

**:crprel=** (optional)

This parameter specifies the ISUP Release cause for a message that is determined to be circular routed.

**Range:** **0-255**  
**Default:** **31** - normal, unspecified

**:dfltrn=** (optional)

Default routing number. This parameter provides a set of digits to substitute for a signalling point. This parameter is used with both calling party and called party numbers.

**Range:** 1-15 digits, **none**  
 1-15 hexadecimal digits. Valid digits are **0-9, a-f, A-F**.

**Default:** **none**

**:dlma=** (optional)

Delimiter A. This parameter specifies the digits used for Delimiter A in an NPP Formatting Action.

**Range:** 1-16 digits, **none**  
 1-16 hexadecimal digits. Valid digits are **0-9, a-f, A-F**.

**Default:** **none**

**:dlmb=** (optional)

Delimiter B. This parameter specifies the digits used for Delimiter B in an NPP Formatting Action.

**Range:** 1-16 digits, **none**  
 1-16 hexadecimal digits. Valid digits are 0-9, a-f, A-F.

**Default:** **none**

**:dlmc=** (optional)

Delimiter C. This parameter specifies the digits used for Delimiter C in an NPP Formatting Action.

**Range:** 1-16 digits, **none**  
 1-16 hexadecimal digits. Valid digits are **0-9, a-f, A-F**.

**Default:** **none**

**:iamcgpn=** (optional)

This parameter specifies the format of the outgoing CgPN digits.

**Range:** **rn, rndn, dn**  
**rn** — Replaces the CgPN with the RN.  
**rndn** — Adds the RN as a prefix to the CgPN.  
**dn** — Replaces the CgPN with the DN.

**Default:** **dn**

**:matchseq=** (optional)

This parameter specifies the DN lookup mechanism.

**Range:** **dn, nptype**

**dn**— The range database is searched only if the DN is not found during subscriber lookup.

**nptype**— The range database is searched if the DN is not found during subscriber lookup or if the located DN does not match the value specified for the **nptype** or **nptypecgpn** parameter.

**Default:** **dn**

**:npflag=** (optional)

This parameter specifies whether the **nm** parameter is modified in the IAM message to show that NP lookup has been performed.

The nm parameter exists only in incoming and outgoing IAM messages.

**Range:** **nm, none**

**nm, none**— Modifies the **nm** parameter.

**none**—Does not modify the **nm** parameter.

**Default:** **none**

**:nptypecgpn=** (optional)

NP entity type for the CgPN. This parameter specifies the entity type of the DN that is used to indicate that a successful NP lookup occurred.

**Range:** **sp, rn, sprn, all, rnsdpn, any**

**sp**— signaling point

**rn**— routing number

**sprn**— Lookup is successful if the value of the entity type is **sp** or **rn**.

**all**— Lookup is always considered successful.

**rnsdpn**— Lookup is successful if the value of the entity type is **rn, sp, or dn**.

**any**— Lookup is successful if the value of the entity type is **rn, sp, or no match with any entity**.

**:nptyperls=** (optional)

This parameter specifies the entity type of the DN that is used to indicate that a successful NP lookup occurred for the NPRLS and NPNRLS Service Actions.

**Range:** **sp, rn, sprn, all, rnsdpn, any**

**sp**— signaling point

**rn**— routing number

**sprn**— Lookup is successful if the value of the entity type is **sp** or **rn**.

**all**— Lookup is always considered successful.

**rnsdpn**— Lookup is successful if the value of the entity type is **rn, sp, or dn**.

**any**— Lookup is successful if the value of the entity type is **rn, sp, or no match with any entity**.

**Default:** No change to the current value

**System**

**Default:** **sprn**

**:nptyperly=** (optional)

This parameter specifies the entity type of the DN that is used to indicate that a successful NP lookup occurred for the NPRELAY Service Action.

**Range:** **sp, rn, sprn, all, rnsdpn, any**

**sp**— signaling point

**rn**— routing number

**sprn**— Lookup is successful if the value of the entity type is **sp** or **rn**.

**all**— Lookup is always considered successful.

**rnspdn**— Lookup is successful if the value of the entity type is **rn**, **sp**, or **dn**.

**any**— Lookup is successful if the value of the entity type is **rn**, **sp**, or no match with any entity.

**Default:** No change to the current value

**System**

**Default:** **sprn**

**:nsaddldata=** (optional)

This parameter specifies whether the incoming IAM Calling Party Category should be compared with the value for the **nspublic** parameter before performing Calling Party number substitution.

**Range:** **yes, no**

**yes**— Compare the Calling Party Category in the message with the **nspublic** parameter value.

**no**— Do not compare the Calling Party Category in the message with the **nspublic** parameter value.

**Default:** **no**

**:nspublic=** (optional)

This parameter specifies the value of the Calling Party Category that indicates that the Calling Party number is public.

**Range:** **0-255**

**Default:** **0**

**:rcausenp=** (optional)

This parameter specifies the value that is used for the release cause in an REL message when number portability occurs.

**Range:** **0-127**

**Default:** **0**

**:rcausepfx=** (optional)

This parameter specifies the value that is used for the release cause in an REL message when number portability does not occur.

**Range:** **0-127**

**Default:** **0**

**:rlcopc=** (optional)

This parameter specifies whether the value specified for the **rcause** parameter (see the **ent/chg-dstn** commands) overrides the values specified for the **rcausenp** and **rcausepfx** parameters.

**Range:** **off, on**

**off**— Use the values specified for the TIFOPTS **rcausenp** and **rcausepfx** parameters as the release cause in REL messages.

**on**— Use the value specified for the **rcause** parameter as the release cause in REL messages.

**Default:** **off**

**:rnrqd=** (optional)

This parameter specifies whether the redirection number is included in the release message when release handling is indicated.

**Range:** **yes, no**

**Default:** **yes**

**:sncgpndflt=** (optional)

This parameter specifies the digits to be used in calling number simple number substitution.

**Range:** 1-32 digits, **none**  
 1-32 hexadecimal digits. Valid digits are **0-9, a-f, A-F**.  
**Default:** **none**

**:spfill=** (optional)

This parameter specifies whether the **sp** entity type is populated if the value specified for the **defltn** or **grn** parameter is used for NPP processing.

**Range:** **off, on**  
**off**— do not populate the **sp** entity type  
**on**— populate the **sp** entity type

**Default:** No change to the current value

**System**

**Default:** **off**

**:splitiam=** (optional)

This parameter specifies when to split the IAM into IAM + 1 SAM.

**Range:** **15-31, none**

**Default:** **none**

**:sportrelay=** (optional)

This parameter specifies the Service Portability configuration option for the NPRELAY Service Action.

**Range:** **none, gsm, is41, all**  
**none**— Service Portability is not performed for this Service Action  
**gsm**— Apply Service Portability prefix (RTDB 'GRN' entity id ) for own-network GSM subscribers  
**is41**— Apply Service Portability prefix (RTDB 'GRN' entity id) for own-network IS41 subscribers  
**all**— Apply Service Portability prefix ('GRN' from RTDB entity) for all own-network (IS41 and GSM) subscribers

**Default:** No change to the current value

**System**

**Default:** **none**

**:sportrls=** (optional)

This parameter specifies the Service Portability configuration option for the NPRLS Service Action.

**Range:** **none, gsm, is41, all**  
**none**— Service Portability is not performed for this Service Action  
**gsm**— Apply Service Portability prefix (RTDB 'GRN' entity id ) for own-network GSM subscribers  
**is41**— Apply Service Portability prefix (RTDB 'GRN' entity id) for own-network IS41 subscribers  
**all**— Apply Service Portability prefix ('GRN' from RTDB entity) for all own-network (IS41 and GSM) subscribers

**Default:** No change to the current value

**System**

**Default:** **none**

**:aclen=** (obsolete)

Area code length. This parameter specifies the length of area code.  
 This parameter is used with the calling party number.

**Range:** **0-8**

**Default:** **0**

**Example**

```
chg-tifopts:dlma=1234567890
chg-tifopts:dlmb=1234567890123456
chg-tifopts:dlmc=1234567890abcdef
chg-tifopts:dfltrn=123456789012345
chg-tifopts:nptype=all
chg-tifopts:nsaddldata=yes:nspublic=5
```

**Dependencies**

At least one optional parameter must be specified.

At least one of the following features must be enabled before this command can be entered.

- TIF Additional Subscriber Data
- TIF Generic Routing Number
- TIF Number Portability
- TIF Number Substitution
- TIF SCS Forwarding
- TIF Simple Number Substitution

If the TIF ASD feature is turned on, then the **matchseq=nptype** parameter cannot be specified.

If the TIF GRN feature is turned on, then the **matchseq=nptype** parameter cannot be specified.

The TIF Number Portability feature must be enabled before the **matchseq=nptype** parameter can be specified.

If the TIF Number Substitution feature is enabled, then the **matchseq=nptype** parameter cannot be specified.

The TIF Number Substitution feature must be enabled before the **nsaddldata** parameter or the **nspublic** parameter can be specified.

If the **matchseq=nptype** parameter is specified, then the only value that can be specified for the **sportrelay** or **sportrls** parameter is **none**. If the **sportrelay** or **sportrls** parameter has a value other than **none**, then the **matchseq=nptype** parameter cannot be specified.

The S-Port feature must be enabled before the **sportrelay** or **sportrls** parameter can be specified.

**Notes**

None

**Output**

```
chg-tifopts:nsaddldata=yes:nspublic=5
tekelecstp 09-03-05 09:36:03 EST EAGLE 41.0.0
CHG-TIFOPTS: MASP A - COMPLTD
;
```

**chg-tinpopts****Change TINP Options**

Use this command to update the TINPOPTS table. The TINP options are used to perform tasks such as number conditioning and response generation.



**NOTE: This command is obsolete.**

**Keyword:** chg-tinpopts

**Related Commands:** rtrv-tinpopts

**Command Class:** Database Administration

## Parameters

**:dlthomern=** (optional)

This parameter specifies whether the home routing number (HomeRN) is deleted from the CdPN in the incoming IAM message before Number Portability (NP) database lookup is performed.

**Range:** **always, none**  
**always, none** — Deletes the HomeRN, if present.  
**none** — Does not delete the HomeRN.

**:dnfmt=** (optional)

Dialed number (DN) encoding scheme. This parameter specifies how the DN in the REL or IAM message is encoded.

**Range:** **rn, rndn, ccrndn, pfxrndn**  
**rn** — Encoded with the RN.  
**rndn** — Encoded with the RN+DN. The number in the incoming IAM message is used as the DN.  
**ccrndn** — Encoded with the country code (CC)+RN+DN.  
**pfxrndn** — Encoded with the prefix +RN.

**Default:** **rn**

**:dnnai=** (optional)

DN Nature of Address (NAI) value. This parameter specifies the NAI that is used in the DN for the outgoing REL or IAM message.

**Range:** **0-15 none**  
**none** — Uses the NAI value from the incoming IAM message.

**:iamact=** (optional)

IAM action. This parameter specifies the action that the STP performs on IAM messages.

**Range:** **relay, release, none**  
**relay** — Modifies the outgoing IAM message if RTDB lookup is successful.  
**release** — Discards the IAM message and generates an ISUP REL message if NP database lookup is successful.  
**none** — Turns off the handling of IAM messages on the STP.

**Default:** **relay**

**:iamcgpn=** (optional)

This parameter specifies whether the CgPN of an incoming IAM message is looked up in the NP database and modified.

**Range:** **rn, rndn, none**  
**rn, none** — Replaces the CgPN with the RN.  
**rndn, none** — Adds the RN as a prefix to the CgPN.  
**none** — Does not look up the CgPN in the NP database.

**Default:** **none**

**:npflg=** (optional)

This parameter specifies whether the **nm** parameter is modified in the IAM message to show that RTDB lookup has been performed.

The **nm** parameter exists only in incoming and outgoing IAM messages.

**Range:** **nm, none**

**nm, none** — Modifies the **nm** parameter.  
**none**—Does not modify the **nm** parameter.

**Default:** **none**

**:nptype=** (optional)

NP entity type. This parameter specifies the entity type of the DN that is used to indicate that a successful RTDB lookup occurred.

**Range:** **sprn, sp, rn, all**

**sprn** — Lookup is successful if the value of the entity type is **sp** or **rn**.

**sp** — signaling point

**rn** — routing number

**all** — Lookup is successful if the value of the entity type is **sp** or **rn**, or if no entity type is found.

**Default:** **sprn**

**:rcausenp=** (optional)

This parameter specifies the result of an RTDB lookup that causes an REL message to be issued.

**Range:** **0-127**

**:rcausepfx=** (optional)

This parameter specifies the prefix that causes an REL message to be issued without performing an RTDBlookup.

**Range:** **0-127**

**:snai=** (optional)

This parameter specifies the field in the incoming IAM message that is used to modify the DN before NP lookup is performed.

**Range:** **intl, nat, iamnai**

**intl** — The IAM message is not modified.

**nat** — Adds the CC to the DN.

**iamnai** — Modifies the DN with the NAI value from the IAM message. If the NAI value is *sub*, then the CC+RN is added. If the NAI value is *national*, then the CC is added. If the NAI value is *intl*, then the DN is not modified. If the NAI is any other value, then the NAI is treated as an *intl* format.

## Example

```
chg-tinpopts:iamact=release
```

## Dependencies

At least one optional parameter must be specified.

The **chg-tinpopts** command cannot be entered unless the TINP feature was enabled before upgrading to Release 39.2 or later.

## Notes

None

## Output

```
chg-tinpopts:iamact=release
tekelecstp 08-02-26 12:03:28 EST EAGLE 38.0.0
CHG-TINPOPTS: MASP A - COMPLTD
;
```

**chg-trm****Change Terminal**

Use the change terminal command to configure the operational characteristics of each of the 40 terminal ports used to connect modems, printers, and terminals to the system.

**Keyword:** **chg-trm**

**Related Commands:** **act-echo, canc-echo, chg-trm, dact-echo, inh-trm, rept-stat-trm, rmv-trm, rst-trm, rtrv-trm**

**Command Class:** Database Administration

**Parameters**

**NOTE: The following parameters are no longer available: lnpdb, lnpsub**

**:trm=** (mandatory)

Terminal. This parameter specifies the ID number of the terminal whose characteristics are to be changed.

**Range:** **1-40**

**:all=** (optional)

This parameter specifies whether to display unsolicited messages of all types (TRAF, LINK, SA, DB, SYS, PU, UIMRD, APPSERV, APPSS, CARD, CLK, DBG, GTT, GWS, MEAS, MON, MPS, SEAS, SLAN) in the scroll area.

**Range:** **yes, no**  
**yes**—Receive all.  
**no**—Receive none.

**Default:** **yes**—If **type=emsalm** is specified  
 Current value—if **type** parameter value is not **emsalm**

**:appserv=** (optional)

Application server. This parameter specifies whether to display UAMs and UIMs assigned to the Application Server output group in the scroll area.

**Range:** **yes, no**  
**yes**—Receive all.  
**no**—Receive none.

**Default:** If **all** is specified—current **all** value  
 If **all** is not specified—current **appserv** value.  
 If **type=emsalm** is specified—**yes**

**System**

**Default:** **no**

**:appss=** (optional)

Application subsystem. This parameter specifies whether to display UAMs and UIMs assigned to the Application Subsystem output group in the scroll area

**Range:** **yes, no**  
**yes**—Receive all.  
**no**—Receive none.

**Default:** If **all** is specified—current **all** value  
 If **all** is not specified—current **appss** value.  
 If **type=emsalm** is specified—**yes**

**System**

**Default:** **no**

**:baud=** (optional)

This parameter specifies the line speed (baud rate) for this terminal's serial port connection.

**Range:** **2400, 4800, 9600, 19200**

**Default:** If **type=oap**—**19200**  
If **type** is **not oap**—no change to current value.

**System**  
**Default:** **9600**

**:card=** (optional)

This parameter specifies whether to display UAMs and UIMs assigned to the Card output group in the scroll area.

**Range:** **yes, no**  
**yes**—Receive all.  
**no**—Receive none.

**Default:** If **all** is specified—current **all** value  
If **all** is not specified—current **card** value.  
If **type=emsalm** is specified—**yes**

**System**  
**Default:** **no**

**:clk=** (optional)

Clock. This parameter specifies whether to display UAMs and UIMs assigned to the Clock output group in the scroll area.

**Range:** **yes, no**  
**yes**—Receive all.  
**no**—Receive none.

**Default:** If **all** is specified—current **all** value  
If **all** is not specified—current **clk** value.  
If **type=emsalm** is specified—**yes**

**:db=** (optional)

Database. This parameter specifies whether to display database-related unsolicited messages in the scroll area.

**Range:** **yes, no**  
**yes**—Receive all.  
**no**—Receive none.

**Default:** If **all** is specified—current **all** value  
If **all** is not specified—current **db** value.  
If **type=emsalm** is specified—**yes**

**System**  
**Default:** **no**

**:dbg=** (optional)

Debug. This parameter specifies whether to display UAMs and UIMs assigned to the Debug output group in the scroll area.

**Range:** **yes, no**  
**yes**—Receive all.  
**no**—Receive none.

**Default:** If **all** is specified—current **all** value  
If **all** is not specified—current **dbg** value.  
If **type=emsalm** is specified—**yes**

**System**  
**Default:** **no**

**:dural=** (optional)

Terminal lockout time. This parameter specifies the length of time the terminal is disabled after each failed login/unlock attempt in excess of the threshold configured on the **mxinv** parameter. The value

can be specified as seconds (*ss*); minutes and seconds (*mms*); or hours, minutes, and seconds (*hmmss*).

**Range:**     **0-999999**  
                   **0-59** (*ss*)  
                   **0-5959** (*mms*)  
                   **0-995959** (*hmmss*)  
                   **999999**

**Default:**     Current value.

**System**

**Default:**     **100** - 1 minute, 0 seconds

**:fc=** (optional)

Flow control. This parameter specifies the type of flow control used to regulate the flow of data between the system and an RS-232 connected device, so that no characters are lost (especially at high baud rates). The control setting of the system and the connected device must match.

**Range:**     **hw, sw, both, none**  
                   **hw**—hardware flow control  
                   **sw**—software flow control  
                   **both**—hardware and software flow control  
                   **none**—neither hardware nor software flow control

**Default:**     If **type=oap**—**sw**  
                   If **type** is **not oap**—no change to current value.

**System**

**Default:**     **sw**

**:gtt=** (optional)

This parameter specifies whether to display UAMs and UIMs assigned to the GTT output group in the scroll area.

**Range:**     **yes, no**  
                   **yes**—Receive all.  
                   **no**—Receive none.

**Default:**     If **all** is specified—current **all** value  
                   If **all** is not specified—current **gtt** value.  
                   If **type=emsalm** is specified—**yes**

**:gws=** (optional)

This parameter specifies whether to display UAMs and UIMs assigned to the GWS output group in the scroll area.

**Range:**     **yes, no**  
                   **yes**—Receive all.  
                   **no**—Receive none.

**Default:**     If **all** is specified—current **all** value  
                   If **all** is not specified—current **gws** value.  
                   If **type=emsalm** is specified—**yes**

**System**

**Default:**     **no**

**:link=** (optional)

This parameter specifies whether to display link maintenance-related unsolicited messages in the scroll area.

**Range:**     **yes, no**  
                   **yes**—Receive all.  
                   **no**—Receive none.

**Default:**     If **all** is specified—current **all** value  
                   If **all** is not specified—current **link** value.

If **type=emsalm** is specified—**yes**

**:logintmr=** (optional)

Login timer. This parameter specifies the amount of time, in seconds, allowed for a user to log into a Telnet terminal after selecting the terminal.

This parameter applies to Telnet terminals.

**Range:** **3-600 none**

**none**—Login can occur at any time after selecting the terminal.

**Default:** No change to the current value

**System**

**Default:** **none**

**:logouttmr=** (optional)

Logout timer. This parameter specifies the amount of time, in seconds, before the Telnet session closes after the user manually or automatically logs out.

This parameter applies to Telnet terminals.

**Range:** **0-1200 none**

**none**—The Telnet session does not close after logout.

**Default:** No change to the current value

**System**

**Default:** **none**

**:meas=** (optional)

Measurement. This parameter specifies whether to display UAMs and UIMs assigned to the Measurements Maintenance output group in the scroll area.

**Range:** **yes, no**

**yes**—Receive all.

**no**—Receive none.

**Default:** If **all** is specified—current **all** value

If **all** is not specified—current **meas** value.

If **type=emsalm** is specified—**yes**

**System**

**Default:** **no**

**:mon=** (optional)

Monitor. This parameter specifies whether to display UAMs and UIMs assigned to the Monitor output group in the scroll area.

**Range:** **yes, no**

**yes**—Receive all.

**no**—Receive none.

**Default:** If **all** is specified—current **all** value

If **all** is not specified—current **mon** value.

If **type=emsalm** is specified—**yes**

**:mps=** (optional)

This parameter specifies whether to display UAMs and UIMs assigned to the MPS output group in the scroll area.

**Range:** **yes, no**

**yes**—Receive all.

**no**—Receive none.

**Default:** If **all** is specified—current **all** value

If **all** is not specified—current **mps** value.

If **type=emsalm** is specified—**yes**

**:mxinv=** (optional)

Login/unlock failure threshold. When a login or unlock failure occurs on a terminal, a counter of successive login failures is incremented by one. After the increment, if the counter is greater than or equal to the mxinv parameter value, the system sends an information message to all system administrator ports and locks out the port temporarily. The port is locked out for an interval that is specified in the dural parameter.

To disable the info message and temporary lockout function for the terminal, specify **mxinv=0**.

**Range:** 0-9

**Default:** Current value.

**System**

**Default:** 5 - successive failed login/unlock attempts

**:pngfailcnt=** (optional)

Ping fail count. This parameter specifies the number of consecutive ping fails that must occur before the Telnet connection is dropped.

This parameter applies to Telnet terminals or to EMSALM terminals that have Telnet connections.

**Range:** 1-10

**Default:** No change to the current value

**System**

**Default:** 1

**:pngtimeint=** (optional)

Ping time out. This parameter specifies the amount of time, in milliseconds, that must pass before the IPSM card initiates a new ping cycle.

This parameter applies to Telnet terminals or to EMSALM terminals that have Telnet connections.

**Range:** 100-120000 none

none—Pinging does not occur.

**Default:** No change to the current value

**System**

**Default:** none

**:prty=** (optional)

Parity. This parameter specifies the parity for this terminal's serial port connection.

**Range:** none, even, odd

**Default:** If type=oap—even

If type is not oap—current value.

**System**

**Default:** even

**:pu=** (optional)

Program update. This parameter specifies whether to display program update-related unsolicited messages in the scroll area.

**Range:** yes, no

yes—Receive all.

no—Receive none.

**Default:** If all is specified—current all value

If all is not specified—current pu value.

If type=emsalm is specified—yes

**:sa=** (optional)

Security administration. This parameter specifies whether to display security administration-related unsolicited messages in the scroll area.

**Range:** yes, no

yes—Receive all.

**Default:** **no**—Receive none.  
 If **all** is specified—current **all** value  
 If **all** is not specified—current **sa** value.  
 If **type=emsalm** is specified—**yes**

**:sb=** (optional)

Stop bit. This parameter specifies the number of stop bits used in communications with the terminal.

**Range:** **1-2**  
**Default:** If **type=oap**—**1**  
 If **type** is **not oap**—current value.

**System**

**Default:** **1**

**:seas=** (optional)

This parameter specifies whether to display UAMs and UIMs assigned to the SEAS Maintenance output group in the scroll area.

**Range:** **yes, no**  
**yes**—Receive all.  
**no**—Receive none.  
**Default:** If **all** is specified—current **all** value  
 If **all** is not specified—current **seas** value.  
 If **type=emsalm** is specified—**yes**

**:slan=** (optional)

This parameter specifies whether to display UAMs and UIMs assigned to the SLAN Maintenance output group in the scroll area.

**Range:** **yes, no**  
**yes**—Receive all.  
**no**—Receive none.  
**Default:** If **all** is specified—current **all** value  
 If **all** is not specified—current **slan** value.  
 If **type=emsalm** is specified—**yes**

**System**

**Default:** **no**

**:sys=** (optional)

System. This parameter specifies whether to display system maintenance-related unsolicited messages in the scroll area.

**Range:** **yes, no**  
**yes**—Receive all.  
**no**—Receive none.  
**Default:** If **all** is specified—current **all** value  
 If **all** is not specified—current **sys** value.  
 If **type=emsalm** is specified—**yes**

**:tmout=** (optional)

Maximum channel idle time. This parameter specifies the maximum amount of time in minutes that a login session can remain idle (that is, no user input) on a terminal before being automatically logged off. To disable idle time monitoring for a terminal, specify **tmout=0**.

**Range:** **0-99**  
**Default:** Current value.  
**System**  
**Default:** **30** - minutes



**:traf=** (optional)

Traffic. This parameter specifies whether to display traffic-related unsolicited messages displayed in the scroll area.

**Range:**     **yes, no**  
               **yes**—Receive all.  
               **no**—Receive none.

**Default:**   If **all** is specified—current **all** value  
               If **all** is not specified—current **traf** value  
               If **type=emsalm** is specified—**yes**

**System**

**Default:**   **no**

**:type=** (optional)

This parameter specifies the type of device being connected to this terminal.

**Range:**     **vt320, ksr, oap, printer, sccs, mgmt, telnet, emsalm, none, seas**  
               The **type=emsalm** parameter value is valid for terminals 1-40.  
               Only **telnet, emsalm, seas,** and **none** are valid values for terminals 17 - 40.

**Default:**   Current value.

**System**

**Default:**   **vt320** - for terminals 1-16  
               **telnet** - for terminals 17-40

**:uimrd=** (optional)

Unsolicited messages. This parameter specifies whether to display the unsolicited messages assigned to this group.

**Range:**     **yes, no**  
               **yes**—Receive all.  
               **no**—Receive none.

**Default:**   If **all** is specified—current **all** value  
               If **all** is not specified—current **uimrd** value.  
               If **type=emsalm** is specified—**yes**

**System**

**Default:**   **no**

**Example**

```
chg-trm:trm=8:type=oap:all=yes
chg-trm:trm=13:type=ksr:baud=9600:uimrd=yes
chg-trm:trm=1:link=yes:sys=yes:db=yes
chg-trm:trm=17:all=yes
chg-trm:trm=22:type=none
chg-trm:trm=10:link=yes:card=yes:clk=yes
chg-trm:trm=1:type=ksr:gtt=yes
chg-
trm:trm=2:appserv=no:appss=yes:card=yes:clk=no:dbg=no:gtt=yes:gws
=no :meas=yes:mon=no:mps=yes:seas=no:slan=yes
chg-trm:trm=17:type=seas
chg-trm:trm=17:logintmr=50
chg-trm:trm=17:logouttmr=50
chg-trm:trm=17:pngtimeint=1000
```

**chg-trm:trm=17:pngfailcnt=5**

### Dependencies

At least one optional parameter must be specified.

The system requires that at least two terminals be configured as security administration terminals. If only two security administration terminals are configured, the value of the **type** parameter cannot be changed to a value that would make the terminal unusable (**oap**, **printer**, or **none**) because only one security administration terminal would remain.

The combined total line speed (baud rate) for all active terminal ports cannot exceed **168,000**. This value allows for 16 terminal to be configured at 9600 bps each.

If the **prty=none** parameter is specified, then the **type=vt320** parameter cannot be specified. A VT320 terminal does not support 7-bit data bytes and no parity. The number of data bits cannot be changed.

If the **prty=none** parameter is specified, then the **type=scs** parameter cannot be specified.

For terminals 1 – 16, the **type=telnet** parameter cannot be specified.

For terminals 17 - 40, the value of the **type** parameter must be **telnet**, **seas**, **emsalm**, or **none**.

If the **type=telnet terminal** parameter is specified, then the **baud**, **prty**, **sb**, and **fc** parameters cannot be specified.

If the value of the **type** parameter is **telnet**, **seas**, or **emsalm**, and if the value of the **trm** parameter is 17-40, then an IPSM card must be equipped in the system. Parameters for these terminals cannot be changed unless an IPSM card has been added for the target terminal.

**NOTE: If you install one IPSM card, telnet terminals 17-24 are available. If you install two IPSM cards, telnet terminal IDs 17-32 are available. If you install three IPSM cards, telnet terminal IDs 17-40 are available. If you remove an installed IPSM card, the eight terminal IDs that were assigned to that card are no longer available. For example, if you install three IPSM cards, and remove the second card that was installed, telnet terminal IDs 17-24 and 33-40 are available. To make the IDs consecutive again, you would need to remove and reinstall the third card that was previously installed. Then its available terminal IDs change from 33-40 to 25-32. You can enter the rtrv-trm command to display the available telnet terminal IDs.**

The terminal port must be inhibited (see the **inh-trm** command) before the **type**, **baud**, **prty**, **sb** and **fc** parameters can be changed. The **all**, **traf**, **link**, **sa**, **db**, **sys**, **uimrd**, and **pu** parameters can be changed on any terminal, including the one in use, regardless of the port status (inhibited or allowed).

The port cannot be removed from service (**rmv-trm**) when the **type**, **baud**, **prty**, **sb**, and **fc** parameters are being changed.

The SEAS feature must be on before the **type=oap** parameter can be specified (see the **rtrv-feat** command output SEAS=ON entry).

The IP User Interface (Telnet) feature must be enabled and turned on before the **type=telnet** parameter (IDs 17-40) or the **type=emsalm** parameter (IDs 1-40).can be specified.

A maximum of two OAP terminals (**type=oap** parameter) can be configured for SEAS.

If the **type=oap** parameter is specified, then the **baud**, **prty**, **sb**, and **fc** parameters cannot be specified.

The **baud**parameter value must be **2400**, **4800**, **9600**, or **19200**.

The specified terminal must be inhibited before the **type=seas** parameter can be specified.

If the specified terminal is a SEAS Terminal, then the SEAS output group cannot be turned off.

If the SEAS Over IP feature is turned on, then an E5-IPSM card must be provisioned at the location corresponding to the specified SEAS terminal.

The SEAS Over IP feature must be enabled before the **type=seas** parameter can be specified.

The **type=seas** parameter cannot be specified under the following conditions:

- The value of the **trm** parameter is **1 - 16**.
- Specifying the parameter results in more than one SEAS terminal on an E5-IPSM card.
- Specifying the parameter results in more than two SEAS terminals in the EAGLE 5 ISS.
- An E5-IPSM card is not physically present in the corresponding location.
- An available (unconfigured) SEAS terminal does not exist in the SEASCFG table.

The IP User Interface feature must be turned on before the value of the **type** parameter can be **telnet**, **seas**, **emsalm**, or **none**.

The **type=telnet** parameter must be specified before the **logintmr** and **logouttmr** parameters can be specified.

If the value specified for the **type** parameter is **seas** or **none**, then the **pngtimeint** and **pngfailcnt** parameters cannot be specified.

The terminal must be in the Inhibited state before the **logintmr**, **logouttmr**, **pngtimeint**, and **pngfailcnt** parameters can be specified.

## Notes

Refer to Appendix E, “Unsolicited Output Message Groups,” in the *EAGLE 5 ISS Maintenance Manual* for a list of unsolicited output messages that you might see for each output group.

This command cannot be entered when an upgrade is in progress.

If your terminal has the auto-wrap feature, you must disable the feature to use the terminal on the system.

To disable the informational message and temporary port lockout feature for a terminal, specify the **mxinv=0** parameter.

To prevent a terminal from being disabled, specify the **dural=0** parameter.

To make the lockout period for a terminal indefinite, specify the **dural=999999** parameter. When disabled, a terminal remains disabled until the port is inhibited (**inh-trm** command) and then allowed (**alw-trm** command).

Terminal idle time monitoring and auto-logout applies only if the terminal **type** is **vt320**, **ksr**, or **sccs**. The **chg-trm** command can be entered with a **tmout** parameter value for other terminal types, but it has no effect.

Using the terminal type of **none** (**type=none**) conveys to the terminal processor that a particular port is not connected or is no longer in use. The terminal processor does not service output queues for a terminal port that is configured as **type=none**.

When the terminal type for a terminal is changed to **type=emsalm**, the value for all output group parameters is set to **yes**.

When the terminal type for a terminal is changed from **type=emsalm** to another type, the current value for all output groups is not changed. A command must be entered to change one or more output group values to another value.

**NOTE: Though the output groups are set to yes, terminals of type emsalm do not display any reports or any UIMs except "UIM 1083 system alive".**

The number of data bits cannot be changed; it is set to 7.

Software flow control (XON and XOFF pacing), involves sending control codes between the system and the connected device.

Hardware flow control (RTS and CTS pacing) uses the RTS and CTS lines of the RS-232 interface to pause and restart the flow of data between the system and the connected device.

Software flow control is recommended if the connected device is a printer. Both software and hardware flow control are highly recommended if the connected device is a modem.

To connect a modem, specify the **type=vt320** parameter.

The **all** parameter cannot be specified in the command with the other message status parameters (**traf**, **link**, **sa**, **db**, **sys**, or **pu**). If the **all** parameter and other message status parameters are specified together in the command, the terminal is assigned the other specified message status parameters and the **all** parameter is ignored.

If a SEAS terminal is being removed, then a warning that states "Invalidating the Terminal data in SEASCFG table" appears.

If the SEAS output group is turned off for a SEAS terminal, then a message "SEAS Output Group is SET for SEAS Terminal *trm number*" appears.

## Output

```
chg-trm:trm=2:all=yes
rlghncxa03w 04-05-07 11:11:28 EST EAGLE 31.5.0
CHG-TRM: MASP A - COMPLTD
;
```

## chg-ttmap

### Change Translation Type Mapping

Use this command to change a mapped SS7 message translation type (TT) for a given gateway linkset name. With this command you can change the identification of the type of allowed global title translation in the SS7 message before and after translation type mapping. For example, suppose you are mapping the translation type 001 (before TT mapping) to 238 (after TT mapping). You can use this command to change that mapping to 001 (before) to 254 (after).

**Keyword:** **chg-ttmap**

**Related Commands:** **dlt-ttmap**, **ent-ttmap**, **rtrv-ttmap**

**Command Class:** Database Administration

## Parameters

**:ett=** (mandatory)

Translation type before mapping. The identification of the type of global title translation in the SS7 message *before* translation type mapping. This attribute is the decimal representation of the 1-octet binary field used by the SS7 protocol to identify the translation type.

**Range:** **0-255**

**:io=** (mandatory)

Incoming or outgoing. The system uses this parameter to indicate whether the translation type mapping data provisioned for the gateway linkset is for SS7 messages *received* or *sent* on the linkset.

**Range:** **i, o**  
**i**—incoming  
**o**—outgoing

**:lsn=** (mandatory)

Linkset name. The unique network identifier for the gateway linkset.

**Range:** *aaaaaaaaaa*  
 1 alphabetic character followed by 9 alphanumeric characters

**:mtt=** (mandatory)

Mapped translation type. The identification of the type of global title translation in the SS7 message *after* translation type mapping. This attribute is the decimal representation of the 1-octet binary field used by the SS7 protocol to identify the translation type.

**Range:** 0-255

### Example

```
chg-ttmap:lsn=nc001:io=o:ett=128:mtt=55
```

### Dependencies

The linkset must be defined.

### Notes

None

### Output

```
chg-ttmap:lsn=nc001:io=o:ett=128:mtt=55
```

```
rlghncxa03w 04-01-22 10:37:07 EST EAGLE 31.3.0
CHG-TTMAP: MASP A - COMPLTD
```

```
TTMAP table for nc001 is (2 of 64) 3% full
```

```
;
```

## chg-ttr-msg

## Change Triggerless TCAP Relay Message

Use this command to revise a Triggerless TCAP Relay message.

**Keyword:** chg-ttr-msg

**Related Commands:** rtrv-ttr-msg, tst-msg

**Command Class:** Database Administration

### Parameters

**:msgn=** (mandatory)

Message number. This parameter specifies the number of the TTR message.

**Range:** 1-10

**:active=** (optional)

This parameter specifies whether the TTR message is sent to the network card for processing.

**Range:** yes, no

**yes** — The message is sent to the network card.

**no** — The message is not sent to the network card.

**Default:** no

**:bcm=** (optional)

Basic call state model. This parameter specifies the value for the *EventTypeBCSM* field of the TTR message.

**Range:** 1-2 digits

2 hexadecimal digits. Valid digits are **0-9, a-f, A-F**.

**Default:** No change to the current value

**:cdpadgts=** (optional)

Called party address digits. This parameter specifies the SCCP CdPA digits for the IDP message.

**Range:** 1-15 digits

1 - 15 hexadecimal digits. Valid digits are **0-9, a-f, A-F**.

- Default:** No change to the current value
- :cdpagt=** (optional)  
Called party address global title. This parameter specifies the SCCP CdPA GT for the IDP message.  
**Range:** 0-15  
**Default:** No change to the current value
- :cdpagtnai=** (optional)  
Called party address global title nature of address indicator. This parameter specifies the SCCP CdPA GT NAI for the IDP message.  
**Range:** 0-127  
**Default:** No change to the current value
- :cdpndgts=** (optional)  
Called party number digits. This parameter specifies the TCAP CdPN digits for the IDP message.  
**Range:** 1-32 digits  
1 - 32 hexadecimal digits. Valid digits are **0-9, a-f, A-F**.  
**Default:** No change to the current value
- :cdpnnai=** (optional)  
Called Party Number Nature of Address Indicator. This parameter specifies the value for TCAP CdPN NAI value for the IDP message.  
**Range:** 0-127  
**Default:** No change to the current value
- :cgpagdts=** (optional)  
Calling party address digits. This parameter specifies the SCCP CgPA digits for the IDP message.  
**Range:** 1-15 digits  
Range is 1 - 15 hexadecimal digits. Valid digits are **0-9, a-f, A-F**.  
**Default:** No change to the current value
- :cgpagt=** (optional)  
Calling party address global title. This parameter specifies the SCCP CgPA GT for the IDP message.  
**Range:** 0-15  
**Default:** No change to the current value
- :cgpagtnai=** (optional)  
Calling party address global title nature of address indicator. This parameter specifies the SCCP CgPA GT NAI for the IDP message.  
**Range:** 0-127  
**Default:** No change to the current value
- :cgpndgts=** (optional)  
Calling party number digits. This parameter specifies the TCAP CgPN digits in the IDP message.  
**Range:** 1-32 digits  
1- 32 hexadecimal digits. Valid digits are **0-9, a-f, A-F**.  
**Default:** No change to the current value
- :cgpnnai=** (optional)  
Calling party number nature of address indicator. This parameter specifies the TCAP CgPN NAI in the IDP message.  
**Range:** 0-127  
**Default:** No change to the current value
- :lacdgt=** (optional)  
Location area code digits. This parameter specifies the area code if the value is not provided in the CdPN.

**Range:** 1-6 digits  
1 - 6 hexadecimal digits. Valid digits are **0-9, a-f, A-F**.

**Default:** No change to the current value

**:reset=** (optional)

This parameter resets all of the parameters to their default values.

**Range:** **yes**  
**yes** — Resets all message parameters to their default values

**Default:** No change to the current value

**:sk=** (optional)

Service key. This parameter specifies the service key for the IDP message.

**Range:** 8 digits  
8 hexadecimal digits. Valid digits are **0-9, a-f, A-F**.

**Default:** No change to the current value

**:tcapttype=** (optional)

This parameter specifies whether the IDP message is Intelligent Network Application Protocol-based (INAP) or Camel Application Protocol-based (CAP).

**Range:** **inap, cap**  
**inap** — INAP-based  
**cap** — CAP-based

**Default:** No change to the current value

### Example

```
chg-ttr-
msg:msgn=1:tcapttype=INAP:cdpnnai=4:cdpadgts=12457896abcd:cgpnnai=
4
chg-ttr-
msg:msgn=1:cdpnnai=2:cdpndgts=981123456:sk=00006b00:bcsm=02
```

### Dependencies

The Prepaid IDP Query Relay feature must be enabled before this command can be entered.

If the **tcapttype** parameter is specified, then the **cdpnnai** and the **cgpnnai** parameters must be specified.

If the **reset** parameter is specified, then no other parameters can be specified.

At least one optional parameter must be specified.

### Output

```
chg-ttr-
msg:msgn=1:tcapttype=CAP:cdpnnai=4:cdpndgts=987654321:cgpnnai=4
tekelecstp 08-05-05 15:58:08 EST EAGLE 39.0.0
CHG-TTR-MSG: MASP A - COMPLTD
;
```

## chg-ttropts

### Change TTR Options

Use this command to enter Triggerless TCAP Relay (TTR)-specific options in the database. This command updates the TTROPTS table.

**NOTE: Values other than none that are entered for the dlma - dlmc parameters for the IDP Relay services (IDPRCDPN, IDPRCGPN) using this command will overwrite values entered for those parameters using the chg-npp-serv command.**

**Keyword:** chg-ttropts

**Related Commands:** rtrv-ttropts

**Command Class:** Database Administration

## Parameters

**:cgnptype** = (optional)

CgPN database lookup type. This parameter specifies the entity type that is considered a success when used for RTDB lookup.

**Range:** **sp, rn, rnspl, anymatch, always, rnspldn**

**sp**— Service Provider

**rn**— Routing Number

**rnspl**— **rn** or **sp**

**anymatch**— **rn, sp**, or no match with any entity

**always**— Lookup is always considered successful

**rnspldn**— **rn, sp**, or **dn**

If the **cgnptype=anymatch** parameter is specified, then the value is also used as the RN for the outgoing CgPN.

**Default:** **rnspl**

**:cgpaccek**= (optional)

CgPA country code check. This parameter specifies whether a DEFCC check is performed on the incoming CgPA.

**Range:** **always, nonintl, off**

**always**— The DEFCC check is always performed.

**nonintl**— The DEFCC check is performed if the CdPN NAI is not 'International'.

**off**— The DEFCC check is not performed.

**Default:** **nonintl**

**:cgpnskrtg**= (optional)

This parameter specifies whether SK routing occurs if IDP A-Party routing fails.

**Range:** **no, yes**

**no**— SK routing does not execute if IDP A-Party Routing fails.

**yes**— SK routing executes if IDP A-Party Routing fails.

**Default:** No change to the current value

**System**

**Default:** **no**

**:cgsnai**= (optional)

Calling party number nature of address indicator. This parameter specifies the CgPN NAI that is used during number conditioning.

**Range:** **incoming, intl, natl, unkn**

**incoming**— The incoming CgPN NAI is used.

**intl**— The CgPN NAI is set to 'International' (4).

**natl**— The CgPN NAI is set to 'National' (3).

**unkn**— The CgPN NAI is set to 'Unknown' (0).

A value of **incoming** must be specified before the **intl, natl, nai1, nai2, nai3**, and **unkn** parameters in the **chg-npp-serv** command can be changed to non-default values for the the IDPRCGPN service.

**Default:** **incoming**



**:dfltrn=** (optional)

Default routing number. This parameter specifies the default RN that is used when a value of **sp** or **rnsp** is specified for the **nptype** parameter, and the CdPN RTDB lookup returns entity type SP.

**Range:** 1-15 digits, **none**  
 1-15 hexadecimal digits. Valid digits are **0-9, a-f, A-F**.  
**none**—a default RN is not used

**Default:** **none**

**:dlma=** (optional)

Delimiter A. This parameter specifies the first delimiter that is used to format the outgoing TCAP dialed number.

**Range:** 1-16 digits, **none**  
 1-16 hexadecimal digits. Valid digits are **0-9, a-f, A-F**.

**Default:** **none**

**:dlmb=** (optional)

Delimiter B. This parameter specifies the second delimiter that is used to format the outgoing TCAP dialed number.

**Range:** 1-16 digits, **none**  
 1-16 hexadecimal digits. Valid digits are **0-9, a-f, A-F**.

**:dlmc=** (optional)

Delimiter C. This parameter specifies the third delimiter that is used to format the outgoing TCAP DN.

**Range:** 1-16 digits, **none**  
 1-16 hexadecimal digits. Valid digits are **0-9, a-f, A-F**.

**:drafrmt=** (optional)

DRA digit format. This parameter specifies the format of the DRA digits.

**Range:** **grn, grndn, dngrn, ccgrndn, grnccdn**  
**grn**— The format is GRN.  
**grndn**— The format is GRN+DN.  
**dngrn**— The format is DN+GRN.  
**ccgrndn**— The format is CC+GRN+DN.  
**grnccdn**— The format is GRN+CC+DN.

**Default:** No change to the current value

**System**

**Default:** **grn**

**:dranai=** (optional)

DRA nature of address indicator. This parameter specifies the DRA NAI that is used during number conditioning.

**Range:** **1-127**  
**Default:** No change to the current value  
**System**  
**Default:** **3 - NATL**

**:nptype=** (optional)

Entity type for CdPN RTDB lookup. This parameter specifies the entity type that is considered a success when used for RTDB lookup.

**Range:** **sp, rn, rnsp, anymatch, always, rnspdn**  
**sp**— Service provider  
**rn**— Routing number  
**rnsp**— **rn** or **sp**

**anymatch**— **rn**, **sp**, or no match with any entity

**always**— Lookup is always considered successful

**rnspsdn**— **rn**, **sp**, or **dn**

If the **nptype=anymatch** parameter is specified, then the value is also used as the RN for the outgoing CdPN.

**Default:** **rnsps** - Use RN or SP as entity type for RTDB lookup

**:rnspsfill=** (optional)

This parameter specifies whether the RN and SP entities are set to the value of the RN or SP digits from the RTDB when certain conditions are met.

**Range:** **off**, **on**

**off**— If the **nptype** parameter has a value of **rnsps**, **anymatch**, or **always**, and the **dfiltrn=none** parameter is specified, then the RN entity is NOT set to the value of the RN digits from the RTDB. If the **nptype** parameter has a value of **rnsps**, **anymatch**, or **always**, then the SP entity is NOT set to the value of the RN digits from the RTDB.

**on**— If the **nptype** parameter has a value of **rnsps**, **any**, or **all**, and the **dfiltrn** parameter has a value of **none**, then the RN entity is set to the value of the SP digits from the RTDB. If the **nptype** parameter has a value of **rnsps**, **anymatch**, or **always**, and the **spsfill=on** parameter is specified, then the SP entity is set to the value of the RN digits from the RTDB.

**Default:** No change to the current value

**System**

**Default:** **off**

**:snai=** (optional)

CdPN nature of address indicator. This parameter specifies the CdPN NAI that is used during number conditioning.

**Range:** **incoming**, **intl**, **natl**, **unkn**

**incoming**— The incoming CdPN NAI is used.

**intl**— A CdPN NAI of 'International' (4) is used.

**natl**— A CdPN NAI of 'National' (3) is used.

**unkn**— A CdPN NAI of 'Unknown' (0) is used.

A value of **incoming** must be specified before the **intl**, **natl**, **nai1**, **nai2**, **nai3**, and **unkn** parameters in the **chg-npp-serv** command can be changed to non-default values for the IDPRCDPN service.

**Default:** **incoming**

**:spsfill=** (optional)

This parameter specifies whether the SP entity type is populated if the value specified for the **dfiltrn** or **grn** parameter is used for NPP processing.

**Range:** **off**, **on**

**off**— do not populate the SP entity type

**on**— populate the SP entity type

**Default:** No change to the current value

**System**

**Default:** **off**

**:sporttype=** (optional)

Service Portability type. This parameter specifies whether Service Portability is performed for the associated feature.

**Range:** **gsm**, **is41**, **all**, **none**

**gsm**— Apply Service Portability prefix (RTDB 'GRN' entity id ) for own-network GSM subscribers

**is41**— Apply Service Portability prefix (RTDB ‘GRN’ entity id) for own-network IS41 subscribers

**all**— Apply Service Portability prefix (‘GRN’ from RTDB entity) for all own-network (IS41 and GSM) subscribers

**none**— Service Portability is not performed for the feature.

**Default:** No change to the current value

**System**

**Default:** none

### Example

```
chg-ttropts:nptype=always
chg-ttropts:snai=intl
chg-ttropts:cgnptype=sp
chg-ttropts:cgsnai=natl
chg-ttropts:dlma=1234567890
chg-ttropts:dlmb=1234567890123456
chg-ttropts:dlmc=1234567890abcdef
chg-ttropts:cgpaccck=always
chg-ttropts:df1trn=123456789012345
```

### Dependencies

At least one optional parameter must be specified.

The Prepaid IDP Query Relay feature must be enabled before this command can be entered.

The IDP A-Party Routing feature and the IDP SK Routing feature must be enabled before the **cgpnskrtg** parameter can be specified.

If the new or existing value specified for the **drafrmt** parameter contains a country code (e.g., **ccgrndn**), then only a value of **4** can be specified for the **dranai** parameter. If the **dranai** parameter has a new or existing value that is not equal to **4**, then the value that is specified for the **drafrmt** parameter cannot contain a country code.

The S-Port feature must be enabled before the **sporttype** parameter can be specified.

### Output

```
chg-ttropts:nptype=sp
tekelecstp 08-05-05 13:34:22 EST EAGLE 39.0.0
CHG-TTROPTS: MASP A - COMPLTD
;
```

## chg-uaps

## Change UA Parameter Set

Use this command to change the UA parameter set.

**Keyword:** chg-uaps

**Related Commands:** rtrv-uaps

**Command Class:** Database Administration

### Parameters

**:set=** (mandatory)

This parameter specifies the UA parameter set to be changed.

**Range:** 1-9

**Default:** Current value

**:parm=** (optional)

Parameter number.

- Range:**     **1-10**  
           **1**—ASP SNM Options  
           **2**—ASP/AS Notification Options  
           **3**—UA Serviceability Options  
           **4-10**—Unused

**Default:**    Current value

**:pvalue=** (optional)

If the **parm** parameter is specified, the **pvalue** parameter specifies the numerical value that the **parm** parameter will be set to. Each parameter value is 32 bits (decimal 4294967295); not all 32 bits are used for each parameter. Only the values of the used bits are evaluated to determine the parameter value.

If the default setting for one bit is ON and you want to turn ON another bit in addition, specify the value that turns both bits ON. To turn OFF a bit that is ON and leave other bits ON, specify the value that turns ON just the bits that you want to be on. See the Notes section for this command for an explanation of the meanings of the bit settings.

**Range:**     **0-4294967295**  
 Enter a valid decimal or hexadecimal value shown in Table 5-35 for the **pvalue** parameter to be used for the specified **parm** parameter.

**Table 5-35.** Valid and Default UAPS Parameter Values

Parameter (parm)	To Turn On Only Bit(s)	Decimal pvalue	Hexadecimal pvalue	System Default
<b>1. ASP SNM Options</b> <b>Bit 0</b> = Broadcast <b>Bit 1</b> = Response Method <b>Bit 6</b> = Broadcast Congestion Status Change <b>Bits 2-5 and 7-31</b> = Unused	0	1	h'1	
	1	2	h'2	
	6	64	h'40	Off
	0, 1	3	h'3	On
	0, 6	65	h'41	
	1, 6	66	h'42	
	0, 1, 6	67	h'43	
<b>2. ASP/AS Notification Options</b> <b>Bit 0</b> = ASP ACTIVE Notifications <b>Bit 1</b> = ASP INACTIVE Notifications <b>Bit 2</b> = ASP AS State Query	0	1	h'1	
	1	2	h'2	
	2	4	h'4	
	0, 1	3	h'3	
	0, 2	5	h'5	

Table 5-35. Valid and Default UAPS Parameter Values

Parameter (parm)	To Turn On Only Bit(s)	Decimal pvalue	Hexadecimal pvalue	System Default
<b>Bits 3-31 = Unused</b>	1, 2	6	h'6	
	0, 1, 2	7	h'7	Off
<b>3. UA Serviceability Options</b>	0	1	h'1	Off
<b>Bit 0 = UA Heartbeats</b>	1	2	h'2	Off
<b>Bit 1 = UA Graceful Shutdown</b>	0,1	3	h'3	Off
<b>Bits 2-31 = Unused</b>				

**Default:** Current value

**:srcset=** (optional)

When specified, this source UAPS will be copied into the specified UAPS (**set**).

**Range:** 1-10

**Default:** Empty

**:timer=** (optional)

The Timer number within the UA parameter set.

**Range:** 1-10

- 1—Unused
- 2—False IP Connection Congestion Timer
- 3—UA Heartbeat Period Timer
- 4—UA Heartbeat Received Timer
- 5-10—Unused

**Default:** Current value

**:tvalue=** (optional)

This parameter specifies the value given to a timer. Each timer value is 32 bits (decimal 4294967295).

**Range:** 0-60000

Timer 2—0-30000 milliseconds

Timer 3—100-60000 milliseconds

Timer 4—100-10000 milliseconds

If the value specified is greater than the maximum range of the timer, then the maximum value of the timer is used.

**Default:** Current value

**System**

**Default:** Timer 2 - 3000 milliseconds  
 Timer 3 - 10000 milliseconds  
 Timer 4 - 5000 milliseconds

**Example**

The following example copies UA parameter set 1 into UA parameter set 2.

**chg-uaps: set=2: srcset=1**

The following example sets the Timer 2 value to 30 milliseconds.

```
chg-uaps:set=1:timer=2:tvalue=30
```

The following example sets the UA parameter set 2 value to hexadecimal 7, which turns on bits 0, 1, and 2.

```
chg-uaps:set=1:parm=2:pvalue=h'7
```

The following example sets the Timer 2 value to 30 milliseconds, and sets the value for UA parameter set 1 to decimal 64, which turns OFF bits 0 and 1 and turns ON only bit 6.

```
chg-uaps:set=2:timer=2:tvalue=30:parm=1:pvalue=64
```

## Dependencies

The **srcset** and **set** parameter values cannot be the same.

At least one of the **timer**, **parm**, and **srcset** optional parameters must be entered.

If the **srcset** parameter is specified, no other optional parameters can be entered in the command.

If the **parm** parameter is specified, the **pvalue** parameter must be specified.

If the **timer** parameter is specified, the **tvalue** parameter must be specified.

## Notes

There are 10 UA parameter sets. Each UA parameter set has 10 timers and 10 optional bit-mapped parameters. The bit-mapped parameter values control SNM and extended UA notification message behavior.

**Timer 2** is the False IP Connection Congestion Timer, which controls the maximum amount of time (in milliseconds) that an association is allowed to remain congested before failing due to false connection congestion. This timer value is limited to 0-30,000 milliseconds by the IPGWx application. The default value is 3000 milliseconds. This timer is not supported on the IPSG application.

**Timer 3** is the UA Heartbeat Period Timer, which controls the time (in milliseconds) between sending of BEAT messages by the NE. This timer value is limited to 100-60,000 milliseconds by the IPSG and IPGWx applications. The default value is 10,000 milliseconds.

**Timer 4** is the UA Heartbeat Received Timer, which controls the timeout period for response BEAT ACK messages by the NE. This timer value is limited to 100-10,000 milliseconds by the IPSG and IPGWx applications. The default value is 5000 milliseconds.

The bit-mapped parameters contain the following flags, which are set by using the **pvalue** parameter to turn the bits on or off in each bit map:

**Broadcast**—Controls broadcast phase SNM TFPs, TFRs and TFAs sent when a destination's status changes. If this flag is on (set to 1), SNM TFPs, TFRs, and TFAs will be broadcast to all associations and sockets assigned to routing keys associated with the destination's network and group code. The default is to enable all broadcast phase messages.

**Response Method**—Sending a SNM TFC/UPU as a reply to a message received on an association or a socket for an unavailable destination. If this bit is on (set to 1), the SNM response message is sent. The default is to allow the response to be sent.

**Broadcast Congestion Status Change**—Controls sending unsolicited congestion status changes. If this flag is on (set to 1) for an ASP, unsolicited congestion status messages are sent by the ASP when a destination's congestion status changes. This flag is applicable only if **ipgwabate** has been turned on with the **chg-sg-opts** command. The default is do not generate unsolicited congestion status changes.

**ASP ACTIVE Notifications**—Controls sending ASP-Active notifications. If this flag is on (set to 1), the Secure Gateway will, when an ASP transitions to Active, send a Notify message to all inactive and active ASPs in the AS of status type "Other" and a newly defined status ID of "ASP Activation". The ASP Activation notification message will include the ASP ID of the ASP that activated, and is transmitted only if the ASP ID is present. This notification is an extension to RFC3332 and not implemented for M3UA Version 8 adapters. The default is do not send ASP Active Notifications.

**ASP INACTIVE Notifications**—Controls sending ASP-Inactive notifications. If this flag is on (set to 1), the Secure Gateway will, when an ASP transitions to Inactive, send a Notify message to all inactive and active ASPs in the AS of status type "Other" and a newly defined status ID of "ASP Inactivation". The ASP Inactivation notification message will include the ASP ID of the ASP that inactivated and is transmitted only if the ASP ID is present. This notification is an extension to RFC3332 and not implemented for M3UA Version 8 adapters. The default is do not send ASP Inactive Notifications.

**ASP AS State Query**—Controls sending ASP/AS State Notifications on request by ASP. If this flag is on (set to 1), the Secure Gateway will respond with ASP and AS state notifications if 1) the remote ASP sends ASP-UP or ASP-INACTIVE while the local ASP is in the ASP-INACTIVE state, or 2) the remote ASP sends ASP-ACTIVE while the local ASP is in the ASP-ACTIVE state. The default is do not send state notifications.

**UA Heartbeats**—Controls sending UA Heartbeats on request by a connection. If this flag is on (set to 1), Heartbeat messages are transmitted in the ASP-DOWN, ASP-ACTIVE and ASP-INACTIVE States on connections from the Secure Gateway to the far end.

**Output**

```
chg-uaps:set=2:srcset=1
  rlgncxa03w 02-03-07 11:11:28 EST EAGLE 30.0.0
  CHG-UAPS: MASP A - COMPLTD
;
```

**chg-user**

**Change User**

Use this command to change user access to commands, change user ID's, and change passwords.

**NOTE: As of Release 40.1, the lnpbas parameter is obsolete.**

**Keyword:** chg-user

**Related Commands:** act-user, chg-pid, dact-user, dlt-user, ent-user, login, logout, rept-stat-user, rtrv-secu-user, rtrv-user

**Command Class:** Security Administration

**Parameters**

**:uid=** (mandatory)

User ID

**Range:** azzzzzzzzzzzzzzzz

1 alphabetic character followed by up to 15 alphanumeric characters

**:all=** (optional)

Specifies whether or not the user ID is assigned all non-configurable command classes (LINK, SA, SYS, PU, DB, DBG, LNP).

**Range:** yes, no

**Default:** Current value

**:cc1=** (optional)

Configurable command class name (*ayy*), and an indicator (**-yes** or **-no**) to specify whether the User ID can enter commands assigned to the specified command class.

**Range:** *ayy*

Specify the parameter value in the format *ayy -no* or *ayy -yes*.

*ayy*—Configurable command class name of 1 alphabetic character followed by 2 alphanumeric characters

**-no**—Indicates that the command class is not allowed.

**-yes**—Indicates that the command class is allowed.

**:cc2=** (optional)

Configurable command class name (*ayy*), and an indicator (**-yes** or **-no**) to specify whether the User ID can enter commands assigned to the specified command class.

**Range:** *ayy*

Specify the parameter value in the format *ayy -no* or *ayy -yes*.

*ayy*—Configurable command class name of 1 alphabetic character followed by 2 alphanumeric characters

**-no**—Indicates that the command class is not allowed.

**-yes**—Indicates that the command class is allowed.

**:cc3=** (optional)

Configurable command class name (*ayy*), and an indicator (**-yes** or **-no**) to specify whether the User ID can enter commands assigned to the specified command class.

**Range:** *ayy*

Specify the parameter value in the format *ayy -no* or *ayy -yes*.

*ayy*—Configurable command class name of 1 alphabetic character followed by 2 alphanumeric characters

**-no**—Indicates that the command class is not allowed.

**-yes**—Indicates that the command class is allowed.

**:cc4=** (optional)

Configurable command class name (*ayy*), and an indicator (**-yes** or **-no**) to specify whether the User ID can enter commands assigned to the specified command class.

**Range:** *ayy*

Specify the parameter value in the format *ayy -no* or *ayy -yes*.

*ayy*—Configurable command class name of 1 alphabetic character followed by 2 alphanumeric characters

**-no**—Indicates that the command class is not allowed.

**-yes**—Indicates that the command class is allowed.

**:cc5=** (optional)

Configurable command class name (*ayy*), and an indicator (**-yes** or **-no**) to specify whether the User ID can enter commands assigned to the specified command class.

**Range:** *ayy*

Specify the parameter value in the format *ayy -no* or *ayy -yes*.

*ayy*—Configurable command class name of 1 alphabetic character followed by 2 alphanumeric characters

**-no**—Indicates that the command class is not allowed.

**-yes**—Indicates that the command class is allowed.



**:cc6=** (optional)

Configurable command class name (*ayy*), and an indicator (**-yes** or **-no**) to specify whether the User ID can enter commands assigned to the specified command class.

**Range:** *ayy*

Specify the parameter value in the format *ayy -no* or *ayy -yes*.

*ayy*—Configurable command class name of 1 alphabetic character followed by 2 alphanumeric characters

**-no**—Indicates that the command class is not allowed.

**-yes**—Indicates that the command class is allowed.

**:cc7=** (optional)

Configurable command class name (*ayy*), and an indicator (**-yes** or **-no**) to specify whether the User ID can enter commands assigned to the specified command class.

**Range:** *ayy*

Specify the parameter value in the format *ayy -no* or *ayy -yes*.

*ayy*—Configurable command class name of 1 alphabetic character followed by 2 alphanumeric characters

**-no**—Indicates that the command class is not allowed.

**-yes**—Indicates that the command class is allowed.

**:cc8=** (optional)

Configurable command class name (*ayy*), and an indicator (**-yes** or **-no**) to specify whether the User ID can enter commands assigned to the specified command class.

**Range:** *ayy*

Specify the parameter value in the format *ayy -no* or *ayy -yes*.

*ayy*—Configurable command class name of 1 alphabetic character followed by 2 alphanumeric characters

**-no**—Indicates that the command class is not allowed.

**-yes**—Indicates that the command class is allowed.

**:db=** (optional)

Access to all commands in command class Database Administration.

**Range:** **yes, no**

**Default:** Current value

**:dbg=** (optional)

Access to all commands in command class Debug.

**Range:** **yes, no**

**Default:** Current value

**:link=** (optional)

Access to all commands in command class Link Maintenance.

**Range:** **yes, no**

**Default:** Current value

**:nuid=** (optional)

New user ID

**Range:** *azzzzzzzzzzzzzzzzz*

1 alphabetic character followed by up to 15 alphanumeric characters

**Default:** Current value

- :page=** (optional)  
 The maximum age of the password, in days. The STP automatically prompts the user for a new password at login if the user's password is older than the value specified for the **page** parameter.  
**Range:** 0-999  
**Default:** Current value
- :pid=** (optional)  
 Password ID. Required only if changing the password of a user.  
**Range:** yes, no  
**Default:** Current value
- :pu=** (optional)  
 Access to all commands in command class Program Update.  
**Range:** yes, no  
**Default:** Current value
- :revoke=** (optional)  
 Revoke the user ID. The system rejects login attempts for a revoked user ID.  
**Range:** yes, no  
**Default:** Current value
- :rstlsl=** (optional)  
 Reset the user ID. Use this command to reset the last successful login date, for this user ID, to the current date. If the user ID has been prevented login for non-use, use the **rstlsl=yes** parameter to allow the user ID access again.  
**Range:** yes, no  
**Default:** Current value
- :sa=** (optional)  
 Access to all commands in command class Security Administration.  
**Range:** yes, no  
**Default:** Current value
- :sys=** (optional)  
 Access to all commands in command class System Maintenance.  
**Range:** yes, no  
**Default:** Current value
- :uout=** (optional)  
 User ID aging interval. The number of successive days a user ID can go unused (that is, no successful login) before the system denies login of that user ID.  
**Range:** 0-999  
**Default:** The value specified for the **uout** parameter on the **chg-secu-dflt** command
- :lnpbas=** (obsolete)  
 Access to all commands in the command class LNP Basic  
**Range:** yes, no  
**Default:** Current value

### Example

```
chg-user:uid=john:nuid=johnmayer
chg-user:uid=john:nuid=john*mayer
chg-user:uid=john:db=yes
chg-user:uid=user123:cc1=dab-no:cc2=krb=yes
```

## Dependencies

Passwords cannot be created or modified from a telnet terminal (terminal IDs 17-40) unless the OA&M IP Security Enhancements feature is turned on.

Changes to a user ID cannot be made while that user is logged on the system.

The **revoke=yes** parameter cannot be specified for a user ID with system administration authorization.

The LNP feature must be turned on (see the **enable-ctrl-feat** command) before the **lnpbas** parameter can be specified.

If the **all=yes** parameter is specified, and the LNP feature has not been turned on, then the **lnpbas** parameter value defaults to **no**.

The Command Class Management feature must be enabled before a configurable command class name can be specified in the **cc1 - cc8** parameters.

The values specified in the **cc1 - cc8** parameters must be valid default (**u01-U32**) or provisioned configurable command class names.

## Notes

When the **pid=yes** parameter is specified, the system issues a separate prompt for this password and disables character echo at the terminal so that the entered password is not displayed on the screen. After the password has been entered, the system issues a second prompt, and the password must be entered again. This feature ensures that no typing mistakes were made on the first entry. The password must adhere to all password provisioning rules as established by the **chg-secu-dflt** command. These rules are displayed on the screen when the password prompt is presented.

The current password is not required when assigning a new password.

Use the following rules for changing passwords:

- A new password cannot contain more than 12 characters.
- A new password must contain at least the number of characters that is specified in the **minlen** parameter of the **chg-secu-dflt** command.
- A new password must contain at least the number of alphabetic (**alpha** parameter), numeric (**num** parameter), and punctuation (**punc** parameter) characters that is specified in the **chg-secu-dflt** command.

A new password cannot contain the associated user ID.

As a default, the command class Basic is assigned to all users. If no other command class is assigned, the user still has access to commands in the Basic class.

Up to 8 configurable command class name parameters can be specified in one command. Additional commands can be entered to assign user access for more than 8 names. To assign user access for all 32 available configurable command class names, you could enter four commands with 8 names specified in each command.

## Output

```
chg-user:uid=john:nuid=johnmayer
  rlgncxa03w 04-01-07 11:11:28 EST EAGLE 31.3.0
  CHG-USER: MASP A - COMPLTD
;
```

**chg-vflx-cd****Change V-Flex Call Decision Entry**

Use this command to revise the call decision criteria. This command updates the Call Decision table.

**NOTE: The V-Flex feature must be enabled before this command can be entered.**

**Keyword:** **chg-vflx-cd**

**Related Commands:** **dlt-vflx-cd, ent-vflx-cd, rtrv-vflx-cd**

**Command Class:** Database Administration

**Parameters**

**:cdn=** (mandatory)

Call decision name. This parameter specifies the name of an entry in the Call Decision table.

**Range:** *ayyy*

1 alphabetic character followed by 3 alphanumeric characters.

**:ncdn=** (optional)

New call decision name. This parameter specifies a new name for an entry in the Call Decision table.

**Range:** *ayyy*

1 alphabetic character followed by 3 alphanumeric characters

**Default:** No change to the current value.

**:nrndix=** (optional)

New routing number index. This parameter specifies a new routing number index that is associated with a call decision entry.

**Range:** **0-9**

**Default:** No change to the current value.

**:nvmdig=** (optional)

New voice mail number or voice mail prefix digits. This parameter specifies a new voice mail number or voice mail digits that is associated with a call decision entry.

**Range:** 1-15 digits

Valid digits **0-9, A-F, a-f**

**Default:** No change to the current value.

**Example**

The following command specifies a new routing number index.

**chg-vflx-cd:cdn=cdn1:nrndix=7**

The following command specifies a new call decision entry name and new routing number index.

**chg-vflx-cd:cdn=cdn1:ncdn=cdn3:nrndix=3**

The following command specifies a new call decision entry name.

**chg-vflx-cd:cdn=cdn3:ncdn=cdn5**

The following command specifies a new voice mail number or voice mail prefix digits.

**chg-vflx-cd:cdn=cdn1:nvmdig=123456**

**Dependencies**

The value specified for the **cdn** parameter cannot be a reserved word, such as **none**.

At least one parameter value must be different from the values provisioned for the table entry.

The value specified for the **cdn** parameter must already exist in the Call Decision table.

The **ncdn, nrndix, or nvmdig** parameter must be specified.

The V-Flex feature must be enabled before this command can be entered.

The value specified for the **ncdn** parameter cannot already exist in the Call Decision table.

The value specified for the **nvmdig** parameter cannot already exist in the Call Decision table with the same **dnstat**, **rdi**, and **bcap** values.

The value specified for the **nvmdig** parameter cannot differ from a value that already exists in the Call Decision table by only the value of the **dnstat** parameter. The values specified for **rdi** and **bcap** parameters must differ as well.

## Output

```
chg-vflx-cd:cdn=cdn1:ncdn=cdn3:nrnidx=3
rlghncxa03w 08-05-07 11:11:28 EST EAGLE 39.0.0
CHG-VFLX-CD: MASP A - COMPLTD
;
```

## chg-vflx-opts

## Change V-Flex Options

Use this command to provision the data that is used to condition the DN in an incoming MSU. This command updates the VFLXOPTS table.

**NOTE: The V-Flex feature must be enabled before this command can be entered.**

**Keyword:** chg-vflx-opts

**Related Commands:** rtrv-vflx-opts

**Command Class:** Database Administration

## Parameters

**:dra=** (optional)

Destination routing address. This parameter specifies the destination routing address in the "CONNECT" response.

**Range:** **rn**, **rndn**, **ccrndn**

**rn**— The destination routing address contains the routing number.

**rndn**— The destination routing address contains the routing number + directory number

**ccrndn**— The destination routing address contains the country code + routing address + directory number

**Default:** No change to current value.

**System**

**Default:** **rn**

**:dranai=** (optional)

Nature of address indicator. This parameter specifies the nature of address indicator for the destination routing address.

The nature of address indicator parameters (**dranaiv** or **dranai**) can be specified with either a mnemonic or an explicit value. The mnemonic and the explicit value cannot be specified together for the same parameter. Either the **dranaiv** or **dranai** parameter can be specified. Table 5-36 shows the mapping between the **dranaiv** and the **dranai** parameters.

**Range:** **sub**, **unknown**, **natl**, **intl**, **ntwk**

**Default:** Current value

**:dranaiv=** (optional)

This parameter specifies the nature of address indicator value for the destination routing address.

**Range:** **0-127**

**NOTE: The nature of address indicator parameters (dranaiv or dranai) can be specified by supplying either a mnemonic or an explicit value. At any time both**

the mnemonic and the explicit value must not be specified together for the same parameter. Either the `dranaiv` or `dranai` parameter can be specified. Table 5-36 shows the mapping between the `dranaiv` and the `dranai` parameters.

Table 5-36. DRANAIV/DRANAI Mapping

dranaiv	dranai	Description
1	sub	Subscriber Number
2	unknown	Unknown
3	natl	National significant number
4	intl	International number
5	ntwk	Network Specific
This mnemonic list is different from the list used by the Service Selector commands because the INAP destination routing address uses ISUP values instead of SCCP values.		

**:dranp=** (optional)

This parameter specifies the numbering plan for the destination routing address.

**NOTE: The numbering plan parameters (`dranpv` or `dranp`) can be specified by supplying either a mnemonic or an explicit value. At any time both the mnemonic and the explicit value must not be specified together for the same parameter. Either the `dranpv` or `dranp` parameter can be specified. Table 5-37 shows the mapping between the `dranpv` and the `dranp` parameters.**

**Range:** e164, x121, f69

**Default:** No change to the current value

**:dranpv=** (optional)

This parameter specifies the numbering plan value for the destination routing address. See Table 5-37.

**Range:** 0-7

**NOTE: The numbering plan parameters (`dranpv` or `dranp`) can be specified by supplying either a mnemonic or an explicit value. At any time both the mnemonic and the explicit value must not be specified together for the same parameter. Either the `dranpv` or `dranp` parameter can be specified. Table 5-37 shows the mapping between the `dranpv` and the `dranp` parameters**

Table 5-37. DRANPV/DRANP Mapping

dranpv	dranp	Description
1	E164	ISDN/telephony numbering plan
3	X121	Data numbering plan

Table 5-37. DRANPV/DRANP Mapping

dranpv	dranp	Description
4	F69	Telex numbering plan
Several of the numbering plan mnemonics that are used by the Service Selector commands are not in this list because they do not apply to INAP destination routing addresses.		

**Default:** No change to the current value

**:nequeryonly=** (optional)

This parameter specifies whether the Call Decision table is searched after RTDB lookup.

**Range:** **off, on**  
**off** — The table is not searched.  
**on** — The table is searched.

**Default:** No change to the current value.

**:netype=** (optional)

This parameter specifies the network entity type that is used for RTDB lookup.

The **nequeryonly=on** parameter must be specified before this parameter can be specified.

**Range:** **vmsid, sprn, grn**  
**vmsid** — voice mail server ID  
**sprn** — signaling point routing number  
**grn** — generic routing number

**Default:** No change to the current value.

**System**

**Default:** **vmsid**

**Example**

The following command specifies a new numbering plan and nature of address indicator.

**chg-vflx-opts:dranai=sub:dranp=e164**

The following command searches the Call Decision and VMSID tables and uses the vmsid network entity before RTDB lookup.

**chg-vflx-opts:nequeryonly=on:netype=vmsid**

The following command specifies a new destination routing address.

**chg-vflx-opts:dra=rn**

**Dependencies**

At least one optional parameter must be specified.

The **dranp** and **dranpv** parameters cannot be specified together in the command.

The **dranai** and **dranaiv** parameters cannot be specified together in the command.

The V-Flex feature must be enabled before this command can be entered.

The **nequeryonly=on** parameter must be specified before the **netype** parameter can be specified.

**Output**

```
chg-vflx-opts:dra=rn:dranp=e164:dranai=int1
tekelecstp 08-05-11 11:34:04 EST EAGLE 39.0.0
CHG-VFLX-OPTS: MASP A - COMPLTD
;
```

**chg-vflx-rn****Change Voice Mail Routing number**

Use this command to revise the voice mail routing numbers. This command updates the Routing Number table.

**NOTE: The V-Flex feature must be enabled before this command can be entered.**

**Keyword:** **chg-vflx-rn**

**Related Commands:** **dlt-vflx-rn, ent-vflx-rn, rtrv-vflx-rn**

**Command Class:** Database Administration

**Parameters**

**:rnname=** (mandatory)

Routing number name. This parameter specifies the name associated with a voice mail routing number.

**Range:** *ayyyyyyy*

1 alphabetic character followed by 7 alphanumeric characters.

**:nrn=** (optional)

New routing number. This parameter specifies a new voice mail routing number.

**Range:** 1-15 digits

Valid digits **0-9, A-F, a-f**

**Default:** No change to the current value.

**:nrnname=** (optional)

New routing number name. This parameter specifies the new name associated with a voice mail routing number.

**Range:** *ayyyyyyy*

1 alphabetic character followed by 7 alphanumeric characters.

**Default:** No change to the current value.

**Example**

The following command changes the name of the routing number.

```
chg-vflx-rn:rnname=rn01:nrnname=rn04
```

The following command changes the routing number digits for a specified routing number name.

```
chg-vflx-rn:rnname=rn01:nrn=122345BC8
```

The following command changes the routing number digits and the routing number name.

```
chg-vflx-rn:rnname=rn01:nrn=1223EAB68:nrnname=rn03
```

**Dependencies**

The value specified for the **rnname** parameter must already exist in the Routing Number table.

The value specified for the **nrn** parameter cannot already exist in the Routing Number table.

The V-Flex feature must be enabled before this command can be entered.

The value specified for the **nrnname** parameter cannot already exist in the Routing Number table.

The **nrn** or **nrnname** parameter must be specified in the command.

The value specified for the **nrnname** parameter cannot be a reserved word, such as **none**.

At least one parameter value must be different from the values provisioned for the table entry.



## Output

```
chg-vflx-rn:rnname=rn01:nrn=122345CE8:nrnname=rn02
rlghncxa03w 08-05-07 11:43:04 EST EAGLE 39.0.0
CHG-VFLX-RN: MASP A - COMPLTD
;
```

**chg-vflx-vmsid****Change Voice Mail Service ID Entry**

Use this command to revise the routing numbers that are associated with a VMS ID. This command updates the VMSID table.

**NOTE: The V-Flex feature must be enabled before this command can be entered.**

**Keyword:** **chg-vflx-vmsid**

**Related Commands:** **dlt-vflx-vmsid, ent-vflx-vmsid, rtrv-vflx-vmsid**

**Command Class:** Database Administration

**Parameters**

**:id=** (mandatory)

This parameter specifies the identification of the voice mail server.

**Range:** 1-15 digits, **dflt**

Valid digits are **0-9, A-F, a-f**.

**dflt**—default set of routing numbers that is used when a query is received with an invalid MSISDN or an MSISDN that is not found in the RTDB.

**:nidx0=** (optional)

This parameter specifies a new routing number name for VMRN index 0.

**Range:** *ayyyyyyy*, **none**

1 alphabetic character followed by up to 7 alphanumeric characters

**none**—deletes the routing number name associated with an index

**Default:** No change to the current value.

**:nidx1=** (optional)

This parameter specifies a new routing number name for VMRN index 1.

**Range:** *ayyyyyyy*, **none**

1 alphabetic character followed by up to 7 alphanumeric characters

**none**—deletes the routing number name associated with an index

**Default:** No change to the current value.

**:nidx2=** (optional)

This parameter specifies a new routing number name for VMRN index 2.

**Range:** *ayyyyyyy*, **none**

1 alphabetic character followed by up to 7 alphanumeric characters

**none**—deletes the routing number name associated with an index

**Default:** No change to the current value.

**:nidx3=** (optional)

This parameter specifies a new routing number name for VMRN index 3.

**Range:** *ayyyyyyy*, **none**

1 alphabetic character followed by up to 7 alphanumeric characters

**none**—deletes the routing number name associated with the index

**Default:** No change to the current value.

**:nidx4=** (optional)

This parameter specifies a new routing number name for VMRN index 4.

**Range:** *ayyyyyyy*, **none**  
 1 alphabetic character followed by up to 7 alphanumeric characters  
**none**—deletes the routing number name associated with the index

**Default:** No change to the current value.

**:nidx5=** (optional)

This parameter specifies a new routing number name for VMRN index 5.

**Range:** *ayyyyyyy*, **none**  
 1 alphabetic character followed by up to 7 alphanumeric characters  
**none**—deletes the routing number name associated with the index

**Default:** No change to the current value.

**:nidx6=** (optional)

This parameter specifies a new routing number name for VMRN index 6.

**Range:** *ayyyyyyy*, **none**  
 1 alphabetic character followed by up to 7 alphanumeric characters  
**none**—deletes the routing number name associated with the index

**Default:** No change to the current value.

**:nidx7=** (optional)

This parameter specifies a new routing number name for VMRN index 7.

**Range:** *ayyyyyyy*, **none**  
 1 alphabetic character followed by up to 7 alphanumeric characters  
**none**—deletes the routing number name associated with an index

**Default:** No change to the current value.

**:nidx8=** (optional)

This parameter specifies a new routing number name for VMRN index 8.

**Range:** *ayyyyyyy*, **none**  
 1 alphabetic character followed by up to 7 alphanumeric characters  
**none**—deletes the routing number name associated with an index

**Default:** No change to the current value.

**:nidx9=** (optional)

This parameter specifies a new routing number name for VMRN index 9.

**Range:** *ayyyyyyy*, **none**  
 1 alphabetic character followed by up to 7 alphanumeric characters  
**none**—deletes the routing number name associated with an index

**Default:** No change to the current value.

**Example**

The following example updates the specified VMS ID with a new routing number name for index 5. It also removes the routing number name associated with index 1.

```
chg-vflx-vmsid: id=1234ae5:nidx1=none:nidx5=rname1
```

**Dependencies**

The V-Flex feature must be enabled before this command can be entered.

The value specified for the **id** parameter must already exist in the VMSID table.

The routing number name of the entry specified by the **id** parameter must already exist in the Routing Number table.

At least one of the optional parameters must be specified.

At least one parameter value must be different from the values provisioned for the table entry.  
The value specified for the **rname** parameter must already exist in the Routing Number table.

### Output

```
chg-vflx-vmsid:id=1234ae5:nidx1=none:nidx5=rname1
rlghncxa03w 08-05-07 11:43:04 EST EAGLE 39.0.0
CHG-VFLX-VMSID: MASP A - COMPLTD
;
```

## chg-x25-dstn

### Change X.25 Destination

Use this command to change the association of an X.25 network address with either an SS7 point code, or a subsystem within that point code. If the node is actually in the X.25 domain, the X.25 address is a real network address and the point code is a dummy point code. If the node is in the SS7 domain, the point code is a real SS7 point code and the X.25 address is a dummy address.

**NOTE: This command is obsolete.**

**Keyword:** chg-x25-dstn

**Related Commands:** dlt-x25-dstn, ent-x25-dstn, rtrv-x25-dstn

**Command Class:** Database Administration

### Parameters

**NOTE: See "Point Code Formats and Conversion" for a detailed description of point code formats, rules for specification, and examples.**

**:xaddr=** (mandatory)

The X.25 network address of the X.25 destination entity or the SS7 node.

**Range:** 1-15 digits

**:dpc=** (optional)

The real SS7 point code assigned to a real SS7 node or the dummy point code for an X.25 destination entity, with subfields *network indicator-network cluster-network cluster member (ni-nc-ncm)*.

**Synonym:** dpca

**Range:** 000-255

Specify a valid value for each subfield of the point code, and separate the subfields with a dash (-).

When **chg-sid:pctype=ansi** is specified, *ni = 000* is not valid.

When **chg-sid:pctype=ansi** is specified, *nc = 000* is not valid if *ni = 001-005*.

When **chg-sid:pctype=ansi** is specified, *nc = 000* is valid if *ni = 006-255*.

The point code **000-000-000** is not a valid point code.

**Default:** Current value

**:ssn=** (optional)

The subsystem number of the destination that is assigned to the X.25 address or the SS7 address.

**Range:** 1-255

**Default:** Current value

### Example

```
chg-x25-dstn:xaddr=205255864567721:dpc=133-013-001:ssn=9
chg-x25-dstn:xaddr=205255864567721:dpc=133-013-013
chg-x25-dstn:xaddr=205255864567721:ssn=3
```

**Dependencies**

At least one optional parameter must be specified.

There must be at least four digits in the X.25 address.

The X.25 address must already exist as an X.25 destination.

The X.25 address must not be a part of an X.25 route.

The DPC must exist in the destination point code table.

The X.25 SS7 ANSI destination point code must be a full point code (*ni-nc-ncm*).

**Notes**

None

**Output**

```
chg-x25-dstn:xaddr=205255864567721:dpc=133-013-001:ssn=9
```

```
rlghncxa03w 04-01-10 11:43:04 EST EAGLE 31.3.0
X.25 DSTN TABLE 45 % FULL
CHG-X25-DSTN: MASP A - COMPLTD
```

```
;
```

**chg-x25-rte****Change X.25 Route**

Use this command to change the X.25 connection type of a given X.25 route. All LIMs with the **ss7gx25** GPL share this information. Even though these connections apply to only one card, they are used by all cards.

**NOTE: This command is obsolete.**

**Keyword:** **chg-x25-rte**

**Related Commands:** **dlt-x25-rte**, **ent-x25-rte**, **rtrv-x25-rte**

**Command Class:** Database Administration

**Parameters**

**:saddr=** (mandatory)

The alias X.25 address assigned to the SS7 destination entity on the SS7 side of the circuit.

**Range:** 1-15 digits

**:xaddr=** (mandatory)

The X.25 address assigned to the X.25 destination entity on the X.25 side of the circuit.

**Range:** 1-15 digits

**:lc2nm=** (optional)

Invokes SS7 MTP network management for failures and recoveries of logical channels.

**Range:** **yes**, **no**

**Default:** **no** if **rt=pc** is specified

**:loc=** (optional)

The card location containing the X.25 signaling link.

**Range:** **1101-1108**, **1111-1112**, **1201-1208**, **1211-1218**, **1301-1308**, **1311-1318**, **2101-2108**, **2111-2118**, **2201-2208**, **2211-2218**, **2301-2308**, **2311-2318**, **3101-3108**, **3111-3118**, **3201-3208**, **3211-3218**, **3301-3308**, **3311-3318**, **4101-4108**, **4111-4118**, **4201-4208**, **4211-4218**, **4301-4308**, **4311-4318**, **5101-5108**, **5111-5118**, **5201-5208**, **5211-5218**, **5301-5308**, **5311-5318**, **6101-6108**, **6111-6118**

**Default:** All card locations are displayed.

**:port=** (optional)

The port on the card containing the X.25 signaling link.

**Range:** a

**:rt=** (optional)

The type of routing to perform for messages originating in the SS7 domain and destined for the X.25 domain. Two types of routing are available: (1) route on X.25 destination point code (XPC), and (2) route using X.25 origination and destination point code combinations (PC).

**Range:** xpc, pc

**Default:** Current value

**:type=** (optional)

The type of X.25 connection that the link is expected to maintain.

**Range:** svca, svcr

svca—automatic virtual circuit

svcr—remote virtual circuit

### Example

```
chg-x25-rte:xaddr=225255:saddr=133131:type=svca:loc=1205:port=a
```

```
chg-x25-rte:xaddr=303545:saddr=234908:type=svcr
```

```
chg-x25-rte:xaddr=225255:saddr=133131:rt=xpc
```

### Dependencies

Each X.25 address must have at least four digits.

The combination of the two X.25 addresses must exist in the X.25 route table.

The number of SVCAs cannot exceed the maximum number of SVCs defined for the signaling link.

One of the following parameters must be specified: **type**, **rt**, or **lc2nm**.

If **lc2nm=yes** is specified, **rt=xpc** must be specified.

If the X.25 domain destination is an adjacent entity, **lc2nm=no** must be specified.

If **rt=xpc** is specified, the **xaddr** parameter's alias SS7 point code must be unique in the X.25 route table.

If the connection type is **svca** (**type=svca**), the **loc** parameter must be specified.

The new connection type (**type=svca** or **type=svcr**) must be different from the currently defined connection type. For example, if the current connection type is **svca** (**type=svca**), the new connection type must be **svcr** (**type=svcr**).

If the **port** parameter is specified, the **loc** parameter must be specified.

If the connection type of the X.25 route is **pvc** (shown in the TYPE field of the **rtrv-x25-rte** output), the X.25 route cannot be changed.

### Notes

The **lc2nm** parameter does not generate MTP level 3 network management messages to the network. Instead, it uses level 3 network management procedures internally to reroute traffic to an alternate route. If the **lc2nm** parameter is not specified, traffic is discarded when routed to a failed logical channel.

**Output**

```
chg-x25-rte:xaddr=225255:saddr=133131:type=svca:loc=1205:port=a
```

```
rlghncxa03w 04-01-10 11:43:04 EST EAGLE 31.3.0
CHG-X25-RTE: MASP A - X.25 Route table 45% full
CHG-X25-RTE: MASP A - COMPLTD
```

```
;
```

**chg-x25-slk****Change X.25 Signaling Link Parameters**

Use this command to change any X.25 signaling link parameter.

**NOTE: This command is obsolete.**

**Keyword:** chg-x25-slk

**Related Commands:** rtrv-x25-rte, rtrv-x25-slk

**Command Class:** Database Administration

**Parameters**

**:loc=** (mandatory)

The card location containing the X.25 signaling link.

**Range:** 1101-1108, 1111-1112, 1201-1208, 1211-1218, 1301-1308, 1311-1318, 2101-2108, 2111-2118, 2201-2208, 2211-2218, 2301-2308, 2311-2318, 3101-3108, 3111-3118, 3201-3208, 3211-3218, 3301-3308, 3311-3318, 4101-4108, 4111-4118, 4201-4208, 4211-4218, 4301-4308, 4311-4318, 5101-5108, 5111-5118, 5201-5208, 5211-5218, 5301-5308, 5311-5318, 6101-6108, 6111-6118

**Default:** All card locations are displayed.

**:port=** (mandatory)

The port on the card containing the X.25 signaling link.

**Range:** a

**Default:** Only one port per LIM is supported for X.25.

**:k=** (optional)

The maximum number of outstanding I frames.

**Range:** 1-7

**Default:** Current value

**System**

**Default:** 7

**:l3mode=** (optional)

The logical layer 3 address of the connection

**Range:** dte, dce

**Default:** dte

**:mps=** (optional)

The maximum packet size (in bytes) allowed on this X.25 signaling link.

**Range:** 128, 256

**Default:** 256

**:n1=** (optional)

The maximum number of bits in a frame.

**Range:** 1080, 2104

**Default:** Current value

**System**

**Default:** 2104

**:n2=** (optional)

The maximum number of retransmission attempts to complete a transmission.

**Range:** 3-15

**Default:** Current value

**System**

**Default:** 10

**:pvc=** (optional)

The total number of the permanent virtual circuits (PVCs) available on this X.25 signaling link.

**Range:** 0-255

**Default:** 0

**:svc=** (optional)

The total number of the switched virtual circuits (SVCs) available on this X.25 signaling link.

**Range:** 0-255

**Default:** 255 minus the value for the **pvc** parameter

**:t1=** (optional)

The amount of time to wait before retransmitting a frame.

**Range:** 3-10 seconds

**Default:** Current value

**System**

**Default:** 5

**:win=** (optional)

The number of packets allowed for a window on this X.25 signaling link.

**Range:** 1-7

**Default:** 3

**Example**

```
chg-x25-slk:loc=1201:port=a:t1=3:n1=1080:n2=3:k=7
```

```
chg-x25-slk:loc=1204:pvc=10:svc=10
```

**Dependencies**

The **limds0**, **limocu**, and **limv35** card types are the only valid card types for this command. These card types must be running the **ss7gx25** application.

The shelf and card must be equipped.

At least one of the optional parameters **t1**, **n1**, **n2**, **k**, **l3mode**, **pvc**, **svc**, **win**, or **mps** must be specified.

The sum of the values for the **pvc** and **svc** parameters must be greater than or equal to **1** and less than or equal to **255**.

If the **mps** parameter is equal to **128**, then the **n1** parameter must be equal to **1080**.

The specified card must be out-of-service maintenance-disabled (OOS-MT-DSBLD) before the X.25 signaling link parameters can be changed. Enter the **rept-stat-card** command with the card location containing the X.25 signaling link that you want to change, to verify the state of the card.

The new quantity of PVCs cannot be greater than the number of logical channels currently assigned to the X.25 signaling link. Enter the **rtrv-x25-rte** command with the card location and port (**loc** and **port**) of the X.25 signaling link to verify the number of logical channels assigned to the X.25 signaling link. This is shown in the *LC* field of the **rtrv-x25-rte** output.

**Notes**

To add, remove, or change an X.25 destination, linkset, signaling link, or route, follow the procedures in the "X.25 Gateway Configuration" chapter of the *Database Administration Manual - Features*.

**Output**

```

chg-x25-slk:loc=1201:port=a:t1=3:n1=1080:n2=3:k=7

rlghncxa03w 04-01-10 11:43:04 EST EAGLE 31.3.0
CHG-X25-SLK: MASP A - COMPLTD
;

```

**chk-unref-ent****Check Unreferenced Entities**

Use this command to check for unreferenced entities in the STP gateway screening entity sets. Unreferenced entities are those entities not referenced by another entity using the next screening function identifier and next screening reference combination, or using the linkset screening reference.

**Keyword:** **chk-unref-ent**

**Related Commands:** **aud-data, chg-scr-aftpc, chg-scr-blkdpc, chg-scr-blkopc, chg-scr-cdpa, chg-scr-cgpa, chg-scr-destfld, chg-scr-dpc, chg-scr-opc, chg-scr-sio, chg-scr-tt, chg-scrset, dlt-scr-aftpc, dlt-scr-blkdpc, dlt-scr-blkopc, dlt-scr-cdpa, dlt-scr-cgpa, dlt-scr-destfld, dlt-scr-dpc, dlt-scr-opc, dlt-scr-sio, dlt-scr-tt, dlt-scrset, ent-scr-aftpc, ent-scr-blkdpc, ent-scr-blkopc, ent-scr-cdpa, ent-scr-cgpa, ent-scr-destfld, ent-scr-dpc, ent-scr-opc, ent-scr-sio, ent-scr-tt, ent-scrset**

**Command Class:** Database Administration

**Parameters**

**:aftpc=** (optional)

Affected point code. Specifies whether you want to audit the affected PC/SSN entity set.

**Range:** **yes, no**

**Default:** **no**

**:all=** (optional)

All entity types. Specifies whether you want to audit all of the entity sets.

**Range:** **yes, no**

**Default:** **no**

**:blkdpc=** (optional)

Blocked destination point code. Specifies whether you want to audit the blocked DPC entity set.

**Range:** **yes, no**

**Default:** **no**

**:blkopc=** (optional)

Blocked originating point code. Specifies whether you want to audit the blocked OPC entity set.

**Range:** **yes, no**

**Default:** **no**

**:cdpa=** (optional)

Called party address. Specifies whether you want to audit the allowed CDPA entity set.

**Range:** **yes, no**

**Default:** **no**

**:cgpa=** (optional)

Calling party address. Specifies whether you want to audit the allowed CGPA entity set.

**Range:** **yes, no**

**Default:** **no**

**:destfld=** (optional)

Affected destination field. Specifies whether you want to audit the affected DESTFLD entity set.

**Range:** **yes, no**



**Default:** no

**:dpc=** (optional)

Destination point code. Specifies whether you want to audit the allowed DPC entity set.

**Range:** yes, no

**Default:** no

**:isup=** (optional)

ISUP message type. Specifies whether you want to audit the ISUP message type entity set.

**Range:** yes, no

**Default:** no

**:opc=** (optional)

Originating point code. Specifies whether you want to audit the allowed OPC entity set.

**Range:** yes, no

**Default:** no

**:sio=** (optional)

Service information octet. Specifies whether you want to audit the allowed SIO entity set.

**Range:** yes, no

**Default:** no

**:tt=** (optional)

Translation type. Specifies whether you want to audit the allowed TT entity set.

**Range:** yes, no

**Default:** no

### Example

```
chk-unref-ent:opc=yes:dpc=yes:sio=yes
```

```
chk-unref-ent:all=yes
```

```
chk-unref-ent:all=yes:blkopc=no:blkdpc=no
```

### Dependencies

At least one entity set name must be specified.

### Notes

None

**Output**

**chk-unref-ent:opc=yes:dpc=yes:sio=yes**

```

rlghncxa03w 04-01-18 08:29:15 EST EAGLE 31.3.0
ENTITY          UNREFERENCED
TYPE            ENTITIES
-----
OPC             <NONE>
DPC             DPC1
DPC             DPC2
SIO             <NONE>
;
    
```

**chk-unref-ent:all=yes**

```

rlghncxa03w 04-01-18 08:29:15 EST EAGLE 31.3.0
ENTITY          UNREFERENCED
TYPE            ENTITIES
-----
OPC             <NONE>
DPC             dpc1
                dpc2
BLKOPC          <NONE>
BLKDPC          <NONE>
SIO             <NONE>
CGPA            <NONE>
CDPA            <NONE>
TT              tt0-1
                tt-05
DESTFLD        <NONE>
AFTPC          <NONE>
ISUP            <NONE>
;
    
```

**chk-unref-ent:all=yes:blkopc=no:blkdpc=no**

```

rlghncxa03w 04-01-18 08:29:15 EST EAGLE 31.3.0
ENTITY          UNREFERENCED
TYPE            ENTITIES
-----
OPC             <NONE>
DPC             dpc1
                dpc2
SIO             <NONE>
CGPA            <NONE>
CDPA            <NONE>
TT              tt01
                tt05
AFTPC          <NONE>
;
    
```

**Legend**

**ENTITY TYPE**—This field displays which entity type is being checked.

**UNREFERENCED ENTITIES**—This field displays whether the entity type listed is referenced by another entity.

**clr-imt-stats**

**Clear IMT Statistics**

Every card in the system has both a card location identifier (stenciled on the shelf and provided in all output) and an IMT address. Use this command to clear the following statistics:

- The IMT level 1 and level 2 statistics for specified IMT addresses and the hourly time period statistics for IMT errors.
- The card error statistics for HMUX or HIPR cards and the hourly time period statistics for HMUX or HIPR cards.
- All IMT, HMUX, and HIPR error and hourly time period statistics. When the hourly time period statistics for IMT errors, HMUX errors, or HIPR errors are cleared, the current hourly time period number is reset to 0 (zero) on all cards.

**Keyword:** `clr-imt-stats`

**Related Commands:** `conn-imt`, `disc-imt`, `rept-imt-info`, `rept-imt-lvl1`, `rept-imt-lvl2`, `rmv-imt`, `rst-imt`, `tst-imt`

**Command Class:** System Maintenance

### Parameters

**:all=** (optional)

Clear all IMT, HMUX, and HIPR statistics.

**Range:** `yes`, `no`

**Default:** `no`

**:e=** (optional)

End address. This parameter specifies the IMT address of the last card in the range.

**Range:** `0-251`

(See the *Installation Manual - EAGLE 5 ISS* for an illustration with IMT addresses).

**:eloc=** (optional)

End location. Specifies the card location of the last card in the range.

**Range:** `1101-1113`, `1115`, `1201-1218`, `1301-1318`, `2101-2118`, `2201-2218`, `2301-2318`, `3101-3118`, `3201-3218`, `3301-3318`, `4101-4118`, `4201-4218`, `4301-4318`, `5101-5118`, `5201-5218`, `5301-5318`, `6101-6118`

**Default:** If `sloc` is specified—current `sloc` value

If `sloc` is not specified—`1115`, which corresponds to IMT address 251 (`e=251`).

**:eshelf=** (optional)

End shelf location for HMUX and HIPR statistics. This parameter specifies the shelf location of the last shelf in the range. (Both HMUX and HIPR statistics will be cleared if they exist in the range between and including the `sshelf` and `eshelf` locations).

**Range:** `1100`, `1200` -`6100`

**Default:** If `sshelf` is specified—current `sshelf` value.

If `sshelf` is not specified—`6100`.

**:s=** (optional)

Start address. This parameter specifies the IMT address of the first (or only) card in the range.

**Range:** `0-251`

(See the *Installation Manual* of your current documentation set for an illustration with IMT addresses).

**:sloc=** (optional)

Start location. Specifies the card location of the first card in the range.

**Range:** `1101-1113`, `1115`, `1201-1218`, `1301-1318`, `2101-2118`, `2201-2218`, `2301-2318`, `3101-3118`, `3201-3218`, `3301-3318`, `4101-4118`, `4201-4218`, `4301-4318`, `5101-5118`, `5201-5218`, `5301-5318`, `6101-6118`

**Default:** If `eloc` is specified—current `eloc` value

If `eloc` is not specified—`1201`, which corresponds to IMT address 0 (`s=0`).

**:sshelf=** (optional)

Start shelf location for HMUX and HIPR statistics. This parameter specifies the shelf location of the first shelf in the range. (Both HMUX and HIPR statistics will be cleared if they exist in the range between and including the **sshelf** and **eshelf** locations).

**Range:** 1100, 1200-6100

**Default:** If **eshelf** is specified—current **eshelf** value.  
If **eshelf** is not specified—**1100**.

### Example

```
clr-imt-stats:s=00
```

### Dependencies

The **clr-imt-stats** command cannot be entered if any of the following commands is running: **rept-imt-info**, **rept-imt-lvl1**, **rept-imt-lvl2**, **tst-imt**.

If the **s** and **e** parameters are specified, do not specify the **sloc** and **eloc** parameters; conversely, if the **sloc** and **eloc** parameters are specified, do not specify the **s** and **e** parameters.

This command cannot be entered during IMT statistics collection following an hourly boundary.

Either the start address (**s** parameter) or start location (**sloc** parameter) must be specified.

### Notes

The **sloc** and **eloc** parameters allow individual **HMUX and HIPR** cards to be cleared.

The **s** and **e** parameters will *not* clear **HMUX and HIPR** cards.

The **sshelf** and **eshelf** parameters clear both **HMUX and HIPR** cards on bus A and bus B.

### Output

```
clr-imt-stats:all=yes
rlghncxa03w 04-01-07 11:02:30 EST EAGLE 35.0.0
Clear IMT Statistics command(s) issued...
Command Completed.
;
```

## conn-imt

## Connect IMT

The interprocessor message transport bus (IMT bus) is the main communications artery between all subsystems in the system. Use this command to connect a manually disconnected card to the specified IMT bus. The card must have been manually disconnected from the bus previously by the **disc-imt** command. If the card was disconnected from the bus for other reasons, this command has no effect.

**Keyword:** conn-imt

**Related Commands:** **clr-imt-stats**, **disc-imt**, **rept-imt-lvl1**, **rept-imt-lvl2**, **rept-stat-imt**, **rmv-imt**, **rst-imt**

**Command Class:** System Maintenance

### Parameters

**:bus=** (mandatory)

IMT bus to which the specified card is to be connected.

**Range:** a, b

**:loc=** (mandatory)

The card location as stenciled on the shelf of the system.

**Range:** 1101-1108, 1111-1112, 1201-1208, 1211-1218, 1301-1308, 1311-1318, 2101-2108, 2111-2118, 2201-2208, 2211-2218, 2301-2308, 2311-2318, 3101-3108, 3111-3118, 3201-3208, 3211-3218, 3301-3308, 3311-3318, 4101-4108, 4111-4118, 4201-4208, 4211-4218, 4301-4308, 4311-4318, 5101-5108, 5111-5118, 5201-5208, 5211-5218, 5301-5308, 5311-5318, 6101-6108, 6111-6118

### Example

```
conn-imt:loc=1201:bus=a
```

### Dependencies

The card being reconnected must first be disconnected manually from the bus by using the **disc-imt** command.

This command cannot be entered during an IMT Fault Isolation Test.

The card location, frame, shelf, or slot must be within the allowed range.

### Notes

This command has no effect if the card was disconnected from the IMT bus in any way other than manually using the **disc-imt** command.

### Output

```
conn-imt:loc=1201:bus=a
rlghncxa03w 04-01-07 11:02:30 EST EAGLE 31.3.0
Connect IMT Bus A command issued to card 1201

rlghncxa03w 04-01-07 11:02:30 EST EAGLE 31.3.0
0100.0006 IMT Bus A Card connected to IMT

rlghncxa03w 04-01-07 11:02:30 EST EAGLE 31.3.0
3112.0006 CARD 1201 CCS7ITU Card connected to IMT
;
```

## copy-disk

## Copy Disk

Use this command to copy a mirror image of the active fixed disk to the standby fixed disk. When the fixed disk requires replacement, or needs to be repaired or updated, this command formats the standby fixed disk and copies the contents of the active fixed disk to the standby fixed disk.



**CAUTION:** Before entering the **copy-disk** command, contact Tekelec Technical Services at (888) FOR-TKLC. The Technical Services engineer may be able to propose a less intrusive method for copying to a fixed disk.



**CAUTION:** If the **copy-disk** command fails and the standby TDM boots continuously, insert a removable disk with the same release as the fixed disks in the MDAL. The standby MASP should successfully boot off the removable disk. After the MASP has booted completely, re-enter the **copy-disk** command.

**Keyword:** **copy-disk**

**Related Commands:** **chg-db**, **copy-gpl**, **copy-meas**, **disp-disk-dir**, **format-disk**, **rept-stat-db**

**Command Class:** System Maintenance

### Parameters

**:dloc=** (mandatory)

This parameter must specify the location of the standby fixed disk. This is the destination drive for this function.

**Range:** 1114, 1116  
(TDM)

**:force=** (optional)

This parameter provides some protection against data loss from copying over a fixed disk. If the target medium is recognized as a valid system medium, the **force=yes** parameter must be specified.

**Range:** yes, no

**Default:** no

**:format=** (optional)

This parameter provides the choice whether or not to format the standby fixed disk before executing the copy. If a format is not necessary, specifying **no** can save a significant amount of time.

**Range:** yes, no

**Default:** yes

**:sloc=** (optional)

This parameter must specify the location of the active fixed disk. This will be the source drive for this function.

**Range:** 1114, 1116  
(TDM)

**Default:** The location of the active fixed disk

### Example

```
copy-disk:sloc=1114:dloc=1116:force=yes
```

### Dependencies



**CAUTION: Do not turn off measurements at midnight because doing so can cause the loss of an entire day of measurements. Do not turn off measurements during the 30 minute measurements processing period, because this can result in the loss of the measurements for the 30 minute period being processed.**

Measurements collection must be turned off or the **copy-disk** command cannot be executed. Do not issue the **chg-meas** command while the **copy-disk** command is in progress. This results in read and write errors, because the standby fixed disk is not accessible and the active fixed disk only allows read-only access.

OAM Measurements collection cannot be in progress when this command is entered. Retry the command after a period of waiting for the measurements collection to complete.

The **copy-disk** command reserves both the active and standby disks, preventing database updates for the duration of the command. Access is allowed for read-only; writing to the disk is prohibited.

All commands that affect the database are not allowed for the duration of the command. Attempts to use such commands are rejected, and an error message is displayed indicating that the command has been rejected because the **copy-disk** command is in use.

The EOAM GPL version that is running in the active OAM card location must be the same GPL version that is running in the standby OAM card location.

The **sloc** and **dloc** fixed disks must be available and compatible.

The **sloc** fixed disk must be coherent.

The **dloc** parameter must specify the standby fixed disk.

The **sloc** parameter must specify the active fixed disk.

The standby fixed disk cannot be initialized while un-uploaded security log entries exist.

The **force=yes** parameter is required if the destination medium is recognized as a system medium. This parameter is optional if the destination medium is not a system medium. Only media that contain the **dms.cfg** file are recognized as system media.

If the **force=yes** parameter is specified, the disk should not require low-level formatting, and the **format=no** parameter should also be specified.

### Notes

The **format=no** parameter should be specified when upgrading a spare TDM. You should specify the **format=yes** parameter when there is a suspected hardware problem.

If the **copy-disk** command is initiated and the standby OAM initialization is not complete, command processing will be delayed. If standby initialization fails, the command proceeds to allow the standby TDM to recover from a previous **format-disk** or **copy-disk** failure. In such cases, the following messages appear:

```
Standby MASP has not finished initializing - please wait...
Standby MASP initialization timed out - continuing...
```

The **format=no** parameter should be specified when upgrading a spare TDM. the **format=yes** parameter should be specified when there is a suspected hardware problem.

If the **copy-disk** command is initiated and the standby OAM initialization is not complete, command processing will be delayed. If standby initialization fails, the command proceeds to allow the standby TDM to recover from a previous **format-disk** or **copy-disk** failure. In such cases, the following messages appear:

```
Standby MASP has not finished initializing - please wait...
Standby MASP initialization timed out - continuing...
```

When the **copy-disk** command is processing, the system cannot log other commands to the security log because the active fixed disk is set to read-only. During this time, commands that would alter the database fail when entered.

The performance time required to copy a fixed disk to another fixed disk varies depending on database size and system activity. This operation should typically take no longer than 2.5 hours. (If you are not performing the low-level format (**format=no**), the operation should take no longer than an hour.) If the **copy-disk** operation exceeds three hours, contact Tekelec Technical Services for assistance at (888) FOR-TKLC. If the **copy-disk** operation without the low-level format exceeds 1.5 hours, call Tekelec Technical Services.

### Output

```
copy-disk:sloc=1114:dloc=1116:force=yes
```

```
rlghncxa03w 04-01-07 11:02:30 EST EAGLE 31.3.0
copy-disk:sloc=1114:dloc=1116:force=yes
Command entered at terminal #3.
```

```
Copy-disk (fixed): from active (1114) to standby (1116) started.
Extended processing required, please wait.
```

```
Copy-disk (fixed): from active (1114) to standby (1116) completed.
Measurements collection may be turned on now if desired.
```

## copy-fts

### Copy to or from the File Transfer Area

This command copies tables into or from the file transfer area (FTA).

**Keyword:** copy-fts

**Related Commands:** act-file-trns, disp-fts-dir, dlt-fts

**Command Class:** System Maintenance





The **1117** location is used by MDAL cards. The **1113** and **1115** locations are used by E5-MCAP cards. The **1114** and **1116** locations are used by TDM or E5-TDM cards.

Legacy TDM, GPSM-II, and MDAL cards cannot be installed in the same system as E5-TDM, E5-MCAP, and E5-MDAL cards.

### Notes

This command is used to copy into the file transfer area or out of the file transfer area. The parameters **stbl**, **dfile**, **sfile**, and **dtbl** are used to describe the nature of the copy. A copy from a DMS table into the file transfer area would use the **stbl** (source table) and **dfile** (destination file) parameters. Thus, data would move from a table into a transfer area file. To copy from the file transfer area to a DMS table, use the **sfile** (source file) and **dtbl** (destination table) parameters. Any other combination of these 4 parameters is invalid.

### Output

```
copy-fta:stbl=1:dfile="2F1.OUT":sloc=1114:dloc=1114
```

```
rlghncxa03w 04-01-05 14:59:10 EST EAGLE 31.3.0
copy-fta:stbl=1:dfile="2F1.OUT":sloc=1114:dloc=1114
Command entered at terminal #1.
;
rlghncxa03w 04-01-05 14:59:26 EST EAGLE 31.3.0
Copied Table 1 successfully from FIXED to F1.OUT in FTA.
;
rlghncxa03w 04-01-05 15:00:49 EST EAGLE 31.3.0
copy-fta:sfile=dms.cfg:dtbl=0:sloc=1114:dloc=1117:drv=remove
Command entered at terminal #1.
;
rlghncxa03w 04-01-05 15:01:12 EST EAGLE 31.3.0
Copied DMS.CFG successfully from FTA to Table 0 on REMOVABLE.
;
```

## copy-gpl

### Copy Generic Program Load

Use this command to copy all approved GPLs from one drive to another. The GPLs can be copied only from the fixed disk on the active TDM to the removable cartridge or drive, or from the removable cartridge or drive to the fixed disk on the standby TDM.

**Keyword:** copy-gpl

**Related Commands:** act-gpl, alw-card, chg-gpl, init-card, init-sys, rept-stat-gpl, rtrv-gpl

**Command Class:** System Maintenance

### Parameters

**:ddrv=** (optional)

Destination drive. This parameter specifies the identification of the disk to which the GPL is copied.

**Range:** fixed, remove, usb

**fixed** — The fixed disk

**remove** — The removable cartridge or drive

**usb** — Argument to be used by Tekelec personnel only.

**:dloc=** (optional)

The destination location of the the GPLs to be copied.

**Range:** 1114, 1116, 1117, 1113, 1115

**1114** — The TDM

**1116** — The TDM

**1117** — The removable cartridge drive

**1113** — The latched USB port

**1115** — The latched USB port

- Default:** 1117
- :sdrv=** (optional)  
Source drive. This parameter specifies the identification of the disk from which the GPL is copied.
- Range:** **fixed, remove, usb**  
**fixed** — The fixed disk  
**remove** — The removable cartridge or drive  
**usb** — Argument to be used by Tekelec personnel only.
- :sloc=** (optional)  
The source location of the the GPLs to be copied.
- Range:** **1114, 1116, 1117, 1113, 1115**  
**1114** — The TDM  
**1116** — The TDM  
**1117** — The removable cartridge drive  
**1113** — The latched USB port  
**1115** — The latched USB port
- Default:** The location of the active TDM

### Example

```
copy-gpl
copy-gpl:sloc=1117:dloc=1116
copy-gpl:sloc=1116
```

### Dependencies

While this command is executing, the **chg-gpl** and **act-gpl** commands cannot be entered.

The destination disk needs to be formatted.

The GPLs can be copied only from the fixed disk on the active TDM (**sloc=1114** or **sloc=1116**) to the removable cartridge (**dloc=1117**), or from the removable cartridge (**sloc=1117**) to the fixed disk on the standby TDM (**dloc=1114** or **dloc=1116**).

The source drive must be coherent when the command is executed.

The **1117** location is used by MDAL cards. The **1113** and **1115** locations are used by E5-MCAP cards. The **1114** and **1116** locations can be used by TDM or E5-TDM cards.

The specified disk type does not match the specified location.

### Notes

This command has no effect on the GPLs stored on other cards (for example, SCCP).

**Output**

Copying the GPLs from the fixed disk on the active TDM (card location 1114) to the removable cartridge.

```
copy-gpl:sloc=1114:dloc=1117
rlghncxa03w 04-01-07 00:57:31 EST EAGLE 31.3.0
COPY GPL: MASP A - COPY STARTS ON ACTIVE MASP
COPY GPL: MASP A - COPY TO REMOVABLE CARTRIDGE COMPLETE
;
```

Copying the GPLs from the removable cartridge to the fixed disk on the standby TDM (card location 1116).

```
copy-gpl:sloc=1117:dloc=1116
rlghncxa03w 09-01-07 00:57:31 EST EAGLE 40.1.0
COPY GPL: MASP B - COPY STARTS ON REMOVABLE DRIVE
;

rlghncxa03w 09-01-07 01:01:27 EST EAGLE 40.1.0
COPY GPL: MASP B - COPY TO STANDBY MASP COMPLETE
;
```

Copying the GPLs from the fixed disk on the active USB drive.

```
copy-gpl:sloc=1114:ddrv=usb
e5oam 09-01-09 05:14:23 MST EAGLE 40.1.0
COPY GPL: MASP A - COPY STARTS ON ACTIVE MASP
;

e5oam 09-01-09 05:22:30 MST EAGLE 40.1.0
COPY GPL: MASP A - COPY TO USB DRIVE COMPLETE
```

**copy-meas****Copy Measurements**

Use this command to copy all measurements tables on the active fixed disk to a measurements removable cartridge. Do this when you need to perform off-line analysis of the raw measurements data.

**NOTE: This command is not supported on the Measurements Platform feature.**

**Keyword:** copy-meas

**Related Commands:** chg-meas, rept-meas, rtrv-meas-sched

**Command Class:** System Maintenance

**Parameters**

None

**Example**

```
copy-meas
```

**Dependencies**

The removable cartridge or removable drive:

- must be inserted
- must be initialized
- must be a MEAS disk
- cannot be a SYSTEM disk

**Notes**

To execute this command, measurement collection must be turned **off**. If measurement collection is on, enter the **chg-meas:collect=off** command to turn off measurement collection.

The *Maintenance Manual* provides a description of all measurement report parameters.

**Table 5-38.** Performance for the **copy-meas** command

Activity	Approximate Performance*
Copy the raw measurements data from the active fixed disk to the measurements removable cartridge.	2 minutes
* Minimum time and dependent on system activity.	

**Output**

**copy-meas**

```
COPY MEASUREMENTS: MASP A - COPY STARTS ON ACTIVE MASP
COPY MEASUREMENTS: MASP A - COPY TO REMOVABLE CARTRIDGE COMPLETE
;
```

**copy-seculog**

**Copy Security Log Contents to FTA Area**

Use this command to copy the contents of a security log to the file transfer area (FTA). If no parameters are specified, a file called **yymmdda.log** (see the description of the **dfile** parameter) is created in the FTA on the active fixed disk. The contents of the security log on the active fixed disk are copied into this file.

**Keyword:** copy-seculog

**Related Commands:** act-file-trns, copy-tbl, disp-fta-dir, dlt-fta

**Command Class:** Security Administration

**Parameters**

**:dfile=** (optional)

Target file name. This parameter specifies the name of the file that is to be created in the FTA and initialized with the security log contents.

**Range:** `xxxxxxxxxxxxxxxxxxxxxxxxxxxxxxxx`  
1–32 characters

**Default:** If not specified, the file is named `yymmddx.log`, where `yymmdd` is the current year, month, and day, and `x` is either `a` or `s`, depending on whether the log on the active or standby fixed disk was copied.

**:dloc=** (optional)

Destination FTA. This parameter specifies which FTA is to receive the copy of the log.

**Range:** **act, stb**  
**act**—Copies the log to the active fixed disk’s FTA  
**stb**—Copies the log to the standby fixed disk’s FTA

**Default:** **act**

**:slog=** (optional)

Source log indicator. This parameter specifies which log is to be copied to the FTA.

**Range:** **act, stb**  
**act**—Copies the log on the active fixed disk

**stb** —Copies the log on the standby fixed disk  
**Default:** **act**

### Example

```
copy-seculog
copy-seculog:dfile="somename.log"
copy-seculog:slog=stb
copy-seculog:slog=act
copy-seculog:slog=act:dloc=stb
```

### Dependencies

No other security log command can be in progress when this command is entered.

No **copy-fta** command can be in progress when this command is entered.

GPSSM-II and E5-MCAP cards cannot be provisioned in the system at the same time.

### Notes

For the **dfile** parameter, if the file name is not accepted by the system because it contains special characters such as blanks, colons, dashes, ampersands, or others; or because it does not start with an alphabetic character, enclose the file name in double quotes (Copies t) as in this example: Copies t.

Any scroll area failure message that can be produced by the **copy-fta** command can be produced also by the **copy-seculog** command.

### Output

The following example shows that the log on the active fixed disk is copied to the FTA on the active fixed disk and given the default name (note the **a** in the log name).

```
copy-seculog
rlghncxa03w 04-01-04 15:59:06 EST EAGLE 31.3.0
Security log on TDM 1114 copied to file 960104a.log on TDM 1114
```

The following example shows that the log on the active fixed disk is copied to the FTA on the active fixed disk and given a user-specified name.

```
copy-seculog:dfile="somename.log"
rlghncxa03w 04-01-04 15:59:06 EST EAGLE 31.3.0
Security log on TDM 1116 copied to file somename.log on TDM 1114
```

The following example shows that the log on the standby fixed disk is copied to the FTA on the active fixed disk and given the default name (note the **s** in the log name).

```
copy-seculog:slog=stb
rlghncxa03w 04-01-04 15:59:06 EST EAGLE 31.3.0
Security log on TDM 1114 copied to file 960104s.log on TDM 1116
```

The following example shows that the copy of the log fails because a file already exists in the FTA with the same name.

```
copy-seculog:slog=act
rlghncxa03w 04-01-04 15:59:06 EST EAGLE 31.3.0
Command Failed - Destination File already exists in the File Transfer Area
```

The following example shows that the copy fails because there is not enough room in the FTA to contain the copy.

```
copy-seculog:slog=act:dloc=stb
rlghncxa03w 04-01-04 15:59:06 EST EAGLE 31.3.0
Command Failed - Not enough room exists in the File Transfer Area
```

**dact-alm-trns****Deactivate Alarm Transfer**

Use this command to return all audible alarm indications to the local office.

**Keyword:** dact-alm-trns

**Related Commands:** act-alm-trns, rept-stat-clk, rept-stat-trbl, rls-alm, rtrv-obit, rtrv-trbl

**Command Class:** System Maintenance

**Parameters**

This command has no parameters.

**Example**

```
dact-alm-trns
```

**Dependencies**

None

**Notes**

After you enter **dact-alm-trns**, enter **rept-stat-alm** to verify the status of the alarms.

**Output**

```
dact-alm-trns
rlghncxa03w 04-01-07 11:11:28 EST EAGLE 31.3.0
Alarms returned to Local Maintenance Center
;
```

**dact-cdl****Deactivate Command Driven Loopback**

Use this command to deactivate a previously initiated command driven loopback for testing a signaling link, if the test is active. If it is not active, the command will attempt to clear both near-end and far-end latched loopback points

**Keyword:** dact-cdl

**Related Commands:** act-cdl, act-lbp, dact-lbp, rept-stat-cdl, tst-slk

**Command Class:** Link Maintenance

**Parameters**

**:link=** (mandatory)

SS7 signaling ports. The signaling port to which the SS7 signaling link being tested is assigned.

**Synonym:** port

**Range:** a, b, a1-a31, b1-b31

Not all card types support all **link** parameter values.

See Table A-1 for valid **link** parameter range values for each type of card that can have assigned signaling links.

**:loc=** (mandatory)

The card location as stenciled on the shelf of the system.

**Range:** 1101-1108, 1111-1112, 1201-1208, 1211-1218, 1301-1308, 1311-1318, 2101-2108, 2111-2118, 2201-2208, 2211-2218, 2301-2308, 2311-2318, 3101-3108, 3111-3118, 3201-3208, 3211-3218, 3301-3308, 3311-3318, 4101-4108, 4111-4118, 4201-4208, 4211-4218, 4301-4308, 4311-4318, 5101-5108, 5111-5118, 5201-5208, 5211-5218, 5301-5308, 5311-5318, 6101-6108, 6111-6118

**Example**

```
dact-cdl:loc=1205:link=b
```

**Dependencies**

The card location specified in the **loc** parameter must be equipped.

The signaling link specified in the **link** parameter must be equipped.

Link Fault Sectionalization (LFS) must not be running on the specified signaling link when this command is entered.

Command Driven Loopback testing is not available during upgrade.

A link diagnostic test is in progress on the signaling link specified in the **link** parameter, but it is not a Command Driven Loopback.

The card location specified in the **loc** parameter must be in service.

The signaling link specified in the **link** parameter must not be active.

The card location specified in the **loc** parameter cannot be reserved by the system.

**Notes**

None

**Output**

```
dact-cdl:loc=1205:link=b
```

```
tekelecstp 05-01-21 17:00:36 EST EAGLE5 33.0.0
Command Accepted: Stop Command Driven Loopback message is sent.
```

```
;
```

```
tekelecstp 05-01-21 17:00:36 EST EAGLE5 33.0.0
Command Completed.
```

```
;
```

**dact-cmd****Deactivate Command**

This command halts processing and output of the commands listed in Table 5-39.

Used without the **trm** parameter, the **dact-cmd** command is entered on the same terminal that is currently running the command that you want to cancel.

Used with the **trm** parameter, the **dact-cmd** command is entered on a terminal other than the one that is currently running the command that you want to cancel.

**Table 5-39.** Commands For Which **dact-cmd** Aborts Processing and Output

Command		
<b>rept-imt-info</b>	<b>rtrv-as</b>	<b>rtrv-obit</b> (active OAM)
<b>rept-stat-as</b>	<b>rtrv-assoc</b>	<b>rtrv-rte</b>
<b>rept-stat-assoc</b>	<b>rtrv-cmd</b>	<b>rtrv-seculog</b>
<b>rept-stat-card</b>	<b>rtrv-dstn</b>	<b>rtrv-secu-user</b>
<b>rept-stat-clk</b>	<b>rtrv-gta</b>	<b>rtrv-slk</b>
<b>rept-stat-dstn</b>	<b>rtrv-gtt</b>	<b>rtrv-tbl-capacity</b>
<b>rept-stat-ls</b>	<b>rtrv-lbp</b>	<b>rtrv-trbltx</b>
<b>rept-stat-rte</b>	<b>rtrv-log</b>	<b>rtrv-uaps</b>
<b>rept-stat-slk</b>	<b>rtrv-ls</b>	<b>rtrv-vflx-cd</b>
<b>rept-stat-trbl</b>	<b>rtrv-map</b>	<b>rtrv-vflx-rn</b>
<b>rtrv-appl-rtkey</b>	<b>rtrv-mrn</b>	<b>rtrv-vflx-vmsid</b>

**NOTE:** The Basic command class allows use of this command without the **trm** parameter (for **dact-cmd**); the Security Administration command class is required for use of this command when the **trm** parameter is specified (**dact-cmd:trm=x**).

**Keyword:** **dact-cmd**

**Related Commands:** **rept-imt-info**, **rept-stat-as**, **rept-stat-assoc**, **rept-stat-card**, **rept-stat-dstn**, **rept-stat-ls**, **rept-stat-slk**, **rtrv-appl-rtkey**, **rtrv-assoc**, **rtrv-dstn**, **rtrv-gta**, **rtrv-gtt**, **rtrv-log**, **rtrv-ls**, **rtrv-map**, **rtrv-rte**, **rtrv-seculog**, **rtrv-slk**, **rtrv-trbltx**, **rtrv-uaps**

**Command Class:** Basic

### Parameters

**:trm=** (optional)

The terminal on which the command is to be canceled.

**Range:** 1-40

### Example

```
dact-cmd
```

```
dact-cmd:trm=3
```

### Dependencies

You cannot specify the **trm** parameter in a **dact-cmd** command that you enter on the same terminal that is running the command that you want to cancel. The terminal will return an error: system is busy.

The **dact-cmd:trm=** command requires the security administration command class for the terminal and for the user.

### Notes

The **dact-cmd** command (without the **trm** parameter) must be entered on the same terminal that is running the command you want to cancel.

If the **dact-cmd** command is entered on a terminal that is not running a command, the **dact-cmd** command completes successfully without returning an error. Likewise, if the **dact-cmd:trm=**



command is entered and there is no command running on the specified terminal, the **dact-cmd:trm=** command completes successfully without returning an error.

Command aborted on terminal 2.

You might still see some output after the abort message if output accumulated in the output queue before you issued the **dact-cmd** command. When you cancel a command, the cancellation should take no longer than 25 seconds to take effect.

The **F9** function key provides the same functionality as the **dact-cmd** command (without the **trm** parameter). On a terminal in KSR mode, pressing <CTRL>I, also provides the same function.

The **dact-cmd** and the **F9** function key cannot be used for pure SEAS commands.

If you try to cancel a command other than one listed in Table 5-39, the terminal accepts the command, but output and processing of the current command continue.

When the **dact-cmd** command is entered, a command status code of AB (command aborted) is logged in the security log as follows:

- When the **dact-cmd** (without the **trm** parameter) is entered, no entry is logged.
- When the **dact-cmd:trm=** command is entered, an entry is logged.
- When the **dact-cmd** (without the **trm** parameter) is entered as a SEAS flow-thru command, an entry is logged. The **dact-cmd:trm=** command is not allowed as a SEAS flow-thru command because the **dact-cmd:trm=** command belongs to the Security Administration Command Class.

For examples of the security log entries, see the **rtrv-seculog** command.

## Output

### **dact-cmd**

```
rlghncxa03w 04-04-27 17:00:36 EST EAGLE 31.6.0
dact-cmd
Command entered at terminal #2.
```

```
rlghncxa03w 04-04-27 17:00:36 EST EAGLE 31.6.0
Command aborted on terminal 2.
```

;

### **dact-cmd:trm=2**

```
rlghncxa03w 04-04-27 17:00:36 EST EAGLE 31.6.0
dact-cmd:trm=2
Command entered at terminal #3.
```

```
rlghncxa03w 04-04-27 17:00:36 EST EAGLE 31.6.0
Command aborted on terminal 2.
```

;

## dact-echo

## Deactivate Echo

Use this command to halt the echoing of command responses from the user's terminal to other terminals or printers.

**Keyword:** **dact-echo**

**Related Commands:** **act-echo**, **alw-trm**, **canc-echo**, **chg-trm**, **inh-trm**, **rept-stat-trm**, **rmv-trm**, **rst-trm**, **rtrv-trm**

**Command Class:** Basic

## Parameters

**:trm=** (optional)  
 The ID number of the terminal for which the echo is being canceled.  
**Range:** 1-16  
**Default:** Cancels all active echoes

## Example

```
dact-echo
```

## Dependencies

You cannot cancel the echo to the same terminal from which you are issuing the **dact-echo** command. There must be an active echo (**act-echo**) to the terminal specified.

## Notes

Only the echoing of command output responses can be halted by this command. To halt the printing of alarm and network messages, you must use the **chg-trm** command.

## Output

```
dact-echo
rlghncxa03w 04-01-07 11:11:28 EST EAGLE 31.3.0
Command entered at terminal #6.
Scroll Area Output echo disabled to all terminals.
;

dact-echo:trm=7
rlghncxa03w 04-01-07 11:11:28 EST EAGLE 31.3.0
Command entered at terminal #1.
Scroll Area Output echo disabled for terminal 7.
;
```

## dact-lbp

## Deactivate Loopback Point Test

Use this command to deactivate a previously activated loopback point test, if a test is active. If no test is active, the command attempts to clear both near-end and far-end latched loopback points.

**Keyword:** dact-lbp

**Related Commands:** act-lbp, chg-lbp, dlt-lbp, ent-lbp, rept-stat-lfs, rtrv-lbp

**Command Class:** Link Maintenance

## Parameters

**:link=** (mandatory)  
 SS7 signaling link. The signaling link for which the loopback point test is being deactivated.  
**Synonym:** port  
**Range:** a, b, a1-a31, b1-b31  
 Not all card types support all **link** parameter values.  
 See Table A-1 for valid **link** parameter range values for each type of card that can have a location specified in the **loc** parameter.

**:loc=** (mandatory)  
 Card location. The unique identifier of the card containing the signaling link on which loopback point testing is to be deactivated.  
**Range:** 1101-1108, 1111-1112, 1201-1208, 1211-1218, 1301-1308, 1311-1318, 2101-2108, 2111-2118, 2201-2208, 2211-2218, 2301-2308, 2311-2318, 3101-3108, 3111-3118, 3201-3208, 3211-3218, 3301-3308, 3311-3318, 4101-4108, 4111-4118, 4201-4208,

4211-4218, 4301-4308, 4311-4318, 5101-5108, 5111-5118, 5201-5208, 5211-5218,  
5301-5308, 5311-5318, 6101-6108, 6111-6118

### Example

```
dact-lbp:loc=1205:link=b
```

### Dependencies

The specified signaling link must be equipped.

For clearing a remotely initiated loopback or LFS test stop, the card location (**loc** parameter) must be a **limds0**, **limt1**, or **limch** (associated with a **limt1**) card configured with either an **ss7ansi** or **ccs7itu** application.

The **dact-lbp** command cannot be entered until any previously issued **act-lbp** or **dact-lbp** command is accepted.

If an LFS test is about to complete, a new **dact-lbp** command cannot be entered until the test completes.

The **dact-lbp** command cannot be entered to cancel a signaling link test (a **tst-slk** test).

The **dact-lbp** command cannot be entered to cancel a Command Driven Loopback test.

The specified link is not found, and the max number of allowed LFS or signaling link tests are already in progress. At least one active LFS or signaling link test must be completed before this command can be entered again.

This command cannot be entered during upgrade.

The specified signaling link must not be active.

For clearing a remotely initiated loopback, the card location specified in the **loc** parameter must be equipped.

For clearing a remotely initiated loopback, The card location specified in the **loc** parameter must be in service (**IS-NR**).

For clearing a remotely initiated loopback, the card location specified in the **loc** parameter cannot be reserved by the system.

### Notes

After the deactivation of loopback point testing has started, you cannot cancel the process.

If an LFS test is aborted by a card reset, it could leave the remote far-end loop-back condition active. Use the **dact-lbp** command to cancel LFS tests.

**Output**

The following example output is generated only when a latched loopback is cleared and when there were no active loopback tests in progress.

**NOTE: This situation could occur even if there were no latched loopbacks to be cleared.**

```
dact-lbp:loc=1205:link=b
rlghncxa03w 04-02-17 16:02:05 EST EAGLE5 33.0.0
LOC = 1205 LINK = B
CLEAR STATUS = PASS, loopback was cleared.
;
```

The following example output is generated only when a latched loopback could not be cleared when there were no active loopback tests in progress.

```
dact-lbp:loc=1205:link=b
rlghncxa03w 04-02-17 16:02:05 EST EAGLE5 33.0.0
LOC = 1205 LINK = B
CLEAR STATUS = ERROR, loopback could not be cleared.
;
```

**dact-rstst****Deactivate Route Set Test**

Use this command to request deactivation of the routeset test being performed by the LIMs running the **ss7ansi** application. The system verifies that the point code and the linkset exist, and that the specified linkset is in the routeset of the specified point code. If it is, then a request to stop routeset testing procedures for the specified destination-linkset combination is sent to the LIM.

**Keyword:** **dact-rstst**

**Related Commands:**

**Command Class:** System Maintenance

**Parameters**

**:dpc=** (mandatory)

The ANSI destination point code of the destination, x-list entry, or cluster whose routeset testing is to be stopped, with subfields *network indicator-network cluster-network cluster member (ni-nc-ncm)*.

**Synonym:** **dpca**

**Range:** **000-255**

Specify a valid value for each subfield of the point code, and separate the subfields with a dash (-).

When **chg-sid:pctype=ansi** is specified, **ni = 000** is not valid.

When **chg-sid:pctype=ansi** is specified, **nc = 000** is not valid if **ni = 001-005**.

When **chg-sid:pctype=ansi** is specified, **nc = 000** is valid if **ni = 006-255**.

The point code **000-000-000** is not a valid point code.

**:lsn=** (mandatory)

The name of the linkset associated with the destination point code that is to have routeset testing stopped.

**Range:** *ayyyyyyyyy*

1 alphabetic character followed by 9 alphanumeric characters

**Example**

```
dact-rstst:dpc=1-2-*:lsn=lsn1a
dact-rstst:dpc=1-2-33:lsn=lsn1b
```

**Dependencies**

The specified DPC must be either provisioned or an x-list entry.

The specified linkset must be in the DPC's routeset.

The destination address must be a full point code or a cluster point code specified as *ni-nc-\**. A DPC cannot be specified as *ni-nc-\*\** or *ni-nc-\*\*\** for the **dact-rstst** command.

The specified linkset must exist in the linkset table.

**Notes**

None

**Output**

```
dact-rstst:dpc=1-2-*:lsn=lsn1a

rlghncxa03w 04-01-05 16:40:40 EST  EAGLE 31.3.0
Stop routeset testing request sent to SNM (scroll area)

rlghncxa03w 04-01-05 16:40:40 EST  EAGLE 31.3.0
Command Completed.

;
```

**dact-slk****Deactivate Signaling Link**

Use this command to change the state of the specified link to OOS-MT-DSBLD (out-of-service maintenance-disabled).



CAUTION

**CAUTION: This command impacts network performance, and should be used only during periods of low traffic.**

**Keyword:** dact-slk

**Related Commands:** act-slk, blk-slk, dlt-slk, ent-slk, inh-slk, rept-stat-slk, rtrv-slk, tst-slk, ublk-slk, unhb-slk

**Command Class:** Link Maintenance

**Parameters**

**:link=** (mandatory)

Signaling link on the card specified in the **loc** parameter. The signaling links can be specified in any sequence or pattern.

**Synonym:** port

**Range:** a, b, a1-a31, b1-b31

Not all card types support all **link** parameter values.

See Table A-1 for valid **link** parameter range values for each type of card that can have a location specified in the **loc** parameter.

**:loc=** (mandatory)

The card location as stenciled on the shelf of the system.

**Range:** 1101-1108, 1111-1112, 1201-1208, 1211-1218, 1301-1308, 1311-1318, 2101-2108, 2111-2118, 2201-2208, 2211-2218, 2301-2308, 2311-2318, 3101-3108, 3111-3118,

3201-3208, 3211-3218, 3301-3308, 3311-3318, 4101-4108, 4111-4118, 4201-4208,  
4211-4218, 4301-4308, 4311-4318, 5101-5108, 5111-5118, 5201-5208, 5211-5218,  
5301-5308, 5311-5318, 6101-6108, 6111-6118

### Example

```
dact-slk:loc=1301:link=a
```

### Dependencies

A card location must be specified that is valid and defined in the database.

No other action command can be in progress when this command is entered.

The card must be equipped and must be one of the following cards:

- An E1 ATM card running the **atmitu** application
- An E1/T1 MIM, E5-E1T1, or HC MIM card running the **ss7ansi** or **ccs7itu** application
- An E5 ATM card running the **atmansi** or **atmitu** application
- An E5-ENET card running the **ipsg** application
- An E5-ENET card or SSEDCCM card running the **iplim** or **iplimi** application with links having **ipliml2=m2pa**
- A LIM card running the **ss7ansi**, **ss7gx25**, or **ccs7itu** application
- A LIM ATM card running the **atmansi** application

The card must contain signaling links.

The signaling link must be equipped in the database.

The following **link** parameter values can be specified for the following cards that support more than 2 links per card:

- **a1-a3, b1-b3**—Multi-port LIM (MPL), SSEDCCM card running the **iplim** or **iplimi** application with links having **ipliml2=m2pa**, E1/T1 MIM card
- **a1-a31, b1-b31**—HC-MIM card
- **a1-a15, b1-b15**—E5-E1T1 card
- **a1-a7, b1-b7**—E5-ENET card running the **iplim** or **iplimi** application that supports 16 links
- **a1-a15, b1-b15**—E5-ENET card running the **ipsg** application

The card must be equipped in the specified card location.

### Notes

The *Installation Manual – EAGLE 5 ISS* provides an illustration of card locations.

After the **dact-slk** command is entered, verify the cancellation by issuing the **rept-stat-slk** command.

### Output

```
dact-slk:loc=1301:link=a
rlghncxa03w 04-01-07 11:11:28 EST EAGLE5 33.0.0
Deactivate Link message sent to card
;
```

**dact-user****Deactivate User**

Use this command to end a user session. The **logout** command has the same affect as the **dact-user** command.

**Keyword:** dact-user

**Related Commands:** act-user, chg-pid, chg-user, dlt-user, ent-user, login, logout, rept-stat-user, rtrv-secu-user, rtrv-user

**Command Class:** Basic

**Parameters**

This command has no parameters.

**Example**

```
dact-user
```

**Dependencies**

None

**Notes**

The **logout** or **canc-user** commands can be used in place of **dact-user**.

**Output**

Not applicable.

**disc-imt****Disconnect IMT**

The interprocessor message transport bus (IMT bus) is the main communications artery between all subsystems in the system. Use this command to disconnect a card from the specified IMT bus.

**Keyword:** disc-imt

**Related Commands:** clr-imt-stats, conn-imt, rept-imt-lvl1, rept-imt-lvl2, rept-stat-imt, rmv-imt, rst-imt

**Command Class:** System Maintenance

**Parameters**

**:bus=** (mandatory)

IMT bus to be disconnected from.

**Range:** a, b

**:loc=** (mandatory)

Card address. The card location as stenciled on the shelf of the system.

**Range:** 1101-1108, 1111-1112, 1201-1208, 1211-1218, 1301-1308, 1311-1318, 2101-2108, 2111-2118, 2201-2208, 2211-2218, 2301-2308, 2311-2318, 3101-3108, 3111-3118, 3201-3208, 3211-3218, 3301-3308, 3311-3318, 4101-4108, 4111-4118, 4201-4208, 4211-4218, 4301-4308, 4311-4318, 5101-5108, 5111-5118, 5201-5208, 5211-5218, 5301-5308, 5311-5318, 6101-6108, 6111-6118

**Example**

```
disc-imt:loc=1213:bus=b
```

**Dependencies**

This command cannot be entered during an IMT Fault Isolation Test. The card cannot be isolated from both IMT busses.

The card location, frame, shelf, or slot must be within the allowed range.

This command cannot be entered if an IMT Rate Change sequence is in progress.

### Notes

The card can be reconnected by issuing the **conn-imt** command, or by re-inserting the card. A software reset does not affect connect status. (The **init-card** command performs a software reset.)

### Output

**disc-imt:loc=1213:bus=b**

```
rlghncxa03w 04-01-07 11:02:30 EST EAGLE 31.3.0
Disconnect IMT Bus B command issued to card 1213
;
```

## disp-fta-dir

### Display Contents of the File Transfer Area

Use this command to display the files that are in the file transfer area (FTA) the layout of FTA, and the amount of free space in the FTA.

**Keyword:** **disp-fta-dir**

**Related Commands:** **act-file-trns, copy-fta, dlt-fta**

**Command Class:** System Maintenance

### Parameters

**:loc=** (optional)

The location of the fixed disk whose FTA is to be displayed.

**Range:** **1114, 1116**  
(TDMs)

**Default:** The active TDM location

### Example

**disp-fta-dir:loc=1114**

### Dependencies

This command must display the files (along with deleted files and free slots) in the order in which they appear in the file transfer area.

The **loc** parameter must specify a TDM card.

Only one file transfer can be active at a time.

TDM and E5-TDM cards cannot co-exist in the system.

### Notes

None



**Output**

```

disp-fta-dir:loc=1114
rlghncxa03w 05-07-01 16:21:12 EST EAGLE 31.3.0
File Transfer Area Directory of fixed disk 1114:

FILENAME                LENGTH  LAST MODIFIED  LBA
oam.elf                  1048576 05-07-01 16:51 40960
<deleted>                65536   -----  ----- 43008
sccp.elf                 1048576 05-07-01 18:30 43136
<deleted>                1048576 -----  ----- 46704
tbl213.out               640000 05-07-01 06:39 48752
  5 File(s) 21584896 bytes free

```

;

**dlt-acg-mic****Delete ACG Manually Initiated Control**

Use this command to delete ACG controls that apply to certain queries. The control can apply to all queries or to specific query services and called party digits. A particular control is selected to be deleted by either specifying that it is the **type=all** control or specifying its service and digits.

**Keyword:** dlt-acg-mic

**Related Commands:** chg-acg-mic, ent-acg-mic, rept-stat-lnp, rtrv-acg-mic

**Command Class:** Database Administration

**Parameters**

**:dgts=** (optional)  
 Digits  
**Range:** 3-10 digits

**:serv=** (optional)  
 Query service  
**Range:** ain, in

**:type=** (optional)  
 Type of control  
**Range:** all, sd  
**Default:** sd

**Example**

```

dlt-acg-mic:type=all
dlt-acg-mic:serv=ain:dgts=9194602132

```

**Dependencies**

If the **type=all** parameter is specified, optional parameters **serv** and **dgts** are not allowed.

If the **type=sd** parameter is specified, optional parameters **srv** and **dgts** are required.

If the **type=all** parameter is specified, a MIC with **type=all** must exist.

If the **type=sd** parameter is specified, a MIC with the same service and digits must exist.

The LNP feature must be turned on (see the **enable-ctrl-feat** command) before this command can be entered.

The **dgts** parameter value must be 3 digits or 6-10 digits in length.

**Notes**

None

**Output**

```

dlt-acg-mic:type=all

rlghncxa03w 04-02-28 08:50:12 EST  EAGLE 31.3.0
ACG MIC table is (10 of 256) 4% full of type SD
DLT-ACG-MIC: MASP A - COMPLTD
;

```

**dlt-acg-noc****Delete ACG Node Overload Control**

Use this command to delete the definition of a node overload level. The definition is comprised of the threshold LNP query rates for node overload levels and the values for the Automatic Call Gappings (ACG) to be sent when at the level. If a level is not defined, it is not used. Level 10 cannot be deleted.

**Keyword:** dlt-acg-noc

**Related Commands:** chg-acg-noc, ent-acg-noc, rept-stat-lnp, rtrv-acg-noc

**Command Class:** Database Administration

**Parameters**

**:lvl=** (mandatory)  
Overload level.  
**Range:** 1-9

**Example**

```
dlt-acg-noc:lvl=3
```

**Dependencies**

The specified overload level must be defined.

The LNP feature must be turned on (see the **enable-ctrl-feat** command) before this command can be entered.

**Notes**

None

**Output**

```

dlt-acg-noc:lvl=3

rlghncxa03w 04-02-28 08:50:12 EST  EAGLE 31.3.0
DLT-ACG-NOC: MASP A - COMPLTD
;

```

**dlt-appl-rtkey****Delete Application Route Key Table**

Use this command to delete static entries from the Routing Key table. These entries are used to associate a routing key with a socket name. A static entry is created using the **ent-appl-rtkey** command.

There are three types of routing keys, as follows:

- DPC, SI, SSN routing keys, which are used to route SCCP messages
- DPC, SI routing keys, which are used to route non-SCCP and non-ISUP messages
- DPC, SI, CIC routing keys, which are used to route ISUP messages

**Keyword:** dlt-appl-rtkey

**Related Commands:** ent-appl-rtkey, rtrv-appl-rtkey

**Command Class:** Database Administration

### Parameters

**NOTE:** See "Point Code Formats and Conversion" for a detailed description of point code formats, rules for specification, and examples.

**:asname=** (optional)

Application Server (AS) name; AS assigned to this routing key.

**Range:** ayyyyyyyyyyyyyy

Up to 15 alphanumeric characters; the first character must be a letter

**:cice=** (optional)

The end range of circuit identification codes assigned to the routing key. Specify **cice** along with **cics** to identify the routing key to be changed. Valid only if **si=4, 5, or 13** and required if **si=4, 5, or 13**.

**Range:** 0-4294967295

See Table A-4 for valid CIC values for specified SI and MSU types.

**:cics=** (optional)

The end range of circuit identification codes assigned to the routing key. Specify **cice** along with **cics** to identify the routing key to be changed. Valid only if **si=4, 5, or 13** and required if **si=4, 5, or 13**.

**Range:** 0-4294967295

See Table A-4 for valid CIC values for specified SI and MSU types.

**:dpc=** (optional)

ANSI destination point code with subfields *network indicator-network cluster-network cluster member (ni-nc-ncm)*.

**Synonym:** dpca

**Range:** 000-255

Specify a valid value for each subfield of the point code, and separate the subfields with a dash (-).

When **chg-sid:pctype=ansi** is specified, *ni = 000* is not valid.

When **chg-sid:pctype=ansi** is specified, *nc = 000* is not valid if *ni = 001-005*.

When **chg-sid:pctype=ansi** is specified, *nc = 000* is valid if *ni = 006-255*.

The point code **000-000-000** is not a valid point code.

**:dpc/dpca/dpci/dpcn/dpcn24=** (optional)

Destination point code.

**:dpci=** (optional)

ITU international destination point code with subfields *zone-area-id*. The *prefix* subfield indicates a spare point code (*prefix-zone-area-id*).

**Range:** s-, 0-255

Specify a valid value for each subfield of the point code, and separate the subfields with a dash (-).

*prefix*—s-

*zone*—0-7

*area*—000-255

*id*—**0-7**

The point code **0-000-0** is not a valid point code.

**:dpcn=** (optional)

ITU national destination point code in the format of a 5-digit number (*nnnnn*); or 2, 3, or 4 numbers (members) separated by dashes (*m1-m2-m3-m4*) as defined by the **chg-stpopts:npfnti** flexible point code option. A group code must be specified when the ITUDUPPC feature is turned on (*nnnnn-gc*, *m1-m2-m3-m4-gc*). The *prefix* subfield indicates a spare point code (*prefix-nnnnn*, *prefix-nnnnn-gc*, *prefix-m1-m2-m3-m4*, *prefix-m1-m2-m3-m4-gc*).

**Range:** **s-, 0-16383, aa-zz**

Specify a valid value for each subfield of the point code, and separate the subfields with a dash (-).

*prefix*—**s-**

*nnnnn*—**0-16383**

*gc*—**aa-zz**

*m1-m2-m3-m4*—**0-14** for each member; values must sum to 14

**:dpcn24=** (optional)

24-bit ITU national destination point code with subfields *main signaling area-sub signaling area-signaling point* (*msa-ssa-sp*).

**Range:** **000-255**

Specify a valid value for each subfield of the point code, and separate the subfields with a dash (-).

*msa*—**000-255**

*ssa*—**000-255**

*sp*—**000-255**

**:opc=** (optional)

ANSI originating point code with subfields *network indicator-network cluster-network cluster member* (*ni-nc-ncm*).

**Synonym:** **opca**

**Range:** **000-255**

Specify a valid value for each subfield of the point code, and separate the subfields with a dash (-).

When **chg-sid:pctype=ansi** is specified, *ni* = **000** is not valid.

When **chg-sid:pctype=ansi** is specified, *nc* = **000** is not valid if *ni* = **001-005**.

When **chg-sid:pctype=ansi** is specified, *nc* = **000** is valid if *ni* = **006-255**.

The point code **000-000-000** is not a valid point code.

**:opc/opca/opci/open/open24=** (optional)

Originating point code. Valid only if **si=4, 5, or 13** and required if **si=4, 5, or 13**.

**:opci=** (optional)

ITU international originating point code with subfields *zone-area-id*. The *prefix* subfield indicates a spare point code (*prefix-zone-area-id*)

**Range:** **s-, 0-255**

Specify a valid value for each subfield of the point code, and separate the subfields with a dash (-).

*prefix*—**s-**

*zone*—**0-7**  
*area*—**000-255**  
*id*—**0-7**

The point code **0-000-0** is not a valid point code.

**:open=** (optional)

ITU national originating point code in the format of a 5-digit number (*nnnnn*); or 2, 3, or 4 numbers (members) separated by dashes (*m1-m2-m3-m4*) as defined by the **chg-stpopts:npfnti** flexible point code option. A group code must be specified when the ITUDUPPC feature is turned on (*nnnnn-gc*, *m1-m2-m3-m4-gc*). The *prefix* subfield indicates a spare point code (*prefix-nnnnn*, *prefix-nnnnn-gc*, *prefix-m1-m2-m3-m4*, *prefix-m1-m2-m3-m4-gc*).

**Range:** **s-, 0-16383, aa-zz**

Specify a valid value for each subfield of the point code, and separate the subfields with a dash (-).

*prefix*—**s-**  
*nnnnn*—**0-16383**  
*gc*—**aa-zz**  
*m1-m2-m3-m4*—**0-14** for each member; values must sum to 14

**:open24=** (optional)

24-bit ITU national originating point code with subfields *main signaling area-sub signaling area-signaling point* (*msa-ssa-sp*).

**Range:** **000-255**

Specify a valid value for each subfield of the point code, and separate the subfields with a dash (-).

*msa*—**000-255**  
*ssa*—**000-255**  
*sp*—**000-255**

**:rcontext=** (optional)

Identify a routing key by its routing context when a routing key needs to be deleted as an optional alternative to entering the **dpc/si/ssn/opc/cics/cice/type** key parameters.

**Range:** **0-4294967295**

**:si=** (optional)

The service indicator

**Range:** **0-15**

**0-15** or equivalent text values:

**Number = Text—Description**

**0 = snm**—Signaling network management messages

**1 = regtest**—Signaling network testing and maintenance regular

**2 = spltest**—Signaling network testing and maintenance special

**3 = sccp**—SCCP

**4 = tup**—Telephone user part

**5 = isup**—ISDN user part

**13 = qbicc**

**:ssn=** (optional)

The subsystem number.

**Range:** **0-255**

**:type=** (optional)

The type of routing key that is being changed.

**Range:** full, partial, default

**Default:** full

### Example

```
dlt-appl-rtkey:dpc=1-1-1:si=3:asname=as1:ssn=255
```

```
dlt-appl-
```

```
rtkey:dpci=s-3-11-1:si=5:opci=s-4-11-2:cics=1:cice=1000:asname=as  
itu
```

```
dlt-appl-rtkey:rcontext=100
```

### Dependencies

The SSN is valid and must be specified only when the **si=3** (or **sccp**) parameter is specified. When the **si=3** (or **sccp**) parameter is not specified, the **ssn** parameter must not be specified.

The value entered for the starting circuit identification code (**cics**) must be less than or equal to the value entered for the ending circuit identification code (**cice**).

A circuit identification code range (**cics** to **cice**) that overlaps an existing routing key cannot be specified.

When the DPC is ANSI and the **si=4** parameter is specified, a DPC/SI routing key must be specified (TUP is used only in an ITU network).

The **opc**, **cics**, and **cice** parameters are required and can be entered only if the **si** parameter value is **4**, **5**, or **13**.

If the **si=4**, **5**, or **13** (or **tup**, **isup**) parameter is specified, or the **qbicc** parameter is specified, a value must also be specified for the **opc**, **cics**, and **cice** parameters used to route ISUP messages. The **opc**, **cics**, and **cice** parameters can be specified only if the **si=4**, **5**, or **13** (or **tup**, **isup**) parameter is specified, or if the **qbicc** parameter is specified.

Table A-4 shows valid CIC values for SI types 4, 5, and 13.

The routing key must be in the Routing Key table.

If the **asname** parameter is specified, the AS name must already be defined in the AS table. The AS name and parameters specified for a routing key must use an address format that is valid for the adapter type used by the ASP associations assigned to the AS.

When the **type=full** parameter is specified, the **dpc** and **si** parameters must be specified.

The following types of partial routing keys are supported:

- DPC-SI-OPC (ignore CIC) can be used as a partial match key for CIC- based traffic.
- DPC-SI (ignore all other fields) can be used as a partial match key for CIC- based traffic or SCCP traffic.
- DPC only (ignore all other fields) can be used as a partial match for any type of traffic.
- SI only (ignore all other fields) can be used as a partial match for any type of traffic.

The following card locations are not valid for this command: 1113, 1115, 1117, 1118, and all *xy09* and *xy10* locations (where *x* is the frame and *y* is the shelf). The card must be equipped and in service.

If the **type=default** parameter is specified, then the **dpc**, **si**, **ssn**, **opc**, **cice**, and **cics** parameters cannot be specified.

The **asname** or the **rcontext** parameter must be specified in the command.

**Notes**

A specific routing key/socket name association can be deleted by specifying a fully qualified routing key (**dpc/dpca**, **si**, **ssn**, and **a sname**). By default, socket associations in the static key entries are deleted using the **dlt-appl-rtkey** command.

The originating point code (**opc**) and destination point code (**dpc**) must not specify a cluster route.

Group codes are required for ITU-N point codes (DPCN/OPCN) when the Duplicate Point Code feature is turned on.

In this command, only ITU-international and ITU national point codes support the spare point code subtype prefix (**s-**).

**Output**

```
dlt-appl-rtkey:asname=tekelec:si=3:ssn=255:type=full:dpc=2-2-2
rlghncxa03w 08-03-17 15:35:05 EST EAGLE 38.0.0
DLT-APPL-RTKEY: MASP A - COMPLTD
;
```

**dlt-as****Delete Application Server**

Use this command to delete an AS.

**Keyword:** **dlt-as**

**Related Commands:** **chg-as**, **ent-as**, **rept-stat-as**, **rtrv-as**

**Command Class:** Database Administration

**Parameters**

**NOTE: The asname parameter is no longer available.**

**:aname=** (mandatory)

Name of the M3UA/SUA SCTP association to be deleted.

**Range:** *aaaaaaaaaaaaaaaa*

Up to 15 alphanumeric characters; the first character must be a letter.

**:asname=** (mandatory)

Application Server (AS) name; AS assigned to this routing key.

**Range:** *aaaaaaaaaaaaaaaa*

Up to 15 alphanumeric characters; the first character must be a letter

**Example**

```
dlt-as:as=asx:aname=asxp1
```

**Dependencies**

An AS that is still assigned to a routing key cannot be deleted.

The connection state for the associations assigned to the AS must be **open=no** before the AS can be deleted.

The AS must be defined in the AS table.

The specified associaton name (**aname**) parameter must be defined in the AS.

**Notes**

None

**Output**

```
dlt-as:as=asx:as=asxp1

rlghncxa03w 04-02-17 15:35:05 EST EAGLE 31.3.0
DLT-AS: MASP A - COMPLTD
;
```

**dlt-assoc****Delete Association**

Use this command to delete the SCTP associations from the IPAPSOCK table.

**Keyword:** dlt-assoc

**Related Commands:** chg-assoc, ent-assoc, rtrv-assoc

**Command Class:** Database Administration

**Parameters**

**:aname=** (mandatory)

Name assigned to the association to be deleted.

**Range:** ayyyyyyyyyyyyyy

Up to 15 alphanumeric characters; the first character must be a letter

**Example**

```
dlt-assoc:aname=tekelec
```

**Dependencies**

The association name (**aname**) must already exist in the IP Socket/Association (IPAPSOCK) table.

An association that exists on any AS cannot be deleted from the IPAPSOCK table.

An AS assigned to a routing key cannot be deleted from the IPAPSOCK table.

The connection state must be **open=no** to delete the association from the IPAPSOCK table.

If the association on an IPSG card is referenced by a signaling link, then the association cannot be deleted.

**Notes**

None.

**Output**

```
dlt-assoc:aname=tekelec

rlghncxa03w 04-02-17 15:35:05 EST EAGLE 31.3.0
DLT-ASSOC: MASP A - COMPLTD
;
```

**dlt-card****Delete Card**

Use this command to remove a card entry from the system database.

**Keyword:** dlt-card

**Related Commands:** init-card, rept-stat-card, rmv-card, rst-card, rtrv-card

**Command Class:** Database Administration

**Parameters**

**:loc=** (mandatory)

The card location as stenciled on the shelf of the system.



**Range:** 1101-1108, 1111-1112, 1201-1208, 1211-1218, 1301-1308, 1311-1318, 2101-2108, 2111-2118, 2201-2208, 2211-2218, 2301-2308, 2311-2318, 3101-3108, 3111-3118, 3201-3208, 3211-3218, 3301-3308, 3311-3318, 4101-4108, 4111-4118, 4201-4208, 4211-4218, 4301-4308, 4311-4318, 5101-5108, 5111-5118, 5201-5208, 5211-5218, 5301-5308, 5311-5318, 6101-6108, 6111-6118

### Example

```
dlt-card:loc=1201
```

### Dependencies

The card location slot must be between **1** and **16**, but not **9** or **10**.

The card location cannot be **1113–1118**.

The shelf location must be **11xx**, **12xx**, **13xx**, **21xx**, **22xx**, **23xx**, **31xx**, **32xx**, **33xx**, **41xx**, **42xx**, **43xx**, **51xx**, **52xx**, **53xx**, or **61xx**.

The shelf and card must be equipped.

Before this command can be entered, all TCP/IP data links assigned to the card must be deleted.

Before an E1 card or an E1/T1 MIM card used as an E1 card can be deleted, any E1 interfaces assigned to the card must be deleted

Before an E1/T1 MIM card that is used as a T1 card can be deleted, any T1 interfaces assigned to the card must be deleted.

After the links are deleted, the card must be inhibited before it can be deleted. Use the **inh-card** command to set the card to the OOS-MT-DSBLD state.

Before this command can be entered, SS7 signaling links assigned to the card must be deleted.

Only one database change, action, backup, or restore can be in progress at a time.

### Notes

If a SEAS terminal is configured for a location, then entering the **dlt-card** command causes the warning “Invalidating the Terminal data in SEASCFG table” to appear.

### Output

```
dlt-card:loc=1201
  rlgncxa03w 04-01-07 11:11:28 EST EAGLE 31.3.0
  DLT-CARD: MASP A - COMPLTD
;
```

## dlt-csl

### Delete Common Screening List

Use this command to delete an existing entry from the Common Screening List (CSL). The Common Screening List commands are used to tailor certain types of general screening information to specific features.

**Keyword:** dlt-csl

**Related Commands:** chg-csl, ent-csl, rtrv-csl, rtrv-ctrl-feat

**Command Class:** Database Administration



**ccnc**— CC+NC List  
**insl**— In Network Subscriber List  
**skts**— Service Key + Teleservice List  
**vmpfx**— Voice Mail Prefix List  
**trig**— Trigger List  
**delpfx**— Delete Prefix List

The following screening lists are valid for the indicated features:

- **insl, skts**—IDP Screening for Prepaid
- **ccnc, gt**—Prepaid IDP Query Relay and Info Analyzed Relay Base
- **skbcsm**—Prepaid IDP Query Relay
- **vmpfx**—VFLEX
- **trig**—Info Analyzed Relay Base

The **delpfx** list is not supported at this time. This list should only be used by Tekelec personnel.

**:pc=** (optional)

ANSI point code with subfields *network indicator-network cluster-network cluster member (ni-nc-ncm)*.

**Synonym:** **pca**

**Range:** **000-255**

Specify a valid value for each subfield of the point code, and separate the subfields with a dash (-).

When **chg-sid:pctype=ansi** is specified, *ni = 000* is not valid.

When **chg-sid:pctype=ansi** is specified, *nc = 000* is not valid if *ni = 001-005*.

When **chg-sid:pctype=ansi** is specified, *nc = 000* is valid if *ni = 006-255*.

The point code **000-000-000** is not a valid point code.

**:pc/pca/pci/pcn/pcn24=** (optional)

Point code. Either the **ds** parameter or a point code parameter must be specified.

**:pci=** (optional)

ITU international point code with subfields *zone-area-id*.

**Range:** **0-255**

Specify a valid value for each subfield of the point code, and separate the subfields with a dash (-).

The point code **0-000-0** is not a valid point code.

*zone*—**0-7**

*area*—**000-255**

*id*—**0-7**

**:pcn=** (optional)

ITU national point code in the format of a 5-digit number (*nnnnn*); or 2, 3, or 4 numbers (members) separated by dashes (*m1-m2-m3-m4*) as defined by the **chg-stpopts:npcfmti** flexible point code option. A group code must be specified when the ITUDUPPC feature is turned on (*nnnnn-gc, m1-m2-m3-m4-gc*).

**Range:** **s-, 0-16383, aa-zz**

Specify a valid value for each subfield of the point code, and separate the subfields with a dash (-).

*prefix*—**s**

*n1-n2-n3-n4*—**0-16383**

*gc*—**aa-zz**

*m1-m2-m3-m4*—**0-14** for each member; values must sum to 14

**:pcn24=** (optional)

24-bit ITU national point code with subfields *main signaling area-sub signaling area-signaling point (msa-ssa-sp)*.

**Range:** **000-255**

Specify a valid value for each subfield of the point code, and separate the subfields with a dash (-).

*msa*—**000-255**

*ssa*—**000-255**

*sp*—**000-255**

**:pn=** (optional)

Part Number. The 9-digit "893xxxxxx" part number of the feature for which the command is entered. The **rtrv-ctrl-feat** command description shows the part number in the command output example. Either the **pn** parameter or the **feature** parameter must be specified to identify the feature.

**Range:** **893000000-893999999**

The first 3 digits are **893**. Do not separate the digits with dashes or spaces. The following part numbers are valid for this command:

- **893015501**—IDP Screening for Prepaid
- **893016001**—Prepaid IDP Query Relay
- **893034201**—Info Analyzed Relay Base
- **893016701**—VFLEX

### Example

```
dlt-csl:feature="IDP Screening for Prepaid":list=insl:ds=246810
```

```
dlt-csl:pn=893015501:list=skts:ds=36ab
```

```
dlt-csl:feature="VFLEX":list=vmpfx:ds=123456789abcdEF
```

### Dependencies

An enabled feature must be specified using either a valid part number (**pn**) or feature name (**feature**). The specified feature must use a Common Screening List.

The value specified for the feature parameter must be a valid feature name for a feature that uses a Common Screening List. The feature name must be specified as it appears in the **rtrv-ctrl-feat** command output. Enough of the name must be specified to make the name unique when two features begin with the same word or acronym.

The feature that is specified in the **feature** parameter must be enabled.

The **list** parameter must be specified for features that use more than one type of screening list.

The value specified for the **list** parameter must be valid for the specified screening feature. The following **list** parameter values are valid for the indicated feature:

- **insl, skts**—IDP Screening for Prepaid

- **gt, ccnc**—Prepaid IDP Query Relay or Info Analyzed Relay Base
- **skbcm**—Prepaid IDP Query Relay
- **vmpfx**—VFLEX
- **trig**—Info Analyzed Relay Base

The specified screening list entry must exist in the screening list that is used by the feature.

The following parameters are allowed with the indicated common screening list type:

- **list=gt—ds** parameter
- **list=ccnc—ds** parameter
- **list=skbcm—ds** parameter
- **list=skts—ds** parameter
- **list=insl—ds** parameter
- **list=vmpfx—ds** parameter
- **list=trig—ds** parameter

The **pc** and **ds** parameters cannot be specified together in the command.

## Notes

None

## Output

```
dlt-csl:pn=893015501:list=insl:ds=123456789abcDEF
tekelecstp 05-08-21 15:18:41 EST EAGLE 34.3.0
INSL List table is (5 of 50) 10% full
DLT-CSL: MASP A - COMPLTD
;

dlt-csl:feature="VFLEX":list=vmpfx:ds=123456789abcDEF
tekelecstp 08-05-23 15:04:03 EST EAGLE 39.0.0
VM Prefix List table is (1 of 100) 1% full
DLT-CSL: MASP A - COMPLTD
;

dlt-csl:pn=893016001:list=skbcm:ds=9876543210
tekelecstp 08-05-11 15:18:41 EST EAGLE 39.0.0
SK+BCSM List table is (5 of 50) 10% full
DLT-CSL: MASP A - COMPLTD
;
```

## dlt-cspc

### Delete Concerned Signaling Point Code

Use this command to remove a CSPC or an entire CSPC group.

**Keyword:** dlt-cspc

**Related Commands:** ent-cspc, rtrv-cspc

**Command Class:** Database Administration

### Parameters

One, but not both, of these optional parameters must be specified: **all**, **pc/pca/pci/pcn/pcn24**.

**NOTE: See "Point Code Formats and Conversion" for a detailed description of point code formats, rules for specification, and examples.**

**:grp=** (mandatory)

Group name

**Range:** *ayyyyyyy*

1 alphabetic character followed by up to 7 alphanumeric characters

**:all=** (optional)

Use this parameter to confirm that all entries for this concerned signaling point code group are to be removed.

**Range:** **yes, no**

**Default:** **no**

**:pc=** (optional)

ANSI point code with subfields *network indicator-network cluster-network cluster member (ni-nc-ncm)*.

**Synonym:** **pca**

**Range:** **000-255**

Specify a valid value for each subfield of the point code, and separate the subfields with a dash (-).

When **chg-sid:pctype=ansi** is specified, *ni = 000* is not valid.

When **chg-sid:pctype=ansi** is specified, *nc = 000* is not valid if *ni = 001-005*.

When **chg-sid:pctype=ansi** is specified, *nc = 000* is valid if *ni = 006-255*.

The point code **000-000-000** is not a valid point code.

**:pc/pca/pci/pcn/pcn24=** (optional)

Concerned signaling point code.

**:pci=** (optional)

ITU international point code with subfields *zone-area-id*. The *prefix* subfield indicates a spare point code (*prefix-zone-area-id*)

**Range:** **s-, 0-255**

Specify a valid value for each subfield of the point code, and separate the subfields with a dash (-).

*prefix—s-*

*zone—0-7*

*area—000-255*

*id—0-7*

The point code **0-000-0** is not a valid point code.

**:pcn=** (optional)

ITU national point code in the format of a 5-digit number (*nnnnn*); or 2, 3, or 4 numbers (members) separated by dashes (*m1-m2-m3-m4*) as defined by the **chg-stpopts:npcfnti** flexible point code option. A group code must be specified when the ITUDUPPC feature is turned on (*nnnnn-gc*, *m1-m2-m3-m4-gc*). The *prefix* subfield indicates a spare point code (*prefix-nnnnn*, *prefix-nnnnn-gc*, *prefix-m1-m2-m3-m4*, *prefix-m1-m2-m3-m4-gc*).

**Range:** **s-, 0-16383, aa-zz**

Specify a valid value for each subfield of the point code, and separate the subfields with a dash (-).

*prefix*—**s-**

*n1-n2-n3-n4*—**0-16383**

*gc*—**aa-zz**

*m1-m2-m3-m4*—**0-14** for each member; values must sum to 14

**:pcn24=** (optional)

24-bit ITU national point code with subfields *main signaling area-sub signaling area-signaling point (msa-ssa-sp)*.

**Range:** **p-, 000-255**

Specify a valid value for each subfield of the point code, and separate the subfields with a dash (-).

*prefix*—**p-**

*msa*—**000-255**

*ssa*—**000-255**

*sp*—**000-255**

### Example

```
dlt-cspc:grp=grp01:pc=144-201-001
```

```
dlt-cspc:grp=grp01:pci=s-144-201-001
```

```
dlt-cspc:grp=grp01:all=yes
```

### Dependencies

A CPC group name must be specified. The specified group name must exist in the database.

The **grp** parameter and the **all=yes** parameter must be entered with no point code parameter, to remove a group and all of its point codes.

If a PC is specified, then the PC network type must match the group network type, and the PC must exist in the specified CPC group. The specified PC is removed from the CPC group.

Either a PC parameter or the **all=yes** parameter must be specified.

The Spare Point Code Support feature must be enabled before the spare PC prefix **s-** can be specified for an ITU-I or ITU-N point code.

A PC parameter cannot be entered together with the **all** parameter in the same command.

The specified CSPC group must not be referred to by any Mate Application entity.

If the Flexible GTT Load Sharing feature is not enabled, a CAUTION is displayed. When the feature is enabled, the command is rejected with message E4534.

### Notes

The system issues a warning if a mate application entity could potentially use a group name that is being deleted.

In this command, only ITU-international and ITU national point codes support the spare point code subtype prefix (**s-**).

### Output

```
dlt-cspc:grp=grp01:pci=2-2-2
tekelecstp 04-04-08 12:42:47 EST EAGLE 31.3.0
DLT-CSPC: MASP A - COMPLTD
;
```

**dlt-dlk****Delete Data Link**

Use this command to remove a TCP/IP data link from the database. The TCP/IP data link is used for the STP LAN feature, connecting the system to a remote host for message processing.

**Keyword:** **dlt-dlk**

**Related Commands:** **act-dlk, canc-dlk, ent-dlk, rept-stat-dlk, rtrv-dlk, tst-dlk**

**Command Class:** Database Administration

**Parameters**

**:loc=** (mandatory)

The card location as stenciled on the shelf of the system.

**Range:** **1101-1108, 1111-1112, 1201-1208, 1211-1218, 1301-1308, 1311-1318, 2101-2108, 2111-2118, 2201-2208, 2211-2218, 2301-2308, 2311-2318, 3101-3108, 3111-3118, 3201-3208, 3211-3218, 3301-3308, 3311-3318, 4101-4108, 4111-4118, 4201-4208, 4211-4218, 4301-4308, 4311-4318, 5101-5108, 5111-5118, 5201-5208, 5211-5218, 5301-5308, 5311-5318, 6101-6108, 6111-6118**

**Example**

```
dlt-dlk:loc=1201
```

**Dependencies**

The ACM is the only card type that is valid for this command.

The shelf and card must be equipped.

The specified ACM must have a TCP/IP data link assigned to it.

The specified ACM and data link must be out-of-service maintenance-disabled (OOS-MT-DSBLD).

Enter the **rept-stat-card** and **rept-stat-dlk** commands to verify the state of the ACM and data link.

**Notes**

None

**Output**

```
dlt-dlk:loc=1201
```

```
rlghncxa03w 04-02-10 11:43:02 EST EAGLE 31.3.0
DLT-DLK: MASP A - COMPLTD
```

```
;
```

**dlt-dstn****Delete Destination**

Use this command to delete destinations from the Destination entity set after the STP no longer routes to those destinations.

**Keyword:** **dlt-dstn**

**Related Commands:** **chg-dstn,, dlt-rte, ent-dstn, ent-rte, rept-stat-dstn, rept-stat-rte, rtrv-dstn, rtrv-rte**

**Command Class:** Database Administration



## Parameters

**NOTE: See "Point Code Formats and Conversion" for a detailed description of point code formats, rules for specification, and examples.**

**:dpc=** (mandatory)

ANSI destination point code with subfields *network indicator-network cluster-network cluster member (ni-nc-ncm)*. The *prefix* subfield indicates a private point code (*prefix-ni-nc-ncm*).

**Synonym: dpca**

**Range: p-, 000-255, \***

Specify a valid value for each subfield of the point code, and separate the subfields with a dash (-).

*prefix*—**p-**

The asterisk value (\*) is not valid for the *ni* subfield.

When **chg-sid:pctype=ansi** is specified, *ni* = **000** is not valid.

When **chg-sid:pctype=ansi** is specified, *nc* = **000** is not valid if *ni* = **001-005**.

When **chg-sid:pctype=ansi** is specified, *nc* = **000** is valid if *ni* = **006-255**.

The point code **000-000-000** is not a valid point code.

**:dpc/dpca/dpci/dpcn/dpcn24=** (mandatory)

Destination point code.

**:dpci=** (mandatory)

ITU international destination point code with subfields *zone-area-id*. The *prefix* subfield indicates a spare point code, private point code, or private and spare point code (*prefix-zone-area-id*).

**Range: s-, p-, ps-, 0-255**

Specify a valid value for each subfield of the point code, and separate the subfields with a dash (-).

*prefix*—**s-, p-, ps-**

*zone*—**0-7**

*area*—**000-255**

*id*—**0-7**

The point code **0-000-0** is not a valid point code.

**:dpcn=** (mandatory)

ITU national destination point code in the format of a 5-digit number (*nnnnn*); or 2, 3, or 4 numbers (members) separated by dashes (*m1-m2-m3-m4*) as defined by the **chg-stpopts:npcfmti** flexible point code option. A group code (*gc*) must be specified when the ITUDUPPC feature is turned on. The *prefix* indicates a spare point code, private point code, or private and spare point code.

**Range: s-, p-, ps-, 0-16383, aa-zz**

Specify a valid value for each subfield of the point code, and separate the subfields with a dash (-).

*prefix*—**s-, p-, ps-**

*nnnnn*—**0-16383**

*gc*—**aa-zz**

*m1-m2-m3-m4*—**0-14** for each member; values must sum to 14

**:dpcn24=** (mandatory)

24-bit ITU national destination point code with subfields *main signaling area-sub signaling area-signaling point (msa-ssa-sp)*. The *prefix* subfield indicates a private point code.

**Range:** **p-, 000-255**  
 Specify a valid value for each subfield of the point code, and separate the subfields with a dash (-).  
*prefix—p-*  
*msa—000-255*  
*ssa—000-255*  
*sp—000-255*

### Example

To delete destination 11-222-111:

```
dlt-dstn:dpc=111-222-111
```

To delete a network destination:

```
dlt-dstn:dpc=21-*-*
```

To delete destination 8112-ge:

```
dlt-dstn:dpcn=8112-ge
```

To delete ITU-N 24-bit destination 13-100-10:

```
dlt-dstn:dpcn24=13-100-10
```

To delete destination spare point code s-8112:

```
dlt-dstn:dpcn=s-8112
```

### Dependencies

The destination address must be either a full point code, a cluster point code, or a network destination point code.

The format of the specified **dpcn** parameter must match the format for ITU national point codes that was assigned with the **chg-stpopts:npcfmti** parameter.

The specified destination point code must already exist in the Destination entity set.

The destination cannot have routes assigned to it.

The specified destination point code cannot already be defined as a remote application internal point code (IPC).

The **dpc** parameter must be defined as a destination point code.

The specified destination point code cannot already be defined as an adjacent point code or a secondary adjacent point code.

The specified destination cannot be referenced by SCCP as a destination point codes in the Mate Application table.

The specified destination cannot be referenced by SCCP as a destination point code in the Mated Relay Node (MRN) table.

If the X.25/SS7 Gateway feature is turned on, any X.25 destinations that reference the specified destination must be removed from the database before the specified destination can be removed from the database.

Network routing is valid only if the Network Routing (NRT) feature is turned on.

When using network routing, if the destination point code has a value of \* in the *nc* subfield, the *ncm* subfield must also be \* (for example, **dpc=21-\*.\***).

A destination point code that is used as a proxy point code cannot be deleted.

**Notes**

In this command, only ITU-international and ITU national point codes support the spare point code subtype prefix (**s-**) and the private and spare point code subtype prefix (**ps-**). All of the point code types support the private (internal) point code subtype prefix (**p-**).

**Output**

The following example shows the display of the destination memory space accounting command completion response with the NCR, NRT, and CRMD features off (disabled) and all Routes and Routesets features off (disabled):

```
dlt-dstn:dpc=111-222-111
rlghncxa03w 04-08-17 15:35:05 EST EAGLE 31.8.0
Destination table is (10 of 2000) 1% full
Alias table is (8 of 12000) 1% full
DLT-DSTN: MASP A - COMPLTD
;
```

The following example shows the display of the destination memory space accounting command completion response with the NCR, NRT, and CRMD features off (disabled) and the DSTN5000 (5000 Routes) feature on:

```
dlt-dstn:dpc=111-222-111
rlghncxa03w 04-08-18 08:29:15 EST EAGLE 31.8.0
Destination table is (10 of 5000) 1% full
Alias table is (8 of 12000) 1% full
DLT-DSTN: MASP A - COMPLTD
;
```

The following example shows the display of the destination memory space accounting command completion response with one or more of the NCR, NRT, or CRMD features on and the DSTN5000 (5000 Routes) feature on:

```
dlt-dstn:dpc=111-222-111
rlghncxa03w 04-08-18 08:29:15 EST EAGLE 31.8.0
DESTINATION ENTRIES ALLOCATED: 5000
FULL DPC(s): 9
NETWORK DPC(s): 0
CLUSTER DPC(s): 1
TOTAL DPC(s): 10
CAPACITY (% FULL): 1%
ALIASES ALLOCATED: 12000
ALIASES USED: 8
CAPACITY (% FULL): 1%
X-LIST ENTRIES ALLOCATED: 500
DLT-DSTN: MASP A - COMPLTD
;
```

The following example shows the display of the destination memory space accounting command completion response with the NCR, NRT, and CRMD features off (disabled) and the 6000 Routesets feature on:

```
dlt-dstn:dpc=111-222-111
rlghncxa03w 04-08-18 08:29:15 EST EAGLE 31.8.0
Destination table is (60 of 6000) 1% full
Alias table is (8 of 12000) 1% full
DLT-DSTN: MASP A - COMPLTD
;
```

The following example shows the display of the destination memory space accounting command completion response with one or more of the NCR, NRT, or CRMD features on and the 6000 Routesets feature on:

```
dlt-dstn:dpc=111-222-111
rlghncxa03w 04-08-18 08:29:15 EST EAGLE 31.8.0
DESTINATION ENTRIES ALLOCATED: 6000
FULL DPC(s): 46
```

```

NETWORK DPC(s):          1
CLUSTER DPC(s):         1
TOTAL DPC(s):           12
CAPACITY (% FULL):      1%
ALIASES ALLOCATED:      12000
ALIASES USED:           8
CAPACITY (% FULL):      1%
X-LIST ENTRIES ALLOCATED: 500
DLT-DSTN: MASP A - COMPLTD
;

```

The following example shows the display of the destination memory space accounting command completion response with the NCR, NRT, and CRMD features off (disabled). When the 7000 Routesets quantity feature is on, the Destination table line shows "...of 7000" as it appears in the example. When the 8000 Routesets quantity feature is on, the Destination table line shows "...of 8000."

```

dlt-dstn:dpc=111-222-111
rlghncxa03w 04-08-18 08:29:15 EST EAGLE 31.8.0
Destination table is (10 of 7000) 1% full
Alias table is (8 of 8000) 1% full
DLT-DSTN: MASP A - COMPLTD
;

```

The following example shows the display of the destination memory space accounting command completion response with one or more of the NCR, NRT, or CRMD features on. When the 8000 Routesets quantity feature is on, the DESTINATION ENTRIES ALLOCATED line shows "8000" as it appears in the example. When the 7000 Routesets quantity feature is on, the DESTINATION ENTRIES ALLOCATED line shows "7000."

```

dlt-dstn:dpc=111-222-111
rlghncxa03w 04-08-18 08:29:15 EST EAGLE 31.8.0
DESTINATION ENTRIES ALLOCATED: 8000
FULL DPC(s):                  46
NETWORK DPC(s):               1
CLUSTER DPC(s):               1
TOTAL DPC(s):                 12
CAPACITY (% FULL):            1%
ALIASES ALLOCATED:            8000
ALIASES USED:                  8
CAPACITY (% FULL):            1%
X-LIST ENTRIES ALLOCATED:     500
DLT-DSTN: MASP A - COMPLTD
;

```

The following example shows the display of the destination memory space accounting command completion response without anyone of the NCR, NRT, or CRMD features on. In this example a proxy destination is being deleted

```

dlt-dstn:dpc=11-11-11
tekelecstp 07-03-07 16:34:32 EST EAGLE 37.5.0
Destination table is (11 of 2000) 1% full
Alias table is (0 of 12000) 0% full
PPC table is (1 of 10) 10% full
DLT-DSTN: MASP A - COMPLTD
;

```

## dlt-e1

### Delete E1 Interface

Use this command to delete an interface for a 2-port E1 card, an E1/T1 MIM, HC-MIM, or E5-E1T1 card used as an E1 card, or an HC-MIM or E5-E1T1 card used as an SE-HSL card.

**NOTE:** On an HC-MIM or E5-E1T1 card, E1 ports 1, 3, 5, and 7 (master ports) can be independently channel bridged with their adjacent even-numbered (slave) ports 2, 4, 6, and 8 to allow non-signaling data pass-through. The slave port interface is automatically deleted with the command that deletes its master port interface.

**Keyword:** dlt-e1

**Related Commands:** chg-e1, ent-e1, rtrv-e1, tst-e1

**Command Class:** Database Administration

### Parameters

**:e1port=** (mandatory)

E1 port number. The value must be an E1 port that has already been configured on the specified E1 card.

**Range:** 1-8

Ports 3 - 8 can be specified only for HC MIM cards and E5-E1T1 cards.

**:loc=** (mandatory)

The card location as stenciled on the shelf of the system.

**Range:** 1101-1108, 1111-1112, 1201-1208, 1211-1218, 1301-1308, 1311-1318, 2101-2108, 2111-2118, 2201-2208, 2211-2218, 2301-2308, 2311-2318, 3101-3108, 3111-3118, 3201-3208, 3211-3218, 3301-3308, 3311-3318, 4101-4108, 4111-4118, 4201-4208, 4211-4218, 4301-4308, 4311-4318, 5101-5108, 5111-5118, 5201-5208, 5211-5218, 5301-5308, 5311-5318, 6101-6108, 6111-6118

### Example

```
dlt-e1:loc=1205:e1port=1
```

```
dlt-e1:loc=1205:e1port=2
```

### Dependencies

The specified card location (**loc** parameter) must be equipped.

The card in the specified card location (**loc** parameter) must be a **lime1** card type.

The port specified by the **e1port** parameter must be already equipped with an E1 interface.

All signaling links providing timeslots serviced by the specified E1 interface must be deleted before the E1 interface can be deleted. See the **dlt-slk** command to delete the signaling links providing the timeslots.

A channel bridged slave (even-numbered) port on an HC-MIM card or an E5-E1T1 card cannot be specified in the **e1port** parameter. To delete channel bridged port interfaces, specify the master (odd-numbered) port in the **e1port** parameter. The slave port interface is automatically deleted when its master port interface is deleted.

### Notes

None.

### Output

```
dlt-e1:loc=1205:e1port=1
```

```
rlghncxa03w 04-02-20 09:07:58 EST EAGLE 31.3.0
dlt-e1: MASP A - COMPLTD
```

```
;
```

**dlt-frm-pwr****dlt-frm-pwr**

Use this command to delete the existing power threshold entry from the Frame Power Threshold table for the specified frame. After the power threshold value is deleted, the default power threshold value of 30 Amps is assumed for the specified frame.

**Keyword:** **dlt-frm-pwr**

**Related Commands:** **chg-frm-pwr, ent-frm-pwr, rtrv-frm-pwr, rtrv-stp**

**Command Class:** Database Administration

**Parameters**

**:frm=** (mandatory)

Frame ID

**Range:** **cf00, ef00, ef01, ef02, ef03, ef04**

**cf00**— Control frame

**ef00**— First extension frame

**ef01**— Second extension frame

**ef02**— Third extension frame

**ef03**— Fourth extension frame

**ef04**— Fifth extension frame

**Example**

Delete the frame power threshold value for the third extension frame.

```
dlt-frm-pwr :frm=ef02
```

**Dependencies**

A power threshold value must already be provisioned for the specified frame.

**Output**

```
dlt-frm-pwr :frm=ef02
```

```
tekelecstp 06-04-11 16:07:11 EST EAGLE 35.0.0
```

```
FRAME POWER THRESHOLD table is (3 of 10) 30% full
```

```
DLT-FRM-PWR: MASP A - COMPLTD
```

```
;
```

**dlt-fta****Delete Entry from the File Transfer Area**

This command removes a file from the file transfer area (FTA).

**Keyword:** **dlt-fta**

**Related Commands:** **act-file-trns, copy-fta, disp-disk-dir**

**Command Class:** System Maintenance

**Parameters**

**NOTE:** At least one of these parameters but not both, must be specified: **all, file**.

**:all=** (optional)

This parameter allows all files to be removed from the FTA.

**Range:** **yes, no**

**Default:** **no**

**:file=** (optional)

The name of the file to be removed.

**Range:**            ////////////////////  
The name of the file with its extension.  
**Default:**        No filename is specified.

**:force=** (optional)

This parameter is required to delete the last file in the FTA. In such cases, the value must be set to **force=yes**.

**Range:**        **yes, no**  
**Default:**     **no**

**:loc=** (optional)

The card location of the fixed disk containing the FTA.

**Range:**        **1114, 1116**  
(TDM)

**Default:**     The location of the active TDM

### Example

```
dlt-fta:loc=1114:file="CAM.ELF"
dlt-fta:loc=1114:file="CAM.ELF":force=yes
dlt-fta:loc=1116:all=yes
```

### Dependencies

Removing an individual file only frees up that file name for another transfer of that file.

The **all=yes** parameter must be specified when a specific filename is not supplied.

The **all=yes** parameter not only removes all files from the FTA, but frees up the space in the FTA.

When using DOS file names, if the file name contains a special character such as an underscore (\_) or begins with a numeric, the file name must be in quotes (" "), for example, "92\_name.ext".

Removing an individual file only frees up that file name for another transfer of that file.

The **force=yes** parameter must be specified to remove the last file in the FTA.

The **loc** parameter must specify a TDM card.

A specific filename and **all=yes** may not be specified at the same time.

Only one file transfer can be active at a time.

TDM and E5-TDM cards cannot be installed in the same system.

### Notes

None

### Output

```
dlt-fta:file=oam.elf:loc=1114
rlghncxa03w 04-02-05 15:31:59 EST EAGLE 31.3.0
File OAM.ELF deleted from File Transfer Area on fixed disk 1114.
;
dlt-fta:all=yes:loc=116
rlghncxa03w 04-02-05 15:33:32 EST EAGLE 31.3.0
All files deleted from File Transfer Area on fixed disk 1116.
;
```

## dlt-ftp-serv

### Delete FTP Server Entry

Use this command to delete an entry for an FTP server from the FTP Server table.



**Keyword:** dlt-ftp-serv

**Related Commands:** chg-ftp-serv, ent-ftp-serv, rtrv-ftp-serv

**Command Class:** Database Administration

### Parameters

**:app=** (mandatory)

Application. This parameter specifies the FTP Client application at the EAGLE 5 ISS STP that interfaces with the FTP Server.

**Range:** meas, user, db, dist

**meas** — Measurements Platform application

**user** — FTP-based Table Retrieve Application (FTRA)

**db** — Database Backup/Restore application

**dist** — EAGLE 5 ISS Software Release distribution application

**:ipaddr=** (mandatory)

IP Address of the FTP Server.

**Range:** 4 numbers separated by dots, with each number in the range of 0-255.

### Example

```
dlt-ftp-serv:app=meas:ipaddr=1.255.0.102
```

### Dependencies

Both the **app** and **ipaddr** parameters must be entered in the command to delete an FTP server.

An entry must already exist in the FTP Server table for this application at the specified IP address.

The **app** parameter must specify an application that uses the FTP Support feature.

The **ipaddr** parameter must specify a valid IP address for the FTP server.

### Notes

None

### Output

```
dlt-ftp-serv:app=meas:ipaddr=1.255.0.102
```

```
rlghncxa03w 04-02-20 09:07:58 EST EAGLE 31.3.0
FTP SERV table is (1 of 10) 10% full
DLT-FTP-SERV: MASP A - COMPLTD
```

```
;
```

```
dlt-ftp-serv:app=user:ipaddr=1.255.0.102
```

```
rlghncxa03w 04-02-20 09:07:58 EST EAGLE 31.3.0
FTP SERV table is (0 of 10) 0% full
DLT-FTP-SERV: MASP A - COMPLTD
```

```
;
```

## dlt-gserv-data

### Delete G-Port SRI Query for Prepaid Service Data

Use this command to delete translation type, originating point code, or global title address data from the GSERV table. These values are used to determine whether a Send Routing Information (SRI) request should receive G-Port SRI Query for Prepaid Service or normal G-Port SRI service.

**Keyword:** dlt-gserv-data

**Related Commands:** ent-gserv-data, rtrv-gserv-data

**Command Class:** Database Administration

## Parameters

**NOTE: See "Point Code Formats and Conversion" for a detailed description of point code formats, rules for specification, and examples.**

**:gta=** (optional)

Global title address. Use this parameter to specify a calling party (CgPA) global title address.

**Range:** 1-21 digits

**:opc=** (optional)

ANSI originating point code with subfields *network indicator-network cluster-network cluster member (ni-nc-ncm)*.

**Synonym:** opca

**Range:** p-, 000-255

Specify a valid value for each subfield of the point code, and separate the subfields with a dash (-).

*prefix*—p-

When **chg-sid:pctype=ansi** is specified, *ni = 000* is not valid.

When **chg-sid:pctype=ansi** is specified, *nc = 000* is not valid if *ni = 001-005*.

When **chg-sid:pctype=ansi** is specified, *nc = 000* is valid if *ni = 006-255*.

The point code **000-000-000** is not a valid point code.

**:opc/opca/opci/opcn/opcn24=** (optional)

Originating point code. Use these parameters to specify message transfer part (MTP) originating point codes.

**:opci=** (optional)

ITU international originating point code with subfields *zone-area-id*.

**Range:** s-, p-, ps-, 0-255

Specify a valid value for each subfield of the point code, and separate the subfields with a dash (-).

*prefix*—s-, p-, ps-

*zone*—0-7

*area*—000-255

*id*—0-7

The point code **0-000-0** is not a valid point code.

**:open=** (optional)

ITU national originating point code in the format of a 5-digit number (*nnnnn*); or 2, 3, or 4 numbers (members) separated by dashes (*m1-m2-m3-m4*) as defined by the **chg-stpopts:npcfnti** flexible point code option. A group code must be specified when the ITUDUPPC feature is turned on (*nnnnn-gc, m1-m2-m3-m4-gc*).

**Range:** s-, p-, ps-, 0-16383, aa-zz

Specify a valid value for each subfield of the point code, and separate the subfields with a dash (-).

*prefix*—s-, p-, ps-

*nnnnn*—0-16383

*gc*—aa-zz

*m1-m2-m3-m4*—0-14 for each member; values must sum to 14

**:opc24=** (optional)

24-bit ITU national originating point code with subfields *main signaling area-sub signaling area-signaling point (msa-ssa-sp)*.

**Range:** **p-, 000-255**

Specify a valid value for each subfield of the point code, and separate the subfields with a dash (-).

*prefix*—**p-**

*msa*—**000-255**

*ssa*—**000-255**

*sp*—**000-255**

**:tt=** (optional)

Translation type. Use this parameter to specify a called party (CdPA) translation type.

**Range:** **0-255**

### Example

```
dlt-gserv-data:tt=26
```

```
dlt-gserv-data:opc=1-1-1
```

```
dlt-gserv-data:gta=9194605500
```

### Dependencies

The specified translation type (**tt** parameter), originating point code (**opc/opca/opci/opcn/opcn24** parameter), or global title address (**gta** parameter) must exist in the GSERV table before this command can be entered.

The G-Port SRI Query for Prepaid feature must be enabled before this command can be entered.

The **tt**, **opc**, and **gta** parameters cannot be specified within the same command.

The G-Port feature must be enabled before this command can be entered.

### Output

```
dlt-gserv-data:tt=26
```

```
mystp 06-07-20 09:04:21 EST EAGLE 35.2.0
```

```
DLT-GSERV-DATA: MASP A - CMLTLD
```

```
;
```

## dlt-gsmmap-scrn

### Delete GSM MAP Screening Entry

Use this command to delete the GSM Map Screening CgPA and CdPA entries that are used to filter out or allow SCCP messages containing Map Op-Codes, CGPA GTA+NPV+NAIV, CDPA GTA+NPV+NAIV, and forbidden parameters.

**Keyword:** **dlt-gsmmap-scrn**

**Related Commands:** **chg-gsmmap-scrn, ent-gsmmap-scrn, rtrv-gsmmap-scrn**

**Command Class:** Database Administration

### Parameters

**:cgsr=** (mandatory)

CgPA Screening Reference.

**Range:** *ayyy*

1 alphabetic character followed by up to 3 optional alphanumeric characters

**:opname=** (mandatory)

The user-defined name for the operation code. The **opname** value references the operation code (**opcode**) defined with the **ent-gsms-opcode** command.

**Range:** *ayyyyyyy*  
Up to 8 alphanumeric characters

**:cdsr=** (optional)

CdPA Screening Reference.

**Range:** *ayyy*  
1 alphabetic character followed by up to 3 optional alphanumeric characters

### Example

```
dlt-gsmmap-scrn:opname=xyz:cgsr=fela:cdsr=fall
```

```
dlt-gsmmap-scrn:opname=xyz:cgsr=fela
```

### Dependencies

The GSM Map Screening feature (see the **enable-ctrl-feat** command) must be enabled before this command can be entered.

The Enhanced GSM Map Screening (EGMS) feature must be enabled before the **cdsr** parameter can be specified.

The specified **cgsr** parameter value must exist in the database.

The specified **cdsr** parameter value must exist in the database.

A **cgpa** entry cannot be deleted if it is referred to by **cdpa** entries.

The specified **opname** parameter value must exist in the GSM Map Op-Code table.

### Notes

Unlike GTT (Global Title Translation) entries, the GSM MAP screening commands do not support splits of ranges during deletion or changes of entries.

### Output

```
dlt-gsmmap-scrn:opname=xyz:cgsr=fela:cdsr=fall
rlghncxa03w 04-02-29 08:51:12 EST EAGLE 31.4.0
GSM Map Screening table is (1 of 4000) 1% full
DLT-GSM MAP-SCRN: MASP A - COMPLTD
;
```

## dlt-gsms-opcode

## Delete GSM MAP Screening Operation Code

Use this command to delete GSM (Global System for Mobile Telecommunication) MAP (Mobile Application Part) screening operation codes and the default screening action for that operation code.

**Keyword:** **dlt-gsms-opcode**

**Related Commands:** **chg-gsms-opcode**, **ent-gsms-opcode**, **rtrv-gsms-opcode**

**Command Class:** Database Administration

### Parameters

**:opname=** (mandatory)

The user-defined name for the operation code. The **opname** value is defined with the **ent-gsms-opcode** command.

**Range:** *ayyyyyyy*  
Up to 8 alphanumeric characters

**Example**

```
dlt-gsms-opcode:opname=ati
```

**Dependencies**

The reserved word **none** cannot be specified as a value for the **opname** parameter.

The value specified for the **opname** parameter must exist in the GSM MAP Op-Code table.

The **opname** value being deleted cannot be referenced in the GSM MAP Screening table.

The GSM Map Screening feature must be enabled (see the **enable-ctrl-feat** command) before this command can be entered.

**Notes**

None

**Output**

```
dlt-gsms-opcode:opname=ati
rlghncxa03w 06-02-29 08:50:12 EST EAGLE 35.0.0
DLT-GSMS-OPCODE: MASP A - COMPLTD
;
```

**dlt-gsmssn-scrn****Delete GSM Subsystem Number Screening Entry**

Use this command to delete an SSN (subsystem number) from the GSM (Global System for Mobile Telecommunication) SSN screening table.

**Keyword:** **dlt-gsmssn-scrn**

**Related Commands:** **ent-gsmssn-scrn, rtrv-gsmssn-scrn**

**Command Class:** Database Administration

**Parameters**

**:ssn=** (mandatory)

Subsystem number.

**Range:** **000-255**

**:type=** (mandatory)

Subsystem type.

**Range:** **orig, dest**

**orig**— The origination SSN

**dest**— The destination SSN

**Example**

This example deletes a destination subsystem of 255 from the GSM SSN screening table:

```
dlt-gsmssn-scrn:ssn=255:type=dest
```

**Dependencies**

The GSM Map Screening feature must be enabled (see the **enable-ctrl-feat** command) before this command can be entered.

A value for the **ssn/type** parameter combination must be specified that exists in the GSM SSN screening table.

**Notes**

None

**Output**

```
dlt-gsmssn-scrn:ssn=255:type=dest

rlghncxa03w 04-02-20 09:04:21 EST EAGLE 31.3.0
DLT-GSMSSN-SCRN: MASP A - COMPLTD
;
```

**dlt-gta****Delete Global Title Address Information**

Use this command to delete the GTA (global title address) information applicable to a global title selector combination.

This command deletes the routing of SCCP messages for specified global title addresses from designated destinations and their subsystem numbers.

**Keyword:** dlt-gta

**Related Commands:** chg-gta, ent-gta, rtrv-gta

**Command Class:** Database Administration

**Parameters**

**NOTE: The TCAP Opcode based Routing (TOBR) feature must be turned on before the cdssn or ecdsn parameter can be specified. A TOBR quantity feature must be turned on before the acn, family, opcode, or pkgtype parameter can be specified.**

**:gttsn=** (mandatory)

GTT set name. A GTT set is an entity to which global title addresses and selectors are assigned.

**Range:** ayyyyyyyy

1 leading alphabetic and up to 8 following alphanumeric characters.

**:acn=** (optional)

Application context name. This parameter specifies the ITU TCAP *acn* field in the incoming MSU.

**Range:** 0-255 \*, none

The **acn** parameter supports up to 7 subfields separated by a dash (e.g.

*1-202-33-104-54-26-007*).

\*—any valid value in the ITU TCAP *acn* field in the incoming MSU

**none**—there is no value in the ITU TCAP *acn* field in the incoming MSU

**:cdssn=** (optional)

Starting CdPA subsystem number.

**Range:** 0-255

**:cgpc=** (optional)

ANSI CgPA point code with subfields *network indicator-network cluster-network cluster member (ni-nc-ncm)*.

**Synonym:** cgpa

**Range:** 000-255, \*

Specify a valid value for each subfield of the point code, and separate the subfields with a dash (-).

The asterisk (\*) value is not valid for the *ni* subfield.

When **chg-sid:pctype=ansi** is specified, *ni* = **000** is not valid.

When **chg-sid:pctype=ansi** is specified, *nc* = **000** is not valid if *ni* = **001-005**.

When **chg-sid:pctype=ansi** is specified, *nc* = **000** is valid if *ni* = **006-255**.

When **chg-sid:pctype=ansi** is specified, *ni*-\*-\* is valid if *ni* = **006-255**.

The point code **000-000-000** is not a valid point code.

**:cgpci=** (optional)

ITU international CgPA point code with subfields *zone-area-id*. The *prefix* subfield indicates a spare point code (*prefix-zone-area-id*).

**Range:** s-, 0-255

Specify a valid value for each subfield of the point code, and separate the subfields with a dash (-).

*prefix*—s-

*zone*—0-7

*area*—000-255

*id*—0-7

The point code **0-000-0** is not a valid point code.

**:cgpcn=** (optional)

ITU national CgPA point code in the format of a 5-digit number (*nnnnn*); or 2, 3, or 4 numbers (members) separated by dashes (*m1-m2-m3-m4*) as defined by the **chg-stpopts:npfnti** flexible point code option. A group code must be specified when the ITUDUPPC feature is turned on (*nnnnn-gc*, *m1-m2-m3-m4-gc*). The *prefix* subfield indicates a spare point code (*prefix-nnnnn*, *prefix-nnnnn-gc*, *prefix-m1-m2-m3-m4*, *prefix-m1-m2-m3-m4-gc*).

**Range:** s-, 0-16383, aa-zz

Specify a valid value for each subfield of the point code, and separate the subfields with a dash (-).

*prefix*—s-

*nnnnn*—0-16383

*gc*—aa-zz

*m1-m2-m3-m4*—0-14 for each member; values must sum to 14

**:cgpcn24=** (optional)

24-bit ITU national CgPA point code with subfields main signaling *area-sub signaling area-signaling point* (*msa-ssa-sp*).

**Range:** 000-255

Specify a valid value for each subfield of the point code, and separate the subfields with a dash (-).

*msa*—000-255

*ssa*—000-255

*sp*—000-255

**:cgssn=** (optional)

Starting CgPA subsystem number.

**Range:** 0-255

**:ecdssn=** (optional)

Ending CdPA subsystem number.

**Range:** 0-255

**:ecgssn=** (optional)

Ending CgPA subsystem number.

**Range:** 0-255

**:egta=** (optional)

End global title address. This parameter specifies the end of a range of global title digits.

**Range:** 1-21 digits  
 If the Hex Digit Support for GTT feature is not enabled and on, the range is 1 - 21 decimal digits; valid digits are **0-9**.  
 If the Hex Digit Support for GTT feature is enabled and on, the range is 1 - 21 hexadecimal digits; valid digits are **0-9, a-f, A-F**.

**Default:** Same as the specified **gta** value

**:family=** (optional)

This parameter specifies the ANSI TCAP *family* field in the incoming MSU.

**Range:** **0-255** \*, **none**  
 \*—any valid value in the ANSI TCAP *family* field in the incoming MSU  
**none**—there is no value in the ANSI TCAP *family* field in the incoming MSU

**:gta=** (optional)

Global title address. This parameter specifies the beginning of a range of global title digits.

**Range:** 1-21 digits  
 If the Hex Digit Support for GTT feature is not enabled and on, the range is 1 - 21 decimal digits; valid digits are **0-9**.  
 If the Hex Digit Support for GTT feature is enabled and on, the range is 1 - 21 hexadecimal digits; valid digits are **0-9, a-f, A-F**.

**:opc=** (optional)

ANSI originating point code with subfields *network indicator-network cluster-network cluster member* (*ni-nc-ncm*).

**Synonym:** **opca**

**Range:** **000-255**, \*  
 Specify a valid value for each subfield of the point code, and separate the subfields with a dash (-).  
 The asterisk (\*) value is not valid for the *ni* subfield.  
 When **chg-sid:pctype=ansi** is specified, *ni* = **000** is not valid.  
 When **chg-sid:pctype=ansi** is specified, *nc* = **000** is not valid if *ni* = **001-005**.  
 When **chg-sid:pctype=ansi** is specified, *nc* = **000** is valid if *ni* = **006-255**.  
 When **chg-sid:pctype=ansi** is specified, *ni*-\*-\* is valid if *ni* = **006-255**.  
 The point code **000-000-000** is not a valid point code.

**:opci=** (optional)

ITU international originating point code with subfields *zone-area-id*. The *prefix* subfield indicates a spare point code (*prefix-zone-area-id*).

**Range:** **s-, 0-255**  
 Specify a valid value for each subfield of the point code, and separate the subfields with a dash (-).  
*prefix*—**s-**  
*zone*—**0-7**  
*area*—**000-255**  
*id*—**0-7**  
 The point code **0-000-0** is not a valid point code.

**:opcn=** (optional)

ITU national originating point code in the format of a 5-digit number (*nnnnn*); or 2, 3, or 4 numbers (members) separated by dashes (*m1-m2-m3-m4*) as defined by the **chg-stpopts:npfnti** flexible point code option. A group code must be specified when the ITUDUPPC feature is turned on (*nnnnn-*



*gc, m1-m2-m3-m4-gc*). The *prefix* subfield indicates a spare point code (*prefix-nnnnn*, *prefix-nnnnn-gc*, *prefix-m1-m2-m3-m4*, *prefix-m1-m2-m3-m4-gc*).

**Range:** **s-, 0-16383, aa-zz**

Specify a valid value for each subfield of the point code, and separate the subfields with a dash (-).

*prefix*—s-

*nnnnn*—**0-16383**

*gc*—**aa-zz**

*m1-m2-m3-m4*—**0-14** for each member; values must sum to 14

**:opc24=** (optional)

24-bit ITU national originating point code with subfields *main signaling area-sub signaling area-signaling point* (*msa-ssa-sp*).

**Range:** **000-255**

Specify a valid value for each subfield of the point code, and separate the subfields with a dash (-).

*msa*—**000-255**

*ssa*—**000-255**

*sp*—**000-255**

**:opcode=** (optional)

This parameter specifies the TCAP *opcode* field in the incoming MSU.

**Range:** **0-255** \*, **none**

\*—any valid value in the TCAP *opcode* field in the incoming MSU

**none**—there is no value in the TCAP *opcode* field in the incoming MSU

**:pkgtype=** (optional)

Package type. This parameter specifies the ANSI TCAP and ITU TCAP package type.

**Range:** **ansiuni, qwp, qwop, cwp, cwop, any, bgn, cnt, ansiabort, end, ituabort, ituuni, resp**

**ansiuni**—ANSI unidirectional

**qwp**—Query with Permission

**qwop**—Query without Permission

**cwp**—Conversation with Permission

**cwop**—Conversation without Permission

**any**—Wildcard value

**bgn**—Begin

**cnt**—Continue

**ansiabort**—ANSI abort

**end**—End

**ituabort**—ITU abort

**ituuni**—ITU unidirectional

**resp**—Response

ANSI TCAP PKGTYPE—**ansiuni, qwp, qwop, resp, cwp, cwop, ansiabort, any**

ITU TCAP PKGTYPE—**bgn, ituabort, ituuni, any, cnt**

## Example

dlt-

gta:gttsn=setcdgta:gta=123456789012345678901:egta=223456789012345678901

dlt-gta:gttsn=t800:gta=919461:egta=919468

```
dlt-
gta:gttsn=setcggt:gta=323456789012345678901:egta=423456789012345
678901
```

```
dlt-gta:gttsn=setcgpc:cgpca=001-001-001
```

```
dlt-gta:gttsn=setopc:opca=002-001-001
```

```
dlt-gta:gttsn=setcgssn:cgssn=100:ecgssn=200
```

The following example specifies hexadecimal digits for the gta and egta parameters.

```
dlt-gta:gttsn=set1:gta=abcd:egta=abce
```

The following example specifies the GTA translations when the TOBR feature is turned on.

```
dlt-gta:gttsn=setcdssn:cdssn=100:ecdssn=150
```

## Dependencies

The EGTT feature must be turned on before this command can be entered.

The **gttsn** parameter must be specified, may not have a value of **none**, and must match an existing **gttsn**.

The length of the specified **gta** parameter must match the number of digits provisioned for the specified GTT set when the VGTT feature is turned off. If the VGTT feature is turned on, then up to 10 GTA lengths can exist per GTT set. If the Support for 16 GTT Lengths in VGTT feature is turned on, then up to 16 GTA lengths can exist per GTT set.

The specified **gta/egta** range must exist for the specified GTT set in the STP active database. While an exact match is not required, you cannot specify an overlap with another range. If the range overlaps, an error is generated that displays a list of overlapped global title addresses. An example follows that shows what happens when the user attempts to enter a global title address range (such as 8005550000 to 8005559999) that overlaps an existing range. The overlapping links must match. If they do not, the error message displays the list of overlapped global title addresses:

The following GTA ranges overlap the input GTA range

```
START GTA          END GTA
8005550000         8005551999
8005552000         8005553999
8005554000         8005555999
DLT-GTA: MASP A - Command Aborted
```

If the **egta** parameter is specified, the **gta** and **egta** value must be the same length and the **egta** value must be greater than the **gta** value.

The GTT table cannot be full in case a delete command causes a split requiring more entries to be added.

The **cgpc/cgpca/cgpci/cgpcn/cgpcn24**, **opc/opca/opci/opcn/opcn24**, **cgssn**, **gta**, **cdssn**, **opcode/acn/pkgtype**, or **opcode/family/pkgtype** parameter must be specified.

If specified, the **ecgssn/ecdssn** parameter must be greater than the **cgssn/cdssn** parameter.

The Origin-based SCCP Routing feature must be enabled when specifying the **cgpc/cgpca/cgpci/cgpcn/cgpcn24**, **opc/opca/opci/opcn/opcn24**, or **(e)cgssn** parameters.

The **gta** parameter must be specified if the GTTSN set type has a value of **cdgta** or **cggta**, and cannot be specified for other set types.

The **cgpc/cgpca/cgpci/cgpcn/cgpcn24** parameter must be specified if the GTTSN set type has a value of **cgpc**, and cannot be specified for other set types.

The **opc/opca/opci/opcn/opcn24** parameter must be specified if the GTTSN set type has a value of **opc**, and cannot be specified for other set types.

The **cgssn** parameter must be specified if the GTTSN set type has a value of **cgssn**, and cannot be specified for other set types.

If the specified GTT Set is an ANSI set, the **cgpc/cgpc** and **opc/opca** parameters must be valid ANSI point codes. If the specified GTT Set is an ITU set, the **cgpci/cgpcn/cgpcn24** and **opci/opcn/opcn24** parameters must be valid ITU point codes.

The range specified by the **cgssn/ecgssn** and **cdssn/ecdssn** parameters must exist for the specified GTT set.

The point code specified by the **cgpc** or **opc** parameter must exist.

The range specified by the **cgssn/ecgssn** and **cdssn/ecdssn** parameters cannot overlap an existing range for the specified GTT set.

The **cgpc**, **cgssn**, **gta**, **opc**, **cdssn**, and **opcode** parameters cannot be specified together in the command.

The Hex Digit Support for GTT feature must be enabled and on before hexadecimal digits can be specified for the **gta** or **egta** parameters.

If the specified GTT set has a set type of **opcode** (see the **ent-gttset** command), then the **opcode/acn/pkgtype** or **opcode/family/pkgtype** parameters must be specified. These parameters cannot be specified for GTT sets with other set types.

If the specified GTT set has a set type of **cdssn** (see the **ent-gttset** command), then the **cdssn** parameter must be specified. The **cdssn** parameter cannot be specified for GTT sets with other set types.

The TOBR feature must be turned on before the **cdssn** or **ecdssn** parameter can be specified.

The value specified for the **gttsn** parameter must match the name of an existing GTT Set.

A TOBR quantity feature must be turned on before the **opcode**, **pkgtype**, **acn**, or **family** parameter can be specified.

The **opcode**, **pkgtype**, and **family** parameters must be specified together for ANSI TCAP translations. The **opcode**, **pkgtype**, and **acn** parameters must be specified together for ITU TCAP translations.

- The **acn** and **family** parameters cannot be specified together in the command.
- If the **cgssn** parameter is specified, then the **cdssn/ecdssn** parameters cannot be specified.
- If the **cdssn** parameter is specified, the **cgssn/ecgssn** parameters cannot be specified.
- If the **opcode** parameter is specified, then the **(e)gta/(e)cgssn/(e)cdssn** parameters cannot be specified.

If the **family** parameter is specified, then the **pkgtype** parameter must have a value of **ansiuni**, **qwop**, **qwop**, **resp**, **cwp**, **cwop**, **ansiabort** or **any**.

If the **acn** parameter is specified, then the **pkgtype** parameter must have a value of **bgn**, **ituabort**, **ituuni**, **any**, **end**, or **cnt**.

If the **pkgtype=ituabort** parameter is specified, then a value of **none** must be specified for the **acn** and **opcode** parameters. If the **pkgtype=ansiabort** parameter is specified, then a value of **none** must be specified for the **family** and **opcode** parameters.

## Notes

When the EGTT feature is turned on, the GTT Selector (**ent/chg/dlt/rtrv-gttset**), GTT Set (**ent/dlt/rtrv-gttset**), and GTA (**ent/chg/dlt/rtrv-gta**) commands replace the Translation Type (**ent/dlt/rtrv-tt**) and Global Title Translation (**ent/chg/dlt/rtrv-gtt**) commands. All data previously provisioned with these commands is maintained.

If a GTT is being deleted or changed and the point code (**dpc** or **rte**) is not found in the route table (unless the point code is the STP's true point code), the following message is displayed in the terminal scroll area:

```
NOTICE: No DPC and/or RTE found for GTT being deleted or changed.
```

The above situation may occur for the following reasons:

A database was upgraded from a release prior to EAGLE 5 ISS Release 27.1 or IP<sup>7</sup> Secure Gateway Release 3.0 when GTT entries were not linked to the route table and the deletion of the **dpc** was permitted. The GTT referenced a **dpc/rte** that was deleted, and the enforce reference counts between the GTT and route tables were not updated.

- A serious problem occurred in which the reference count rules were not enforced and a **dpc** and/or **rte** were deleted while being referenced by a GTT entry. This indicates a software error; notify the Customer Care Center at (888) FOR-TKLC.

## Output

The following example specifies GTA translations when the TOBR feature is turned on.

```
dlt-gta:gttsn=setcdssn:cdssn=100
  rlgncxa03w 09-03-10 09:04:21 EST EAGLE 41.0.0
  DLT-GTA: MASP A - CMLPTD
;
```

## dlt-gtcnv

## Delete Global Title Conversion

Use this command to delete entries from the Default Global Title Conversion table. The particular entry to be deleted is identified by the direction in conjunction with the TTA or TTI, or with the TTI, NP, and NAI.

**Keyword:** **dlt-gtcnv**

**Related Commands:** **chg-gtcnv**, **ent-gtcnv**, **rtrv-gtcnv**

**Command Class:** Database Administration

## Parameters

**:dir=** (mandatory)

Direction of conversion.

**Range:** **atoi**, **itoa**, **both**

**atoi**— ANSI to ITU conversion

**itoa**— ITU to ANSI conversion

**both**— Conversion in both directions

**:nai=** (optional)

Nature of Address Indicator. This parameter is mandatory when **gtixlat=24** is specified, and cannot be specified when **gtixlat=22** is specified.

**Range:** **0-63** \*

**Default:** No change to current value

**:np=** (optional)

Numbering Plan. This parameter is mandatory when **gtixlat=24** is specified, and cannot be specified when **gtixlat=22** is specified.

**Range:** **0-15** \*

**Default:** No change to current value

**:tta=** (optional)

ANSI translation type. This parameter is mandatory when **dir=atoi** or **dir=both** is specified.

**Range:** **0-255** \*

**Default:** No change to current value

**:tti=** (optional)

ITU translation type. This parameter is required when **dir=atoi** is specified.

**Range:** 0-255 \*

**Default:** No change to current value

### Example

The following example deletes an ANSI-to-ITU entry using the TTA of 10 to identify the entry.

```
dlt-gtcnv:dir=atoi:tta=10
```

The following example deletes an ANSI-to-ITU entry using the TTA of 11 to identify the entry.

```
dlt-gtcnv:dir=atoi:tta=11
```

The following example deletes a ITU-to-ANSI entry using the TTI of 7, NAI of 8, and NP of 6 to identify the entry.

```
dlt-gtcnv:dir=ittoa:tti=7:nai=8:np=6
```

The following example deletes a BOTH (ANSI <-> ITU) entry using the TTI of 9 and TTA of 12 to identify the entry.

```
dlt-gtcnv:dir=both:tta=12:tti=9
```

The following example deletes a BOTH (ANSI <-> ITU) entry using the TTI of 7, NAI of 6, NP of 4, and TTA of 12 to identify the entry.

```
dlt-gtcnv:dir=both:tta=12:tti=7:np=4:nai=6
```

The following example deletes an ANSI-to-ITU default entry using the TTA of \* to identify the entry.

```
dlt-gtcnv:dir=atoi:tta=*
```

The following example deletes an ITU-to-ANSI default entry using the TTI of \*, NAI of \* and NP of \* to identify the entry.

```
dlt-gtcnv:dir=ittoa:tti=:nai=:np=*
```

### Dependencies

The ANSI-ITU-China SCCP Conversion feature must be enabled before this command can be entered.

The entry that is to be deleted must exist in the database.

When **dir=atoi** is specified, the **tta** parameter must be specified.

When **dir=atoi** is specified, the **tta** parameter must be specified.

When **dir=atoi** is specified, **tta**, **nai**, and **np** parameters cannot be specified.

When **dir=ittoa** is specified, the **tta=\*** parameter must be specified.

When **dir=ittoa** is specified, **nai** and **np** parameter values must be \* if specified.

When **dir=both** is specified, at least the **tta** and **tta** parameters must be specified.

When **dir=both** is specified, asterisk values for other parameters cannot be specified.

If specified, the **nai** and **np** parameters must be specified together in the command.

When **gtixlat=22** and **dir=ittoa** are specified, asterisk entries cannot be specified. Specify **gtixlat=24** when **dir=ittoa** is specified and asterisk entries are specified.

### Notes

To delete an ANSI-to-ITU entry, specify the direction (**dir**) and the TTA.

To delete an ITU-to-ANSI entry with a **gtixlat** of **22**, specify the direction (**dir**) and the TTI.

To delete an ITU-to-ANSI entry with a **gtixlat** of **24**, specify the direction (**dir**), TTI, NAI and NP.

To delete a BOTH (ANSI <-> ITU) entry with a **gtixlat** of **22**, specify the direction (**dir**), TTA and TTI.

To delete a BOTH (ANSI <-> ITU) entry with a **gtixlat** of **24**, specify the direction (**dir**), TTA, TTI, NP and NAI.

## Output

```
dlt-gtcnv:dir=both:tta=12:tti=9
r1ghncxa03w 03-03-18 08:50:12 EST EAGLE 31.3.0
DLT-GTCNV: MASP A - COMPLTD
;
```

## dlt-gtt

### Delete Global Title Translation

Use this command to remove the routing of messages for specified global title addresses from designated destinations and their subsystem numbers.

If the EGTT (Enhanced Global Title Translation) feature is turned on, the system will no longer accept GTT (Global Title Translation) and TT (Translation Type) commands. Refer to the new command sets that replace the GTT and TT commands:

- GTT Selector commands (**ent/chg/dlt/rtrv-gttsel**)
- GTT Set commands (**ent/dlt/rtrv-gttset**)
- GTA commands (**ent/chg/dlt/rtrv-gta**).

**Keyword:** **dlt-gtt**

**Related Commands:** **chg-gtt, ent-gtt, rtrv-gtt**

**Command Class:** Database Administration

## Parameters

At least one of these optional parameters must be specified: **ttn, type/typea/typei/typen/typen24**.

**:gta=** (mandatory)

Global title start address. This parameter specifies the beginning of a range of global title digits.

**Range:** 1-21 digits

If the Hex Digit Support for GTT feature is not enabled and on, the range is 1 - 21 decimal digits; valid digits are **0-9**.

If the Hex Digit Support for GTT feature is enabled and on, the range is 1 - 21 hexadecimal digits; valid digits are **0-9, a-f, A-F**.

**:egta=** (optional)

Global title end address. This parameter specifies the end of a range of global title digits.

**Range:** 1-21 digits

If the Hex Digit Support for GTT feature is not enabled and on, the range is 1 - 21 decimal digits; valid digits are **0-9**.

If the Hex Digit Support for GTT feature is enabled and on, the range is 1 - 21 hexadecimal digits; valid digits are **0-9, a-f, A-F**.

**Default:** **egta** same as **gta**

**:ttn=** (optional)

Translation type name.

**Range:**        *ayyyyyyy*  
                   1 alphabetic character followed by up to 7 alphanumeric characters

**Default:**     No translation name is given

**:type/typea/typei/typen/typen24=** (optional)

Translation type identifies the translation type and network type. This parameter is the decimal representation of the 1-byte field used in SS7.

The **type** and **typea** parameters specify an ANSI network.

The **typei** parameter specifies an ITU-international network.

The **typen** parameter specifies an ITU-national network.

The **typen24** parameter specifies a 24-bit ITU-national network.

A translation type numeric value may be entered as ANSI type (**type** or **typea**) and also as an ITU type (**typei** or **typen**). However, they are separate entities.

The point code domain translation types for GTT are handled by the EAGLE 5 ISS protocol processing as either ANSI or ITU; therefore, ITU applies to ITU-I, ITU-I Spare, ITU-N, and ITU-N Spare. ITU-I includes ITU-I Spare, and ITU-N includes ITU-N Spare.

**Range:**        **0-255**  
**Default:**     No translation type is specified

### Example

```
dlt-gtt:type=252:ttn=1ldb9:gta=408908:egta=408988
```

```
dlt-gtt:gta=919833:typen24=4
```

The following example specifies hexadecimal digits for the gta and egta parameters.

```
dlt-gtt:ttn=set1:gta=abcd123456789a:egta=abcE123456789F
```

### Dependencies

This EGTT feature must be turned on before this command can be entered.

If translation type is specified, it must exist in the database.

If the **ttn** parameter is specified, the name must correspond to a translation type entry.

If both **ttn** and **type** are specified, **ttn** must correspond to the given translation type.

The **type** or **ttn** parameter must be specified.

The **gta** length must equal the number of digits specified by the translation type. If the VGTT (variable length GTT) feature is turned on, you can have up to 10 GTA lengths per translation type. When you enter the **ent-gtt** command to create entries, the software keeps track of the lengths and allows only ten different lengths. The global title address specified for the translation type must then have the same number of digits as an existing GTA.

The global title address range as expressed by the **gta** and **egta** parameters must already exist in the global title translation.

The range, as specified by the **gta** and the **egta**, must be exactly the same as a current entry or be contained within an existing range in the GTT data for the specified translation type. If the range overlaps, an error is generated that displays a list of overlapped global title addresses. An example follows that shows what happens when the user attempts to delete a global title address range (such as 8005550000 to 8005559999) that overlaps an existing range. The overlapping links must match. If they do not, the error message displays the list of overlapped global title addresses:

```

The following GTA ranges overlap the input GTA range
START GTA          END GTA
8005550000         8005551999
8005552000         8005553999
8005554000         8005555999
DLT-GTT: MASP A - Command Aborted

```

If the address range as specified by the start and end global title addresses does not exactly match the existing range, the range is split. All addresses in the existing range that are outside of the specified range are used to create new ranges. The specified range is deleted.

The Hex Digit Support for GTT feature must be enabled and on before hexadecimal digits can be specified for the **gta** or **egta** parameters.

If the **egta** parameter is specified, the value must be greater than the value specified for the **gta** parameter.

If a national Translation Type (**TYPEN**) is specified, the Translation Type must exist in the STP's active database.

If an International Translation Type (**TYPEI**) is specified, the Translation Type must exist in the STP's active database.

The **tt** parameter cannot be specified with a value that has been defined as an alias for another translation type.

The length of the specified GTA must match the number of digits provisioned for the specified Translation Type or the Translation Type referenced by the specified Translation Type Name, unless the PVGTT or VGTT feature is on. In the case the PVGTT feature is on the length of the specified GTA and EGTA can be less than or equal to the number of digits provisioned for the corresponding TT. In the case the VGTT feature is on, up to 10 different lengths can be provisioned per TT.

The **gta** length is not defined for the specified translation type entity.

The GTT table cannot be full.

## Output

```

dlt-gtt:type=252:ttn=lidb9:gta=408908:egta=408988
  rlgncxa03w 04-01-07 11:43:07 EST  EAGLE 31.3.0
  DLT-GTT:  MASP A - COMPLTD
;

```

## dlt-gttsel

## Delete GTT Selectors

Use this command to delete an applicable global title translation (GTT) selector.

**Keyword:** dlt-gttsel

**Related Commands:** chg-gttsel, ent-gttsel, rtrv-gttsel

**Command Class:** Database Administration



## Parameters

**NOTE: The Origin-based SCCP Routing (OBSR) feature must be enabled before the cgssn parameter can be specified.**

**NOTE: The Flexible Linkset Optional Based Routing (FLOBR) feature must be turned on before the eaglegen or lsn parameter can be specified.**

**NOTE: The OBSR feature must be enabled or the FLOBR feature must be turned on before the selid parameter can be specified.**

**:gti/gtia/gtii/gtin/gtin24=** (mandatory)

Global title indicator. For all EGTT selector commands, the domain is defined as **gti** and **gtia** (ANSI), **gtii** (ITU international), **gtin** (ITU national), and **gtin24** (24-bit ITU national).

For the selector commands, **gti** and **gtia** are equivalent; **gtii** and **gtin/gtin24** are mutually exclusive because the EGTT database does not distinguish between ITU national and ITU international translations. This means that while ITU-I and ITU-N selectors are stored separately, two separate ITU-I and ITU-N entries with the same selector values cannot exist. For example, if an entry with **gtii=2** and **tt=4** already exists, an entry of **gtin=2** and **tt=4** cannot be entered

**Range:** Supported value for ANSI: **gti=2** and **gtia=2**  
Supported values for ITU: **gtii=2, 4** and **gtin/gtin24=2, 4**

**:tt=** (mandatory)

Translation type.

**Range:** **0-255**

**:cgssn=** (optional)

CgPA subsystem number.

**Range:** **0-255**

**:eaglegen=** (optional)

This parameter specifies whether the selector is used by EAGLE 5 ISS generated messages.

**Range:** **yes**  
**yes** — used by EAGLE 5 ISS generated messages

**:lsn=** (optional)

Linkset name.

**Range:** *ayyyyyyyy*  
1 alphabetic character followed by up to 9 alphanumeric characters

**:nai=** (optional)

Nature of Address indicator. The Nature of Address indicator can be specified by supplying either a mnemonic value (**nai** parameter) or an explicit numeric value (**naiv** parameter). Either the **nai** parameter or the **naiv** parameter, but not both, can be specified in the command. Table A-5 shows the mapping between the **naiv** and the **nai** parameter values.

**Range:** **sub, rsvd, natl, intl, dflt**

**:naiv=** (optional)

Nature of Address indicator value. The Nature of Address indicator can be specified by supplying either a mnemonic value (**nai** parameter) or an explicit numeric value (**naiv** parameter). Either the **nai** parameter or the **naiv** parameter, but not both, can be specified in the command. Table A-5 shows the mapping between the **naiv** and the **nai** parameter values.

**Range:** **0-127**

**:np=** (optional)

Numbering Plan. The numbering plan indicator can be specified by supplying either a mnemonic value (**np** parameter) or an explicit numeric value (**npv** parameter). Either the **np** parameter or the **npv** parameter, but not both, can be specified in the command. Table A-6 shows the mapping between the **npv** and the **np** parameter values.

**Range:** e164, generic, x121, f69, e210, e212, e214, private, dflt

**:npv=** (optional)

Numbering Plan value. The numbering plan indicator can be specified by supplying either a mnemonic value (**np** parameter) or an explicit numeric value (**npv** parameter). Either the **np** parameter or the **npv** parameter, but not both, can be specified in the command. Table A-6 shows the mapping between the **npv** and the **np** parameter values.

**Range:** 0-15

**:selid=** (optional)

Selector ID.

**Range:** 0-65534

### Example

```
dlt-gttset:gti=2:tt=10
```

```
dlt-gttset:gtin=4:tt=0:np=dflt:nai=dflt
```

```
dlt-gttset:gtia=2:tt=21:cgssn=20:selid=1:lsn=ls10
```

```
dlt-gttset:gtia=2:tt=2:eaglegen=yes
```

### Dependencies

The EGTT feature must be turned on before this command can be entered.

The **np** and **npv** parameters cannot be specified together in the same command.

The **nai** and **naiv** parameters cannot be specified together in the same command.

The **gtia=4**, **gti/gtia/gtii/gtin/gtin24=1**, and **gti/gtia/gtii/gtin/gtin24=3** parameters cannot be specified.

If the **gti/gtia/gtii/gtin/gtin24=2** parameter is specified, then the **np/npv** and **nai/naiv** parameter combinations cannot be specified.

If the **gtii/gtin/gtin24=4** parameter is specified, then an **np(v)** and **nai(v)** parameter combination must be specified. These parameters can be specified in any combination: **np** and **naiv**, **npv** and **nai**, **np** and **nai**, or **npv** and **naiv**.

The FLOBR feature must be turned on before the **lsn** or **eaglegen** parameters can be specified.

If the **eaglegen=yes** parameter is specified, then the **lsn**, **selid**, or **cgssn** parameters cannot be specified.

The OBSR feature must be enabled or the FLOBR feature must be turned on before the **selid** parameter can be specified.

The GTT selector specified by the **gti(x)**, **tt**, and **np(v)** and **nai(v)** parameters must already exist.

A value of **dflt** must be specified for the **np** and **nai** parameters, or neither parameter can have a value of **dflt**.

The OBSR feature must be enabled before the **cgssn** parameter can be specified.

If a value of **dflt** is specified for the **np** and **nai** parameters, then the **cgssn**, **selid**, **lsn**, or **eaglegen** parameters cannot be specified.

The linkset specified by the **lsn** parameter must already exist.

**Notes**

When the EGTT feature is turned on, the GTT Selector (**ent/chg/dlt/rtrv-gttset**), GTT Set (**ent/dlt/rtrv-gttset**), and GTA (**ent/chg/dlt/rtrv-gta**) commands replace the Translation Type (**ent/dlt/rtrv-tt**) and Global Title Translation (**ent/chg/dlt/rtrv-gtt**) commands. All data previously provisioned with these commands is maintained.

**Output**

```
dlt-gttset:gti=2:tt=10
rlghncxa03w 04-02-18 08:54:41 EST EAGLE 31.3.0
DLT-GTTSEL: MASP A - CMLPTD
;
```

**dlt-gttset****Delete GTT Set**

Use this command to delete the specified global title translation set.

**Keyword:** dlt-gttset

**Related Commands:** chg-gttset, ent-gttset, rtrv-gttset

**Command Class:** Database Administration

**Parameters**

**:gttsn=** (mandatory)

GTT set name. A GTT set is an entity to which global title addresses and selectors are assigned.

**Range:** ayyyyyyyy

1 leading alphabetic and up to 8 following alphanumeric characters.

**Example**

```
dlt-gttset:gttsn=t800
```

**Dependencies**

The EGTT feature must be turned on before this command can be entered.

The **gttsn** parameter must be specified, cannot have a value of **none**, and must match an existing GTT set.

The specified GTT set cannot have any GTT selectors using it.

The specified GTT set cannot have the **gta**, **cgpc**, **cgssn**, **opc**, **cdssn** or **opcode** parameters assigned to it and cannot be used by any translation.

A GTT set cannot be deleted if it is being referenced by the SCCP Options table.

If the GTT set is referenced by the **bpartygttsn** or **is41smscgtsn** parameter in the **chg-gsmsmsopts** command or by the **bpartygttsn** parameter in the **chg-is41smsopts** command, then the GTT set cannot be deleted.

The value specified for the **gttsn** parameter must match the name of an existing GTT Set.

**Notes**

When the EGTT feature is turned on, the GTT Selector (**ent/chg/dlt/rtrv-gttset**), GTT Set (**ent/dlt/rtrv-gttset**), and GTA (**ent/chg/dlt/rtrv-gta**) commands replace the Translation Type (**ent/dlt/rtrv-tt**) and Global Title Translation (**ent/chg/dlt/rtrv-gtt**) commands. All data previously provisioned with these commands is maintained.

**Output**

```

dlt-gttset:gttsn=t800
  rlghncxa03w 09-08-09 08:20:26 EST  EAGLE 41.1.0
  DLT-GTTSET: MASP A - CMLPTD

  GTT-SET table is (3 of 2000) 1% full.

;

```

**dlt-gws-redirect****Delete Gateway Screening Redirect Command**

Use this command to delete the provisioning of the redirect function and subsequently to disable the gateway screening redirect function. After the gateway screening redirect function is disabled, you must use **ent-gws-redirect** to enable the function again.

**Keyword:** **dlt-gws-redirect**

**Related Commands:** **chg-gws-redirect, ent-gws-redirect,**

**Command Class:** Database Administration

**Parameters**

This command has no parameters.

**Example**

```
dlt-gws-redirect
```

**Dependencies**

The redirect function data that will be deleted (removed) with this command must exist in the database.

**Notes**

None

**Output**

```

dlt-gws-redirect

  rlghncxa03w 04-02-10 11:43:04 EST  EAGLE 31.3.0
  DLT-GWS-REDIRECT: MASP A - CMLPTD

;

```

**dlt-home-smsc****Delete HOME SMSC Address**

Use this command to delete HOME SMSC specific addresses currently used to identify Short Message Service Centers in the database. This command updates the HOME SMSCADDR table.

**Keyword:** **dlt-home-smsc**

**Related Commands:** **ent-home-smsc, rtrv-home-smsc**

**Command Class:** Database Administration

**Parameters**

**:smsc=** (mandatory)  
Short Message Service Center address.  
**Range:** 1-21 digits  
1-21 hexadecimal digits

**Example**

```
dlt-home-smsc:smc=552611646
```

**Dependencies**

One of the following features must be enabled (see the **enable-ctrl-feat** command) before this command can be entered.

- MO SMS IS41-to-GSM Migration
- MO-based GSM SMS NP
- MO-based IS41 SMS NP
- MT-Based GSM SMS NP
- MT-Based IS41 SMS NP
- Portability Check for Mobile Originated SMS

The specified HOME SMSC address must exist in the HOME SMSCADDR table.

**Notes**

None

**Output**

```
dlt-home-smsc:smc=552611646
rlghncxa03w 04-02-28 08:50:12 EST EAGLE 31.3.0
DLT-HOME-SMSC: MASP A - COMPLTD
;
```

**dlt-homern****Delete Home Routing Number Prefix**

Use this command to delete a routing number prefix from the HOMERN table.

**Keyword:** dlt-homern

**Related Commands:** ent-homern, rtrv-homern

**Command Class:** Database Administration

**Parameters**

**:rn=** (mandatory)  
The home routing number prefix  
**Range:** 1-15 digits

**Example**

```
dlt-homern:rn=C441234
```

**Dependencies**

The specified routing number must already exist in the HOMERN table.

A value of **none** cannot be specified for the **rn** parameter.

The A-Port, AINPQ, G-Port, INP, or V-Flex feature must be turned on before this command can be entered.

**Notes**

None

**Output**

```

dlt-homern:rn=C441234

rlghncxa03w 04-02-28 08:50:12 EST EAGLE 31.3.0
HOMERN table is (1 of 100) 1% full
DLT-HOMERN: MASP A - COMPLTD
;

```

**dlt-ip-host****Delete Internet Protocol Hostname**

Use this command to delete entries from the IP Host table. The IP Host table defines the local and remote host names and their associated IP addresses.

**Keyword:** dlt-ip-host

**Related Commands:** ent-ip-host, rtrv-ip-host

**Command Class:** Database Administration

**Parameters**

**:host=** (mandatory)

Host name. This parameter specifies the logical name assigned to the host device.

**Range:** ~~~~~

A string of characters, beginning with a letter and comprising up to 60 characters in length

Valid values are **a..z**, **A..Z**, **0..9**, **-**, or **.**

**Example**

```

dlt-ip-host:host=gw100.nc.tekelec.com

```

**Dependencies**

The value specified for the **host** parameter must begin with an alphabetic character and can contain **a..z**, **A..Z**, **0..9**, **-** (hyphen), or **.** (period). If the host name contains a hyphen, then the host name must be enclosed within quotation marks.

The value specified for the **host** parameter must already exist in the IP Host table.

Before a local entry can be deleted from the IP Host table, all association references to the hostname must be deleted. This rule does not apply to remote host entries.

**Notes**

None

**Output**

```

dlt-ip-host:host=gw100.nc.tekelec.com

rlghncxa03w 04-02-17 15:35:05 EST EAGLE 31.3.0
DLT-IP-HOST: MASP A - COMPLTD
;

```

**dlt-ip-node****Delete IP Node**

Use this command to remove an IP node from the database that is directly connected to a TCP/IP data link used for the STP LAN feature. You can remove a particular connection, a particular application on a node, or an entire node.

**Keyword:** dlt-ip-node

**Related Commands:** ent-ip-node, rtrv-ip-node

**Command Class:** Database Administration

## Parameters

**:ipaddr=** (mandatory)

The node's IP address. This is a TCP/IP address expressed in standard dot notation. IP addresses consist of the system's network number and the machine's unique host number. An example IP address is **192.126.100.5**, where **192.126.100** is the network number and **5** is the machine's host number.

**Range:** 1-223, 0-255

4 numbers separated by dots

**1-223**—first number

**0-255**—the other three numbers

**:force=** (optional)

Whether or not to remove all applications associated with the node, thus removing the entire node from the database.

**Range:** yes, no

**yes** — Delete all connections to node

**no** — Delete specified application or connection

**Default:** no

**:ipappl=** (optional)

The IP application supported by the node.

**Range:** stplan

**Default:** Default value not given

**:ippport=** (optional)

The logical IP port that addresses the application on the node.

**Range:** 1024-5000

**Default:** The logical IP port is not given.

**:loc=** (optional)

The card location as stenciled on the shelf of the system.

**Range:** 1101-1108, 1111-1112, 1201-1208, 1211-1218, 1301-1308, 1311-1318, 2101-2108, 2111-2118, 2201-2208, 2211-2218, 2301-2308, 2311-2318, 3101-3108, 3111-3118, 3201-3208, 3211-3218, 3301-3308, 3311-3318, 4101-4108, 4111-4118, 4201-4208, 4211-4218, 4301-4308, 4311-4318, 5101-5108, 5111-5118, 5201-5208, 5211-5218, 5301-5308, 5311-5318, 6101-6108, 6111-6118

**Default:** The card location is not given.

## Example

To delete the connection for a TCP/IP link associated with an STPLAN on a specified location:

```
dlt-ip-node:ipaddr=193.4.201.50:ipappl=stplan:loc=1201
```

To delete the connection for a TCP/IP link associated with an IPPORT on a specified location:

```
dlt-ip-node:ipaddr=193.4.201.50:ippport=1024:loc=1201
```

To delete all connections for TCP/IP links associated with the STPLAN on all locations:

```
dlt-ip-node:ipaddr=193.4.201.50:ipappl=stplan
```

To delete the connection for TCP/IP links associated with an IPPORT:

```
dlt-ip-node:ipaddr=193.4.201.50:ippport=1024
```

To delete all connections for a TCP/IP link associated with any application on a specified location:

```
dlt-ip-node:ipaddr=193.4.201.50:loc=1201
```

To delete all connections for TCP/IP links associated with any application on any location:

```
dlt-ip-node:ipaddr=193.4.201.50:force=yes
```

### Dependencies

The **force** parameter. must be specified to remove an entire node.

At least one of the following parameters must sbe specified: **ipappl**, **ippport**, **loc**, or **force=yes**.

If the **force=yes** parameter is specified, the **ipappl**, **ippport**, and **loc** parameters cannot be specified.

The **ipappl** and **ippport** parameters cannot be specified together in the command.

The ACM (shown by the entry ACMENET in the TYPE field in the **rtrv-card** command output) is the only valid card type for this command.

If the **loc** parameter is specified, the shelf and card must be equipped.

If the **loc** parameter is specified, the specified card must have a TCP/IP data link assigned to it.

If the **loc** parameter is specified, the IP port on the node must be assigned to the application for the specified TCP/IP data link.

If the **loc** and **ipaddr** parameters are specified, the specified IP address must match the IP address of the card location's remote IP node.

If the **loc** and **ippport** parameters are specified, the specified IP port must match the card location's remote IP port.

If the **loc** and **ipappl** parameters are specified, the specified IP application must match the card location's remote IP application.

The specified ACM (shown by the entry ACMENET in the TYPE field in the **rtrv-card** command output) must be out-of-service maintenance-disabled (OOS-MT-DSBLD). Enter the **rept-stat-card** command to verify the state of the ACM.

### Notes

A particular application can be specified by giving either the application's name (**ipappl**) or its IP port (**ippport**) on the node.

Only Class A, Class B, and Class C IP addresses are supported by the STP LAN feature.

### Output

```
dlt-ip-node:ipaddr=193.4.201.50:loc=1201
```

```
rlghncxa03w 04-02-10 11:43:04 EST EAGLE 31.3.0
Deleting multiple nodes on disk - please wait...
DLT-IP-NODE: MASP A - COMPLTD
;
```

## dlt-ip-rte

### Delete IP Route

Use this command to delete a static IP route entry from the Static IP Route table (destination IP address, subnet mask, and gateway IP address) for the specified card.



CAUTION

**CAUTION: The deletion of static IP routes can adversely affect IP connection oriented transports.**



**Keyword:** dlt-ip-rte  
**Related Commands:** , rtrv-ip-lnk  
**Command Class:** Database Administration

### Parameters

**:dest=** (mandatory)

Destination IP Address. The remote destination host or network destination IP Address that is to be removed.

**Range:** 4 numbers separated by dots, with each number in the range of **0–255**.  
 The IP address **0.0.0.0** is not valid.

**:loc=** (mandatory)

Card location. The unique identifier of a specific IP card in the system.

**Range:** **1101-1108, 1111-1112, 1201-1208, 1211-1218, 1301-1308, 1311-1318, 2101-2108, 2111-2118, 2201-2208, 2211-2218, 2301-2308, 2311-2318, 3101-3108, 3111-3118, 3201-3208, 3211-3218, 3301-3308, 3311-3318, 4101-4108, 4111-4118, 4201-4208, 4211-4218, 4301-4308, 4311-4318, 5101-5108, 5111-5118, 5201-5208, 5211-5218, 5301-5308, 5311-5318, 6101-6108, 6111-6118**

**:force=** (optional)

A value of **yes** is required when the card is allowed and this command is to be completed.

**Range:** **yes, no**  
**Default:** **no**

### Example

```
dlt-ip-rte:loc=1301:dest=128.252.10.5
dlt-ip-rte:loc=1301:dest=128.252.10.5:force=yes
```

### Dependencies

The **loc** parameter value must correspond to a SSED CM card in the card table that is running the **ss7ipgw**, **ipgwi**, **iplim**, or **iplimi** application.

The specified destination IP address (**dest** parameter):

- Must not be the default route (0.0.0.0)
- Must not correspond to any loopback address (i.e. 127.X.X.X)
- Must not reside on this card's A or B network

The specified destination IP address must exist in the Static IP Route table.

The card in the location specified with the **loc** parameter should typically be inhibited for this command to complete successfully. The **force=yes** parameter is required when the card is allowed and the command is entered.

### Notes

None

### Output

```
dlt-ip-rte:loc=1301:dest=128.252.10.5

rlghncxa03w 04-02-17 15:35:05 EST EAGLE 31.3.0
DLT-IP-RTE: MASP A - COMPLTD
;
```

**dlt-lbp****Delete Loopback Point**

Use this command to delete one or all far-end loopback points maintained in the Link Fault Sectionalization table for testing data signaling link elements in a single CCS7 transmission path.

**Keyword:** **dlt-lbp**

**Related Commands:** **act-lbp, chg-lbp, dact-lbp, ent-lbp, rtrv-lbp**

**Command Class:** Database Administration

**Parameters**

**:link=** (mandatory)

SS7 signaling link. The SS7 signaling link that is to be tested.

**Synonym:** **port**

**Range:** **a, b, a1-a31, b1-b31**

Not all card types support all **link** parameter values.

See Table A-1 for valid **link** parameter range values for each type of card that can have assigned signaling link ports.

**:loc=** (mandatory)

Card location. The unique identifier of a the card containing the signaling link you want to use for loopback point testing.

**Range:** **1101-1108, 1111-1112, 1201-1208, 1211-1218, 1301-1308, 1311-1318, 2101-2108, 2111-2118, 2201-2208, 2211-2218, 2301-2308, 2311-2318, 3101-3108, 3111-3118, 3201-3208, 3211-3218, 3301-3308, 3311-3318, 4101-4108, 4111-4118, 4201-4208, 4211-4218, 4301-4308, 4311-4318, 5101-5108, 5111-5118, 5201-5208, 5211-5218, 5301-5308, 5311-5318, 6101-6108, 6111-6118**

**:all=** (optional)

Deletes all loopback points for the specified signaling link or deletes only the link specified on the **lbp** parameter.

**Range:** **yes**

**:lbp=** (optional)

Loopback point ID. This parameter identifies a far-end loopback point that lies along an SS7 signaling link path between the STP and the target device (up to and including the target device).

**Range:** **1-32**

**Example**

```
dlt-lbp:loc=1101:link=a:lbp=1
```

```
dlt-lbp:loc=1101:link=a:all=yes
```

**Dependencies**

At least one optional parameter must be specified.

The **lbp** parameter and the **all** parameter cannot be specified together in the command.

The Link Fault Sectionalization (LFS) feature must be on before this command can be entered.

The loopback point (LBP) must have been previously defined.

The card location (**loc** parameter) must identify a **limds0**, **limt1**, or **limch** (associated to a **limt1**) card configured with either an **ss7ansi** or **ccs7itu** application.

The card location specified in the **loc** parameter must be equipped.

The card location specified in the **loc** parameter cannot be reserved by the system

**Notes**

None

**Output**

```
dlt-lbp:loc=1101:link=a:lbp=1

rlghncxa03w 05-02-17 15:35:05 EST EAGLE5 33.0.0
DLT-LBP: MASP A - COMPLTD
;
```

**dlt-lnp-serv****Delete LNP Service**

Use this command to delete from the database an LNP service or an alias translation type associated with an LNP service.

**Keyword:** **dlt-lnp-serv**

**Related Commands:** **chg-lnp-serv, ent-lnp-serv, rtrv-lnp-serv**

**Command Class:** Database Administration

**Parameters**

**:serv=** (mandatory)

Reserved service type name.

**Range:** **ain, in, pcs, wnp, class, lidb, cnam, isvm, lnpqs, wmsc, udf1, udf2, udf3, udf4, lrnqt**

**:alias=** (optional)

The alias translation type.

**Range:** **000-255**

**Example**

```
dlt-lnp-serv:serv=lidb
dlt-lnp-serv:serv=lidb:alias=236
dlt-lnp-serv:serv=lrnqt
```

**Dependencies**

The LNP feature must be turned on (see the **enable-ctrl-feat** command) before the **dlt-lnp-serv** command can be entered.

The value of the **serv** parameter must already exist in the LNP database.

The service must not be referenced in the LNP database.

The value of the **alias** parameter must be associated with the value of the specified **serv** parameter.

The value that is specified for the **alias** parameter must not already exist in the LNP database as a true translation type.

All aliases associated with the LNP service must be deleted before the service can be deleted.

The value of the **alias** parameter must exist in the LNP database.

**Notes**

None

**Output**

```

dlt-lnp-serv: serv=lidb
  rlghncxa03w 02-11-29 16:40:40 EST  EAGLE 30.0.0
  DLT-LNP-SERV: MASP A - COMPLTD
  Command Completed.
;

```

**dlt-loopset****Delete Loop Set Command**

Use this command to delete loopset and point code data from the database. This command updates the Loopset table.

**NOTE: A total of 6 point codes can be deleted each time the dlt-loopset command is issued. If the command is issued twice, all of the point codes in a loopset can be deleted, creating an empty loopset.**

**Keyword:** dlt-loopset

**Related Commands:** chg-loopset, ent-loopset, rtrv-loopset

**Command Class:** Database Administration

**Parameters**

**:name=** (mandatory)

Loopset name. This parameter specifies an entry in the Loopset table.

The **name=none** parameter cannot be specified.

**Range:** ayyyyyyy

1 alphabetic and up to 7 alphanumeric characters.

**:force=** (optional)

The **force=yes** parameter must be specified to delete a single point code entry from a loopset that is being used by GTT.

**Range:** yes

**:pcl=** (optional)

ANSI point code list with subfields *network indicator-network cluster-network cluster-member (ni-nc-ncm)*. The *prefix* subfield indicates a private point code (*prefix-ni-nc-ncm*). This parameter allows up to 6 comma-delimited entries in the point code list.

**Synonym:** pcla

**Range:** p-, 000-255

Specify a valid value for each subfield of the point code, and separate the subfields with a dash (-).

*prefix—p-*

When **chg-sid:pctype=ansi** is specified, *ni = 000* is not valid.

When **chg-sid:pctype=ansi** is specified, *nc = 000* is not valid if *ni = 001-005*.

When **chg-sid:pctype=ansi** is specified, *nc = 000* is valid if *ni = 006-255*.

The point code **000-000-000** is not a valid point code.

**:pcli=** (optional)

ITU international point code list with subfields *zone-area-id*. The *prefix* subfield indicates a spare point code, private point code, or private and spare point code (*prefix-zone-area-id*). This parameter allows up to 6 comma-delimited entries in the point code list.

**Range:** s-, p-, ps-, 0-255

Specify a valid value for each subfield of the point code, and separate the subfields with a dash (-).

*prefix*—**s-, p-, ps-**  
*zone*—**0-7**  
*area*—**000-255**  
*id*—**0-7**

The point code **0-000-0** is not a valid point code.

**:pcIn=** (optional)

ITU national point code list in the format of a 5-digit number (*nnnnn*); or 2, 3, or 4 numbers (members) separated by dashes (*m1-m2-m3-m4*) as defined by the **chg-stpopts:npcfmti** flexible point code option. A group code must be specified when the ITUDUPPC feature is turned on (*nnnnn-gc*, *m1-m2-m3-m4-gc*). The *prefix* subfield indicates a spare point code (*prefix-nnnnn*, *prefix-nnnnn-gc*, *prefix-m1-m2-m3-m4*, *prefix-m1-m2-m3-m4-gc*). This parameter allows up to 6 comma-delimited entries in the point code list.

**Range:** **s-, p-, ps-, 0-16383, aa-zz**

Specify a valid value for each subfield of the point code, and separate the subfields with a dash (-).

*prefix*—**s-, p-, ps-**  
*nnnnn*—**0-16383**  
*gc*—**aa-zz**

*m1-m2-m3-m4*—**0-14** for each member; values must sum to 14

**:pcIn24=** (optional)

24-bit ITU national point code with subfields *main signaling area-sub signaling area-signaling point* (*msa-ssa-sp*). This parameter allows up to 6 comma-delimited entries in the point code list.

**Range:** **p-, 000-255**

Specify a valid value for each subfield of the point code, and separate the subfields with a dash (-).

*prefix*—**p-**  
*msa*—**000-255**  
*ssa*—**000-255**  
*sp*—**000-255**

## Example

This example deletes the entire loopset table entry for the loopset rtp7 when that set is not being used by GTT.

```
dlt-loopset:name=rtp7
```

This example deletes a single point code in the entry for the loopset rtp2 when that set is being used by GTT.

```
dlt-loopset:name=rtp2:pc1=3-3-9:force=yes
```

This example deletes a point code for the loopset rtp1 when the loopset is not being used by GTT.

```
dlt-loopset:name=rtp1:pc1=3-3-9
```

## Dependencies

The value of the **name** parameter must already exist in the database.

The SCCP Loop Detection feature must be enabled before this command can be entered.

The GTT feature must be turned on before this command can be entered.

A loopset entry cannot be deleted when it is being used by GTT.

If a point code in the Loopset table is being used by GTT, then the **force=yes** parameter must be specified before the **pcl/pcli/pcln/pcln24** parameter can be specified.

The values for the **pcl** parameter cannot consist of any invalid point codes. The valid point codes must be consecutively specified and separated by commas.

The **name=none** parameter cannot be specified.

At least one valid point code must be specified as a value for the **pcl** parameter.

The values for the **pcl** parameter must be unique.

The value of the **pcl** parameter must exist in the loopset entry in the database.

### Output

The following example deletes a single point code in the entry for the loopset **rtp2** when the set is being used by GTT.

```
dlt-loopset:name=rtp2:pcl=3-3-9:force=yes
rlghncxa03w 07-02-10 08:48:25 EST EAGLE Rel 35.6.0
LOOPSET table is (11 of 1000) 1% full
DLT-LOOPSET: MASP A - COMPLTD
;
```

## dlt-ls

### Delete Linkset

Use this command to remove a linkset from the system database. A linkset is a group of signaling links carrying traffic to the same signaling point.

**Keyword:** **dlt-ls**

**Related Commands:** **chg-l3t, ent-ls, rept-stat-ls, rtrv-ls**

**Command Class:** Database Administration

### Parameters

**:lsn=** (mandatory)

Linkset name. This parameter specifies the name of the linkset. Only one linkset name per command can be specified.

**Range:** *ayyyyyyyyy*

1 alphabetic character followed by up to 9 alphanumeric characters

### Example

```
dlt-ls:lsn=lsna
```

### Dependencies

The linkset must be in the database.

The linkset can be removed only if all links associated with the linkset have been removed.

If the linkset is referenced by the historic routeset of any destination, then this command cannot be entered.

The specified linkset cannot be deleted if it has or is a mate linkset.

A gateway linkset can be deleted only from a SEAS terminal, and not from a system terminal.

The linkset cannot be deleted if an SAPC entry is present for the linkset.

If the linkset is referenced by the historic routeset of any exception route destination, then this command cannot be entered.

If multiple linksets are assigned to an adjacent point code, then the proxy linkset must be the final linkset that is deleted.

If the linkset that is specified by the **lsn** parameter is used as an incoming linkset for an exception route entry (see the **rtrv-rtx** command), then this command cannot be entered.

If the linkset is referenced by the GTT selector table, then this command cannot be entered.

### Notes

When a linkset is removed from the system database, the related entries are removed automatically from the translation type mapping table.

### Output

```
dlt-ls:lsn=lsna
rlghncxa03w 04-01-07 11:11:28 EST EAGLE 31.3.0
Link set table is (114 of 1024) 11% full
DLT-LS: MASP A - COMPLTD
;
```

## dlt-map

### Delete Mate Applications

Use this command to remove mate application entries, groups, or an Alternate RI Mate associated with a MAP Set. This command removes one or more entries from the Remote Point Code Subsystem Number table.



**CAUTION: If PC/SSNs within a weighted entity set are deleted such that the entity set's multiplicity mode becomes solitary or dominant, the weight values are reset to indicate a non-weighted entity set.**

**NOTE: See the "Notes" section for this command for additional information on multiplicity modes.**

**NOTE: The GTT LS ARI feature must be enabled before an Alternate RI Mate can be deleted from a MAP Set.**

**Keyword:** dlt-map

**Related Commands:** chg-map, ent-map, rtrv-map

**Command Class:** Database Administration

### Parameters

At least one of these parameters must be specified: **all**, **ssn**.

**NOTE: See "Point Code Formats and Conversion" for a detailed description of point code formats, rules for specification, and examples.**

**:pc=** (mandatory)

ANSI point code with subfields *network indicator-network cluster-network cluster member (ni-ncm)*.

**Synonym:** pca

**Range:** 000-255

Specify a valid value for each subfield of the point code, and separate the subfields with a dash (-).

When **chg-sid:pctype=ansi** is specified, **ni = 000** is not valid.

When **chg-sid:pctype=ansi** is specified, **nc = 000** is not valid if **ni = 001-005**.

When **chg-sid:pctype=ansi** is specified, **nc = 000** is valid if **ni = 006-255**.

The point code **000-000-000** is not a valid point code.

**:pc/pca/pci/pcn/pcn24=** (mandatory)

Post-GTT-translated point code.

**:pci=** (mandatory)

ITU international point code with subfields *zone-area-id*. The *prefix* subfield indicates a spare point code (*prefix-zone-area-id*)

**Range:** **s-, 0-255**

Specify a valid value for each subfield of the point code, and separate the subfields with a dash (-).

*prefix*—**s-**

*zone*—**0-7**

*area*—**000-255**

*id*—**0-7**

The point code **0-000-0** is not a valid point code.

**:pcn=** (mandatory)

ITU national point code in the format of a 5-digit number (*nnnnn*); or 2, 3, or 4 numbers (members) separated by dashes (*m1-m2-m3-m4*) as defined by the **chg-stpopts:npcfmti** flexible point code option. A group code must be specified when the ITUDUPPC feature is turned on (*nnnnn-gc*, *m1-m2-m3-m4-gc*). The *prefix* subfield indicates a spare point code (*prefix-nnnnn*, *prefix-nnnnn-gc*, *prefix-m1-m2-m3-m4*, *prefix-m1-m2-m3-m4-gc*).

**Range:** **s-, 0-16383, aa-zz**

Specify a valid value for each subfield of the point code, and separate the subfields with a dash (-).

*prefix*—**s-**

*nnnnn*—**0-16383**

*gc*—**aa-zz**

*m1-m2-m3-m4*—**0-14** for each member; values must sum to 14

**:pcn24=** (mandatory)

24-bit ITU national point code with subfields *main signaling area-sub signaling area-signaling point* (*msa-ssa-sp*).

**Range:** **000-255**

Specify a valid value for each subfield of the point code, and separate the subfields with a dash (-).

*msa*—**000-255**

*ssa*—**000-255**

*sp*—**000-255**

**:all=** (optional)

This parameter must be specified to remove all subsystem numbers associated with this point code. If this parameter is not specified, only the specified subsystem number is removed.

**Range:** **yes**

**Default:** **no**

**:mapset=** (optional)

The MAP set ID.

This parameter is mandatory if the Flexible GTT Load Sharing feature is enabled.

**Range:** **1-36000 dflt**

**dflt**—Default MAP set



**Default:** **dflt** - If the Flexible GTT Load Sharing feature is not enabled, the default value of the **mapset** parameter is **dflt**.

**:mrnset=** (optional)

Alternate RI Mate MRN Set ID.

**Range:** **1-6000 dflt**

**:ssn=** (optional)

Subsystem Number.

**Range:** **2-255**

**Default:** The specified subsystem number is removed for the given point code.

### Example

The following example deletes the single entry PC 1-1-1 with an SSN value of 123 from its mated group. If this is the last entry in the group then the PC is also deleted from the MAP tables:

```
dlt-map:pc=1-1-1:ssn=123
```

The following example deletes each entry of PC 1-1-1 and all SSNs associated with the PC from each of the PC/SSN mated groups. The PC is also deleted from the MAP tables:

```
dlt-map:pc=1-1-1:all=yes
```

The following command deletes subsystem 10 associated with spare PC 1-1-0 from the MAP table.

```
dlt-map:pci=s-1-1-0:ssn=10
```

The following example deletes subsystem 10 associated with PC 1-1-1 in MAP set 362.

```
dlt-map:pc=1-1-1:ssn=10:mapset=362
```

The following example deletes PC 1-1-1 along with all the subsystems associated with this PC in MAP set 362.

```
dlt-map:pc=1-1-1:all=yes:mapset=362
```

The following example deletes PC 1-1-2 along with all the subsystems associated with this PC in the default MAP set.

```
dlt-map:pc=1-1-2:all=yes:mapset=dflt
```

The following example deletes the Alternate RI Mate associated with MAP Set 362.

```
dlt-map:mapset=362:mrnset=1
```

The following example deletes the Alternate RI Mate for the default MAP Set and PC/SSN 1-1-1/10.

```
dlt-map:mapset=dflt:pc=1-1-1:ssn=10:mrnset=1
```

The following example deletes the entry from MAP set.

```
dlt-map:mapset=1:pc=1-1-1:ssn=10
```

### Dependencies

The **all** and **ssn** parameters cannot be specified together in the command.

If the **all=yes** parameter is specified, all SSNs for the given PC are removed.

The DPC of the primary subsystem must be a full PC.

The specified remote PC must exist in the MAP table.

The specified SSN must exist in the MAP table entity set associated with the specified remote PC.

An STP true point code that is assigned to an ATINPQ, EIR, INP, LNP, or V-Flex subsystem cannot be deleted.

If the **pcn** parameter is specified, the format of the PC must match the format that was assigned with the **chg-stpopts:npfnti** parameter.

If the Flexible GTT Load Sharing feature is not enabled, the **mapset** parameter must not be specified. If the Flexible GTT Load Sharing feature is enabled, the **mapset** parameter must be specified.

The specified MAP set must exist in the database.

The specified PC/SSN/MAP set must already be provisioned in the MAP table.

If the **pc** and **mapset** parameters are specified, and the **all=yes** parameter is specified, then at least one entry for that PC/MAP set must exist in the MAP table.

If the **mapset** parameter has any value other than **dflt**, then the PC/SSN/MAP set cannot be referenced from the GTT, GSM-MAP Opcode, GSM MAP Screening, or MRN table entry.

PC “Point code out of range”.

If the **pcn** or **mpcn** parameter is specified, then the format of the parameter must match the format dictated by the **chg-stpopts:npcfnti** command.

PC and SSN are not primary applications.

A PC/MAP set ID cannot be deleted from the MAP table if it is the last such entry and is being referenced by an entry in the PPSOPTS table.

The GTT LS ARI feature must be enabled before the **mrnset** parameter can be specified.

If the **mrnset** and the **mapset=dflt** parameters are specified, then the **ssn** parameter must be specified.

The value specified for the **mrnset** parameter must already be associated with a MAP Set.

If the **mrnset** parameter is specified, then the **all** parameter cannot be specified.

## Notes

For the MAP commands, an entity set consists of a group of PC/SSNs that are used for traffic distribution, and an RC group consists of PC/SSNs within an entity set that have the same RC. In loadsharing mode, an entity set contains 1 RC group. In combined/dominant loadsharing mode, an entity set can contain multiple loadsharing groups.

The EAGLE 5 ISS supports the following modes for nodes/subsystems:

- When a PC/SSN pair is not replicated, the pair is in *solitary* mode. The subsystem acts as the only application, with no backup. If this subsystem fails, messages routed to it are discarded and SCCP management returns “Subsystem Unavailable” messages to the originator.
- A group of replicated PC/SSN pairs are in *dominant* mode if each PC/SSN pair in the group has a unique RC. The specified subsystem with the lowest RC acts as the primary subsystem, while the mate subsystem acts as a backup. In the event of congestion, messages route to the mate subsystem. When the congestion subsides, messages are again routed to the primary (dominant) subsystem.
- A group of replicated PC/SSN pairs are in *load sharing* mode if each PC/SSN pair in the group has the same RC. All messages are evenly distributed at the SCCP level to all nodes/subsystems in the group. In the event of congestion or failure, the non-affected subsystem assumes the load of its failed or congested mate.
- The *combined load sharing/dominant* mode supports a combination of load sharing and dominant mode. A group of PC/SSN pairs are in combined load sharing/dominant mode when at least two of the PC/SSN pairs have the same RC and another node subsystem in the group has a different RC. A combination of node accessibility and RC determines the preferred PC/SSN.

When the Flexible GTT Load Sharing feature is on, MAP load sharing sets are supported. Each MAP set is identified by a new **mapset** parameter.

When the Weighted GTT Loadsharing feature is turned on, weighted entity sets and RC groups are supported, and threshold values can be assigned to each PC/SSN.

**Output**

```

dlt-map:pc=1-1-0:ssn=10:mapset=362
tekelecstp 08-12-22 12:20:10 EST EAGLE 40.1.0
DLT-MAP: MASP A - COMPLTD
;
dlt-map:mapset=362:mrnset=1
tekelecstp 08-12-22 12:20:10 EST EAGLE 40.1.0
DLT-MAP: MASP A - COMPLTD
;

```

**dlt-mrn****Delete Mated Relay Node**

Use this command to delete entries or an Alternate RI Mate from the MRN table. A single command can delete one point code from the group, or delete the entire group.



**CAUTION: If PCs within a weighted entity set are deleted such that the entity set's multiplicity mode becomes dominant, the weight values are reset to indicate a non-weighted entity set.**

**NOTE: See the "Notes" section for this command for additional information on multiplicity modes.**

**NOTE: The GTT LS ARI feature must be enabled before an Alternate RI Mate can be deleted from an MRN Set.**

**Keyword:** dlt-mrn

**Related Commands:** chg-mrn, ent-mrn, rtrv-mrn

**Command Class:** Database Administration

**Parameters**

**NOTE: See "Point Code Formats and Conversion" for a detailed description of point code formats, rules for specification, and examples.**

**:pc=** (mandatory)

ANSI point code with subfields *network indicator-network cluster-network cluster member (ni-nc-ncm)*.

**Synonym:** pca

**Range:** 000-255

Specify a valid value for each subfield of the point code, and separate the subfields with a dash (-).

When **chg-sid:pctype=ansi** is specified, *ni = 000* is not valid.

When **chg-sid:pctype=ansi** is specified, *nc = 000* is not valid if *ni = 001-005*.

When **chg-sid:pctype=ansi** is specified, *nc = 000* is valid if *ni = 006-255*.

The point code **000-000-000** is not a valid point code.

**:pc/pca/pci/pcn/pcn24=** (mandatory)

Post-GTT-translated point code.

**:pci=** (mandatory)

ITU international point code with subfields *zone-area-id*. The *prefix* subfield indicates a spare point code (*prefix-zone-area-id*)

**Range:** s-, 0-255

Specify a valid value for each subfield of the point code, and separate the subfields with a dash (-).

*prefix*—s-

*zone*—0-7

*area*—000-255

*id*—0-7

The point code **0-000-0** is not a valid point code.

**:pcn=** (mandatory)

ITU national point code in the format of a 5-digit number (*nnnnn*); or 2, 3, or 4 numbers (members) separated by dashes (*m1-m2-m3-m4*) as defined by the **chg-stpopts:npcfmti** flexible point code option. A group code must be specified when the ITUDUPPC feature is turned on (*nnnnn-gc*, *m1-m2-m3-m4-gc*). The *prefix* subfield indicates a spare point code (*prefix-nnnnn*, *prefix-nnnnn-gc*, *prefix-m1-m2-m3-m4*, *prefix-m1-m2-m3-m4-gc*).

**Range:** s-, 0-16383, aa-zz

Specify a valid value for each subfield of the point code, and separate the subfields with a dash (-).

*prefix*—s-

*nnnnn*—0-16383

*gc*—aa-zz

*m1-m2-m3-m4*—0-14 for each member; values must sum to 14

**:pcn24=** (mandatory)

24-bit ITU national point code with subfields *main signaling area-sub signaling area-signaling point* (*msa-ssa-sp*).

**Range:** 000-255

Specify a valid value for each subfield of the point code, and separate the subfields with a dash (-).

*msa*—000-255

*ssa*—000-255

*sp*—000-255

**:all=** (optional)

This parameter is used to delete the entire group of point codes that contains the specified point code in the MRN table.

**Range:** yes

**:mapset=** (optional)

Alternate RI Mate MAP Set ID.

**Range:** 1-36000 dflt

**:mrnset=** (optional)

The MRN set ID.

**Range:** 1-3000 dflt

dflt—Default MRN set.

**:pc1=** (optional)

ANSI point code with subfields *network indicator-network cluster-network cluster member* (*ni-nc-ncm*).

**Synonym:** pca1

**Range:** 000-255

Specify a valid value for each subfield of the point code, and separate the subfields with a dash (-).

When **chg-sid:pctype=ansi** is specified, *ni* = **000** is not valid.

When **chg-sid:pctype=ansi** is specified, *nc* = **000** is not valid if *ni* = **001–005**.

When **chg-sid:pctype=ansi** is specified, *nc* = **000** is valid if *ni* = **006–255**.

The point code **000-000-000** is not a valid point code.

**:pc1/pca1/pci1/pcn1/pcn241=** (optional)

Alternate post-GTT-translated point code.

**:pc2=** (optional)

ANSI point code with subfields *network indicator-network cluster-network cluster member (ni-nc-ncm)*.

**Synonym: pca2**

**Range: 000-255**

Specify a valid value for each subfield of the point code, and separate the subfields with a dash (-).

When **chg-sid:pctype=ansi** is specified, *ni* = **000** is not valid.

When **chg-sid:pctype=ansi** is specified, *nc* = **000** is not valid if *ni* = **001–005**.

When **chg-sid:pctype=ansi** is specified, *nc* = **000** is valid if *ni* = **006–255**.

The point code **000-000-000** is not a valid point code.

**:pc2/pca2/pci2/pcn2/pcn242=** (optional)

Alternate post-GTT-translated point code.

**:pc3=** (optional)

ANSI point code with subfields *network indicator-network cluster-network cluster member (ni-nc-ncm)*.

**Synonym: pca3**

**Range: 000-255**

Specify a valid value for each subfield of the point code, and separate the subfields with a dash (-).

When **chg-sid:pctype=ansi** is specified, *ni* = **000** is not valid.

When **chg-sid:pctype=ansi** is specified, *nc* = **000** is not valid if *ni* = **001–005**.

When **chg-sid:pctype=ansi** is specified, *nc* = **000** is valid if *ni* = **006–255**.

The point code **000-000-000** is not a valid point code.

**:pc3/pca3/pci3/pcn3/pcn243=** (optional)

Post-GTT-translated point code.

**:pc4=** (optional)

ANSI point code with subfields *network indicator-network cluster-network cluster member (ni-nc-ncm)*.

**Synonym: pca4**

**Range: 000-255**

Specify a valid value for each subfield of the point code, and separate the subfields with a dash (-).

When **chg-sid:pctype=ansi** is specified, *ni* = **000** is not valid.

When **chg-sid:pctype=ansi** is specified, **nc = 000** is not valid if **ni = 001–005**.

When **chg-sid:pctype=ansi** is specified, **nc = 000** is valid if **ni = 006–255**.

The point code **000-000-000** is not a valid point code.

**:pc4/pca4/pci4/pcn4/pcn244=** (optional)

Alternate post-GTT-translated point code.

**:pci1=** (optional)

ITU international point code with subfields *zone-area-id*. The *prefix* subfield indicates a spare point code (*prefix-zone-area-id*)

**Range:** **s-, 0-255**

Specify a valid value for each subfield of the point code, and separate the subfields with a dash (-).

*prefix*—**s-**

*zone*—**0-7**

*area*—**000-255**

*id*—**0-7**

The point code **0-000-0** is not a valid point code.

**:pci2=** (optional)

ITU international point code with subfields *zone-area-id*. The *prefix* subfield indicates a spare point code (*prefix-zone-area-id*)

**Range:** **s-, 0-255**

Specify a valid value for each subfield of the point code, and separate the subfields with a dash (-).

*prefix*—**s-**

*zone*—**0-7**

*area*—**000-255**

*id*—**0-7**

The point code **0-000-0** is not a valid point code.

**:pci3=** (optional)

ITU international point code with subfields *zone-area-id*. The *prefix* subfield indicates a spare point code (*prefix-zone-area-id*)

**Range:** **s-, 0-255**

Specify a valid value for each subfield of the point code, and separate the subfields with a dash (-).

*prefix*—**s-**

*zone*—**0-7**

*area*—**000-255**

*id*—**0-7**

The point code **0-000-0** is not a valid point code.

**:pci4=** (optional)

ITU international point code with subfields *zone-area-id*. The *prefix* subfield indicates a spare point code (*prefix-zone-area-id*)

**Range:** **s-, 0-255**

Specify a valid value for each subfield of the point code, and separate the subfields with a dash (-).

*prefix*—s-

*zone*—0-7

*area*—000-255

*id*—0-7

The point code **0-000-0** is not a valid point code.

**:pcn1=** (optional)

ITU national point code in the format of a 5-digit number (*nnnnn*); or 2, 3, or 4 numbers (members) separated by dashes (*m1-m2-m3-m4*) as defined by the **chg-stpopts:npfnti** flexible point code option. A group code must be specified when the ITUDUPPC feature is turned on (*nnnnn-gc*, *m1-m2-m3-m4-gc*). The *prefix* subfield indicates a spare point code (*prefix-nnnnn*, *prefix-nnnnn-gc*, *prefix-m1-m2-m3-m4*, *prefix-m1-m2-m3-m4-gc*).

**Range:** s-, 0-16383, aa-zz

Specify a valid value for each subfield of the point code, and separate the subfields with a dash (-).

*prefix*—s-

*nnnnn*—0-16383

*gc*—aa-zz

*m1-m2-m3-m4*—0-14 for each member; values must sum to 14

**:pcn2=** (optional)

ITU national point code in the format of a 5-digit number (*nnnnn*); or 2, 3, or 4 numbers (members) separated by dashes (*m1-m2-m3-m4*) as defined by the **chg-stpopts:npfnti** flexible point code option. A group code must be specified when the ITUDUPPC feature is turned on (*nnnnn-gc*, *m1-m2-m3-m4-gc*). The *prefix* subfield indicates a spare point code (*prefix-nnnnn*, *prefix-nnnnn-gc*, *prefix-m1-m2-m3-m4*, *prefix-m1-m2-m3-m4-gc*).

**Range:** s-, 0-16383, aa-zz

Specify a valid value for each subfield of the point code, and separate the subfields with a dash (-).

*prefix*—s-

*nnnnn*—0-16383

*gc*—aa-zz

*m1-m2-m3-m4*—0-14 for each member; values must sum to 14

**:pcn241=** (optional)

24-bit ITU national point code with subfields *main signaling area-sub signaling area-signaling point* (*msa-ssa-sp*).

**Range:** 000-255

Specify a valid value for each subfield of the point code, and separate the subfields with a dash (-).

*msa*—000-255

*ssa*—000-255

*sp*—000-255

**:pcn242=** (optional)

24-bit ITU national point code with subfields *main signaling area-sub signaling area-signaling point* (*msa-ssa-sp*).

**Range:** 000-255

Specify a valid value for each subfield of the point code, and separate the subfields with a dash (-).

*msa*—**000–255**

*ssa*—**000–255**

*sp*—**000–255**

**:pcn243=** (optional)

24-bit ITU national point code with subfields *main signaling area-sub signaling area-signaling point (msa-ssa-sp)*.

**Range:** **000-255**

Specify a valid value for each subfield of the point code, and separate the subfields with a dash (-).

*msa*—**000–255**

*ssa*—**000–255**

*sp*—**000–255**

**:pcn244=** (optional)

24-bit ITU national point code with subfields *main signaling area-sub signaling area-signaling point (msa-ssa-sp)*.

**Range:** **000-255**

Specify a valid value for each subfield of the point code, and separate the subfields with a dash (-).

*msa*—**000–255**

*ssa*—**000–255**

*sp*—**000–255**

**:pcn3=** (optional)

ITU national point code in the format of a 5-digit number (*nnnnn*); or 2, 3, or 4 numbers (members) separated by dashes (*m1-m2-m3-m4*) as defined by the **chg-stpopts:npcfnti** flexible point code option. A group code must be specified when the ITUDUPPC feature is turned on (*nnnnn-gc*, *m1-m2-m3-m4-gc*). The *prefix* subfield indicates a spare point code (*prefix-nnnnn*, *prefix-nnnnn-gc*, *prefix-m1-m2-m3-m4*, *prefix-m1-m2-m3-m4-gc*).

**Range:** **s-, 0-16383, aa-zz**

Specify a valid value for each subfield of the point code, and separate the subfields with a dash (-).

*prefix*—**s-**

*nnnnn*—**0-16383**

*gc*—**aa-zz**

*m1-m2-m3-m4*—**0-14** for each member; values must sum to 14

**:pcn4=** (optional)

ITU national point code in the format of a 5-digit number (*nnnnn*); or 2, 3, or 4 numbers (members) separated by dashes (*m1-m2-m3-m4*) as defined by the **chg-stpopts:npcfnti** flexible point code option. A group code must be specified when the ITUDUPPC feature is turned on (*nnnnn-gc*, *m1-m2-m3-m4-gc*). The *prefix* subfield indicates a spare point code (*prefix-nnnnn*, *prefix-nnnnn-gc*, *prefix-m1-m2-m3-m4*, *prefix-m1-m2-m3-m4-gc*).

**Range:** **s-, 0-16383, aa-zz**

Specify a valid value for each subfield of the point code, and separate the subfields with a dash (-).

*prefix*—**s-**



*nnnnn*—**0-16383**

*gc*—**aa-zz**

*m1-m2-m3-m4*—**0-14** for each member; values must sum to 14

### Example

The following example deletes the entire entry for the specified point code (the point code plus all of its associated point codes).

```
dlt-mrn:pc=1-1-0
```

The following example finds point codes 1-1-0 and 1-1-1, and deletes them from the group that contains them in the MRN table.

```
dlt-mrn:pc=1-1-0:pc1=1-1-1
```

The following example deletes from the MRN table the entire group of point codes that contains the specified point code.

```
dlt-mrn:pc=1-1-0:all=yes
```

The following examples include spare point codes.

```
dlt-mrn:pci=s-2-2-1
```

```
dlt-mrn:pcn=s-1-1-1-0235-aa
```

```
dlt-mrn:pc=1-1-9:mrnset=df1t
```

```
dlt-mrn:pc=1-1-9:mrnset=111
```

```
dlt-mrn:pc=1-1-1:pc1=1-1-9:mrnset=111
```

```
dlt-mrn:pc=1-1-9:All=yes:mrnset=111
```

The following example deletes the Alternate RI Mate for MRN Set 111.

```
dlt-mrn:mrnset=111:mapset=123
```

The following example deletes the Alternate RI Mate for the default MRN Set and PC 1-1-1.

```
dlt-mrn:mrnset=df1t:pc=1-1-1:mapset=123
```

The following example deletes the entry from the MRN set.

```
dlt-mrn:mrnset=1:pc=1-1-1
```

### Dependencies

ITU-N point codes must be the format set by the **npcfmti** parameter of the **chg-stpopts** command. (Use the **rtrv-stpopts** command to display the STP option settings.)

A point code that is specified in the command must already exist in the MRN table.

The PCs in an entity set cannot be deleted if the deletion leaves only one PC in the entity set. If this occurs, the entire entity set must be deleted by specifying the **all=yes** parameter.

The **mrnset** parameter can be specified only when the Flexible GTT Load Sharing feature is enabled. If the Flexible GTT Load Sharing feature is enabled, then the specified PC must already exist in the specified MRN set.

The specified MRN set must already exist in the MRN table.

A specified MRN Set or a PC in a MRN Set cannot be deleted if it is referred to in the GTT2 or MAP table.

The **rtrv-gtt** and **rtrv-gta** commands can be used to display GT Translations.

A point code in a non-default MRN set cannot be deleted from the MRN table if it is referenced by an entry in the PPSOPTS table.

If the **all=yes** parameter is specified, the **pc** parameter must be specified, and the **pc1/pc2/pc3/pc4** parameters cannot be specified.

The same point code value cannot be entered more than once for deletion.

The **pc/pc1/pc2/pc3/pc4** parameter values must be full point codes.

The GTT LS ARI feature must be enabled before the **mapset** parameter can be specified.

The value specified for the **mrnset** parameter must already be associated with a MAP Set.

If the **mapset** parameter is specified, then the **pc1**, **pc2**, **pc3**, **pc4**, and **all** parameters cannot be specified.

## Notes

For the MRN commands, an entity set consists of a group of PCs that are used for traffic distribution, and an RC group consists of PCs within an entity set that have the same RC. In loadsharing mode, an entity set contains 1 RC group. In combined/dominant loadsharing mode, an entity set can contain multiple loadsharing groups.

The EAGLE 5 ISS supports the following modes for nodes/subsystems:

- A group of replicated PCs are in *dominant* mode if each PC in the group has a unique RC. The specified subsystem with the lowest RC acts as the primary subsystem, while the mate subsystem acts as a backup. In the event of congestion, messages route to the mate subsystem. When the congestion subsides, messages are again routed to the primary (dominant) subsystem.
- A group of replicated PCs are in *load sharing* mode if each PC in the group has the same RC. All messages are evenly distributed at the SCCP level to all nodes/subsystems in the group. In the event of congestion or failure, the non-affected subsystem assumes the load of its failed or congested mate.
- The *combined load sharing/dominant* mode supports a combination of load sharing and dominant mode. A group of PC are in combined load sharing/dominant mode when at least two of the PC have the same RC and another node subsystem in the group has a different RC. A combination of node accessibility and RC determines the preferred PC.

The Flexible Intermediate GTT Loadsharing feature adds support for loadsharing sets, which are identified by the **mrnset** parameter.

The Flexible GTT Loadsharing feature and the Intermediate GTT Loadsharing feature used together support MRN sets for flexible intermediate GTT loadsharing.

When the Weighted GTT Loadsharing feature is turned on, weighted entity sets and RC groups are supported, and threshold values can be assigned to each PC/SSN.

## Output

```
dlt-mrn:pc=1-1-1:mrnset=111
  tekelecstp 08-12-22 12:20:10 EST EAGLE 40.1.0
  DLT-MRN : MASP A - COMPLTD
;

dlt-mrn:mrnset=111:mapset=123
  tekelecstp 08-12-22 12:20:10 EST EAGLE 40.1.0
  DLT-MRN : MASP A - COMPLTD
;
```

## dlt-na

### Delete Network Appearance

Use this command to delete a previously defined network appearance.

**Keyword:** dlt-na  
**Related Commands:** ent-na, rtrv-na  
**Command Class:** Database Administration

### Parameters

**:na=** (mandatory)  
 Network appearance.  
**Range:** 0-4294967295

**:type=** (mandatory)  
 Type of the network appearance to be deleted.  
**Range:** ansi, itui, ituis, itun, ituns, itun24

**:gc=** (optional)  
 Group Code of the network appearance.  
**Range:** yy  
 2 alphabetic characters; valid values are aa-zz

### Example

```
dlt-na:type=ansi:na=10
dlt-na:type=itui:na=11
dlt-na:type=itun:na=10
dlt-na:type=itun:na=11:gc=fr
dlt-na:type=ituis:na=4
```

### Dependencies

Group Code (**gc**) is not allowed with network types **ansi**, **itui**, **ituis**, and **itun24**.  
 The specified network appearance must exist in the Network Appearance table

### Notes

The ITUDUPPC feature must be turned on before a group code can be deleted for an ITU-N network type

### Output

```
dlt-na:pstncat=5000:pstnid=1:force=yes

r1ghncxa03w 04-02-20 09:07:58 EST EAGLE 31.3.0
DLT-NA: MASP A - COMPLTD
;
```

## dlt-npp-as

## Delete a NPP Action Set

Use this command to delete an NPP Action Set (AS) entry.

**Keyword:** dlt-npp-as  
**Related Commands:** chg-npp-as, dlt-npp-srs, ent-npp-as, rtrv-npp-as  
**Command Class:** Database Administration

### Parameters

**:asn=** (mandatory)  
 Action set name. This parameter specifies the name of the AS.  
**Range:** ayyyyyyyyy  
 1 alphabetic character followed by up to 9 alphanumeric characters

**Example**

```
dlt-npp-as:asn=asn1
```

**Dependencies**

The value specified for the **asn** parameter must exist in the NPP AS table.

If the AS is referenced by a NPP Service Rule Set, then this command cannot be entered.

**Output**

```
dlt-npp-as:asn=asn1
tekelecstp 09-02-19 13:57:06 EST EAGLE 40.1.0
NPP-AS table is (4 of 1024) 1% full.

DLT-NPP-AS: MASP A - COMPLTD
;
```

**dlt-npp-srs****Delete an NPP Service Rule Set**

Use this command to delete an NPP Service Rule Set (SRS).

**Keyword:** dlt-npp-srs

**Related Commands:** chg-npp-as, chg-npp-srs, dlt-npp-srs, ent-npp-as, rtrv-npp-as, rtrv-npp-srs

**Command Class:** Database Administration

**Parameters**

**:fdl=** (mandatory)

Filter digit length. This parameter specifies the number of digits on the incoming digit string that is filtered by the NPP.

**Range:** 1-32 \*

\*—multiple lengths of messages can be filtered

**:fnai=** (mandatory)

Filter Nature of Address Indicator (NAI).

**Range:** intl, natl, nai1, nai2, nai3, unkn

**intl** — filter messages with NAI=INTL

**natl** — filter messages with NAI=NATL

**nai1** — filter messages with NAI=NAI1

**nai2** — filter messages with NAI=NAI2

**nai3** — filter messages with NAI=NAI3

**unkn** — filter messages when the NAI is unknown

**:fpx=** (mandatory)

Filter prefix. This parameter specifies the prefix used to filter incoming digit strings.

**Range:** 1-16 digits, \*, ?

1 - 16 hexadecimal digits inclusive of single digit wildcard (?); or wildcard (\*) matching the entire digit string; valid digits are ?, 0-9, a-f, A-F.

**:srvn=** (mandatory)

Service name. This parameter specifies the name of the NPP Service.

**Range:** nppt, idprcdpn, idprcgpn, tif, tif2, tif3, mosmsgcgn, mosmsicdpn,

mosmsgcdpn, iarcgpn, iarcgpn

**nppt** — NPP Test Service

**idprcdpn** — IDPRCDPN Service

**idprcgpn** — IDPRCGPN Service

**tif** — TIF Service  
**tif2** — TIF2 Service  
**tif3** — TIF3 Service  
**mosmsicgpn** — MOSMSICGPN Service  
**mosmsicdpn** — MOSMSICDPN Service  
**mosmsgcgpn** — MOSMSGCGPN Service  
**mosmsgcdpn** — MOSMSGCDPN Service  
**iarcdpn** — IARCDPN Service  
**iarcgpn** — IARCGPN Service

**Example**

```
dlt-npp-srs:svrn=nppt:fpx=a:fdl=10:fnai=intl
dlt-npp-srs:svrn=nppt:fpx=abc:fdl=16:fnai=intl
```

**Dependencies**

The NPP Rule must exist in the NPP Rule table.  
 The value specified for the **fpx** parameter cannot have a ? as the final character.

**Output**

```
dlt-npp-srs:svrn=nppt:fpx=abc:fdl=16:fnai=intl
tekelecstp 09-02-19 13:57:01 EST EAGLE 40.1.0
NPP-SRS table is (0 of 8192) 0% full.

DLT-NPP-SRS: MASP A - COMPLTD
;
```

**dlt-prefix**

**Delete Prefix**

Use this command to delete a prefix based on the name of the feature, its prefix, and its prefix number.

**Keyword:** **dlt-prefix**  
**Related Commands:** **chg-prefix, rtrv-ctrl-feat, rtrv-prefix**  
**Command Class:** Database Administration

**Parameters**

**NOTE:** See "Point Code Formats and Conversion" for a detailed description of point code formats, rules for specification, and examples.

**:feature=** (mandatory)

Feature Name. This parameter specifies the name of an enabled controlled feature that is supported by this command. The parameter value must match the feature name as it is displayed in the **rtrv-ctrl-feat** command output.

**Range:** *abcdefghijklmnopqrstuvwxyz*

1 alphabetic character and up to 24 optional alphanumeric characters and spaces, enclosed in double quotation marks.  
 The parameter value is not case-sensitive; upper case or lower case or both can be entered.

Part or all of the feature name can be entered. If part of the feature name is specified, the entry must start with the first letter of the name, and must contain enough of the name to uniquely identify the feature. For example, there are two feature names that begin with "GSM MAP." Enter enough additional characters to identify which GSM MAP feature is being entered (at least "GSM MAP SR" to identify the "GSM MAP SRI Redirect" feature). This command supports the following controlled features:

- GSM MAP SRI Redirect
- ISUP NP for EPAP

**:prefix=** (mandatory)

Prefix Value.

**Range:** 1-15 digits  
1-15 hexadecimal digits; valid digits are **0-9, a-f, A-F**.

**Default:** Current value**:prefixnum=** (mandatory)

Prefix Number. The prefix number identifies the prefix value to use for the specified feature name.

**Range:** **1-7**  
**1-3** for GSM MAP SRI Redirect feature prefix values  
**1-5** for ISUP NP with EPAP feature prefix values  
**6** for the ISUP NP with EPAP feature Insertion Country Code  
**7** for the ISUP NP with EPAP feature Deletion Condition value

**Default:** Current value**Example**

Delete a prefix with prefix number 1 for the ISUP NP with EPAP feature.

**dlt-prefix:feature="isup np with epap":prefix=1004:prefixnum=1**

Delete a prefix with prefix number 2 and specify part of the GSM MAP SRI Redirect feature name.

**dlt-prefix:feature="GSM MAP SRI":prefix=104:prefixnum=2****Dependencies**

The specified feature name must be the name of an enabled controlled feature as it is displayed in the **rtrv-ctrl-feat** command output. The specified feature must be one of the following features that are supported by this command:

- GSM MAP SRI Redirect
- ISUP NP for EPAP

The specified feature prefix value must already exist in the database.

The specified feature prefix value must be used by the specified feature in the database.

**Notes**

None

**Output****dlt-prefix:feature="isup np with epap":prefix=1004:prefixnum=1**

r1ghncxa03w 04-09-20 09:04:14 EST EAGLE 31.11.0

DLT-PREFIX: MASP A - COMPLTD

;

**dlt-rmt-appl****Delete Remote Application**

Use this command to remove remote application assignments from the database.

**Keyword:** dlt-rmt-appl**Related Commands:** ent-rmt-appl, rtrv-rmt-appl**Command Class:** Database Administration

## Parameters

**:ipc=** (mandatory)

ANSI point code with subfields *network indicator-network cluster-network cluster member (ni-nc-ncm)*. The *prefix* subfield indicates a private point code (prefix-ni-nc-ncm).

**Synonym: ipca****Range: p-, 000-255**

Specify a valid value for each subfield of the point code, and separate the subfields with a dash (-).

*prefix*—**p-**

When **chg-sid:pctype=ansi** is specified, *ni = 000* is not valid.

When **chg-sid:pctype=ansi** is specified, *nc = 000* is not valid if *ni = 001-005*.

When **chg-sid:pctype=ansi** is specified, *nc = 000* is valid if *ni = 006-255*.

The point code **000-000-000** is not a valid point code.

**:ipc/ipca/ipci/ipcn/ipcn24=** (mandatory)

End node's internal point code.

**:ipci=** (mandatory)

ITU international point code with subfields *zone-area-id*. The *prefix* subfield indicates a spare point code, private point code, or private and spare point code (*prefix-zone-area-id*).

**Range: s-, p-, ps-, 0-255**

Specify a valid value for each subfield of the point code, and separate the subfields with a dash (-).

*prefix*—**s-, p-, ps-**

*zone*—**0-7**

*area*—**000-255**

*id*—**0-7**

The point code **0-000-0** is not a valid point code.

**:ipcn=** (mandatory)

ITU national point code in the format of a 5-digit number (*nnnnn*); or 2, 3, or 4 numbers (members) separated by dashes (*m1-m2-m3-m4*) as defined by the **chg-stpopts:npcfmti** flexible point code option. A group code must be specified when the ITUDUPPC feature is turned on (*nnnnn-gc, m1-m2-m3-m4-gc*). The *prefix* subfield indicates a spare point code, private point code, or private and spare point code (*prefix-nnnnn, prefix-nnnnn-gc, prefix-m1-m2-m3-m4, prefix-m1-m2-m3-m4-gc*).

**Range: s-, p-, ps-, 0-16383, aa-zz**

Specify a valid value for each subfield of the point code, and separate the subfields with a dash (-).

*prefix*—**s-, p-, ps-**

*nnnnn*—**0-16383**

*gc*—**aa-zz**

*m1-m2-m3-m4*—**0-14** for each member; values must sum to 14

**:ipcn24=** (mandatory)

24-bit ITU national point code with subfields *main signaling area-sub signaling area-signaling point (msa-ssa-sp)*. The *prefix* indicates a private point code (*prefix-msa-ssa-sp*).

**Range: p-, 000-255**

Specify a valid value for each subfield of the point code, and separate the subfields with a dash (-).

*prefix*—**p-**  
*msa*—**000-255**  
*ssa*—**000-255**  
*sp*—**000-255**

**:si=** (mandatory)

Service indicator value that designates which user part is assigned to IPC.

**Range:** 3-15

**:ssn=** (optional)

SCCP subsystem number. Valid only if **si=3**. Use **ssn** as the starting value of the range if **ssne** is specified.

**Range:** 0-255

**:ssne=** (optional)

Specifies the end range of subsystem number.

**Range:** 0-255

### Example

```
dlt-rmt-appl:ipc=0-0-1:si=3:ssn=5
dlt-rmt-appl:ipc=0-0-1:si=5
dlt-rmt-appl:ipcn24=1-100-1:si=5
dlt-rmt-appl:ipci=ps-2-2-2:si=5
```

### Dependencies

Partial point codes are not allowed.

The **ssn** parameter is required if **si=3**.

The **ssn** and **ssne** parameters are not allowed unless **si=3**.

The **ssne** parameter value must be greater than the **ssn** parameter value.

The specified **ipc** must be previously defined in the Destination table.

The new entry cannot conflict with an existing entry.

The **ipc**, **si**, and **ssn...ssne** parameter values must all match a value in the Destination table.

### Notes

To specify a range of subsystem numbers, specify the **ssn** parameter value as the start of the range and the **ssne** parameter value as the end of the range.

In this command, only ITU-international and ITU national point codes support the spare point code subtype prefix (**s-**) and the private and spare point code subtype prefix (**ps-**). All of the point code types support the private (internal) point code subtype prefix (**p-**).

### Output

```
dlt-rmt-appl:ipc=0-0-1:si=3:ssn=5
  rlgncxa03w 04-01-07 11:43:04 EST EAGLE 31.3.0
  DLT-RMT-APPL: MASP A - COMPLTD
;
```

## dlt-rte

## Delete Route

Use this command to remove either a single route or all routes from the system database.



**Keyword:** dlt-rte

**Related Commands:** chg-dstn,, dlt-dstn, ent-dstn, ent-rte, rept-stat-dstn, rept-stat-rte, rtrv-dstn, rtrv-rte

**Command Class:** Database Administration

### Parameters

**NOTE:** See "Point Code Formats and Conversion" for a detailed description of point code formats, rules for specification, and examples.

At least one of the following optional parameters must be specified: **dpc/dpca/dpci/dpcn/dpcn24** or **cic**. If the **dpc/dpca/dpci/dpcn/dpcn24** parameter is specified, then action is taken upon the historic routes of the destination entity only.

**:all=** (optional)

This parameter removes all destinations from the system database.

**Range:** yes

**Default:** no

**:dpc=** (optional)

ANSI destination point code with subfields *network indicator-network cluster-network cluster member (ni-nc-ncm)*. The *prefix* subfield indicates a private point code (*prefix-ni-nc-ncm*).

**Synonym:** dpca

**Range:** p-, 000-255, \*

Specify a valid value for each subfield of the point code, and separate the subfields with a dash (-).

*prefix*—p-

The asterisk value (\*) is not valid for the *ni* subfield.

When **chg-sid:pctype=ansi** is specified, *ni* = 000 is not valid.

When **chg-sid:pctype=ansi** is specified, *nc* = 000 is not valid if *ni* = 001–005.

When **chg-sid:pctype=ansi** is specified, *nc* = 000 is valid if *ni* = 006–255.

The point code 000-000-000 is not a valid point code.

**:dpc/dpca/dpci/dpcn/dpcn24=** (optional)

Destination point code.

**:dpci=** (optional)

ITU international destination point code with subfields *zone-area-id*. The *prefix* subfield indicates a spare point code, private point code, or private and spare point code (*prefix-zone-area-id*).

**Range:** s-, p-, ps-, 0-255

Specify a valid value for each subfield of the point code, and separate the subfields with a dash (-).

*prefix*—s-, p-, ps-

*zone*—0-7

*area*—000-255

*id*—0-7

The point code 0-000-0 is not a valid point code.

**:dpcn=** (optional)

ITU national destination point code in the format of a 5-digit number (*nnnnn*); or 2, 3, or 4 numbers (members) separated by dashes (*m1-m2-m3-m4*) as defined by the **chg-stpopts:npfnti** flexible point code option. A group code must be specified when the ITUDUPPC feature is turned on (*nnnnn-gc, m1-m2-m3-m4-gc*). The *prefix* subfield indicates a spare point code, private point code, or private

and spare point code (*prefix-nnnnn*, *prefix-nnnnn-gc*, *prefix-m1-m2-m3-m4*, *prefix-m1-m2-m3-m4-gc*).

**Range:** **s-, p-, ps-, 0-16383, aa-zz**

Specify a valid value for each subfield of the point code, and separate the subfields with a dash (-).

*prefix*—**s-, p-, ps-**

*nnnnn*—**0-16383**

*gc*—**aa-zz**

*m1-m2-m3-m4*—**0-14** for each member; values must sum to 14

**:dpcn24=** (optional)

24-bit ITU national point code with subfields *main signaling area-sub signaling area-signaling point (msa-ssa-sp)*. The *prefix* subfield indicates a private point code (*prefix-msa-ssa-sp*).

**Range:** **p-, 000-255**

Specify a valid value for each subfield of the point code, and separate the subfields with a dash (-).

*prefix*—**p-**

*msa*—**000-255**

*ssa*—**000-255**

*sp*—**000-255**

**:lsn=** (optional)

Linkset name. This parameter specifies the name of the linkset associated with the route.

**NOTE: This parameter must be specified when the all parameter is not specified, and cannot be specified when the all=yes parameter is specified.**

**Range:** *ayyyyyyyyy*

1 alphabetic character followed by 9 alphanumeric characters

**Default:** No linkset name is specified

### Example

Delete route to dpc 1-1-1 using linkset hq435326:

```
dlt-rte:dpc=1-1-1:lsn=hq435326
```

Delete all routes to dpc 2-2-2:

```
dlt-rte:dpc=2-2-2:all=yes
```

Delete all routes to dpc 21-\*-\*:

```
dlt-rte:dpc=21-*-*:all=yes
```

Delete route to dpcn=3-15-15-15-sp using link elm2itun:

```
dlt-rte:dpcn=3-15-15-15-sp:lsn=elm2itun
```

Delete route for dpcn24=10-100-14 using linkset we123624:

```
dlt-rte:dpcn24=10-100-14:lsn=we123624:rc=10
```

Delete route to private point code dpc=p-1-1-1 using linkset hq325426:

```
dlt-rte:dpc=p-1-1-1:lsn=hq325426
```

Delete all routes to private point code dpc=p-21-\*-\*:

```
dlt-rte:dpc=p-21-*-*:all=yes
```

Delete route to spare point code dpci=s-1-100-1 using linkset we123624:

```
dlt-rte:dpci=s-1-100-1:lsn=we123624
```

## Dependencies

The **dpc/dpca/dpci/dpcn/dpcn24** parameter must exist in the Destination Point Code table.

The value of the **lsn** parameter must exist in the Linkset table.

If the **all=yes** parameter is specified, then the **lsn** parameter cannot be specified.

At least one optional parameter must be specified.

The destination point code of a route must be a full point code (*ni-nc-ncm*) or a cluster point code (*ni-nc-\**).

If the specified destination address is a full point code address (*ni-nc-ncm*) and is a member of a provisioned cluster (*ni-nc-\**), then whether the ordered routes can be deleted is determined by the destination address's nested cluster allowed indicator. This value is set with the **ncai** parameter of the **ent/chg-dstn** commands:

- If the **ncai=no** parameter is specified, then the ordered route cannot be deleted.
- If the **ncai=yes** parameter is specified, then the destination address is a member of a provisioned nested cluster where the ordered routes of the provisioned members can be deleted. Deletion of the ordered routes of a provisioned member results in the provisioned member assuming the attributes of its cluster

If the specified destination address is a network cluster address (*ni-nc-\**), then the method used to delete the specified ordered route attributes is determined by the setting of the destination address's nested cluster allowed indicator. This value is set with the **ncai** parameter of the **ent/chg-dstn** commands.

- If the **ncai=no** parameter is specified, then the specified ordered route is deleted for each signaling point code having the same network identifier (*ni*) and network cluster (*nc*) codes.
- If the **ncai=yes** parameter is specified, then the specified destination is a nested cluster where deletion of the cluster route will not delete the ordered route of the provisioned member.

If the **dpcn** parameter is specified, the format of the point code(s) must match the format you assigned with the **chg-stpopts:npcfnti** parameter.

The last route for the specified destination point code being removed cannot be referenced by an X.25 route, a mated application, or a concerned signaling point code. If any of the destinations referencing the specified routset exist in the MAP table, then the last route of the routeset cannot be deleted.

The last route to a destination referenced by an X.25 route cannot be deleted.

If any of the destinations referencing the routset is used by the redirect function, then the last route of the routeset cannot be deleted.

The last route to a destination point code that exists in the MRN table cannot be deleted until the point code is deleted from the MRN table. If any of the destinations referencing the specified routset exists in the MRN table, then the last route of the routeset cannot be deleted.

The last route to a destination point code that still exists in the Concerned Secondary Point Code (CSPC) table cannot be deleted until the point code is deleted from the CSPC table. If any of the destinations referencing the routset exist in the CSPC table, then the last route of the routeset cannot be deleted.

If the destination point codes associated with the routeset are referenced by GTT, then the last route cannot be deleted. If the last route to a destination point code is referenced by a GTT, then then the route cannot be deleted until one of the following actions is performed:

- Delete the GTT using the route's destination.

- Change the route used by the GTT to a route using a different destination.
- Add another route using the same destination.

The NRT feature must be turned on before the **dpc/dpca/dpci/dpcn/dpcn24** parameter can be specified.

When using network routing, if the destination point code has a value of \* in the *nc* field, the *ncm* field must also be \* (for example, **dpc=21-\*-\***).

If the routeset does not contain routes, then the **all=yes** parameter cannot be specified.

The last route to a destination that contains exception routes cannot be deleted. If any of the destinations referencing the specified routset contains exception routes, then the last route of the routeset cannot be deleted.

The value of the **dpc/dpca/dpci/dpcn/dpcn24** parameter cannot exist in the Application Filter table.

The last route to a destination point code that still exists in the Prepaid SMS Options (PPSOPTS) table cannot be deleted until the point code is deleted from the PPSOPTS table. If any of the destinations referencing the routset exist in the PPSOPTS table, then the last route of the routeset cannot be deleted.

If multiple routes are assigned to a point code, then the route that uses the proxy linkset must be the final route that is deleted.

The network type of the linkset and routeset must match.

## Notes

In this command, only ITU-international and ITU national point codes support the spare point code subtype prefix (**s-**) and the private and spare point code subtype prefix (**ps-**). All of the point code types support the private (internal) point code subtype prefix (**p-**).

## Output

```
dlt-rte:dpc=1-1-1:lsn=ls01
rlghncxa03w 04-01-07 11:43:04 EST EAGLE 31.3.0
DLT-RTE: MASP A - COMPLTD
;
```

In the following example, the GTT and X.25 Gateway features are turned on.

```
dlt-rte:dpc=2-2-2:all=yes
rlghncxa03w 04-01-07 11:43:04 EST EAGLE 31.3.0
WARNING - ROUTE MAY BE REFERENCED BY MAP, CSPC, OR X25 RTE.
DLT-RTE: MASP A - COMPLTD
;
```

In the following example, only the GTT feature is turned on.

```
dlt-rte:dpc=2-2-2:all=yes
rlghncxa03w 04-01-07 11:43:04 EST EAGLE 31.3.0
WARNING - ROUTE MAY BE REFERENCED BY MAP OR CSPC.
DLT-RTE: MASP A - COMPLTD
;
```

In the following example, only the X.25 Gateway feature is turned on.

```
dlt-rte:dpc=2-2-2:all=yes
rlghncxa03w 04-01-07 11:43:04 EST EAGLE 31.3.0
WARNING - ROUTE MAY BE REFERENCED BY X25 RTE.
DLT-RTE: MASP A - COMPLTD
;
```

**dlt-rtx****Delete Exception Route**

Use this command to delete an exception route entry. If only the **dpc** and criteria (**opc/ilsn/cic/si**) parameters are specified, then all exception route entries associated with those parameters are deleted.

**Keyword:** dlt-rtx

**Related Commands:** chg-rtx, ent-rtx, rept-stat-rtx, rtrv-rtx

**Command Class:** Database Administration

**Parameters**

**NOTE:** The following parameters are no longer available: all, force

**:dpc=** (mandatory)

ANSI destination point code with subfields *network indicator-network-cluster-network cluster member (ni-nc-ncm)*. The *prefix* subfield indicates a private point code (*prefix-ni-nc-ncm*).

**Synonym:** dpca

**Range:** p-, 000-255

Specify a valid value for each subfield of the point code, and separate the subfields with a dash (-).

*prefix*—p-

When **chg-sid:pctype=ansi** is specified, *ni = 000* is not valid.

When **chg-sid:pctype=ansi** is specified, *nc = 000* is not valid if *ni = 001-005*.

When **chg-sid:pctype=ansi** is specified, *nc = 000* is valid if *ni = 006-255*.

The point code **000-000-000** is not a valid point code.

**:dpc/dpca/dpci/dpcn/dpcn24=** (mandatory)

Destination point code.

**:dpci=** (mandatory)

ITU international point code with subfields *zone-area-id*. The *prefix* subfield indicates a spare point code, private point code, or private and spare point code (*prefix-zone-area-id*).

**Range:** s-, p-, ps-, 0-255

Specify a valid value for each subfield of the point code, and separate the subfields with a dash (-).

*prefix*—s-, p-, ps-

*zone*—0-7

*area*—000-255

*id*—0-7

The point code **0-000-0** is not a valid point code.

**:dpcn=** (mandatory)

ITU national point code in the format of a 5-digit number (*nnnnn*); or 2, 3, or 4 numbers (members) separated by dashes (*m1-m2-m3-m4*) as defined by the **chg-stpopts:npcfmti** flexible point code option. A group code must be specified when the ITUDUPPC feature is turned on (*nnnnn-gc, m1-m2-m3-m4-gc*). The *prefix* subfield indicates a spare point code, private point code, or private and spare point code (*prefix-nnnnn, prefix-nnnnn-gc, prefix-m1-m2-m3-m4, prefix-m1-m2-m3-m4-gc*).

**Range:** s-, p-, ps-, 0-16383, aa-zz

Specify a valid value for each subfield of the point code, and separate the subfields with a dash (-).

*prefix*—s-, p-, ps-

*nnnnn*—**0-16383**

*gc*—**aa-zz**

*m1-m2-m3-m4*—**0-14** for each member; values must sum to 14

**:dpen24=** (mandatory)

24-bit ITU national point code with subfields *main signaling area-sub signaling area-signaling point (msa-ssa-sp)*. The *prefix* subfield indicates a private point code (*prefix-msa-ssa-sp*).

**Range:** **p-, 000-255**

Specify a valid value for each subfield of the point code, and separate the subfields with a dash (-).

*prefix*—**p-**

*msa*—**000-255**

*ssa*—**000-255**

*sp*—**000-255**

**:cic=** (optional)

Starting Circuit Identification Code. This parameter is used alone or together with the **ecic** parameter as exception routing criteria for the specified exception route.

**Range:** **0-16383**

**:ecic=** (optional)

Ending Circuit Identification Code. This parameter, together with the **cic** parameter defines the CIC range that is used as exception routing criteria for the specified exception route.

**Range:** **16383**

**:ilsn=** (optional)

Incoming Link Set Name. This parameter contains the name of the originating linkset. The parameter value is used as part of the exception routing criteria for the specified exception route.

**Range:** *ayyyyyyyyy*

1 alphabetic character followed by up to 9 alphanumeric characters.

**:lsn=** (optional)

Linkset Name. This parameter provides the name of the linkset associated with the specified exception route.

**Range:** *ayyyyyyyyy*

1 alphabetic character followed by up to 9 alphanumeric characters.

**:opc=** (optional)

ANSI origination point code with subfields *network indicator-network-cluster-network cluster member (ni-nc-ncm)*. The *prefix* subfield indicates a private point code (*prefix-ni-nc-ncm*).

**Range:** **p-, 000-255**

Specify a valid value for each subfield of the point code, and separate the subfields with a dash (-).

*prefix*—**p-**

When **chg-sid:pctype=ansi** is specified, *ni = 000* is not valid.

When **chg-sid:pctype=ansi** is specified, *nc = 000* is not valid if *ni = 001-005*.

When **chg-sid:pctype=ansi** is specified, *nc = 000* is valid if *ni = 006-255*.

The point code **000-000-000** is not a valid point code.

**:opci=** (optional)

ITU international point code with subfields *zone-area-id*. The *prefix* subfield indicates a spare point code, private point code, or private and spare point code (*prefix-zone-area-id*).

**Range:** **s-, p-, ps-, 0-255**

Specify a valid value for each subfield of the point code, and separate the subfields with a dash (-).

*prefix*—**s-, p-, ps-**

*zone*—**0-7**

*area*—**000-255**

*id*—**0-7**

The point code **0-000-0** is not a valid point code.

**:opcn=** (optional)

ITU national point code in the format of a 5-digit number (*nnnnn*); or 2, 3, or 4 numbers (members) separated by dashes (*m1-m2-m3-m4*) as defined by the **chg-stpopts:npcfmti** flexible point code option. A group code must be specified when the ITUDUPPC feature is turned on (*nnnnn-gc*, *m1-m2-m3-m4-gc*). The prefix subfield indicates a spare point code, private point code, or private and spare point code (*prefix-nnnnn*, *prefix-nnnnn-gc*, *prefix-m1-m2-m3-m4*, *prefix-m1-m2-m3-m4-gc*).

**Range:** **s-, p-, ps-, 0-16383, aa-zz**

Specify a valid value for each subfield of the point code, and separate the subfields with a dash (-).

*prefix*—**s-, p-, ps-**

*nnnnn*—**0-16383**

*gc*—**aa-zz**

*m1-m2-m3-m4*—**0-14** for each member; values must sum to 14

**:opcn24=** (optional)

24-bit ITU national point code with subfields *main signaling area-sub signaling area-signaling point* (*msa-ssa-sp*). The *prefix* subfield indicates a private point code (*prefix-msa-ssa-sp*).

**Range:** **p-, 000-255**

Specify a valid value for each subfield of the point code, and separate the subfields with a dash (-).

*prefix*—**p-**

*msa*—**000-255**

*ssa*—**000-255**

*sp*—**000-255**

**:si=** (optional)

Service Indicator. This parameter is used as part of the exception routing criteria for the specified exception route.

**Range:** **3-15**

### Example

```
dlt-rtx:dpca=1-1-1:opc:2-3-3:lsn=1set1
```

```
dlt-rtx:dpca=1-2-1:si=3:lsn=1set2
```

```
dlt-rtx:dpca=1-3-1:ilsn=1set2:lsn=1set3
```

```
dlt-rtx:dpci=2-100-1:ilsn=1set2:lsn=1set4
```

```
dlt-rtx:dpci=2-100-1:si=5:lsn=1set5
```

```
dlt-rtx:dpci=2-100-1:si=6
```

```
dlt-rtx:dpci=2-100-1:opc=8-***
```

### Dependencies

Only one of the **opc**, **ilns**, **cic**, or **si** parameters can be specified for an exception route entry.

If the **ecic** parameter is specified, the **cic** parameter must also be specified.

The **ecic** parameter value cannot be less than the **cic** parameter value.

The Origin-Based MTP Routing feature must be enabled and turned on before this command can be entered.

The linkset name, as defined by the **ilsn** or **lsn** parameter, must exist.

The specified combination of exception route parameter conditions must exist.

The value specified for the destination point code must be a full point code and not a cluster or network point code.

The point code specified by the **dpc**, **dPCA**, **dpci**, **dpcn**, or **dpcn24** parameter must exist in the destination table.

## Output

Delete a specific exception route.

```
dlt-rtx:dPCA=1-3-1:ilsn=1set2:lsn=1set3
stdcfq2b 06-05-19 18:20:11 EST EAGLE 35.0.0
DLT-RTX: MASP A - COMPLTD
```

Delete all exception routes for a specific exception criteria.

```
dlt-rtx:dpci=2-100-2:opc=8-**-*
tekelecstp 08-02-25 10:54:07 EST EAGLE 38.0.0
Command entered at terminal #4.
DLT-RTX: MASP A - COMPLTD
```

;

## dlt-sccp-serv

## Delete SCCP Service

Use this command to remove entries from the SCCP Service table. The command may either remove a PC from a group or remove the entire group.

**Keyword:** dlt-sccp-serv

**Related Commands:** chg-sccp-serv, rtrv-sccp-serv

**Command Class:** Basic

## Parameters

**:serv=** (mandatory)

The name of the service being deleted.

**Range:** gflex, gport

**:all=** (optional)

Deletes all point codes from a service.

**Range:** no, yes

**:pc1=** (optional)

ANSI point code with subfields *network indicator-network cluster-network cluster member (ni-nc-ncm)*.

**Range:** 000-255

Specify a valid value for each subfield of the point code, and separate the subfields with a dash (-).

When **chg-sid:pctype=ansi** is specified, *ni = 000* is not valid.

When **chg-sid:pctype=ansi** is specified, *nc = 000* is not valid if *ni = 001-005*.

When **chg-sid:pctype=ansi** is specified, *nc = 000* is valid if *ni = 006-255*.

The point code **000-000-000** is not a valid point code.



**:pc1/pca1/pci1/pcn1/pcn241=** (optional)

Post GTT-translated point code 1.

**:pc2=** (optional)

ANSI point code with subfields *network indicator-network cluster-network cluster member (ni-nc-ncm)*.

**Synonym:** **pca2**

**Range:** **000-255**

Specify a valid value for each subfield of the point code, and separate the subfields with a dash (-).

When **chg-sid:pctype=ansi** is specified, *ni* = **000** is not valid.

When **chg-sid:pctype=ansi** is specified, *nc* = **000** is not valid if *ni* = **001-005**.

When **chg-sid:pctype=ansi** is specified, *nc* = **000** is valid if *ni* = **006-255**.

The point code **000-000-000** is not a valid point code.

**:pc2/pca2/pci2/pcn2/pcn242=** (optional)

Post GTT-translated point code 2.

**:pc3=** (optional)

ANSI point code with subfields *network indicator-network cluster-network cluster member (ni-nc-ncm)*.

**Synonym:** **pca3**

**Range:** **000-255**

Specify a valid value for each subfield of the point code, and separate the subfields with a dash (-).

When **chg-sid:pctype=ansi** is specified, *ni* = **000** is not valid.

When **chg-sid:pctype=ansi** is specified, *nc* = **000** is not valid if *ni* = **001-005**.

When **chg-sid:pctype=ansi** is specified, *nc* = **000** is valid if *ni* = **006-255**.

The point code **000-000-000** is not a valid point code.

**:pc3/pca3/pci3/pcn3/pcn243=** (optional)

Post GTT-translated point code 3.

**:pc4=** (optional)

ANSI point code with subfields *network indicator-network cluster-network cluster member (ni-nc-ncm)*.

**Range:** **000-255**

Specify a valid value for each subfield of the point code, and separate the subfields with a dash (-).

When **chg-sid:pctype=ansi** is specified, *ni* = **000** is not valid.

When **chg-sid:pctype=ansi** is specified, *nc* = **000** is not valid if *ni* = **001-005**.

When **chg-sid:pctype=ansi** is specified, *nc* = **000** is valid if *ni* = **006-255**.

The point code **000-000-000** is not a valid point code.

**:pc4/pca4/pci4/pcn4/pcn244=** (optional)

Post GTT-translated point code 4.

**:pci1=** (optional)

ITU international point code with subfields *zone-area-id*. The *prefix* subfield indicates a spare point code (*prefix-zone-area-id*).

**Range:** s-, 0-255

Specify a valid value for each subfield of the point code, and separate the subfields with a dash (-).

*prefix*—s-

*zone*—0-7

*area*—000-255

*id*—0-7

The point code **0-000-0** is not a valid point code.

**:pci2=** (optional)

ITU international point code with subfields *zone-area-id*. The *prefix* subfield indicates a spare point code (*prefix-zone-area-id*).

**Range:** s-, 0-255

Specify a valid value for each subfield of the point code, and separate the subfields with a dash (-).

*prefix*—s-

*zone*—0-7

*area*—000-255

*id*—0-7

The point code **0-000-0** is not a valid point code.

**:pci3=** (optional)

ITU international point code with subfields *zone-area-id*. The *prefix* subfield indicates a spare point code (*prefix-zone-area-id*).

**Range:** s-, 0-255

Specify a valid value for each subfield of the point code, and separate the subfields with a dash (-).

*prefix*—s-

*zone*—0-7

*area*—000-255

*id*—0-7

The point code **0-000-0** is not a valid point code.

**:pci4=** (optional)

ITU international point code with subfields *zone-area-id*. The *prefix* subfield indicates a spare point code (*prefix-zone-area-id*).

**Range:** s-, 0-255

Specify a valid value for each subfield of the point code, and separate the subfields with a dash (-).

*prefix*—s-

*zone*—0-7

*area*—000-255

*id*—0-7

The point code **0-000-0** is not a valid point code.

**:pcn1=** (optional)

ITU national point code in the format of a 5-digit number (*nnnnn*); or 2, 3, or 4 numbers (members) separated by dashes (*m1-m2-m3-m4*) as defined by the **chg-stpopts:npfnti** flexible point code option. A group code must be specified when the ITUDUPPC feature is turned on (*nnnnn-gc*, *m1-m2-m3-m4-gc*). The *prefix* subfield indicates a spare point code (*prefix-nnnnn*, *prefix-nnnnn-gc*, *prefix-m1-m2-m3-m4*, *prefix-m1-m2-m3-m4-gc*).

**Range:** **s-, 0-16383, aa-zz**

Specify a valid value for each subfield of the point code, and separate the subfields with a dash (-).

*prefix*—**s-**

*nnnnn*—**0-16383**

*gc*—**aa-zz**

*m1-m2-m3-m4*—**0-14** for each member; values must sum to 14

**:pcn2=** (optional)

ITU national point code in the format of a 5-digit number (*nnnnn*); or 2, 3, or 4 numbers (members) separated by dashes (*m1-m2-m3-m4*) as defined by the **chg-stpopts:npfnti** flexible point code option. A group code must be specified when the ITUDUPPC feature is turned on (*nnnnn-gc*, *m1-m2-m3-m4-gc*). The *prefix* subfield indicates a spare point code (*prefix-nnnnn*, *prefix-nnnnn-gc*, *prefix-m1-m2-m3-m4*, *prefix-m1-m2-m3-m4-gc*).

**Range:** **s-, 0-16383, aa-zz**

Specify a valid value for each subfield of the point code, and separate the subfields with a dash (-).

*prefix*—**s-**

*nnnnn*—**0-16383**

*gc*—**aa-zz**

*m1-m2-m3-m4*—**0-14** for each member; values must sum to 14

**:pcn241=** (optional)

24-bit ITU national point code with subfields *main signaling area-sub signaling area-signaling point* (*msa-ssa-sp*).

**Range:** **000-255**

Specify a valid value for each subfield of the point code, and separate the subfields with a dash (-).

*msa*—**000-255**

*ssa*—**000-255**

*sp*—**000-255**

**:pcn242=** (optional)

24-bit ITU national point code with subfields *main signaling area-sub signaling area-signaling point* (*msa-ssa-sp*).

**Range:** **000-255**

Specify a valid value for each subfield of the point code, and separate the subfields with a dash (-).

*msa*—**000-255**

*ssa*—**000-255**

*sp*—**000-255**

**:pcn243=** (optional)

24-bit ITU national point code with subfields *main signaling area-sub signaling area-signaling point (msa-ssa-sp)*.

**Range:**     **000-255**

Specify a valid value for each subfield of the point code, and separate the subfields with a dash (-).

*msa*—**000-255**

*ssa*—**000-255**

*sp*—**000-255**

**:pcn244=** (optional)

24-bit ITU national point code with subfields *main signaling area-sub signaling area-signaling point (msa-ssa-sp)*.

**Range:**     **000-255**

Specify a valid value for each subfield of the point code, and separate the subfields with a dash (-).

*msa*—**000-255**

*ssa*—**000-255**

*sp*—**000-255**

**:pcn3=** (optional)

ITU national point code in the format of a 5-digit number (*nnnnn*); or 2, 3, or 4 numbers (members) separated by dashes (*m1-m2-m3-m4*) as defined by the **chg-stpopts:npcfmti** flexible point code option. A group code must be specified when the ITUDUPPC feature is turned on (*nnnnn-gc*, *m1-m2-m3-m4-gc*). The *prefix* subfield indicates a spare point code (*prefix-nnnnn*, *prefix-nnnnn-gc*, *prefix-m1-m2-m3-m4*, *prefix-m1-m2-m3-m4-gc*).

**Range:**     **s-, 0-16383, aa-zz**

Specify a valid value for each subfield of the point code, and separate the subfields with a dash (-).

*prefix*—**s-**

*nnnnn*—**0-16383**

*gc*—**aa-zz**

*m1-m2-m3-m4*—**0-14** for each member; values must sum to 14

**:pcn4=** (optional)

ITU national point code in the format of a 5-digit number (*nnnnn*); or 2, 3, or 4 numbers (members) separated by dashes (*m1-m2-m3-m4*) as defined by the **chg-stpopts:npcfmti** flexible point code option. A group code must be specified when the ITUDUPPC feature is turned on (*nnnnn-gc*, *m1-m2-m3-m4-gc*). The *prefix* subfield indicates a spare point code (*prefix-nnnnn*, *prefix-nnnnn-gc*, *prefix-m1-m2-m3-m4*, *prefix-m1-m2-m3-m4-gc*).

**Range:**     **s-, 0-16383, aa-zz**

Specify a valid value for each subfield of the point code, and separate the subfields with a dash (-).

*prefix*—**s-**

*nnnnn*—**0-16383**

*gc*—**aa-zz**

*m1-m2-m3-m4*—**0-14** for each member; values must sum to 14

**Example**

To delete a specified PC from the G-Port service:

```
dlt-sccp-serv: serv=gport :pca2=3-3-3
```

To delete all PCs from the G-Port service and to specify a network PC to delete:

```
dlt-sccp-serv: serv=gport :all=yes :pca1=1-1-1
```

**Dependencies**

At least one PC must be specified.

The specified PC must already exist in the SCCP Service table.

The same point code cannot be specified more than once.

The specified point code must already exist in the specified MRN set in the SCCP-SERV table.

At least one point code must be specified.

The specified MRN set must already exist in the SCCP-SERV table portion of the MRN table.

**Notes**

In this command, only ITU-international and ITU national point codes support the spare point code subtype prefix (s-).

**Output**

```
dlt-sccp-serv: serv=gport :pca2=3-3-3
tekelecstp 05-12-20 08:54:59 EST EAGLE 35.0.0
DLT-SCCP-SRV: MASP A - COMPLTD
;
```

**dlt-scr-aftpc****Delete Allowed Affected Point Code**

Use this command to remove a specific screening reference in the allowed affected point code category.

**Keyword:** **dlt-scr-aftpc**

**Related Commands:** **chg-scr-aftpc, ent-scr-aftpc, rtrv-scr-aftpc**

**Command Class:** Database Administration

**Parameters**

**:sr=** (mandatory)

Screening reference. This parameter specifies the point code's unique screening reference name.

**Range:** *ayyy*

1 alphabetic character followed by up to 3 alphanumeric characters

**:ssn=** (mandatory)

The subsystem number. An asterisk (\*) indicates the full range of values from **1-255**.

**Range:** **1-255 \***

**:area=** (optional)

The ITU international area. The area is specified in the point code. The format of the point code is *zone-area-id*. An asterisk (\*) indicates the full range of values from **000-255**.

**Range:** **000-255 \***

**:id=** (optional)

The ITU international ID. The parameter specifies the ID in the point code represented by format *zone-area-id*. An asterisk (\*) indicates the full range of values from **0-7**.

**Range:** 0-7, \*

**:msa=** (optional)

The 24-bit ITU-national main signaling area (*msa*) value. It specifies the *msa* of the point code *msa-ssa-sp*. An asterisk (\*) indicates the full range of values from **000-255**.

**Range:** 000-255 \*

**:nc=** (optional)

The network cluster (*nc*) value. This parameter specifies one or more *nc* values for the network indicator (*ni*) and network cluster member (*ncm*) values specified in the **ni** and **ncm** parameters. It specifies the *nc* of the point code represented by *ni-nc-ncm*. You can specify a single value or a range of values. An asterisk (\*) indicates the full range of values from **000-255**.

**Range:** 000-255 \*

**:ncm=** (optional)

The network cluster member (*ncm*) value. This parameter specifies one or more **ncm** values for the network indicator (*ni*) and network cluster (*nc*) values identified in the **ni** and **nc** parameters. It specifies the *ncm* of the point code represented by *ni-nc-ncm*. You can specify a single value or a range of values. An asterisk (\*) indicates the full range of values from **000-255**.

**Range:** 0-255 \*

**:ni=** (optional)

The network indicator (*ni*) value. This parameter specifies one or more *ni* values for the network cluster (*nc*) and network cluster member (*ncm*) values identified in the **nc** and **ncm** parameters. It specifies the *ni* of the point code represented by *ni-nc-ncm*. You can specify a single value or a range of values. An asterisk (\*) indicates the full range of values from **000-255**.

**Range:** 0-255 \*

**:npc=** (optional)

The ITU national point code. An asterisk (\*) indicates the full range of values from **00000-16383**.

**NOTE: Gateway screening allows the ITU national point code to be displayed and entered in the database only as a single number. If you are using multiple-part ITU national point codes, see "Converting ITU National Point Code Formats" in Appendix A for information on converting the point code format.**

**Range:** 00000-16383 \*

**:pct=** (optional)

Point code subtype. This parameter indicates whether the specified ITU international or ITU national point code has no subtype prefix or has the spare point code prefix (s-).

**Range:** none, s

**Default:** none

**:sp=** (optional)

The 24-bit ITU national signaling point. This parameter specifies the signaling point (*sp*) in the point code represented by *msa-ssa-sp*. An asterisk (\*) indicates the full range of values from **000-255**.

**Range:** 000-255 \*

**:ssa=** (optional)

The 24-bit ITU national sub signaling area. This parameter specifies the sub signaling area (*ssa*) in the point code represented by the format *msa-ssa-sp*. An asterisk (\*) indicates the full range of values from **000-255**.

**Range:** 000-255 \*

**:zone=** (optional)

The ITU international zone. The parameter specifies the zone in the point code represented by format *zone-area-id*. An asterisk (\*) indicates the full range of values from **0-7**.

**Range:** 0-7,\*

### Example

```
dlt-scr-aftpc:sr=iec:ni=240:nc=010:ncm=010:ssn=012
```

```
dlt-scr-aftpc:sr=aft1:zone=1:area=2:id=3:ssn=1:pcst=s
```

### Dependencies

A complete point code must be specified, and must be one, and only one of the four point code parameter combinations: **ni-nc-ncm**; **zone-area-id**; **msa-ssa-sp**; or **npc**.

The affected point code or point code range (given by **ni-nc-ncm/ssn** or **zone-area-id** or **msa-ssa-sp** or **npc**) to be removed from the table must already exist in the screening reference.

ANSI point code value **000-000-000** and ITU-International point code value **0-000-0** are not allowed.

If asterisk values are specified, the range cannot overlap or contain any of the point code ranges that already exist in the allowed affected point code screening category.

If **zone=\*** is specified, **area=\*** and **id=\*** must be specified.

If **area=\*** is specified, **id=\*** must be specified.

If **ssa=\*** is specified, **sp=\*** must be specified.

If **msa=\*** is specified, **ssa=\*** and **sp=\*** must be specified.

If the **nc** parameter is specified as a range, the **ncm** parameter must be specified as an asterisk or as the full range **000-255**.

If the **nc** parameter is specified as a single value or a range, a single value must be specified for the **ni** parameter.

If the **nc** parameter is specified as an asterisk (**nc=\***), the **ncm** parameter must be specified as an asterisk or as the full range **000-255**.

If the **ncm** parameter is specified as a single value, or a range other than the full range of **000-255**, the **ni** and the **nc** parameters must be specified with a single value.

If the **ni** parameter is specified as an asterisk (**ni=\***) or as a range, the **nc** and **ncm** parameters must be specified as an asterisk or as the full range **000-255**.

The character **c** is not a valid value for the **ni**, **nc**, **ncm**, **zone**, **area**, **id**, **msa**, **ssa**, **sp**, and **npc** parameters.

The specified screening reference (**sr**) must already exist in the database.

The Spare Point Code Support feature must be enabled before the **pcst** parameter can be specified.

The spare point code subtype prefix (**s-**) is not supported for ANSI point codes (parameters **ni**, **nc**, **ncm**) or for 24-bit ITU national point codes (parameters **msa**, **ssa**, **sp**). The **pcst** parameter cannot be specified for ANSI and ITU-N24 point codes.

No AFTPC screening reference (**sr**) can be deleted that is referenced by an entity in another screening set.

You cannot remove the **sr**, **ni**, **nc**, **ncm**, and **ssn** parameters, or the **zone**, **area**, **id** and **npc** parameters, if they are the last entry in the screening reference and the screening reference is part of a screen set.

If only one entry exists, the **sr** must not be referenced by another screening table. If the **sr** is not referenced by another screening table, the entire screening table is deleted.

### Notes

The asterisk is a parameter value indicating that the gateway screening process is screening all values for that parameter in the MSU. The asterisk parameter value does not mean that multiple entries whose values may be in the range implied by the asterisk will be removed. The only entry that will

be removed by this command when the asterisk is specified as a parameter value is the entry that contains an asterisk as that parameter value.

For example, if the **dlt-scr-aftpc:sr=ied:ni=240:nc=010:nccm=":ssn=\*** command is entered, the only entry that will be removed from the database is the entry in screening reference **ied** that contains the values **ni=240**, **nc=010**, **ncm=\***, and **ssn=\***. For an entry to be specified in this command with asterisks as parameter values, that entry must be shown in the **rtrv-scr-aftpc** output with asterisks as the same parameter values specified in the **dlt-scr-aftpc** command.

A range of values is specified by separating the values that define the range by two ampersands (**&&**); for example, **ni=025&&100** specifies all network indicators for ANSI point codes from **25** to **100**.

The spare point code subtype prefix **s-** is supported only for ITU international and ITU national point codes. The **pcst** parameter indicates whether the specified point code has no subtype prefix or has the spare point code prefix.

## Output

```
dlt-scr-aftpc:sr=ied:ni=240:nc=010:nccm=010:ssn=012
r1ghncxa03w 04-01-07 11:43:04 EST EAGLE 31.3.0
DLT-SCR-AFTPC: SCREEN SET AFFECTED - IEC 25% FULL
DLT-SCR-AFTPC: MASP A - COMPLTD
;
```

### Legend

**DLT-SCR-AFTPC**—The command entered that caused this output. This is echoed to the printer as a reference.

**SCREEN SET AFFECTED**—Identifies the screen set that was affected by the command. The screen set name is shown

**% FULL**—Indicates the relative size of the screen set.

## dlt-scr-blkdpc

## Delete Blocked DPC

Use this command to remove a specific screening reference from the blocked DPC category. Deleting the last point code (**c-c-c**) also deletes the screening reference.

**Keyword:** **dlt-scr-blkdpc**

**Related Commands:** **chg-scr-blkdpc**, **ent-scr-blkdpc**, **rtrv-scr-blkdpc**

**Command Class:** Database Administration

## Parameters

**:sr=** (mandatory)

Screening reference. This parameter specifies the point code's unique screening reference name.

**Range:** *ayyy*

1 alphabetic character followed by up to 3 alphanumeric characters

**:area=** (optional)

The ITU international area. The area is specified in the point code. The format of the point code is *zone-area-id*. An asterisk (\*) indicates the full range of values from **000–255**.

**Range:** **000-255** \*, C

**:id=** (optional)

The ITU international ID. The parameter specifies the ID in the point code represented by format *zone-area-id*. An asterisk (\*) indicates the full range of values from **0–7**.

**Range:** **0-7** \*, C



**:msa=** (optional)

The 24-bit ITU-national main signaling area (*msa*) value. It specifies the *msa* of the point code represented by *msa-ssa-spt*. An asterisk (\*) indicates the full range of values from **000-255**.

**Range:** **000-255** \*, C

**:nc=** (optional)

The network cluster (*nc*) value. This parameter specifies one or more *nc* values for the network indicator (*ni*) and network cluster member (*ncm*) values specified in the **ni** and **ncm** parameters. It specifies the *nc* of the point code represented by *ni-nc-ncm*. You can specify a single value or a range of values. An asterisk (\*) indicates the full range of values from **000-255**.

**Range:** **000-255** \*, C

**:ncm=** (optional)

The network cluster member (*ncm*) value. This parameter specifies one or more *ncm* values for the network indicator (*ni*) and network cluster (*nc*) values identified in the **ni** and **nc** parameters. It specifies the *ncm* of the point code represented by *ni-nc-ncm*. You can specify a single value or a range of values. An asterisk (\*) indicates the full range of values from **000-255**.

**Range:** **0-255** \*, C

**:ni=** (optional)

The network indicator (*ni*) value. This parameter specifies one or more *ni* values for the network cluster (*nc*) and network cluster member (*ncm*) values identified in the **nc** and **ncm** parameters. It specifies the *ni* of the point code represented by *ni-nc-ncm*. You can specify a single value or a range of values. An asterisk (\*) indicates the full range of values from **000-255**.

**Range:** **0-255** \*, C

**:npc=** (optional)

The ITU national point code. An asterisk (\*) indicates the full range of values from **00000-16383**.

**NOTE: Gateway screening allows the ITU national point code to be displayed and entered in the database only as a single number. If you are using multiple-part ITU national point codes, see "Converting ITU National Point Code Formats" in Appendix A for information on converting the point code format.**

**Range:** **00000-16383** \*, C

**:pct=** (optional)

Point code subtype. This parameter indicates whether the specified ITU international or ITU national point code has no subtype prefix or has the spare point code prefix (s-).

**Range:** **none, s**

**Default:** **none**

**:sp=** (optional)

The 24-bit ITU national signaling point. This parameter specifies the signaling point (*sp*) in the point code represented by *msa-ssa-spt*. An asterisk (\*) indicates the full range of values from **000-255**.

**Range:** **000-255** \*, C

**:ssa=** (optional)

The 24-bit ITU national sub signaling area. This parameter specifies the sub signaling area (*ssa*) in the point code represented by the format *msa-ssa-spt*. An asterisk (\*) indicates the full range of values from **000-255**.

**Range:** **000-255** \*, C

**:zone=** (optional)

The ITU international zone. The parameter specifies the zone in the point code represented by format *zone-area-id*. An asterisk (\*) indicates the full range of values from **0-7**.

**Range:** **0-7** \*, C

**Example**

```
dlt-scr-blkdpc:sr=iec:ni=240:nc=010:ncm=010
```

```
dlt-scr-blkdpc:sr=bdp1:npc=128:pcst=s
```

**Dependencies**

At least one optional parameter must be specified.

A complete point code must be specified, using the **ni-nc-ncm**, **zone-area-id**, **msa-ssa-sp**, or **npc** combination unless a value of **c** for “continue” is specified.

The blocked DPC or blocked DPC range specified by **ni-nc-ncm**; **zone-area-id**; **msa-ssa-sp**; or the **npc** parameter must already exist in the specified screening reference.

The point code to delete cannot have the value **c-c-c** if there is another point code in the blocked screen reference. The last screen reference to be deleted must have **ni**, **zone**, **msa**, or **npc** equal to **c**.

ANSI point code value **000-000-000** and ITU-International point code value **0-000-0** are not allowed.

If **msa=\*** is specified, **ssa=\*** and **sp=\*** must be specified.

If the **msa=c** parameter is specified, then the **ssa** and the **sp** parameters must have a value of **c** or must not be specified. If the **msa=c** parameter is specified, and the **ssa** and the **sp** parameters are not specified, then the **ssa** and **sp** parameters default to a value of **c**.

If the **nc** parameter is specified as a range, the **ncm** parameter must be specified as an asterisk or as the full range **000-255**.

If the **nc** parameter is specified as a single value or a range, a single value must be specified for the **ni** parameter.

If the **nc** parameter is specified as an asterisk (**nc=\***), the **ncm** parameter must be specified as an asterisk or as the full range **000-255**.

If the **ncm** parameter is specified as a single value, or a range other than the full range of **000-255**, the **ni** and the **nc** parameters must be specified with a single value.

If the **ni** parameter is specified as an asterisk (**ni=\***) or as a range, the **nc** and **ncm** parameters must be specified as an asterisk or as the full range **000-255**.

If the **ni=c** parameter is specified, then the **nc** and the **ncm** parameters must have a value of **c** or must not be specified. If the **ni=c** parameter is specified, and the **nc** and the **ncm** parameters are not specified, then the **nc** and **ncm** parameters default to a value of **c**.

The last screening reference (**sr**) entry cannot be deleted if it is referenced by another screen.

The Spare Point Code Support feature must be enabled before the **pcst** parameter can be specified.

The spare point code subtype prefix (**s-**) is not supported for ANSI point codes (parameters **ni**, **nc**, **ncm**) or for 24-bit ITU national point codes (parameters **msa**, **ssa**, **sp**). The **pcst** parameter cannot be specified for ANSI and ITU-N24 point codes.

If the **zone=c** parameter is specified, then the **area** and the **id** parameters must have a value of **c** or must not be specified. If the **zone=c** parameter is specified, and the **area** and the **id** parameters are not specified, then the **area** and **id** parameters default to a value of **c**.

**Notes**

If the screening reference is not referenced by any other screen, and if all entries are removed, the entire screening reference can be removed using **ni-nc-ncm**, **zone-area-id**, or **msa-ssa-sp** equal to **c-c-c** or **npc=c**. If more than one entry exists, **ni-nc-ncm**, **zone-area-id**, **msa-ssa-sp**, or **npc** must not equal **c**.

The asterisk is a parameter value indicating that the gateway screening process is screening all values for that parameter in the MSU. The asterisk parameter value does not mean that multiple entries whose values may be in the range implied by the asterisk will be removed. The only entry that will be removed by this command when the asterisk is specified as a parameter value is the entry that contains an asterisk as that parameter value.

For example, if the **dlt-scr-blkdpc:sr=ied:ni=240:nc=010:nccm=":ssn=\*** command is entered, the only entry that will be removed from the database is the entry in screening reference **iec** that contains the values **ni=240**, **nc=010**, **ncm=\***, and **ssn=\***. For an entry to be specified in this command with asterisks as parameter values, that entry must be shown in the **rtrv-scr-blkdpc** output with asterisks as the same parameter values specified in the **dlt-scr-blkdpc** command.

The asterisk (\*) value cannot be specified with the character **c**. For example, a point code **c-c-\*** is not allowed.

A range of values is specified by separating the values that define the range by two ampersands (&&); for example, **ni=025&&100** specifies all network indicators for ANSI point codes from **25** to **100**.

The character **c** is used in the blocked DPC screens to allow the screening process to continue for messages with point codes that do not match any point codes in the blocked DPC screens. When screening for a blocked DPC and the point code being screened does not match any of the point codes in the blocked DPC screens, the message is not rejected and the screening process continues.

There must be an entry in each unique blocked DPC screening reference to allow the screening process to continue. This entry consists of a screening reference, point code, **nsfi**, and **nsr**. The point code is in the form of subfields *ni-nc-ncm*, *zone-area-id*, or *msa-ssa-sp* equal to **c-c-c** or **npc=c**. When the character **c** is specified, the **nsfi** and **nsr** parameters must be specified.

When the point code does not match any entries in the blocked DPC screens, the screening process is directed to the screening reference with the point code **c-c-c**. The **nsfi** and **nsr** in this entry are examined to determine the next step in the screening process.

The spare point code subtype prefix **s-** is supported only for ITU international and ITU national point codes. The **pcst** parameter indicates whether the specified point code has no subtype prefix or has the spare point code prefix.

## Output

```
dlt-scr-blkdpc:sr=iec:ni=240:nc=010:ncm=010
rlghncxa03w 04-01-07 11:43:04 EST EAGLE 31.3.0
DLT-SCR-BLKDPC: SCREEN SET AFFECTED - IEC 25% FULL
DLT-SCR-BLKDPC: MASP A - COMPLTD
;
```

### Legend

**DLT-SCR-BLKDPC**—The command entered that caused this output. This is echoed to the printer as a reference.

**SCREEN SET AFFECTED**—Identifies the screen set that was affected by the command. The screen set name is provided.

**% FULL**—Indicates the relative size of the screen set.

## dlt-scr-blkopc

### Delete Blocked OPC

Use this command to remove a specific screening reference from the blocked OPC category.

**Keyword:** dlt-scr-blkopc

**Related Commands:** chg-scr-blkopc, ent-scr-blkopc, rtrv-scr-blkopc

**Command Class:** Database Administration

## Parameters

**:sr=** (mandatory)

Screening reference. This parameter specifies the point code's unique screening reference name.

**Range:** *ayyy*  
1 alphabetic character followed by up to 3 alphanumeric characters

**:area=** (optional)

The ITU international area. The area is specified in the point code. The format of the point code is *zone-area-id*. An asterisk (\*) indicates the full range of values from **000–255**.

**Range:** **000-255** \*, C

**:id=** (optional)

The ITU international ID. The parameter specifies the ID in the point code represented by format *zone-area-id*. An asterisk (\*) indicates the full range of values from **0–7**.

**Range:** **0-7**, \*

**:msa=** (optional)

The 24-bit ITU-national main signaling area (*msa*) value. It specifies the *msa* of the point code represented by *msa-ssa-spt*. An asterisk (\*) indicates the full range of values from **000–255**.

**Range:** **000-255** \*, C

**:nc=** (optional)

The network cluster (*nc*) value. This parameter specifies one or more *nc* values for the network indicator (*ni*) and network cluster member (*ncm*) values specified in the **ni** and **ncm** parameters. It specifies the *nc* of the point code represented by *ni-nc-ncm*. You can specify a single value or a range of values. An asterisk (\*) indicates the full range of values from **000–255**.

**Range:** **000-255** \*, C

**:ncm=** (optional)

The network cluster member (*ncm*) value. This parameter specifies one or more *ncm* values for the network indicator (*ni*) and network cluster (*nc*) values identified in the **ni** and **nc** parameters. It specifies the *ncm* of the point code represented by *ni-nc-ncm*. You can specify a single value or a range of values. An asterisk (\*) indicates the full range of values from **000–255**.

**Range:** **0-255** \*, C

**:ni=** (optional)

The network indicator (*ni*) value. This parameter specifies one or more *ni* values for the network cluster (*nc*) and network cluster member (*ncm*) values identified in the **nc** and **ncm** parameters. It specifies the *ni* of the point code represented by *ni-nc-ncm*. You can specify a single value or a range of values. An asterisk (\*) indicates the full range of values from **000–255**.

**Range:** **0-255** \*, C

**:npc=** (optional)

The ITU national point code. An asterisk (\*) indicates the full range of values from **00000–16383**.

**NOTE: Gateway screening allows the ITU national point code to be displayed and entered in the database only as a single number. If you are using multiple-part ITU national point codes, see "Converting ITU National Point Code Formats" in Appendix A for information on converting the point code format.**

**Range:** **00000-16383** \*, C

**:pcst=** (optional)

Point code subtype. This parameter indicates whether the specified ITU international or ITU national point code has no subtype prefix or has the spare point code prefix (s-).

**Range:** none, s

**Default:** none

**:sp=** (optional)

The 24-bit ITU national signaling point. This parameter specifies the signaling point (*sp*) in the point code represented by *msa-ssa-sp*. An asterisk (\*) indicates the full range of values from **000-255**.

**Range:** 000-255 \*, C

**:ssa=** (optional)

The 24-bit ITU national sub signaling area. This parameter specifies the sub signaling area (*ssa*) in the point code represented by the format *msa-ssa-sp*. An asterisk (\*) indicates the full range of values from **000-255**.

**Range:** 000-255 \*, C

**:zone=** (optional)

The ITU international zone. The parameter specifies the zone in the point code represented by format *zone-area-id*. An asterisk (\*) indicates the full range of values from **0-7**.

**Range:** 0-7, \*, C

**Example**

```
dlt-scr-blkopc:sr=iec:ni=240:nc=010:ncm=010
```

```
dlt-scr-blkopc:sr=bop1:npc=128:pcst=s
```

**Dependencies**

A complete point code must be specified, using the **ni-nc-ncm**, **zone-area-id**, **msa-ssa-sp**, or **npc** combination unless a value of **c** for “continue” is specified.

The blocked OPC specified by **ni-nc-ncm**; **zone-area-id**; **msa-ssa-sp**; or the **npc** parameter must already exist in the screening reference or within an existing range of OPCs.

The point code to delete cannot have the value **c-c-c** if there is another point code in the blocked screen reference. The last screen reference to be deleted must have **ni**, **zone**, **msa**, or **npc** equal to **c**.

ANSI point code value **000-000-000** and ITU-International point code value **0-000-0** are not allowed.

If the **msa=c** parameter is specified, then the **ssa** and the **sp** parameters must have a value of **c** or must not be specified. If the **msa=c** parameter is specified, and the **ssa** and the **sp** parameters are not specified, then the **ssa** and **sp** parameters default to a value of **c**.

If the **nc** parameter is specified as a range, the **ncm** parameter must be specified as an asterisk or as the full range **000-255**

If the **nc** parameter is specified as a single value or a range, a single value must be specified for the **ni** parameter.

If the **nc** parameter is specified as an asterisk (**nc=\***), the **ncm** parameter must be specified as an asterisk or as the full range **000-255**.

If the **ncm** parameter is specified as a single value, or a range other than the full range of **000-255**, the **ni** and the **nc** parameters must be specified with a single value.

If the **ni** parameter is specified as an asterisk (**ni=\***) or as a range, the **nc** and **ncm** parameters must be specified as an asterisk or as the full range **000-255**.

If the **ni=c** parameter is specified, then the **nc** and the **ncm** parameters must have a value of **c** or must not be specified. If the **ni=c** parameter is specified, and the **nc** and the **ncm** parameters are not specified, then the **nc** and **ncm** parameters default to a value of **c**.

The spare point code subtype prefix (**s-**) is not supported for ANSI point codes (parameters **ni**, **nc**, **ncm**) or for 24-bit ITU national point codes (parameters **msa**, **ssa**, **sp**). The **pcst** parameter cannot be specified for ANSI and ITU-N24 point codes.

The Spare Point Code Support feature must be enabled before the **pcst** and **npcst** parameters can be specified.

The last screening reference (**sr**) entry cannot be deleted if it is referenced by another screen.

If the **zone=c** parameter is specified, then the **area** and the **id** parameters must have a value of **c** or must not be specified. If the **zone=c** parameter is specified, and the **area** and the **id** parameters are not specified, then the **area** and **id** parameters default to a value of **c**.

## Notes

If the screening reference is not referenced by any other screen, and if all entries are removed, the entire screening reference can be removed using **ni-nc-ncm**, **zone-area-id**, or **msa-ssa-sp** equal to **c-c-c** or **npc=c**. If more than one entry exists, **ni-nc-ncm**, **zone-area-id**, **msa-ssa-sp**, or **npc** must not equal **c**.

The asterisk is a parameter value indicating that the gateway screening process is screening all values for that parameter in the MSU. The asterisk parameter value does not mean that multiple entries whose values may be in the range implied by the asterisk will be removed. The only entry that will be removed by this command when the asterisk is specified as a parameter value is the entry that contains an asterisk as that parameter value.

For example, if the **dlt-scr-blkopc:sr=ied:ni=240:nc=010:ncm="":ssn=\*** command is entered, the only entry that will be removed from the database is the entry in screening reference **ied** that contains the values **ni=240**, **nc=010**, **ncm=\***, and **ssn=\***. For an entry to be specified in this command with asterisks as parameter values, that entry must be shown in the **rtrv-scr-blkopc** output with asterisks as the same parameter values specified in the **dlt-scr-blkopc** command.

The asterisk (\*) value cannot be specified with the character **c**. For example, a point code **c-c-\*** is not allowed.

A range of values is specified by separating the values that define the range by two ampersands (&&); for example, **ni=025&&100** specifies all network indicators for ANSI point codes from **25** to **100**.

The character **c** is used in the blocked OPC screens to allow the screening process to continue for messages with point codes that do not match any point codes in the blocked OPC screens. When screening for a blocked OPC and the point code being screened does not match any of the point codes in the blocked DPC screens, the message is not rejected and the screening process continues.

There must be an entry in each unique blocked OPC screening reference to allow the screening process to continue. This entry consists of a screening reference, point code, **nsfi**, and **nsr**. The point code is either **npc=c**, or in the form of subfields *ni-nc-ncm*, *zone-area-id*, or *msa-ssa-sp* equal to **c-c-c**. When the character **c** is specified, the **nsfi** and **nsr** must be specified.

When the point code does not match any entries in the blocked OPC screens, the screening process is directed to the screening reference with the point code **c-c-c**. The **nsfi** and **nsr** in this entry are examined to determine the next step in the screening process.

The spare point code subtype prefix **s-** is supported only for ITU international and ITU national point codes. The **pcst** parameter indicates whether the specified point code has no subtype prefix or has the spare point code prefix.

**Output**

```

dlt-scr-blkopc:sr=iec:ni=240:nc=010:ncm=010
rlghncxa03w 04-01-07 11:43:04 EST EAGLE 31.3.0
DLT-SCR-BLKOPC: SCREEN SET AFFECTED - IEC 25% FULL
DLT-SCR-BLKOPC: MASP A - COMPLTD
;

```

**Legend**

**DLT-SCR-BLKOPC**—The command entered that caused this output. This is echoed to the printer as a reference.

**SCREEN SET AFFECTED**—Identifies the screen set that was affected by the command. The screen set name is shown.

**% FULL**—Indicates the relative size of the screen set.

**dlt-scr-cdpa****Delete Allowed Called Party Address**

Use this command to remove a specific screening reference from the allowed called party address category.

**Keyword:** dlt-scr-cdpa

**Related Commands:** chg-scr-cdpa, ent-scr-cdpa, rtrv-scr-cdpa

**Command Class:** Database Administration

**Parameters**

**:sr=** (mandatory)

Screening reference. This parameter specifies the point code's unique screening reference name.

**Range:** *ayyy*

1 alphabetic character followed by up to 3 alphanumeric characters

**:ssn=** (mandatory)

The subsystem number. An asterisk (\*) indicates the full range of values from **1-255**.

**Range:** **1-255 \***

**:area=** (optional)

The ITU international area. The area is specified in the point code. The format of the point code is *zone-area-id*. An asterisk (\*) indicates the full range of values from **000-255**.

**Range:** **000-255 \*, C**

**:id=** (optional)

The ITU international ID. The parameter specifies the ID in the point code represented by format *zone-area-id*. An asterisk (\*) indicates the full range of values from **0-7**.

**Range:** **0-7, \***

**:msa=** (optional)

The 24-bit ITU national signaling point. This parameter specifies the signaling point (*sp*) in the point code represented by *msa-ssa-sp*. An asterisk (\*) indicates the full range of values from **000-255**.

**Range:** **000-255 \***

**:nc=** (optional)

The network cluster (*nc*) value. This parameter specifies one or more *nc* values for the network indicator (*ni*) and network cluster member (*ncm*) values specified in the **ni** and **ncm** parameters. It specifies the *nc* of the point code represented by *ni-nc-ncm*. You can specify a single value or a range of values. An asterisk (\*) indicates the full range of values from **000-255**.

**Range:** **000-255 \***

**:ncm=** (optional)

The network cluster member (*ncm*) value. This parameter specifies one or more *ncm* values for the network indicator (*ni*) and network cluster (*nc*) values identified in the **ni** and **nc** parameters. It specifies the *ncm* of the point code represented by *ni-nc-ncm*. You can specify a single value or a range of values. An asterisk (\*) indicates the full range of values from **000–255**.

**Range:** 0-255 \*

**:ni=** (optional)

The network indicator (*ni*) value. This parameter specifies one or more *ni* values for the network cluster (*nc*) and network cluster member (*ncm*) values identified in the **nc** and **ncm** parameters. It specifies the *ni* of the point code represented by *ni-nc-ncm*. You can specify a single value or a range of values. An asterisk (\*) indicates the full range of values from **000–255**.

**Range:** 0-255 \*

**:npc=** (optional)

The ITU national point code. An asterisk (\*) indicates the full range of values from **00000–16383**.

**NOTE: Gateway screening allows the ITU national point code to be displayed and entered in the database only as a single number. If you are using multiple-part ITU national point codes, see "Converting ITU National Point Code Formats" in Appendix A for information on converting the point code format.**

**Range:** 00000-16383 \*, C

**:pcst=** (optional)

Point code subtype. This parameter indicates whether the specified ITU international or ITU national point code has no subtype prefix or has the spare point code prefix (s-).

**Range:** none, s

**Default:** none

**:scmgfid=** (optional)

The SCCP management (SCMG) format ID, which consists of a one-octet field and uniquely defines the function and format of each SCMG message. You can specify a single value or a range of values. An asterisk (\*) indicates the full range of values from **1–255**.

**Range:** 1-255 \*

**:sp=** (optional)

The 24-bit ITU national signaling point. This parameter specifies the signaling point (*sp*) in the point code represented by *msa-ssa-sp*. An asterisk (\*) indicates the full range of values from **000–255**.

**Range:** 000-255 \*

**:ssa=** (optional)

The 24-bit ITU national sub signaling area. This parameter specifies the sub signaling area (*ssa*) in the point code represented by the format *msa-ssa-sp*. An asterisk (\*) indicates the full range of values from **000–255**.

**Range:** 000-255 \*

**:zone=** (optional)

The ITU international zone. The parameter specifies the *zone* in the point code represented by format *zone-area-id*. An asterisk (\*) indicates the full range of values from **0–7**.

**Range:** 0-7 \*, C

**Example**

```
dlt-scr-cdpa:sr=iec:ni=240:nc=010:ncm=010:ssn=012
dlt-scr-
cgpa:sr=cgpa:zone=1:area=2:id=3:ssn=1:sccpmt=9:ri=*:pcst=s
```



## Dependencies

A complete point code must be specified, and must be one and only one of the four point code parameter combinations: **ni-nc-ncm**; **zone-area-id**; **msa-ssa-sp**; or **npc**, except in the special case of entering **c** for "continue."

The CDPA point code, **ssn**, and **scmgfid** to be removed must exist in the CDPA entity set.

ANSI point code value **000-000-000** and ITU-International point code value **0-000-0** are not allowed.

If the **nc** parameter is specified as a range, the **ncm** parameter must be specified as an asterisk or as the full range **000-255**

If the **nc** parameter is specified as a single value or a range, a single value must be specified for the **ni** parameter.

If the **nc** parameter is specified as an asterisk (**nc=\***), the **ncm** parameter must be specified as an asterisk or as the full range **000-255**.

If the **ncm** parameter is specified as a single value, or a range other than the full range of **000-255**, the **ni** and the **nc** parameters must be specified with a single value.

If the **ni** parameter is specified as an asterisk (**ni=\***) or as a range, the **nc** and **ncm** parameters must be specified as an asterisk or as the full range **000-255**.

The specified screening reference (**sr**) must already exist in the database.

The Spare Point Code Support feature must be enabled before the **pcst** parameter can be specified.

The spare point code subtype prefix (**s-**) is not supported for ANSI point codes (parameters **ni**, **nc**, **ncm**) or for 24-bit ITU national point codes (parameters **msa**, **ssa**, **sp**). The **pcst** parameter cannot be specified for ANSI and ITU-N24 point codes.

A CDPA screening reference (**sr**) cannot be deleted if it referenced by an entity in another screening set.

If the **ssn** parameter is a value other than **1**, the **scmgfid** parameter cannot be specified.

If the **ssn=1** parameter is specified, the **scmgfid** parameter must be specified.

## Notes

If only one entry exists and is not referenced by another screening table, the entire screening table is removed.

The asterisk is a parameter value indicating that the gateway screening process is screening all values for that parameter in the MSU. The asterisk parameter value does not mean that multiple entries whose values may be in the range implied by the asterisk will be removed. The only entry that will be removed by this command when the asterisk is specified as a parameter value is the entry that contains an asterisk as that parameter value.

For example, if the **dlt-scr-cdpa:sr=ied:ni=240:nc=010:ncm="":ssn=\*** command is entered, the only entry that will be removed from the database is the entry in screening reference **ied** that contains the values **ni=240**, **nc=010**, **ncm=\***, and **ssn=\***. For an entry to be specified in this command with asterisks as parameter values, that entry must be shown in the **rtrv-scr-cdpa** output with asterisks as the same parameter values specified in the **dlt-scr-cdpa** command.

A range of values is specified by separating the values that define the range by two ampersands (**&&**); for example, **:ni=025&&100** specifies all network indicators for ANSI point codes from **25** to **100**.

The spare point code subtype prefix **s-** is supported only for ITU international and ITU national point codes. The **pcst** parameter indicates whether the specified point code has no subtype prefix or has the spare point code prefix.

**Output**

```

dlt-scr-cdpa:sr=iec:ni=240:nc=010:ncm=010:ssn=012
rlghncxa03w 04-01-07 11:43:04 EST EAGLE 31.3.0
DLT-SCR-CDPA: SCREEN SET AFFECTED - IEC 25% FULL
DLT-SCR-CDPA: MASP A - COMPLTD
;

```

**Legend**

**DLT-SCR-CDPA**—The command entered that caused this output. This is echoed to the printer as a reference.

**SCREEN SET AFFECTED**—Identifies the screen set that was affected by the command. The screen set name is shown.

**% FULL**—Indicates the relative size of the screen set.

**dlt-scr-cgpa****Delete Allowed Calling Party Address**

Use this command to remove a specific screening reference from the allowed calling party address category.

**Keyword:** dlt-scr-cgpa

**Related Commands:** chg-scr-cgpa, ent-scr-cgpa, rtrv-scr-cgpa

**Command Class:** Database Administration

**Parameters**

**:ri=** (mandatory)

Routing indicator that provides routing instructions to the receiving signaling point. In gateway screening, messages may be screened based on the value of the routing indicator.

**Range:** dpc, gt, \*

**dpc**— Allow a called party address with a routing indicator value of “DPC/SSN.”

**gt**— Screening stops and gateway screening is bypassed as a forced pass.

**\***— Allow both routing indicator values.

**:sccpmt=** (mandatory)

The SCCP message type. You can specify a single value or a range of values. An asterisk (\*) indicates the full range of values.

**Range:** 9, 10, 17, 18, \*

**9, \***— UDT

**10, \***— UDTS

**17, \***— XUDT

**18, \***— XUDTS

**:sr=** (mandatory)

Screening reference. This parameter specifies the point code's unique screening reference name.

**Range:** ayyy

1 alphabetic character followed by up to 3 alphanumeric characters

**:ssn=** (mandatory)

The subsystem number. An asterisk (\*) indicates the full range of values from **1-255**.

**Range:** 1-255 \*

**:area=** (optional)

The ITU international area. The area is specified in the point code. The format of the point code is *zone-area-id*. An asterisk (\*) indicates the full range of values from **000-255**.

**Range:** 000-255 \*

**:id=** (optional)

The ITU international ID. The parameter specifies the ID in the point code represented by format *zone-area-id*. An asterisk (\*) indicates the full range of values from 0–7.

**Range:** 0-7, \*

**:msa=** (optional)

The 24-bit ITU-national main signaling area (*msa*) value. It specifies the *msa* of the point code represented by *msa-ssa-spt*. An asterisk (\*) indicates the full range of values from 000-255.

**Range:** 000-255 \*

**:nc=** (optional)

The network cluster (*nc*) value. This parameter specifies one or more *nc* values for the network indicator (*ni*) and network cluster member (*ncm*) values specified in the **ni** and **ncm** parameters. It specifies the *nc* of the point code represented by *ni-nc-ncm*. You can specify a single value or a range of values. An asterisk (\*) indicates the full range of values from 000–255.

**Range:** 000-255 \*

**:ncm=** (optional)

The network cluster member (*ncm*) value. This parameter specifies one or more *ncm* values for the network indicator (*ni*) and network cluster (*nc*) values identified in the **ni** and **nc** parameters. It specifies the *ncm* of the point code represented by *ni-nc-ncm*. You can specify a single value or a range of values. An asterisk (\*) indicates the full range of values from 000–255.

**Range:** 0-255 \*

**:ni=** (optional)

The network indicator (*ni*) value. This parameter specifies one or more *ni* values for the network cluster (*nc*) and network cluster member (*ncm*) values identified in the **nc** and **ncm** parameters. It specifies the *ni* of the point code represented by *ni-nc-ncm*. You can specify a single value or a range of values. An asterisk (\*) indicates the full range of values from 000–255.

**Range:** 0-255 \*

**:npc=** (optional)

The ITU national point code. An asterisk (\*) indicates the full range of values from 00000–16383.

**NOTE: Gateway screening allows the ITU national point code to be displayed and entered in the database only as a single number. If you are using multiple-part ITU national point codes, see "Converting ITU National Point Code Formats" in Appendix A for information on converting the point code format.**

**Range:** 00000-16383 \*

**:pcst=** (optional)

Point code subtype. This parameter indicates whether the specified ITU international or ITU national point code has no subtype prefix or has the spare point code prefix (s-).

**Range:** none, s

**Default:** none

**:sp=** (optional)

The 24-bit ITU national signaling point. This parameter specifies the signaling point (*sp*) in the point code represented by *msa-ssa-sp*. An asterisk (\*) indicates the full range of values from 000-255.

**Range:** 000-255 \*

**:ssa=** (optional)

The 24-bit ITU national sub signaling area. This parameter specifies the sub signaling area (*ssa*) in the point code represented by the format *msa-ssa-sp*. An asterisk (\*) indicates the full range of values from 000-255.

**Range:** 000-255 \*

**:zone=** (optional)

The ITU international zone. The parameter specifies the zone in the point code represented by format *zone-area-id*. An asterisk (\*) indicates the full range of values from 0–7.

**Range:** 0-7, \*

### Example

```
dlt-scr-cgpa:sr=iec:ni=240:nc=010:ncm=010:ssn=012
```

```
dlt-scr-cgpa:sr=cdp1:ni=5:nc=5:ncm=5:ssn=1:ri=dpc:sccpmt=009
```

```
dlt-scr-
```

```
cgpa:sr=cgpa:zone=1:area=2:id=3:ssn=1:sccpmt=9:ri=*:pcst=s
```

### Dependencies

A complete point code must be specified, and must be one, and only one of the four point code parameter combinations: **ni-nc-ncm**; **zone-area-id**; **msa-ssa-sp** ; or **npc**.

ANSI point code value **000-000-000** and ITU-International point code value **0-000-0** are not allowed.

The CGPA point code, **ri**, **ssn**, and **sccpmt** to be removed must exist in the CGPA entity set.

If the **nc** parameter is specified as a range, the **ncm** parameter must be specified as an asterisk or as the full range **000–255**

If the **nc** parameter is specified as a single value or a range, a single value must be specified for the **ni** parameter.

If the **nc** parameter is specified as an asterisk (**nc=\***), the **ncm** parameter must be specified as an asterisk or as the full range **000–255**.

If the **ncm** parameter is specified as a single value, or a range other than the full range of **000–255**, the **ni** and the **nc** parameters must be specified with a single value.

If the **ni** parameter is specified as an asterisk (**ni=\***) or as a range, the **nc** and **ncm** parameters must be specified as an asterisk or as the full range **000–255**.

The specified screening reference (**sr**) must already exist in the database.

The Spare Point Code Support feature must be enabled before the **pcst** parameter can be specified.

The spare point code subtype prefix (**s-**) is not supported for ANSI point codes (parameters **ni**, **nc**, **ncm**) or for 24-bit ITU national point codes (parameters **msa**, **ssa**, **sp**). The **pcst** parameter cannot be specified for ANSI and ITU-N24 point codes.

A CGPA screening reference (**sr**) cannot be deleted if it is referenced by an entity in another screening set.

### Notes

The asterisk is a parameter value indicating that the gateway screening process is screening all values for that parameter in the MSU. The asterisk parameter value does not mean that multiple entries whose values may be in the range implied by the asterisk will be removed. The only entry that will be removed by this command when the asterisk is specified as a parameter value is the entry that contains an asterisk as that parameter value.

For example, if the **dlt-scr-cgpa:sr=ied:ni=240:nc=010:ncm="":ssn=\*** command is entered, the only entry that will be removed from the database is the entry in screening reference **ied** that contains the values **ni=240**, **nc=010**, **ncm=\***, and **ssn=\***. For an entry to be specified in this command with asterisks as parameter values, that entry must be shown in the **rtrv-scr-cgpa** output with asterisks as the same parameter values specified in the **dlt-scr-cgpa** command.

A range of values is specified by separating the values that define the range by two ampersands (&&); for example, **:ni=025&&100** specifies all network indicators for ANSI point codes from **25** to **100**.

The routing indicator in the calling party address provides routing instructions for the receiving signaling point. When the routing indicator specifies global title, the message is routed based on the global title digits. If the routing indicator specifies DPC, the message is routed based on the DPC/subsystem number in the calling party address.

The spare point code subtype prefix **s-** is supported only for ITU international and ITU national point codes. The **pcst** parameter indicates whether the specified point code has no subtype prefix or has the spare point code prefix.

## Output

```
dlt-scr-cgpa:sr=iec:ni=240:nc=010:ncm=010:ssn=012
rlghncxa03w 04-01-07 11:43:04 EST EAGLE 31.3.0
DLT-SCR-CGPA: SCREEN SET AFFECTED - IEC 25% FULL
DLT-SCR-CGPA: MASP A - COMPLTD
;
```

### Legend

**DLT-SCR-CGPA**—The command entered that caused this output. This is echoed to the printer as a reference.

**SCREEN SET AFFECTED**—Identifies the screen set that was affected by the command. The screen set name is provided (such as IEC).

**% FULL**—Indicates the relative size of the screen set.

## dlt-scr-destfld

### Delete an Allowed DESTFLD

Use this command to remove a specific screening reference from the allowed affected destination field (DESTFLD) category.

**Keyword:** **dlt-scr-destfld**

**Related Commands:** **chg-scr-destfld**, **ent-scr-destfld**, **rtrv-scr-destfld**

**Command Class:** Database Administration

### Parameters

**:sr=** (mandatory)

Screening reference. This parameter specifies the point code's unique screening reference name.

**Range:** *ayyy*

1 alphabetic character followed by up to 3 alphanumeric characters

**:area=** (optional)

The ITU international area. The area is specified in the point code. The format of the point code is *zone-area-id*. An asterisk (\*) indicates the full range of values from **000-255**.

**Range:** **000-255 \***

**:id=** (optional)

The ITU international ID. The parameter specifies the ID in the point code represented by format *zone-area-id*. An asterisk (\*) indicates the full range of values from **0-7**.

**Range:** **0-7 \***

**:msa=** (optional)

The 24-bit ITU-national main signaling area (*msa*) value. It specifies the *msa* of the point code represented by *msa-ssa-spt*. An asterisk (\*) indicates the full range of values from **000-255**.

**Range:**     **000-255 \***

**:nc=** (optional)

The network cluster (*nc*) value. This parameter specifies one or more *nc* values for the network indicator (*ni*) and network cluster member (*ncm*) values specified in the **ni** and **ncm** parameters. It specifies the *nc* of the point code represented by *ni-nc-ncm*. A single value or a range of values can be specified. An asterisk (\*) indicates the full range of values from **000-255**.

**Range:**     **000-255 \***

**:ncm=** (optional)

The network cluster member (*ncm*) value. This parameter specifies one or more *ncm* values for the network indicator (*ni*) and network cluster (*nc*) values identified in the **ni** and **nc** parameters. It specifies the *ncm* of the point code represented by *ni-nc-ncm*. A single value or a range of values can be specified. An asterisk (\*) indicates the full range of values from **000-255**.

**Range:**     **0-255 \***

**:ni=** (optional)

The network indicator (*ni*) value. This parameter specifies one or more *ni* values for the network cluster (*nc*) and network cluster member (*ncm*) values identified in the **nc** and **ncm** parameters. It specifies the *ni* of the point code represented by *ni-nc-ncm*. A single value or a range of values can be specified. An asterisk (\*) indicates the full range of values from **000-255**.

**Range:**     **0-255 \***

**:npc=** (optional)

The ITU national point code. An asterisk (\*) indicates the full range of values from **00000-16383**.

**NOTE: Gateway screening allows the ITU national point code to be displayed and entered in the database only as a single number. If you are using multiple-part ITU national point codes, see "Converting ITU National Point Code Formats" in Appendix A for information on converting the point code format.**

**Range:**     **00000-16383 \***

**:pct=** (optional)

Point code subtype. This parameter indicates whether the specified ITU international or ITU national point code has no subtype prefix or has the spare point code prefix (s-).

**Range:**     **none, s**

**Default:**   **none**

**:sp=** (optional)

The 24-bit ITU national signaling point. This parameter specifies the signaling point (*sp*) in the point code represented by *msa-ssa-sp*. An asterisk (\*) indicates the full range of values from **000-255**.

**Range:**     **000-255 \***

**:ssa=** (optional)

The 24-bit ITU national sub signaling area. This parameter specifies the sub signaling area (*ssa*) in the point code represented by the format *msa-ssa-sp*. An asterisk (\*) indicates the full range of values from **000-255**.

**Range:**     **000-255 \***

**:zone=** (optional)

The ITU international zone. The parameter specifies the zone in the point code represented by format *zone-area-id*. An asterisk (\*) indicates the full range of values from **0-7**.

**Range:**     **0-7, \***

**Example**

```
dlt-scr-destfld:sr=iec:ni=240:nc=010:ncm=010
```

```
dlt-scr-destfld:sr=dst1:zone=1:area=2:id=3:pcst=s
```

**Dependencies**

A complete point code must be specified, using the **ni-nc-ncm**, **zone-area-id**, **msa-ssa-sp**, or **npc** combination unless a value of **c** for “continue” is specified.

ANSI point code value **000-000-000** and ITU-International point code value **0-000-0** are not allowed.

If the **zone=\*** parameter is specified, then the **area=\*** and the **id=\*** parameters must be specified.

If the **area=\*** parameter is specified, then the **id=\*** parameter must be specified.

If the **ssa=\*** parameter is specified, then the **sp=\*** parameter must be specified.

If the **msa=\*** parameter is specified, then the **ssa=\*** and the **sp=\*** parameters must be specified.

If the **nc** parameter is specified as a range, the **ncm** parameter must be specified as an asterisk or as the full range **000-255**.

If the **nc** parameter is specified as a single value or a range, a single value must be specified for the **ni** parameter.

If the **nc** parameter is specified as an asterisk (**nc=\***), the **ncm** parameter must be specified as an asterisk or as the full range **000-255**.

If the **ncm** parameter is specified as a single value, or a range other than the full range of **000-255**, the **ni** and the **nc** parameters must be specified with a single value.

If the **ni** parameter is specified as an asterisk (**ni=\***) or as a range, the **nc** and **ncm** parameters must be specified as an asterisk or as the full range **000-255**.

The DESTFLD specified by **ni-nc-ncm**, **zone-area-id**, **msa-ssa-sp**, or the **npc** parameter must already exist in the screening reference.

If only one entry exists, the **sr** must not be referenced by another screening table. If the **sr** is not referenced by another screening table, the entire screening table is deleted.

The Spare Point Code Support feature must be enabled before the **pcst** parameter can be specified.

The spare point code subtype prefix (**s-**) is not supported for ANSI point codes (parameters **ni**, **nc**, **ncm**) or for 24-bit ITU national point codes (parameters **msa**, **ssa**, **sp**). The **pcst** parameter cannot be specified for ANSI and ITU-N24 point codes.

If the **nsfi=fail** parameter is specified, then the **nni**, **nc**, **ncm**, **narea**, **nzone**, **nid**, **nmsa**, **nssa**, **nsp**, and **npc** parameters cannot have a value of **c**.

**Notes**

The asterisk is a parameter value indicating that the gateway screening process is screening all values for that parameter in the MSU. The asterisk parameter value does not mean that multiple entries whose values may be in the range implied by the asterisk will be removed. The only entry that will be removed by this command when the asterisk is specified as a parameter value is the entry that contains an asterisk as that parameter value.

For example, if the **dlt-scr-destfld:sr=ied:ni=240:nc=010:ncm=\*:ssn=\*** command is entered, the only entry that will be removed from the database is the entry in screening reference **ied** that contains the values **ni=240**, **nc=010**, **ncm=\***, and **ssn=\***. For an entry to be specified in this command with asterisks as parameter values, that entry must be shown in the **rtrv-scr-destfld** output with asterisks as the same parameter values specified in the **dlt-scr-destfld** command.

A range of values is specified by separating the values that define the range by two ampersands (&&); for example, **:ni=025&&100** specifies all network indicators for ANSI point codes from **25** to **100**.

The spare point code subtype prefix **s-** is supported only for ITU international and ITU national point codes. The **pcst** parameter indicates whether the specified point code has no subtype prefix or has the spare point code prefix.

### Output

```
dlt-scr-destfld:sr=iec:ni=240:nc=010:ncm=010

rlghncxa03w 04-02-13 11:49:47 EST EAGLE 31.3.0
DLT-SCR-DESTFLD: SCREEN SET AFFECTED - SS01 25% FULL
DLT-SCR-DESTFLD: MASP A - COMPLTD
;
```

## dlt-scr-dpc

### Delete Allowed DPC

Use this command to remove a specific screening reference from the allowed DPC category.

**Keyword:** **dlt-scr-dpc**

**Related Commands:** **chg-scr-dpc**, **ent-scr-dpc**, **rtrv-scr-dpc**

**Command Class:** Database Administration

### Parameters

**:sr=** (mandatory)

Screening reference. This parameter specifies the point code's unique screening reference name.

**Range:** *ayyy*  
1 alphabetic character followed by up to 3 alphanumeric characters

**:area=** (optional)

The ITU international area. The area is specified in the point code. The format of the point code is *zone-area-id*. An asterisk (\*) indicates the full range of values from **000-255**.

**Range:** **000-255 \***

**:id=** (optional)

The ITU international ID. The parameter specifies the ID in the point code represented by format *zone-area-id*. An asterisk (\*) indicates the full range of values from **0-7**.

**Range:** **0-7, \***

**:msa=** (optional)

The 24-bit ITU-national main signaling area (*msa*) value. It specifies the *msa* of the point code represented by *msa-ssa-sp*. An asterisk (\*) indicates the full range of values from **000-255**.

**Range:** **000-255 \***

**:nc=** (optional)

The network cluster (*nc*) value. This parameter specifies one or more *nc* values for the network indicator (*ni*) and network cluster member (*ncm*) values specified in the **ni** and **ncm** parameters. It specifies the *nc* of the point code represented by *ni-nc-ncm*. A single value or a range of values can be specified. An asterisk (\*) indicates the full range of values from **000-255**.

**Range:** **000-255 \***

**:ncm=** (optional)

The network cluster member (*ncm*) value. This parameter specifies one or more *ncm* values for the network indicator (*ni*) and network cluster (*nc*) values identified in the **ni** and **nc** parameters. It



specifies the *ncm* of the point code represented by *ni-nc-ncm*. A single value or a range of values can be specified. An asterisk (\*) indicates the full range of values from **000–255**.

**Range:**     **0-255 \***

**:ni=** (optional)

The network indicator (*ni*) value. This parameter specifies one or more *ni* values for the network cluster (*nc*) and network cluster member (*ncm*) values identified in the **nc** and **ncm** parameters. It specifies the *ni* of the point code represented by *ni-nc-ncm*. A single value or a range of values can be specified. An asterisk (\*) indicates the full range of values from **000–255**.

**Range:**     **0-255 \***

**:npc=** (optional)

The ITU national point code. An asterisk (\*) indicates the full range of values from **00000–16383**.

**NOTE: Gateway screening allows the ITU national point code to be displayed and entered in the database only as a single number. If you are using multiple-part ITU national point codes, see "Converting ITU National Point Code Formats" in Appendix A for information on converting the point code format.**

**Range:**     **00000-16383 \***

**:pcst=** (optional)

Point code subtype. This parameter indicates whether the specified ITU international or ITU national point code has no subtype prefix or has the spare point code prefix (**s-**).

**Range:**     **none, s**

**Default:**   **none**

**:sp=** (optional)

The 24-bit ITU national signaling point. This parameter specifies the signaling point (*sp*) in the point code represented by *msa-ssa-sp*. An asterisk (\*) indicates the full range of values from **000–255**.

**Range:**     **000-255 \***

**:ssa=** (optional)

The 24-bit ITU national sub signaling area. This parameter specifies the sub signaling area (*ssa*) in the point code represented by the format *msa-ssa-sp*. An asterisk (\*) indicates the full range of values from **000–255**.

**Range:**     **000-255 \***

**:zone=** (optional)

The ITU international zone. The parameter specifies the zone in the point code represented by format *zone-area-id*. An asterisk (\*) indicates the full range of values from **0–7**.

**Range:**     **0-7, \***

## Example

```
dlt-scr-dpc:sr=iec:ni=240:nc=010:ncm=010
```

```
dlt-scr-dpc:sr=dpc1:npc=128:pcst=s
```

## Dependencies

A complete point code must be specified, using the **ni-nc-ncm**, **zone-area-id**, **msa-ssa-sp**, or **npc** combination unless a value of **c** for “continue” is specified.

The DPC specified by **ni-nc-ncm**, **zone-area-id**, **msa-ssa-sp**, or the **npc** parameter must already exist in the screening reference or within an existing range of DPCs.

ANSI point code value **000-000-000** and ITU-International point code value **0-000-0** are not allowed.

If the **nc** parameter is specified as a range, the **ncm** parameter must be specified as an asterisk or as the full range **000–255**

If the **nc** parameter is specified as a single value or a range, a single value must be specified for the **ni** parameter.

If the **nc** parameter is specified as an asterisk (**nc=\***), the **ncm** parameter must be specified as an asterisk or as the full range **000–255**.

If the **ncm** parameter is specified as a single value, or a range other than the full range of **000–255**, the **ni** and the **nc** parameters must be specified with a single value.

If the **ni** parameter is specified as an asterisk (**ni=\***) or as a range, the **nc** and **ncm** parameters must be specified as an asterisk or as the full range **000–255**.

If only one entry exists, the **sr** must not be referenced by another screening table. If the **sr** is not referenced by another screening table, the entire screening table is deleted.

The Spare Point Code Support feature must be enabled before the **pcst** parameter can be specified.

The spare point code subtype prefix (**s-**) is not supported for ANSI point codes (parameters **ni**, **nc**, **ncm**) or for 24-bit ITU national point codes (parameters **msa**, **ssa**, **sp**). The **pcst** parameter cannot be specified for ANSI and ITU-N24 point codes.

If the **nsfi=fail** parameter is specified, then the **nmi**, **nc**, **nncm**, **narea**, **nzone**, **nid**, **nmsa**, **nssa**, **nsp**, and **npc** parameters cannot have a value of **c**.

## Notes

The asterisk is a parameter value indicating that the gateway screening process is screening all values for that parameter in the MSU. The asterisk parameter value does not mean that multiple entries whose values may be in the range implied by the asterisk will be removed. The only entry that will be removed by this command when the asterisk is specified as a parameter value is the entry that contains an asterisk as that parameter value.

For example, if the **dlt-scr-dpc:sr=ied:ni=240:nc=010:ncm=":ssn=\*** command is entered, the only entry that will be removed from the database is the entry in screening reference **ied** that contains the values **ni=240**, **nc=010**, **ncm=\***, and **ssn=\***. For an entry to be specified in this command with asterisks as parameter values, that entry must be shown in the **rtrv-scr-dpc** output with asterisks as the same parameter values specified in the **dlt-scr-dpc** command.

A range of values is specified by separating the values that define the range by two ampersands (**&&**); for example, **ni=025&&100** specifies all network indicators for ANSI point codes from **25** to **100**.

The spare point code subtype prefix **s-** is supported only for ITU international and ITU national point codes. The **pcst** parameter indicates whether the specified point code has no subtype prefix or has the spare point code prefix.

## Output

```
dlt-scr-dpc:sr=iec:ni=240:nc=010:ncm=010
  rlgncxa03w 04-01-07 11:43:04 EST EAGLE 31.3.0
  DLT-SCR-DPC: SCREEN SET AFFECTED - IEC 25% FULL
  DLT-SCR-DPC: MASP A - COMPLTD
;
```

## Legend

**DLT-SCR-DPC**—The command entered that caused this output. This is echoed to the printer as a reference.

**SCREEN SET AFFECTED**—Identifies the screen set that was affected by the command. The screen set name is shown.

**% FULL**—Indicates the relative size of the screen set.

**dlt-scr-isup****Delete Allowed ISUP Screening Reference**

Use this command to delete an allowed ISUP screening reference from the Allowed ISUP entity set.

**Keyword:** **dlt-scr-isup**

**Related Commands:** **chg-scr-isup**, **ent-scr-isup**, **rtrv-scr-isup**

**Command Class:** Database Administration

**Parameters**

**:isupmt/tupmt=** (mandatory)

ISUP message type or TUP message type. A single value or a range of values can be specified. An asterisk (\*) indicates the full range of values from **000–255**. The **tupmt** parameter is not valid for SEAS.

**Range:** **000-255**

**:sr=** (mandatory)

Screening reference. This parameter specifies the point code's unique screening reference name.

**Range:** *ayyy*

1 alphabetic character followed by up to 3 alphanumeric characters

**Example**

```
dlt-scr-isup:sr=iec:isupmt=9
```

```
dlt-scr-isup:sr=iec:isupmt=1&&2
```

```
dlt-scr-isup:tupmt=1:sr=tu01
```

**Dependencies**

The specified **sr** must exist in the Allowed ISUP entity set.

The specified **isupmt** parameter or **tupmt** parameter value must already exist in the specified **sr**.

The last entry in the specified **sr** cannot be deleted if the entry is referenced by another screen.

**Notes**

An asterisk can be specified for a parameter value in the **chg-scr-isup** and **dlt-scr-isup** commands *only* if that parameter value was specified as an asterisk in the **ent-scr-isup** command to define the parameter value.

A range of values can be specified for the **isupmt** parameter or **tupmt** parameter, by separating the values that define the range by two ampersands (**&&**); for example, **:isupmt=025&&100** specifies all ISUP message types from **25** to **100**. The value to the left of the **&&** must be less than the value to the right of the **&&** in the range.

**Output**

No screen sets are listed in the following example, because the specified screening reference is not associated with any screen sets.

```
dlt-scr-isup:sr=iec:isupmt=9
tekelecstp 02-09-02 11:59:41 EST EAGLE 30.0.0
DLT-SCR-ISUP: MASP A - COMPLTD
;
```

No screen sets are listed in the following example, because the specified screening reference is not associated with any screen sets.

```
dlt-scr-isup:sr=iec:isupmt=1&&2
tekelecstp 02-09-02 12:00:30 EST EAGLE 30.0.0
DLT-SCR-ISUP: MASP A - COMPLTD
;
```

The following example lists the screen sets that are associated with the specified screening reference.

```
dlt-scr-isup:tupmt=1:sr=tu01
tekelecstp 03-11-02 12:00:30 EST EAGLE 31.3.0
Extended Processing Time Required -- Please Wait
Notice: The number of screensets affected is 2.
DLT-SCR-ISUP: SCREEN SET AFFECTED - ist1 1% FULL
DLT-SCR-ISUP: SCREEN SET AFFECTED - ist2 1% FULL
DLT-SCR-ISUP: MASP A - COMPLTD
;
```

**dlt-scr-opc****Delete Allowed OPC**

Use this command to remove a specific screening reference from the allowed OPC category.

**Keyword:** **dlt-scr-opc**

**Related Commands:** **chg-scr-opc**, **ent-scr-opc**, **rtrv-scr-opc**

**Command Class:** Database Administration

**Parameters**

**:sr=** (mandatory)

Screening reference. This parameter specifies the point code's unique screening reference name.

**Range:** *ayyy*

1 alphabetic character followed by up to 3 alphanumeric characters

**:area=** (optional)

The ITU international area. The area is specified in the point code. The format of the point code is *zone-area-id*. An asterisk (\*) indicates the full range of values from **000-255**.

**Range:** **000-255 \***

**:id=** (optional)

The ITU international ID. The parameter specifies the ID in the point code represented by format *zone-area-id*. An asterisk (\*) indicates the full range of values from **0-7**.

**Range:** **0-7 \***

**:msa=** (optional)

The 24-bit ITU-national main signaling area (*msa*) value. It specifies the *msa* of the point code represented by *msa-ssa-spt*. An asterisk (\*) indicates the full range of values from **000-255**.

**Range:** **000-255 \***

**:nc=** (optional)

The network cluster (*nc*) value. This parameter specifies one or more *nc* values for the network indicator (*ni*) and network cluster member (*ncm*) values specified in the **ni** and **ncm** parameters. It

specifies the *nc* of the point code represented by *ni-nc-ncm*. A single value or a range of values can be specified. An asterisk (\*) indicates the full range of values from **000–255**.

**Range:**     **000-255 \***

**:ncm=** (optional)

The network cluster member (*ncm*) value. This parameter specifies one or more *ncm* values for the network indicator (*ni*) and network cluster (*nc*) values identified in the **ni** and **nc** parameters. It specifies the *ncm* of the point code represented by *ni-nc-ncm*. You can specify a single value or a range of values. An asterisk (\*) indicates the full range of values from **000–255**.

**Range:**     **0-255 \***

**:ni=** (optional)

The network indicator (*ni*) value. This parameter specifies one or more *ni* values for the network cluster (*nc*) and network cluster member (*ncm*) values identified in the **nc** and **ncm** parameters. It specifies the *ni* of the point code represented by *ni-nc-ncm*. A single value or a range of values can be specified. An asterisk (\*) indicates the full range of values from **000–255**.

**Range:**     **0-255 \***

**:npc=** (optional)

The ITU national point code. An asterisk (\*) indicates the full range of values from **00000–16383**. Gateway screening allows the ITU national point code to be displayed and entered in the database only as a single number. If you are using multiple-part ITU national point codes, see "Converting ITU National Point Code Formats" in Appendix A for information on converting the point code format.

**Range:**     **00000-16383 \***

**:pcst=** (optional)

Point code subtype. This parameter indicates whether the specified ITU international or ITU national point code has no subtype prefix or has the spare point code prefix (s-).

**Range:**     **none, s**

**Default:**   **none**

**:sp=** (optional)

The 24-bit ITU national signaling point. This parameter specifies the signaling point (*sp*) in the point code represented by *msa-ssa-sp*. An asterisk (\*) indicates the full range of values from **000–255**.

**Range:**     **000-255 \***

**:ssa=** (optional)

The 24-bit ITU national sub signaling area. This parameter specifies the sub signaling area (*ssa*) in the point code represented by the format *msa-ssa-sp*. An asterisk (\*) indicates the full range of values from **000–255**.

**Range:**     **000-255 \***

**:zone=** (optional)

The ITU international zone. The parameter specifies the zone in the point code represented by format *zone-area-id*. An asterisk (\*) indicates the full range of values from **0–7**.

**Range:**     **0-7, \***

## Example

```
dlt-scr-opc:sr=iec:ni=240:nc=010:ncm=010
```

```
dlt-scr-opc:sr=opc1:npc=128:pcst=s
```

## Dependencies

A complete point code must be specified, using the **ni-nc-ncm**, **zone-area-id**, **msa-ssa-sp**, or **npc** combination unless a value of **c** for “continue” is specified.

The OPC specified by **ni-nc-ncm**; **zone-area-id**, **msa-ssa-sp**, or the **npc** parameter must already exist in the screening reference or within an existing range of OPCs.

ANSI point code value **000-000-000** and ITU-International point code value **0-000-0** are not allowed.

If the **nc** parameter is specified as a range, the **ncm** parameter must be specified as an asterisk or as the full range **000-255**

If the **nc** parameter is specified as a single value or a range, a single value must be specified for the **ni** parameter.

If the **nc** parameter is specified as an asterisk (**nc=\***), the **ncm** parameter must be specified as an asterisk or as the full range **000-255**.

If the **ncm** parameter is specified as a single value, or a range other than the full range of **000-255**, the **ni** and the **nc** parameters must be specified with a single value.

If the **ni** parameter is specified as an asterisk (**ni=\***) or as a range, the **nc** and **ncm** parameters must be specified as an asterisk or as the full range **000-255**.

If only one entry exists, the **sr** must not be referenced by another screening table. If the **sr** is not referenced by another screening table, the entire screening table is deleted.

The Spare Point Code Support feature must be enabled before the **pcst** parameter can be specified.

The spare point code subtype prefix (**s-**) is not supported for ANSI point codes (parameters **ni**, **nc**, **ncm**) or for 24-bit ITU national point codes (parameters **msa**, **ssa**, **sp**). The **pcst** parameter cannot be specified for ANSI and ITU-N24 point codes.

If the **nsfi=fail** parameter is specified, then the **nmi**, **nc**, **ncm**, **narea**, **nzone**, **nid**, **nmsa**, **nssa**, **nsp**, and **npc** parameters cannot have a value of **c**.

## Notes

The asterisk is a parameter value indicating that the gateway screening process is screening all values for that parameter in the MSU. The asterisk parameter value does not mean that multiple entries whose values may be in the range implied by the asterisk will be removed. The only entry that will be removed by this command when the asterisk is specified as a parameter value is the entry that contains an asterisk as that parameter value.

For example, if the **dlt-scr-dpc:sr=ied:ni=240:nc=010:ncm=":ssn=\*** command is entered, the only entry that will be removed from the database is the entry in screening reference **ied** that contains the values **ni=240**, **nc=010**, **ncm=\***, and **ssn=\***. For an entry to be specified in this command with asterisks as parameter values, that entry must be shown in the **rtrv-scr-dpc** output with asterisks as the same parameter values specified in the **dlt-scr-dpc** command.

A range of values is specified by separating the values that define the range by two ampersands (**&&**); for example, **ni=025&&100** specifies all network indicators for ANSI point codes from **25** to **100**.

The spare point code subtype prefix **s-** is supported only for ITU international and ITU national point codes. The **pcst** parameter indicates whether the specified point code has no subtype prefix or has the spare point code prefix.

**Output**

```

dlt-scr-opc:sr=iec:ni=240:nc=010:ncm=010
  rlgncxa03w 04-01-07 11:43:04 EST EAGLE 31.3.0
  DLT-SCR-OPC: SCREEN SET AFFECTED - IEC 25% FULL
  DLT-SCR-OPC: MASP A - COMPLTD
;

```

**Legend**

**DLT-SCR-OPC**—The command entered that caused this output. This is echoed to the printer as a reference.

**SCREEN SET AFFECTED**—Identifies the screen set that was affected by the command. The screen set name is shown.

**% FULL**—Indicates the relative size of the screen set.

**dlt-scr-sio****Delete Allowed SIO**

Use this command to remove a specific screening reference from the allowed service indicator octet (SIO) category.

**Keyword:** **dlt-scr-sio**

**Related Commands:** **chg-scr-sio, ent-scr-sio, rtrv-scr-sio**

**Command Class:** Database Administration

**Parameters**

**:nic=** (mandatory)

The network indicator code identifies whether the message originated from an international (**0**) or national (**2**) network. You can specify a single value or a range of values. An asterisk (\*) indicates the full range of values from **0–3**.

**Range:** **0-3 \***

**:pri=** (mandatory)

New message priority. This parameter specifies the new message priority in the SIO. You can specify a single value or a range of values. An asterisk (\*) indicates the full range of values from **0–3**.

**Range:** **0-3 \***

**Default:** Current value

**:si=** (mandatory)

Service indicator. The service indicator identifies the type of message. The values are defined in Telcordia TR-NWT-000246.

**Range:** **00, 01- 15**

**:sr=** (mandatory)

Screening reference. This parameter specifies the point code's unique screening reference name.

**Range:** *ayyy*

1 alphabetic character followed by up to 3 alphanumeric characters

**:h0=** (optional)

This parameter is mandatory if the service indicator (*si*) value is **00, 01, 02, or 03**. Otherwise, the **h0** parameter is undefined.

**Range:** **0-15 \***

**Default:** Current value or undefined

**:h1=** (optional)

This parameter is mandatory if the service indicator (*si*) value is **00**, **01**, **02**, or **03**. Otherwise, the **h1** parameter is undefined.

**Range:** **0-15 \***

**Default:** Current value or undefined

### Example

```
dlt-scr-sio:sr=iec:nic=1:si=1:h0=4:h1=2:pri=*
```

```
dlt-scr-sio:sr=iec:nic=1:si=3:pri=2
```

### Dependencies

The **nh0** and **nh1** parameters cannot be specified if the **nsi** parameter is specified and is not equal to **00**, **01**, or **02**.

The **sr**, **nic**, **si**, **pri**, and **h0/h1** parameters to be removed must be in the screening reference.

Table 5-40 shows the valid combinations of the **h0/h1** parameter:

**Table 5-40.** Valid Combinations for the **h0/h1** and **nh0/nh1** Parameters (**chg-scr-sio**)

<b>If the h0 (nh0) parameter is specified as:</b>	<b>The h1 (nh1) parameter value can be specified as:</b>
A single value	A single value
A single value	A range
A single value	An asterisk (*) entry
A range	An asterisk (*) entry
An asterisk (*) entry	An asterisk (*) entry

The **sr**, **nic**, **si**, **pri**, and **h0/h1** parameters cannot be removed if they are the last entry in the screening reference and the screening reference is part of a screen set.

If the **si** parameter is equal to **00**, **01**, or **02**, the **h0** and **h1** parameters must be specified. Otherwise, the **h0** parameter cannot be specified.

If the value of the **si** parameter is greater than **2**, then the **h0** and **h1** parameters cannot be specified.

If asterisks or ranges are specified for the heading codes, nothing that matches the combination of **nic**, **si**, and the specified heading codes can already exist in the allowed SIO entity set for the screening reference.

The specified screening reference (**sr**) must already exist in the database.

### Notes

The network identifier specifies whether the message originated from an international (**0**) or a national (**2**) network.

The asterisk is a parameter value indicating that the gateway screening process is screening all values for that parameter in the MSU. The asterisk parameter value does not mean that multiple entries whose values may be in the range implied by the asterisk will be removed. The only entry that will be removed by this command when the asterisk is specified as a parameter value is the entry that contains an asterisk as that parameter value.



For example, if the **dlt-scr-sio:sr=ied:ni=240:nc=010:nccm=":ssn=\*** command is entered, the only entry that will be removed from the database is the entry in screening reference **iec** that contains the values **ni=240**, **nc=010**, **ncm=\***, and **ssn=\***. For an entry to be specified in this command with asterisks as parameter values, that entry must be shown in the **rtrv-scr-sio** output with asterisks as the same parameter values specified in the **dlt-scr-sio** command.

A range of values is specified by separating the values that define the range by two ampersands (**&&**); for example, **ni=025&&100** specifies all network indicators for ANSI point codes from **25** to **100**.

## Output

```
dlt-scr-sio:sr=iec:nic=1:si=3:pri=2
rlghncxa03w 04-02-14 16:45:50 EST EAGLE 31.3.0
DLT-SCR-SIO: SCREEN SET AFFECTED - SS01 25% FULL
DLT-SCR-SIO: SCREEN SET AFFECTED - SS04 35% FULL
DLT-SCR-SIO: MASP A - COMPLTD
;
```

### Legend

**DLT-SCR-SIO**—The command entered that caused this output. This is echoed to the printer as a reference.

**SCREEN SET AFFECTED**—Identifies the screen set that was affected by the command. The screen set name is provided.

**% FULL**—Indicates the relative size of the screen set.

## dlt-scr-tt

## Delete Allowed Translation Type

Use this command to remove a specific screening reference from the allowed translation type category.

**Keyword:** **dlt-scr-tt**

**Related Commands:** **chg-scr-tt**, **ent-scr-tt**, **rtrv-scr-tt**

**Command Class:** Database Administration

### Parameters

**:sr=** (mandatory)

Screening reference. This parameter specifies the point code's unique screening reference name.

**Range:** *ayyy*

1 alphabetic character followed by up to 3 alphanumeric characters

**:type=** (mandatory)

Translation type. The translation type identifies the global title translation type value in the called party address. You can enter a single value or a range of values. An asterisk (\*) indicates the full range of values from **0-255**.

**Range:** **000-255 \***

### Example

```
dlt-scr-tt:sr=iec:type=012
```

### Dependencies

The screening reference must exist.

You cannot remove the **sr** and **type** parameters if they are the last entry in the screening reference and the screening reference is part of a screen set.

The allowed **type** to be removed must already exist in the screening reference.

The single value or range specified for the allowed **type** to be deleted from the TT screen for the allowed TT screening reference must already exist in that TT screen.

### Notes

The asterisk is a parameter value indicating that the gateway screening process is screening all values for that parameter in the MSU. The asterisk parameter value does not mean that multiple entries whose values may be in the range implied by the asterisk will be removed. The only entry that will be removed by this command when the asterisk is specified as a parameter value is the entry that contains an asterisk as that parameter value.

For example, if the **dlt-scr-tt:sr=iec:type=":ssn=\*** command is entered, the only entry that will be removed from the database is the entry in screening reference **iec** that contains an asterisk as the value for the **type** parameter. For an entry to be specified in this command with an asterisk as the value for the **type** parameter, that entry must be shown in the **rtrv-scr-tt** output with an asterisk as the value for the **type** parameter.

### Output

```
dlt-scr-tt:sr=iec:type=012
rlghncxa03w 04-01-07 11:43:04 EST EAGLE 31.3.0
DLT-SCR-TT:  SCREEN SET AFFECTED - IEC 25% FULL
DLT-SCR-TT:  MASP A - COMPLTD
;
```

### Legend

**DLT-SCR-TT**—The command entered that caused this output. This is echoed to the printer as a reference.

**SCREEN SET AFFECTED**—Identifies the screen set that was affected by the command. The screen set name is shown.

**% FULL**—Indicates the relative size of the screen set.

## dlt-scrset

## Delete Screen Set

Use this command to remove a screen set definition from the database. A screen set is a group of screening references that belong to various categories. This command does not remove any gateway screening tables.

**Keyword:** **dlt-scrset**

**Related Commands:** **chg-scrset, ent-scrset, rtrv-scrset**

**Command Class:** Database Administration

### Parameters

**:scrn=** (mandatory)

Screen set name. Each screening reference must have a unique name.

**Range:** *ayyy*

1 alphabetic character followed by up to 3 alphanumeric characters

### Example

```
dlt-scrset:scrn=nc27
```

### Dependencies

The screen set name must exist.

Before the screen set can be removed, it must be removed from all linksets.

### Notes

The system validates the command to ensure that the specified screen set name is in use.

### Output

```
dlt-scrset:scrn=nc27
  rlgncxa03w 04-01-07 11:43:04 EST EAGLE 31.3.0
  DLT-SCRSET: MASP A - COMPLTD
;
```

## dlt-shlf

## Delete Shelf

Use this command to remove a shelf from the system database.

**Keyword:** dlt-shlf

**Related Commands:** ent-shlf, rtrv-shlf

**Command Class:** Database Administration

### Parameters

**:loc=** (mandatory)

The shelf location.

**Range:** 1200, 1300, 2100, 2200, 2300, 3100, 3200, 3300, 4100, 4200, 4300, 5100, 5200, 5300, 6100

### Example

```
dlt-shlf:loc=2300
```

### Dependencies

The equipment shelf must have been configured previously.

The equipment shelf must not have any cards configured for it.

If the equipment shelf is the only provisioned shelf in the frame and a frame power threshold entry is configured in the Frame Power Threshold table for the frame, the shelf cannot be deleted until the frame power threshold entry is deleted from the Frame Power Threshold table.

### Notes

All shelves in the system can be removed, except the control shelf (**1100**).

Before a shelf can be removed from the database, all SS7 signaling links and TCP/IP data links must be deactivated and removed from the database. All TSMs must be placed out of service. All X.25 signaling links, and the X.25 routes assigned to them, must be removed from the database. Then all cards in the shelf must be removed from the database. See the *Database Administration Manual - System Management* for more information on shelf removal.

Refer to the *Installation - EAGLE 5 ISS* manual for an illustration of shelf locations.

### Output

```
dlt-shlf:loc=2300
  rlgncxa03w 04-01-07 11:11:28 EST EAGLE 31.3.0
  DLT-SHLF: MASP A - COMPLTD
;
```

## dlt-slk

## Delete Signaling Link

Use this command to remove a signaling link from the system database.

**Keyword:** dlt-slk

**Related Commands:** act-slk, blk-slk, chg-lsopts, dact-slk, ent-slk, inh-slk, rept-stat-slk, rtrv-slk, tst-slk, ublk-slk, unhb-slk

**Command Class:** Database Administration

## Parameters

**:link=** (mandatory)

Signaling link on the card specified in the **loc** parameter. The links can be specified in any sequence or pattern.

**Synonym:** port

**Range:** a, b, a1-a31, b1-b31

Not all card types support all **link** parameter values.

See Table A-1 for valid **link** parameter range values for each type of card that can have a location specified in the **loc** parameter.

**:loc=** (mandatory)

The card location as stenciled on the shelf of the system.

**Range:** 1101-1108, 1111-1112, 1201-1208, 1211-1218, 1301-1308, 1311-1318, 2101-2108, 2111-2118, 2201-2208, 2211-2218, 2301-2308, 2311-2318, 3101-3108, 3111-3118, 3201-3208, 3211-3218, 3301-3308, 3311-3318, 4101-4108, 4111-4118, 4201-4208, 4211-4218, 4301-4308, 4311-4318, 5101-5108, 5111-5118, 5201-5208, 5211-5218, 5301-5308, 5311-5318, 6101-6108, 6111-6118

**:force=** (optional)

This parameter must be used to remove the last link in a linkset without having to remove all of the routes that referenced the linkset.

**Range:** yes, no

**Default:** no

## Example

```
dlt-slk:loc=1211:link=a
```

```
dlt-slk:loc=1201:link=b:force=yes
```

The following example deletes link a1 from a multi-port LIM, E1/T1 MIM, HC MIM, or E5-E1T1 card at card location 1205:

```
dlt-slk:loc=1205:link=a1
```

## Dependencies

Card locations **1113** through **1118** cannot be specified.

The frame and shelf portions of the specified card location (**loc**) can be **11** through **13**, **21** through **23**; **31** through **33**; **41** through **43**; **51** through **53**; and **61**. (The card location is *xyss*, where *x* is the frame, *y* is the shelf, and *ss* is the slot.)

The following **link** parameter values can be specified for the following cards that support more than 2 links per card:

- **a1-a3, b1-b3**—Multi-port LIM (MPL), SSED CM card running the **iplim** or **iplimi** application with links having **ipliml2=m2pa**, E1/T1 MIM card
- **a1-a31, b1-b31**—HC-MIM card
- **a1-a15, b1-b15**—E5-E1T1 card
- **a1-a7, b1-b7**—E5-ENET card running the **iplim** or **iplimi** application that supports 16 links
- **a1-a15, b1-b15**—E5-ENET card running the **ipsg** application

The **link** parameter values **a4-a7** and **b4-b7** can be specified for E5-ENET or HC MIM cards. The **link** parameter values **a8-a31 a4-a15** and **b8-b31 b4-b15** can be specified only for HC MIM and E5-E1T1 cards that are used as E1 cards or T1 cards. The **link** parameter values **a16-a31** and **b16-b31** can be specified only for HC MIM cards that are used as E1 cards or T1 cards. Links **a4-a31** and **b4-b31** cannot be specified for Channel cards.

Links **a16-a31** and **b16-b31** cannot be specified for even-numbered card locations. HC MIM cards are dual-slot cards. The links are assigned only to the cards in odd-numbered locations.

The specified link must exist in the database.

The signaling link must be in the unavailable (UAV) state before it can be removed. Enter the **rept-stat-slk** command to verify the state of the signaling link.

The signaling link cannot have an active LFS test in progress when this command is entered to delete the link.

The **force=yes** parameter must be specified to remove the last signaling link in a linkset that is assigned to a route.

To remove the last signaling link on a card, the state of the card must be OOS-MT-DSBLD. Enter the **rept-stat-card** command to verify the state of the card.

The card must be inhibited before the last link on the card can be deleted.

An IPLIMx or IPGWx signaling link assigned to a local host cannot be deleted if it has a socket or association with connection status **open=yes**.

The slot portion of the specified card location (**loc**) can be **1** through **8** and **11** through **18**. Slots **09** and **10** cannot be specified. (The card location is *xyss*, where *x* is the frame, *y* is the shelf, and *ss* is the slot.)

If deleting the link causes the provisioned link count to fall below the **numslk** thresholds configured for the corresponding IPSG-M3UA linkset (see the **chg-isopts** command), then the command cannot be entered. If values of **0** or **1** are specified for all of the **numslk** threshold parameters, then the last link can be deleted.

## Notes

This command disassociates the equipment of a link from a logical signaling link. The link must first be placed in the unavailable (UAV) state by entering the **chg-slk** (or **canc-slk**) command before this command can be used to disconnect it. Entering this command results in the link entity being deleted from the STP's link entity set. The link is then considered to be "disconnected." The link on the STP becomes unassigned (spare) but retains the existing equipment type and options; the link remains in the "equipped" provisioning state unless that state is changed by subsequent local craft activity. The link is also no longer associated with its assigned linkset.

Not every card location represents a signaling link. Be sure to address a signaling link in this command.

The *Installation Manual – EAGLE 5 ISS* provides an illustration of card locations.

## Output

```
dlt-slk:loc=1211:link=a
  rlgncxa03w 05-02-07 11:11:28 EST EAGLE5 33.0.0
  DLT-SLK: MASP A - COMPLTD
;
```

**dlt-spc****Delete Secondary Point Code**

Use this command to delete an SPC (secondary point code) from the database. Also use this command to change an SPC by first removing the SPC from the database and then using the **ent-spc** command to enter the new SPC value.

**Keyword:** **dlt-spc**

**Related Commands:** **ent-spc, rtrv-spc**

**Command Class:** Database Administration

**Parameters**

**NOTE: See "Point Code Formats and Conversion" in Appendix A for a detailed description of point code formats, rules for specification, and examples.**

**:spc=** (mandatory)

ANSI destination point code with subfields *network indicator-network cluster-network cluster member (ni-nc-ncm)*.

**Synonym:** **spca**

**Range:** **000-255**

Specify a valid value for each subfield of the point code, and separate the subfields with a dash (-).

When **chg-sid:pctype=ansi** is specified, *ni = 000* is not valid.

When **chg-sid:pctype=ansi** is specified, *nc = 000* is not valid if *ni = 001-005*.

When **chg-sid:pctype=ansi** is specified, *nc = 000* is valid if *ni = 006-255*.

The point code **000-000-000** is not a valid point code.

**:spc/spca/spci/spcn/pcn24=** (mandatory)

Secondary point code.

**:spci=** (mandatory)

ITU international point code with subfields *zone-area-id*. The *prefix* subfield indicates a spare point code (*prefix-zone-area-id*)

**Range:** **s-, 0-255**

Specify a valid value for each subfield of the point code, and separate the subfields with a dash (-).

*prefix—s-*

*zone—0-7*

*area—000-255*

*id—0-7*

The point code **0-000-0** is not a valid point code.

**:spcn=** (mandatory)

ITU international point code with subfields *zone-area-id*. The *prefix* subfield indicates a spare point code (*prefix-zone-area-id*).

**Range:** **s-, 0-16383, aa-zz**

Specify a valid value for each subfield of the point code, and separate the subfields with a dash (-).

*prefix—s-*

*nnnnn—0-16383*

*gc—aa-zz*

$m1-m2-m3-m4$ —**0-14** for each member; values must sum to 14

**:spcn24=** (mandatory)

24-bit ITU national point code with subfields *main signaling area-sub signaling area-signaling point (msa-ssa-sp)*.

**Range:** **000-255**

Specify a valid value for each subfield of the point code, and separate the subfields with a dash (-).

*msa*—**000-255**

*ssa*—**000-255**

*sp*—**000-255**

### Example

```
dlt-spc:spc=10-20-30
```

```
dlt-spc:spcn24=98-98-98
```

```
dlt-spc:spcn=s-12345
```

### Dependencies

A secondary point code that is referenced in the Destination table cannot be deleted.

If the value specified for the **spc** parameter is referenced in the Linkset table, then the parameter cannot be deleted.

The MPC feature must be turned on before this command can be entered.

The value specified for the **spc** parameter must exist in the Secondary Point Code table.

### Notes

In this command, only ITU-international and ITU national point codes support the spare point code subtype prefix (s-).

### Output

```
dlt-spc:spc=10-20-30
```

```
rlghncxa03w 04-02-18 08:50:12 EST EAGLE 31.3.0
Secondary Point Code table is (7 of 40) 17% full
DLT-SPC: MASP A - COMPLTD
```

```
;
```

## dlt-srvsel

## Delete Service Selector

Use this command to delete a service selector.

**Keyword:** **dlt-srvsel**

**Related Commands:** **chg-srvsel, ent-srvsel, rtrv-srvsel**

**Command Class:** Database Administration

### Parameters

**:gti/gtia/gtii/gtin/gtin24=** (mandatory)

Global title indicator. For all service selector commands, the domain is defined as **gti** and **gtia** (ANSI), **gtii** (ITU international), and **gtin** (ITU national). For the service selector commands, **gti** and **gtia** are equivalent.

**Range:** **2, 4**

Supported value for ANSI: **gti=2** and **gtia=2**

Supported values for ITU: **gtii=2, gtii=4, gtin=2, gtin=4, gtin24=2, gtin24=4**

- :ssn=** (mandatory)  
Subsystem number.  
**Range:** 0-255 \*
- :tt=** (mandatory)  
Translation type.  
**Range:** 0-255
- :nai=** (optional)  
Nature of Address indicator. The Nature of Address indicator can be specified by supplying either a mnemonic value (**nai** parameter) or an explicit numeric value (**naiv** parameter). Either the **nai** parameter or the **naiv** parameter, but not both, can be specified in the command. Table A-5 shows the mapping between the **naiv** and the **nai** parameter values.  
**Range:** sub, rsvd, natl, intl
- :naiv=** (optional)  
Nature of Address indicator value. The Nature of Address indicator can be specified by supplying either a mnemonic value (**nai** parameter) or an explicit numeric value (**naiv** parameter). Either the **nai** parameter or the **naiv** parameter, but not both, can be specified in the command. Table A-5 shows the mapping between the **naiv** and the **nai** parameter values.  
**Range:** 0-127
- :np=** (optional)  
Numbering Plan. The numbering plan indicator can be specified by supplying either a mnemonic value (**np** parameter) or an explicit numeric value (**npv** parameter). Either the **np** parameter or the **npv** parameter, but not both, can be specified in the command. Table A-6 shows the mapping between the **npv** and the **np** parameter values.  
**Range:** e164, generic, x121, f69, e210, e212, e214, private
- :npv=** (optional)  
Numbering Plan value. The numbering plan can be specified by supplying either a mnemonic value (**np** parameter) or an explicit numeric value (**npv** parameter). Either the **np** parameter or the **npv** parameter, but not both, can be specified in the command. Table A-6 shows the mapping between the **npv** and the **np** parameter values.  
**Range:** 0-15

### Example

```
dlt-srvsel:gti=2:ssn=250:tt=10
dlt-srvsel:gtin=4:tt=0:ssn=100:np=e164:nai=sub
dlt-srvsel:gtin24=4:tt=4:ssn=20:np=e164:nai=intl
dlt-srvsel:gtii=4:tt=4:np=e164:nai=intl:ssn=9
dlt-srvsel:gtii=4:tt=5:np=e164:nai=intl:ssn=*
```

### Dependencies

- The **np** and **npv** parameters cannot be specified together in the command.
- The **nai** and **naiv** parameters cannot be specified together in the command.
- The **gti=4** and **gtia=4** parameters cannot be specified. The value **4** is not valid for these parameters.
- The values **1** and **3** are not valid for the **gti/gtia/gtii/gtin/gtin24** parameters.
- If the **gtii/gtin/gtin24=4** parameter is specified, then an **np(v)** and **nai(v)** parameter combination must be specified. These parameters can be specified in the following combinations: **np** and **naiv**, **npv** and **nai**, **np** and **nai**, or **npv** and **naiv**.



If the **gti/gtia/gtii/gtin/gtin24=2** parameter is specified, no **np(v)** and **nai(v)** parameter combinations can be specified.

An entry must already exist that matches the **gti/gtia/gtii/gtin/gtin24**, **tt**, **ssn**, and **np(v)** and **nai(v)** combination of parameters.

### Notes

None

### Output

```
dlt-srvsel:gti=2:ssn=250:tt=10
  rlgncxa03w 07-10-05 16:40:40 EST EAGLE 37.5.0
  Service Selector table is (114 of 1024) 11% full
  DLT-SRVSEL: MASP A - COMPLTD
;
```

## dlt-ss-appl

## Delete Subsystem Application

Use this command to remove the application from the LNP database.

**Keyword:** **dlt-ss-appl**

**Related Commands:** **chg-ss-appl**, **ent-ss-appl**, **rtrv-ss-appl**

**Command Class:** Database Administration

### Parameters

**:appl=** (mandatory)

Application type.

**Range:** **lnp**, **inp**, **eir**, **vflex**, **atinpq**

### Example

```
dlt-ss-appl:appl=inp
dlt-ss-appl:appl=vflex
dlt-ss-appl:appl=atinpq
```

### Dependencies

The LNP feature must be turned on (see the **enable-ctrl-feat** command) before the **dlt-ss-appl:appl=lnp** command can be entered.

The INP feature must be turned on before the **dlt-ss-appl:appl=inp** command can be entered.

The Equipment Identity Register (EIR) feature must be turned on before the **dlt-ss-appl:appl=eir** command can be entered.

The value specified for the **appl** parameter must already exist in the SS-APPL table.

The subsystem must be inhibited before **status=offline** can be specified.

Application type must exist in the LNP database (non DBS 1.0 only)

The V-Flex feature must be turned on before the **appl=vflex** parameter can be specified.

The ATINP feature must be enabled before the **appl=atinpq** parameter can be entered.

### Notes

When a subsystem application is deleted, the following message is displayed:

CAUTION: DELETED APPL SSN MAY BE REFERENCED BY GTT ENTRY

**Output**

```

dlt-ss-appl:appl=eir
  rlghncxa03w 09-04-05 17:34:20 EST  EAGLE 41.0.0
  DLT-SS-APPL: MASP A - CAUTION: DELETED APPL SSN MAY BE REFERENCED BY GTT
  ENTRY
  DLT-SS-APPL: MASP A - COMPLTD
;

```

**dlt-subnetid****Delete Subnet ID**

Use this command to delete a Subnet ID entry from the Subnet ID list, for the ISUP NP with EPAP feature.

**Keyword:** dlt-subnetid

**Related Commands:** ent-subnetid, rtrv-subnetid

**Command Class:** Database Administration

**Parameters**

**:subnetid=** (mandatory)  
Subnet ID  
**Range:** 1-15 digits

**Example**

```
dlt-subnetid:subnetid=886933
```

**Dependencies**

The value **none** cannot be specified for the **subnetid** parameter.

The specified Vendor ID entry must already exist in the SUBNETID table.

**Notes**

None.

**Output**

```

dlt-subnetid:subnetid=886933
  rlghncxa03w 04-10-07 11:11:28 EST  EAGLE 31.11.0
  SUBNETID table is (6 of 50) 3% full
  DLT-SUBNETID: MASP A - COMPLTD
;

```

**dlt-t1****Delete T1 Interface**

Use this command to delete an interface for an E1/T1 MIM or HC-MIM card, an E5-E1T1 card used as a T1 card, or an HC-MIM or E5-E1T1 card used as an ST-HSL-A card.

**NOTE: On HC-MIM and E5-E1T1 cards, T1 ports 1, 3, 5, and 7 (master ports) can be independently channel bridged with their adjacent even numbered (slave) ports 2, 4, 6, and 8 to allow non-signaling data pass-through. The slave port interface is automatically deleted with the command that deletes its master port interface.**

**Keyword:** dlt-t1

**Related Commands:** chg-t1, ent-t1, rtrv-e1, tst-t1

**Command Class:** Database Administration

## Parameters

**:loc=** (mandatory)

The card location as stenciled on the shelf of the system.

**Range:** 1101-1108, 1111-1112, 1201-1208, 1211-1218, 1301-1308, 1311-1318, 2101-2108, 2111-2118, 2201-2208, 2211-2218, 2301-2308, 2311-2318, 3101-3108, 3111-3118, 3201-3208, 3211-3218, 3301-3308, 3311-3318, 4101-4108, 4111-4118, 4201-4208, 4211-4218, 4301-4308, 4311-4318, 5101-5108, 5111-5118, 5201-5208, 5211-5218, 5301-5308, 5311-5318, 6101-6108, 6111-6118

**:t1port=** (mandatory)

T1 card port number. The value must be a T1 port for which an interface has already been configured on the specified T1 card.

**Range:** 1-8

Ports 3-8 are valid only for HC-MIM cards and E5-E1T1 cards.

## Example

```
dlt-t1:loc=1205:etport=1
```

```
dlt-t1:loc=1205:t1port=2
```

## Dependencies

The specified card location (**loc** parameter) must be equipped.

The card in the specified card location (**loc** parameter) must be a **limt1** card type.

The port specified by the **t1port** parameter must be already equipped with an T1 interface.

All signaling links providing timeslots serviced by the specified T1 interface must be deleted before the T1 interface can be deleted. Use the **dlt-slk** command to delete the signaling links providing the timeslots.

A channel bridged slave (even-numbered) port on an HC-MIM card or E5-E1T1 card cannot be specified in the **t1port** parameter. To delete channel bridged port interfaces, specify the master (odd-numbered) port in the **t1port** parameter. The slave port interface is automatically deleted when its master port interface is deleted.

## Notes

None.

## Output

```
dlt-t1:loc=1205:t1port=1
  rlgncxa03w 04-02-20 09:07:58 EST  EAGLE 31.3.0
  DLT-T1: MASP A - COMPLTD
;
```

## dlt-tt

## Delete Translation Type

Use this command to remove a translation type from the system database.

**NOTE: If the EGTT (Enhanced Global Title Translation) feature is turned on in your system, the system will no longer accept GTT (Global Title Translation) and TT (Translation Type) commands. Refer to the new command sets that replace the GTT and TT commands: GTT Selector commands (ent/chg/dlt/rtrv-gttsel), GTT Set commands (ent/dlt/rtrv-gttset), and GTA commands (ent/chg/dlt/rtrv-gta).**

**Keyword:** dlt-tt

**Related Commands:** ent-tt, rtrv-tt

**Command Class:** Database Administration

## Parameters

**:alias=** (optional)

The global title translation type

**Range:** 000-255

**Default:** No translation type given

**:ttn=** (optional)

Translation type name.

**Range:** ayyyyyyyy

1 alphabetic character followed by up to 7 alphanumeric characters

**Default:** No translation name is given

**:type/typea/typei/typen/typen24=** (optional)

**Type** and **typea** specify an ANSI network, **typei** specifies an ITU-international network, **typen** specifies an ITU-national network, and **typen24** specifies a 24-bit ITU national network. A translation type numeric value may be entered as ANSI (**type** or **typea**) and also as an ITU type (**typei**, **typen**, or **typen24**). However, they are separate entities.

**Range:** 0-255

**Default:** No translation type is specified

## Example

```
dlt-tt:type=230
```

```
dlt-tt:ttn=lidb
```

```
dlt-tt:type=230:ttn=lidb
```

```
dlt-tt:type=230:ttn=lidb:alias=030
```

## Dependencies

This command is not valid when the EGTT feature is turned on.

Asterisk (\*) parameter values are not allowed in this command.

To delete a translation type, the translation type, the translation name, or both, must be specified.

If the translation type is specified, it must already exist in the database for the network type.

If the translation name is specified, it must already exist in the database.

If the translation type is specified, it cannot be an **alias** value.

If both the translation type and translation name are specified, they must correspond.

The translation type cannot be deleted if there are current GTT entries that reference it.

To delete an **alias**, both the **alias** and the translation type must be specified, and both must already exist in the database for the network type.

If an **alias** is specified, it must be associated with the specified translation type and cannot be the value of an existing translation type.

Either the **type** parameter or **ttn** parameter must be specified.

If the **type** parameter is specified, the translation type must exist in the translation table. If the **type** or **ttn** parameter, or both, are specified, they must be the same as the values entered with the **ent-tt** command.

If the translation name is specified, it must be associated with a translation type.

If aliases exist, they must be removed from the database before the translation types can be removed.

**Notes**

If the specified translation type entry is not referenced by a current global title translation entry and does not have any aliases, the translation type entry is removed.

**Output**

**dlt-tt:type=230**

```
rlghncxa03w 04-01-07 11:43:04 EST EAGLE 31.3.0
DLT-TT: MASP A - COMPLTD
```

;

**dlt-ttmap****Delete Translation Type Mapping**

Use this command to delete from the database a mapped SS7 message translation type (TT) for a given gateway linkset name. For example, suppose you are mapping the translation type 001 (before TT mapping) to 238 (after TT mapping). You can use this command to delete that mapping from the database.

**Keyword:** **dlt-ttmap**

**Related Commands:** **chg-ttmap, ent-ttmap, rtrv-ttmap**

**Command Class:** Database Administration

**Parameters**

**:lsn=** (mandatory)

Linkset name. The unique network identifier for the gateway linkset.

**Range:** *ayyyyyyyy*

1 alphabetic character followed by 9 alphanumeric characters

**:ett=** (optional)

Translation type before mapping. The identification of the type of global title translation in the SS7 message *before* translation type mapping. This attribute is the decimal representation of the 1-octet binary field used by the SS7 protocol to identify the translation type.

**Range:** **0-255**

**:io=** (optional)

Incoming or outgoing. The system uses this parameter to indicate whether the translation type mapping data provisioned for the gateway linkset is for SS7 messages *received* or *sent* on the linkset.

**Range:** **i, o**

**i**— incoming

**o**— outgoing

**Default:** Both incoming and outgoing

**Example**

```
dlt-ttmap:lsn=n c001:io=i:ett=128:mtt=55
```

**Dependencies**

None

**Notes**

None

**Output**

```
dlt-ttmap:lsn=nc001:io=i:ett=128:mtt=55
rlghncxa03w 04-02-22 11:18:50 EST EAGLE 31.3.0
TTMAP table for nc001 is (2 of 64) 3% full
DLT-TTMAP: MASP A - COMPLTD
;
```

**dlt-uim-acthresh****Delete Activity Level Threshold for STP UIM Activity Reporting**

Use this command to clear the level of activity threshold that is used to report UIM messages.

**Keyword:** dlt-uim-acthresh

**Related Commands:** rtrv-uim-acthresh, set-uim-acthresh

**Command Class:** Database Administration

**Parameters**

**:uimn=** (mandatory)  
The UIM number.  
**Range:** 1000-1499

**Example**

Clears UIM number 1333 message threshold:

```
dlt-uim-acthresh:uimn=1333
```

**Dependencies**

The **uimn** parameter value must be a numeric value in the range of **1000–1499**.

The specified **uimn** value must exist in the UIM Threshold database table.

**Notes**

None

**Output**

```
dlt-uim-acthresh:uimn=1333

rlghncxa03w 04-02-01 08:50:12 EST EAGLE 31.3.0
DLT-UIM-ACTHRESH: MASP A - COMPLTD
;
```

**dlt-user****Delete User**

Use this command to remove a user from the system database.

**Keyword:** dlt-user

**Related Commands:** act-user, chg-pid, chg-user, dact-user, ent-user, login, logout, rept-stat-user, rtrv-secu-user, rtrv-user

**Command Class:** Security Administration

**Parameters**

**:uid=** (mandatory)  
User ID  
**Range:** azzzzzzzzzzzzzzzzzzzzzz  
1 alphabetic character followed by up to 15 alphanumeric characters

**Example**

```
dlt-user:uid=terryjohnson
```

**Dependencies****Notes**

If the user being removed is logged onto the system, this command logs the user off immediately.

**Output**

```
dlt-user:uid=terryjohnson
rlghncxa03w 04-01-07 11:11:28 EST EAGLE 31.3.0
DLT-USER: MASP A - COMPLTD
;
```

**dlt-vendid****Delete Vendor ID**

Use this command to delete a Vendor ID entry from the Vendor ID list, for the GSM MAP SRI Redirect to Serving HLR feature.

**Keyword:** dlt-vendid

**Related Commands:** ent-vendid, rtrv-vendid

**Command Class:** Database Administration

**Parameters**

**:vendid=** (mandatory)  
Vendor ID  
**Range:** 1-15 digits

**Example**

```
dlt-vendid:vendid=886933
```

**Dependencies**

The value **none** cannot be specified for the **vendid** parameter.

The specified Vendor ID entry must already exist in the VendID table.

**Notes**

None.

**Output**

```
dlt-vendid:vendid=886933
rlghncxa03w 04-10-07 11:11:28 EST EAGLE 31.11.0
VENDID table is (6 of 200) 3% full
DLT-VENDID: MASP A - COMPLTD
;
```

**dlt-vflx-cd****Delete VFLEX Call Decision Entry**

Use this command to delete call decision criteria from the Call Decision table.

**NOTE: The V-Flex feature must be enabled before this command can be entered.**

**Keyword:** dlt-vflx-cd

**Related Commands:** chg-vflx-cd, ent-vflx-cd, rtrv-vflx-cd

**Command Class:** Database Administration

**Parameters****:cdn=** (mandatory)

Call decision name. This parameter specifies the entry in the Call Decision table to be deleted.

**Range:** *ayyy*

1 alphabetic character followed by 3 alphanumeric characters

**Example****dlt-vflx-cd:cdn=cdn1****Dependencies**The value specified for the **cdn** parameter cannot be a reserved word, such as **none**.The value specified for the **cdn** parameter must already exist in the Call Decision table.

The V-Flex feature must be enabled before this command can be entered.

**Output**

```
dlt-vflx-cd:cdn=cdn1
rlghncxa03w 08-05-07 11:11:28 EST EAGLE 39.0.0
DLT-VFLX-CD: MASP A - COMPLTD
;
```

**dlt-vflx-rn****Delete VFLEX Routing Number**

Use this command to delete a voice mail routing number from the Routing Number table.

**NOTE: The V-Flex feature must be enabled before this command can be entered.****Keyword:** **dlt-vflx-rn****Related Commands:** **chg-vflx-rn, ent-vflx-rn, rtrv-vflx-rn****Command Class:** Database Administration**Parameters****:rname=** (mandatory)

Routing number name. This parameter specifies the voice mail routing number to be deleted.

**Range:** *ayyyyyyy*

1 alphabetic character followed by 7 alphanumeric characters.

**Example****dlt-vflx-rn:rname=rn01****Dependencies**

The V-Flex feature must be enabled before this command can be entered.

The value specified for the **rname** parameter must already exist in the Routing Number table.The value specified for the **rname** parameter cannot be referenced by an entry in the VMSID table.The value specified for the **rname** parameter cannot be a reserved word such as **none**.**Output**

```
dlt-vflx-rn:rname=rn02
rlghncxa03w 08-05-29 08:51:12 EST EAGLE 39.0.0
DLT-VFLX-RN: MASP A - COMPLTD
;
```



**dlt-vflx-vmsid****Delete VFLEX VMSID Entry**

Use this command to delete a voice mail server ID from the VMSID table.

**NOTE: The V-Flex feature must be enabled before this command can be entered.**

**Keyword:** dlt-vflx-vmsid

**Related Commands:** chg-vflx-vmsid, ent-vflx-vmsid, rtrv-vflx-vmsid

**Command Class:** Database Administration

**Parameters**

**:id=** (mandatory)

This parameter specifies the voice mail server to be deleted.

**Range:** 1-15 digits, **dflt**

Valid digits are **0-9, A-F, a-f**

**dflt**—the default VMS ID

**Example**

```
dlt-vflx-vmsid:id=1234ae4
```

**Dependencies**

The V-Flex feature must be enabled before this command can be entered.

The value specified for the **vmsid** parameter must already exist in the VMSID table.

**Output**

```
dlt-vflx-vmsid:id=1234ae5
rlghncxa03w 08-05-29 08:51:12 EST EAGLE 39.0.0
DLT-VFLX-VMSID: MASP A - COMPLTD
;
```

**dlt-x25-dstn****Delete X.25 Destination**

Use this command to remove the association of an X.25 network address with an SS7 point code.

**NOTE: This command is obsolete.**

**Keyword:** dlt-x25-dstn

**Related Commands:** chg-x25-dstn, ent-x25-dstn, rtrv-x25-dstn

**Command Class:** Database Administration

**Parameters**

**:xaddr=** (mandatory)

The X.25 network address of the X.25 destination entity or the SS7 node.

**Range:** 1-15 digits

**Example**

```
dlt-x25-dstn:xaddr=205255864567721
```

**Dependencies**

An X.25 address must have a minimum of four digits.

The X.25 address must already exist as an X.25 destination.

The X.25 address cannot be assigned to an X.25 route.

**Notes**

None

**Output**

```

dlt-x25-dstn:xaddr=205255864567721

rlghncxa03w 04-02-10 11:43:04 EST EAGLE 31.3.0
X.25 DSTN TABLE 45 % FULL
DLT-X25-DSTN: MASP A - COMPLTD
;

```

**dlt-x25-rte****Delete X.25 Route**

Use this command to remove X.25 routes from the database.

**NOTE: This command is obsolete.**

**Keyword:** dlt-x25-rte

**Related Commands:** chg-x25-rte, ent-x25-rte, rtrv-x25-rte

**Command Class:** Database Administration

**Parameters**

**:saddr=** (mandatory)

The alias X.25 address assigned to the SS7 destination entity on the SS7 side of the circuit.

**Range:** 1-15 digits

**:xaddr=** (mandatory)

The X.25 address assigned to the X.25 destination entity on the X.25 side of the circuit.

**Range:** 1-15 digits

**Example**

```

dlt-x25-rte:xaddr=225255:saddr=133131

```

**Dependencies**

Each X.25 address must have at least four digits.

The combination of the two X.25 addresses must be in the X.25 Routing table.

**Notes**

None

**Output**

```

dlt-x25-rte:xaddr=225255:saddr=133131

rlghncxa03w 04-02-10 11:43:04 EST EAGLE 31.3.0
DLT-X25-RTE: MASP A - X.25 Route table 45% full
DLT-X25-RTE: MASP A - COMPLTD
;

```

**enable-ctrl-feat****Enable Controlled Feature**

Use this command to enable a controlled feature that the customer has purchased.

**NOTE:** The “LNP (Local Number Portability) feature” is turned on when the LNP ported TNs quantity is greater than 0 in the `rtrv-ctrl-feat` command output. An LNP ported TNs quantity feature access key has been enabled and turned on.

**Keyword:** `enable-ctrl-feat`

**Related Commands:** `chg-ctrl-feat`, `rtrv-ctrl-feat`

**Command Class:** Database Administration

### Parameters

**:fak=** (mandatory)

Feature Access Key. This parameter specifies the Feature Access Key for the feature.

**Range:** `ayyyyyyyyyyy`

13 alphanumeric characters; the first character must be a letter.

The feature access key cannot contain any special characters, including spaces and dashes. Upper-case characters are mapped to lower case.

**:partnum=** (mandatory)

Part number. This parameter specifies the part number for the feature.

**Range:** `893000000 - 893999999`

Do not include dashes in the 9-digit number.

### Example

```
enable-ctrl-feat:partnum=893xxxxxx:fak=xxxxxxxxxxxxxx
```

### Dependencies



**CAUTION:** Never install or initialize MCAP cards in card slots 1113 and 1115 after GPSM-II cards are provisioned in these slots. Attempting to initialize MCAP cards after GPSM-II cards have been provisioned in slots 1113 and 1115 will cause a system outage. Before replacing an existing GPSM-II card in slot 1113 or slot 1115, contact the Customer Care Center.

The phrase "Service Module cards" is used to refer to DSM cards or E5-SM4G cards when either type of card can be used. If DSM cards or E5-SM4G cards are specifically required, then the appropriate card requirement is listed.

The system serial number must be locked in the database before this command can be entered for the feature (see the `ent-serial-num` command).

The feature access key must be valid for the specified feature part number and for the system serial number.

A feature cannot be enabled with this command when the feature has already been enabled with a temporary feature access key, a permanently On feature access key, or a feature access key for a quantity that is greater than the quantity specified in the command.

A temporary feature access key can be used only one time to enable a feature. After the temporary feature access key expires, you must purchase the feature before you can use a permanent feature access key to enable the feature.

A temporary feature access key cannot be used to enable features that do not allow a temporary feature access key. The following features allow a temporary feature access key:

- 1100 TPS/DSM for ITU NP
- ATINP
- Circular Route Auto-Recovery
- Command Class Management

- EAGLE OA&M IP Security
- Enhanced Far-End Loopback
- Flexible GTT Load Sharing (FGTTLS)
- GTT LS ARI
- IDPR ASD
- IDPR GRN
- INP Circular Route Prevention
- Intermediate GTT Load Sharing (IGTTLS)
- Large BICC MSU
- LNP Short Message Service (LNP SMS)
- MNP Circular Route Prevention
- MO SMS ASD
- MO SMS B-Party Routing
- MO SMS GRN
- MO SMS IS41-to-GSM Migration
- MTP Map Screening
- Network Security Enhancements
- Portability Check for MO SMS
- Prepaid SMS Intercept Ph1 (PPSMS)
- SEAS Over IP
- Service Portability
- Telnet
- TIF ASD
- TIF GRN
- TIF Number Substitution

If any EPAP-based feature is turned on, then a maximum of 25 Service Module cards is allowed in the system. If the system is running only GTT, then a maximum of 32 Service Module cards is allowed in the system.

The GTT feature must be on before the IDP Screening for Prepaid feature can be enabled.

The value specified for the **partnum** parameter must be the correct part number for the purchased feature.

A valid system serial number must be entered in the database before this command can be entered for the feature (see the **ent-serial-num** command).

The LNP ELAP Configuration feature and the WNP feature must be turned on before the LNP SMS feature can be enabled.

The GTT feature must be turned on before the XGTT Table Expansion feature can be enabled.

The XGTT (269,999 to 400,000 entries) feature requires TSM cards that have at least a 586K processor and are running the **sccp** application, Service Module cards that are running the **vsccp** application, or a combination of the cards.

The XMAP (2000 and 3000 entries) feature requires TSM cards that have at least a 586K processor and are running the **sccp** application, Service Module cards that are running the **vsccp** application, or a combination of the cards.

The DSTN5000 feature bit for the 5000 Routesets feature must be turned on before the 6000 Routesets feature, the 7000 Routesets feature, or the 8000 Routesets feature can be enabled.

The 7000 Routesets feature and the 8000 Routesets feature cannot be enabled when more than 8000 alias point codes are already assigned in the system.

If the LNP (an LNP ported TNs quantity), LNP 150,000 LRNs, or LNP 300,000 NPANXX feature is enabled, then the INP and AINPQ features cannot be turned on, and none of the following features can be enabled:

- AINPQ
- A-Port
- ATINP
- Equipment Identity Register (EIR)
- G-Flex
- G-Port
- Info Analyzed Relay Base (IAR Base)
- INP
- IS41 GSM Migration (IGM)
- MO SMS ASD
- MO SMS GRN
- MO-based GSM SMS NP
- MO-based IS41 SMS NP
- MTP Messages for Prepaid Applications (MTPR)
- Portability Check for MO SMS
- Prepaid IDP Query Relay (IDP Relay)
- Prepaid SMS Intercept Phase 1 (PPSMS)
- TIF Number Portability
- TIF Number Substitution
- V-Flex

The LNP feature (an LNP ported TNs quantity) must be enabled before the LNP 150,000 LRNs feature or the LNP 300,000 NPANXXs feature can be enabled.

The LNP ELAP Configuration feature must be enabled, and turned on with the **chg-ctrl-feat** command, before the features for the following quantities can be enabled:

- The LNP feature for a quantity equal to or greater than 24 million TNs
- The 150,000 LNP LRNs feature
- The 300,000 NPANXXs feature

The LNP feature for 24 million TNs requires all DSM cards with a minimum of 2GB of memory.

The LNP feature for 36 million TNs requires all DSM cards with a minimum of 3GB of memory.

The LNP feature for LNP ported TNs quantities of 48 million TNs to 192 million TNs requires all Service Module cards with a minimum of 4GB of memory. The LNP feature for LNP ported TNs quantities of 204 million TNs to 228 million TNs requires all DSM cards with a minimum of 4GB of memory. TSM cards running the **sccp** application cannot be used.

The 150,000 LNP LRNs feature requires all Service Module cards; any DSM cards must have a minimum of 2GB of memory.

The 300,000 LNP NPANXXs feature requires all Service Module cards; any DSM cards must have a minimum of 2GB of memory.

The GTT feature bit must be turned on (see the **chg-feat** command) before the following features can be enabled:

- Advanced GT Modification (AMGTT)
- ATI Number Portability Query (ATINP)
- E5-SM4G Throughput Capacity
- Equipment Identity Register (EIR)
- G-Flex
- GSM Map Screening (GSM)
- Hex Digit Support for GTT
- Info Analyzed Relay Base (IAR Base)
- Intermediate GTT Loadsharing (IGTTLS)
- LNP ELAP Configuration
- LNP ported LRNs
- LNP ported NPANXXs
- LNP ported TNs
- MO SMS ASD
- MO SMS GRN
- MO SMS IS41-to-GSM Migration
- MO-based GSM SMS NP
- MO-based IS41 SMS NP
- MTP Routed Gateway Screening Stop Action
- Portability Check for MO SMS (MNPSMS)
- Prepaid SMS Intercept Ph1 (PPSMS)
- SCCP Loop Detection
- TIF Additional Subscriber Data
- TIF Generic Routing Number
- TIF Number Portability
- TIF Number Substitution
- TIF SCS Forwarding
- TIF Simple Number Substitution

- Transaction-based GTT Loadsharing (TBGTTLS)
- Voice Mail Router (V-Flex)

The ANSI-ITU-China SCCP Conversion feature cannot be enabled if the SCCPCNV (SCCP Converison) feature bit or the TCAPCNV (TCAP Conversion) feature bit is turned on.

The ANSI-ITU-China SCCP Conversion feature requires TSM or Service Module cards in the system.

The GSM Map Screening (GSM) feature must be turned on before the Enhanced GSM Map Screening (EGSM) feature can be enabled.

The Enhanced GSM Map Screening (EGSM) feature must be turned on before the MTP MAP Screening feature can be enabled.

The Measurements Platform feature must be turned on and the Measurements Platform collection function must be enabled (see the **chg-measopts:platformenable=on** parameter) before the MTP MAP Screening feature can be enabled (at least one MCPM card must be active).

The 7000 Routesets and 8000 Routesets quantity keys can not be enabled if the number of provisioned alias destinations is greater than 8000.

The G-Port feature must be turned on before the following features can be enabled:

- GSM MAP SRI Redirect for Serving HLR
- ISUP NP with EPAP
- MNP Circular Route Prevention
- Prepaid SMS Intercept Phase 1 (PPSMS)

The GWS (Gateway Screening) feature must be turned on before the following features can be enabled:

- ISUP NP with EPAP
- TIF Additional Subscriber Data
- TIF Generic Routing Number
- TIF Number Portability
- TIF Number Substitution
- TIF SCS Forwarding
- TIF Simple Number Substitution

The following features cannot be enabled if the **ansigflex** system option is enabled (see the **chg-stpopts** command):

- 1100 TPS/DSM for ITU NP
- ANSI-41 INP Query (AINPQ)
- A-Port
- ATINP
- Equipment Identity Register (EIR)
- G-Flex MAP Layer Routing
- G-Port

- Info Analyzed Relay Base
- INP
- IS41 GSM Migration (IGM)
- MO SMS ASD
- MO SMS GRN
- MO SMS IS41-to-GSM Migration
- MO-based SMS GSM NP
- MO-based SMS IS41 NP
- Portability Check for MO SMS
- TIF Number Portability
- TIF Number Substitution
- V-Flex

Before an LNP ported TNs quantity greater than 96 million numbers can be enabled, an ELAP system that supports a quantity greater than 96 million numbers must be available to the EAGLE 5 ISS.

- The ELAP software must be at version 4.0 to support LNP ported TNs quantities greater than 96 million numbers and up to 120 million numbers.
- The ELAP software must be at version 5.0 or greater to support LNP ported TNs quantities greater than 120 million numbers. A quantity greater than 120 million numbers cannot be enabled until the ELAP is upgraded to the required software level, and the appropriate ELAP commands are issued to convert the 120 Million LNP Numbers database structure to the data compaction structure for more than 120 million numbers.

The **rept-stat-mps** command can be entered at the EAGLE 5 ISS to determine the ELAP software version.

The following features require Service Module cards running the **vscep** application to be present in the system before they can be enabled:

- AINPQ
- A-Port
- ATI Number Portability Query (ATINP)
- EIR
- Enhanced GSM MAP Screening (EGMS)
- Flexible GTT Load Sharing
- G-Flex
- G-Port
- INP
- IS41 GSM Migration (IGM)
- LNP ELAP Configuration
- MO SMS ASD
- MO SMS B-Party Routing



- MO SMS GRN
- MO SMS IS41-to-GSM Migration
- MO-based GSM SMS NP
- MO-based IS41 SMS NP
- Origin-based SCCP Routing (OBSR)
- PPSMS
- SCCP Loop Detection
- SCCP Loop Detection
- TIF Additional Subscriber Data
- TIF Generic Routing Number
- TIF Number Portability
- TIF Number Substitution
- TIF SCS Forwarding
- TIF Simple Number Substitution
- Transaction-based GTT Loadsharing (TBGTTLS)
- Weighted GTT Loadsharing (WGTTLS)
- V-Flex

Before LNP ported TNs quantities greater than 96 million numbers can be enabled, an ELAP system must be available to validate its software version to the EAGLE 5 ISS.

The Enhanced GTT (EGTT) feature must be turned on before the following features can be enabled

- Flexible Linkset Optional Based Routing (FLOBR)
- MO SMS B-Party Routing
- Origin-based SCCP Routing (OBSR)

At least one of the EPAP-based ITU NP features (G-Port, A-Port, INP, IGM, EIR, IDP Relay, ANSI-41 INP Query, V-Flex, or PPSMS) must be turned on before the 1100 TPS/DSM for ITU NP feature can be enabled.

The GTT feature must be turned on (see the **chg-feat** command) before the A-Port feature can be enabled.

The GTT feature must be turned on (see the **chg-feat** command) before the G-Port feature can be enabled.

The GTT feature must be turned on (see the **chg-feat** command) before the IS41 GSM Migration (IGM) feature can be enabled.

One of the following features must be turned on before the MTP MSGS for SCCP Apps (MTPR) feature can be enabled:

- A-Port
- G-Flex
- IS41 GSM Migration
- MO SMS ASD

- MO SMS B-Party Routing
- MO SMS GRN
- MO SMS IS41-to-GSM Migration
- MO-based IS41 SMS NP

If a DSM card with less than 4 gigabytes of memory is present in the system, the following features cannot be enabled

- A-Port
- MO SMS ASD
- MO SMS B-Party Routing
- MO SMS GRN
- MO SMS IS41-to-GSM Migration
- MO SMS Prepaid Intercept on B-Party
- Portability Check for MO SMS
- PPSMS

The PPSMS feature cannot be enabled if the LNP ELAP Configuration feature is turned on.

If the MTP Msgs for SCCP Apps feature is turned on, the EIR feature cannot be enabled.

Service Module cards must be provisioned in the system before the Prepaid IDP Query Relay feature can be enabled.

The GTT feature must be turned on before the Prepaid IDP Query Relay feature can be enabled.

The Default Country Code must be provisioned (see the **defcc** parameter in the **chg-stpopts** command) before the Prepaid IDP Query Relay feature can be enabled.

E5-SM4G cards do not support LNP ported TNs quantities of 204-228 million numbers. DSM cards are required.

The IP User Interface feature must be enabled before the SEAS Over IP feature can be enabled.

If the TIF (Number Portability/ Additional Subscriber Data / Generic Routing Number) is enabled, then the LNP feature cannot be enabled. If the LNP feature is enabled, then the TIF (Number Portability/ Additional Subscriber Data / Generic Routing Number) feature cannot be enabled.

The Multiple Point Code (MPC) feature must be turned on before the Multiple Linksets to Single Adjacent PC (MLS) feature can be enabled.

The G-Flex feature must be turned on before the G-Flex MAP Layer Routing feature can be enabled.

The G-Port feature must be enabled before the following features can be enabled:

- G-Port SRI Query for Prepaid
- MT-Based GSM SMS NP

The A-Port feature must be enabled before the MT-Based IS41 SMS NP feature can be enabled.

The AMGTT CdPA Only feature cannot be enabled using the **enable-ctrl-feat** command. This feature is automatically enabled and turned on if the MGTT feature was on before upgrade to EAGLE 5 ISS Release 38.0 occurred.

The AMGTT CdPA Only feature must be turned on before the AMGTT CgPA Upgrade feature can be enabled.

If the AMGTT CdPA Only feature or the AMGTT CgPA Upgrade feature is turned on, then the AMGTT feature cannot be enabled.

The LNP (an LNP ported TNs quantity), LNP 150,000 LRNs, or LNP 300,000 NPANXX feature cannot be enabled if the INP or AINPQ feature is turned on or if any of the features listed below is enabled.

- A-Port
- ATINP
- Equipment Identity Register (EIR)
- G-Flex
- G-Port
- IS41 GSM Migration (IGM)
- MO SMS ASD
- MO SMS GRN
- MO SMS IS41-to-GSM Migration
- MO-based GSM SMS NP
- MO-based IS41 SMS NP
- MTP Messages for Prepaid Applications (MTPR)
- Portability Check for MO SMS (MNPSMS)
- Prepaid IDP Query Relay (IDP Relay)
- Prepaid SMS Intercept Phase 1 (PPSMS)
- TIF Number Portability
- TIF Number Substitution
- V-Flex

The MT-Based GSM SMS NP feature must be enabled before the MT-Based GSM MMS NP feature can be enabled.

The LNP ported TNs 24 Million Quantity feature or greater must be turned on before the LRNQT feature can be enabled.

The Intermediate GTT Load Sharing feature must be turned on before the GTT LS ARI feature can be enabled.

The Flexible GTT Load Sharing feature must be enabled before the GTT LS ARI feature can be enabled.

The Flexible Linkset Optional Based Routing (FLOBR) feature must be turned on before the TCAP Opcode Based Routing (TOBR) feature can be enabled.

The Variable Length GTT (VGTT) feature must be turned on before the Support for 16 GTT Lengths in VGTT feature can be enabled.

The TOBR feature must be turned on before any of the TOBR Quantity features can be enabled.

A TOBR quantity feature cannot be enabled if a TOBR feature with a higher quantity is enabled.

If the TOBR quantity feature of maximum quantity level is enabled, then no other TOBR Quantity feature can be enabled.

The Prepaid IDP Query Relay feature must be turned on before the following features can be enabled:

- IDP A-Party Blacklist
- IDP A-Party Routing
- IDP Service Key Routing

The INP feature must be turned on before the INP CRP feature can be enabled.

The Default Country Code must be provisioned (see the **defcc** parameter in the **chg-stpopts** command) before the ATINP, IAR Base, MT-Based GSM SMS NP, or MT-Based IS41 SMS NP feature can be enabled.

If the system contains any cards other than those listed below, then the 2800 links quantity of the Large System # Links feature cannot be enabled:

- E5-ATM
- E5-E1/T1
- E5-ENET
- E5-IPSM
- E5-OAM
- E5-SM4G
- E5-TSM (GLS)
- HC-MIM
- HIPR
- HIPR2
- IPSM
- MCPM
- SLAN (SSEDCM and E5-SLAN)
- STC (SSEDCM and E5-STC)
- TSM (GLS)

The Info Analyzed Relay Base (IAR Base) feature must be enabled before the IAR NP, IAR GRN, or IAR ASD feature can be enabled.

The S-Port feature and the IDP A-Party Blacklist feature cannot both be enabled in the system.

The value specified for the **partnum** parameter must consist of 9 digits, without any dashes. The first three digits are **893**. The next six values are numeric (**0...9**).

## Notes

### *XGTT or XMAP (GTT or MAP Table Increase) Feature*

After the XGTT feature is enabled, the feature cannot be disabled or turned off.

After the XMAP feature is enabled, the feature cannot be disabled or turned off.

### *1500 Links and 2000 Links Support*

After the 1500 Links feature or the 2000 Links Support feature is enabled, the feature cannot be disabled or turned off.

### *SE-HSL SLK Capacity*

The SE-HSL feature allows unchannelized E1 links to be provisioned.

Table 5-41 lists the total number of unchannelized signaling links that can be assigned to HC-MIM and E5-E1T1 cards in the system when each SE-HSL SLK Capacity quantity feature access key is enabled.

**Table 5-41. SE-HSL SLK Capacity Feature Quantities**

Part Number	Maximum SE-HSL Links Allowed in the System
893-0130-01	4
893-0130-02	8
893-0130-03	16
893-0130-04	24
893-0130-05	32
893-0130-06	40
893-0130-07	48
893-0130-08	56
893-0130-09	64
893-0130-10	72
893-0130-11	80

***LNP 384 Million TNs, LNP 300,000 NPANXXs, LNP 150,000 LRNs, and LNP ELAP Configuration Features***

Table 5-42 lists the types and memory capacity for the Service Module cards (DSM cards or E5-SM4G cards) required by each LNP quantity feature. Quantities of 204-228 million TNs require DSM cards and do not support E5-SM4G cards. Quantities of 240-384 million TNs require E5-SM4G cards.

**Table 5-42. Minimum Hardware Required for LNP Quantity Features**

Object / Capacity	Minimum Hardware	Feature Access Key
24 Million TNs	2 GB DSM	893-0110-06
36 Million TNs	3 GB DSM	893-0110-07
48 Million TNs	4 GB Service Module card	893-0110-08
60 Million TNs	4 GB Service Module card	893-0110-09
72 Million TNs	4 GB Service Module card	893-0110-10
84 Million TNs	4 GB Service Module card	893-0110-11
96 Million TNs	4 GB Service Module card	893-0110-12

**Table 5-42.** Minimum Hardware Required for LNP Quantity Features

<b>Object / Capacity</b>	<b>Minimum Hardware</b>	<b>Feature Access Key</b>
108 Million TNs	4 GB Service Module card	893-0110-13
120 Million TNs	4 GB Service Module card	893-0110-14
132 Million TNs	4 GB Service Module card	893-0110-15
144 Million TNs	4 GB Service Module card	893-0110-16
156 Million TNs	4 GB Service Module card	893-0110-17
168 Million TNs	4 GB Service Module card	893-0110-18
180 Million TNs	4 GB Service Module card	893-0110-19
192 Million TNs	4 GB Service Module card	893-0110-20
204 Million TNs	4 GB DSM	893-0110-21
216 Million TNs	4 GB DSM	893-0110-22
228 Million TNs	4 GB DSM	893-0110-23
240 Million TNs	E5-SM4G	893-0110-24
252 Million TNs	E5-SM4G	893-0110-25
264 Million TNs	E5-SM4G	893-0110-26
276 Million TNs	E5-SM4G	893-0110-27
288 Million TNs	E5-SM4G	893-0110-28
300 Million TNs	E5-SM4G	893-0110-29
312 Million TNs	E5-SM4G	893-0110-30
324 Million TNs	E5-SM4G	893-0110-31
336 Million TNs	E5-SM4G	893-0110-32
348 Million TNs	E5-SM4G	893-0110-33
360 Million TNs	E5-SM4G	893-0110-34
372 Million TNs	E5-SM4G	893-0110-35
384 Million TNs	E5-SM4G	893-0110-36
150,000 NPANXXs	1 GB DSM	893-0094-01
300,000 NPANXXs	2 GB DSM	893-0094-02
100,000 LRNs	1 GB DSM	893-0105-05
150,000 LRNs	2 GB DSM	893-0105-01

***Flexible GTT Load Sharing***

The Flexible GTT Load Sharing feature allows a PC or PC/SSN combination to be provisioned in multiple load-sharing relationships for post-GTT load sharing of intermediate and final GTT traffic. Load sharing for intermediate GTT traffic requires the Intermediate GTT Load Sharing feature, which can be run in conjunction with the Flexible GTT Load Sharing feature. Intermediate GTT load sharing is performed through the MRN table, and the GTT destination is a PC. If both the Intermediate and Flexible GTT Load Sharing features are on, different load-sharing relationships can be defined between the same set of PCs, and different sets of destinations can contain the same PCs.

Load sharing for final GTT traffic is performed through the MAP table, and the GTT destination is a PC/SSN combination. If the Flexible GTT Load Sharing feature is on, different load-sharing relationships can be defined between the same set of PC/SSNs, and different sets of destinations can contain the same PC/SSN combinations.

***Weighted GTT Loadsharing***

The Weighted GTT Loadsharing feature allows a PC or PC/SSN combination to be provisioned with weights and threshold values to change the loadsharing method. This weight is relative to the weights of the PCs or PC/SSNs that have the same relative cost (RC group) and determines the relative percentage of traffic sent to the PC or PC/SSN. If the total available weight of the PCs or PC/SSNs in the RC group falls below the threshold, that RC group is not used and the next lowest RC group is used for traffic loadsharing.

***SEAS Over IP***

All database commands associated with the SEAS Over IP feature can be entered after the SEAS Over IP feature is enabled.

***SCCP Loop Detection***

The SCCP Loop Detection feature allows sets of point codes that form a routing loop in the network to be specified. These sets are linked with GTT sets and are checked during intermediate and final GTT traffic routing. If a loop exists, either the system can simply be notified or the traffic can be discarded. The SCCP Loop Detection feature requires the GTT feature and is supported only on Service Module cards; TSM cards running the **sccp** application cannot be used.

***Multiple Linksets to a Single Adjacent PC (MLS)***

The MLS feature allows multiple linksets to be established to a single adjacent destination point code.

***Voice Mail Router (V-Flex)***

The V-Flex feature allows calls to be routed to a specific voice mail server based on subscriber and call context data.

***Proxy Point Code Capacity***

The Proxy Point Code feature allows the EAGLE 5 ISS to assume the point codes of other nodes. Table 5-43 lists the total number of proxy point codes that can be provisioned in the system.

**Table 5-43.** Proxy Point Codes Feature Quantities

<b>Part Number</b>	<b>Maximum Proxy Point Codes Allowed in the System</b>
893-0187-01	10
893-0187-02	20
893-0187-03	30
893-0187-04	40
893-0187-05	50

**Table 5-43.** Proxy Point Codes Feature Quantities

Part Number	Maximum Proxy Point Codes Allowed in the System
893-0187-06	60
893-0187-07	70
893-0187-08	80
893-0187-09	90
893-0187-10	100

***E5-SM4G Throughput Capacity***

The E5-SM4G Throughput Capacity feature is a quantity feature that is used to increase the SCCP traffic processing capacity of an E5-SM4G card.

- 893-0191-01—5000 TPS
- 893-0191-02—6800 TPS

Table 5-44 displays the TPS capacities for each E5-SM4G Throughput Capacity Quantity

**Table 5-44.** TPS Capacities

Feature Quantity Part Number	Maximum TPS Capacity per E5-SM4G Card	Maximum System TPS Capacity
893-0191-01	3125	75,000 TPS with one or more EPAP-related features enabled and 24+1 cards
	5000	150,000 TPS with no EPAP-related or ELAP-related feature traffic and 31+1 cards 120,000 TPS with G-Flex and the ANSIGFLEX STP option enabled and 24+1 cards 40,000 TPS with ELAP and 8+1 cards
893-0191-02	6800	210,000 TPS with no EPAP-related or ELAP-related feature traffic and 31+1 cards 163,200 TPS with one or more EPAP-related features enabled and 24 cards 54,400 TPS with ELAP and 8+1 cards

***HIPR2***

The HIPR2 High Rate Mode feature (Part Number 893-0201-01) must be enabled before a system equipped with all HIPR2 cards can use the entire channel for data and provide a throughput rate of 2.5Gbps. If this feature is not enabled, then a system equipped with all HIPR2 cards provides an effective inter-shelf throughput rate of 1Gbps.

***Advanced GT Modification (AMGTT)***



There are three AMGTT features:

- Part number 893-0218-01: Advanced Global Title Modification (AMGTT). Allows non-MGTT customers to enable CdPA and CgPA functions after upgrade.
- Part number 893-0218-02: Advanced Global Title Modification, Called Party Only (AMGTT CdPA Only). Allows existing MGTT customers to continue using CdPA modification functions after upgrade. Does not allow any CgPA modification capabilities. The AMGTT CdPA Only feature cannot be enabled by this command. It is automatically enabled upon upgrading from the source release to EAGLE 5 ISS release 38.0 if the MGTT feature was turned on prior to the upgrade.
- Part number 893-0218-03: Advanced Global Title Modification, Calling Party Upgrade (AMGTT CgPA Upgrade). Allows existing MGTT customers to upgrade to AMGTT after upgrade to EAGLE 5 ISS release 38.0. Requires the AMGTT CdPA Only feature to be enabled, and allows full AMGTT CdPA and CgPA modification.

#### *Prepaid IDP Query Relay*

The IDPRCDPN NPP Service must be enabled before the Prepaid IDP Query Relay feature can be turned on. If the customer wants to process calling party numbers, then the IDPRCGPN NPP service must also be enabled. The following warning message appears while enabling the Prepaid IDP Query Relay feature:



**CAUTION: IDPRCDPN NPP service and possibly the IDPRCGPN service must be enabled for activating IDPR service.**

#### *MO SMS IS41-to-GSM Migration*

The MO SMS IS41-to-GSM Migration feature addresses modifications to the MO-based IS41 SMS NP feature (893-0194-01) required to meet certain IS41-to-GSM Migration call flows. This feature also allows the IS412GSM Migration Prefix to be used as a prefix instead of the RTDB RN/SP when an SMS is destined for a GSM-migrated subscriber.

#### *SLS Bit Rotation by Incoming Linkset (ISLSBR)*

The ISLSBR feature allows SLS Bit rotation to occur on an incoming linkset. This feature provides the ability to configure distribution in an ANSI or ITU network.

#### *Eagle Additional Subscriber Data*

Prepaid IDP Query Relay and TIF framework features support ASD data, which can be associated with individual subscribers and ranges. IDPR and TIF ASD/GRN features address the addition of ASD fields into the EAGLE 5 ISS. The ASD feature allows generic data to be associated with DN and DN Block subscriber records.

#### *Prepaid SMS Intercept Ph1*

The MOSMSGCDPN and MOSMSGCGPN services must be provisioned before the MO SMS Prepaid Check feature is turned on for "Prepaid SMS Intercept Ph1" to be functional. The following warning message appears while enabling the MO SMS Prepaid Check feature:



**CAUTION: MOSMSGCDPN or/and MOSMSGCGPN NPP Services must be turned on for the feature to be functional.**

#### *MO-based IS41 SMS NP and MO SMS IS41-to-GSM Migration*

The MOSMSICDPN NPP service must be provisioned before the MO-based IS41 SMS NP or the MO SMS IS41-to-GSM Migration feature is turned on for the feature to be functional. The following warning message appears while enabling these features:



**CAUTION: MOSMSICDPN NPP Services must be turned on for the feature to be functional.**

***Portability Check for MO SMS***

The MOSMSGCGPN NPP service must be enabled before the Portability Check for MO SMS feature is turned on for the feature to be functional. The following warning message appears while enabling the feature:



**CAUTION: MOSMSGCGPN NPP Services must be turned on for the feature to be functional.**

***MO-based GSM SMS NP***

The MOSMSGCDPN NPP service must be provisioned before the MO-based GSM SMS NP feature is turned on for the feature to be functional. The following warning message appears while enabling the feature:



**CAUTION: MOSMSGCDPN NPP Services must be turned on for the feature to be functional.**

***GTT Load Sharing With Alternate Routing Indicator***

The GTT Load Sharing with Alternate Routing Indicator (GTT LS ARI) feature allows loadsharing relationships to be established between the MAP and MRN table in that the MAP and MRN sets allow provisioning of MRN and MAP sets, respectively, as the Alternate Mate RI if the point codes in the MAP or MRN table are unavailable.

***ST-HSL-A SLK Capacity***

The ST-HSL-A feature allows unchannelized T1 links to be provisioned.

Table 5-45 lists the total number of unchannelized signaling links that can be assigned to HC-MIM and E5-E1T1 cards in the system when each ST-HSL-A SLK Capacity quantity feature access key is enabled.

**Table 5-45. ST-HSL-A SLK Capacity Feature Quantities**

<b>Part Number</b>	<b>Maximum ST-HSL-A Links Allowed in the System</b>
893-0273-01	4
893-0273-02	8
893-0273-03	16
893-0273-04	24
893-0273-05	32

**Table 5-45. ST-HSL-A SLK Capacity Feature Quantities**

<b>Part Number</b>	<b>Maximum ST-HSL-A Links Allowed in the System</b>
893-0273-06	40
893-0273-07	48
893-0273-08	56
893-0273-09	64
893-0273-10	72
893-0273-11	80
893-0273-12	88
893-0273-13	96
893-0273-14	104
893-0273-15	112
893-0273-16	120
893-0273-17	128
893-0273-18	136
893-0273-19	144
893-0273-20	152
893-0273-21	160
893-0273-22	168
893-0273-23	176
893-0273-24	180

***MO SMS ASD, MO SMS GRN***

The MOSMSGCGPN, MOSMSGCDPN, MOSMSICGPN, or MOSMSICDPN NPP service must be provisioned before the MO SMS ASD or MO SMS GRN feature is turned on for the feature to be functional. The following warning message appears while enabling the feature:



**CAUTION: MOSMSGCDPN, MOSMSICDPN, MOSMSGCGPN or/and MOSMSICGPN NPP Services must be turned on for the feature to be functional.**

**Output**

```

enable-ctrl-feat:partnum=893xxxxxx:fak=xxxxxxxxxxxxxxxx
tekelecstp 08-12-04 13:55:19 EST EAGLE 40.1.0
enable-ctrl-feat:partnum=893xxxxxx:fak=xxxxxxxxxxxxxxxx
Command entered at terminal #4.
ENABLE-CTRL-FEAT: MASP A - COMPLTD
;

```

**ent-acg-mic****Enter ACG Manually Initiated Control**

Use this command to assign Automatic Call Gapping (ACG) controls to certain queries. The control can apply to all queries or to specific query services and called party digits. If the EAGLE 5 ISS LNP query service receives a query to which a control applies, then the EAGLE 5 ISS sends an ACG component, encoded as configured, with the response.

**Keyword:** ent-acg-mic

**Related Commands:** chg-acg-mic, dlt-acg-mic, rept-stat-lnp, rtrv-acg-mic

**Command Class:** Database Administration

**Parameters**

**:drtn=** (mandatory)

Duration index. The amount of time that the ACG is in effect. This number is mapped to a time value at the LNP node. Refer to the chapter on Automatic Call Gapping configuration in the *LNP Feature Activation Guide* for a description of the use of the duration index.

**Range:** 1-13

**Default:** The current value

**:aintvl=** (optional)

AIN interval index

**Range:** 1-15

**Default:** The current value

**:dgts=** (optional)

Digits

**Range:** 3-10 digits

000-999, 000000-9999999999

**:intvl=** (optional)

IN Interval index. The amount of time between ACGs. This number is mapped to a time value for the LNP node. Refer to the chapter on Automatic Call Gapping configuration in the *LNP Feature Activation Guide* for a description of the use of the gap interval index.

**Range:** 0-15

**Default:** Current value

**:nd=** (optional)

Number of digits

**Range:** 3, 6-10

**Default:** The current value

**:serv=** (optional)

Query service

**Range:** ain, in

**:type=** (optional)

Type of control

**Range:** all, sd

**Default:** sd

### Example

```
ent-acg-mic:type=all:nd=6:drtn=6:intvl=2:aintvl=7
ent-acg-mic:serv=ain:dgts=9194602132:drtn=13:aintvl=1
ent-acg-mic:type=sd:serv=in:dgts=919:drtn=8:intvl=3
```

### Dependencies

If the **type=all** parameter is specified, the optional parameters **nd**, **intvl**, and **aintvl** must be specified.

If the **type=all** parameter is specified, the optional parameters **serv** and **dgts** cannot be specified.

If the **type=sd** parameter is specified, the optional parameters **serv** and **dgts** must be specified.

If the **type=sd** parameter is specified, the optional parameter **nd** cannot be specified.

If the **serv=in** parameter is specified, the optional parameter **aintvl** cannot be specified.

If the **serv=ain** parameter is specified, the optional parameter **intvl** cannot be specified.

If the **serv=in** parameter is specified, the optional parameter **intvl** must be specified.

If the **serv=ain** parameter is specified, the optional parameter **aintvl** must be specified.

The **dgts** parameter value must be specified as 3 or 6–10 digits.

The **nd** parameter value must be **3** or **6-10**.

The LNP feature must be turned on (see the **enable-ctrl-feat** command) before this command can be entered.

If the **type=all** parameter is specified, a manually initiated control (MIC) with the **type=all** parameter must not already exist.

If the **type=sd** parameter is specified, a MIC with the same service and digits must not already exist.

A maximum of 256 **type=sd** MICs are allowed.

### Notes

None

### Output

```
ent-acg-mic:type=all:nd=6:drtn=6:intvl=2:aintvl=7
rlghncxa03w 04-02-28 08:50:12 EST EAGLE 31.3.0
ACG MIC table is (11 of 256) 4% full of type SD
ENT-ACG-MIC: MASP A - COMPLTD
;
```

## ent-acg-noc

### Enter ACG Node Overload Control

Use this command to enter the values for the automatic call gapping (ACG) controls that you want to send when you reach the specified node overload level. The definition is comprised of the threshold LNP query rates for node overload levels and the values for the ACG to be sent when at the level. If a level is not defined, it is not used. Level 10 is predefined.

**Keyword:** ent-acg-noc

**Related Commands:** chg-acg-noc, dlt-acg-noc, rept-stat-lnp, rtrv-acg-noc

**Command Class:** Database Administration

## Parameters

**:drtn=** (mandatory)

Duration index. The amount of time that the ACG is in effect. This number is mapped to a time value at the LNP node. Refer to the chapter on Automatic Call Gapping configuration in the *LNP Feature Activation Guide* for a description of the use of the duration index.

**Range:** 1-13

**Default:** The current value

**:intvl=** (mandatory)

Interval index. The amount of time between ACGs. This number is mapped to a time value for the LNP node. Refer to the chapter on Automatic Call Gapping configuration in the *LNP Feature Activation Guide* for a description of the use of the gap interval index.

**Range:** 0-15

**Default:** Current value

**:lvl=** (mandatory)

Overload level.

**Range:** 1-9

**:qr=** (mandatory)

Query rate. The number of LNP queries, which define a particular overload level, in a 30-second period.

**Range:** 1-2147483647

**:and=** (optional)

AIN number of digits. The number of digits in the global title address of an AIN query.

**Range:** 6, 10

**Default:** 6

**:ind=** (optional)

IN number of digits. The number of digits in the global title address of an IN query.

**Range:** 6, 10

**Default:** 6

## Example

```
ent-acg-noc:lvl=3:qr=300000:and=10:ind=6:drtn=6:intvl=3
```

## Dependencies

The LNP feature must be turned on (see the **enable-ctrl-feat** command) before the **ent-acg-noc** command can be entered.

Either **6** or **10** must be specified for the **and** parameter.

The specified overload level must not already be defined.

Either **6** or **10** must be specified for the **ind** parameter.

## Notes

None

## Output

```
ent-acg-noc:lvl=3:qr=300000:and=10:ind=6:drtn=6:intvl=3
rlghncxa03w 04-02-28 08:50:12 EST EAGLE 31.3.0
ENT-ACG-NOC: MASP A - COMPLTD
;
```

**ent-appl-rtkey****Enter Application Route Key Table**

Use this command to configure static entries in the Routing Key table, which associates a routing key with a socket name.

There are three types of routing keys, as follows:

- DPC, SI, SSN routing keys, which are used to route SCCP messages
- DPC, SI routing keys, which are used to route non-SCCP and non-ISUP messages
- DPC, SI, CIC routing keys, which are used to route ISUP messages

**Keyword:** ent-appl-rtkey

**Related Commands:** dlt-appl-rtkey, rtrv-appl-rtkey

**Command Class:** Database Administration

**Parameters**

**NOTE:** See "Point Code Formats and Conversion" in Appendix A for a detailed description of point code formats, rules for specification, and examples.

**:asname=** (mandatory)

Application Server (AS) name assigned to this routing key.

**Range:** ayyyyyyyyyyyyyy

Up to 15 alphanumeric characters; the first character must be a letter

**:cice=** (optional)

The end range of circuit identification codes assigned to the routing key.

**Range:** 0-4294967295

See Table A-4 for valid CIC values for specified SI and MSU types.

**:cics=** (optional)

The start range of circuit identification codes assigned to the routing key. This parameter is valid only if **si=4, 5, or 13** and is required if **si=4, 5, or 13** and **type=full**.

**Range:** 0-4294967295

See Table A-4 for valid CIC values for specified SI and MSU types.

**:dpc=** (optional)

ANSI destination point code with subfields *network indicator-network cluster-network cluster member (ni-nc-ncm)*.

**Synonym:** dpca

**Range:** 000-255

Specify a valid value for each subfield of the point code, and separate the subfields with a dash (-).

When **chg-sid:pctype=ansi** is specified, **ni = 000** is not valid.

When **chg-sid:pctype=ansi** is specified, **nc = 000** is not valid if **ni = 001-005**.

When **chg-sid:pctype=ansi** is specified, **nc = 000** is valid if **ni = 006-255**.

The point code **000-000-000** is not a valid point code.

**:dpc/dpca/dpci/dpcn/dpcn24=** (optional)

Destination point code.

**:dpci=** (optional)

ITU international destination point code with subfields *zone-area-id*. The *prefix* subfield indicates a spare point code (*prefix-zone-area-id*)

**Range:** **s-, 0-255**

Specify a valid value for each subfield of the point code, and separate the subfields with a dash (-).

*prefix*—**s-**

*zone*—**0-7**

*area*—**000-255**

*id*—**0-7**

The point code **0-000-0** is not a valid point code.

**:dpcn=** (optional)

ITU national destination point code in the format of a 5-digit number (*nnnnn*); or 2, 3, or 4 numbers (members) separated by dashes (*m1-m2-m3-m4*) as defined by the **chg-stpopts:npcfnti** flexible point code option. A group code must be specified when the ITUDUPPC feature is turned on (*nnnnn-gc*, *m1-m2-m3-m4-gc*). The *prefix* subfield indicates a spare point code (*prefix-nnnnn*, *prefix-nnnnn-gc*, *prefix-m1-m2-m3-m4*, *prefix-m1-m2-m3-m4-gc*).

**Range:** **s-, 0-16383, aa-zz**

Specify a valid value for each subfield of the point code, and separate the subfields with a dash (-).

*prefix*—**s-**

*nnnnn*—**0-16383**

*gc*—**aa-zz**

*m1-m2-m3-m4*—**0-14** for each member; values must sum to 14

**:dpcn24=** (optional)

24-bit ITU national destination point code with subfields *main signaling area-sub signaling area-signaling point* (*msa-ssa-sp*).

**Range:** **000-255**

Specify a valid value for each subfield of the point code, and separate the subfields with a dash (-).

*msa*—**000-255**

*ssa*—**000-255**

*sp*—**000-255**

**:opc=** (optional)

ANSI originating point code with subfields *network indicator-network cluster-network cluster member* (*ni-nc-ncm*).

**Synonym:** **opca**

**Range:** **000-255**

Specify a valid value for each subfield of the point code, and separate the subfields with a dash (-).

When **chg-sid:pctype=ansi** is specified, *ni* = **000** is not valid.

When **chg-sid:pctype=ansi** is specified, *nc* = **000** is not valid if *ni* = **001-005**.

When **chg-sid:pctype=ansi** is specified, *nc* = **000** is valid if *ni* = **006-255**.

The point code **000-000-000** is not a valid point code.



**:opc/opca/opci/opcn/opcn24=** (optional)

Originating point code. This parameter is valid only if **si=4, 5, or 13**, and is required when **si=4, 5, or 13** and **type=full**.

**:opci=** (optional)

ITU international destination point code with subfields *zone-area-id*. The *prefix* subfield indicates a spare point code (*prefix-zone-area-id*)

**Range:** **s-, 0-255**

Specify a valid value for each subfield of the point code, and separate the subfields with a dash (-).

*prefix*—**s-**

*zone*—**0-7**

*area*—**000-255**

*id*—**0-7**

The point code **0-000-0** is not a valid point code.

**:opcn=** (optional)

New ITU national originating point code in the format of a 5-digit number (*nnnnn*); or 2, 3, or 4 numbers (members) separated by dashes (*m1-m2-m3-m4*) as defined by the **chg-stpopts:npfnti** flexible point code option. A group code must be specified when the ITUDUPPC feature is turned on (*nnnnn-gc, m1-m2-m3-m4-gc*). The *prefix* subfield indicates a spare point code (*prefix-nnnnn, prefix-nnnnn-gc, prefix-m1-m2-m3-m4, prefix-m1-m2-m3-m4-gc*).

**Range:** **s-, 0-16383, aa-zz**

Specify a valid value for each subfield of the point code, and separate the subfields with a dash (-).

*prefix*—**s-**

*nnnnn*—**0-16383**

*gc*—**aa-zz**

*m1-m2-m3-m4*—**0-14** for each member; values must sum to 14

**:opcn24=** (optional)

24-bit ITU national originating point code with subfields *main signaling area-sub signaling area-signaling point* (*msa-ssa-sp*).

**Range:** **000-255**

Specify a valid value for each subfield of the point code, and separate the subfields with a dash (-).

*msa*—**000-255**

*ssa*—**000-255**

*sp*—**000-255**

**:rcontext=** (optional)

Routing context. This parameter specifies a new routing context for a routing key. The routing context uniquely identifies the routing key.

Routing context is mandatory for routing keys associated with SUA Application Servers. Routing context is optional for routing keys associated with M3UA Application Servers.

**Range:** **0-4294967295**

**:si=** (optional)

Service indicator.

**Range:** **1-15**

**0-15** or equivalent text values:

**Number = Text—Description**

**0** = **snm**—Signaling network management messages  
**1** = **regtest**—Signaling network testing and maintenance regular  
**2** = **spltest**—Signaling network testing and maintenance special  
**3** = **sccp**—SCCP  
**4** = **tup**—Telephone user part  
**5** = **isup**—ISDN user part  
**13** = **qbicc**

**:ssn=** (optional)

Subsystem number. This parameter is valid only if **si=3** and is required if **si=3** and **type=full**.

**Range:** **0-255**

**:type=** (optional)

The type of routing key.

**Range:** **full, partial, default**

**Default:** **full**

**Example**

```
ent-appl-rtkey:asname=suaas1:dpc=8-8-8:si=3:ssn=5:rcontext=100
ent-appl-
rtkey:asname=suaas2:dpc=8-8-8:si=3:type=partial:rcontext=101
ent-appl-rtkey:asname=suaas3:dpc=8-8-8:type=partial:rcontext=102
ent-appl-rtkey:asname=suaas4:si= 3:type=partial:rcontext=103
ent-appl-rtkey:asname=suaas5:type=default:rcontext=104
ent-appl-
rtkey:asname=m3uaas1:dpc=8-8-9:si=5:opc=3-3-3:cics=1:cice=100:rc
ncontext=200
ent-appl-
rtkey:asname=m3uaas2:dpc=8-8-9:si=5:opc=3-3-3:type=partial:rconte
xt=201
ent-appl-
rtkey:asname=m3uaas3:dpc=8-8-9:si=5:type=partial:rcontext=202
ent-appl-rtkey:asname=m3uaas4:dpc=8-8-9:type=partial:rcontext=203
ent-appl-rtkey:asname=m3uaas5:si= 5:type=partial:rcontext=204
ent-appl-rtkey:asname=m3uaas6:type=default:rcontext=205
ent-appl-
rtkey:dpci=s-3-11-1:si=5:opci=s-4-11-1:cics=1:cice=1000:asname=as
itu
ent-appl-rtkey:dpc=1-1-1:si=3:asname=as1:ssn=255
ent-appl-rt-appl-
rtkey:dpci=3-11-1:si=3:opci=4-11-1:cics=1:cice=1000:asname=asitu:
rcontext=7
```

**Dependencies**

The **srkq** parameter value in the **chg-sg-opts** command limits the maximum number of static routing keys that can be provisioned using the **ent-appl-rtkey** command. For **ss7ipgw** and **ipgwi** applications running on SSED CM cards (870-2732-xx) or E5-ENET cards (870-2212-xx), there is a limit of 2500 routing keys in the system. See the **chg-sg-opts** command for parameter values that allow 2500 routing keys to be defined in the system.

The **ssn** parameter is valid only when the **si=3** (or **sccp**) parameter is specified. When the **si=3** (or **sccp**) parameter is not specified, the **ssn** parameter cannot be specified.

The value entered for the starting circuit identification code (**cics**) must be less than or equal to the value entered for the ending circuit identification code (**cice**).

The ISUP routing-over-IP feature must be turned on before a DPC/SI/CIC routing key to route ISUP messages can be specified. The ISUP routing-over-IP feature can be turned on by entering the command **chg-feat:ipisup=on**.

A circuit identification code range (**cics** to **cice**) cannot be specified that overlaps an existing routing key.

When the **si=4, 5, or 13** (or **tup, isup, or qbicc**) parameter is specified, the **opc, cics, and cice** parameters are required. The **opc, cics, and cice** parameters can be specified only if the **si=4, 5, or 13** parameter is specified. See Table A-4 for valid **cic** and **si** values for MSU types.

Partial point codes are not allowed; no asterisks can be specified in the routing key in the command.

Mixed point code types are not allowed; the types for the **opc** and **dpc** parameters must match.

A DPC/SI routing key must be specified when the DPC is ANSI and the **si=4** parameter is specified (TUP is used only in an ITU network).

When the **type=full** parameter is specified, the **dpc** and **si** parameters must also be specified.

The group codes for the **dpc** and **opc** parameter values must match when both parameters are entered in the command.

The **rcontext** parameter must be specified for routing keys that are associated with SUA Application Servers.

The specified **rcontext** parameter value must not already exist in the database.

If specified, the service indicator parameter must be **si=3** for routing keys that are associated with SUA Application Servers.

An AS cannot be simultaneously assigned to a routing key with routing contexts and routing keys without routing context.

To assign an M3UA or SUA association to multiple routing keys with routing context, the M3UA/SUA association must be assigned to more than one AS and each AS must be assigned to a routing key with routing context.

The AS name and parameters specified for a routing key must use an address format that is valid for the adapter type used by the ASP associations assigned to the AS.

If the **type=default** parameter is specified, then the **rcontext** parameter is the only optional parameter that can be specified.

The following four types of partial routing keys are supported:

- DPC/SI/OPC (ignore CIC) can be used as a partial match key for CIC- based traffic.
- DPC/SI (ignore all other fields) can be used as a partial match key for CIC- based traffic or SCCP traffic.
- DPC only (ignore all other fields) can be used as a partial match for any type of traffic.
- SI only (ignore all other fields) can be used as a partial match for any type of traffic.

The DPC entered cannot be an APC or SAPC for an IPGWx linkset. Routing keys cannot be provisioned for the fake adjacent node.

## Notes

The Routing Key table associates a routing key with a socket name or an Application Server (AS).

The routing key can be associated with up to 16 socket names or with 1 AS.

The originating point code (**opc**) and destination point code (**dpc**) must not specify a cluster route.

Group codes are required for ITU-N point codes and spare point codes (DPCN/OPCN) when the ITU Duplicate Point Code feature (ITUDUPPC) is turned on, and not allowed when the feature is off.

Routing context is a routing key parameter that uniquely identifies routing keys. Routing context is mandatory for routing keys associated with SUA Application Servers and optional for routing keys associated with M3UA Application Servers. An AS cannot be simultaneously assigned to routing keys with routing contexts and routing keys without routing contexts.

An AS cannot be simultaneously assigned to a routing key with routing contexts and routing keys without routing contexts.

An AS can be associated with multiple routing keys that do not contain routing context. An AS can be associated with only 1 routing key with routing context. To assign an M3UA or SUA association to multiple routing keys with routing context, the M3UA/SUA association must be assigned to more than one AS and each AS must be assigned to a routing key with routing context.

In this command, only ITU-international and ITU national point codes support the spare point code subtype prefix (**s-**).

## Output

```
ent-appl-rtkey:dpc=2-2-2:asname=assoc1:type=partial
  rlgncxa03w 08-04-17 15:35:05 EST EAGLE 38.0.0
  ENT-APPL-RTKEY: MASP A - COMPLTD
;
```

## ent-as

### Enter Application Server

Use this command to create an Application Server (AS) as a logical entity to serve a specific routing key. This command enters a new AS into the AS table and assigns an M3UA or SUA SCTP association to it, or assigns an M3UA or SUA SCTP association to an existing AS.

**Keyword:** ent-as

**Related Commands:** chg-as, dlt-as, rtrv-as

**Command Class:** Database Administration

## Parameters

**NOTE: The asname parameter is no longer available.**

**:aname=** (mandatory)

Name of the M3UA or SUA SCTP association.

**Range:** ayyyyyyyyyyyyyy

Up to 15 alphanumeric characters; the first character must be a letter.

**:asname=** (mandatory)

Name of the Application Server (AS).

**Range:** ayyyyyyyyyyyyyy

Up to 15 alphanumeric characters; the first character must be a letter.

## Example

```
ent-as:asname=asx:aname=asxp1
```

**Dependencies**

- The specified **aname** must exist in the IPAPSOCK table.
- The adapter layer for each association assigned to the AS must be defined.
- SUA Application Servers must have routing keys with assigned routing contexts.
- The service indicator must be **si=3** for routing keys that are associated with SUA Application Servers.
- The adapter layer must be the same for all M3UA/SUA associations assigned to the AS.
- The value specified for the **aname** parameter cannot refer to an IPLIMx or IPSG association.
- The **aname=default** parameter cannot be specified.

**Notes**

The DCM card has 16 MB of memory. Socket/association limits are based on card memory as is the ratio of associations to sockets. This ratio, known as the trade ratio, defines the number of sockets that are equivalent to one association with respect to memory consumption.

By default the AS recovery timer value is set to 200 ms when an AS is entered. This value can be changed at any time using the **chg-as** command. The new timer value will be used the next time the AS enters the AS-Pending state.

The trade ratio states the quantity of associations to sockets that may be provisioned on a certain card, as follows:

Trade Ratio = a:s

Where:

a=association : s=socket

Table 5-46 shows the maximum sockets/associations per DCM card.

**Table 5-46.** Maximum Sockets/Associations per Card

Card Type	Socket to Assoc Ratio	Max Sockets	Max Associations
DCM	8:1	50	4

**Output**

```
ent-as:asame=asx:aname=asxp1
rlghncxa03w 05-05-17 15:35:05 EST EAGLE 34.0.0
ENT-AS: MASP A - COMPLTD
;
```

**ent-assoc**

**Enter Association**

Use this command to configure the SCTP associations in the IPAPSOCK table. This command associates the local host and local port to a remote host and remote port in the IPAPSOCK table. This command provides the association to transport protocol data units and adapter layer peer messages. Each association is connected to a process on the far end.

**Keyword:** ent-assoc

**Related Commands:** chg-assoc, dlt-assoc, rtrv-assoc

**Command Class:** Database Administration

**Parameters****:aname=** (mandatory)

Name assigned to this association (in IPAPSOCK table).

**Range:** *aaaaaaaaaaaaaaaa*

Up to 15 alphanumeric characters; the first character must be a letter

**:lhost=** (mandatory)

The local host name as defined in the IP Host table.

**Range:** *aa***a-z, A-Z, 0-9, -, .**

Any string of characters beginning with a letter and comprising up to 60 characters in length

**:adapter=** (optional)

The adapter layer for this association.

**Range:** **m3ua, sua, m2pa****Default:** **m3ua** if the **lhost** is an IPGWx card and the adapter type is not specified.**m2pa** if the **lhost** is an IPLIMx or IPSG card and the adapter type is not specified.**:alhost=** (optional)

Name of alternate local host. When specified, this parameter configures the SCTP association as a multi-homed endpoint.

**Range:** *aa***a-z, A-Z, 0-9, -, . or none**

Any string of characters beginning with a letter and comprising up to 60 characters in length

**none**—the **alhost** is not configured; the SCTP association is configured as a uni-homed endpoint**:link=** (optional)

The signaling link for this association.

**Synonym:** **port****Range:** **a, b, a1-a31, b1-b31**Not all card types support all **link** parameter values.See Table A-1 for valid **link** parameter range values for each type of card that can have assigned signaling links.**Default:** **a****:lport=** (optional)

The SCTP port number for the Local Host.

**Range:** **1024-65535****Default:** **0****:m2patset=** (optional)

The M2PA timer set assigned to this association.

**Range:** **1-20****Default:** **1****:rhost=** (optional)

Name of Remote Host as defined in the IP Host table.

**Range:** *aa***a-z, A-Z, 0-9, -, .**

Any string of characters beginning with a letter and comprising up to 60 characters in length

**:rport=** (optional)  
 The SCTP port number for the Remote Host.  
**Range:** 1024-65535  
**Default:** 0

### Example

```
ent-
assoc:aname=assoc1:lhost=gw105.nc.tekelec.com:lport=1030 :rhost=gw
100.nc.tekelec.com:rport=1030:adapter=m3ua
```

### Dependencies

The association name (**aname**) must already exist in the IP Socket/Association (IPAPSOCK) table.

The hostnames specified in the **lhost** and **alhost** parameters must refer to different IP addresses.

The IP host names specified in the **lhost** and **alhost** parameters must exist in the IP Host table and must be provisioned as local to this EAGLE 5 ISS.

The hostnames specified in the **lhost** and **alhost** parameters must refer to IP addresses on the same IP card.

Only **link=a** can be specified if the card is running the **ss7ipgw** or **ipgwi** application.

Links {**a..a3, b..b3**} or {**a..a7, b..b7**} can be specified if the card running **iplim** or **iplimi** application is an SSEDCEM or E5-ENET card respectively.

To assign an association on an IPLIMx card for a local host, the signaling link associated with the signaling link port must have its **ipliml2= m2pa**.

If the **m2patset** parameter is specified, then the **adapter=m2pa** parameter must be specified.

If the card is running an **iplim** or **iplimi** application, then an association with **adapter=sua** or **m3ua** cannot be assigned as a value for the **lhost** parameter.

Association connection parameters (**lhost, rhost, lport, rport**) must be unique.

The card location for the card associated with the **lhost** and **alhost** must exist in the IP Link table.

The allowed maximum is 1 association per signaling link on IPLIMx cards.

There is a maximum of 50 connections (association-to-AS assignments + sockets) per Local Host on IPGWx cards.

A maximum of 4000 connections (association-to-AS assignments + sockets) are allowed per system.

If the value specified for the **lhost** parameter refers to an IPSG card, then the **link** parameter cannot be specified.

A maximum of 32 associations can be provisioned on an IPSG card.

Links **a, a1-a15, b, b1-b15** can be specified for an E5-ENET card running the IPSG application.

The value specified for the **host** parameter must begin with an alphabetic character and can contain **a..z, A..Z, 0..9, -** (hyphen), or **.** (period). If the host name contains a hyphen, then the host name must be enclosed within quotation marks.

### Notes

The IPAPSOCK table is used to associate the Local Host/Local Port to a Remote Host/Remote Port. This fully specifies the connection.

SCTP associations can be configured as either uni-homed or multi-homed endpoints. Uni-homed endpoints are SCTP associations configured with the **lhost** parameter specified and the **alhost** parameter not specified. In this case, the **lhost** represents an IP address that corresponds to either the A or B network of the IP application card (see **chg-ip-lnk**). Multi-homed endpoints are SCTP associations configured with both the **lhost** and **alhost** parameters specified. In this case, the **lhost**

represents an IP address corresponding to one of the networks (A or B) of the IP card while the **alhost** represents an IP address corresponding to the other network of the same IP card.

If a valid **lhost** parameter is specified that equates to a valid IP address, the **lhost** maps directly to a card location in the IP Link table, which can then determine the card's application (IPLIMx or SS7IPGWx). If the application is an IPLIMx, two additional validation checks are made:

- The **adapter** parameter value must equal **m3ua** or **m2pa**.
- The **ipliml2** value for the IPLIMx signaling link must be the same as the association **adapter** parameter value.
- The **ipliml2** value for an IPLIMx signaling link cannot be set to **m3ua**.

If the determination of the application running on the card or the signal link cannot be performed when the **ent-assoc** command is executed, the check will be performed by the **chg-assoc** command.

An association with an adapter value of **m2pa** cannot be assigned to an SS7IPGW or IPGWI host.

There are fields in the IPAPSOCK table that receive default values even though there are no parameters on this command for changing those fields. If a different value is desired, the **chg-assoc** command must be used. The **chg-assoc** command can also be used if the hostnames are too long to fit on the command line with other parameters. The fields in question and their default values are:

- open=no
- alw=no
- rmode=lin
- rmin=120
- rmax=800
- rtimes=10
- cwmin=3000
- ver=rfc
- istrms=2
- ostrms=2

For the M2PA RFC feature, when the application is IPLIMx and the **adapter=m2pa** parameter is specified, the supported M2PA version is set to M2PA RFC by default.

## Output

```
ent-
assoc:aname=assoc1:lhost=gw105.nc.tekelec.com:lport=1030 :rhost=gw
100.nc.tekelec.com:rport=1030:adapter=m3ua
    rlgncxa03w 04-02-17 15:35:05 EST  EAGLE 31.3.0
    ENT-ASSOC: MASP A - COMPLTD
;
```

## ent-card

### Enter Card

Use this command to add a card to the database. The card type and application specifies the function assigned to the card.



**Keyword:** ent-card

**Related Commands:** dlt-card, init-card, rept-stat-card, rmv-card, rst-card, rtrv-card

**Command Class:** Database Administration

### Parameters

**NOTE:** See Table A-7 for information on valid card types and applications for cards that use the ent-card command.

**NOTE:** The phrase "Service Module card" is used to mean either a Database Services Module (DSM) card or an E5-SM4G card when either type of card can be used. Both types of cards are provisioned with the type=dsm and appl=vsccp parameters.

**:appl=** (mandatory)

Application. This parameter specifies the application for the card.

**Range:** xyyyyyy

1 alphabetic character followed by up to 6 alphanumeric characters. Valid applications are:

**atmansi**—This application is used by LIM-ATM cards and E5-ATM cards to support high-speed ATM signaling links. It is also used by the E5-ATM card to support T1 functions.

**atmitu**—This application is used by E1-ATM cards and E5-ATMs card to support E1 high-speed ATM signaling links. It is also used by the E5-ATM card to support E1 functions.

**ccs7itu**—This application is used by E1/T1 MIM cards, HC-MIM cards, and E5-E1T1 cards for ITU-TSS MTP functions.

**eroute**—This application is used by STC cards and E5-STC cards for EAGLE 5 Integrated Monitoring Support functions.

**gls**—This application is used by TSM cards and E5-TSM cards for downloading gateway screening to LIM cards and Service Module cards.

**ipgwi**—This application is used by SSEDCCM cards and E5-ENET cards for TCP/IP point-to-multipoint connectivity for ITU point codes. The system allows a maximum of 125 cards to be assigned the **ipgwi** application.

**iplim**—This application is used by SSEDCCM cards and E5-ENET cards for TCP/IP point-to-point connectivity for ANSI point codes.

**iplimi**—This application is used by SSEDCCM cards and E5-ENET cards for TCP/IP point-to-point connectivity for ITU point codes.

**ips**—This application is used by IPSM cards and E5-IPSM cards for the IP User Interface feature.

**ipsg**—This application is used by E5-ENET cards (IPSG cards) to support the combined functionality of IPLIMx M2PA and IPGWx M3UA.

**mcp**—This application is used by MCPM cards for the Measurements Platform feature.

**ss7ansi**—This application is used by MPL cards, E1/T1 MIMs card, HC-MIM cards, and E5-E1T1 cards for MTP functions.

**ss7ipgw**—The application software for TCP/IP point-to-multipoint connectivity. The system allows a maximum of 125 cards to be assigned the **ss7ipgw** application.

**stplan**—This application is used by DCM cards and E5-ENET cards to support STP LAN functions.

**vsccp**—This application is used by Service Module cards to support EPAP-based features and LNP features. If no EPAP-based features or LNP features are turned on, and a Service Module card is present, the **vsccp** GPL processes normal GTT traffic.

**:loc=** (mandatory)

The card location as stenciled on the shelf of the system.

**Range:** 1101-1108, 1111-1112, 1201-1208, 1211-1218, 1301-1308, 1311-1318, 2101-2108, 2111-2118, 2201-2208, 2211-2218, 2301-2308, 2311-2318, 3101-3108, 3111-3118, 3201-3208, 3211-3218, 3301-3308, 3311-3318, 4101-4108, 4111-4118, 4201-4208, 4211-4218, 4301-4308, 4311-4318, 5101-5108, 5111-5118, 5201-5208, 5211-5218, 5301-5308, 5311-5318, 6101-6108, 6111-6118

**:type=** (mandatory)

This parameter specifies the type of hardware being added.

**Range:** *xyyyyyy*

1 alphabetic character followed by up to 6 alphanumeric characters. Valid card types are:

**dcm**—Data Communications Module card (SSEDCM or E5-ENET card). The applications for this card type are **stplan**, **iplim**, **iplimi**, **ss7ipgw**, and **ipgwi**.

**dsm**—Database Services Module (DSM) card or E5-SM4G card to support EPAP-based features, LNP features, and the GTT feature. The application for this card type is **vsccp**.

**enet**—E5-ENET card to support the IP Signaling Gateway. The application for this card type is **ipsg**.

**ipsm**—IP Services Module card (DSM-1G or E5-IPSM card) to support the IP User Interface feature. The application for this card type is **ips**.

**limatm**—LIM-ATM card or E5-ATM card to support high-speed signaling links. The application for this card type is **atmansi**.

**limds0**—Multi-port LIM (MPL) card to support signaling links with the DS0 interface. The application for this card type is **ss7ansi**.

**lime1atm**—E1-ATM card or E5-ATM card to support high-speed signaling links. The application for this card type is **atmitu**.

**lime1**—E1/T1 MIM card or HC-MIM card or E5-E1T1 card used as an E1 card or an SE-HSL card. The application types for this card type are **ss7ansi** and **ccs7itu**.

**limt1**—E1/T1 MIM card, HC-MIM card, or E5-E1T1 card used as a T1 card. The applications for this card type are **ss7ansi** and **ccs7itu**.

**limch**—E1/T1 MIM card defined as a Channel card. The applications for this card type are **ss7ansi** and **ccs7itu**.

**mcpm**—EDSM-2G card used as a Measurement Collection and Polling Module (MCPM) card for the Measurements Platform feature. The application for this card type is **mcp**.

**stc**—DCM card, SSEDCM card, or E5-ENET card used as a Signaling Transport Card (STC or E5-STC) for the EAGLE 5 Integrated Monitoring Support feature. The application for this card type is **eroute**.

**tsm**—TSM card or E5-TSM card used for Gateway Screening. The application for this card type is **gls**.

**:force=** (optional)

If the **force=yes** parameter is used to add a LIM card to the database, it is recommended that you add the required number of Service Module cards to the database after the LIM card is added to avoid the loss of global title translation (GTT) traffic.

**Range:**     yes, no  
**Default:**   no

### Example

```
ent-card:loc=1206:type=limatm:appl=atmansi:force=yes
ent-card:loc=1208:type=limatm:appl=atmansi:force=no
ent-card:loc=1206:type=limds0:appl=ss7ansi
ent-card:loc=1105:type=enet:appl=ipsg
```

### Dependencies

**NOTE:** The LNP feature is "turned on" when an LNP ported TNs quantity is shown in the `rtrv-ctrl-feat` command output. An LNP quantity feature access key has been enabled and turned on. See the `enable-ctrl-feat` command for more information about enabling and turning on the LNP feature.

For features that are enabled with the `enable-ctrl-feat` command, use the `rtrv-ctrl-feat` command to verify whether a feature is enabled or turned on.

For features that are turned on with the `chg-feat` command, use the `rtrv-feat` command to display the **on** or **off** status of the features.

Table A-7 shows the card names, the only valid card type (**type** parameter) and application (**appl** parameter) combinations, the card part numbers, and the maximum number of cards allowed in the database.

The card location must not be **1113-1118**, or *xy* **09** and *xy* **10** where *x* is the frame and *y* is the shelf.

The specified shelf location must be provisioned and present in the frame.

The specified card location cannot already be provisioned in the database.

The DSM card must be inserted into an odd-numbered location. The *n*+1 slot next to the DSM card must be empty, where *n* is the odd-numbered location (for example, if the DSM card is in location 1101, then the 1102 slot must be empty and unprovisioned).

The Measurements Platform feature must be turned on before the command can be entered for an MCPM card (**:type=mcpm:appl=mcp**).

The following applications are valid for the **appl** parameter: **ss7ansi**, **gls**, **ccs7itu**, **stplan**, **atmansi**, **iplim**, **iplimi**, **ss7ipgw**, **vsccp**, **atmitu**, **ipgwi**, **ips**, **eroute**, **mcp**, **ipsg**.

The *n*+1 slot next to the DSM or HC-MIM card must be empty, where *n* is the odd-numbered location (for example, if the DSM card is in location 1101, then the 1102 slot must be empty and unprovisioned).

The GTT feature must be turned on to specify the **appl=vsccp** parameter.

The GWS feature must be turned on to specify the **appl=gls** parameter.

The LAN feature must be turned on to specify the **appl=stplan** parameter.

The valid card types (**type** parameter) are **limds0**, **tsm**, **limatm**, **dcm**, **dsm**, **stc**, **lime1**, **limt1**, **limch**, **mcpm**, **lime1atm**, **ipsm**, **enet**.

Table A-7 lists the maximum number of cards of each card type and application that are allowed in the system.

If any EPAP-based features or LNP features are turned on, or the ATINP feature is enabled, then a maximum of 25 Service Module cards is allowed in the system. If the system is running only GTT, a maximum number of 32 Service Module cards is allowed in the system.

All provisioned shelves must contain HIPR cards before more than 115 LIM-ATM cards can be provisioned.

If the **force** parameter is not specified or has a value of **no**, then the increased GTT TPS from the new card must be within the Eagle current TPS rating.

## Notes

### *ITU Environment*

Each DSM card can handle 1700 transactions per second.

When the **ent-card** command is entered to add a card that requests service from a DSM card, the EAGLE 5 ISS adds the current TPS level to the estimated TPS level for the new card. The EAGLE 5 ISS uses the following values to derive the TPS estimate: 53 for low-speed links (cards provisioned as SS7ANSI or CCS7ITU), 480 for ATM, and 1000 for IPLIM cards. The EAGLE 5 ISS then compares the sum to a user-configured threshold (SCCP TPS Threshold) that is set using the **chg-th-alm** command. The purpose of the SCCP TPS threshold is to generate an alarm if the threshold is exceeded. The SCCP TPS threshold also triggers an error message if the **ent-card** command is issued and the resulting TPS level (the current TPS plus the estimated TPS for the new card) would be greater than the configured threshold:

```
E3715: Cmd Rej - Insufficient #SCCP cards to support LIM - use FORCE=YES
The force parameter can be specified to add the card even if its addition would exceed the SCCP TPS threshold. If the force=yes parameter is specified, the command is accepted but the following warning message appears:
```

```
WARNING: System current rated TPS unable to support additional SS7 card =
use FORCE=YES.
```

If the **force=yes** parameter is specified, it is recommended that the required number of Service Module cards be added to the database after the LIM card is added. This action avoids the loss of GTT traffic. Another option is to add additional Service Module cards or to increase the SCCP TPS threshold, and then add the LIM card. This action prevents the alarm from being triggered. For additional information on using the **force** parameter, see Chapter 4, "System Administration Procedures" of the *Database Administration Manual - System Management*.

### *ANSI Environment*

In an ANSI environment with only the G-Flex feature turned on, only DSM cards in the system and the **ansigflex** system option enabled, each DSM card can handle up to 1700 TPS.

### *LIM Cards*

The MPL cards support only the LIMDS0 interface, and the **appl** value must be **ss7ansi**. The MPL cards support 8 ports, namely **a**, **b**, **a1**, **b1**, **a2**, **b2**, **a3**, and **b3**. The **rtrv-card** command displays the status of all ports of the MPL cards.

The EAGLE 5 ISS cannot contain more than 115 provisioned LIM-ATM cards unless every provisioned shelf contains HIPR cards. The EAGLE 5 ISS checks the card configuration when the **ent-card** command is used to add a LIM-ATM card.

Using the **dlt-card** command to reduce the ATM card count takes the card out of service.

### *STC Cards*

"STC cards" are SSEDCEM cards and E5-ENET cards that run the **eroute** application.

The **type=stc** and **appl=eroute** parameters apply only when the EAGLE 5 Integrated Monitoring Support (E5IS) feature is turned on.

An "n+1" STC configuration is required to provide redundancy: therefore, a minimum of two STC cards must be provisioned in the EAGLE 5 ISS. If single-slot STC cards are provisioned in the database, then a minimum of two single-slot STC cards must be provisioned in the EAGLE 5 ISS. For "n+1" redundancy purposes, a dual-slot STC card cannot be used to replace a single-slot STC card, and a DCM card cannot be used to replace an E5-ENET card.

The EAGLE 5 ISS can contain a maximum of 32 STC cards.

E5-ENET cards cannot be provisioned on a shelf that contains HMUX cards. If a shelf contains HMUX cards, then any E5-STC cards must be provisioned in shelves adjacent to the shelf containing the cards being monitored. The optimum configuration is to provision half of the STC cards in the previous shelf and half in the next shelf.

If non-E5-ENET cards are used as STC cards, then a maximum of 3 cards can be provisioned in a shelf that contains HMUX cards.

HIPR cards must be installed on any shelf that contains E5-STC cards.

HIPR and HMUX cards cannot be used at the same time in the shelf during normal operation.

If a shelf contains HIPR cards, then the STC cards must be provisioned in the same shelf that contains the cards or links being monitored. A maximum of 4 E5-STC cards can be provisioned on a shelf that contains HIPR cards. A maximum of 16 non-E5-ENET cards that are acting as STC cards can be provisioned on a shelf that contains HIPR cards.

If IP signalling links are being monitored, then only single-slot STC cards can be provisioned. HIPR cards must be used in the shelves where the IP links are located.

#### ***DCM Cards***

The SSEDCCM card occupies only one slot in an EAGLE 5 ISS shelf. The provisioning rules for DCM/STC cards allow provisioning of any slot where a DCM or STC card can physically be inserted. If the slot is provisioned for a DCM card, an E5-ENET card can be inserted instead of a DCM card for **stplan** and an E5-ENET or SSEDCCM card for **iplim** or **ipgw** applications. The slot located immediately to the right of an SSEDCCM card can also be provisioned.

#### ***Cards Running the STPLAN Application***

Either DCM cards or E5-ENET cards can be provisioned to run the STPLAN application.

An "n+1" STP LAN configuration is required to provide redundancy: therefore, a minimum of two cards running the STPLAN application (E5-SLAN cards) must be provisioned in the EAGLE 5 ISS. A minimum of 2 E5-SLAN cards must be provisioned in the EAGLE 5 ISS. For "n+1" redundancy purposes. A DCM card cannot be used to replace an E5-SLAN card.

E5-ENET cards cannot be provisioned on a shelf that contains HMUX cards. If a shelf contains HMUX cards, then the E5-SLAN cards must be provisioned in shelves adjacent to the shelf containing the cards being monitored. The optimum configuration is to provision half of the E5-SLAN cards in the previous shelf and half in the next shelf.

If DCM cards are used to run the STPLAN application, then up to 16 cards can be provisioned in a shelf that contains HMUX cards.

HIPR cards must be installed on any shelf that contains E5-SLAN cards.

HIPR and HMUX cards cannot be used at the same time in the shelf during normal operation.

If a shelf contains HIPR cards, then the cards used to run the STPLAN application (either DCM or E5-SLAN cards) must be provisioned in the same shelf that contains the cards or links being monitored. A maximum of 2 E5-SLAN cards and up to 16 DCM cards can be provisioned on a shelf that contains HIPR cards.

#### ***E5-SM4G Cards***

If an LNP feature quantity that is greater than 192 million numbers and less than 240 million numbers is present in a node, and there is an attempt to insert an E5-SM4G card, then the E5-SM4G card auto-inhibits (see the **alw-card** command).

Two HIPR cards must be installed on each shelf where an E5-SM4G card is installed.

#### ***E5-IPSM Cards***

Two HIPR cards must be installed on each shelf where an E5-IPSM card is installed.

A maximum of three E5-IPSM cards, IPSM cards, or a combination of both cards is supported for a single EAGLE 5 ISS node, on any shelf or combination of shelves.

#### **IPSG Cards**

IPSG cards are E5-ENET cards running the IP Signaling Gateway application (**appl=ipsg** and **type=enet**). The IPSG application combines the functionality of IPLIMx M2PA and IPGWx M3UA. A maximum of 100 IPSG cards are allowed per node, independently of other card types.

#### **E5-ATM Cards**

The E5-ATM card supports both ANSI and ITU implementations and can be used to replace the LIM-ATM and E1-ATM cards. The LIM-ATM and E1-ATM cards continue to be supported.

The E5-ATM card can support 2 ATM signaling links, operating at 1 Erlang. If the **b** signaling link is provisioned, then the card slot is no longer compatible with the LIM-ATM or E1-ATM cards.

HIPR cards must be installed on any shelf that contains E5-ATM cards.

#### **IP Signaling Capacity Guidelines**

System limits on the total number of cards allowed in the system are not enforced by the **ent-card** command. The total IP Signaling TPS for the system cannot exceed 500,000 TPS.

#### **E5-TSM Cards**

A maximum of eight cards - E5-TSM cards, TSM cards, or a combination of both cards - is supported for a single EAGLE 5 ISS node, on any shelf or combination of shelves, to support the **gls** application for Gateway Screening. Two HIPR cards must be installed on each shelf where an E5-TSM card is installed.

#### **Fast Copy Cards**

A card that can run the Fast Copy interface is referred to as an *FC-capable* card. Currently, E5-ENET cards running the **ipsg** application are the only supported FC-capable cards. After the **fmode=fcopy** parameter (see the **chg-eisopts** command) is specified for an FC-capable card, the card is referred to as an *FC-enabled* card.

### Output

```
ent-card:loc=1206:type=linds0:appl=ss7ansi
  r1ghncxa03w 06-06-01 11:11:28 EST EAGLE 35.0.0
  ENT-CARD: MASP A - COMPLTD
;
```

### ent-csl

### Enter Common Screening List

Use this command to enter new screening data into the Common Screening List (CSL). The Common Screening List commands are used to tailor certain types of general screening information to specific features.

**Keyword:** ent-csl

**Related Commands:** chg-csl, dlt-csl, rtrv-csl, rtrv-ctrl-feat

**Command Class:** Database Administration

### Parameters

**NOTE:** See "Point Code Formats and Conversion" for a detailed description of point code formats, rules for specification, and examples.

**:ds=** (optional)

Digit string. This parameter specifies a unique string of digits that is used by the specified screening feature.

Either the **ds** parameter or the **pc** parameter must be specified. Both parameters cannot be specified in the same command

**Range:** 1-15 digits  
Valid digits are **0-9, a-f, A-F**.

- 1-6 digits—Prepaid IDP Query Relay **ccnc** list
- 1-15 digits—Prepaid IDP Query Relay **gt** list
- 1-10 digits—Prepaid IDP Query Relay **skbcsm** list
- 4 digits—IDP Screening for Prepaid **skts** list
- 1-15 digits—IDP Screening for Prepaid **insl** list
- 1-15 digits—VFLEX **vmpfx** list
- 1-6 digits—Info Analyzed Relay Base **ccnc** list
- 1-15 digits—Info Analyzed Relay Base **gt** list
- 2 digits—Info Analyzed Relay Base **trig** list

Table 5-47 lists valid hexadecimal values for the Info Analyzed Relay Base **trig** list **ds** entries.

**:feature=** (optional)

Feature name. This parameter specifies the name of the enabled feature for which the command is entered.

Either the **pn** parameter or the **feature** parameter must be specified to identify the feature.

**Range:** *aaaaaaaaaaaaaaaaaaaaaaaa*

1 alphabetic character followed by up to 24 optional alphanumeric characters, including spaces and special characters, enclosed in double quotation marks (" ").

- IDP Screening for Prepaid
- Info Analyzed Relay Base
- Prepaid IDP Query Relay
- VFLEX

**:list=** (optional)

This parameter specifies the name of the Common Screening List associated with the feature.

The **list** parameter must be specified when the feature uses more than one type of Common Screening List.

**Range:** **gt, skbcsm, ccnc, skts, insl, vmpfx, trig, delpfx**

- gt**— Global Title List
- skbcsm**— SK+BCSM List
- ccnc**— CC+NC List
- skts**— SK+TS List
- insl**— In Network Subscriber List
- vmpfx**— Voice Mail Prefix List
- trig**— Trigger List
- delpfx**— Delete Prefix List

The following screening lists are valid for the indicated features:

- **skts, insl**—IDP Screening for Prepaid
- **ccnc, gt**—Prepaid IDP Query Relay and Info Analyzed Relay Base
- **skbcsm**—Prepaid IDP Query Relay
- **vmpfx**—VFLEX

- **trig**—Info Analyzed Relay Base

The **delpfx** list is not supported at this time. This list should only be used by Tekelec personnel.

**:p1=** (optional)

Parameter value 1. This parameter value is specific to the feature and list using the parameter.

**NOTE: Currently, only the Prepaid IDP Query Relay (IDP Relay) feature uses this parameter.**

**Range:** *zzzzzzzz*

Valid values are **0, 1, 3-35 (Prepaid1-Prepaid32), 255 (Prepaidno)**

**0, 1-gt** list

**3-35 (Prepaid1-Prepaid32 ), 255 (Prepaidno)-skbcsm** list

**:p2=** (optional)

Parameter 2. The parameter value is specific to the feature and list name that use this parameter. No feature currently uses this parameter.

**:p3=** (optional)

Parameter 3. The parameter value is specific to the feature and list name that use this parameter. No feature currently uses this parameter.

**:pc=** (optional)

ANSI point code with subfields *network indicator-network cluster-network cluster member (ni-nc-ncm)*.

**Synonym:** **pca**

**Range:** **000-255**

Specify a valid value for each subfield of the point code, and separate the subfields with a dash (-).

When **chg-sid:pctype=ansi** is specified, **ni = 000** is not valid.

When **chg-sid:pctype=ansi** is specified, **nc = 000** is not valid if **ni = 001-005**.

When **chg-sid:pctype=ansi** is specified, **nc = 000** is valid if **ni = 006-255**.

The point code **000-000-000** is not a valid point code.

**:pc/pca/pci/pcn/pcn24=** (optional)

Point code. Either the **ds** parameter or a point code parameter must be specified.

**:pci=** (optional)

ITU international point code with subfields *zone-area-id*.

**Range:** **0-255**

Specify a valid value for each subfield of the point code, and separate the subfields with a dash (-).

The point code **0-000-0** is not a valid point code.

*zone*—**0-7**

*area*—**000-255**

*id*—**0-7**

**:pcn=** (optional)

ITU national destination point code in the format of a 5-digit number (*nnnnn*); or 2, 3, or 4 numbers (members) separated by dashes (*m1-m2-m3-m4*) as defined by the **chg-stpopts:npcfmti** flexible



point code option. A group code must be specified when the ITUDUPPC feature is turned on (*nnnnn-gc, m1-m2-m3-m4-gc*).

**Range:** **s-, 0-16383, aa-zz**

Specify a valid value for each subfield of the point code, and separate the subfields with a dash (-).

*prefix*—**s-**

*nnnnn*—**0-16383**

*gc*—**aa-zz**

*m1-m2-m3-m4*—**0-14** for each member; values must sum to 14

**:pcn24=** (optional)

24-bit ITU national point code with subfields *main signaling area-sub signaling area-signaling point (msa-ssa-sp)*.

**Range:** **000-255**

Specify a valid value for each subfield of the point code, and separate the subfields with a dash (-).

*msa*—**000-255**

*ssa*—**000-255**

*sp*—**000-255**

**:pn=** (optional)

Part number. This parameter specifies the 9-digit "893xxxxxx" part number of the feature for which the command is entered. The **rtrv-ctrl-feat** command description shows the part number in the command output example.

Either the **pn** parameter or the **feature** parameter must be specified to identify the feature.

**Range:** **893000000-893999999**

The first 3 digits are **893**. Do not separate the digits with dashes or spaces. The following part numbers are valid for this command:

- **893015501**—IDP Screening for Prepaid
- **893034201**—Info Analyzed Relay Base
- **893016001**—Prepaid IDP Query Relay
- **893016701**—VFLEX

### Example

```
ent-csl:feature="Prepaid IDP Query Relay":list=ccnc:ds=123456
```

```
ent-csl:pn=893015001:list=insl:ds=123456789bcdEF
```

### Dependencies

An enabled feature must be specified using either a valid part number (the **pn** parameter) or feature name (the **feature** parameter). The specified feature must use a Common Screening List.

The feature that is specified in the **feature** parameter must be enabled.

The **list** parameter must be specified for features that use more than one type of screening list.

The value specified for the **list** parameter must be valid for the specified screening list. The following **list** parameter values are valid for the indicated feature:

- **skts, insl**—IDP Screening for Prepaid
- **ccnc, gt**—Prepaid IDP Query Relay or Info Analyzed Relay Base

- **trig**—Info Analyzed Relay Base
- **skbcm**—Prepaid IDP Query Relay
- **vmpfx**—VFLEX

The length of the digit string that is specified for the **ds** parameter must be valid for the screening feature and list type.

A valid **ds** parameter value is required for the specified feature and list type.

The following parameters are allowed with the indicated common screening list type:

- **list=gt**—**ds** parameter
- **list=ccnc**—**ds** parameter
- **list=skbcm**—**ds** parameter
- **list=skts**—**ds** parameter
- **list=insl**—**ds** parameter
- **list=vmpfx**—**ds** parameter
- **list=trig**—**ds** parameter

The leading digit pattern of the value specified for the **ds** parameter must be unique in the specified screening list for the indicated feature.

Each list table is allowed to contain a maximum number of entries:

- IDP Screening for Prepaid
  - **insl**—50 entries
  - **skts**—25 entries
- Prepaid IDP Query Relay
  - **ccnc**—20 entries
  - **gt**—50 entries
  - **skbcm**—25 entries
- VFLEX
  - **vmpfx**—100 entries
- Info Analyzed Relay Base
  - **ccnc**—20 entries
  - **gt**—50 entries
  - **trig**—150 entries

The **pc** and **ds** parameters cannot be specified together in the command.

The value specified for the feature parameter must be a valid feature name for a feature that uses a Common Screening List. The feature name must be specified as it appears in the **rtrv-ctrl-feat**

command output. Enough of the name must be specified to make the name unique when two features begin with the same word or acronym.

**Notes**

None

Table 5-47 lists the decimal values, the hexadecimal values, and the mnemonic for each TRIGTYPE code that can appear in the CSL TRIG list.

**Table 5-47. TRIGTYPE Hexadecimal Codes**

Hex	Decimal	Mnemonic	Hex	Decimal	Mnemonic
00	0	Unspecified	1A	26	Inter-LATA_Toll_Call.
01	1	All_Calls.	1B	27	World_Zone_Call.
02	2	Double_Introducing_Star.	1C	28	International_Call.
03	3	Single_Introducing_Star.	1D	29	Unrecognized_Number.
04	4	Reserved	1E	30	Prior_Agreement.
05	5	Double_Introducing_Pound.	1F	31	Specific_Called_Party_Digit_String
06	6	Single_Introducing_Pound.	20	32	Mobile_Termination
07	7	Revertive_Call.	21	33	Advanced_Termination
08	8	0_Digit.	22	34	Location
09	9	1_Digit.	23	35	Locally_Allowed _Specific_Digit_String
0A	10	2_Digit.	24	36	Orgination_Atempt_Authorized.
0B	11	3_Digit.	25	37	Calling_Routing_Address_Available.
0C	12	4_Digit.	26	38	Initial_Termination
0D	13	5_Digit.	27	39	Called_Routing_Address_Available
0E	14	6_Digit.	29	40	O_Answer.
0F	15	7_Digit.	29	41	O_Disconnect.
10	16	8_Digit.	2A	42	O_Called_Party_Busy.
11	17	9_Digit.	2B	43	O_No_Answer.
12	18	10_Digit.	40	64	Terminating_Resource_Available
13	19	11_Digit.	41	65	T_Busy.
14	20	12_Digit.	42	66	T_No_Answer.
15	21	13_Digit.	43	67	T_No_Page_Response.
16	22	14_Digit.	44	68	T_Unroutable.

Table 5-47. TRIGTYPE Hexadecimal Codes

Hex	Decimal	Mnemonic	Hex	Decimal	Mnemonic
17	23	15_Digit.	45	69	T_Answer.
18	24	Local_Call.	46	70	T_Disconnect.
19	25	Intra-LATA_Toll_Call.			

### Output

```
ent-csl:feature="VFLEX":list=vmpfx:ds=123456789abcdef
tekelecstp 08-05-22 13:53:59 EST EAGLE 39.0.0
VM Prefix List table is (1 of 100) 1% full
ENT-CSL: MASP A - COMPLTD
;
```

### ent-cspc

### Enter Concerned Signaling Point Code

Use this command to add signaling points to a current broadcast signaling point code group. These point codes are notified of the receipt by the system of subsystem-prohibited (SSP) and subsystem-allowed (SSA) SS7 SCCP management messages from an application at an adjacent signaling point and subsystem. This command can also be used to add new groups to the table.

**NOTE: The command must be entered first with the group only (no point code); then the command must be entered again with the group code and the point code.**

**Keyword:** ent-cspc

**Related Commands:** dlt-cspc, rtrv-cspc

**Command Class:** Database Administration

### Parameters

**NOTE: See "Point Code Formats and Conversion" in Appendix A for a detailed description of point code formats, rules for specification, and examples.**

**:grp=** (mandatory)

Name of the group. This parameter is a character string associated with this broadcast list.

**Range:** ayyyyyy

1 alphabetic character followed by up to 7 alphanumeric characters

**:pc=** (optional)

ANSI point code with subfields *network indicator-network cluster-network cluster member (ni-nc-ncm)*.

**Synonym:** pca

**Range:** 000-255

Specify a valid value for each subfield of the point code, and separate the subfields with a dash (-).

When **chg-sid:pctype=ansi** is specified, *ni = 000* is not valid.

When **chg-sid:pctype=ansi** is specified, *nc = 000* is not valid if *ni = 001-005*.

When **chg-sid:pctype=ansi** is specified, *nc = 000* is valid if *ni = 006-255*.

The point code **000-000-000** is not a valid point code.

**:pc/pca/pci/pcn/pcn24=** (optional)

Point code.

This parameter is mandatory when the group and point code are entered, after the group has been entered.

**:pci=** (optional)

ITU international point code with subfields *zone-area-id*. The *prefix* subfield indicates a spare point code (*prefix-zone-area-id*)

**Range:** **s-, 0-255**

Specify a valid value for each subfield of the point code, and separate the subfields with a dash (-).

*prefix*—**s-**

*zone*—**0-7**

*area*—**000-255**

*id*—**0-7**

The point code **0-000-0** is not a valid point code.

**:pcn=** (optional)

ITU national point code in the format of a 5-digit number (*nnnnn*); or 2, 3, or 4 numbers (members) separated by dashes (*m1-m2-m3-m4*) as defined by the **chg-stpopts:npfnti** flexible point code option. A group code must be specified when the ITUDUPPC feature is turned on (*nnnnn-gc*, *m1-m2-m3-m4-gc*). The *prefix* subfield indicates a spare point code (*prefix-nnnnn*, *prefix-nnnnn-gc*, *prefix-m1-m2-m3-m4*, *prefix-m1-m2-m3-m4-gc*).

**Range:** **s-, 0-16383, aa-zz**

Specify a valid value for each subfield of the point code, and separate the subfields with a dash (-).

*prefix*—**s-**

*nnnnn*—**0-16383**

*gc*—**aa-zz**

*m1-m2-m3-m4*—**0-14** for each member; values must sum to 14

**:pcn24=** (optional)

24-bit ITU national point code with subfields *main signaling area-sub signaling area-signaling point* (*msa-ssa-sp*).

**Range:** **p-, 000-255**

Specify a valid value for each subfield of the point code, and separate the subfields with a dash (-).

*prefix*—**p-**

*msa*—**000-255**

*ssa*—**000-255**

*sp*—**000-255**

## Example

When the ANSI-ITU-China SCCP Conversion feature is not on, a CSPC group can contain point codes of only one network type.

```
ent-cspc:grp=grp01:pc=144-201-001
```

```
ent-cspc:grp=group02:pcn24=10-100-10
```

When the ANSI-ITU-China SCCP Conversion feature is on, a CSPC group can contain point codes of more than one network type. ITU-N and ITU-N24 point codes are not allowed in the same group.

```

ent-cspc:grp=grp01
ent-cspc:grp=grp01:pc=240-3-55
ent-cspc:grp=grp01:pci=7-233-5
ent-cspc:grp=grp01:pci=s-7-233-5
ent-cspc:grp=grp01:pcn24=234-56-245

```

### Dependencies

Reserved words (for example, “**none**”) cannot be used to name a group.

The specified CSPC Broadcast group name must not exist if a point code is not specified. If the specified group name does not exist, and a point code is not specified, a new group is created.

The Spare Point Code Support feature must be enabled before the spare point code prefix **s-** can be specified for an ITU-I or ITU-N point code.

If the CSPC group name and a point code are specified, the group name must exist in the database.

The specified point code must exist in the Routing Table and cannot already exist in the specified group.

The destination point code must be a full point code (*ni-nc-ncm*).

The concerned signaling point code must have been specified previously as a full point code destination, or it must be a member of a previously specified cluster.

A maximum of 2550 Concerned Signaling Point Code Broadcast groups can be defined.

A maximum of 96 point codes can be defined for each group.

When the ANSI-ITU-China SCCP Conversion feature is not on, the first point code to be entered defines the network type for the group. All subsequent point codes for the group must be for the same network type. For example,

- **pc** and **pca** cause the group to be an ANSI group
- **pci** causes the group to be an ITU international group
- **pcn** causes the group to be an ITU national group
- **pcn24** causes the group to be a 24-bit ITU national group, which is administered as a subset of an ITU national group

When the ANSI-ITU-China SCCP Conversion feature is on, the point codes in a group can be of different network types. The only exception is that **pcn** and **pcn24** point codes are not allowed in the same group.

The point code must exist in the routing table.

A routeset and link that provides a path to the new CSPC must be configured before the **ent-cspc** command can be entered.

### Notes

To broadcast SSPs and SSAs to one or more mated applications, each mate’s point code must be added to the CSPC group. Otherwise the broadcast is not sent to the mate.

In this command, only ITU-international and ITU national point codes support the spare point code subtype prefix (**s-**).

**Output**

The command must be entered with just the **grp** parameter to define a new group in the database.

```
ent-cspc:grp=grp01
  rlgncxa03w 04-01-07 11:43:04 EST EAGLE 31.3.0
  ENT-CSPC: MASP A - COMPLTD
;
```

The command must specify an existing group and a point code to add the point code to the group.

```
ent-cspc:grp=grp01:pc=144-201-001
  rlgncxa03w 04-01-07 11:43:04 EST EAGLE 31.3.0
  ENT-CSPC: MASP A - COMPLTD
;
```

**ent-dlk****Enter Data Link**

Use this command to add a TCP/IP data link to the database. The TCP/IP data link is used to send copies of SS7 MSUs (selected by the gateway screening feature) to a remote host for further processing.

**Keyword:** ent-dlk

**Related Commands:** act-dlk, canc-dlk, dlt-dlk, rept-stat-dlk, rtrv-dlk, tst-dlk

**Command Class:** Database Administration

**Parameters**

**:ipaddr=** (mandatory)

The TCP/IP data link's IP address. This is a TCP/IP address expressed in standard dot notation. IP addresses consist of the system's network number and the machine's unique host number. An example IP address is **192.126.100.5**, where **192.126.100** is the network number and **5** is the machine's host number.

**Range:** **1-223, 0-255**  
 4 numbers separated by dots  
**1-223**—first number  
**0-255**—the other three numbers

**:loc=** (mandatory)

The card location as stenciled on the shelf of the system.

**Range:** **1101-1108, 1111-1112, 1201-1208, 1211-1218, 1301-1308, 1311-1318, 2101-2108, 2111-2118, 2201-2208, 2211-2218, 2301-2308, 2311-2318, 3101-3108, 3111-3118, 3201-3208, 3211-3218, 3301-3308, 3311-3318, 4101-4108, 4111-4118, 4201-4208, 4211-4218, 4301-4308, 4311-4318, 5101-5108, 5111-5118, 5201-5208, 5211-5218, 5301-5308, 5311-5318, 6101-6108, 6111-6118**

**:auto=** (optional)

Automatic. This parameter specifies whether the hardware automatically determines duplex and speed.

This parameter is valid only for DCM cards (running the **vwxslan** GPL) or E5-ENET cards (running the **slanhc** GPL)

**Range:** **yes, no**  
**yes**—Duplex and speed are automatically determined.  
**no**—Duplex and speed are not automatically determined.

**Default:** **yes**

**:duplex=** (optional)

This parameter specifies the mode of operation of the interface.

This parameter is valid only for DCM cards (running the **vwxsln** GPL) or E5-ENET cards (running the **slanhc** GPL).

**Range:**     **half, full**

**half**— The mode of operation of the interface is half duplex.

**full**— The mode of operation of the interface is full duplex.

**Default:**   **half**

**:speed=** (optional)

This parameter specifies the bandwidth for the interface in megabits per second.

**Range:**     **10, 100**

**Default:**   **10**

### Example

```
ent-dlk:loc=1201:ipaddr=196.3.202.45
```

```
ent-dlk:loc=1101:ipaddr=192.168.63.11:speed=10:duplex=half
```

```
ent-dlk:loc=1107:ipaddr=192.168.63.12:auto=yes
```

### Dependencies

The shelf and card must be equipped.

The IP address (**ipaddr**) cannot be in the TCP/IP link table and cannot be a TCP/IP node.

The specified card cannot contain any data links.

The specified card's status must be out of service maintenance disabled (OOS-MT-DSBLD). Enter the **rept-stat-card** command to verify the state of the card.

The specified TCP/IP data link cannot be in the database.

The specified card must be running the **stplan** GPL.

The Gateway Screening feature and the STPLAN feature must be turned on before this command can be entered.

The first octet of the IP Address must not be **127**, because **127** represents an IP address for loopback.

If the **auto=yes** parameter is specified, then the **speed** and **duplex** parameters cannot be specified.

If the **type=acmenet** parameter is specified (see the **ent-card** command), then the **duplex** and **auto** parameters cannot be specified.

The **speed** and **duplex** parameters must be specified together in the command.

If the **speed=100** parameter is specified, then a DCM card (running the **vwxsln** GPL) or an E5-ENET card (running the **slanhc** GPL) must be used. The **type=dcn** parameter must be specified in the **ent-card** command.

### Notes

If the first octet of the IP address is **127**, an error message is issued because the number **127** represents a loopback address.

The value of the **ipaddr** parameter cannot match the TCP/IP default router's IP address (the **iprte** parameter of the **ent-ip-node** command).



**Output**

```
ent-dlk:loc=1201:ipaddr=196.3.202.45
tekelecstp 07-04-03 11:12:34 EST EAGLE 37.0.0
ENT-DLK: MASP A - COMPLTD
;
```

The following example issues an error message because the first octet of the IP address is a loopback address.

```
ent-dlk:loc=1201:ipaddr=127.3.202.45
rlghncxa03w 07-04-03 11:43:04 EST EAGLE 37.0.0
Command Rejected : First octet of IPADDR cannot be 127.
ENT-DLK: MASP A - COMPLTD
;
```

**ent-dstn****Enter Destination**

Use this command to add a destination address (a destination point code, capability point code, or network cluster address) and the associated destination attributes to the destination point code table.



**CAUTION:** When using the Network Routing feature, limited network management is provided for point codes not covered by full point code routing, Cluster Routing, or Nested Cluster Routing.

**Keyword:** ent-dstn

**Related Commands:** chg-dstn,, dlt-dstn, dlt-rte, ent-rte, rept-stat-dstn, rept-stat-rte, rtrv-dstn, rtrv-rte

**Command Class:** Database Administration

**Parameters**

**NOTE:** See "Point Code Formats and Conversion" for a detailed description of point code formats, rules for specification, and examples.

**:dpc=** (mandatory)

ANSI destination point code with subfields *network indicator-network cluster-network cluster member (ni-nc-ncm)*. The *prefix* subfield indicates a private point code (*prefix-ni-nc-ncm*).

**Synonym:** dpca

**Range:** p-, 000-255, \*

Specify a valid value for each subfield of the point code, and separate the subfields with a dash (-).

*prefix—p-*

The asterisk value (\*) is not valid for the *ni* subfield.

When **chg-sid:pctype=ansi** is specified, *ni* = 000 is not valid.

When **chg-sid:pctype=ansi** is specified, *nc* = 000 is not valid if *ni* = 001–005.

When **chg-sid:pctype=ansi** is specified, *nc* = 000 is valid if *ni* = 006–255.

The point code 000-000-000 is not a valid point code.

**:dpc/dpca/dpci/dpcn/dpcn24=** (mandatory)

Destination point code.

**:dpci=** (mandatory)

ITU international destination point code with subfields *zone-area-id*. The *prefix* subfield indicates a spare point code, private point code, or private and spare point code (*prefix-zone-area-id*).

**Range:** s-, p-, ps-, 0-255

Specify a valid value for each subfield of the point code, and separate the subfields with a dash (-).

*prefix*—**s-, p-, ps-**

*zone*—**0-7**

*area*—**000-255**

*id*—**0-7**

The point code **0-000-0** is not a valid point code.

**:dpcn=** (mandatory)

ITU national destination point code in the format of a 5-digit number (*nnnnn*); or 2, 3, or 4 numbers (members) separated by dashes (*m1-m2-m3-m4*) as defined by the **chg-stpopts:npcfnti** flexible point code option. A group code must be specified when the ITUDUPPC feature is turned on (*nnnnn-gc, m1-m2-m3-m4-gc*). The *prefix* subfield indicates a spare point code, private point code, or private and spare point code (*prefix-nnnnn, prefix-nnnnn-gc, prefix-m1-m2-m3-m4, prefix-m1-m2-m3-m4-gc*).

**Range:** **s-, p-, ps-, 0-16383, aa-zz**

Specify a valid value for each subfield of the point code, and separate the subfields with a dash (-).

*prefix*—**s-, p-, ps-**

*nnnnn*—**0-16383**

*gc*—**aa-zz**

*m1-m2-m3-m4*—**0-14** for each member; values must sum to 14

**:dpcn24=** (mandatory)

24-bit ITU national point code with subfields *main signaling area-sub signaling area-signaling point* (*msa-ssa-sp*). The *prefix* indicates a private point code (*prefix-msa-ssa-sp*).

**Range:** **p-, 000-255**

Specify a valid value for each subfield of the point code, and separate the subfields with a dash (-).

*prefix*—**p-**

*msa*—**000-255**

*ssa*—**000-255**

*sp*—**000-255**

**Default:** No change to current value.

**:aliasa=** (optional)

ANSI alias point code with subfields *network indicator-network cluster-network cluster member* (*ni-nc-ncm*). This parameter is not valid if an ANSI (**dpc** or **dpca**) point code is entered.

**Range:** **000-255**

Specify a valid value for each subfield of the point code, and separate the subfields with a dash (-).

When **chg-sid:pctype=ansi** is specified, *ni* = **000** is not valid.

When **chg-sid:pctype=ansi** is specified, *nc* = **000** is not valid if *ni* = **001-005**.

When **chg-sid:pctype=ansi** is specified, *nc* = **000** is valid if *ni* = **006-255**.

The point code **000-000-000** is not a valid point code.

**:aliasa/aliasi/aliasn/aliasn24=** (optional)

Alias point code.

**:aliasi=** (optional)

ITU international alias point code list with subfields *zone-area-id*. The *prefix* subfield indicates a spare point code (*prefix-zone-area-id*).

If an ITU international destination (**dpci**) point code is entered, then the **dpci** and **aliasi prefix** subfields cannot be the same (both spare or both non-spare). Up to 2 comma-delimited entries can be entered in the point code list.

**Range:** **s-, 0-255**

Specify a valid value for each subfield of the point code, and separate the subfields with a dash (-).

*prefix*—**s-**

*zone*—**0-7**

*area*—**000-255**

*id*—**0-7**

The point code **0-000-0** is not a valid point code.

**:aliasn=** (optional)

ITU national alias point code list in the format of a 5-digit number (*nnnnn*); or 2, 3, or 4 numbers (members) separated by dashes (*m1-m2-m3-m4*) as defined by the **chg-stpopts:npfnti** flexible point code option. A group code must be specified when the ITUDUPPC feature is turned on (*nnnnn-gc*, *m1-m2-m3-m4-gc*). The *prefix* subfield indicates a spare point code (*prefix-nnnnn*, *prefix-nnnnn-gc*, *prefix-m1-m2-m3-m4*, *prefix-m1-m2-m3-m4-gc*).

If an ITU national destination (**dpcn**) point code is entered, then the **dpcn** and **aliasn prefix** subfields cannot be the same (both spare or both non-spare). Up to 2 comma-delimited entries can be entered in the point code list.

**Range:** **s-, 0-16383, aa-zz**

Specify a valid value for each subfield of the point code, and separate the subfields with a dash (-).

*prefix*—**s-**

*nnnnn*—**0-16383**

*gc*—**aa-zz**

*m1-m2-m3-m4*—**0-14** for each member; values must sum to 14

**:aliasn24=** (optional)

24-bit ITU national alias point code with subfields *main signaling area-sub signaling area-signaling point* (*msa-ssa-sp*). This parameter is not valid if a 24-bit ITU national (**dpcn24**) point code is entered.

**Range:** **000-255**

Specify a valid value for each subfield of the point code, and separate the subfields with a dash (-).

*msa*—**000-255**

*ssa*—**000-255**

*sp*—**000-255**

**:bei=** (optional)

Broadcast exception indicator. This parameter specifies whether the STP broadcasts network management messages to adjacent signaling points. The network management messages contain information about the indicated cluster and any of that cluster's member signaling points that are on its exception list. The messages whose broadcast is determined by this parameter are:

- TFP—transfer prohibited

- TCP—transfer cluster prohibited
- TFA—transfer allowed
- TCA—transfer cluster allowed

**Range:**     **yes, no**  
               **yes** — Network management messages are not broadcast  
               **no** — Network management messages are broadcast

**Default:**   **yes**— for DPCs in the X.25 domain or if the DPC is a member whose associated cluster destination has **bei=yes** specified.  
               **no**—for DPCs in the cluster or if the DPC is a member whose associated cluster destination has **bei=no** specified or the **bei** parameter is not specified.

**:cli=** (optional)

The Common Language Location Identifier assigned to this destination.

**Range:**     ayyyyyyyyyy  
               1 alphabetic character followed by 10 alphanumeric characters

**Default:**   Null string

**:domain=** (optional)

The network in which the destination entity or node exists.

**Range:**     x25, ss7  
**Default:**   ss7

**:elei=** (optional)

Exception-list exclusion indicator, for cluster destinations only. This parameter specifies whether the system *excludes* or *includes (maintains)* a dynamic status exception list (x-list) for each cluster route used to reach the member signaling points that make up the cluster.

**Range:**     **yes, no**  
               **yes** — Do not maintain a dynamic status x-list  
               **no** — Maintain a dynamic status x-list

**Default:**   **no**

**:homescp=** (optional)

This parameter specifies whether the destination point code (DPC) is considered a Home SCP when performing SCCP processing for messages with no Global Title Address Digits (Global Title Indicator (GTI) is set to zero)

This parameter can only be set to "yes" for full DPCs.

**Range:**     **yes, no**  
               **yes** — the DPC is considered a Home SCP  
               **no** — the DPC is not considered a Home SCP

**System**

**Default:**   **no**

**:homesmsc=** (optional)

This parameter specifies whether the DPC is considered a Home SMSC when performing SCCP processing for messages with no Global Title Address Digits (GTI is set to zero).

This parameter can only be set to "yes" for full DPCs.

**Range:**     **yes, no**  
               **yes** — the DPC is considered a Home SMSC  
               **no** — the DPC is not considered a Home SMSC

**System**

**Default:**   **no**

**:ipgwape=** (optional)

IP gateway adjacent point code indicator.

**Range:**     **yes, no**

**Default:**   **no**

**:ncai=** (optional)

Nested cluster allowed indicator. Specifies whether the route to the cluster point code can be different for provisioned members of the cluster. A point code is a member of a cluster point code if it has the same network identifier (NI) and network cluster (NC) values as the cluster point code. This parameter can be specified only for cluster point codes. Nested cluster routing is allowed if this parameter is set to **yes** and the CRMD and NCR features are turned on.

**Range:**     **yes, no**

**yes**— The cluster point code is a nested cluster point code. Point codes that are members of this cluster point code can be assigned to route sets that are different from the route set assigned to the cluster point code.

**no**— The cluster point code is not a nested cluster point code. Point codes that are members of this cluster point code must be assigned to the same route set assigned to the cluster point code.

**Default:**   **no**

**:nprst=** (optional)

NM bits reset. This parameter specifies whether the NM bits should be set to **00**.

This parameter applies only to ITU IAM messages. The **nptype=nm** parameter must be specified (see the **chg-tifo** command) before this parameter can be specified.

**Range:**     **off, on**

**off**— Do not set NM Bits to **00** in an ITU IAM message if the TIFOPTS **nptype** option value is **nm**

**on**— Set the NM Bits to 00 in an ITU IAM message if the TIFOPTS **nptype** option value is **nm**

**System**

**Default:**   **off**

**:ppc=** (optional)

ANSI proxy point code with subfields *network indicator-network cluster-network cluster member* (*ni-nc-ncm*).

The proxy point code must be a full point code.

**Synonym:** **ppca**

**Range:**     **000-255**

Specify a valid value for each subfield of the point code, and separate the subfields with a dash (-).

When **chg-sid:pctype=ansi** is specified, *ni* = **000** is not valid.

When **chg-sid:pctype=ansi** is specified, *nc* = **000** is not valid if *ni* = **001–005**.

When **chg-sid:pctype=ansi** is specified, *nc* = **000** is valid if *ni* = **006–255**.

The point code **000-000-000** is not a valid point code.

**:ppc/ppca/ppci/ppcn/ppcn24=** (optional)

Proxy point code.

The proxy point code must be a full point code.

**:ppci=** (optional)

ITU international proxy point code with subfields *zone-area-id*. The *prefix* subfield indicates a spare point code (*prefix-zone-area-id*).

**Range:** s-, 0-255

Specify a valid value for each subfield of the point code, and separate the subfields with a dash (-).

*prefix*—s-

*zone*—0-7

*area*—000-255

*id*—0-7

The point code **0-000-0** is not a valid point code.

**:ppcn=** (optional)

ITU national proxy point code in the format of a 5-digit number (*nnnnn*); or 2, 3, or 4 numbers (members) separated by dashes (*m1-m2-m3-m4*) as defined by the **chg-stpopts:npcfnti** flexible point code option. A group code must be specified when the ITUDUPPC feature is turned on (*nnnnn-gc*, *m1-m2-m3-m4-gc*). The *prefix* subfield indicates a spare point code (*prefix-nnnnn*, *prefix-nnnnn-gc*, *prefix-m1-m2-m3-m4*, *prefix-m1-m2-m3-m4-gc*).

**Range:** s-, 0-16383, aa-zz

Specify a valid value for each subfield of the point code, and separate the subfields with a dash (-).

*prefix*—s-

*nnnnn*—0-16383

*gc*—aa-zz

*m1-m2-m3-m4*—0-14 for each member; values must sum to 14

**:ppcn24=** (optional)

24-bit ITU national point code with subfields *main signaling area-sub signaling area-signaling point* (*msa-ssa-sp*).

**Range:** 000-255

Specify a valid value for each subfield of the point code, and separate the subfields with a dash (-).

*msa*—000-255

*ssa*—000-255

*sp*—000-255

**:prx=** (optional)

Proxy point code indicator. This parameter specifies whether a destination is used as a proxy point code.

**Range:** yes, no

**yes**— The destination is used as a proxy point code.

**no**— The destination is not used a proxy point code.

**Default:** no - Will not be used as a proxy point code.

**:rcause=** (optional)

Release cause. This parameter specifies the condition that triggers the sending of a Release message.

If the TIFOPTS **rlcopc** parameter is specified (see the **chg-tifo** command), and a value of **0-127** is specified for the **rcause** parameter, then the **rcause** parameter value overrides the values specified for the TIFOPTS **rcausenp** and **rcausepfx** parameters.

**Range:** 0-127, none

**none**—use the values specified for the TIFOPTS **rcausenp** and **rcausepfx** parameters

**System**

**Default:** none

**:spc=** (optional)

ANSI secondary point code with subfields *network indicator-network cluster-network cluster member (ni-nc-ncm)*. The *prefix* subfield indicates a private point code ( *prefix-ni-nc-ncm* ) .

**Synonym: spca**

**Range:**       **000-255**

Specify a valid value for each subfield of the point code, and separate the subfields with a dash (-).

When **chg-sid:pctype=ansi** is specified, *ni* = **000** is not valid.

When **chg-sid:pctype=ansi** is specified, *nc* = **000** is not valid if *ni* = **001-005**.

When **chg-sid:pctype=ansi** is specified, *nc* = **000** is valid if *ni* = **006-255**.

The point code **000-000-000** is not a valid point code.

**:spc/spca/spci/spcn/spcn24=** (optional)

Secondary point code.

**:spci=** (optional)

ITU international secondary point code with subfields *zone-area-id*. The *prefix* subfield indicates a spare point code, private point code, or private and spare point code (*prefix-zone-area-id*).

**Range:**       **s-, p-, ps-, 0-255**

Specify a valid value for each subfield of the point code, and separate the subfields with a dash (-).

*prefix*—**s-, p-, ps-**

*zone*—**0-7**

*area*—**000-255**

*id*—**0-7**

The point code **0-000-0** is not a valid point code.

**:spcn=** (optional)

ITU national secondary point code in the format of a 5-digit number (*nnnnn*); or 2, 3, or 4 numbers (members) separated by dashes (*m1-m2-m3-m4*) as defined by the **chg-stpopts:npcfmti** flexible point code option. A group code must be specified when the ITUDUPPC feature is turned on (*nnnnn-gc*, *m1-m2-m3-m4-gc*). The *prefix* subfield indicates a spare point code, private point code, or private and spare point code (*prefix-nnnnn*, *prefix-nnnnn-gc*, *prefix-m1-m2-m3-m4*, *prefix-m1-m2-m3-m4-gc*).

**Range:**       **s-, p-, ps-, 0-16383, aa-zz**

Specify a valid value for each subfield of the point code, and separate the subfields with a dash (-).

*prefix*—**s-, p-, ps-**

*nnnnn*—**0-16383**

*gc*—**aa-zz**

*m1-m2-m3-m4*—**0-14** for each member; values must sum to 14

**:spcn24=** (optional)

24-bit ITU national point code with subfields *main signaling area-sub signaling area-signaling point (msa-ssa-sp)*. The *prefix* subfield indicates a private point code (*prefix-msa-ssa-sp*).

**Range:**       **p-, 000-255**

Specify a valid value for each subfield of the point code, and separate the subfields with a dash (-).

*prefix*—**p-**

*msa*—000–255  
*ssa*—000–255  
*sp*—000–255

**:splitiam=** (optional)

This parameter specifies when and how to split an ITU IAM message into 1 IAM message + 1 SAM message.

This parameter applies only to ITU IAM messages.

**Range:** 15-31, none

**15-31**—Maximum number of CdPN digits allowed in the IAM message before splitting occurs. The remaining digits, up to a total of 32, are encoded in the SAM message.

**none**—the value specified for the TIFOPTS **splitiam** parameter is used to determine when to split the IAM message

**System**

**Default:** none

### Example

To add destination 8-1-1 with clii of systest1:

```
ent-dstn:dpc=8-1-1:clli=systest1:bei=yes
```

To add destination 8-8-8 with ITU and national aliases:

```
ent-dstn:dpc=8-8-8:aliasi=1-2-3:aliasn=124
```

To add cluster 20-2-\*:

```
ent-dstn:dpc=20-2-*:elei=yes:bei=yes
```

To add a destination with an SPC of 100-100-100:

```
ent-dstn:dpc=20-2-2:spc=100-100-100
```

To add nested cluster 21-2-\*:

```
ent-dstn:dpc=21-2-*:elei=yes:bei=yes:ncai=yes
```

To add network routing destination 21-\*-\*:

```
ent-dstn:dpc=21-*-*
```

To add ITU national destination 7654 with a group code of fr and secondary point code of 7050:

```
ent-dstn:dpcn=7654-fr:spc=7050-fr
```

To add ITU-N 24-bit destination 15-100-10:

```
ent-dstn:dpcn24=15-100-10:bei=no
```

To add a 24-bit ITU-N destination with a 24-bit ITU-N secondary point code of 99-99-99:

```
ent-dstn:dpcn24=12-12-12:spcn24=99-99-99
```

To add destination 1-6-1 with a 24-bit ITU-N alias:

```
ent-dstn:dpci=1-6-1:aliasn24=4-4-4
```

To add private ANSI destination point code p-100-100-101:with spare point code alias s-1-123-1

```
ent-
```

```
dstn:dPCA=p-100-100-101:spca=2-2-3:aliasi=s-1-123-1:aliasn=128
```

To add spare ITU-I destination point code s-2-100-1 with ANSI alias point code 121-120-120 and ITU-N alias spare point code s-129:



```
ent-  
dstn:dpci=s-2-100-1:spci=s-2-129-9:aliasa=121-120-120:aliasn=s-12  
9
```

To add spare ITU-N destination point code s-231 with ITU-N secondary point code 129, ANSI alias point code 120-120-122, and ITU-I alias spare point code s-2-123-2:

```
ent-dstn:dpcn=s-231:spcn=129:aliasa=120-120-122:aliasi=s-2-123-2
```

To define a destination as a proxy point code:

```
ent-dstn:dpc=11-11-11:prx=yes
```

To associate a proxy point code with a destination point code:

```
ent-dstn:dpc=11-11-11:ppc=2-7-2
```

To add ITU-I destination point code 3-30-3 with ITU-I spare alias s-3-30-3:

```
ent-dstn:dpci=3-30-3:aliasi=s-3-30-3
```

To add ITU-N destination point code 8199-aa with ITU-I aliases s-4-0-7 and 4-0-7:

```
ent-dstn:dpcn=8199-aa:aliasi=s-4-0-7,4-0-7
```

## Dependencies

**NOTE:** A *full point code* contains numerical values for all three segments of the point code.

The ANSI self-ID destination point code for the STP must be defined before ANSI destinations can be entered.

The ITU-I self-ID destination point code for the STP must be defined before ITU-I destinations can be entered.

The ITU-N self-ID destination point code for the STP must be defined before ITU-N destinations can be entered.

The 24-bit ITU-N self-ID destination point code for the STP must be defined before 24-bit ITU-N destinations can be entered. (See the **chg-sid** command.)

The Destination point code table can contain up to 2000 entries.

The destination address must be a full point code or a cluster point code.

The specified destination address cannot already exist in the Destination entity set.

A destination address cannot already be defined as an alias address.

The Spare Point Code Support feature must be enabled before the spare point code prefix **s-** can be specified for an ITU-I or ITU-N destination, secondary, or alias point code.

The specified **dpc** value cannot match the point code, secondary point code, or capability point code of the system.

A destination can have up to two alias point codes. A destination alias point code type (ANSI, ITU-I, ITU-N, ITU-N24) must not match that destination's true point code type. If both alias point codes are defined, the point code types of the aliases must not match.

Alias point codes are supported only for destinations in the SS7 domain (**domain=ss7**).

Alias point codes are supported only for full point code destinations.

Alias point codes for destinations must be full point codes.

An alias point code cannot already be defined as a destination point code.

The format of the specified **dpcn** or **aliasn** parameter must match the format that was assigned with the **chg-stpopts:npfmti** parameter.

When the 7000 Routesets or 8000 Routesets feature is enabled, the total number of provisioned aliases in the system cannot exceed 8000.

If an ANSI or ITU-I point code is specified, either the **aliasn** or the **aliasn24** parameter can be specified, but not both.

A 24-bit ITU-N point code cannot have:

- A 14-bit ITU-N alias point code
- An ANSI alias point code

A 24-bit ITU-National point code can have an ITU-I point code alias. This allows conversion of 14-bit ITU-I routing label to 24-bit routing label and vice versa.

An ITU-I point code can have either a 14-bit ITU-N alias or a 24-bit ITU-N alias, but not both.

A 14-bit ITU-N point code cannot have a 24-bit ITU-N alias point code.

An ANSI point code cannot have a 24-bit ITU-N alias point code.

The X.25/SS7 Gateway feature (X25G) feature must be turned on before the **domain=x25** parameter can be specified.

The **domain=ss7** parameter must be specified before alias point codes can be supported.

Cluster destinations are not supported in the X.25 domain (**domain=x25**).

The CRMD feature must be turned on before a cluster destination point code (**ni-nc-\***) can be specified.

A cluster destination cannot be defined using the same network identifier (*ni*) and network cluster (*nc*) subfields of any previously defined alias ANSI point codes.

The CRMD (Cluster Routing and Management Diversity) and NCR (Nested Cluster Routing) features must be turned on before the **ncai** parameter can be specified.

If the **ncai=yes** parameter is specified, then the maximum number of provisioned nested clusters must be no greater than 500.

When a cluster point code is specified, the collection of signaling points sharing the same network identifier (*ni*) and network cluster (*nc*) subfields must have the same route set.

Cluster DPCs are not allowed to inherit cluster members that have routes with A or E linkset types.

Network routing is valid only if the Network Routing (NRT) feature is turned on.

When using network routing, if the destination point code has a value of \* in the *nc* subfield, the *ncm* subfield must also be \* (for example, **dpc=21-\*.\***).

The **ncai** parameter can be specified only for cluster destinations.

Alias ANSI point codes cannot have the same network identifier (*ni*) and network cluster (*nc*) subfields as a cluster point code that is already defined.

The CRMD feature must be turned on before the **elei** parameter can be specified.

The **elei** parameter can be specified only for cluster destinations (for example **dpc=ni-nc-\***).

The **cli** of the destination point code cannot match the **cli** of the system.

A reserved word cannot be specified for the destination identifier (**cli**).

If the corresponding destination for the specified destination point code is an adjacent signaling point (matched a Far End point code in its linkset entity set), the **cli** of the specified destination point code cannot be assigned to any other destination address.

The value of the **dpc** parameter must be a valid point code.

If specified, the **spc** parameter value must be already be configured as a secondary point code in the Secondary Point Code table.

The value specified for the **spc** parameter must be a full point code.

If the **spc** parameter is specified, the **domain=ss7** parameter must be specified.

If the **spc** parameter is specified, then the value specified for the **dpc** parameter must be a full point code.

The network type of the value specified for the **spc** parameter must match the network type of the value specified for the **dpc** parameter.

If an ITU national destination is provisioned and the ITUDUPPC feature is turned on, and if the destination does **not** use an SPC, the group code of the destination must be the same as the group code of the ITU national true point code. For example, if the ITU national true point code has a group code of **ee**, then you can add destinations with group codes of **ee** without using an SPC. Destinations with a group code of **ff**, however, must use an SPC with a group code of **ff**.

The Route table cannot be full.

If an ITU national destination is provisioned and the ITUDUPPC feature is turned on, and if the destination uses an SPC, then the group code of the destination must match the group code of the SPC. For example, if the ITU national true point code has a group code of **ee**, then you can add destinations with group codes of **ee** without using an SPC. Destinations with a group code of **ff**, however, must use an SPC with a group code of **ff**.

The **ncai** parameter can be specified only for cluster destinations (for example **dpc=ni-nc-\***).

The value of the **cli** parameter cannot already exist in the Route table.

The ICNP feature must be turned on before the **icnpxlat**, **cgpafmt**, and **cdpafmt** parameters can be specified.

The NCR feature must be enabled before the **ncai** parameter can be enabled.

If the 6000 Routesets feature is turned on, and the destination point code to be provisioned is above 5000, then the GPSM-II OAM cards must be used.

The **alias** parameter must be specified with a different point code type than the **dpc** parameter. The **aliasa** and **dpca** parameters cannot be specified together in the command. The **aliasi** and **dpci** parameters and the **aliasn** and **dpcn** parameters cannot be specified together in the command if the *prefix* subfields are the same (both are spare or both are non-spare).

The Proxy Point Code feature must be enabled before the **prx=yes** parameter can be specified.

If the **ipgwapc=yes** parameter is specified, then the **prx=yes** parameter cannot be specified.

If the **ipgwapc=yes** parameter is specified, then the **ppc** parameter cannot be specified.

The Proxy Point Code feature must be enabled before the **ppc** parameter can be specified.

If the **ppc** parameter or the **prx=yes** parameter is specified, then the value specified for the **dpc** parameter must be a full point code.

If the **prx=yes** parameter is specified, then the **domain=ss7** parameter must be specified.

If the **ppc** parameter is specified, then the **domain=ss7** parameter must be specified.

The **spc** and **ppc** parameters cannot be specified together in the command.

The values specified for the **dpc** and **ppc** parameters must have the same network type.

The values specified for the **dpc** and **ppc** parameters must have the same group code.

The number of proxy destinations cannot exceed the value given by the enabled Proxy Point Code quantity feature.

If the value of the **dpc** parameter is a private point code, then the **prx=yes** parameter cannot be specified.

If the value of the **dpc** parameter is a private point code, then the **ppc** parameter cannot be specified.

The **dpc** parameter and the **prx=yes** parameter must be specified before the **ppc** parameter can be specified.

The total number of proxy destinations cannot exceed the total capacity (100) of the Proxy Point Code feature.

If the **prx** parameter is specified, then either **yes** or **no** value must be assigned

Cluster destination point codes cannot inherit cluster members that have routes using proxy linksets.

The spare ITU-I self-ID destination point code for the STP must be defined before spare ITU-I destinations can be entered.

The spare ITU-N self-ID destination point code for the STP must be defined before spare ITU-N destinations can be entered.

A maximum of two aliases can be specified per destination point code.

If the **dpci** parameter is specified, then a combination of ITUI and ANSI aliases cannot be specified.

If the **dpcn** parameter is specified, then a combination of ITUN and ANSI aliases cannot be specified.

Two ITUI or two ITUN aliases can be specified for the same destination point code only if the aliases have different prefixes. One alias must be spare and one non-spare.

The TIF Number Portability feature must be enabled before the **rcause** or **nprst** parameter can be specified.

A TIF feature must be enabled before the **splitiam** parameter can be specified.

## Notes

Upon initial installation of the system, the self point code must be entered before you enter any destination.

When you define a DPC with the unique destination signaling point of a provisioned cluster, the DPC automatically inherits the route set of its cluster if the **ncai** parameter is set to **no**. If the **ncai** parameter is set to **yes**, the provisioned members can have a different route set.

When you define a cluster point code for previously defined destination signaling points, the cluster automatically inherits the unique route set of its members.

For ITU national duplicate point codes, you cannot change a destination's group code. To move a destination from one group to another, provision a new destination that uses the new group code and delete the old destination.

The system requires that the destination point code of each routeset be entered in the database. For example, to enter 6000 routesets in the database, 6000 destination point codes must be entered in the database.

If you have turned on the 5000 Routes feature, prior to provisioning the additional routing table entries, you must issue the **chg-stpopts** command to specify the maximum number of allowed DPCs and dynamic x-list entries.

When the 6000, 7000, or 8000 Routesets feature is enabled, if you want to enter more than 2000 destination point codes, the maximum number of point codes that can be configured on the system must be changed to 6000, 7000, or 8000 respectively, using the **mtpdpcq** parameter of the **chg-stpopts** command.

In this command, only ITU-international and ITU national point codes and aliases support the spare point code subtype prefix (**s-**). Only ITU-international and ITU national point codes support the private and spare point code subtype prefix (**ps-**). All of the point code types support the private (internal) point code subtype prefix (**p-**). Aliases do not support the private (internal) point code prefix.

If the Proxy Point Code feature is enabled, then the value specified for the **ppc** parameter or of the **dpc** parameter (when the destination point code is designated as a proxy point code) must be full point codes. Cluster point codes and private point codes are not supported.

## Output

The following example shows the display of the destination memory space accounting command completion response with the NCR, NRT, and CRMD features off (disabled) and all Routes and Routesets features off (disabled):

```
ent-dstn:dpc=8-8-8:aliasi=1-2-3:aliasn=124
  rlghncxa03w 04-08-17 15:35:05 EST  EAGLE 31.8.0
  Destination table is (10 of 2000) 1% full
  Alias table is (8 of 12000) 1% full
  ENT-DSTN: MASP A - COMPLTD
;

```

The following example shows the display of the destination memory space accounting command completion response with the NCR, NRT, and CRMD features off (disabled) and the DSTN5000 (5000 Routes) feature on:

```
ent-dstn:dpc=8-8-8:aliasi=1-2-3:aliasn=124
  rlghncxa03w 04-08-18 08:29:15 EST  EAGLE 31.8.0
  Destination table is (10 of 5000) 1% full
  Alias table is (8 of 12000) 1% full
  ENT-DSTN: MASP A - COMPLTD
;

```

The following example shows the display of the destination memory space accounting command completion response with one or more of the NCR, NRT, or CRMD features on and the DSTN5000 (5000 Routes) feature on:

```
ent-dstn:dpc=8-8-8:aliasi=1-2-3:aliasn=124
  rlghncxa03w 04-08-18 08:29:15 EST  EAGLE 31.8.0
  DESTINATION ENTRIES ALLOCATED:    5000
  FULL DPC(s):                      9
  NETWORK DPC(s):                   0
  CLUSTER DPC(s):                   1
  TOTAL DPC(s):                     10
  CAPACITY (% FULL):                 1%
  ALIASES ALLOCATED:                 12000
  ALIASES USED:                      8
  CAPACITY (% FULL):                 1%
  X-LIST ENTRIES ALLOCATED:         500
  ENT-DSTN: MASP A - COMPLTD
;

```

The following example shows the display of the destination memory space accounting command completion response with the NCR, NRT, and CRMD features off (disabled) and the 6000 Routesets feature on:

```
ent-dstn:dpc=8-8-8:aliasi=1-2-3:aliasn=124
  rlghncxa03w 04-08-18 08:29:15 EST  EAGLE 31.8.0
  Destination table is (60 of 6000) 1% full
  Alias table is (8 of 12000) 1% full
  ENT-DSTN: MASP A - COMPLTD
;

```

The following example shows the display of the destination memory space accounting command completion response with one or more of the NCR, NRT, or CRMD features on and the 6000 Routesets feature on:

```
ent-dstn:dpc=8-8-8:aliasi=1-2-3:aliasn=124
  rlghncxa03w 04-08-18 08:29:15 EST  EAGLE 31.8.0
  DESTINATION ENTRIES ALLOCATED:    6000
  FULL DPC(s):                      46

```

```

NETWORK DPC(s):          1
CLUSTER DPC(s):         1
TOTAL DPC(s):           12
CAPACITY (% FULL):      1%
ALIASES ALLOCATED:      12000
ALIASES USED:            8
CAPACITY (% FULL):      1%
X-LIST ENTRIES ALLOCATED: 500
ENT-DSTN: MASP A - COMPLTD

```

;

The following example shows the display of the destination memory space accounting command completion response with the NCR, NRT, and CRMD features off (disabled). When the 7000 Routesets quantity feature is on, the Destination table line shows "...of 7000" as it appears in the example. When the 8000 Routesets quantity feature is on, the Destination table line shows "...of 8000."

**ent-dstn:dpc=8-8-8:aliasi=1-2-3:aliasn=124**

```

rlghncxa03w 04-08-18 08:29:15 EST EAGLE 31.8.0
Destination table is (60 of 7000) 1% full
Alias table is (8 of 8000) 1% full
ENT-DSTN: MASP A - COMPLTD

```

;

The following example shows the display of the destination memory space accounting command completion response with one or more of the NCR, NRT, or CRMD features on: When the 7000 Routesets quantity feature is on, the DESTINATION ENTRIES ALLOCATED line shows "8000" as it appears in the example. When the 7000 Routesets quantity feature is on, the DESTINATION ENTRIES ALLOCATED line shows "7000."

**ent-dstn:dpc=8-8-8:aliasi=1-2-3:aliasn=124**

```

rlghncxa03w 04-08-18 08:29:15 EST EAGLE 31.8.0
DESTINATION ENTRIES ALLOCATED: 8000
FULL DPC(s):                  9
NETWORK DPC(s):               0
CLUSTER DPC(s):               1
TOTAL DPC(s):                 10
CAPACITY (% FULL):            1%
ALIASES ALLOCATED:            8000
ALIASES USED:                  8
CAPACITY (% FULL):            1%
X-LIST ENTRIES ALLOCATED:     500
ENT-DSTN: MASP A - COMPLTD

```

;

The following example shows the display of the destination memory space accounting command completion response when none of the NCR, NRT, or CRMD features on. In this example, a destination is defined as a proxy point code.

**ent-dstn:dpc=11-11-11:prx=yes**

```

tekelecstp 07-03-07 16:34:32 EST EAGLE 37.5.0
Destination table is (11 of 2000) 1% full
Alias table is (0 of 12000) 0% full
PPC table is (2 of 10) 20% full
ENT-DSTN: MASP A - COMPLTD

```

;

The following example shows the display of the destination memory space accounting command completion response when one or more of the NCR, NRT, or CRMD features are on. In this example, a destination refers to a proxy point code.

**ent-dstn:dpc=1-1-1:ppc=11-11-11**

```

tekelecstp 07-03-05 17:34:18 EST EAGLE 37.5.0
DESTINATION ENTRIES ALLOCATED: 2000
FULL DPC(s):                  27

```

```

EXCEPTION DPC(s) :          0
NETWORK DPC(s) :           1
CLUSTER DPC(s) :           1
Proxy DPC(s) :             1
TOTAL DPC(s) :             30
CAPACITY (% FULL) :        2%
ALIASES ALLOCATED:         12000
ALIASES USED:              0
CAPACITY (% FULL) :        0%
X-LIST ENTRIES ALLOCATED:  500
ENT-DSTN: MASP A - COMPLTD
;

```

**ent-e1****Enter E1 Interface**

Use this command to enter an interface into the system for an E1/T1 MIM card, an HC-MIM card used as an E1 card, an E5-E1T1 card used as an E1 card, an HC-MIM card used as an SE-HSL card, or an E5-E1T1 card used as an SE-HSL card. The E1 port number on the card and the E1 card location in the EAGLE 5 ISS must be specified for the interface.

CRC4, CAS, CCS, encoding, timing source, and NFAS signaling bit options can be set with the command parameters.

On an HC-MIM card or E5-E1T1 card, E1 ports 1, 3, 5, and 7 (master ports) can be independently channel bridged with their adjacent even-numbered (slave) E1 ports 2, 4, 6, and 8 to allow non-signaling data pass-through.

Any of the 8 ports on an HC-MIM card or E5-E1T1 card can be specified when the card is used as a standard HC-MIM card or E5-E1T1 card respectively. No more than 2 ports on the HC-MIM card or 1 port on the E5-E1T1 card can have a defined E1 interface when the card is used as an SE-HSL card.

**NOTE: CRC4, CAS, CCS, encoding, timing source, and NFAS signaling bit options can be set with the command parameters. Do not use the DIP switches, if any, on E1 and Channel cards to define the E1 interface.**

**NOTE: The E1 card can have a DIP switch called E1BKEN, which is used to enable or disable data transmission on the E1 backplane. Because there is no command parameter that corresponds to the DIP switch, the default value of enabled is assumed. The backplane is enabled for data transmit and receive on E1 port number 1.**

**NOTE: On an HC-MIM or E5-E1T1 card, E1 ports 1, 3, 5, and 7 (master ports) can be independently channel bridged with their adjacent even-numbered (slave) E1 ports 2, 4, 6, and 8 to allow non-signaling data pass-through.**

**NOTE: Any of the 8 ports on an HC-MIM or E5-E1T1 card can be specified when the card is used as a standard HC-MIM or E5-E1T1 card. No more than 2 ports on the HC-MIM or 1 port on the E5-E1T1 when used as an SE-HSL card can have defined E1 interfaces.**

**Keyword:** ent-e1

**Related Commands:** chg-e1, dlt-e1, rtrv-e1, tst-e1

**Command Class:** Database Administration

**Parameters**

**:e1port=** (mandatory)

E1 card port number. The value must be a E1 port for which an interface has not been configured on the specified E1 card.

**Range: 1-8**

Ports 3 through 8 can be specified only for HC-MIM and E5-E1T1 cards.

Any 2 of the 8 ports on an HC-MIM card can be specified when the card is used as an SE-HSL card.

Any 1 of the 8 ports on an E5-E1T1 card can be specified when the card is used as an SE-HSL card.

**:loc=** (mandatory)

The card location as stenciled on the shelf of the system.

**Range:** 1101-1108, 1111-1112, 1201-1208, 1211-1218, 1301-1308, 1311-1318, 2101-2108, 2111-2118, 2201-2208, 2211-2218, 2301-2308, 2311-2318, 3101-3108, 3111-3118, 3201-3208, 3211-3218, 3301-3308, 3311-3318, 4101-4108, 4111-4118, 4201-4208, 4211-4218, 4301-4308, 4311-4318, 5101-5108, 5111-5118, 5201-5208, 5211-5218, 5301-5308, 5311-5318, 6101-6108, 6111-6118

**:cas=** (optional)

CAS multiframing (**on**) or CCS (**off**) indicator.

**Range:** on, off

CAS cannot be specified for HC-MIM and E5-E1T1 cards.

**Default:** off

**:chanbrdg=** (optional)

Port bridging status. This parameter indicates whether an odd-numbered E1 port on an HC-MIM or E5-E1T1 card is channel bridged with its adjacent even-numbered E1 port for non-signaling data pass through.

**Range:** on, off

**Default:** off

**:crc4=** (optional)

CRC4 enable or disable indicator.

**Range:** on, off

**Default:** on

**:e1tsel=** (optional)

Timing source. This parameter indicates a master (**external**) or slave (**line**) timing source, or a timing source recovered from the paired master port for channel bridged slave ports.

**Range:** line, external, recovered

**Default:** line

**:encode=** (optional)

Indicator for use of HDB3 or AMI encoding/decoding.

**Range:** hdb3, ami

AMI encoding is supported for E1/T1 MIM, HC-MIM, and E5-E1T1 cards that are used as an E1 card.

**Default:** hdb3

**:force=** (optional)

This parameter specifies to provision an odd-numbered E1 port to channel bridging mode if the adjacent next higher even-numbered port is already provisioned with an E1 interface.

**Range:** yes, no

**:linkclass=** (optional)

Link class for links that are assigned to HC-MIM and E5-E1T1 cards ("channelized" links) or SE-HSL cards ("unchannelized" links).

**Range:** chan, unchan

**Default:** chan



**:minsurate=** (optional)

Minimum signal unit rate. This parameter indicates the minimum number of SUs present on a link uniformly distributed. This parameter is valid only when the **linkclass=unchan** parameter is specified for an SE-HSL card.

**Range:** 500-2000

**Default:** 1000

**:si=** (optional)

Value of two Spare International bits of NFAS data.

**Range:** 0-3

**Default:** 0

**:sn=** (optional)

Value of five Spare International bits of NFAS data.

**Range:** 0-31

**Default:** 0

### Example

```
ent-
e1:loc=1205:e1port=1:crc4=off:cas=on:encode=hdb3:e1tsel=external:
si=2:sn=12

ent-e1:loc=1205:e1port=2:cas=off:encode=ami

ent-e1:loc=1203:e1port=1:chanbrdg=on:e1tsel=recovered

ent-e1:loc=1203:e1port=3:chanbrdg=on:e1tsel=external

ent-
e1:loc=1203:crc4=on:e1port=2:encode=hdb3:e1tsel=line:linkclass=un
chan :minsurate=2000
```

### Dependencies

The specified card location (**loc** parameter) must be equipped.

The card specified by the **loc** parameter must be a **lime1** card type.

The port specified by the **e1port** parameter must not already be equipped with an E1 interface.

The **cas=on** parameter cannot be specified if E1 ports **3 - 8** (**e1port** parameter) have been specified or if the **chanbrdg=on** parameter has been specified.

The **chanbrdg=on** and **cas=on** parameters cannot be specified when the **linkclass=unchan** parameter is specified. The **minsurate** parameter can be specified only when the **linkclass=unchan** parameter is specified.

The **chanbrdg=on** parameter can be specified only for HC-MIM and E5-E1T1 cards.

The **chanbrdg=on** parameter cannot be specified for even-numbered E1 ports (**e1port** parameter).

The timing source parameter **e1tsel** must be specified if the **chanbrdg=on** parameter is specified.

The **e1tsel=line** parameter cannot be specified for an E1 port (**e1port** parameter) when the **chanbrdg=on** parameter is specified.

The **e1tsel=recovered** parameter cannot be specified for an E1 port (**e1port** parameter) unless the **chanbrdg=on** parameter is specified.

Only 2 ports can be used for E1 interfaces on an HC-MIM card that is used as an SE-HSL card. Any 2 of the 8 ports can be used on the SE-HSL card.

If the **chanbrdg=on** parameter is specified for an odd-numbered E1 port on an HC-MIM or an E5-E1T1 card, then the **force=yes** parameter must be specified if the adjacent even-numbered port is already provisioned with an E1 interface.

Before the **chanbrdg=on** parameter can be specified for an odd-numbered E1 port on an HC-MIM and E5-E1T1 card, all signaling links assigned to the adjacent even-numbered E1 port must be deleted (see the **dlt-slk** command).

The fan feature bit (see the **chg-feat** command) must be turned on before HC-MIM cards that are used as E1 or SE-HSL cards can be used in an EAGLE 5 ISS shelf.

HIPR cards must be equipped in card locations *xy09* and *xy10* (*x* is the frame, *y* is the shelf) on each EAGLE 5 ISS shelf that contains one or more HC-MIM or E5-E1T1 cards that are used as E1 or SE-HSL cards.

An SE-HSL feature quantity must be enabled before the **linkclass=unchan** parameter can be specified for an SE-HSL card. (See the **enable-ctrl-feat** command and the SEHSL SLK Capacity entry in the **rtrv-ctrl-feat** command output example.)

The **linkclass=unchan** parameter can be specified only for HC-MIM and E5-E1T1 cards.

Channelized and unchannelized E1 ports (mixed mode) are not allowed on a single HC-MIM or E5-E1T1 card (the card cannot be used as an E1 card and an SE-HSL card at the same time).

Only 1 port can be used for E1 interfaces on an E5-E1T1 card that is used as an SE-HSL card. Any 1 of the 8 ports can be used on the SE-HSL card.

E1 ports **3 - 8** (**e1port** parameter) can be specified only for HC-MIM and E5-E1T1 cards.

The **encode=ami** parameter is supported only for the E1/T1 MIM, HC-MIM, and E5-E1T1 card used as an E1 card.

The **cas =on** parameter cannot be specified for HC-MIM or E5-E1T1 cards.

## Notes

One or two E1 interfaces must be defined on an E1 card after the E1 and any associated Channel cards types (**lime1** and **limch**) are defined in the database (see the **ent-card** command), and before the signaling links and associated timeslots are defined for the E1 card and any associated Channel cards (see the **ent-slk** command).

When the **e1tsel=external** parameter is specified, a user-supplied BITS clock is required.

External timing is derived from the EAGLE High-Speed Master Clock (1.544 MHz for T1 or 2.048 MHz for E1): therefore, the Master Timing feature is required. Line timing is derived from its received data stream, if present.

Up to 8 E1 interfaces can be defined on an HC-MIM or E5-E1T1 card used as a E1 card after the E1 card type (**lime1**) is defined in the database (with the **ent-card** command), and before the signaling links and associated timeslots are defined for the E1 card .

On a HC-MIM or E5-E1T1 card, E1 ports 1, 3, 5, and 7 (master ports) can be independently channel bridged with their adjacent even-numbered (slave) ports 2, 4, 6, and 8 to allow non-signaling data pass-through. The **chanbrdg** parameter must be specified for the odd-numbered E1 port.

For an SE-HSL card, the **minsurate** parameter indicates the least number of SUs present on a link uniformly distributed. The number of SUs present is the **minsurate** parameter value (without link traffic) or the **minsurate** parameter value minus the number of MSUs (with link traffic).

## Output

```
ent-
e1:loc=1205:e1port=1:crc4=off:cas=on:encode=hdb3:e1tsel=external:
si=2:sn=12
  rlgncxa03w 04-02-20 09:07:58 EST  EAGLE 31.3.0
  ENT-E1: MASP A - COMPLTD
;
```

**ent-frm-pwr****Enter Frame Power Threshold**

Use this command to add a new entry to the Frame Power Threshold (FPT) table. The frame-level power threshold value in the table is compared with the current calculated maximum power consumption for a particular frame, and appropriate alarms are raised if that consumption exceeds the threshold limit.

The entries in the Frame Power Threshold table contain a Frame ID and the corresponding power threshold value. You can use the following commands to display the threshold and calculated maximum power consumption for the frames in the system.

- The **rtrv-frm-pwr** command displays the current provisioned frame power threshold for each provisioned frame.
- The **rtrv-stp:display=power** command displays the provisioned frame power threshold for each provisioned frame, and displays the maximum calculated power consumption for each frame, based on card population.
- The **rtrv-stp:display=power:frm=xxxx** command displays the provisioned frame power threshold for the specified frame, the maximum calculated power consumption for the frame based on card population, and the maximum power consumption for each card in the frame and for a fan assembly for each shelf.

**NOTE: The frame-level power threshold value needs to be determined from the capacity in Amps of the fuse alarm panel (FAP) for the frame. Contact your site engineer to determine the FAP capacity.**

**Keyword:** ent-frm-pwr

**Related Commands:** chg-frm-pwr, dlt-frm-pwr, rtrv-frm-pwr, rtrv-stp

**Command Class:** Database Administration

**Parameters**

**:frm=** (mandatory)

Frame ID.

**Range:** cf00, ef00, ef01, ef02, ef03, ef04

cf00 — Control frame

ef00 — First extension frame

ef01 — Second extension frame

ef02 — Third extension frame

ef03 — Fourth extension frame

ef04 — Fifth extension frame

**:thrshld=** (optional)

Threshold. This parameter specifies the frame-level power threshold value, in Amps. This value is compared with the current calculated maximum power consumption for a particular frame (use the **rtrv-stp:display=power:frm=** command to obtain the maximum power consumption value), and the appropriate alarms are raised if current consumption exceeds the threshold limit.

The value of the **thrshld** parameter needs to be determined from the capacity of the fuse alarm panel (FAP) for the frame. Contact your site engineer to determine the frame FAP capacity.

**Range:** 30-65

**Default:** 30

**Example**

Enter the frame power threshold value for the first extension frame.

```
ent-frm-pwr:frm=ef00:thrshld=55
```

### Dependencies

The specified power threshold value (**thrshld** parameter) must not already be provisioned for the specified frame.

The specified frame (**frm** parameter) must be a provisioned frame.

### Notes

The maximum calculated power for a frame is based on the cards that are populated in the system, and includes a fan tray assembly for every shelf (the system cannot detect the presence or absence of a fan tray, and assumes presence for the calculation). These values are typically much higher than the actual power being drawn; the values cannot be used as a gauge of the actual power consumption of the EAGLE 5 ISS.

### Output

```
ent-frm-pwr:frm=ef00:thrshld=55
tekelecstp 06-04-11 15:18:41 EST EAGLE 35.0.0
FRAME POWER THRESHOLD table is (4 of 10) 40% full
ENT-FRM-PWR: MASP A - COMPLTD
;
```

## ent-ftp-serv

### Enter FTP Server Entry

Use this command to write an entry into the FTP Server table for an FTP Server.

**NOTE: The FTP Serve table entry for the FTP-based Table Retrieve Application (FTRA) is entered through input from FTRA. Though the entry can be made with this command at the EAGLE 5 ISS, the information entered at the EAGLE 5 ISS will be overwritten by the information sent by FTRA.**

**Keyword:** ent-ftp-serv

**Related Commands:** chg-ftp-serv, dlt-ftp-serv, rtrv-ftp-serv

**Command Class:** Database Administration

### Parameters

**:app=** (mandatory)

Application. This parameter specifies the FTP Client application that interfaces with the FTP server.

**Range:** **meas, user, db, dist**

**meas** — Measurements Platform application

**user** — FTP-based Table Retrieve Application (FTRA)

**db** — Database Backup\Restore application

**dist** — EAGLE 5 ISS Software Release Distribution application

**:ipaddr=** (mandatory)

IP Address of the FTP Server.

**Range:** 4 numbers separated by dots, with each number in the range of **0-255**.

**:login=** (mandatory)

FTP Server Username (A prompt for entering a password appears on a separate line.)

**Range:** zzzzzzzzzzzzzzzz

1 to 15 alphanumeric characters; mixed-case is allowed

**:path=** (mandatory)

FTP path used to locate the file that will be sent.

**Range:** ~~~~~  
 ~~~~~  
 Up to 100 characters; mixed-case string in double quotes with valid FTP path format

**Default:** User's home directory

**:prio=** (mandatory)  
 Priority of this FTP server when there is more than one FTP Server for this application.  
**Range:** 1-10

**Example**

```
ent-ftp-
serv:app=meas:ipaddr=1.255.0.102:login=ftpmeas1:path="~meas":prio
=1
ent-ftp-serv:app=user:ipaddr=1.255.0.102:login=tektoperson1:path="~
\data":prio=1
ent-ftp-
serv:app=dist:ipaddr=192.168.53.195:login=pvftp:prio=1:path="/
remote/labftp1/pvftp/dallen2ftp"
ent-ftp-
serv:app=db:ipaddr=192.168.53.195:login=pvftp:prio=1:path="/
remote/labftp1/pvftp/aholden"
```

**Dependencies**

A separate prompt appears for you to enter the FTP server password that will be used with the FTP Server Username (**login**). You must enter a password that is at least 1 and not more than 15 characters long. If you enter an invalid password (you press the Return key without entering a password, or you enter more than 15 characters), you must enter the entire command again to cause the password prompt to appear again. The password that you enter is not displayed as you enter it.

- An entry for the specified application ID at the specified priority cannot already exist.
- An entry for the specified application ID at the specified IP address cannot already exist.
- The **app** parameter must specify an application that uses the FTP Support feature.
- The **ipaddr** parameter must specify a valid IP address for the FTP server.
- The **path** parameter value must be in a valid FTP path format.

The **prio** parameter specifies a priority for use of an FTP server by an application when the application has more than one FTP server defined in the table. Each FTP server defined for use by the application must have a priority from 1 to 10 assigned. The available FTP server with the highest priority (smallest number) will be used first by the application.

The FTP Server table can contain entries for a maximum of 10 FTP servers: however, the number of FTP servers supported by an application may be less than 10. Entries that are made for an application cannot be made for more than the maximum number of FTP servers supported by the application.

- The Measurements Platform application (**app=meas**) supports 3 FTP servers.
- The FTP-based Table Retrieve Application (FTRA) (**app=user**) supports 2 FTP servers.
- The Database (**app=db**) and Software Distribution (**app=dist**) applications each support 1 FTP server.

**Notes**

The same FTP server can be defined more than once, but the specified application must be different for each entry.

**Output**

```
ent-ftp-
serv:app=meas:ipaddr=1.255.0.102:login=ftpmeas1:path=~meas":prio
=1
    rlghncxa03w 04-02-20 09:07:58 EST  EAGLE 31.3.0
Enter Password:*****
    FTP SERV table is (1 of 10) 10% full
    ENT-FTP-SERV: MASP A - COMPLTD
;

ent-ftp-
serv:app=user:ipaddr=1.255.0.102:login=tektoperson1:path=~data":pr
io=1
    rlghncxa03w 04-02-20 09:07:58 EST  EAGLE 31.3.0
Enter Password:*****
    FTP SERV table is (2 of 10) 20% full
    ENT-FTP-SERV: MASP A - COMPLTD
;
```

**ent-gserv-data****Enter G-Port SRI Query for Prepaid Service Data**

Use this command to enter translation type, originating point code, or global title address data in the GSERV table. These values are used to determine whether a Send Routing Information (SRI) request should receive G-Port SRI Query for Prepaid service or normal G-Port SRI service.

**Keyword:** ent-gserv-data

**Related Commands:** dlt-gserv-data, rtrv-gserv-data

**Command Class:** Database Administration

**Parameters**

**NOTE:** See "Point Code Formats and Conversion" for a detailed description of point code formats, rules for specification, and examples.

**:gta=** (optional)

Global title address. Use this parameter to specify a calling party (CgPA) global title address.

**Range:** 1-21 digits

**:opc=** (optional)

ANSI originating point code in the form of *network indicator-network cluster-network cluster member (ni-nc-ncm)*. The *prefix* subfield indicates a private point code *prefix-ni-nc-ncm*.

**Synonym:** opca

**Range:** p-, 000-255

Specify a valid value for each subfield of the point code, and separate the subfields with a dash (-).

*prefix*—p-

When **chg-sid:pctype=ansi** is specified, *ni = 000* is not valid.

When **chg-sid:pctype=ansi** is specified, *nc = 000* is not valid if *ni = 001-005*.

When **chg-sid:pctype=ansi** is specified, *nc = 000* is valid if *ni = 006-255*.

The point code **000-000-000** is not a valid point code.

**:opc/opca/opci/opcn/open24=** (optional)

Originating point code. Use these parameters to specify message transfer part (MTP) originating point codes.

**:opci=** (optional)

ITU international originating point code with subfields *zone-area-id*.

**Range:** **s-, p-, ps-, 0-255**

Specify a valid value for each subfield of the point code, and separate the subfields with a dash (-).

*prefix*—**s-, p-, ps-**

*zone*—**0-7**

*area*—**000-255**

*id*—**0-7**

The point code **0-000-0** is not a valid point code.

**:open=** (optional)

ITU national originating point code in the format of a 5-digit number (*nnnnn*); or 2, 3, or 4 numbers (members) separated by dashes (*m1-m2-m3-m4*) as defined by the **chg-stpopts:npcfnti** flexible point code option. A group code must be specified when the ITUDUPPC feature is turned on (*nnnnn-gc, m1-m2-m3-m4-gc*).

**Range:** **s-, p-, ps-, 0-16383, aa-zz**

Specify a valid value for each subfield of the point code, and separate the subfields with a dash (-).

*prefix*—**s-, p-, ps-**

*nnnnn*—**0-16383**

*gc*—**aa-zz**

*m1-m2-m3-m4*—**0-14** for each member; values must sum to 14

**:opcn24=** (optional)

24-bit ITU national originating point code with subfields *main signaling area-sub signaling area-signaling point* (*msa-ssa-sp*).

**Range:** **p-, 000-255**

Specify a valid value for each subfield of the point code, and separate the subfields with a dash (-).

*prefix*—**p-**

*msa*—**000-255**

*ssa*—**000-255**

*sp*—**000-255**

**:tt=** (optional)

Translation type. Use this parameter to specify a called party (CdPA) translation type.

**Range:** **0-255**

### Example

```
ent-gserv-data:tt=26
```

```
ent-gserv-data:opc=1-1-1
```

```
ent-gserv-data:gta=9194605500
```

### Dependencies

Duplicate entries cannot exist in the GSERV table.

The G-Port SRI Query for Prepaid feature must be enabled before this command can be entered.

A new entry cannot be added to the GSERV table because all available space is in use. A maximum of 256 **tt** values, 50 **gta** values, and 50 **opc** values can be entered in the GSERV table.

The **tt**, **opc**, and **gta** parameters cannot be specified within the same command.

The G-Port feature must be enabled before this command can be entered.

### Notes

A translation type, originating point code, or global title address (**tt**, **opc**, or **gta** parameter) value must be entered in the GSERV table and must match the corresponding SRI Query parameter for an SRI message to receive the G-Port SRI Query for Prepaid service.

The G-Port SRI Query for Prepaid feature must be on before entries in the GSERV table can be used to affect a G-Port SRI query

### Output

```
ent-gserv-data:tt=26
mystp 06-07-27 22:58:17 EST EAGLE 35.2.0
ENT-GSERV-DATA: MASP A - COMPLTD
```

## ent-gsmmap-scrn

### Enter GSM MAP Screening Entry

Use this command to assign the GSM (Global System for Mobile Telecommunication) MAP (Mobile Application Part) screening entries that filter or allow TCAP messages for certain MAP operation codes. The messages are filtered or allowed based on CgPA GTA+NPV+NAIV, CdPA GTA+NPV+NAIV, and forbidden (**forbid**) parameters. Each CgPA entry is associated with one or more CdPA entries and one or more CgPA entries are associated with a MAP Opcode. This command provisions both CgPA and CdPA entries into the database.

**Keyword:** ent-gsmmap-scrn

**Related Commands:** chg-gsmmap-scrn, chg-map, dlt-gsmmap-scrn, dlt-map, rtrv-gsmmap-scrn, rtrv-map

**Command Class:** Database Administration

### Parameters

**NOTE:** See "Point Code Formats and Conversion" for a detailed description of point code formats, rules for specification, and examples.

**:cgsr=** (mandatory)

The CGPA screening reference. CGSR uniquely identifies a CGPA entry for a specified OPNAME.

**Range:** ayyy

1 alphabetic character and up to 3 optional alphanumeric characters

**:opname=** (mandatory)

The user-defined name for the operation code. The **opname** value references the operation code (**opcode**) defined with the **ent-gsms-opcode** command. GSM Map Screening is performed on the specified address or addresses for the referenced operation code.

**Range:** ayyyyyyy

Up to 8 alphanumeric characters

**:action=** (optional)

The screening action to take if a message is forbidden as defined by the **forbid** parameter.

**Range:** **atierr**, **discard**, **dupdisc**, **duplicate**, **forward**, **pass**, **route**

**atierr** — An ATI (Any Time Interrogation) reject message is generated. This option is only valid for ATI MAP operation codes.

**discard** — The MSU is to be discarded.



**dupdisc**— Route the original message to the duplicate node. The original message will not be sent to the original node. If, however, the duplicate node is not available for routing, the MSU is discarded.

**duplicate**— Route the message as normal to the original destination and route a copy of the original message to the duplicate node. If the MSU fails to route to the duplicate node, a UIM is generated indicating the duplicate routing failure.

**forward**— Route the original message to the forward node. The original message will not be sent to the original node. If, however, the forward node is not available for routing, the MSU is routed to the original node.

**pass**— Route the message as normal to the destination.

**route**— Route the message as normal to the original destination node; no UIM will be generated. The original destination is the node to which normal GTT would be sent if no GSM MAP actions are taken.

**Default:** **discard**

**:cdsr=** (optional)

The CDPA screening reference. CDSR uniquely identifies a CDPA entry for a specified combination of CGSR and OPNAME.

**Range:** *ayyy*

1 alphabetic character and up to 3 optional alphanumeric characters

**:eaddr=** (optional)

In association with **npv**, **naiv**, **cgsr**, and **cdsr**, it is for the ending CDPA address in the range to be screened.

**Range:** 1-15 digits

Valid digits are **0-9**, **a-f**, **A-F**

**:forbid=** (optional)

The forbidden parameter value. Indicates a forbidden parameter for the entered address. If a forbidden parameter is detected the message is rejected by the action defined by the **action** parameter.

**Range:** **all**, **none**, **state**, **location**

**all**— All parameters are forbidden. Take the specified screening action defined by the **action** parameter for messages arriving at the system.

**none**— None of the parameters are forbidden. Route the message to its destination.

**state**— Take the specified screening action defined by the **naction** parameter for messages arriving at the system that contain **state** as the forbidden parameter for the entered address/operation code combination. Note: The **state** parameter is valid only for GSM ATI messages.

**location**— Take the specified screening action defined by the **naction** parameter for messages arriving at the system that contain **location** as the forbidden parameter for the entered address/operation code combination. Note: The **location** parameter is valid only for GSM ATI messages.

**Default:** **all**

**:force=** (optional)

Check Mated Application Override. This parameter must be used to complete command execution if the **pc/pca/pci/pcn/pcn24** and **ssn** parameter combination specified in the command is not already defined in the SCCP Application entity set (Remote Point Code/Mated Application Table).

**Range:** **yes**, **no**

**Default:** **no**

**:mapset=** (optional)

The MAP set ID.

**Range:** **1-36000 dflt**

**dflt**—Default MAP set

**:naiv=** (optional)

Nature of Address value for the address or range of CgPA and CdPA addresses. If a message is screened and does not contain matching **npv** and **naiv** values, the message is rejected. The message is rejected with the default action defined by the **ent-gsms-opcode** command for the operation code (**opcode**) parameter entry referenced by the operation name (**opname**) parameter.

This parameter must be specified with the **npv** parameter.

**Range:** 0-127, \*

**Default:** \*

**:npv=** (optional)

Numbering Plan value for the address or range of CgPA and CdPA addresses. If a message is screened and does not contain matching **npv** and **naiv** values, the message is rejected. The message is rejected with the default action defined by the **ent-gsms-opcode** command for the operation code (**opcode**) parameter entry referenced by the operation name (**opname**) parameter.

This parameter must be specified with the **naiv** parameter.

**Range:** 0-15 \*

**Default:** \*

**:pc=** (optional)

ANSI point code with subfields *network indicator-network cluster-network cluster member (ni-nc-ncm)*.

**Synonym:** **pca**

**Range:** 000-255

Specify a valid value for each subfield of the point code, and separate the subfields with a dash (-).

When **chg-sid:pctype=ansi** is specified, *ni = 000* is not valid.

When **chg-sid:pctype=ansi** is specified, *nc = 000* is not valid if *ni = 001-005*.

When **chg-sid:pctype=ansi** is specified, *nc = 000* is valid if *ni = 006-255*.

The point code **000-000-000** is not a valid point code.

**:pc/pca/pci/pcn/pcn24=** (optional)

Point code. The **pc/pca/pci/pcn/pcn24** and **nssn** parameters are used when the default screening action (**dfltact**) is **forward**, **duplicate**, or **dupdisc** (duplicate and discard). These parameters are used to enter the node to which the input message will be routed.

**:pci=** (optional)

ITU international point code with subfields *zone-area-id*. The *prefix* subfield indicates a spare point code (*prefix-zone-area-id*).

**Range:** s-, 0-255

Specify a valid value for each subfield of the point code, and separate the subfields with a dash (-).

*prefix*—s-

*zone*—0-7

*area*—000-255

*id*—0-7

The point code **0-000-0** is not a valid point code.

**:pcn=** (optional)

ITU national point code in the format of a 5-digit number (*nnnnn*); or 2, 3, or 4 numbers (members) separated by dashes (*m1-m2-m3-m4*) as defined by the **chg-stpopts:npcfmti** flexible point code option. A group code must be specified when the ITUDUPPC feature is turned on (*nnnnn-gc, m1-*

*m2-m3-m4-gc*). The *prefix* subfield indicates a spare point code (*prefix-nnnnn*, *prefix-nnnnn-gc*, *prefix-m1-m2-m3-m4*, *prefix-m1-m2-m3-m4-gc*).

**Range:** **s-, 0-16383, aa-zz**

Specify a valid value for each subfield of the point code, and separate the subfields with a dash (-).

*prefix*—s-

*nnnnn*—0-16383

*gc*—aa-zz

*m1-m2-m3-m4*—0-14 for each member; values must sum to 14

**:pcn24=** (optional)

24-bit ITU national point code with subfields *main signaling area-sub signaling area-signaling point* (*msa-ssa-sp*).

**Range:** **000-255**

Specify a valid value for each subfield of the point code, and separate the subfields with a dash (-).

*msa*—000-255

*ssa*—000-255

*sp*—000-255

**:ri=** (optional)

Routing indicator. This parameter specifies whether a subsequent global title translation is required. This parameter can be specified only when the value specified for the **action** parameter is **forward**, **duplicate** or **dupdisc**.

**Range:** **gt, ssn**

**System**

**Default:** **ssn**

**:saddr=** (optional)

The starting origination address.

In association with the **npv**, **naiv**, and **cgsr** parameters, this parameter is for the single CGPA entry or the starting CGPA address in the range to be screened.

In association with the **npv**, **naiv**, and **cdsr** parameters, this parameter is for the single CDPA entry or the starting CDPA address in the range to be screened.

**Range:** 1-15 digits, \*

Valid digits are 0-9, a-f, A-F

**Default:** \*

**:ssn=** (optional)

Subsystem Number. The **pc/pca/pci/pcn/pcn24** and **ssn** parameters are used when the screening action (**action**) is **forward**, **duplicate**, or **dupdisc** (duplicate and discard). These parameters allow the craftsperson to change the defined node to which the input message will be routed.

**Range:** **002-255 none**

**Default:** **none**

**:tt=** (optional)

Translation type. This parameter specifies the value that the CdPA TT is set to as the result of Enhanced GSM Map Screening.

**This parameter can be specified only if the value specified for the action parameter is forward, duplicate, or dupdisc.**

**Range:** **0-255 none**

**Default:** none

### Example

The following example adds a MAP opname of ati with a range of allowed addresses, defines a forbidden parameter for that range of addresses and an action to take if the forbidden parameter is detected, and sets the npv and naiv values. This example is wrapped to the next line for readability:

```
ent-gsmmap-
scrn:saddr=919461:eaddr=919462:opname=ati:action=discard:forbid=state :npv=1:naiv=4:cgsr=fela
```

The following example adds a MAP opname of ati with a range of allowed addresses, defines a forbidden parameter for that range of addresses and an action to take if the forbidden parameter is detected, and sets the npv and naiv values. The command also defines an ITU International Point Code with Subsystem Number 5, and forbids by location messages that have an action of forward. This example is wrapped to the next line for readability:

```
ent-gsmmap-
scrn:saddr=919461:eaddr=919462:opname=ati:action=forward:pci=1-1-1 :ssn=5:force=yes:forbid=location:cgsr=fela
```

The following example adds a MAP opname of xyz with an allowed hexadecimal address of abcdefabcdefabc, defines the action discard to take if a forbidden parameter is detected, and sets the npv and naiv values. The command also defines a CGSR of fela. This example is wrapped to the next line for readability:

```
ent-gsmmap-
scrn:opname=xyz:saddr=abcdefabcdefabc:npv=10:naiv=10:cgsr=fela :action=discard

ent-gsmmap-
scrn:opname=test2:cgsr=t1:cdsr=cd3:saddr=125:pci=s-1-1-1:ssn=10 :action=duplicate

ent-gsmmap-
scrn:opname=test2:cgsr=cg1:cdsr=cd1:saddr=125:pci=1-1-1:ssn=10:action=duplicate:mapset=11

ent-gsmmap-
scrn:opname=test3:cgsr=ad:action=forward:pc=1-1-2:ssn=12:ri=gt

ent-gsmmap-
scrn:opname=test4:cgsr=ks1:action=forward:mapset=df1t:pc=1-2-3:ssn=12:tt=11
```

### Dependencies

The GSM Map Screening feature must be turned on (see the **enable-ctrl-feat** and **chg-ctrl-feat** commands) before this command can be entered.

The EGMS feature must be turned on before:

- The **saddr=\*** parameter can be specified.
- Values for the **saddr** and **eaddr** parameters can contain hexadecimal digits.
- The **cdsr** parameter can be specified.
- The **pc/pca** parameter can be specified.

If the **eaddr** parameter is specified, the **saddr** parameter must be specified.

If the **eaddr** parameter is specified, then its value must contain the same number of digits as the value of the **saddr** parameter.

If the **eaddr** parameter is specified, its value must be greater than the **saddr** parameter value.

If the **saddr=\*** parameter is specified, then the **eaddr** parameter cannot be specified.

If the **opname** parameter is specified, its value must exist in the GSM MAP Op-Code table.

A value of **state** or **location** cannot be specified for the **forbid** parameter unless the operation code (**opcode**) referenced by **opname** is **71**. The **opcode=71** parameter signifies an ATI MAP operation code.

The **action=atierr** parameter cannot be specified unless the operation code (**opcode**) referenced by the **opname** parameter is **71**. The **atierr** option is only valid for ATI MAP operation codes, and the **opcode=71** parameter signifies an ATI MAP operation code.

The GSM MAP Screening table cannot be full.

The GSM MAP Screening table must have at least two free entries to provision a CgPA entry, because a default wildcard CdPA entry is created for each CgPA entry.

If a single entry is specified for the CgPA/CdPA (the **eaddr** parameter is not specified), then the combination of **saddr/npv/naiv** and **opname** parameters must not already exist in the GSM MAP screening table.

If a range entry is specified for the CgPA/CdPA (the **eaddr** parameter is specified), then the **saddr/eaddr/npv/naiv** and **opname** combination must not already exist or overlap another range entry in the GSM MAP screening table.

If a CdPA entry is being created, then the CGSR must already exist for the specified OPNAME.

If a CgPA entry is being created, the CGSR cannot already exist for the specified OPNAME.

The specified **cdsr** cannot already exist for the specified **cgsr**.

If specified, the **pc/pca/pci/pcn/pcn24** parameter must be a full point code.

If the **action** parameter is specified and its value is **forward**, **duplicate**, or **dupdisc**, the **pc/pca/pci/pcn/pcn24** parameter and the **ssn** parameter must be specified.

The **pc/pca/pci/pcn/pcn24** parameter and the **ssn** parameter can be specified only if the **action** parameter is specified and its value is **forward**, **duplicate**, or **dupdisc**.

The **force** parameter can be specified only if the **pc/pca/pci/pcn/pcn24** parameter and the **ssn** parameter are specified.

If the **pc/pca/pci/pcn/pcn24** parameter and the **ssn** parameter are specified, and the **force** parameter is not specified as **yes**, then the PC/SSN must be populated in the SCCP Application entity set (Remote Point Code/MAP Table).

The values for the **npv** and **naiv** parameters must be either both numbers or both asterisks (\*). The parameters cannot be specified as **:npv=\*:naiv=9** or **:npv=9:naiv=\***, for example.

If specified, the **pc/pca/pci/pcn/pcn24** parameter value must exist as a destination in the Ordered Route entity set or reside in a cluster (ANSI only) that exists as a destination in the Ordered Route entity set (for global title routing).

If the **action** parameter is specified as **forward**, **duplicate**, or **dupdisc**, then the **mapset** parameter must be specified.

If the **mapset**, **ri**, or **tt** parameter is specified, then the value specified for the **action** parameter must be **forward**, **duplicate**, or **dupdisc**.

The Flexible GTT Load Sharing feature must be enabled before the **mapset** parameter can be specified.

The specified MAP set must exist.

If the value of the **mapset** parameter is not **dfit**, then the specified PC/SSN must exist in the specified MAP set.

If the **mapset=dflt** parameter is specified, and the **force** parameter is not specified as **yes**, then the specified PC/SSN must exist in the specified MAP set.

If the **action** parameter has a value of **forward**, **duplicate**, or **dupdisc**, then the value specified for the **pc/pca/pci/pcn/pcn24** parameter cannot be associated with a proxy point code.

If the **ri=ssn** parameter is specified, then the **ssn=none** parameter cannot be specified.

If the **forbid=none** parameter is specified, then the value specified for the **action** parameter must be **pass**.

## Notes

GSM screening entries are handled differently from other screening entries such as GWS (gateway screening) in the system database. The following differences apply to provisioning GSM screening entries:

- GSM screening entries can be either single entries or range entries.
- Single entries have precedence in screening over range entries. Thus the single entries are searched first and if a match is found, the range entries are never searched.
- Range entries can overlap single entries.

In this command, only ITU-international and ITU national point codes support the spare point code subtype prefix (s-).

## Output

```
ent-gsmmap-
scrn:opname=test2:cgsr=cg1:cdsr=cd1:saddr=125:pci=1-1-1:ssn=10:ac
tion=duplicate:mapset=11
tekelecstp 06-05-29 13:24:41 EST EAGLE 35.0.0
GSM Map Screening table is (1 of 4000) 1% full
ENT-GSMMAP-SCRN: MASP A - COMPLTD
;

ent-gsmmap-
scrn:opname=test3:cgsr=ad:action=forward:pc=1-1-2:ssn=12:ri=gt
tekelecstp 08-01-18 17:03:01 EST EAGLE 38.0.0
GSM MAP Screening Table (4 of 4000) is 1% full
ENT-GSMMAP-SCRN: MASP A - COMPLTD
;

ent-gsmmap-
scrn:opname=test4:cgsr=ks1:action=forward:mapset=dflt:pc=1-2-3:ss
n=12:tt=11
tekelecstp 08-08-20 19:13:01 EST EAGLE 39.2.0
GSM MAP Screening Table (1 of 4000) is 1% full
ENT-GSMMAP-SCRN: MASP A - COMPLTD
;
```

## ent-gsms-opcode

### Enter GSM MAP Screening Operation Code

Use this command to assign the concerned GSM (Global System for Mobile Telecommunication) MAP (mobile application part) screening operation codes and the default screening action for the operation code. This command allows the craftsperson to provision a list of all operation codes that the system uses in performing GSM screening.

**Keyword:** ent-gsms-opcode

**Related Commands:** chg-gsms-opcode, dlt-gsms-opcode, rtrv-gsms-opcode

**Command Class:** Database Administration

**Parameters**

**NOTE: See "Point Code Formats and Conversion" for a detailed description of point code formats, rules for specification, and examples.**

**:opcode=** (mandatory)

MAP operation code. This parameter refers to the actual decimal value of the MAP operation codes from the TCAP layer of GSM MAP messages.

**Range:** **0-255 \***

If a decimal Map Opcode is not found in the database, then the asterisk (wildcard \*), if provisioned, will constitute a match when screening the MSUs.

**:opname=** (mandatory)

Name for the operation code. The **opname** value is defined with the **ent-gsmmap-scrn** command.

**Range:** *ayyyyyyy*

Up to 8 alphanumeric characters

**:dfltact=** (optional)

Default screening action for a MAP operation code. The default screening action is used when a matching CGPA address+NPV+NAIV entry is not found in the GSM MAP screening table.

**Range:** **atierr, discard, dupdisc, duplicate, forward, pass, route**

**atierr**— Do not route the MSU. An ATI (Any Time Interrogation) reject message is generated. This option is only valid for ATI MAP operation codes.

**discard**— Do not route the MSU. The MSU is discarded (thrown away) and an appropriate UIM is issued.

**dupdisc**— Route the original message to the duplicate node. The original message will not be sent to the original node. If, however, the duplicate node is not available for routing, the MSU is discarded.

**duplicate**— Route the message as normal to the original destination and route a copy of the original message to the duplicate node. If the MSU fails to route to the duplicate node, a UIM is generated indicating the duplicate routing failure.

**forward**— Route the original message to the forward node. The original message will not be sent to the original node. If, however, the forward node is not available for routing, the MSU is routed to the original node.

**pass**— Route the message as normal to the destination.

**route**— Route the message as normal to the original destination node; no UIM will be generated. The original destination is the node to which normal GTT would be sent if no GSM MAP actions are taken.

**Default:** **discard**

**:force=** (optional)

Check Mated Application Override. This parameter must be used to complete command execution if the **pc/pca/pci/pcn/pcn24** and **ssn** parameter combination specified in the command is not already defined in the SCCP Application entity set (Remote Point Code/Mated Application Table).

**Range:** **yes, no**

**Default:** **no**

**:mapset=** (optional)

The MAP set ID.

**Range:** **1-36000 dflt**

**dflt**—Default MAP set

**:pc=** (optional)

ANSI point code with subfields *network indicator-network cluster-network cluster member (ni-nc-ncm)*.

**Synonym:** *pca***Range:** 000-255

Specify a valid value for each subfield of the point code, and separate the subfields with a dash (-).

When **chg-sid:pctype=ansi** is specified, *ni* = 000 is not valid.

When **chg-sid:pctype=ansi** is specified, *nc* = 000 is not valid if *ni* = 001-005.

When **chg-sid:pctype=ansi** is specified, *nc* = 000 is valid if *ni* = 006-255.

The point code 000-000-000 is not a valid point code.

**:pc/pca/pci/pcn/pcn24=** (optional)

Point code. The **pc/pca/pci/ncn/pcn24** and **ssn** parameters are used when the default screening action (**dflfact**) is **forward**, **duplicate** or **dupdisc** (duplicate and discard). These parameters allow the craftsman to change the defined node to which the input message will be routed.

**:pci=** (optional)

ITU international point code with subfields *zone-area-id*. The *prefix* subfield indicates a spare point code (*prefix-zone-area-id*).

**Range:** s-, 0-255

Specify a valid value for each subfield of the point code, and separate the subfields with a dash (-).

*prefix*—s-*zone*—0-7*area*—000-255*id*—0-7

The point code 0-000-0 is not a valid point code.

**:pcn=** (optional)

ITU national point code in the format of a 5-digit number (*nnnnn*); or 2, 3, or 4 numbers (members) separated by dashes (*m1-m2-m3-m4*) as defined by the **chg-stpopts:npcfmti** flexible point code option. A group code must be specified when the ITUDUPPC feature is turned on (*nnnnn-gc*, *m1-m2-m3-m4-gc*). The *prefix* subfield indicates a spare point code (*prefix-nnnnn*, *prefix-nnnnn-gc*, *prefix-m1-m2-m3-m4*, *prefix-m1-m2-m3-m4-gc*).

**Range:** s-, 0-16383, aa-zz

Specify a valid value for each subfield of the point code, and separate the subfields with a dash (-).

*prefix*—s-*nnnnn*—0-16383*gc*—aa-zz*m1-m2-m3-m4*—0-14 for each member; values must sum to 14**:pcn24=** (optional)

24-bit ITU national point code with subfields *main signaling area-sub signaling area-signaling point* (*msa-ssa-sp*).

**Range:** 000-255

Specify a valid value for each subfield of the point code, and separate the subfields with a dash (-).

*msa*—000-255*ssa*—000-255*sp*—000-255



**:ri=** (optional)

Routing indicator. This parameter specifies whether a subsequent global title translation is required. This parameter can be specified only when the value specified for the **dfltact** parameter is **forward**, **duplicate**, or **dupdisc**.

**Range:** gt, ssn

**System**

**Default:** ssn

**:ssn=** (optional)

Subsystem Number. The **pc/pca/pci/pcn/pcn24** and **ssn** parameters are used when the default screening action (**dfltact**) is **forward**, **duplicate** or **dupdisc** (duplicate and discard). These parameters allow the craftsperson to change the defined node to which the input message will be routed.

**Range:** 002-255 none

**Default:** none

**:tt=** (optional)

Translation type. This parameter specifies the value that the CdPA TT is set to as the result of Enhanced GSM Map Screening.

The parameter can be specified only if the value specified for the **dfltact** parameter is **forward**, **duplicate**, or **dupdisc**.

**Range:** 0-255 none

**Default:** none

## Example

The following example adds a MAP operation code of 71 with a name of ati with a default action of discard:

```
ent-gsms-opcode:opcode=71:opname=ati:dfltact=discard
```

The following example adds a MAP operation code of 71 with a name of ati with a default action of forward, an international point code of 1-1-1, a subsystem number of 5, and forces:

```
ent-gsms-  
opcode:opcode=71:opname=ati:dfltact=forward:pci=1-1-1:ssn=5:force  
=yes
```

The following example adds a MAP operation code of 71 with a name of ati with a default action of duplicate, an international point code of 1-1-1, a subsystem number of 5, and forces:

```
ent-gsms-  
opcode:opcode=71:opname=ati:dfltact=duplicate:pci=1-1-1:ssn=5:for  
ce=yes
```

The following example adds a MAP operation code of 71 with a name of ati with a default action of dupdisc, an international point code of 1-1-1, a subsystem number of 5, and forces:

```
ent-gsms-  
opcode:opcode=71:opname=ati:dfltact=dupdisc:pci=1-1-1:ssn=5:force  
=yes
```

The following example adds a MAP operation code of \* with a name of xyz with a default action of duplicate, an ANSI point code of 8-8-8, a subsystem number of 20:

```
ent-gsms-  
opcode:opcode=*:opname=xyz:pca=8-8-8:dfltact=duplicate:ssn=20
```

The following example adds a MAP operation code of 22 with a name of ati with a default action of discard:

```
ent-gsms-opcode:opcode=22:opname=ati:dfltact=discard
```

The following example shows a spare point code:

```
ent-gsms-
opcode:opname=test3:opcode=3:pci=s-1-1-1:dfltact=duplicate:ssn=10
:force
```

The following example shows a MAP set value. The Flexible GTT Load Sharing feature is ON.

```
ent-gsms-
opcode:opname=test3:opcode=3:pc=1-1-1:dfltact=duplicate:ssn=10:ma
pset=7
```

The following example adds a MAP operation code of 27 with a name of test3 with a default action of forward, an ANSI point code of 1-1-2, a subsystem number of 12 and a routing indicator of gt:

```
ent-gsms-
opcode:opname=test3:opcode=27:dfltact=forward:pca=1-1-2:ssn=12:ri
=gt
```

The following example shows a translation type value:

```
ent-gsms-
opcode:opname=test4:opcode=32:dfltact=forward:mapset=dflt:pc=1-2-
3:ssn=12:tt=11
```

## Dependencies

The GSM Map Screening feature (see the **enable-ctrl-feat** command) must be turned on before this command can be entered.

If the **dfltact** parameter is specified, then the **pass**, **discard**, **atierr**, **route**, **forward**, **duplicate**, or **dupdisc** value must be assigned.

The reserved word **none** cannot be specified as a value for the **opname** parameter.

The **pc/pca/pci/pcn/pcn24** and **ssn** parameters can be specified only if the **dfltact** parameter is specified and its value is **forward**, **duplicate**, or **dupdisc**.

If the **dfltact** parameter is specified with a value of **forward**, **duplicate**, or **dupdisc**, then a **pc/pca/pci/pcn/pcn24** parameter and the **ssn** parameter must be specified.

The **force** parameter can be specified only if a **pc/pca/pci/pcn/pcn24** parameter and the **ssn** parameter are specified.

The **dfltact=atierr** parameter cannot be specified unless the value of the operation code referenced by the **opname** parameter is **71**. The **atierr** option is valid only for ATI MAP operation codes, and the **opcode=71** parameter signifies an ATI MAP operation code.

The value specified for the **opcode** parameter cannot already exist in the GSM Map Op-Code table.

The value specified for the **opname** parameter cannot already be used in the GSM Map Op-Code table.

If the **pc/pca/pci/pcn/pcn24** parameter and the **ssn** parameter are specified, and the **force** parameter is not specified as **yes**, then the PC-SSN must exist in the SCCP Application entity set (Remote Point Code / Mated Application Table).

The Enhanced GSM Map Screening feature must be enabled and turned on before the **opcode=\*** parameter can be specified.

If specified, the **pc/pca/pci/pcn/pcn24** parameter value must be a full point code.

If specified, the **pc/pca/pci/pcn/pcn24** parameter value must exist as a destination in the Ordered Route entity set or reside in a cluster (ANSI only) that exists as a destination in the Ordered Route entity set (for global title routing).

The Enhanced GSM Map Screening feature must be enabled and turned on when the PC/PCA is specified.

If the **mapset**, **ri**, or **tt** parameter is specified, then the value specified for the **dfltact** parameter must be **forward**, **duplicate**, or **dupdisc**.

If the **dfltact** parameter is specified as **forward**, **duplicate**, or **dupdisc**, then the **mapset** parameter must be specified.

The Flexible GTT Load Sharing feature must be enabled before the **mapset** parameter can be specified.

The specified MAP set must exist.

If the **mapset** parameter is not specified as **dflt**, or if the **mapset=dflt** parameter is specified, and the **force** parameter is not specified as **yes**, then the specified PC/SSN must exist in the specified MAP set.

If the **dfltact** parameter has a value of **forward**, **duplicate**, or **dupdisc**, then the value specified for the **pc/pca/pci/pcn/pcn24** parameter cannot be associated with a proxy point code.

If the **ri=ssn** parameter is specified, then the **ssn=none** parameter cannot be specified.

## Notes

Origination Addresses are considered to be the SCCP CGPA address as well as the Numbering Plan and Nature of Address values.

In this command, only ITU-international and ITU national point codes support the spare point code subtype prefix (s-).

## Output

```
ent-gsms-
opcode:opname=test3:opcode=3:pc=1-1-1:dfltact=duplicate:ssn=10:mapset=7
tekelecstp 06-05-29 13:21:58 EST EAGLE 35.0.0
ENT-GSMS-OPCODE: MASP A - COMPLTD
;

ent-gsms-
opcode:opname=test3:opcode=27:dfltact=forward:pca=1-1-2:ssn=12:ri=gt
tekelecstp 08-01-18 16:56:43 EST EAGLE 38.0.0
ENT-GSM-OPCODE: MASP A - COMPLTD
;

ent-gsms-
opcode:opname=test4:opcode=32:dfltact=forward:mapset=dflt:pc=1-2-3:ssn=12:tt=11
tekelecstp 08-08-20 19:13:01 EST EAGLE 39.2.0
ENT-GSM-OPCODE: MASP A - COMPLTD
;
```

## ent-gsmssn-scrn

### Enter GSM Subsystem Number Screening Entry

Use this command to provision origination and destination SSNs (subsystem numbers) to be screened using the GSM (Global System for Mobile Telecommunication) MAP (mobile application part) screening feature. The value of the **ssn** parameter that is entered with this command is added to the GSM SSN screening table. All theMAP messages with the originating or destination **ssn** entered are screened using the GSM Map screening feature.

**Keyword:** ent-gsmssn-scrn

**Related Commands:** dlt-gsmssn-scrn, rtrv-gsmssn-scrn

**Command Class:** Database Administration

**Parameters**

**:ssn=** (mandatory)  
 Subsystem number.  
**Range:** 000-255

**:type=** (mandatory)  
 Subsystem type.  
**Range:** **dest, orig**  
**dest**— The destination SSN  
**orig**— The origination SSN

**Example**

The following example adds an originating subsystem of 10 to the GSM SSN Screening table:

```
ent-gsmssn-scrn:ssn=10:type=orig
```

**Dependencies**

The GSM Map Screening feature must be turned on (see the **enable-ctrl-feat** command) before this command can be entered.

A value for the **ssn** and **type** parameter combination cannot be specified that already exists in the GSM SSN screening table.

**Notes**

None

**Output**

```
ent-gsmssn-scrn:ssn=10:type=orig
rlghncxa03w 04-01-10 11:43:04 EST EAGLE 31.3.0
ENT-GSMSSN-SCRN: MASP A - COMPLTD
;
```

**ent-gta****Enter Global Title Address Information  
Command**

Use this command to specify the GTA (global title address) information for applicable global title selectors required to specify a global title entry.

This command adds the routing object (a destination address and a subsystem number) for messages requiring a global title translation. The translation is performed on the basis of the global title address (**gta**), global title indicator (**gti**), numbering plan (**np**), nature of address indicator (**nai**), and translation type (**tt**) of each SS7 SCCP message directed to the STP with a routing indicator of 0, indicating a GTT is required.

**Keyword:** ent-gta

**Related Commands:** chg-gta, dlt-gta, rtrv-gta

**Command Class:** Database Administration

## Parameters

**NOTE:** See "Point Code Formats and Conversion" for a detailed description of point code formats, rules for specification, and examples.

**NOTE:** As of Release 41.0, the *cggtasn*, *cgpcsn*, *cgssnsn*, and *selid* parameters are obsolete. The *optsn* parameter replaces the *cggtasn*, *cgpcsn*, and *cgssnsn* parameters. The *cgselid* or *cdselid* parameter replaces the *selid* parameter.

**NOTE:** The TCAP Opcode Based Routing (TOBR) feature must be turned on before the *cdssn* and *ecdssn* parameters can be specified. A TOBR quantity feature must be turned on before the *acn*, *family*, *opcode*, or *pkgtype* parameter can be specified.

**NOTE:** The Origin based SCCP Routing (OBSR) feature must be enabled or the Flexible Option Based Routing (FLOBR) feature must be turned on before the *cgselid* or *optsn* parameter can be specified.

**NOTE:** The FLOBR feature must be turned on before the *cdselid*, *cgcnvsn*, *fallback*, or *testmode* parameter can be specified. The SCCP Conversion feature must be enabled and the FLOBR feature must be turned on before the *cgcnvsn* parameter can be specified.

**:gttsn=** (mandatory)

GTT set name. This parameter specifies the entity to which global title addresses and selectors are assigned.

**Range:** *ayyyyyyyy*  
1 leading alphabetic and up to 8 following alphanumeric characters.

**:xlat=** (mandatory)

Translate indicator. This parameter specifies translation actions and routing actions.

**Range:** *dpc, dpcngt, dpcssn, udts, disc*

**:acn=** (optional)

Application context name. This parameter specifies the ITU TCAP *acn* field in the incoming MSU.

**Range:** *0-255 \**, *none*  
The *acn* supports up to 7 subfields separated by dash (e.g., *1-202-33-104-54-26-007*)  
\*—any valid value in the ITU TCAP *acn* field in the incoming MSU  
*none*—there is no ITU TCAP *acn* field in the incoming MSU

**:ccgt=** (optional)

Cancel called global title indicator.

**Range:** *yes, no*  
**Default:** *no*

**:cdselid=** (optional)

CdPA Selector ID.

**Range:** *0-65534*

**:cdssn=** (optional)

Starting CdPA subsystem number.

**Range:** *0-255*

**:cgcnvsn=** (optional)

CgPA conversion set name.

**Range:** *ayyyyyyyy*  
1 leading alphabetic character and up to 8 following alphanumeric characters.

**:cggtmod=** (optional)

Calling party GT modification indicator. This parameter specifies whether calling party global title modification is required.

**Range:**     **yes, no**

**Default:**   **no**

**:cgpc=** (optional)

ANSI CgPA point code with subfields *network indicator-network cluster-network cluster member (ni-nc-ncm)*.

**Synonym:** **cgpca**

**Range:**     **000-255, \***

Specify a valid value for each subfield of the point code, and separate the subfields with a dash (-).

The asterisk (\*) value is not valid for the *ni* subfield.

When **chg-sid:pctype=ansi** is specified, *ni* = **000** is not valid.

When **chg-sid:pctype=ansi** is specified, *nc* = **000** is not valid if *ni* = **001-005**.

When **chg-sid:pctype=ansi** is specified, *nc* = **000** is valid if *ni* = **006-255**.

When **chg-sid:pctype=ansi** is specified, *ni*-\*-\* is valid if *ni* = **006-255**.

The point code **000-000-000** is not a valid point code.

**:cgpci=** (optional)

ITU international CgPA point code with subfields *zone-area-id*. The *prefix* subfield indicates a spare point code (*prefix-zone-area-id*).

**Range:**     **s-, 0-255**

Specify a valid value for each subfield of the point code, and separate the subfields with a dash (-).

*prefix*—**s-**

*zone*—**0-7**

*area*—**000-255**

*id*—**0-7**

The point code **0-000-0** is not a valid point code.

**:cgpcn=** (optional)

ITU national CgPA point code in the format of a 5-digit number (*nnnnn*); or 2, 3, or 4 numbers (members) separated by dashes (*m1-m2-m3-m4*) as defined by the **chg-stpopts:npcfmti** flexible point code option. A group code must be specified when the ITUDUPPC feature is turned on (*nnnnn-gc*, *m1-m2-m3-m4-gc*). The *prefix* subfield indicates a spare point code, (*prefix-nnnnn*, *prefix-nnnnn-gc*, *prefix-m1-m2-m3-m4*, *prefix-m1-m2-m3-m4-gc*).

**Range:**     **s-, 0-16383, aa-zz**

Specify a valid value for each subfield of the point code, and separate the subfields with a dash (-).

*prefix*—**s-**

*nnnnn*—**0-16383**

*gc*—**aa-zz**

*m1-m2-m3-m4*—**0-14** for each member; values must sum to 14

**:cgpcn24=** (optional)

24-bit ITU national CgPA point code with subfields *main signaling area-sub signaling area-signaling point (msa-ssa-sp)*.

**Range:**     **000-255**

Specify a valid value for each subfield of the point code, and separate the subfields with a dash (-).

*msa*—**000–255**

*ssa*—**000–255**

*sp*—**000–255**

**:cgselid=** (optional)

CgPA Selector ID.

**Range:** **0-65534**

**:cgssn=** (optional)

Starting CgPA subsystem number.

**Range:** **0-255**

**:ecdssn=** (optional)

Ending CdPA subsystem number.

**Range:** **0-255**

**:ecgssn=** (optional)

Ending CgPA subsystem number.

**Range:** **0-255**

**:egta=** (optional)

End global title address. This parameter specifies the end of a range of global title digits.

**Range:** 1-21 digits

If the Hex Digit Support for GTT feature is not enabled and on, the range is 1 - 21 decimal digits; valid digits are **0-9**.

If the Hex Digit Support for GTT feature is enabled and on, the range is 1 - 21 hexadecimal digits; valid digits are **0-9, a-f, A-F**.

**Default:** Same as the specified **gta** value

**:fallback=** (optional)

Fallback option. This parameter specifies the action taken when the final translation does not match while performing GTT using a FLOBR-specific GTT mode.

**Range:** **yes, no, sysdflt**

**yes** — perform GTT based on the last matched entry

**no** — GTT fails and the MSU is discarded

**sysdflt** — use the system-wide default fallback option in the SCCPOPTS table

**Default:** **sysdflt**

**:family=** (optional)

This parameter specifies the ANSI TCAP *family* field in the incoming MSU.

**Range:** **0-255 \*, none**

**\***—any valid value in the ANSI TCAP *family* field in the incoming MSU

**none**—there is no value in the ANSI TCAP *family* field in the incoming MSU

**:force=** (optional)

Check mated application override. This parameter must be used to complete command execution if the **pci/pcn** and **ssn** parameter combination specified in the command is not already defined in the SCCP Application entity set (Remote Point Code/Mated Application Table).

**Range:** **yes, no**

**Default:** **no**

**:gta=** (optional)

Global title address. This parameter specifies the beginning of a range of global title digits.

**Range:** 1-21 digits  
 If the Hex Digit Support for GTT feature is not enabled and on, the range is 1 - 21 decimal digits; valid digits are **0-9**.  
 If the Hex Digit Support for GTT feature is enabled and on, the range is 1 - 21 hexadecimal digits; valid digits are **0-9, a-f, A-F**.

**:loopset=** (optional)

SCCP loopset name. This parameter associates a translation set with a loopset.

**Range:** *ayyyyyyy*, **none**  
 1 leading alphabetic character and up to 7 following alphanumeric characters.  
**none**—There is no association between the translation set and any loopset.

**Default:** **none**

**:mapset=** (optional)

MAP set ID. This parameter specifies the Mated Application set ID.

**Range:** **1-36000 dflt**  
**dflt**—Default MAP set

**:mrnset=** (optional)

MRN set ID. This parameter specifies the Mated Relay Node set ID.

**Range:** **1-3000 none, dflt**  
**dflt**—Default MRN set.

**none**—The GTA translation does not participate in any load sharing.

**:ngti=** (optional)

New GTI code. When the ANSI-ITU-China SCCP Conversion and AMGTT features are ON, and the Translated Point Code is of a different network type, this parameter specifies whether the new GTI translation format is GTI type **2** or GTI type **4**.

**Range:** **2, 4**

**:nnai=** (optional)

New nature of address indicator. This parameter specifies the nature of address indicator that will replace the received nature of address indicator.

**Range:** **0-127**  
**Default:** **0xFFFF**

**:nnp=** (optional)

New numbering plan. This parameter specifies the numbering plan that will replace the received numbering plan.

**Range:** **0-15**  
**Default:** **0xFFFF**

**:npdd=** (optional)

New prefix digits to be deleted. This parameter specifies the new prefix digits to be deleted that will replace the received prefix digits to be deleted.

**Range:** **0-21**  
**Default:** **0**

**:npds=** (optional)

New prefix digits string. This parameter specifies the new prefix digits string that will replace the received prefix digits string.

**Range:** 1-21 digits  
 If the Hex Digit Support for GTT feature is not enabled and on, the range is 1 - 21 decimal digits; valid digits are **0-9**.



If the Hex Digit Support for GTT feature is enabled and on, the range is 1 - 21 hexadecimal digits; valid digits are **0-9, a-f, A-F**.

**Default:** No digits

**:nsdd=** (optional)

New suffix digits to be deleted. This parameter specifies the new suffix digits to be deleted that will replace the received suffix digits to be deleted.

**Range:** **0-21**

**Default:** **0**

**:nsds=** (optional)

New suffix digits string. This parameter specifies the new suffix digits string that will replace the received suffix digits string.

**Range:** 1-21 digits

If the Hex Digit Support for GTT feature is not enabled and on, the range is 1 - 21 decimal digits; valid digits are **0-9**.

If the Hex Digit Support for GTT feature is enabled and on, the range is 1 - 21 hexadecimal digits; valid digits are **0-9, a-f, A-F**.

**Default:** No digits

**:ntt=** (optional)

New translation type. The point code domain translation types for EGTT are handled by the EAGLE 5 ISS protocol processing as either ANSI or ITU; therefore, ITU applies to ITU-I, ITU-I Spare, ITU-N, and ITU-N Spare. ITU-I includes ITU-I Spare, and ITU-N includes ITU-N Spare.

**Range:** **000-255**

**Default:** No **ntt** value provided

**:opc=** (optional)

ANSI originating point code with subfields *network indicator-network cluster-network cluster member (ni-nc-ncm)*.

**Range:** **000-255, \***

Specify a valid value for each subfield of the point code, and separate the subfields with a dash (-).

The asterisk (\*) value is not valid for the *ni* subfield.

When **chg-sid:pctype=ansi** is specified, *ni* = **000** is not valid.

When **chg-sid:pctype=ansi** is specified, *nc* = **000** is not valid if *ni* = **001-005**.

When **chg-sid:pctype=ansi** is specified, *nc* = **000** is valid if *ni* = **006-255**.

When **chg-sid:pctype=ansi** is specified, *ni*-\*-\* is valid if *ni* = **006-255**.

The point code **000-000-000** is not a valid point code.

**:opci=** (optional)

ITU international originating point code with subfields *zone-area-id*. The *prefix* subfield indicates a spare point code (*prefix-zone-area-id*).

**Range:** **s-, 0-255**

Specify a valid value for each subfield of the point code, and separate the subfields with a dash (-).

*prefix*—**s-**

*zone*—**0-7**

*area*—**000-255**

*id*—**0-7**

The point code **0-000-0** is not a valid point code.

**:open=** (optional)

ITU originating point code in the format of a 5-digit number (*nnnnn*); or 2, 3, or 4 numbers (members) separated by dashes (*m1-m2-m3-m4*) as defined by the **chg-stpopts:npcfnti** flexible point code option. A group code must be specified when the ITUDUPPC feature is turned on (*nnnnn-gc*, *m1-m2-m3-m4-gc*). The *prefix* subfield indicates a spare point code (*prefix-nnnnn*, *prefix-nnnnn-gc*, *prefix-m1-m2-m3-m4*, *prefix-m1-m2-m3-m4-gc*).

**Range:** **s-, 0-16383, aa-zz**

Specify a valid value for each subfield of the point code, and separate the subfields with a dash (-).

*prefix*—**s-**

*nnnnn*—**0-16383**

*gc*—**aa-zz**

*m1-m2-m3-m4*—**0-14** for each member; values must sum to 14

**:open24=** (optional)

24-bit ITU national originating point code with subfields *main signaling area-sub signaling area-signaling point* (*msa-ssa-sp*).

**Range:** **000-255**

Specify a valid value for each subfield of the point code, and separate the subfields with a dash (-).

*msa*—**000-255**

*ssa*—**000-255**

*sp*—**000-255**

**:opcode=** (optional)

This parameter specifies the TCAP *opcode* field in the incoming MSU.

**Range:** **0-255 \*, none**

\*—any valid value in the TCAP *opcode* field in the incoming MSU

**none**—there is no value in the TCAP *opcode* field in the incoming MSU

**:opcsn=** (optional)

The OPC GTT set name.

**Range:** *ayyyyyyy*

1 leading alphabetic character and up to 8 following alphanumeric characters.

**:optsn=** (optional)

Optional gtt set name.

**Range:** *ayyyyyyy*

1 leading alphabetic character and up to 8 following alphanumeric characters.

**:pc=** (optional)

ANSI point code with subfields *network indicator-network cluster-network cluster member* (*ni-nc-ncm*). The *prefix* subfield indicates a private point code (*prefix-ni-nc-ncm*).

**Synonym:** **pca**

**Range:** **p-, 000-255**

Specify a valid value for each subfield of the point code, and separate the subfields with a dash (-).

*prefix*—**p-**

When **chg-sid:pctype=ansi** is specified, *ni* = **000** is not valid.

When **chg-sid:pctype=ansi** is specified, *nc* = **000** is not valid if *ni* = **001-005**.

When **chg-sid:pctype=ansi** is specified, *nc* = **000** is valid if *ni* = **006-255**.

The point code **000-000-000** is not a valid point code.

**:pc/pca/pci/pcn/pcn24=** (optional)

Point code.

**:pci=** (optional)

ITU international destination point code with subfields *zone-area-id*. The *prefix* subfield indicates a spare point code, private point code, or private and spare point code (*prefix-zone-area-id*).

**Range:** **s-, p-, ps-, 0-255**

Specify a valid value for each subfield of the point code, and separate the subfields with a dash (-).

*prefix*—**s-, p-, ps-**

*zone*—**0-7**

*area*—**000-255**

*id*—**0-7**

The point code **0-000-0** is not a valid point code.

**:pcn=** (optional)

ITU national point code in the format of a 5-digit number (*nnnnn*); or 2, 3, or 4 numbers (members) separated by dashes (*m1-m2-m3-m4*) as defined by the **chg-stpopts:npcfmti** flexible point code option. A group code must be specified when the ITUDUPPC feature is turned on (*nnnnn-gc*, *m1-m2-m3-m4-gc*). The *prefix* subfield indicates a spare point code, private point code, or private and spare point code (*prefix-nnnnn*, *prefix-nnnnn-gc*, *prefix-m1-m2-m3-m4*, *prefix-m1-m2-m3-m4-gc*).

**Range:** **s-, p-, ps-, 0-16383, aa-zz**

Specify a valid value for each subfield of the point code, and separate the subfields with a dash (-).

*prefix*—**s-, p-, ps-**

*nnnnn*—**0-16383**

*gc*—**aa-zz**

*m1-m2-m3-m4*—**0-14** for each member; values must sum to 14

**:pcn24=** (optional)

24-bit ITU national point code with subfields *main signaling area-sub signaling area-signaling point (msa-ssa-sp)*. The *prefix* subfield indicates a private point code (*prefix-ni-nc-ncm*).

**Range:** **p-, 000-255**

Specify a valid value for each subfield of the point code, and separate the subfields with a dash (-).

*prefix*—**p-**

*msa*—**000-255**

*ssa*—**000-255**

*sp*—**000-255**

**:pkgtype=** (optional)

This parameter specifies the ANSI and ITU TCAP package type.

**Range:** **ituuni, qwp, qwop, resp, cwp, cwop, any, bgn, end, cnt, ituabort, ansiabort, ansiuni**

**ituuni** — ITU unidirectional

**qwp** — Query with Permission

**qwop** — Query without Permission

**resp** — Response

**cwp** — Conversation with Permission

**cwop** — Conversation without Permission  
**any** — Wildcard value  
**bgn** — Begin  
**end** — End  
**cnt** — Continue  
**ituabort** — ITU abort  
**ansiabort** — ANSI abort  
**ansiuni** — ANSI unidirectional  
 ANSI TCAP Package Types—**ansiuni, qwop, qwop, resp, cwp, cwop, ansiabort, any**  
 ITU TCAP Package Types—**bgn, ituabort, ituuni, any, end, cnt**

**:ri=** (optional)

Routing indicator.

**Range:** **gt, ssn**

**gt** — Allow a called party address with a routing indicator value of “global title.”

**ssn** — Allow a called party address with a routing indicator value of “DPC/SSN.”

**:ssn=** (optional)

New translated subsystem number.

**Range:** **002-255**

**Default:** No **ssn** value provided

**:testmode=** (optional)

This parameter is used to invoke a field-safe Test Tool in order to debug the FLOBR/TOBR rules.



**CAUTION: If the testmode=yes parameter is specified, then the rule is used only by test messages. The rule is ignored by 'live' traffic. If the testmode=off parameter is specified, then both test and live messages use the rule. Changing from testmode=off to testmode=on is equivalent to deleting the rule for live traffic.**

**Range:** **on, off**

**on** — Process the translation rules defined in the test message

**off** — Perform standard GTT behavior

**Default:** **off**

**:cggtasn=** (obsolete)

CgPA GTA GTT set name.

**NOTE: This parameter is obsolete, use the optsn parameter.**

**Range:** **ayyyyyyyy, none**

1 leading alphabetic character and up to 8 following alphanumeric characters.

**none**—Set names do not point to the CgGTA set.

**:cgpcsn=** (obsolete)

CgPA PC GTT set name.

**NOTE: This parameter is obsolete, use the optsn parameter.**

**Range:** **ayyyyyyyy**

1 leading alphabetic character and up to 8 following alphanumeric characters.

**:cgssnsn=** (obsolete)

CgPA subsystem number GTT set name.

**NOTE: This parameter is obsolete, use the optsn parameter.**

**Range:** **ayyyyyyyy**

1 leading alphabetic character and up to 8 following alphanumeric characters.

**:selid=** (obsolete)

Selector ID.

**NOTE:** This parameter is obsolete, use the **cgselid** parameter for CgPA selectors and the **cdselid** parameter for CdPA selectors.

**Range:** 0-65534

### Example

The lines in some examples are wrapped for readability:

```
ent-gta:gttsn=lidb:gta=9195554321:xlat=dpc:ri=gt:pc=001-255-253
```

```
ent-gta:gttsn=t800:gta=919460:xlat=dpc:ri=gt:pc=001-255-252
```

```
ent-
```

```
gta:gttsn=t800:gta=919461:egta=919468:xlat=dpc:ssn:ri=ssn:pc=001-255-252:ssn=254
```

```
ent-
```

```
gta:gttsn=setint000:gta=391951212000000:egta=391951212399999:xlat=dpc:ssn:ri=ssn:pci=1-253-1:ssn=255
```

```
ent-
```

```
gta:gttsn=imsi:gta=591975593000000:egta=591975593299999:xlat=dpc:ri=gt:pci=004-167-25:ntt=4
```

```
ent-
```

```
gta:gttsn=test:gta=100000:egta=199999:pca=1-1-1:ntt=123:xlat=dpc:ri=gt:npdd=2:nnp=3:nnai=120
```

```
ent-
```

```
gta:gttsn=test2:gta=123:egta=321:pcn=222:ntt=10:xlat=dpc:ri=gt:npds=999:nnai=100
```

```
ent-
```

```
gta:xlat=dpc:ssn:ri=ssn:pcn24=8-8-8:gttsn=any:gta=919833:ssn=20
```

```
ent-
```

```
gta:xlat=dpc:ssn:ri=ssn:ssn=10:gta=12345678901:egta=23456789012:nnp=14:nnai=3:pcn=s-124:gttsn=setnat003
```

```
ent-
```

```
gta:xlat=dpc:ssn:ri=ssn:ssn=10:gta=12345688901:egta=23456889012:nnp=14:nnai=3:pcn=s-128-aa:gttsn=setnat003
```

```
ent-gta:gta=987666799012345678901:egta=987667321099765432101
```

```
xlat=dpc:ri=gt:pcn=s-124-aa:ntt=234:ccgt=no:
```

```
gttsn=setnat003:nnp=12:nnai=26
```

```
ent-
```

```
gta:xlat=dpc:ssn:ri=ssn:ssn=10:gta=13345688901:egta=24456889012:nnp=14:nnai=3:pci=s-1-230-2:gttsn=itui1
```

```
ent-
```

```
gta:gttsn=tbla:xlat=dpc:ri=gt:pc=1-1-1:gta=1234567700:mrnset=df1t
```

```
ent-
```

```
gta:gttsn=tbla:xlat=dpc:ri=gt:pc=1-1-1:gta=1234567890:egta=2234567890:mrnset=23
```

```
ent-
gta:gttsn=tbla:xlat=dpcngt:ri=gt:pc=1-1-2:gta=2345678901:egta=345
6789012:mrnset=54:ntt=11
```

```
ent-
gta:gttsn=tbla:xlat=dpcngt:ri=gt:pc=1-1-3:gta=3456789012:egta=456
7890123:mrnset=none:ntt=10
```

The following examples require the Flexible GTT Load Sharing feature to be ON.

```
ent-
gta:gttsn=tblx:xlat=dpcssn:ri=ssn:pc=1-1-1:gta=1234567890:egta=22
34567890:ssn=10:mapset=23
```

```
ent-gta:gttsn=tblx:xlat=dpc:ri=ssn:pc=2-2-2:gta=2345678911:egta=
3456789022:mapset=df1t
```

Provisions Advanced CdPA GTA translations.

```
ent-
gta:gttsn=setcdgta:gta=123456789012345678901:egta=223456789012345
678901:
xlat=dpcssn:ri=ssn:pca=001-001-001:ssn=100:optsn=setcggta:opcsn=s
etopc
```

This example provisions GTA translations when FLOBR is turned on.

```
ent-gta:gttsn=setcdgta:gta=1234567890:egta=2234567890:
xlat=dpcssn:ri=ssn:pca=001-001-001:ssn=100:fallback=yes:testmode=
on
```

```
ent-
gta:gttsn=setudts1:gta=423456789012345678901:egta=523456789012345
678901: xlat=udts
```

```
ent-
gta:gttsn=setcggta:gta=323456789012345678901:egta=423456789012345
678901: xlat=dpcssn:ri=ssn:pca=001-001-001:ssn=20:optsn=setcgssn
```

```
ent-
gta:gttsn=cggtadsc:gta=623456789012345678901:egta=623456789012345
678901: xlat=disc
```

```
ent-gta:gttsn=setcgpc:cgpca=001-001-001:xlat=dpcssn:ri=ssn:
pca=001-001-001:ssn=20:optsn=setcgssn
```

```
ent-gta:gttsn=cgpcudt2:cgpca=001-001-009:xlat=udts
```

```
ent-gta:gttsn=setopc:opca=002-001-001:xlat=dpcssn:ri=ssn:
pca=001-001-001:ssn=20:optsn=setcgssn
```

```
ent-gta:gttsn=opcdis3:opca=002-001-001:xlat=disc
```

```
ent-gta:gttsn=setcgssn:cgssn=100:ecgssn=200:xlat=dpcssn:ri=ssn:
pca=001-001-001:ssn=20
```

```
ent-gta:gttsn=cgssnud3:cgssn=100:ecgssn=200:xlat=udts
```

```
ent-
gta:gttsn=setans004:gta=981817:xlat=dpc:pc=1-1-1:ri=gt:cggmod=ye
s
```

```
ent-
gta:gttsn=tblx:xlat=dpcssn:ri=ssn:pc=1-1-1:gta=1234567890:egta=22
34567890:ssn=10:mapset=23:loopset=raleigh1
```

The following example provisions the flexible GTA translations when the FLOBR and OBSR features are turned on.

```
ent-gta:gttsn=setcggta:gta=1234567890:egta=2234567890:
xlat=dpcssn:ri=ssn:pca=001-001-001:ssn=100:fallback=yes:opcsn=set
opcsn
```

```
ent-
gta:gttsn=setopc:opca=2-2-2:xlat=dpcssn:ri=ssn:pca=001-001-002:ss
n=100:optsn=setcGPC:fallback=no
```

```
ent-
gta:gttsn=setcdgta:gta=567565756552:xlat=dpc:ri=gt:pc=1-1-2:optsn
=setcGPC:fallback=no:opcsn=setopc
```

This example provisions GTA translations when the TOBR feature is turned on.

```
ent-
gta:gttsn=setcdssn:gta=3456778899:xlat=dpc:ri=gt:pc=1-1-1:opcsn=s
etopc
```

The following examples provision the GTA translations when the TOBR and OBSR features are turned on.

```
ent-
gta:gttsn=setopcode:pkgtype=qwop:opcode=none:family=*:xlat=dpc:ri
=gt:pc=2-2-2:opcsn=setopc:optsn=setcdgta
```

```
ent-
gta:gttsn=setopcode:pkgtype=bgn:opcode=none:acn=1-2-3-4-5-6-7:sla
t=dpc:ri=gt:pc=2-2-2:opcsn=setopc:optsn=setcdgta
```

## Dependencies

The EGTT feature must be turned on before this command can be entered.

The AMGTT feature must be turned on before the **nnp**, **nnai**, **ngti**, **nsdd**, **nsds**, **npdd**, and **npds** parameters can be specified.

The ANSI-ITU-China SCCP Conversion feature must be enabled and turned on before the **ngti** parameter can be specified.

The ANSI-ITU-China SCCP Conversion feature must be enabled and turned on before a translated PC that is of a different domain than the GTTSN can be specified.

The ANSI-ITU-China SCCP Conversion feature must be on before a translated PC and a translation type in different network types can be specified.

The **gttsn** parameter must be specified and must match an existing **gttsn**.

The **pc/pca/pci/pcn/pcn24** parameter cannot be out of range.

If the **egta** parameter is specified, then the values of the **gta** and **egta** parameters must be the same length.

The length of the specified **gta** parameter must match the number of digits provisioned for the specified GTT set (**gttsn**) when VGTT is OFF. If the VGTT (variable length GTT) feature is turned on, then up to 10 GTA lengths can exist per GTT set. If the Support for 16 GTT Lengths in VGTT feature is turned on, then up to 16 GTA lengths can exist per GTT set.

The specified **gta/egta** range must exist for the specified GTT set in the STP active database. While an exact match is not required, you cannot specify an overlap with another range. If the range overlaps, an error is generated that displays a list of overlapped global title addresses. An example follows that shows what happens when the user attempts to enter a global title address range (such as 8005550000

to 800555999) that overlaps an existing range. The overlapping links must match. If they do not, the error message displays the list of overlapped global title addresses:

```
The following GTA ranges overlap the input GTA range
START GTA          END GTA
8005550000         8005551999
8005552000         8005553999
8005554000         8005555999
ENT-GTA: MASP A - Command Aborted
```

The new translation type (**ntt** parameter) must match that of an existing ANSI GTT selector that is assigned to a GTT set (**gttsn** parameter).

The new translation type (**ntt** parameter) cannot already be defined as an alias.

If the ANSI-ITU-China SCCP Conversion feature is on, and the **ntt** parameter is specified, then the **ri=gt** parameter must be specified.

If the ANSI-ITU-China SCCP Conversion feature is on, then the **ntt** parameter can be specified only when the **xlat** parameter value is **dpc** or **dpcngt**.

The **ngti** parameter can be specified only when the translated point code and the translation type are in different domains, or are both in the ITU domain.

The **nsdd** and **nsds** parameters cannot be used in the same command with the **npdd** and **npds** parameters.

If the **ngti=4** parameter is specified, then the **nnp** and **nnai** parameters must be specified.

If the **ngti=4** parameter is specified, then the translated PC cannot be ANSI. For ANSI PCs, the GTI value must be **2**.

If the **ngti=2** parameter is specified, then the **nnp** and **nnai** parameters cannot be specified.

The **ccgt** and **ngti** parameters cannot be specified together in the command.

If the ANSI-ITU-China SCCP Conversion feature is not on and the specified GTT set is an ANSI set, then the **pc/pca** parameter must be a valid ANSI point code.

When the ANSI-ITU-China SCCP Conversion feature is not on and the specified GTT set is an ITU set, the **pci/pcn/pcn24** parameter must be a valid ITU point code.

If the **xlat=dpcngt** parameter is specified, then the **ri=gt** parameter must be specified.

If the **xlat=dpcngt** parameter is specified, then the **ntt** parameter must be specified.

If the **ntt** parameter is specified, then the **xlat=dpcngt** parameter must be specified.

If the **ssn** parameter is specified, then the **xlat=dpcssn** parameter must be specified.

If the **xlat=dpcssn** parameter is specified, then the **ssn** parameter must be specified.

If the value specified for the **pc/pca/pci/pcn/pcn24** parameter is the STP's true point code, the **xlat=dpcssn** and **ri=ssn** parameters must be specified.

If the value specified for the **pc/pca/pci/pcn/pcn24** parameter is the STP's true point code and the **ssn** parameter is specified, the **ssn** parameter must exist in the SS-APPL table.

Unless the PC is the STP true PC, the value specified for the **pc/pca/pci/pcn/pcn24** parameter must exist as a destination in the Route table or reside in a cluster that exists as a destination in the Route table (for global routing).

If a final GTT (the **ri=ssn** parameter) is specified with the **xlat=dpc** parameter and without the **force=yes** parameter, then the PC (**pc/pca/pci/pcn/pcn24**) must exist in the Remote Point Code/ MAP table. The **force=yes** parameter can be specified to execute the command when the PC is not in the table; the following warning message is displayed in the scroll area of the terminal:

```
CAUTION: DPC DOES NOT EXIST IN MATED APPLICATION TABLE.
```

If the **ccgt=yes** parameter is specified, then the **ri=ssn** parameter must be specified.



If the **pc/pca/pci/pcn/pcn24** parameter is any of the STP's PCs or CPCs, then the **ccgt=no** parameter must be specified.

If the XGTT feature is enabled, the GTT table can contain up to either 400,000 or 1,000,000 entries, depending on the controlled feature Part Number that is enabled. If XGTT is not enabled, the GTT table can contain up to 269,999 user entries. An error message is displayed if a command entry would result in more than the allowed maximum number of entries in the table.

If the **egta** parameter is specified, then the value of the **egta** parameter must be greater than or equal to the value of the **gta** parameter.

The GTT Set Name must not be **none**.

The **pc/pca/pci/pcn/pcn24** parameter must be a full PC.

If the VGTT feature is turned on, then up to 10 GTA lengths can exist per GTT set. If the Support for 16 GTT Lengths in VGTT feature is turned on, then up to 16 GTA lengths can exist per GTT set.

If the **ri=ssn** parameter is specified, then the **mrnset** parameter must not be specified.

If the Flexible GTT Load Sharing feature is enabled, then the specified PC must already exist in the specified MRN set.

The specified MRN set must already exist in the MRN table.

The **mrnset** parameter can only be specified when the Flexible GTT Load-Sharing feature is enabled.

If the **ri=gt** parameter is specified, then the **mrnset** parameter must be specified.

The **mapset** parameter can only be specified if the Flexible GTT Load Sharing feature is enabled, and the **ri=ssn** parameter is specified. If the **ri=ssn** parameter is specified, the **mapset** parameter must be specified. If the **ri=gt** parameter is specified, the **mapset** parameter cannot be specified.

The Flexible GTT Load Sharing feature must be enabled before the **mapset** parameter can be specified.

The specified PC and SSN must exist in the specified MAP set.

The specified MAP set must exist in the database.

If the **xlat=dpc** parameter is specified, and the **force** parameter is not specified as **yes**, then the specified PC and MAP set must exist in the MAP table.

The **gta**, **cgpc/cgpca/cgpci/cgpcn/cgpcn24**, **opc/opca/opci/opcn/opcn24**, **cgssn/cdssn**, **opcode/acn/pkgtype**, or **opcode/family/pkgtype** parameter must be specified.

The **cdselid**, **cgselid**, and **optsn** parameters cannot be specified together in the command. If the GTT set has a set type of **cdgta**, **cdssn**, or **opcode**, then the **opcsn** parameter can be specified with one of the above parameters.

If the **cgssn** parameter is specified, then the **optsn** and **cgselid** parameters cannot be specified.

The value specified for the **ecgssn** or **ecdssn** parameter must be greater than the value specified for the **cgssn** or **cdssn** parameter.

If the **xlat** parameter has a value of **udts** or **disc**, then the only other optional parameters that can be specified are the **gta/egta**, **cgpc**, **opc**, **cgssn/ecgssn**, **cdssn/ecdssn**, **opcode/pkgtype/family**, or **opcode/pkgtype/acn** parameters.

If the **xlat** parameter has a value of **dpc**, **dpcngt**, or **dpcssn**, then the **pc/pca/pci/pcn/pcn24** and **ri** parameters must be specified.

The OBSR feature must be enabled before the **opcsn**, **cgpc/cgpca/cgpci/cgpcn/cgpcn24**, **opc/opca/opci/opcn/opcn24**, or **(e)cgssn** parameters can be specified, or before a value of **udts** or **discard** can be specified for the **xlat** parameter.

If the GTT set specified by the **gttsn** parameter (GTTSN set) has a set type of **cdgta** (see the **ent-gttset** command), then the **optsn** parameter cannot specify a GTT set (OPTSN set) with a set type of **cgssn**. If the GTTSN set has a set type of **cdgta**, then the OPTSN set must have a set type

of **cggta** or **cgpc**. The FLOBR feature must be turned on before a GTTSN set with a set type of **cgpc**, **cggta**, or **opc** can be specified with an OPTSN with a set type other than **cgssn**. If the FLOBR feature is turned on, and the GTTSN set has a set type of **cdgta**, then the OPTSN set cannot have a set type of **opc**. If the TOBR feature is turned on, and the GTTSN set has a set type of **cdgta**, **cdssn**, or **opcode**, then the OPTSN set cannot have a set type of **opc**.

The GTA must be specified if the GTTSN set type has a value of **cdgta** or **cggta**. The GTA cannot be specified for other set types.

If the GTTSN set type has a value of **cgpc**, the **cgpc/cgpcac/cgpci/cgpcn/cgpcn24** parameter must be specified. This parameter cannot be specified for other set types.

The **opc**, **opca**, **opci**, **opcn**, or **opcn24** parameter must be specified if the GTTSN set type has a value of **opc**. These parameters cannot be specified for other set types.

If the GTTSN set type has a value of **cgssn**, the **cgssn** parameter must be specified. The **cgssn** parameter cannot be specified for GTTSN of other types.

The range specified by the **cdssn/ecdssn** and **cgssn/ecgssn** parameters cannot overlap a currently existing range for the specified GTT set.

The GTT set name specified by the **opcsn** parameter must have a set type of **opc** (see the **ent-gttset** command).

If the specified GTT set is an ANSI set, the **cgpc/cgpcac** and **opc/opca** parameters must be valid ANSI point codes. If the specified GTT set is an ITU set, the **cgpci/cgpcn/cgpcn24** and the **opci/opcn/opcn24** parameters must be valid ITU point codes.

The OPC subsystem number set domain must be the same as the GTTSN set domain. If the GTT subsystem number set domain is ANSI, then the OPC subsystem number set domain must be ANSI. If the GTT subsystem number set domain is ITU, then the OPC subsystem number set domain must be ITU.

The translation entry specified by the **cgpc**, **opcode** or **opc** parameters cannot already exist.

The **cgpc**, **cgssn**, **gta**, **opc**, **cdssn**, and **opcode** parameters cannot be specified together in the command.

The Hex Digit Support for GTT feature must be enabled and on before hexadecimal digits can be specified for the **gta**, **egta**, **npds**, or **nsds** parameters.

The value of the **loopset** parameter must already exist in the database.

The SCCP Loop Detection feature must be enabled before the **loopset** parameter can be specified.

The value specified for the **pc** parameter cannot be associated with a proxy point code.

The AMGTT feature or the AMGTT CgPA Upgrade feature must be turned on before the **cggtmod** parameter can be specified.

The FLOBR feature must be turned on before the **fallback**, **testmode**, or **cdselid** parameters can be specified.

The FLOBR feature must be turned on before the **gttsn** parameter can specify a GTT set with a set type other than **cdgta** (see the **ent-gttset** command) in the same command with the **cgselid** parameter.

The OBSR feature must be enabled or the FLOBR feature must be turned on before the **cgselid** parameter can be specified.

The SCCP Conversion feature must be enabled before the GTT set specified by the **optsn** parameter can have a different domain than the GTT set specified by the **gttsn** parameter.

A TOBR quantity feature must be turned on before the **opcode**, **pkgtype**, **acn**, or **family** parameter can be specified.

The **opcode**, **pkgtype**, and **family** parameters must be specified together for ANSI TCAP translations. The **opcode**, **pkgtype**, and **acn** parameters must be specified together for ITU TCAP translations.

If the GTT set specified by the **gttsn** parameter has a set type of **opcode** (see the **ent-gttset** command), then the **opcode/acn/pkgtype** or **opcode/family/pkgtype** parameter must be specified. These parameters cannot be specified for GTT sets of any other set types.

The TOBR feature must be turned on before the **cdssn** and **edcssn** parameters can be specified.

If the GTT set specified by the **gttsn** parameter has a set type of **cdssn** (see the **ent-gttset** command), then the **cdssn** parameter must be specified. This parameter cannot be specified for GTT sets with other set types.

The maximum number of OPCODE translation entries cannot exceed the value that is set by the associated TOBR quantity feature.

The GTT set specified by the **gttsn** parameter must have a set type of **cdgta**, **opcode**, or **cdssn** (see the **ent-gttset** command) before the **opcsn** parameter can be specified.

The GTT set specified by the **gttsn** parameter cannot have the same set type (see the **ent-gttset** command) as the GTT set specified by the **optsn** parameter.

The SCCP conversion feature must be enabled and the FLOBR feature must be turned on before the **cgcnvsn** parameter can be specified.

The GTT set specified by the **gttsn** parameter must have a set type of **cdgta** or **cggta** (see the **ent-gttset** command) before the **cgcnvsn** parameter can be specified.

If the **cgssn** parameter is specified, then the **edcssn** and **egta** parameters cannot be specified. If the **cdssn** parameter is specified, then the **ecgssn** and **egta** parameters cannot be specified. The **acn** and **family** parameters cannot be specified together in the command. If the **opcode** parameter is specified, then the **egta**, **edcssn**, and **ecgssn** parameters cannot be specified.

The GTT set specified by the **gttsn** parameter cannot be the same as the GTT set specified by the **cgcnvsn** parameter.

If the **family** parameter is specified, then a value of **ansiuni**, **qwp**, **qwop**, **resp**, **cwp**, **cwop**, **ansiabort**, or **any** must be specified for the **pkgtype** parameter.

If the **acn** parameter is specified, then a value of **bgn**, **ituabort**, **ituuni**, **any**, **end**, or **ent** must be specified for the **pkgtype** parameter.

The GTT set specified by the **optsn**, **opcsn**, and **cgcnvsn** parameters must match an existing GTT set.

If the **pkgtype=ituabort**, then a value of **none** must be specified for the **acn** and **opcode** parameters. If the **pkgtype=ansiabort** is specified then a value of **none** must be specified for the **family** and **opcode** parameters.

If the **family** and **opcode** parameters are specified in the command, then either both parameters must have a value of **none** or neither parameter can have a value of **none**.

One or more point codes in the command will exceed the maximum number of entries in the MAP table.

The OBSR feature must be enabled or the TOBR feature must be turned on before the **optsn** parameter can be specified.

## Notes

When the EGTT feature is turned on, the GTT Selector (**ent/chg/dlt/rtrv-gttset**), GTT Set (**ent/dlt/rtrv-gttset**), and GTA (**ent/chg/dlt/rtrv-gta**) commands replace the Translation Type (**ent/dlt/rtrv-tt**) and Global Title Translation (**ent/chg/dlt/rtrv-gtt**) commands. All data previously provisioned with these commands is maintained.

In this command, only ITU-international and ITU national point codes support the spare point code subtype prefix (**s-**) and the private and spare point code subtype prefix (**ps-**). All of the point code types support the private (internal) point code subtype prefix (**p-**).

When the Flexible GTT Load Sharing feature and the Intermediate GTT Load Sharing feature are on, multiple relationships can be defined among set of destination point codes in the MRN table, which already exists in the EAGLE 5 ISS. The relationship used in a particular translation is based on the GTA digits used for translation. The MRN set and the post-translation PC create a key that is used to perform lookups in the MRN table. The lookup results in a set of alternate PCs, one of which is selected, based on PC relative cost, to route the MSU in the most cost effective way.

When the Flexible GTT Load Sharing feature is enabled, multiple relationships can be defined among a set of PC/SSNs in the existing MAP table. The relationship used in a particular translation is based on the GTA digits used for translation.

When the Origin-based SCCP Routing feature is turned on, the CdPA GTA, CgPA GTA, CgPA PC, CgPA SSN, and OPC entries can be provisioned. When provisioning, the following rules apply:

- The Advanced CdPA GTA entry can associate with CgPA GTA set, CgPA PC set, or SELID and OPC set.
- The CgPA GTA, CgPA PC, or OPC entry can associate with the CgPA SSN set.
- The CgPA SSN entry cannot associate with any other GTT set.
- The Advanced CdPA GTA entry may contain SELID, which is (together with the CgPA information) derived from incoming MSU to search the Selector table again for the CgPA GTA or CgPA PC Set.

When the Origin-based SCCP Routing feature is enabled, the GTA and EGTA can be used for the CgPA translation as well as the CdPA GTA translation.

A loopset consists of a set of point codes that form a routing loop in the network. If the SCCP Loop Detection feature is enabled, then the loopset can be associated with or disassociated from specified translation entries. Loopsets that are associated with translation entries are checked during intermediate and final GTT traffic routing. If a loop exists, then the system can be notified with or without discarding the associated traffic.

The maximum length of the resulting GTA string must not exceed 21 digits when translation is complete.

If the FLOBR GTT hierarchy is provisioned on a linkset, then translations do not have to be searched in a predetermined manner (a specific translation can only point to specific GTTSETs, and CgPA SSN translation is the terminating point). If a translation points to another GTTSET/SELID, then database searches continue. The number of searches is limited by the following conditions:

- Same GTT set type can't be referred more than once.
- Number of database searches is limited to 7.

If the FLOBR feature is turned on, then any translation can point to any GTTSETs that do not have the same GTT set type. The CdPA GTA translations can also point to an OPC GTTSET. For CdPA GTA translations, if a GTTSET/SELID is provisioned apart from an OPC GTTSET, then the GTTSET/SELID takes precedence over the OPC GTTSET.

The TOBR feature introduces 2 new type of translations.

1. TOBR CdPA SSN Translations—CdPA SSN translations can be provisioned with routing and flexible routing data. The provisioning rules for CdPA SSN translations are the same as the CgPA SSN translations in OBSR.
2. TOBR Opcode Translations—Opcode translations support ANSI or ITU opcodes.
  - ANSI Opcode—ANSI opcode specifier, ANSI TCAP Package Type, and Family

- ITU Opcode—ITU opcode, ITU TCAP Package Type and ACN

## Output

This example provisions GTA translation when TOBR is turned on.

```
ent-
gta:gttsn=setcdssn:gta=12345678901:xlat=dpcssn:ri=ssn:pca=001-
001-001:ssn=100:opcsn=setopc
    tekelecstp 09-03-24 12:09:18 EST EAGLE 41.0.0
    ENT-GTA: MASP A - COMPLTD
;
```

## ent-gtcnv

### Enter Global Title Conversion

Use this command to provision the Default Global Title Conversion table. The table is used during conversion for MTP-routed cross network SCCP UDT, UDTS and SCCP Management messages. It is also used during conversion for GT routed messages when a matching entry exists in the Global Title address table but the NGTI value is not provisioned.

**Keyword:** ent-gtcnv

**Related Commands:** chg-gtcnv, dlt-gtcnv, rtrv-gtcnv

**Command Class:** Database Administration

## Parameters

**:dir=** (mandatory)

Direction of conversion.

**Range:** **atoi, itoa, both**

**atoi**— ANSI to ITU conversion

**itoa**— ITU to ANSI conversion

**both**— conversion in both directions

**:gtixlat=** (mandatory)

Global Title Indicator conversion. This parameter is expressed in the form of the ANSI GTI and the ITU GTI.

**Range:** **22, 24**

**22**— Converts an incoming ANSI GTI 2 to an outgoing ITU GTI 2 or an incoming ITU GTI 2 to an outgoing ANSI GTI 2

**24**— Converts an incoming ANSI GTI 2 to an outgoing ITU GTI 4 or an incoming ITU GTI 4 to an outgoing ANSI GTI 2

**:tta=** (mandatory)

ANSI translation type.

**Range:** **0-255 \***

**:tti=** (mandatory)

ITU translation type.

**Range:** **0-255 \***

**:nai=** (optional)

Nature of address indicator. This parameter is mandatory when **gtixlat=24** is specified, and not specified when **gtixlat=22** is specified.

**Range:** **0-63 \***

**Default:** Not set

**:np=** (optional)

Numbering plan. This parameter is mandatory when **gtixlat=24** is specified, and not specified when **gtixlat=22** is specified.

**Range:** 0-15 \*

**Default:** Not set

**:npdd=** (optional)

New prefix digits to be deleted. This parameter specifies the number of new prefix digits to be deleted. These digits will be replaced with the new prefix digits string (**npds**).

**Range:** 0-21

**Default:** 0

**:npds=** (optional)

New prefix digits string. This parameter specifies the new prefix digits string that will replace the received prefix digits string.

**Range:** 1-21 digits

If the Hex Digit Support for GTT feature is not enabled and on, the range is 1 - 21 decimal digits; valid digits are **0-9**.

If the Hex Digit Support for GTT feature is enabled and on, the range is 1 - 21 hexadecimal digits; valid digits are **0-9, a-f, A-F**.

**Default:** No digits

**:nsdd=** (optional)

New suffix digits to be deleted. This parameter identifies the new suffix digits to be deleted that will replace the received suffix digits to be deleted.

**Range:** 0-21

**Default:** 0

**:nsds=** (optional)

New suffix digits string. This parameter specifies the new suffix digits string that will replace the received suffix digits string.

**Range:** 1-21 digits

If the Hex Digit Support for GTT feature is not enabled and on, the range is 1 - 21 decimal digits; valid digits are **0-9**.

If the Hex Digit Support for GTT feature is enabled and on, the range is 1 - 21 hexadecimal digits; valid digits are **0-9, a-f, A-F**.

**Default:** No digits

**Example**

The following example assigns an entry used for ANSI to ITU conversion where the conversion is from GTI 2 to GTI 2.

```
ent-gtcnv:dir=atoi:gtixlat=22:tta=10:tti=5
```

The following example assigns an entry used for ANSI to ITU conversion where the conversion is from GTI 2 to GTI 4. The nsdd parameter specifies that the last 3 digits are to be removed from the end of the address digits, and the nsds parameter specifies that the digits 123 are to be appended to the end of the remaining address digits.

```
ent-
```

```
gtcnv:dir=atoi:gtixlat=24:tta=11:tti=7:nai=8:np=6:nsdd=3:nsds=123
```

The following example assigns an entry used for ITU to ANSI conversion where the conversion is from GTI 2 to GTI 2. The npdd parameter specifies that the first 3 digits are to be deleted from the beginning of the address digits, and the npds parameter specifies that the digits 407 should be appended to the beginning of the remaining address digits.

```
ent-gtcnv:dir=itoe:gtixlat=22:tta=11:tti=7:npdd=3:npds=407
```

The following example assigns an entry used for ITU to ANSI conversion where the conversion is from GTI 2 to GTI 4. The nsds Parameter specifies that the digits 45667 are to be appended to the end of the address digits.

```
ent-gtcnv:dir=itoe:gtixlat=24:tta=11:tti=7:nai=8:np=6:nsds=45667
```

The following example assigns an entry used for ANSI/ITU conversion in both directions where the conversion is from GTI 2 to GTI 2.

```
ent-gtcnv:dir=both:gtixlat=22:tta=11:tti=7
```

The following example assigns an entry used for ANSI/ITU conversion where an incoming ANSI GTI 2 is converted to an outgoing ITU GTI 4 or an incoming ITU GTI 4 to an outgoing ANSI GTI 2.

```
ent-gtcnv:dir=both:gtixlat=24:tta=12:tti=9:nai=6:np=4
```

The following example assigns a default entry for ANSI to ITU conversion where the conversion is from GTI 2 to GTI 2.

```
ent-gtcnv:dir=atoi:gtixlat=24:tta=*:tti=4:nai=6:np=5
```

The following example assigns a default entry for ITU to ANSI where the conversion is from GTI 2 to GTI 4. The npds parameter specifies that the digits 919 are to be appended to the beginning of the address digits.

```
ent-gtcnv:dir=itoe:gtixlat=24:tta=17:tti=*:nai=*:np=*:npds=919
```

The following example specifies hexadecimal digits for the npds parameter.

```
ent-  
gtcnv:dir=atoi:gtixlat=22:tta=*:tti=4:npdd=3:npds=abcdef012345678  
9
```

## Dependencies

The ANSI-ITU-China SCCP Conversion feature must be turned on before this command can be entered.

If **gtixlat=22** is specified, the **nai** and **np** parameters cannot be specified.

If **gtixlat=24** is specified, the **nai** and **np** parameters must be specified.

When **dir=both** is specified, no asterisk (\*) parameter values can be specified.

When **dir=atoi** is specified, the asterisk parameter value (\*) can be specified only for the **tta** parameter.

When **dir=itoe** is specified, the asterisk parameter value (\*) must be specified for the **tti**, **np**, and **nai** parameters.

The specified **dir**, **tta**, **tti**, **np**, and **nai** parameter combination cannot already exist in the database.

The **nsdd** and **nsds** parameters cannot be used in the same command with the **npdd** and **npds** parameters.

The Default Global Title Conversion table can contain a maximum of 1000 entries.

The Hex Digit Support for GTT feature must be enabled and on before hexadecimal digits can be specified for the **npds** and **nsds** parameters.

## Notes

The use of asterisks (wildcards) is allowed only once for each direction of ANSI to ITU and ITU to ANSI. This provides a configurable default.

In the conversion direction of ANSI to ITU, an asterisk can be specified only for the ANSI **tta** parameter.

In the conversion direction of ITU to ANSI, the asterisk value must be specified for the **itu tti**, **np**, and **nai** parameters.

Asterisks are not allowed when conversion is in both directions (**dir=both**).

The suffix digit manipulation parameters **nsdd** and **nsds** cannot be specified in the same command with the prefix digit manipulation parameters **npdd** and **npds** parameters. The **npdd** and **nsdd** parameters specify how many digits to delete, if any, from the beginning or end respectively of the Global Title address digits. The **npds** and **nsds** parameters specify what digits, if any, to append to the beginning or end respectively of the Global Title address digits.

The **gtixlat** parameter is expressed in the form of the ANSI GTI and the ITU GTI. The **gtixlat** parameter is used to indicate the conversion of the Global Title Indicator between the ANSI and ITU standards. For example: A **gtixlat** value of **24** converts an incoming ANSI GTI 2 to an outgoing ITU GTI 4 or an incoming ITU GTI 4 to an outgoing ANSI GTI 2.

### Output

```
ent-gtcnv:dir=atoi:gtixlat=22:tta=10:tti=5
rlghncxa03w 04-01-07 11:43:07 EST EAGLE 31.3.0
ENT-GTCNV: MASP A - COMPLTD
;
```

## ent-gtt

### Enter Global Title Translation

Use this command to add the routing object, DPC, and subsystem number for messages requiring global title translation. The translation is performed on the basis of the global title address (GTA) and translation type (TT) for each SS7 SCCP message directed to the STP's self-identity DPC or CPC with a routing indicator of 0, indicating a GTT is required.

If the EGTT (Enhanced Global Title Translation) feature is turned on in the system, the system will no longer accept **-gtt** (Global Title Translation) and **-tt** (Translation Type) commands. Refer to the new command sets that replace the **-gtt** and **-tt** commands:

- GTT Selector commands (**ent/chg/dlt/rtrv-gttsel**)
- GTT Set commands (**ent/dlt/rtrv-gttset**)
- GTA commands (**ent/chg/dlt/rtrv-gta**).

See the "Notes" section of this command description for functions provided when various controlled features are turned on.

**Keyword:** **ent-gtt**

**Related Commands:** **chg-gtt, dlt-gtt, rtrv-gtt**

**Command Class:** Database Administration

### Parameters

At least one of these parameters must be specified: **ttn, type/typea/typei/typen/typen24**.

**NOTE:** See **"Point Code Formats and Conversion"** for a detailed description of point code formats, rules for specification, and examples.

**:gta=** (mandatory)

Global title address. This parameter specifies the beginning of a range of global title digits.

**Range:** 1-21 digits

If the Hex Digit Support for GTT feature is not enabled and on, the range is 1 - 21 decimal digits; valid digits are **0-9**.



If the Hex Digit Support for GTT feature is enabled and on, the range is 1 - 21 hexadecimal digits; valid digits are **0-9, a-f, A-F**.

**:pc=** (mandatory)

ANSI point code with subfields *network indicator-network cluster-network cluster member (ni-nc-ncm)*. The *prefix* subfield indicates a private point code (*prefix-ni-nc-ncm*).

**Synonym: pca**

**Range: p-, 000-255**

Specify a valid value for each subfield of the point code, and separate the subfields with a dash (-).

*prefix*—**p-**

When **chg-sid:pctype=ansi** is specified, *ni = 000* is not valid.

When **chg-sid:pctype=ansi** is specified, *nc = 000* is not valid if *ni = 001-005*.

When **chg-sid:pctype=ansi** is specified, *nc = 000* is valid if *ni = 006-255*.

The point code **000-000-000** is not a valid point code.

**:pc/pca/pci/pcn/pcn24=** (mandatory)

Point code.

**:pci=** (mandatory)

ITU international point code with subfields *zone-area-id*. The *prefix* subfield indicates a spare point code, private point code, or private and spare point code (*prefix-zone-area-id*).

**Range: s-, p-, ps-, 0-255**

Specify a valid value for each subfield of the point code, and separate the subfields with a dash (-).

*prefix*—**s-, p-, ps-**

*zone*—**0-7**

*area*—**000-255**

*id*—**0-7**

The point code **0-000-0** is not a valid point code.

**:pcn=** (mandatory)

ITU national point code in the format of a 5-digit number (*nnnnn*); or 2, 3, or 4 numbers (members) separated by dashes (*m1-m2-m3-m4*) as defined by the **chg-stpopts:npcfmti** flexible point code option. A group code must be specified when the ITUDUPPC feature is turned on (*nnnnn-gc, m1-m2-m3-m4-gc*). The *prefix* subfield indicates a spare point code, private point code, or private and spare point code (*prefix-nnnnn, prefix-nnnnn-gc, prefix-m1-m2-m3-m4, prefix-m1-m2-m3-m4-gc*).

**Range: s-, p-, ps-, 0-16383, aa-zz**

Specify a valid value for each subfield of the point code, and separate the subfields with a dash (-).

*prefix*—**s-, p-, ps-**

*nnnnn*—**0-16383**

*gc*—**aa-zz**

*m1-m2-m3-m4*—**0-14** for each member; values must sum to 14

**:pcn24=** (mandatory)

24-bit ITU national point code with subfields *main signaling area-sub signaling area-signaling point (msa-ssa-sp)*. The *prefix* subfield indicates a private point code (*prefix-ni-nc-ncm*).

**Range: p-, 000-255**

Specify a valid value for each subfield of the point code, and separate the subfields with a dash (-).

*prefix*—**p-**  
*msa*—**000–255**  
*ssa*—**000–255**  
*sp*—**000–255**

**:ri=** (mandatory)

Route indicator. This parameter specifies whether a subsequent global title translation is required.

**Range:** **gt, ssn**  
**gt**— Subsequent translation is required.  
**ssn**— Subsequent translation is not required.

**:xlat=** (mandatory)

Translate indicator. This parameter specifies the type of global title translation to be performed.

**Range:** **dpc, dpcssn, dpcngt**

**:cggtmod=** (optional)

Calling party GT modification indicator. This parameter specifies whether calling party global title modification is required.

**Range:** **yes, no**  
**Default:** **no**

**:egta=** (optional)

Global title end address. This parameter specifies the end of a range of global title digits.

**Range:** 1-21 digits  
If the Hex Digit Support for GTT feature is not enabled and on, the range is 1 - 21 decimal digits; valid digits are **0-9**.  
If the Hex Digit Support for GTT feature is enabled and on, the range is 1 - 21 hexadecimal digits; valid digits are **0-9, a-f, A-F**.  
**Default:** **egta** same as **gta**

**:force=** (optional)

When a final GTT is specified, the DPC and subsystem number must be configured in the mated application table (**xlat=dpc** and **ri=ssn**). The **force=yes** parameter allows you to override this restriction.

**Range:** **yes, no**  
**Default:** **no**

**:loopset=** (optional)

SCCP loopset name. This parameter associates a translation set with a loopset.

**Range:** *ayyyyyyy*, **none**  
1 alphabetic character followed by up to 7 alphanumeric characters.  
**none**—There is no association between the translation set and any loopset.  
**Default:** **none**

**:mapset=** (optional)

MAP set ID.

**Range:** **1-36000 dflt**  
**dflt**—Default MAP set

**:mrnset=** (optional)

MRN set ID.

**Range:** **1-3000 none, dflt**  
**dflt**—Default MRN Set ID  
**none**—Removes the specified MRN Set ID from the MRN table

**:ngt=** (optional)

New global title. This parameter specifies the type of global title translation that will replace the received global title.

If the **xlat=dpngt** parameter is specified, the **ngt** parameter must be specified. If the **xlat=dpngt** parameter is not specified, the **ngt** parameter cannot be specified.

**Range:** 000-255

**:ngti=** (optional)

New global title indicator code. When the ANSI-ITU-China SCCP Conversion and AMGTT features are ON and the Translated Point Code is of a different network type, the **ngti** parameter specifies whether the new GTI translation format is GTI type 2 or GTI type 4.

**Range:** 2, 4

**:nnai=** (optional)

New nature of address indicator. This parameter specifies the nature of address indicator that will replace the received nature of address indicator.

**Range:** 0-127

**Default:** 0xFFFF

**:nnp=** (optional)

New numbering plan. This parameter specifies the numbering plan that will replace the received numbering plan.

**Range:** 0-15

**Default:** 0xFFFF

**:npdd=** (optional)

New prefix digits to be deleted. This parameter specifies the new prefix digits to be deleted that will replace the received prefix digits to be deleted.

**Range:** 0-21

**Default:** 0

**:npds=** (optional)

New prefix digits string. This parameter specifies the new prefix digits that will replace the received prefix digits string

**Range:** 1-21 digits

If the Hex Digit Support for GTT feature is not enabled and on, the range is 1 - 21 decimal digits; valid digits are **0-9**.

If the Hex Digit Support for GTT feature is enabled and on, the range is 1 - 21 hexadecimal digits; valid digits are **0-9, a-f, A-F**.

**Default:** No digits

**:nsdd=** (optional)

New suffix digits to be deleted. This parameter specifies the new suffix digits to be deleted that will replace the received suffix digits to be deleted.

**Range:** 0-21

**Default:** 0

**:nsds=** (optional)

New suffix digits string. This parameter specifies the new suffix digits string that will replace the received suffix digits string.

**Range:** 1-21 digits

If the Hex Digit Support for GTT feature is not enabled and on, the range is 1 - 21 decimal digits; valid digits are **0-9**.

If the Hex Digit Support for GTT feature is enabled and on, the range is 1 - 21 hexadecimal digits; valid digits are **0-9, a-f, A-F**.

**Default:** No digits

**:ssn=** (optional)

Subsystem number. This parameter specifies the subsystem address that will receive the message. If the **xlat=dpcssn** parameter is specified, the **ssn** parameter must be specified. If the **xlat=dpcssn** parameter is not specified, the **ssn** parameter cannot be specified.

**Range:** 002-255

**:ttn=** (optional)

Translation type name. The name is of local significance only, and is related to the translation type.

**Range:** ayyyyyyy

1 alphabetic character followed by up to 7 alphanumeric characters

**Default:** No translation name is given

**:type/typea/typei/typen/typen24=** (optional)

Translation type identifies the translation type and network type. This parameter is the decimal representation of the 1-byte field used in SS7.

The **type** and **typea** parameters specify an ANSI network.

The **typei** parameter specifies an ITU-international network.

The **typen** parameter specifies an ITU-national network.

The **typen24** parameter specifies a 24-bit ITU-national network.

A translation type numeric value may be entered as ANSI type (**type** or **typea**) and also as an ITU type (**typei** or **typen**). However, they are separate entities.

The point code domain translation types for GTT are handled by the EAGLE 5 ISS protocol processing as either ANSI or ITU; therefore, ITU applies to ITU-I, ITU-I Spare, ITU-N, and ITU-N Spare. ITU-I includes ITU-I Spare, and ITU-N includes ITU-N Spare.

**Range:** 000-255

**Default:** No translation type is specified

## Example

The lines in the following examples are wrapped for readability:

ent-

```
gtt:type=3:gta=9195551212:egta=9195552000:xlat=dpcssn:ri=ssn:pc=0
01-255-255:ssn=255
```

ent-

```
gtt:ttn=lidb1:gta=9105551212:egta=9105554000:xlat=dpcngt:ri=gt:pc=
=001-255-254:ngt=4
```

```
ent-gtt:ttn=c800:gta=9195554321:xlat=dpc:ri=gt:pc=001-255-253
```

```
ent-gtt:type=4:gta=919460:xlat=dpc:ri=ssn:pc=001-255-252
```

```
ent-gtt:type=4:gta=919461:xlat=dpcssn:ri=gt:ssn=254
```

ent-

```
gtt:typea=210:ttn=test:gta=100000:egta=199999:pca=1-1-1:ngt=123:x
lat=dpcngt:ri=gt:npdd=2:nnp=3:nnai=120
```

ent-

```
gtt:type=100:ttn=test2:gta=123:egta=321:pcn=222:ngt=10:xlat=dpcng
t:ri=gt:npds=999:nnai=100
```

ent-

```
gtt:pcn24=8-8-8:gta=919833:xlat=dpcssn:ri=ssn:ssn=20:typen24=4
```

```

ent-
gtt:typea=100:ttn=test2:gta=123:egta=321:pci=2-2-2:ngt=10:xlat=dp
cngt:ri=gt :nsdd=3:nsds=567:nnai=62:nnp=4:ngti=4
ent-gtt:xlat=dpcssn:ssn=10:ri=gt:pci=s-1-21-1:gta=123456:typei=3
ent-gtt:xlat=dpcssn:ssn=10:ri=gt:pcn=s-124:gta=123456:typen=3
ent-gtt:xlat=dpcssn:ssn=10:ri=gt:pcn=s-125-aa:gta=123456:typen=3

ent-
gtt:type=1:xlat=dpc:ri=gt:pc=1-1-1:gta=1234567890:egta=2234567890
:mrnset=23

ent-gtt:type=1:xlat=dpcngt:ri=gt:pc=1-1-2:
gta=2345678901:egta=3456789012:mrnset=54:ngt=10

ent-gtt:type=1:xlat=dpcngt:ri=gt:pc=1-1-3:
gta=3456789013:egta=3456789019:mrnset=df1t:ngt=10

ent-gtt:type=1:xlat=dpcngt:ri=gt:pc=1-1-3:
gta=3456789012:egta=4567890123:mrnset=none:ngt=10

ent-
gtt:type=1:xlat=dpcssn:ri=ssn:pc=1-1-1:gta=1234567890:egta=223456
7890:ssn=10:mapset=23

ent-
gtt:type=1:xlat=dpcssn:ri=ssn:pc=2-2-2:gta=2345678911:egta=345678
9022:ssn=25:mapset=df1t

```

The following example specifies hexadecimal digits for the gta, egta, and npds parameters.

```

ent-
gtt:ttt=set1:xlat=dpcssn:ri=ssn:ssn=10:pc=1-1-1:gta=abcd:egta=abc
e:npds=fab

```

The following example specifies that calling party GT modification is required.

```

ent-gtt:xlat=dpc:pc=1-1-1:ri=gt:gta=981234:type=4:cggmod=yes

```

## Dependencies

The EGTT feature must be turned on before this command can be entered.

The end address must be greater than or equal to the start address.

The **pcn** parameter format must match the format that was assigned with the **chg-stpopts:npcfmti** parameter.

If the **xlat=dpcngt** parameter is specified, the **ngt** parameter must be specified. If the **xlat** parameter value is not **dpcngt**, the **ngt** parameter cannot be specified.

Point code entries must be full point codes. Partial point codes are not allowed.

The start global title address length must be equal to the number of digits specified by the given translation type. If the VGTT (variable length GTT) feature is turned on, then up to 10 GTA lengths per translation type can be provisioned. When the **ent-gtt** command is entered to create entries, the software keeps track of the lengths and allows only 10 different lengths. The global title address specified for the translation type must then have the same number of digits as an existing GTA.

If the end global title address is specified, its length must equal the length of the start global title address.

The maximum length of the resulting GTA string must not exceed 21 digits when translation is complete.

The AMGTT feature must be on before the **nnp**, **nnai**, **nsdd**, **nsds**, **npdd**, and **npds** parameters can be specified.

If the **npdd** and **npds** parameters are specified, the **nsdd** and **nsds** parameters cannot be specified.

If the translation type is specified, then it must already exist and cannot be an alias.

If the translation type is ANSI (the **type** or **typea** parameter), the **pc** parameter type must be ANSI (the **pc** or **pca** parameter). If the translation type is an ITU type (the **typei**, **typen**, or **typen24** parameter), the **pc** parameter type must be an ITU type (the **pci**, **pcn**, or **pcn24** parameter).

The ANSI-ITU-China SCCP Conversion feature must be on before a translated point code and a translation type in different network types can be specified.

The **ngti** parameter can be specified only when the translated PC and the translation type are in different domains, or are both in the ITU domain.

If the **ngti=4** parameter is specified, the **nnp** and **nnai** parameters must be specified.

If the **ngti=4** parameter is specified, the translated PC cannot be ANSI. For ANSI PCs, the GTI value must be **2**.

If the **ngti=2** parameter is specified, the **nnp** and **nnai** parameters cannot be specified.

The range, as specified by the start and end global title addresses, cannot exist in the global title translation data for the specified translation type. Each range may be contained completely within a previously defined range, in which case splitting is performed. However, if the ranges overlap, splitting cannot occur, the command is rejected, and a list of overlapped global title addresses is displayed. An example follows that shows what happens when the user attempts to enter a global title address range (such as 8005550000 to 8005559999) that overlaps an existing range. The overlapping links must match. If they do not, error message E2401 is generated displaying the list of overlapped global title addresses:

```
The following GTA ranges overlap the input GTA range
START GTA          END GTA
8005550000         8005551999
8005552000         8005553999
8005554000         8005555999
ENT-GTT: MASP A - Command Aborted
```

If a final GTT is specified with the **ri=ssn** parameter and the **xlat=dpc** parameter, and if the value of the **force** parameter is not **yes**, the point code must be configured in the Remote Point Code/MAP Table.

The **xlat=dpcssn** parameter must be specified before the **ssn** parameter can be specified.

If the **xlat=dpcssn** parameter is specified, then the **ssn** parameter must be specified.

If the ANSI-ITU-China SCCP Conversion feature is not on, and the **xlat=dpcngt** parameter is specified, then a value for the **ngt** parameter must be specified, and the **ri=gt** parameter must be specified. If the value for the **xlat** parameter parameter is not **dpcngt**, then a value for the **ngt** parameter cannot be specified.

If the ANSI-ITU-China SCCP Conversion feature is turned on, and the **ngt** parameter is specified, then the **ri=gt** parameter must be specified.

If the ANSI-ITU-China SCCP Conversion feature is not on, the **ngt** parameter can be specified only if the **xlat=dpcngt** parameter is specified.

If the ANSI-ITU-China SCCP Conversion feature is turned on, the **ngt** parameter can be specified only if the **xlat=dpc** or the **xlat=dpcngt** parameter is specified.

Table 5-48 shows the valid combinations for the **xlat**, **ri**, **ssn**, and **ngt** parameters. All other combinations are rejected.

**Table 5-48.** Valid **ent-gtt** Routing Parameter Combinations

| <b>XLAT Value</b> | <b>RI Value</b> | <b>Routing Action</b>                                                             | <b>SSN Value</b> | <b>NGT Value</b>                                                |
|-------------------|-----------------|-----------------------------------------------------------------------------------|------------------|-----------------------------------------------------------------|
| DPC               | GT              | Translate <b>DPC</b> only and route on <b>GT</b>                                  | Cannot specify   | Cannot specify unless ANSI-ITU-China SCCP Conversion is enabled |
| DPC               | SSN             | Translate <b>DPC</b> only and route on <b>SSN</b>                                 | Cannot specify   | Cannot specify                                                  |
| DPCSSN            | GT              | Translate <b>DPC</b> and <b>SSN</b> and route on <b>GT</b>                        | Must specify     | Cannot specify                                                  |
| DPCSSN            | SSN             | Translate <b>DPC</b> and <b>SSN</b> and route on <b>SSN</b>                       | Must specify     | Cannot specify                                                  |
| DPCNGT            | GT              | Translate <b>DPC</b> , new translation type ( <b>TT</b> ), and route on <b>GT</b> | Cannot specify   | Must specify                                                    |

If the **ri=ssn** parameter is specified, the **mrnset** parameter cannot be specified.

If the Flexible GTT Load Sharing feature is enabled, the specified PC must already exist in the specified MRN set.

The specified MRN set must already exist in the MRN table.

The Flexible GTT Load Sharing feature must be enabled before the **mrnset** parameter can be specified.

If the **ri=gt** parameter is specified, then the **mrnset** parameter must be specified.

If the **ri=gt** parameter is specified, the **mapset** parameter cannot be specified.

The Flexible GTT Load Sharing feature must be enabled before the **mapset** parameter can be specified.

The **mapset** parameter can only be specified if the Flexible GTT Load Sharing feature is enabled, and the **ri=ssn** parameter is specified. If the **ri=ssn** parameter is specified, the **mapset** parameter must be specified. If the **ri=gt** parameter is specified, the **mapset** parameter cannot be specified.

The specified PC and SSN must exist in the specified MAP set.

At least one entry must be provisioned in the specified MAP set in the MAP table.

If the **xlat=dpc** parameter is specified, and the **force** parameter is not specified as **yes**, the specified PC and MAP set must exist in the MAP table.

The Hex Digit Support for GTT feature must be enabled and on before hexadecimal digits can be specified for the **gta**, **egta**, **npds** and **nsds** parameters.

The SCCP Loop Detection feature must be enabled before the **loopset** parameter can be specified.

The value of the **loopset** parameter must already exist in the database.

The **tt** or the **ttn** parameter must be specified.

The value of the **pc/pca/pci/pcn/pcn24** parameter must be a valid ANSI point code.

The SCCP Loop Detection feature must be enabled before the **loopset** parameter can be specified.

The value of the **loopset** parameter must exist in the Loopset table.

If the value of the **pc/pca/pci/pcn/pcn24** parameter is the True Point Code, then the **xlat=dpcssn** parameter and the **ri=ssn** parameter must be specified.

If the **ssn** parameter is specified, and if the value of the **pc/pca/pci/pcn/pcn24** parameter is the True Point Code, then the value of the **ssn** parameter must exist in the SS-APPL table.

The value of the **pc/pca/pci/pcn/pcn24** parameter must exist as a destination in the ordered route entity set or must reside in a cluster (ANSI only) that exists as a destination in the ordered route entity set (for global title routing).

If the VGTT feature is turned on, then up to 10 GTA lengths can exist per translation type. If the Support for 16 GTT Lengths in VGTT feature is turned on, then up to 16 GTA lengths can exist per translation type.

The value of the **tt** parameter must not be defined as an alias.

If both the translation type (**tt**) and translation type name (**ttn**) are specified, the translation type name (**ttn**) must match that of the specified translation type (**tt**).

If an International Translation Type (**TYPEI**) is specified, the Translation Type (**tt**) must exist in the STP's active database.

If a national Translation Type (**TYPEN**) is specified, the Translation Type (**tt**) must exist in the STP's active database.

If the **tt** parameter is not specified, then the value of the **ttn** parameter must match the value of a **tt** parameter in the STP database.

If the **xlat=dpcngt** parameter is specified, then the **ngtt** parameter must be specified.

If the **xlat=dpcngt** parameter is specified, then the **ri=gt** parameter must be specified.

The GTT table cannot be full.

The value specified for the **pc** parameter cannot be associated with a proxy point code.

The AMGTT feature or the AMGTT CgPA Upgrade feature must be turned on before the **cggtmod** parameter can be specified.

One or more point codes in the command will exceed the maximum number of entries in the MAP table.

## Notes

The routing indicator provides routing instructions to the receiving signaling point. If the routing indicator specifies global title, global title translation then needs to be performed at another signaling point.

Up to 200,00 entries are allowed for an individual translation type if all SCCP cards are TSM cards or DSM cards.

The ANSI point code **0-0-0** and the ITU-I point code **0-000-0** are not valid point codes.

The EAGLE 5 ISS does not require a MAP table entry to be configured prior to provisioning a GTT entry. The EAGLE 5 ISS assumes that the GTT entry is for a solitary point code/subsystem and automatically creates a MAP entry for the point code/subsystem.

The suffix digit manipulation parameters **nsdd** and **nsds** are available only with the AMGTT feature on. The **nsdd** and **nsds** suffix digit manipulation parameters cannot be specified together with the **npdd** and **npds** prefix digit manipulations parameters in the command.

In this command, only ITU-international and ITU national point codes support the spare point code subtype prefix (**s-**) and the private and spare point code subtype prefix (**ps-**). All of the point code types support the private (internal) point code subtype prefix (**p-**).

When the Flexible GTT Load Sharing feature and the Intermediate GTT Load Sharing feature are on, multiple relationships can be defined among a set of destination point codes in the MRN table



that exists in the EAGLE 5 ISS. The relationship used in a particular translation is based on the GTA digits used for translation. The MRN set and the post-translation PC creates a key that is used to perform lookups in the MRN table. The lookup results in a set of alternate PCs, one of which is selected, based on the PCs relative cost, to route the MSU in the most cost-effective way.

When the FFGTTLS feature is turned on, multiple relationships can be defined among set of PC/SSNs in the existing MAP table. The relationship used in a particular translation is based on the GTA digits used for translation.

With the ANSI-ITU-China SCCP Conversion feature turned on, the Translated Point Code (**pc**, **pca**, **pci**, **pcn**, and **pcn24** parameters) can be of a different network type than the Translation Type (**type** parameter).

When the ANSI-ITU-China SCCP Conversion and AMGTT features are ON and the Translated Point Code is of a different network type, the **ngti** parameter specifies whether the new GTI translation format is GTI type 2 or GTI type 4.

If the AMGTT feature is turned off, then the **ngti** parameter cannot be specified, and the Default GT Conversion Table is used for conversion. If the ANSI-ITU-China SCCP Conversion feature is turned off, then mixed network types are not allowed.

A loopset consists of a set of point codes that form a routing loop in the network. If the SCCP Loop Detection feature is enabled, then the loopset can be associated with or disassociated from specified translation entries. Loopsets that are associated with translation entries are checked during intermediate and final GTT traffic routing. If a loop exists, then the system can be notified with or without discarding the associated traffic.

## Output

```
ent-gtt:xlat=dpc:pc=12-1-11:ri=gt:gta=981234:type=4:cggmod=yes
tekelecstp 08-02-24 12:06:11 EST EAGLE 38.0.0
ENT-GTT: MASP A - COMPLTD
;
```

## ent-gttsel

### Enter GTT Selectors

Use this command to assign applicable global title selectors to a GTT set for enhanced global title translations.

**Keyword:** ent-gttsel

**Related Commands:** chg-gttsel, dlt-gttsel, rtrv-gttsel

**Command Class:** Database Administration

## Parameters

**NOTE:** The Flexible Linkset Optional Based Routing (FLOBR) feature must be turned on before the cdgttsn, cggtsn, eaglegen, and lsn parameter can be specified.

**NOTE:** The Origin-based SCCP Routing (OBSR) feature must be enabled before the cdgtasn, cggtsn, cgpcsn, or cgssn parameter can be specified. If the FLOBR feature is turned on, then the cdgtasn, cggtsn, and cgpcsn parameters cannot be specified.

**NOTE:** The OBSR feature must be enabled or the FLOBR feature must be turned on before the selid parameter can be specified.

**NOTE:** If the OBSR feature is enabled, or the FLOBR feature is turned on, then the gttsn parameter cannot be specified.

**:gti/gtia/gtii/gtin/gtin24=** (mandatory)

Global title indicator. For all EGTT selector commands, the domain is defined as **gti** and **gtia** (ANSI), **gtii** (ITU international), **gtin** (ITU national), and **gtin24** (24-bit ITU national).

For the selector commands, **gti** and **gtia** are equivalent; **gtii** and **gtin/gtin24** are mutually exclusive because the EGTT database does not distinguish between ITU national and ITU international

translations. This means that while ITU-I and ITU-N selectors are stored separately, two separate ITU-I and ITU-N entries with the same selector values cannot exist. For example, if an entry with **gtii=2** and **tt=4** already exists, an entry of **gtin=2** and **tt=4** cannot be entered.

**Range:** 2, 4  
Supported value for ANSI: **gti=2** and **gtia=2**  
Supported values for ITU: **gtii=2, 4** and **gtin/gtin24=2, 4**

**:tt=** (mandatory)

Translation type.

**Range:** 0-255

**:cdgtasn=** (optional)

CdPA GTA GTT set name.

**Range:** ayyyyyyyy  
1 leading alphabetic and up to 8 following alphanumeric characters.

**:cdgttsn=** (optional)

CdPA GTT set name.

**Range:** ayyyyyyyy  
1 leading alphabetic and up to 8 following alphanumeric characters.

**:cggtasn=** (optional)

CgPA GTA GTT set name.

**Range:** ayyyyyyyy  
1 leading alphabetic and up to 8 following alphanumeric characters.

**:cggttsn=** (optional)

CgPA GTT set name.

**Range:** ayyyyyyyy  
1 leading alphabetic and up to 8 following alphanumeric characters.

**:cgpcsn=** (optional)

CgPA PC GTT set name.

**Range:** ayyyyyyyy  
1 leading alphabetic and up to 8 following alphanumeric characters.

**:cgssn=** (optional)

CgPA subsystem number.

**Range:** 0-255

**:eaglegen=** (optional)

This parameter specifies whether the selector is used by EAGLE 5 ISS generated messages.

**Range:** yes  
yes — Indicates selector used only by Eagle generated MSU.

**:gttsn=** (optional)

GTT set name. A GTT set is an entity to which global title addresses and selectors are assigned.

**Range:** ayyyyyyyy  
1 leading alphabetic and up to 8 following alphanumeric characters.

**:lsn=** (optional)

Linkset name.

**Range:** ayyyyyyyy  
1 alphabetic character followed by up to 9 alphanumeric characters

**:nai=** (optional)

Nature of address indicator. The nature of address indicator can be specified by a mnemonic value (**nai** parameter) or an explicit numeric value (**naiv** parameter). Either the **nai** parameter or the **naiv** parameter, but not both, can be specified. Table A-5 shows the mapping between the **naiv** and the **nai** parameter values.

**Range:** **sub, rsvd, natl, intl**

**:naiv=** (optional)

Nature of address indicator value. The nature of address indicator can be specified by a mnemonic value (**nai** parameter) or an explicit numeric value (**naiv** parameter). Either the **nai** parameter or the **naiv** parameter, but not both, can be specified. Table A-5 shows the mapping between the **naiv** and the **nai** parameter values.

**Range:** **0-127**

**:np=** (optional)

Numbering plan. The numbering plan can be specified by a mnemonic value (**np** parameter) or an explicit numeric value (**npv** parameter). Either the **np** parameter or the **npv** parameter, but not both, can be specified. Table A-6 shows the mapping between the **npv** and the **np** parameter values.

**Range:** **e164, generic, x121, f69, e210, e212, e214, private**

**:npv=** (optional)

Numbering plan value. The numbering plan can be specified by a mnemonic value (**np** parameter) or an explicit numeric value (**npv** parameter). Either the **np** parameter or the **npv** parameter, but not both, can be specified. Table A-6 shows the mapping between the **npv** and the **np** parameter values.

**Range:** **0-15**

**:selid=** (optional)

Selector ID.

**Range:** **0-65534**

### Example

```
ent-gtttsel:gtia=2:tt=9:cdgttsn=lidb:lsn=ls0010
ent-gtttsel:gtia=2:tt=10:gttsn=t800
ent-gtttsel:gtia=2:tt=253:gttsn=setans253
ent-gtttsel:gtii=4:tt=0:np=e164:nai=intl:gttsn=setint000
ent-gtttsel:gtii=2:tt=0:gttsn=setint000
ent-gtttsel:gtin=4:tt=9:np=e214:nai=natl:gttsn=imsi
ent-gtttsel:gtii=4:tt=0:np=e164:nai=sub:gttsn=setint000

ent-
gttsel:gtia=2:tt=20:cdgtasn=setcdgta:cggtasn=setcggta:cgssn=10:selid=0

ent-
gttsel:gtia=2:tt=21:cggttsn=setcgpc:cdgttsn=setcdgta:cgssn=20:selid=1:lsn=ls10

ent-gtttsel:gtii=2:tt=40:cdgtasn=setcdgta:cgpcsn=setcgpc:cgssn=12
ent-gtttsel:gtii=2:tt=41:cgpcsn=setcgpc:cgssn=255:selid=65534
ent-gtttsel:gtin=4:tt=60:npv=5:naiv=5:cdgtasn=setcdgta
ent-gtttsel:gtin=4:tt=60:npv=5:naiv=6:cgpcsn=setcgpc:cgssn=112
ent-gtttsel:gtia=2:tt=9:cdgttsn=lidb:eaglegen=yes
```

## Dependencies

The EGTT feature must be turned on before this command can be entered.

The **np** and **npv** parameters cannot be specified in the same command.

The **nai** and **naiv** parameters cannot be specified in the same command.

The **gtia=4**, **gti/gtia/gtii/gtin/gtin24=1**, and **gti/gtia/gtii/gtin/gtin24=3** parameters cannot be specified.

If the **gti/gtia/gtii/gtin/gtin24=2** parameter is specified, the **np/npv** and **nai/naiv** parameter combinations cannot be specified.

If the **gtii/gtin/gtin24=4** parameter is specified, an **np(v)** and **nai(v)** parameter combination must be specified. These parameters can be specified in any combination: **np** and **naiv**, **npv** and **nai**, **np** and **nai**, or **npv** and **naiv**.

For existing TTs with **gtii/gtin/gtin24=4**, the domain of the new entry must match the existing domain.

A value of **none** cannot be specified for the **gttsn**, **cdgtasn**, **cggtasn**, **cgpcsn**, **cdgttsn**, and **cggttsn** parameters.

At least one GTT set name parameter must be specified. These parameters include:

- **cdgtasn**, **cggtasn** or **cgpcsn** if the OBR feature is enabled
- **cdgttsn** or **cggttsn** if the FLOBR feature is turned on
- **gttsn** if the OBR feature is not enabled and the FLOBR feature is not turned on

The OBR feature must be enabled before the **cggtasn**, **cgpcsn**, **cgssn**, or **cdgtasn** parameters can be specified.

The SSNSELID Table cannot contain more than 100,000 entries.

The linkset specified by the **lsn** parameter must already exist.

The FLOBR feature must be turned on before the **lsn**, **eaglegen**, **cdgttsn** and **cggttsn** parameters can be specified.

The OBR or FLOBR feature must be turned on before the **selid** parameter can be specified.

If the FLOBR feature is turned on, then the **cdgtasn**, **cggtasn**, and **cgpcsn** parameters cannot be specified.

The value specified for the **cdgtasn** or **gttsn** parameter must match the name of an existing GTT set.

The GTT set specified by the **cdgtasn** or **gttsn** parameter must have a set type of **cdgta** (see the **ent-gttset** command).

An entry cannot already exist that matches the **eaglegen**, **gti**, **tt**, and **np(v)** and **nai(v)** parameter combination for the specified CdPA and/or CgPA selector.

The GTT set specified by the **gttsn**, **cdgtasn**, or **cdgttsn** parameter must already exist in the GTT Set table.

The network domain of the specified GTT selector must match the domain of the GTT set that is specified by the **gttsn**, **cdgtasn**, or **cdgttsn** parameter, unless the domain of the GTT set has a value of **cross**.

The GTT set specified by the **cggttsn**, **cggtasn** or **cgpcsn** parameter must already exist in the GTT Set table.

The network domain of the GTT set that is specified by the **cggttsn**, **cggtasn**, or **cgpcsn** parameter must match the domain specified by the **gti(x)** parameter.

The set type of the GTT set specified by the **cggtasn** or **cgpcsn** parameter must match the set type of the corresponding entry in the GTT Set table.

The GTT Set specified by the **cdgttsn**, **cdgtasn** or **gttsn** parameter must have a set type of **cdgta** (see the **ent-gttset** command).

The **gttsn** parameter cannot be specified if the OBSR feature is enabled or the FLOBR feature is turned on.

The GTTDBMM Table cannot contain more than 42,502 entries.

The domain specified by the **gti(x)** parameter must match the domain of the linkset specified by the **lsn** parameter.

If the **gti(x)=4** parameter is specified, then the GTT selector table cannot have more than 5 **nai** entries per **tt/np** combination.

The **cggtasn**, **cgpcsn**, and **cggttsn** parameters cannot be specified together in the command.

The **gttsn**, **cdgtasn**, and **cdgttsn** parameters cannot be specified together in the command.

If the **gttsn**, **cdgttsn**, or **cdgtasn** parameter is specified, then the **cgssn** parameter cannot be specified. If the **cggtasn**, **cgpcsn** or **cggttsn** parameter is specified, then the **cgssn** parameter must be specified.

If the **gttsn** or **cdgtasn** parameter is specified, then the **selid** parameter cannot be specified.

If the **cdgttsn** or **cggttsn** parameter is specified, then the **lsn** parameter must be specified.

If the **eaglegen=yes** parameter is specified, then the **lsn**, **selid**, **gttsn**, **cdgtasn**, **cgssn**, **cggttsn**, **cggtasn**, and **cgpcsn** parameters cannot be specified.

## Notes

When the EGTT feature is turned on, the GTT Selector (**ent/chg/dlt/rtrv-gttset**), GTT Set (**ent/dlt/rtrv-gttset**), and GTA (**ent/chg/dlt/rtrv-gta**) commands replace the Translation Type (**ent/dlt/rtrv-tt**) and Global Title Translation (**ent/chg/dlt/rtrv-gtt**) commands. All data previously provisioned with these commands is maintained.

For **gtii/gtin=4**, although DFLT may appear in the **rtrv-gttset** output, **dflt** cannot be specified as value for the **np** or **nai** parameters when the **ent-gttset** command is entered. If a new GTT selector is specified that matches an existing GTT selector's **gti** and **tt** and the existing selector has **dflt** as the value for the **np** and/or **nai** parameters, a new entry is created with the new **np** and **nai** parameter values. The existing GTT selector entry with the **dflt** value is also retained. The **np/nai** parameter value **dflt** can be specified for the **chg/dlt/rtrv-gttset** commands.

The Origin-based SCCP Routing feature allows two GTT sets to be assigned to a GTT selector: **cdgtasn** and **cggtasn** or **cdgtasn** and **cgpcsn**. The **cggtasn** and **cgpcsn** GTT sets are mutually exclusive and cannot be assigned to the same GTT selector.

## Output

```
ent-gttset:gtia=2:tt=9:gttsn=lidb
  rlgncxa03w 04-02-18 08:50:27 EST EAGLE 31.3.0
  ENT-GTTSEL: MASP A - CMLPTD
;
```

## ent-gttset

### Enter GTT Set

Use this command to specify the attributes of a new GTT set (a set of global title translations). A GTT set consists of a GTT set name, the number of digits allocated for the GTA (global title address), the domain of the point codes used in the translation, and a pointer to a GTA tree. After the GTT set is provisioned, you can enter subsequent GTT Selector commands and GTA commands.

**Keyword:** ent-gttset  
**Related Commands:** chg-gttset, dlt-gttset, rtrv-gttset  
**Command Class:** Database Administration

### Parameters

- :gttsn=** (mandatory)  
 GTT set name. A GTT set is an entity to which global title addresses and selectors are assigned.  
**Range:** *ayyyyyyyy*  
 1 leading alphabetic character and up to 8 following alphanumeric characters.
- :netdom=** (mandatory)  
 Network domain. This command does not distinguish between ITU national or ITU international because the Enhanced Global Title Translation (EGTT) feature does not discriminate between the ITU-I and ITU-N translations.  
 The **netdom** parameter refers to the incoming message network domain.  
**Range:** **ansi, itu, cross**
- :ndgt=** (optional)  
 Number of digits. This parameter specifies the number of digits required for GTAs associated with this GTT set. This parameter is not valid if the VGTT feature is turned on or if the **settype** parameter has a value of **cgpc, cgssn, opc, cdssn** or **opcode**.  
**Range:** **1-21**  
**Default:** **6**
- :settype=** (optional)  
 GTT set type.  
**NOTE: This parameter is mandatory if the Origin-based SCCP Routing (OBSR) feature is enabled or the TCAP Opcode Based Routing (TOBR) feature is turned on.**  
**Range:** **cdgta, cggtta, cgpc, cgssn, opc, cdssn, opcode**

### Example

```
ent-gttset:gttsn=lidb:ndgt=10:netdom=ansient-
gttset:gttsn=t800:netdom=ansi
ent-gttset:gttsn=setint000:netdom=itu:ndgt=15
ent-gttset:gttsn=setcdgt:netdom=cross:ndgt=10:settype=cdgta
ent-gttset:gttsn=setcggg:netdom=ansi:ndgt=11:settype=cggta
ent-gttset:gttsn=setxyz:netdom=ansi:ndgt=11:settype=cggta
ent-gttset:gttsn=setopc:netdom=itu:settype=opc
ent-gttset:gttsn=setcgpc:netdom=ansi:settype=cgpc
ent-gttset:gttsn=setssn:netdom=ansi:settype=cgssn
ent-gttset:gttsn=setopcode:settype=opcode
ent-gttset:gttsn=setcdssn:netdom=ansi:settype=cdssn
```

### Dependencies

- The EGTT feature must be turned on before this command can be entered.
- The GTT Set table cannot contain more than 2000 entries.
- The **gttsn=none** parameter cannot be specified.
- If the VGTT (Variable Length GTT) feature is turned on, the **ndgt** parameter cannot be specified.
- The **gttsn** parameter must be specified and must not match an existing **gttsn**.

The **ndgt** parameter cannot be specified if the **settype** parameter has a value of **cgssn**, **opc**, **cgpc**, **cdssn** or **opcode**.

The **netdom=cross** parameter can be specified only if the **settype=cdgta** parameter is specified.

The Origin-based SCCP Routing feature must be turned on if the value of the **settype** parameter is **cggta**, **cgssn**, **opc**, or **cgpc**.

If the OBSR feature is enabled or the TOBR feature is turned on, then the **settype** parameter must be specified.

The ANSI-ITU-China SCCP Conversion feature must be enabled before the **netdom=cross** parameter can be specified.

The TOBR feature must be turned on before a value of **cdssn** or **opcode** can be specified for the **settype** parameter.

The OBSR feature must be enabled or the TOBR feature must be turned on before the **settype** parameter can be specified.

## Notes

When the EGTT feature is turned on, the GTT Selector (**ent/chg/dlt/rtrv-gttset**), GTT Set (**ent/dlt/rtrv-gttset**), and GTA (**ent/chg/dlt/rtrv-gta**) commands replace the Translation Type (**ent/dlt/rtrv-tt**) and Global Title Translation (**ent/chg/dlt/rtrv-gtt**) commands. All data previously provisioned with these commands is maintained.

When the Origin-based SCCP Routing feature is turned on, VGTT is supported only for CdPA GTA and CgPA GTA. The **cross** network domain is supported only for CdPA GTA.

## Output

```
ent-gttset:gttsn=setcdssn:netdom=ansi:settype=cdssn
tekelecstp 09-08-12 18:28:54 EST EAGLE 41.1.0
Command entered at terminal #4.
ENT-GTTSET: MASP A - COMPLTD

GTT-SET table is (3 of 2000) 1% full.
```

;

## ent-gws-redirect

### Enter Gateway Screening Redirect Command

Use this command to provision the gateway screening redirect function. The Redirect table must be provisioned before configuring gateway screening to redirect received MSUs. The values that are specified with this command are stored in the Redirect table, and they are used to set the variable fields of the MSUs being redirected. For example, if the **ri=gt** parameter is specified, the value **gt** is set for the routing indicator in the called party address (CDPA) of the MSU being redirected.

**Keyword:** ent-gws-redirect

**Related Commands:** chg-gws-redirect, dlt-gws-redirect,

**Command Class:** Database Administration

## Parameters

**NOTE:** See "Point Code Formats and Conversion" for a detailed description of point code formats, rules for specification, and examples.

**:dpc=** (mandatory)

Specifies the value used to set the ANSI destination point code field in the routing label of the MSU that is being redirected. The ANSI point code has subfields *network indicator-network cluster-network cluster member (ni-nc-ncm)*.

**Synonym:** dpca

**Range: 000-255**

Specify a valid value for each subfield of the point code, and separate the subfields with a dash (-).

When **chg-sid:pctype=ansi** is specified, *ni* = **000** is not valid.

When **chg-sid:pctype=ansi** is specified, *nc* = **000** is not valid if *ni* = **001-005**.

When **chg-sid:pctype=ansi** is specified, *nc* = **000** is valid if *ni* = **006-255**.

The point code **000-000-000** is not a valid point code.

**:dpc/dpca/dpci/dpcn/dpcn24=** (mandatory)

Destination point code.

**:dpci=** (mandatory)

Specifies the value used to set the ITU international destination point code field in the routing label of the MSU that is being redirected. The point code has subfields *zone-area-id*.

**Range: 0-255**

Specify a valid value for each subfield of the point code, and separate the subfields with a dash (-).

The point code **0-000-0** is not a valid point code.

*zone*—**0-7**

*area*—**000-255**

*id*—**0-7**

**:dpcn=** (mandatory)

Specifies the value used to set the ITU national destination point code field in the routing label of the MSU that is being redirected. The point code is in the format of a 5-digit number (*nnnnn*); or 2, 3, or 4 numbers (members) separated by dashes (*m1-m2-m3-m4*) when the **chg-stpopts:npfnti** flexible point code option is on. A group code (*gc*) must be specified when the ITUDUPPC feature is on (*nnnnn-gc*, *m1-m2-m3-m4-gc*).

**Range: 0-16383, aa-zz**

Specify a valid value for each subfield of the point code, and separate the subfields with a dash (-).

*nnnnn*—**0-16383**

*gc*—**aa-zz**

*m1-m2-m3-m4*—**0-14** for each member; values must sum to 14

**:dpcn24=** (mandatory)

Specifies the value used to set the 24-bit ITU national destination point code field in the routing label of the MSU that is being redirected. The point code has subfields *main signaling area-sub signaling area-signaling point* (*msa-ssa-sp*).

**Range: 000-255**

Specify a valid value for each subfield of the point code, and separate the subfields with a dash (-).

*msa*—**000-255**

*ssa*—**000-255**

*sp*—**000-255**

**:gta=** (mandatory)

Specifies the value used to set the global title address (dialed digits) in the SCCP called party address of the MSU being redirected.



**Range:** 1-21 digits

**:ri=** (mandatory)

Specifies the value used to set the routing indicator in the SCCP called party address of the MSU being redirected. Use the **gt** value to route by global title digits or use the **ssn** value to route by subsystem number.

**Range:** **gt, ssn**

**:ssn=** (mandatory)

Specifies the value used to set the subsystem number (SSN) in the SCCP called party address of the MSU being redirected. This number is the SSN of the SCP to which all MSUs meeting the redirect criteria are to be redirected.

**Range:** **000-255**

**:tt=** (mandatory)

Identifies the type of the global title translation (GTT). This value is the decimal representation of the 1-byte field used in SS7 and is used to set the type of the GTT in the SCCP called party address of the MSU being redirected.

**Range:** **000-255**

**:enabled=** (optional)

Specifies whether MSUs that have passed gateway screening are to be redirected (**enabled=on**) or routed as normal (**enabled=off**).

**Range:** **on, off**

**Default:** **on**

### Example

```
ent-gws-redirect:dpc=1-40-1:ri=gt:ssn=10:tt=1:gta=180833:enabled=on
```

```
ent-gws-redirect:dpc=1-40-1:ri=ssn:ssn=10:tt=1:gta=1800833:enabled=off
```

### Dependencies

The **dpc/dpca/dpci/dpcn/dpcn24** parameter must be defined in the Destination table or defined as the STP site point code.

If the **dpc/dpca/dpci/dpcn/dpcn24** parameter is defined as a destination, it must have at least one route defined.

The redirect function data can be entered only once.

### Notes

The SCCP screening functions (CGPA, TT, CDPA, and AFTPC) cannot select an MSU to be redirected.

Do not apply a Redirect Stop Action on the Adjacent Node point code for the BLKOPC and OPC screening functions.

Do not apply a Redirect Stop Action for an allowed DPC screen rule if the rule contains the self-identity point code of EAGLE 5 ISS where the screening rule is applied. This is because the redirection of SLTAs and SLTMs (Signal Link Test Messages and Acknowledgements) will not return to the originating EAGLE 5 ISS and will cause the link to fail.

If **gwsa=off** and **gwsn=off** are specified for all linksets, gateway screening and the GWS redirect function for the DTA feature are disabled.

**Output**

```
ent-gws-redirect:dpc=1-40-1:ri=gt:ssn=10:tt=1:gta=180833:enabled=
on
  rlghncxa03w 03-11-10 11:43:04 EST  EAGLE 31.6.0
  ENT-GWS-REDIRECT: MASP A - COMPLTD
;
```

**ent-home-smsc****Enter HOME SMSC Address**

Use this command to enter HOME SMSC specific addresses, currently used to identify Short Message Service Centers in the database. This command updates the HOME SMSCADDR table.

**Keyword:** ent-home-smsc

**Related Commands:** dlt-home-smsc, rtrv-home-smsc

**Command Class:** Database Administration

**Parameters**

**:smc=** (mandatory)

Identifies the type of the Short Message Service Center address.

**Range:** 1-21 digits

1-21 hexadecimal digits. Valid digits are **0-9, a-f, A-F**

**Example**

```
ent-home-smsc:smc=256489
```

```
ent-home-smsc:smc=256489a98bccee56ad237
```

**Dependencies**

The Portability Check for Mobile Originated SMS (MNPSMS) feature must be turned on or one of the following features must be enabled before this command can be entered.

- MO SMS IS41-to-GSM Migration
- MO-based GSM SMS NP
- MO-based IS41 SMS NP
- MT-Based GSM SMS NP
- MT-Based IS41 SMS NP

The specified HOME SMSC address cannot already exist in the HOME SMSCADDR table.

The HOME SMSCADDR table can contain a maximum of 500 entries.

**Notes**

None

**Output**

```
ent-home-smsc:smc=256489
  rlghncxa03w 04-02-28 08:50:12 EST  EAGLE 31.3.0
  ENT-HOME-SMSC: MASP A - COMPLTD
;
```

**ent-homern****Enter Home Routing Number Prefix**

Use this command to enter up to 100 routing number prefixes for the operating network into the HOMERN table.



An example IP address is **192.126.100.5**, where **192.126.100** is the system's network number and **5** is the machine's host number.

**Range:** 4 numbers separated by dots, with each number in the range of **0-255**.

**:type=** (optional)

The residency attribute of the host entry.

**Range:** **local, remote**

**local**— The IP host name and IP address resides on the IP card in this EAGLE 5 ISS.

**remote**— The IP host name and IP address resides on equipment not in this EAGLE 5 ISS.

**Default:** **local**

### Example

```
ent-ip-host:host=gw100.nc.tekelec.com:ipaddr=150.001.001.001
ent-ip-
host:host=gw100.nc.tekelec.com:ipaddr=150.001.001.001:type=local
ent-ip-host:host="gw100.nc-tekelec.com":ipaddr=150.001.001.001
```

### Dependencies

The value specified for the **ipaddr** parameter cannot already exist in the IP Host table.

The value specified for the **host** parameter must begin with an alphabetic character and can contain **a..z, A..Z, 0..9, -** (hyphen), or **.** (period). If the host name contains a hyphen, then the host name must be enclosed within quotation marks.

The **ipaddr=0.0.0.0** parameter cannot be specified.

The value specified for the **host** parameter cannot already exist in the IP Host table.

The IP Host table can have a maximum of 2048 host entries.

If a remote host is used (the **type=remote** parameter is specified), then the value specified for the **ipaddr** parameter cannot already exist in the IP Link table.

If a local host is used (the **type=local** parameter is specified), then the value specified for the **ipaddr** parameter must already exist in the IP Link table.

### Notes

None

### Output

```
ent-ip-
host:host=gw100.nc.tekelec.com:ipaddr=150.001.001.001:type=local
  rlgncxa03w 05-07-17 15:35:05 EST EAGLE 34.0.0
  ENT-IP-HOST: MASP A - COMPLTD
;
```

## ent-ip-node

### Enter IP Node

Use this command to define the IP address of a node that will be receiving messages from the STPLAN application.

**Keyword:** **ent-ip-node**

**Related Commands:** **dlt-ip-node, rtrv-ip-node**

**Command Class:** Database Administration

## Parameters

### :cap= (mandatory)

This parameter specifies the maximum percentage of ethernet capacity for the node connection. This capacity is added to other connections to this node for the total capacity of the node.

The value specified for the **cap** parameter can be used to calculate throughput for DCM and E5-ENET cards. Refer to the *Notes* section for more information.

**Range:** 1-100

### :ipaddr= (mandatory)

The node's IP address. This is a TCP/IP address expressed in standard dot notation. IP addresses consist of the system's network number and the machine's unique host number. An example IP address is **192.126.100.5**, where **192.126.100** is the network number and **5** is the machine's host number.

**Range:** 1-223, 0-255

4 numbers separated by dots

**1-223**—first number

**0-255**—the other three numbers

### :ipappl= (mandatory)

The IP application supported by the node.

**Range:** stplan

### :ipport= (mandatory)

The logical IP port that addresses the application on the node.

**Range:** 1024-5000

### :loc= (mandatory)

The card location as stenciled on the shelf of the system that contains the TCP/IP link that will be directly connected to the node.

**Range:** 1101-1108, 1111-1112, 1201-1208, 1211-1218, 1301-1308, 1311-1318, 2101-2108, 2111-2118, 2201-2208, 2211-2218, 2301-2308, 2311-2318, 3101-3108, 3111-3118, 3201-3208, 3211-3218, 3301-3308, 3311-3318, 4101-4108, 4111-4118, 4201-4208, 4211-4218, 4301-4308, 4311-4318, 5101-5108, 5111-5118, 5201-5208, 5211-5218, 5301-5308, 5311-5318, 6101-6108, 6111-6118

### :iprte= (optional)

The default router IP address. This is a TCP/IP address expressed in standard dot notation. IP addresses consist of the system's network number and the machine's unique host number. An example IP address is **192.126.100.5**, where **192.126.100** is the network number and **5** is the machine's host number.

**Range:** 1-223, 0-255

4 numbers separated by dots

**1-223**—first number

**0-255**—the other three numbers

## Example

```
ent-ip-
node:ipaddr=13.49.210.50:ipappl=stplan:ipport=1024:loc=1201:cap=1
5:iprte=193.4.201.84
```

## Dependencies

The ACM is the only valid card type for this command.

The shelf and card must be equipped.

The node IP address cannot be **127.x.x.x**, where **x** is a number from **1** to **254**.

The specified card location must be equipped with a TCP/IP data link.

The IP address must be unique to the TCP/IP link table and to the TCP/IP nodes.

Only one node can be connected for each data link and each application. The IP address, IP application, and card location combination must be unique in the database.

The IP port on each node cannot be assigned to another application. The IP address and IP port combination must always use the same IP application.

The class of the IP address (**ipaddr**) must match the class of the assigned TCP/IP data link's IP address. The system supports three classes of IP addresses, Class A, Class B, and Class C. Class A IP addresses can contain only the values **1** to **126** in the first field of the IP address. Class B IP addresses can contain only the values **128** to **191** in the first field of the IP address. Class C IP addresses can contain only the values **192** to **223** in the first field of the IP address.

The network portion of the IP address (**ipaddr**) must match the network portion of the IP address assigned to the TCP/IP data link. The network portion of the IP address is based on the class of the IP address. If the IP address is a Class A IP address, the first field is the network portion of the IP address. If the IP address is a Class B IP address, the first two fields are the network portion of the IP address. If the IP address is a Class C IP address, the first three fields are the network portion of the IP address.

If the network portion and class of the IP address of the TCP/IP node matches the class of the assigned TCP/IP data link's IP address, the **iprte** parameter cannot be specified. The **iprte** parameter can be specified only with the **ent-ip-node** command when the network portion and class of the TCP/IP node does not match the class of the assigned TCP/IP data link's IP address. The values of the **ipaddr** parameter, the IP address of the TCP/IP node, and the **iprte** parameter cannot be the same.

The capacity of all connections to the given node cannot be greater than 100%.

## Notes

If the IP address is a Class A IP address, do not use the IP addresses **127.x.x.x**, where *x* is a number from **1** to **254**. These addresses are reserved for loopback.

### *Determining the correct CAP value for ECAP*

The STPLAN uses a TVG (grant) rate value, while the ECAP uses an MSUs per second value. These values do not have a 1-to-1 correlation. Therefore, the average number of MSUs per TVG can vary depending on the average MSU size. When calculating the **cap** parameter value, the average number of MSUs per TVG must be factored. The formula for determining the **cap** value is as follows:

$$\text{cap value} = (\text{Host capacity} / (175 \text{ [or } 17.5] * \text{MSU/TVG})).$$



**CAUTION: The 175 multiplier is used only when the link negotiates to 100 Mbits/second full duplex. If the link is a different value than 100 Mbits/second full duplex, then a multiplier of 17.5 is used.**

**NOTE: The cap value is rounded down.**

- **HOST CAPACITY**—capacity of the ECAP server
- **MSU/TVG**—average number of MSUs a single system buffer can transfer to Remote Host

If the MSU/TVG value is not known, then 2 should be used as the MSU/TVG value. If a value of 2 is used, then the network must be monitored to determine if the **cap** value requires adjustment.

*Using the CAP Value to Calculate Throughput for DCM and E5-ENET Cards*

The value specified for the **cap** parameter can be used to calculate the throughput in transactions per second (TPS) for DCM and E5-ENET cards. The TPS value is the smaller of the following values:

- GPL\_CARD\_CAPACITY
  - E5-ENET card—15000
  - DCM card—2870
- 175 [or 17.5] \* **cap** parameter value



**CAUTION: The 175 multiplier is used only when the link negotiates to 100 Mb/s full duplex. If the link is a different value than 100 Mb/s full duplex, then a multiplier of 17.5 is used.**

**Output**

```
ent-ip-
node:ipaddr=13.49.210.50:ipappl=stplan:ipport=1024:loc=1201:cap=1
5:iprte=193.4.201.84
    rlgncxa03w 04-01-18 08:50:12 EST EAGLE 31.3.0
    ENT-IP-NODE: OAM A - COMPLTD
;
```

**ent-ip-rte****Enter IP Route**

Use this command to configure the destination IP address, subnet mask, and the gateway IP address for the specified card in the Static IP Route table.

**Keyword:** ent-ip-rte

**Related Commands:** dlt-ip-rte, rtrv-ip-rte

**Command Class:** Database Administration

**Parameters**

**:dest=** (mandatory)

Destination IP Address. The IP Address of a remote destination host or network to be reached.

**Range:** 4 numbers separated by dots, with each number in the range of 0–255.

The IP address 0.0.0.0 is not valid.

**:gtwy=** (mandatory)

Gateway IP Address. The IP address assigned to the gateway router that will properly forward IP datagrams with the destination IP address (**dest**) to the next-hop gateway router or final destination host.

**Range:** 4 numbers separated by dots, with each number in the range of 0–255.

The IP address 0.0.0.0 is not valid.

**:loc=** (mandatory)

Card location. The unique identifier of a specific IP card in the system.

**Range:** 1101-1108, 1111-1112, 1201-1208, 1211-1218, 1301-1308, 1311-1318, 2101-2108, 2111-2118, 2201-2208, 2211-2218, 2301-2308, 2311-2318, 3101-3108, 3111-3118, 3201-3208, 3211-3218, 3301-3308, 3311-3318, 4101-4108, 4111-4118, 4201-4208, 4211-4218, 4301-4308, 4311-4318, 5101-5108, 5111-5118, 5201-5208, 5211-5218, 5301-5308, 5311-5318, 6101-6108, 6111-6118

**:submask=** (mandatory)

The subnet mask of the destination IP address, in the form of an IP address with a restricted range of values. This parameter is required if the **ipaddr** parameter is entered.

**Range:** The value must be valid for the class of the entered IP address.

**Table 5-49.** Valid Subnet Mask Values

| Valid for Class A Networks | Valid for Class A or B Networks | Valid for Class A, B, or C Networks |
|----------------------------|---------------------------------|-------------------------------------|
| 255.0.0.0                  | 255.255.0.0                     | 255.255.255.0                       |
| 255.192.0.0                | 255.255.192.0                   | 255.255.255.192                     |
| 255.224.0.0                | 255.255.224.0                   | 255.255.255.224                     |
| 255.240.0.0                | 255.255.240.0                   | 255.255.255.240                     |
| 255.248.0.0                | 255.255.248.0                   | 255.255.255.248                     |
| 255.252.0.0                | 255.255.252.0                   | 255.255.255.252                     |
| 255.254.0.0                | 255.255.254.0                   |                                     |
| 255.255.128.0              | 255.255.255.128                 |                                     |

The value **255.255.255.255** must be specified if the destination IP address represents a host address.

If the destination IP address represents a network address, a value must be specified that identifies the network ID and host ID portions of the address.

### Example

```
ent-ip-rte:loc=1301:dest=128.252.10.5:submask=255.255.255.255:
gtwy=140.188.13.33
```

### Dependencies

The specified destination IP address (**dest** parameter):

- Must not be the default route (0.0.0.0)
- Must not correspond to any loopback address (i.e. 127.X.X.X)
- Must be unique per card
- Must not reside on this card's A or B local network

The specified gateway IP address (**gtwy** parameter):

- Must not be the default route (0.0.0.0)
- Must not correspond to any loopback address (i.e. 127.X.X.X)
- Must correspond to a host IP address that resides on this card's A or B local network

The IP address must be defined for the A or B network, or both, for the card before this command can be entered. (See the **chg-ip-card** command.)



Each destination IP address entered into the Static IP Route table must be unique for the card.

A maximum of 64 static IP routes can be defined for a card.

A maximum of 1024 static IP routes can be defined in the IP Route table.

The **loc** parameter value must correspond to a SSED CM card running the **ss7ipgw**, **ipgwi**, **iplim**, or **iplimi** application.

The network address specified by the **dest** and **submask** parameters must be different from the network address specified by the **pvn** and **pvnmask**, **fcna** and **fcnamask**, and **fcnb** and **fcnbmask** parameters of the NETOPTS table.

## Notes

The Static IP Route table is used to store static IP route entries. Static routes are maintained across card initialization, failures, and reloads. These types of routes are used when the IP Layer cannot determine routes dynamically. Static IP route entries can be added or deleted dynamically.

## Output

```
ent-ip-rte:loc=1301:dest=128.252.10.5:submask=255.255.255.255:
gtwy=140.188.13.33
  rlgncxa03w 04-01-17 15:35:05 EST EAGLE 31.3.0
  IP Route table is (1 of 256) 1% full
  ENT-IP-RTE: MASP A - COMPLTD
;
```

## ent-lbp

## Enter Loopback Point

Use this command to assign a far-end loopback point for testing data signaling link elements in a SS7 transmission path.

**Keyword:** **ent-lbp**

**Related Commands:** **act-lbp**, **chg-lbp**, **dact-lbp**, **dlt-lbp**, **rtrv-lbp**

**Command Class:** Database Administration

## Parameters

**:lbp=** (mandatory)

Loopback point ID. This parameter identifies a far-end loopback point that lies along an SS7 signaling link path between the STP and the target device (up to *and including* the target device).

**Range:** **1-32**

**:lfst=** (mandatory)

Link fault sectionalization test. The type of link fault sectionalization loopback test to be performed.

**Range:** **llt**, **nlt**

**llt** — latching loopback test

**nlt** — nonlatching loopback test

**:link=** (mandatory)

SS7 signaling link. The SS7 signaling link that is to be tested.

**Synonym:** **port**

**Range:** **a**, **b**, **a1-a31**, **b1-b31**

Not all card types support all **link** parameter values.

See Table A-1 for valid **link** parameter range values for each type of card that can have assigned signaling link ports.

**:loc=** (mandatory)

Card location. The unique identifier of a specific application subsystem located in the STP.

**Range:** 1101-1108, 1111-1112, 1201-1208, 1211-1218, 1301-1308, 1311-1318, 2101-2108, 2111-2118, 2201-2208, 2211-2218, 2301-2308, 2311-2318, 3101-3108, 3111-3118, 3201-3208, 3211-3218, 3301-3308, 3311-3318, 4101-4108, 4111-4118, 4201-4208, 4211-4218, 4301-4308, 4311-4318, 5101-5108, 5111-5118, 5201-5208, 5211-5218, 5301-5308, 5311-5318, 6101-6108, 6111-6118

**:rle=** (mandatory)

Remote link element. The link element to be looped back for testing.

**Range:** ds0, ocu, csu, dsu, nei

**:cli=** (optional)

The Common Language Location Identifier (CLLI) code, or other mnemonic identifier, used to refer to the given loopback point.

**Range:** ayyyyyyyyyy

1 alphabetic character followed by up to 10 alphanumeric characters.

**:rep=** (optional)

Repetition count. The number of link elements of the same type (not including the target device) that lie between the STP and the link element to be tested.

**Range:** 0-31

**Default:** 0—If the link element to be looped back for testing is NEI (**rle=nei** is specified)

0—If the LFS test is NLT (non-latched); **lfst=nl** is specified

0—If no other LBP for this link has the same **rle** value

1–30—Next sequential number for subsequent loopback points of the link to be tested (**rle** is specified as anything but **nei**)

### Example

```
ent-
lbp:loc=1101:link=a:lbp=1:rle=ds0:lfst=llt:rep=0:cli=righncxa05w
ent-lbp:loc=1101:port=a:lbp=2:rle=nei:lfst=llt
ent-
lbp:loc=1205:port=a1:lbp=1:rle=ds0:lfst=llt:cli=righncxa05w:rep=
1
```

### Dependencies

The Link Fault Sectionalization (LFS) feature must be on before this command can be entered.

The card location (**loc** parameter) must be equipped.

The **rle=ds0** parameter and the **rle=nei** parameter cannot be specified when the **lfst=nl** parameter is specified. The DS0 and Network Element Interface (NEI) link elements do not support non-latching loopbacks.

If the **rle=nei** parameter is specified, the **rep=0** parameter must be specified.

The **rep** parameter can be specified only if the **lfst=llt** parameter is specified.

Each specified **rep** parameter value must be greater than any previously specified **rep** value and less than any subsequent specified **rep** value.

The specified **cli** cannot be a reserved word.

The loopback point (LBP) cannot have been previously defined.

The value specified for the **lbp** parameter cannot exceed the **lbp** parameter value previously defined for a loopback point with **rle=nei** specified.

For each SS7 signaling link, only one loopback point with **rle=nei** specified can be defined.

The **rep** parameter must be specified if taking the default value results in duplicate **rep** values for loopback points.

The loopback point with **rle=nei** specified must be the terminating SS7 signaling link element.

The card location must contain a provisioned **limds0**, **limt1**, or **limch** (associated to a **limt1**) card that is running an **ss7ansi** or **ccs7itu** application.

The card location (**loc** parameter) must not be reserved by the system.

**Notes**

None

**Output**

```
ent-lbp:loc=1101:link=a:lbp=2:rle=nei:lfst=11t
rlghncxa03w 05-02-17 15:35:05 EST EAGLE5 33.0.0
ENT-LBP: MASP A - COMPLTD
;
```

**ent-lnp-serv**

**Enter LNP Service**

Use this command to reserve an LNP translation type for a unique LNP service. The available services include up to six query services (**ain**, **in**, **pcs**, **lnpqs**, **wnp**, and **lrnqt**) and any combination of six message relay or user-defined services. Translation type names can also be defined and are defaulted to the corresponding reserved service type names.

A maximum of 10 LNP services can be assigned in systems with up to 12 million numbers, and a maximum of 15 LNP services can be assigned in systems with more than 12 million numbers (using ELAP). Two of these assigned services will always be reserved for administration of AIN and IN Translation Types. Administration of Message Relay user defined services will also be allowed.

**Keyword:** ent-lnp-serv

**Related Commands:** chg-lnp-serv, dlt-lnp-serv, rtrv-lnp-serv

**Command Class:** Database Administration

**Parameters**

**:serv=** (mandatory)

Reserved service type name.

**Range:** **ain, in, pcs, wnp, class, lidb, cnam, isvm, lnpqs, wmsmc, udf1, udf2, udf3, udf4, lrnqt**

**:alias=** (optional)

The alias translation type.

**Range:** **000-255**

**:dv=** (optional)

Digits valid.

**Range:** **sccp, tcap**

**Default:** **sccp**—If **serv= class, lidb, cnam, isvm, wmsmc, udf1, udf2, udf3, udf4**  
**tcap**—If **serv= ain, in, pcs, wnp, lnpqs, lrnqt**

**:tt=** (optional)

Translation type.

**Range:** **000-255**

**:ttn=** (optional)

User defined TT name.

**Range:** **aaaaaaaa**

1 to 8 alphabetic characters, the value **none** is not allowed.

**Default:** Reserved service type name (**serv** parameter)

**Example**

```
ent-lnp-serv:serv=lidb:tt=16:dv=tcap:ttt=mrlidb
ent-lnp-serv:serv=lrnqt:tt=239:dv=tcap
```

**Dependencies**

The LNP feature must be turned on (see the **enable-ctrl-feat** command) before this command can be entered.

The PLNP feature must be turned on before the **nserv=pcs** parameter can be specified.

The WNP feature must be turned on before the **nserv=wnp** feature can be specified.

The LNP SMS feature must be turned on before the **serv=wsmsc** parameter can be specified.

The **tt** parameter, the **ttt** parameter, and the **dv** parameter cannot be specified in the same command with the **alias** parameter.

The **tt** parameter must be specified if the **alias** parameter is not specified in the command.

The **ttt=none** parameter cannot be specified.

If any of the **udf1** – **udf6** values are specified for the **serv** parameter, then the **dv=sccp** parameter must be specified.

If the **lnpqs**, **ain**, **in**, **pcs**, **wnp**, or **lrnqt** values are specified for the **serv** parameter, then the **dv=tcap** parameter must be specified.

A reserved service type name can be specified for the **ttt** parameter only if it matches the **serv** parameter value.

The value of the **tt** parameter cannot already exist in the LNP database.

If the **tt** parameter is specified, then the value of the **serv** parameter cannot exist in the LNP database.

A maximum of 6 Message Relay services are allowed.

If the **alias** parameter is specified, then the **serv** parameter must already have an assigned translation type.

When the **alias** parameter is specified, its value cannot already exist in the LNP database as a true translation type for this service.

If the **alias** parameter is specified, then the specified **alias** cannot be in use.

If the **tt** parameter is specified, then its value cannot already exist in the LNP database as an **alias** for this service.

The value of the **ttt** parameter cannot exist in the LNP database.

The LRNQT feature must be turned on (see the **chg-ctrl-feat** command) before the **serv=lrnqt** parameter can be specified.

**Notes**

Translation type names must be unique for LNP services.

A translation type name can be a reserved service type name only if it matches the specified service.

**Output**

```
ent-lnp-serv:serv=lidb:tt=16:dv=tcap:ttt=mrlidb
rlghncxa03w 02-11-18 08:50:12 EST EAGLE 30.0.0
ENT-LNP-SERV: MASP A - COMPLTD
;
```

**ent-loopset****Enter Loop Set Command**

Use this command to enter the loopset information into the database. This command updates the Loopset table.

**Keyword:** ent-loopset

**Related Commands:** chg-loopset, dlt-loopset, rtrv-loopset

**Command Class:** Database Administration

**Parameters**

**:name=** (mandatory)

Loopset name. This parameter specifies an entry in the Loopset table.

The **name=none** parameter cannot be specified.

**Range:** ayyyyyyy

1 alphabetic and up to 7 alphanumeric characters.

**:pcl=** (mandatory)

ANSI point code list with subfields *network indicator-network cluster-network cluster member (ni-nc-ncm)*. The *prefix* subfield indicates a private point code (*prefix-ni-nc-ncm*). This parameter allows up to 6 comma-delimited entries in the point code list.

**Synonym:** pcla

**Range:** p-, 000-255

Specify a valid value for each subfield of the point code, and separate the subfields with a dash (-).

*prefix—p-*

When **chg-sid:pctype=ansi** is specified, *ni = 000* is not valid.

When **chg-sid:pctype=ansi** is specified, *nc = 000* is not valid if *ni = 001-005*.

When **chg-sid:pctype=ansi** is specified, *nc = 000* is valid if *ni = 006-255*.

The point code **000-000-000** is not a valid point code.

**:pcli=** (mandatory)

ITU international point code list with subfields *zone-area-id*. The *prefix* subfield indicates a spare point code, private point code, or private and spare point code (*prefix-zone-area-id*). This parameter allows up to 6 comma-delimited entries in the point code list.

**Range:** s-, p-, ps-, 0-255

Specify a valid value for each subfield of the point code, and separate the subfields with a dash (-).

*prefix—s-, p-, ps-*

*zone—0-7*

*area—000-255*

*id—0-7*

The point code **0-000-0** is not a valid point code.

**:pcli=** (mandatory)

ITU national point code list in the format of a 5-digit number (*nnnnn*); or 2, 3, or 4 numbers (members) separated by dashes (*m1-m2-m3-m4*) as defined by the **chg-stpopts:npcfmti** flexible point code option. A group code must be specified when the ITUDUPPC feature is turned on (*nnnnn-gc, m1-m2-m3-m4-gc*). The *prefix* subfield indicates a spare point code (*prefix-nnnnn, prefix-nnnnn-gc, prefix-m1-m2-m3-m4, prefix-m1-m2-m3-m4-gc*). This parameter allows up to 6 comma-delimited entries in the point code list.

**Range:** s-, p-, ps-, 0-16383, aa-zz

Specify a valid value for each subfield of the point code, and separate the subfields with a dash (-).

*prefix*—**s**, **p**, **ps**

*n1-n2-n3-n4*—**0-16383**

*gc*—**aa-zz**

*m1-m2-m3-m4*—**0-14** for each member; values must sum to 14

**:pcln24=** (mandatory)

24-bit ITU national point code list with subfields *main signaling area-sub signaling area-signaling point (msa-ssa-sp)*. This parameter allows up to 6 comma-delimited entries in the point code list.

**Range:** **p**, **000-255**

Specify a valid value for each subfield of the point code, and separate the subfields with a dash (-).

*prefix*—**p**

*msa*—**000-255**

*ssa*—**000-255**

*sp*—**000-255**

**:mode=** (optional)

Mode of operation. This parameter specifies whether the message is discarded when an SCCP loop is detected.

**Range:** **notify**, **discard**

**notify** — Generates a UIM without discarding the message.

**discard** — Generates a UIM and discards the message.

**Default:** **notify**

### Example

This example creates a new loopset using the default mode of notify.

```
ent-loopset:name=rtp1:pcl=3-3-3,5-5-5,7-7-7,3-4-3
```

This example creates a new loopset and sets the mode to discard.

```
ent-loopset:name=rtp2:mode=discard:pcl=3-3-3,5-5-5,7-7-7,3-4-3
```

### Dependencies

The value of the **name** parameter cannot already exist in the database.

The SCCP Loop Detection feature must be enabled before this command can be entered.

The GTT feature must be turned on before this command can be entered.

The Loopset table can hold a maximum of 1,000 loopset entries, with each entry containing up to 12 point codes. Additional loopset entries and point codes cannot be added when the table is full.

The values for the **pcl** parameter must be unique.

The **name=none** parameter cannot be specified.

At least one valid point code must be specified as a value for the **pcl** parameter.

The values for the **pcl** parameter cannot consist of any invalid point codes. The valid point codes must be consecutively specified and separated by commas.

**Output**

The following example creates a new loopset and sets the mode to **discard**.

```
ent-loopset:name=rtp2:mode=discard:pcl=3-3-3,5-5-5,7-7-7,3-4-3
  rlgncxa03w 07-02-10 08:31:28 EST EAGLE Rel 35.6.0
  LOOPSET table is (12 of 1000) 1% full
  ENT-LOOPSET: MASP A - COMPLTD
;
```

**ent-ls****Enter Linkset**

Use this command to add a linkset, with its assigned far-end point code and other linkset attributes, to the database.

**Keyword:** ent-ls

**Related Commands:** chg-ls, dlt-ls, rtrv-ls

**Command Class:** Database Administration

**Parameters**

**NOTE:** See "Point Code Formats and Conversion" for a detailed description of point code formats, rules for specification, and examples.

**:apc=** (mandatory)

ANSI adjacent destination point code with subfields *network indicator-network cluster-network cluster member (ni-nc-ncm)*. The *prefix* subfield indicates a private point code (*prefix-ni-nc-ncm*).

**Synonym:** apca

**Range:** p-, 000-255

Specify a valid value for each subfield of the point code, and separate the subfields with a dash (-).

*prefix*—p-

When **chg-sid:pctype=ansi** is specified, *ni* = 000 is not valid.

When **chg-sid:pctype=ansi** is specified, *nc* = 000 is not valid if *ni* = 001-005.

When **chg-sid:pctype=ansi** is specified, *nc* = 000 is valid if *ni* = 006-255.

The point code 000-000-000 is not a valid point code.

**:apc/apca/apci/apcn/apcn24=** (mandatory)

Adjacent point code. The DPC of the adjacent signaling node at the far end of the linkset.

**:apci=** (mandatory)

ITU international adjacent destination point code with subfields *zone-area-id*. The *prefix* subfield indicates a spare point code, private point code, or private and spare point code (*prefix-zone-area-id*).

**Range:** s-, p-, ps-, 0-255

Specify a valid value for each subfield of the point code, and separate the subfields with a dash (-).

*prefix*—s-, p-, ps-

*zone*—0-7

*area*—000-255

*id*—0-7

The point code 0-000-0 is not a valid point code.

**:apcn=** (mandatory)

ITU national adjacent destination point code in the format of a 5-digit number (*nnnnn*); or 2, 3, or 4 numbers (members) separated by dashes (*m1-m2-m3-m4*) as defined by the **chg-stpopts:npcfnti** flexible point code option. A group code must be specified when the ITUDUPPC feature is turned on (*nnnnn-gc, m1-m2-m3-m4-gc*). The *prefix* subfield indicates a spare point code, private point code, or private and spare point code (*prefix-nnnnn, prefix-nnnnn-gc, prefix-m1-m2-m3-m4, prefix-m1-m2-m3-m4-gc*).

**Range:** **s-, p-, ps-, 0-16383, aa-zz**

Specify a valid value for each subfield of the point code, and separate the subfields with a dash (-).

*prefix*—**s-, p-, ps-**

*nnnnn*—**0-16383**

*gc*—**aa-zz**

*m1-m2-m3-m4*—**0-14** for each member; values must sum to 14

**:apcn24=** (mandatory)

24-bit ITU national adjacent destination point code with subfields *main signaling area-sub signaling area-signaling point (msa-ssa-sp)*. The *prefix* indicates a private point code (*prefix-msa-ssa-sp*).

**Range:** **p-, 000-255**

Specify a valid value for each subfield of the point code, and separate the subfields with a dash (-).

*prefix*—**p-**

*msa*—**000-255**

*ssa*—**000-255**

*sp*—**000-255**

**:lsn=** (mandatory)

Linkset name. Each linkset name must be unique in the system.

**Range:** *ayyyyyyyy*

1 alphabetic character followed by up to 9 alphanumeric characters

**:lst=** (mandatory)

Linkset type. This parameter specifies the linkset type of the specified linkset as defined in Telcordia GR-246-CORE, T1.111.5.

**Range:** **a, b, c, d, e, prx**

**a**— Access links

**b**— Bridge links

**c**— Cross links

**d**— Diagonal links

**e**— Extended links

**prx**— Proxy links

**:adapter=** (optional)

This parameter specifies the adapter layer for links provisioned in a IPSG linkset.

**Range:** **m3ua, m2pa**

**Default:** **m2pa**

**:apctype=** (optional)

ITU-N Adjacent Point Code Type. This parameter specifies the format that will be used for changeover and changeover acknowledgement messages.

**Range:** **itun, itunchina**

**itun**— ITU National Adjacent Point Code Type



- itunchina**— ITU National China Adjacent Point Code Type
- Default:** **itun**
- :asl8=** (optional)  
Adjacent SLS 8-bit indicator. This parameter specifies whether the adjacent node is sending MSUs with 8-bit SLSs.  
**Range:** **yes, no**  
**Default:** **no**
- :asnotif=** (optional)  
AS notification. This parameter specifies whether AS notifications should be sent for IPSG-M3UA linkset.  
**Range:** **yes, no**  
**Default:** **yes**
- :bei=** (optional)  
Broadcast exception indicator. This parameter specifies whether TFP (transfer prohibited) messages are allowed to be broadcast on the linkset.  
**Range:** **yes, no**  
**yes**— TFPs are not broadcast (for X.25).  
**no**— TFPs are broadcast (for SS7).  
**Default:** **yes**—for X.25  
**no**—for SS7
- :cggtmod=** (optional)  
Calling party GT modification indicator. This parameter specifies whether calling party global title modification is required for the specified linkset.  
**Range:** **yes, no**  
**Default:** **no**
- :clli=** (optional)  
Far-end Common Language Location Identifier (CLLI). This parameter specifies the CLLI assigned to the linkset.  
**Range:** *ayyyyyyyyyy*  
1 alphabetic character followed by up to 10 alphanumeric characters  
**Default:** CLLI of the adjacent point code
- :gsmscrn=** (optional)  
GSM MAP screening. This parameter specifies whether GSM MAP screening is allowed.  
**Range:** **on, off**  
**Default:** **off**
- :gttmode=** (optional)  
Global title translation mode. This parameter selects a GTT Mode hierarchy for each link set.  
**Range:** **cd, cg, acdcd, acdcgcd, acdcdcg, cgacdcd, cgcd, sysdflt, fcd, fcg, fcgfc, fcdfcg, cdcg**  
**cd**— CdPA GTT only  
**cg**— CgPA GTT only  
**acdcd**— Advanced CdPA GTT, CdPA GTT  
**acdcgcd**— Advanced CdPA GTT, CgPA GTT, CdPA GTT  
**acdcdcg**— Advanced CdPA GTT, CdPA GTT, CgPA GTT  
**cgacdcd**— CgPA GTT, Advanced CdPA GTT, CdPA GTT  
**cgcd**— CgPA GTT, CdPA GTT  
**sysdflt**— System wide default value  
**fcd**— FLOBR CdPA only  
**fcg**— FLOBR CgPA only

**fcgfd** — FLOBR CgPA, FLOBR CdPA  
**fdcfg** — FLOBR CdPA, FLOBR CgPA  
**cdeg** — CdPA GTT, CgPA GTT

**Default:** **sysdflt**

**:gwsa=** (optional)

Gateway screening action. This parameter specifies whether gateway screening (GWS) is on or off for the specified linkset.

**Range:** **on, off**

**Default:** **on**—if **scrn** is specified  
**off**—if **scrn** is not specified

**:gwsd=** (optional)

Gateway screening MSU discard. This parameter specifies whether the discarding of MSUs that bypass the gateway screening function due to load-shedding is on or off. This parameter is also used with the redirect function; MSUs that cannot be screened are discarded if **gwsd=on** is specified.

**Range:** **on, off**

**Default:** **off**

**:gwsn=** (optional)

Gateway screening messaging. This parameter specifies whether messages are generated for each message screened by gateway screening.

**Range:** **on, off**

**Default:** **off**

**:ipgwpc=** (optional)

IP gateway adjacent point code. Specifying **ipgwpc=yes** indicates that the linkset is entered for a card of application type SS7IPGW or IPGWI and the adjacent point code specified is an IP gateway adjacent point code.

**Range:** **yes, no**

**Default:** **no**

**:ipsg=** (optional)

IP signaling gateway adjacent point code. This parameter specifies whether a linkset is entered for an IPSG card. The specified adjacent point code is an IPLIM or IP gateway adjacent point code.

**Range:** **yes, no**

**Default:** **no**

**:iptps=** (optional)

IPGWx Linkset TPS.

This parameter is a user-defined portion of the total system IP Signaling TPS. This parameter is allowed and required only for IPGWx linksets (the **ipgwpc=yes** parameter is specified).

The sum of the TPS values assigned to all linksets in the system cannot exceed 500000.

**Range:** **100-32000**

The specified value must be divisible by 10.

**:islsrb=** (optional)

Incoming rotated signaling link selection (SLS) bit. This parameter specifies the bit (**1–4**) for ITU and (**1–8**) for ANSI link sets to rotate as the new SLS LSB (Least Significant Bit) of the incoming linkset. The SLS is not modified in the outgoing message.

Table 5-50 shows how the rotation affects the four bits of the ITU SLS during linkset selection:

**Table 5-50.** Incoming SLS Bit Rotation for ITU

| <b>If This Bit is Selected...</b> | <b>Then Bit Locations 4 3 2 1 Are Rotated To...</b>        | <b>Description</b>                                                             |
|-----------------------------------|------------------------------------------------------------|--------------------------------------------------------------------------------|
| Bit 4                             | 3 2 1 4                                                    | SLS = 0110 becomes Rotated SLS = 1100<br>SLS = 1011 becomes Rotated SLS = 0111 |
| Bit 3                             | 2 1 4 3                                                    | SLS = 0110 becomes Rotated SLS = 1001<br>SLS = 1011 becomes Rotated SLS = 1110 |
| Bit 2                             | 1 4 3 2                                                    | SLS = 0110 becomes Rotated SLS = 0011<br>SLS = 1011 becomes Rotated SLS = 1101 |
| Bit 1                             | No rotation is performed because bit 1 is the existing LSB |                                                                                |

Table 5-51 shows how the rotation affects the eight bits of the ANSI SLS during linkset selection:

**Table 5-51.** Incoming SLS Bit Rotation for ANSI

| <b>If This Bit is Selected...</b> | <b>Then Bit Locations 8 7 6 5 4 3 2 1 Are Rotated To...</b> |                                                                                                |
|-----------------------------------|-------------------------------------------------------------|------------------------------------------------------------------------------------------------|
| Bit 8                             | 7 6 5 4 3 2 1 8                                             | SLS = 10010110 becomes Rotated SLS = 00101101<br>SLS = 11001011 becomes Rotated SLS = 10010111 |
| Bit 7                             | 6 5 4 3 2 1 8 7                                             | SLS = 10010110 becomes Rotated SLS = 01011010<br>SLS = 11001011 becomes Rotated SLS = 00101111 |
| Bit 6                             | 5 4 3 2 1 8 7 6                                             | SLS = 10010110 becomes Rotated SLS = 10110100<br>SLS = 11001011 becomes Rotated SLS = 01011110 |

Table 5-51. Incoming SLS Bit Rotation for ANSI

| If This Bit is Selected... | Then Bit Locations 8 7 6 5 4 3<br>2 1 Are Rotated To...     |                                                                                                |
|----------------------------|-------------------------------------------------------------|------------------------------------------------------------------------------------------------|
| Bit 5                      | 4 3 2 1 8 7 6 5                                             | SLS = 10010110 becomes Rotated SLS = 01101001<br>SLS = 11001011 becomes Rotated SLS = 10111100 |
| Bit 4                      | 3 2 1 8 7 6 5 4                                             | SLS = 10010110 becomes Rotated SLS = 11010010<br>SLS = 11001011 becomes Rotated SLS = 01111001 |
| Bit 3                      | 2 1 8 7 6 5 4 3                                             | SLS = 10010110 becomes Rotated SLS = 10100101<br>SLS = 11001011 becomes Rotated SLS = 11110010 |
| Bit 2                      | 1 8 7 6 5 4 3 2                                             | SLS = 10010110 becomes Rotated SLS = 01001011<br>SLS = 11001011 becomes Rotated SLS = 11100101 |
| Bit 1                      | No rotation is performed because bit 1 is the existing LSB. |                                                                                                |

This parameter is used for ITU or ANSI messages on a per-linkset basis.

**Range:** 1-8

ITU linksets—1-4

ANSI linksets—1-8

The **rsls8=yes** parameter must be specified (see the **chg-lsopts** command) before a value greater than 5 can be specified for the **islsrsb** parameter.

**Default:** 1

**:itutfr=** (optional)

ITU TFR (Transfer Restricted) procedure indicator. This parameter specifies whether the TFR procedure is on or off on a per-linkset basis. This parameter is valid for ITU national linksets only.

**Range:** on, off

**Default:** off

**:l3tset=** (optional)

Link timer set. This parameter value is the value that is defined with the **chg-l3t** command.

**Range:** 1

**Default:** 1

**:lsusealm=** (optional)

IPTPS linkset alarm threshold percent. This parameter specifies the percent of the linkset TPS (**iptps**) at which an alarm is generated to indicate that the actual linkset TPS is approaching the configured **iptps** value for the linkset.

**Range:** 10-100

**Default:** 100

**:mtprese=** (optional)

ANSI or ITU MTP Restart equipped. This parameter specifies whether the node adjacent to the linkset is equipped with MTP Restart.

**Range:** **yes, no**  
**yes** — equipped  
**no** — not equipped

**Default:** **no**

**:multgc=** (optional)

Multiple group codes. This parameter specifies whether multiple group codes can be specified.

**Range:** **yes, no**

**Default:** **no**

**:nis=** (optional)

Network Indicator Spare. This parameter specifies whether the Network Indicator Spare option is on or off for the specified linkset. When this option is enabled, the Network Spare value for network indicator for both ANSI and ITU-National (ITU-N) links is supported by the system.

**Range:** **on, off**

**Default:** **off**

**:ppc=** (optional)

ANSI proxy point code with subfields *network indicator-network cluster-network cluster member* (*ni-nc-ncm*).

The proxy point code must be a full point code.

**Synonym:** **ppca**

**Range:** **000-255**

Specify a valid value for each subfield of the point code, and separate the subfields with a dash (-).

When **chg-sid:pctype=ansi** is specified, *ni* = **000** is not valid.

When **chg-sid:pctype=ansi** is specified, *nc* = **000** is not valid if *ni* = **001-005**.

When **chg-sid:pctype=ansi** is specified, *nc* = **000** is valid if *ni* = **006-255**.

The point code **000-000-000** is not a valid point code.

**:ppc/ppca/ppci/ppcn/ppcn24=** (optional)

Proxy Point Code

The proxy point code must be a full point code.

**:ppci=** (optional)

ITU international proxy point code with subfields *zone-area-id*. The *prefix* subfield indicates a spare point code.

**Range:** **s-, 0-255, none**

Specify a valid value for each subfield of the point code, and separate the subfields with a dash (-).

*prefix*—**s-**

*zone*—**0-7**

*area*—**000-255**

*id*—**0-7**

Enter **none** to delete the point code.

The point code **0-000-0** is not a valid point code.

**:ppcn=** (optional)

ITU national proxy point code in the format of a 5-digit number (*nnnnn*); or 2, 3, or 4 numbers (*members*) separated by dashes (*m1-m2-m3-m4*) as defined by the **chg-stpopts:npcfmti** flexible point code option. A group code must be specified when the ITUDUPPC feature is turned on (*nnnnn-gc*, *m1-m2-m3-m4-gc*). The *prefix* subfield indicates a spare point code (*prefix-nnnnn*, *prefix-nnnnn-gc*, *prefix-m1-m2-m3-m4*, *prefix-m1-m2-m3-m4-gc*).

**Range:** **s-, 0-16383, aa-zz**

Specify a valid value for each subfield of the point code, and separate the subfields with a dash (-).

*prefix*—s-

*nnnnn*—**0-16383**

*gc*—**aa-zz**

*m1-m2-m3-m4*—**0-14** for each member; values must sum to 14

**:ppcn24=** (optional)

24-bit ITU national point code with subfields *main signaling area-sub signaling area-signaling point* (*msa-ssa-sp*).

**Range:** **000-255**

Specify a valid value for each subfield of the point code, and separate the subfields with a dash (-).

*msa*—**000-255**

*ssa*—**000-255**

*sp*—**000-255**

**:randsls=** (optional)

Random SLS (signaling link selection). This parameter is used to apply random SLS generation for the specified linkset.

Specifying the **randsls** parameter in the **ent-ls** command enables random SLS generation on a per linkset basis only if the **randsls=perls** parameter has been specified in the **chg-stpopts** command.

**Range:** **off, class0, all**

**off**— Disables random SLS generation on a specified linkset.

**class0**— Enables random SLS generation for Class0 SCCP traffic on a specified linkset.

**all**— Enables random SLS generation for Class0 and Class1 SCCP traffic on a specified ITU linkset and for Class0 and ISUP traffic on a specified ANSI linkset.

**Default:** **off**

**:rcontext=** (optional)

Routing context. This parameter specifies whether to assign a new routing context to an IPSG-M3UA linkset.

**Range:** **0-4294967295**

**System**

**Default:** **none**

**:scrn=** (optional)

Gateway screening screen set. This parameter specifies the gateway screening screen set assigned to this linkset.

**Range:** *ayyy*, **none**

1 alphabetic character followed by up to 3 alphanumeric characters, or **none**

**none**—Deletes screen set association with the linkset

**:slktps=** (optional)

Per signaling link TPS for IPSG Linkset. This parameter is specified for each link provisioned in the specified linkset. This parameter is allowed and required only for IPSG linksets (the **ipsg=yes** parameter is specified).

The sum of the TPS values assigned to all linksets in the system cannot exceed 500,000.

**Range: 100-5000**

**:slkusealm=** (optional)

IPTPS signaling link alarm threshold percent. This parameter specifies the percent of the link "fair share" TPS at which an alarm is generated to indicate that the actual link TPS is approaching the link's "fair share" of its linkset's configured TPS (**iptps**). The "fair share" of the linkset TPS for a link is the configured linkset TPS divided by the number of in-service links in the linkset.

**Range: 10-100**

**Default: 80**

**:slsci=** (optional)

5-bit to 8-bit SLS conversion indicator. This parameter specifies whether the 5-bit to 8-bit SLS conversion feature is used to select links for outgoing messages direct to the given linkset. When enabled, the system replaces any 5-bit SLS values contained in received messages, with a random 8-bit value before the 5-bit SLS values are used by the STP to select the outgoing link in that linkset.

**Range: yes, no**

**yes** — enabled

**no** — disabled

**Default: no**

**:slsocbit=** (optional)

Other CIC (Circuit Identification Code) Bit. If the SLSOCB feature is turned on, this parameter specifies whether the Other CIC Bit option is to be used during link selection. If the option is to be used, specify which bit (5– 16) of the CIC is to be used as the other CIC bit. During link selection, the specified bit acts as the most significant bit of the new SLS and bits 2 through 4 of the received CIC become the least significant bits of the new SLS. This parameter is used for ITU-ISUP messages. The SLS is not modified in the outgoing message. The following example shows a received CIC where bit 9 is the other CIC bit (**slsocbit=9**). The new SLS is 0100.

|           |           |           |           |           |           |           |          |          |          |          |          |          |          |          |          |
|-----------|-----------|-----------|-----------|-----------|-----------|-----------|----------|----------|----------|----------|----------|----------|----------|----------|----------|
| <b>16</b> | <b>15</b> | <b>14</b> | <b>13</b> | <b>12</b> | <b>11</b> | <b>10</b> | <b>9</b> | <b>8</b> | <b>7</b> | <b>6</b> | <b>5</b> | <b>4</b> | <b>3</b> | <b>2</b> | <b>1</b> |
| 0         | 0         | 0         | 0         | 1         | 0         | 0         | 0        | 1        | 0        | 0        | 1        | 1        | 0        | 0        | 1        |
| New SLS   |           |           |           |           |           |           |          | 0        |          |          | 1        | 0        | 0        |          |          |

**Range: 5-16 none**

**Default: none**

**:slsrsb=** (optional)

Rotated signaling link selection (SLS) bit. This parameter specifies the bit (1–4) to rotate as the new SLS Least Significant Bit (LSB). The SLS is not modified in the outgoing message. Table 5-52 shows how the rotation affects the four bits of the SLS during linkset selection:

Table 5-52. SLS Bit Rotation

| If This Bit is Selected... | Then Bit Locations 4 3 2 1 Are Rotated To...               | Description                                                                    |
|----------------------------|------------------------------------------------------------|--------------------------------------------------------------------------------|
| Bit 4                      | 3 2 1 4                                                    | SLS = 0110 becomes Rotated SLS = 1100<br>SLS = 1011 becomes Rotated SLS = 0111 |
| Bit 3                      | 2 1 4 3                                                    | SLS = 0110 becomes Rotated SLS = 1001<br>SLS = 1011 becomes Rotated SLS = 1110 |
| Bit 2                      | 1 4 3 2                                                    | SLS = 0110 becomes Rotated SLS = 0011<br>SLS = 1011 becomes Rotated SLS = 1101 |
| Bit 1                      | No rotation is performed because bit 1 is the existing LSB | -                                                                              |

This parameter is used for ITU messages on a per-linkset basis.

**Range:** 1-4

**Default:** 1

**:sltset=** (optional)

SLTM record. This parameter specifies the SLTM record to be associated with the linkset.

**Range:** 1-20

**Default:** 1 for ANSI  
2 for ITU

**:spc=** (optional)

ANSI secondary point code with subfields *network indicator-network cluster-network cluster member (ni-nc-ncm)*. The *prefix* subfield indicates a private point code (*prefix-ni-nc-ncm*).

**Range:** 000-255

Specify a valid value for each subfield of the point code, and separate the subfields with a dash (-).

When **chg-sid:pctype=ansi** is specified, *ni* = 000 is not valid.

When **chg-sid:pctype=ansi** is specified, *nc* = 000 is not valid if *ni* = 001-005.

When **chg-sid:pctype=ansi** is specified, *nc* = 000 is valid if *ni* = 006-255.

The point code 000-000-000 is not a valid point code.

**:spc/spca/spci/spcn/spcn24=** (optional)

Secondary point code.



**:spci=** (optional)

ITU international secondary point code with subfields *zone-area-id*. The *prefix* subfield indicates a spare point code (*prefix-zone-area-id*).

**Range:** **s-, 0-255**

Specify a valid value for each subfield of the point code, and separate the subfields with a dash (-).

*prefix*—**s-**

*zone*—**0-7**

*area*—**000-255**

*id*—**0-7**

The point code **0-000-0** is not a valid point code.

**:spcn=** (optional)

ITU national secondary point code in the format of a 5-digit number (*nnnnn*); or 2, 3, or 4 numbers (members) separated by dashes (*m1-m2-m3-m4*) as defined by the **chg-stpopts:npcfnti** flexible point code option. A group code must be specified when the ITUDUPPC feature is turned on (*nnnnn-gc*, *m1-m2-m3-m4-gc*). The *prefix* subfield indicates a spare point code (*prefix-nnnnn*, *prefix-nnnnn-gc*, *prefix-m1-m2-m3-m4*, *prefix-m1-m2-m3-m4-gc*).

**Range:** **s-, 0-16383, aa-zz**

Specify a valid value for each subfield of the point code, and separate the subfields with a dash (-).

*prefix*—**s-**

*nnnnn*—**0-16383**

*gc*—**aa-zz**

*m1-m2-m3-m4*—**0-14** for each member; values must sum to 14

**:spcn24=** (optional)

24-bit ITU national secondary point code with subfields *main signaling area-sub signaling area-signaling point* (*msa-ssa-sp*).

**Range:** **000-255**

Specify a valid value for each subfield of the point code, and separate the subfields with a dash (-).

*msa*—**000-255**

*ssa*—**000-255**

*sp*—**000-255**

**Example**

Adds linkset wy644368 with apc 144-201-1 with lstc:

```
ent-ls:lsn=wy644368:apc=144-201-001:lst=c
```

Adds linkset lsitua1 with apcn5-5-5-1 with lstc. The apcn parameter is using a four-part format where the maximum number of bits in each position is defined by the chg-stpopts:npcfnti parameter :

```
ent-ls:lsn=lsitua1:apcn=5-5-5-1:lst=c
```

In this example, the ITU national duplicate point code (ITUDUPPC) feature is turned on, so the ITU national point code contains a group code. Adds linkset exp123 with apcn2-3-4-5-aa, which has a duplicate point code group of aa and linkset type a:

```
ent-ls:lsn=exp123:apcn=2-3-4-5-aa:lst=a
```

Add a linkset in which all applicable MSUs arriving on the linkset are screened using the GSM MAP screening feature:

**ent-ls:lsn=lsitu1:apcn=5000:lst=a:gsmscrn=on**

Adds a link set lsn24 with 24-bit ITU-N apcn2410-100-10 and linkset type a:

**ent-ls:lsn=lsn24:apcn24=10-100-10:lst=a**

Adds link set lsa2 with private APC p-1-2-4

**ent-ls:lst=a:lsn=lsa2:apc=p-1-2-4**

Adds link set lsn410234 with private and spare APCN ps-1-1-1-2047-aa:

**ent-ls:lst=b:lsn=lsn410234:apcn=ps-1-1-1-2047-aa**

Adds link set lsi00001 with spare APCI s-1-1-209-7:

**ent-ls:lst=b:lsn=lsi00001:apci=s-1-1-209-7**

Adds link set lsn24 with APCN24 10-100-10 with apcntype=itunchina and linkset type a.

**ent-ls:lsn=lsn24:apcn24=10-100-10:lst=a:apcntype=itunchina**

Adds link set lsa using the global title translation mode cgacdcd.

**ent-ls:lsn=lsa:lst=a:apca=1-1-1:gttmode=cgacdcd**

Enables random SLS generation for Class0 and Class1 SCCP traffic on ITU linkset lsa.

**ent-ls:lsn=lsa:lst=a:apci=1-1-2:randsls=all**

Adds a linkset in which calling party global title modification is required for all GT routed MSUs arriving on the linkset:

**ent-ls:lsn=ls2:apc=2-2-2:lst=a:cggmod=yes**

Adds an IPSG-M3UA linkset.

**ent-**

**ls:lsn=ls1201:apc=10-10-10:lst=a:adapter=m3ua:ipsg=yes:slktps=100**

Adds an IPSG-M2PA linkset.

**ent-ls:lsn=lsm2pa:apc=5-6-7:lst=c:ipsg=yes:slktps=300**

Adds a linkset and sets the Incoming SLS Bit Rotation on the 2nd Bit.

**ent-ls:lsn=lsa:lst=a:apci=1-1-2:islsrsb=2**

Adds linkset lsa using the GTT mode fcdfcg when the Flexible Option Based Routing (FLOBR) feature is turned on.

**ent-ls:lsn=lsa:lst=a:apca=1-1-1:gttmode=fcdfcg**

Adds ANSI link set lsa and sets the Incoming SLS Bit Rotation to the 6th bit (the 6th bit in the SLS is used as the LSB)

**ent-ls:lsn=lsa:lst=a:apca=1-1-1:islsrsb=6**

## Dependencies

The value specified for the **apc** parameter must be a full point code.

The specified adjacent point code cannot exist as an alias point code.

If the **gwsa=on**, **gwsn=on**, and **gwsd=on** parameters are specified, the **scrn** parameter must be specified.

The specified adjacent point code cannot be the same as the self-ID destination point code of the STP.

The specified adjacent point code cannot be the same as any self-ID capability point codes of the STP.

If the system is configured for ANSI point codes, and the **nc=0** parameter is specified, then the value of the **ni** parameter must be **6** or greater.

The specified linkset name cannot already exist in the database.

The specified adjacent point code cannot be assigned to any other linkset.

Private (**p-**) and private and spare (**ps-**) point codes can be assigned only to IPGW linksets (the **ipgwapc=yes** parameter is specified).

The maximum number of linksets that can be defined in the system is 1024.

The specified screen set (**scrn** parameter) must exist in the database.

If the **gwsd=on** parameter is specified, the **gwsa=on** parameter must be specified.

If a destination point code matching the specified far-end point code exists, the far-end CLLI for the given linkset must match the destination identifier (DI) of that matching destination.

If the adjacent point code is in the X.25 domain, the **bei=yes** parameter must be specified or the **bei** parameter must be omitted from the command.

The specified adjacent point code cannot be referenced by an X.25 route that specifies the **lc2nm=yes** parameter.

The **slsci** parameter cannot be specified for X25 linksets.

The **mtpmse** parameter can be specified only if the MTP Restart feature MTPRS (for ANSI) is turned on. The **>rtrv-feat** command can be used to verify whether the feature is turned on (mtpms=yes in the output).

If the **ipgwapc=yes** parameter is specified or the **ipsg=yes** and the **adapter=m3ua** parameters are specified, then the **mtpmse=yes** parameter cannot be specified.

The **asl8=yes** parameter can be assigned only to an ANSI linkset (a linkset containing an adjacent point code in the SS7 domain).

The **apcntype** parameter can be specified only for ITU-N and ITU-N24 linksets.

The Other CIC (Circuit Identification Code) Bit Used feature (SLSOCB) feature must be turned on before the **slsochbit** parameter can be specified.

The **slsochbit** parameter is valid only for ITU linksets.

The **slsrstb** parameter is valid only for ITU linksets.

The GSM Map Screening feature must be turned on (see the **enable-ctrl-feat** and **chg-ctrl-feat** commands) before the **gmscrn** parameter can be specified.

The **itutfr** parameter is valid only for

- ITU national linksets on the EAGLE 5 ISS STP
- ITU linksets on the IP<sup>7</sup> Secure Gateway

The ITU National Duplicate Point Code (ITUDUPPC) feature must be turned on before the **multgc=yes** parameter can be specified.

The **multgc=yes** parameter is valid only for ITU-N or ITU-I point codes.

The **iptps** parameter must be specified for IPGWx linksets

The **iptps** parameter cannot be specified for linksets that are not IPGWx.

The specified **iptps** parameter value must be divisible by 10.

The total of the **iptps** parameter values for all linksets cannot exceed the maximum system limit of 500,000 TPS.

The **ipgwapc=yes** or the **ipsg=yes** parameter must be specified before the **lsusealm** parameter can be specified.

The **ipgwapc=yes** or the **ipsg=yes** parameter must be specified before the **slkusealm** parameter can be specified.

The Enhanced GSM Map Screening feature must be turned on before the **gsmscrn=on** parameter can be specified for an ANSI linkset.

The **mtrprse** parameter can be specified only if the MTP Restart feature ITUMTPRS (for ITU), is turned on. The **rtrv-feat** command can be used to verify whether the feature is turned on (itumtps=yes in the output).

A point code cannot be assigned to a linkset as an APC if the point code has been provisioned with exception routes.

An APC cannot be assigned to an IPGWx linkset that is already assigned to a route involving another linkset.

The Origin-based SCCP Routing feature must be turned on before the **gttmode** parameter can have a value of **acdcdd**, **cgacdcdd**, **acdcgdd**, **acdcdeg**, **cgcd**, **cdcg**, or **cg**.

A new IPGW link set cannot be entered if it contains an APC that is already configured in a routing key. An SAPC cannot be added to an existing IPGW link set if the new SAPC is already configured in a routing key.

If APCN is specified for the Adjacent Point Code then the format of APCN must match the format dictated by the NPCFMTI parameter via the CHG-STPOPTS command.

The value of the **dpc/dpca/dpci/dpcn/dpcn24** parameter must exist in the Destination Point Code table.

The **gsmscrn** parameter can be specified only for ITU linksets.

The value specified for the **spc** parameter must be a full point code.

If the Multiple Linksets to a Single Adjacent Point Code (MLS) feature is enabled and turned on, then a maximum of **6** non-IPGW linksets can be created using the same adjacent point code.

The values specified by the **spc** and **apc** parameters must have the same network type.

The Multiple Linksets to a Single Adjacent Point Code (MLS) feature must be turned on before the **spc** parameter can be specified.

The value specified by the **spc** parameter must already exist in the SPC table.

The specified combination of the **apc** and **spc** parameters must be unique for each linkset.

The value specified for the **spc** parameter cannot already be specified as a secondary point code for an adjacent destination point code.

The Proxy Point Code feature must be enabled before the **lst=prx** parameter can be specified.

The Proxy Point Code feature must be enabled before the **ppc** parameter can be specified.

The value specified for the **ppc** parameter must be a full point code.

The **lst=prx** parameter must be specified before the **ppc** parameter can be specified. If the **lst=prx** parameter is specified, then the **ppc** parameter must be specified.

The values specified for the **apc** and **ppc** parameters must have the same network type.

The values specified for the **apc** and **ppc** parameters must have the same group code.

The **spc** and **ppc** parameters cannot be specified together in the command.

The **ppc** parameter cannot be specified for more than 10 linksets.

Two adjacent point codes cannot reference each other as proxy point codes.

Only one IPGWx linkset can be created for an adjacent destination point code.

The **apc** parameter and the **prx=yes** parameter must be specified before the **ppc** parameter can be specified.

If the **ipgwapc=yes** parameter is specified, then the **ppc** parameter cannot be specified.

If an IPGW linkset is used, then the **lst=prx** parameter cannot be specified.

If the **ipgwapc=yes** parameter is specified, then the **spc** parameter cannot be specified.

The **spc** and **ppc** parameters cannot be specified together in the command.

All of the linksets for an adjacent destination point code must be of the same type.

The specified combination of the **apc** and **ppc** parameters must be unique for each linkset.

The value specified for the proxy point code must be defined in the Destination table before the **lst=prx** parameter can be specified.

If multiple linksets are defined for the **apc** parameter, and if a proxy point code is defined for the **apc** parameter, then the first linkset defined in the **ent-ls** command must use the proxy point code.

The AMGTT feature or the AMGTT CgPA Upgrade feature must be turned on before the **cggtmod** parameter can be specified.

The **ipgwapc=yes** and the **ipsg=yes** parameter cannot be specified together in the command.

The **ipsg=yes** parameter must be specified before the **adapter** parameter can be specified.

The **ipsg=yes** and the **adapter=m3ua** parameter must be specified before the **asnotif** parameter can be specified.

The **ipsg=yes** and the **adapter=m3ua** parameters must be specified before the **rcontext** parameter can be specified.

The **ipgwapc=yes** parameter must be specified before an invalid point code (ANSI network = 0) can be specified as an APC.

If the **ipsg=yes** parameter is specified, then the **slktps** parameter must be specified.

The **ipsg=yes** parameter must be specified before the **slktps** parameter can be specified.

The **ipsg=yes** and **adapter=m3ua** parameters must be specified before the **lst=a** parameter can be specified.

A maximum of one IPGW linkset or a maximum of 6 of any other linksets are allowed between any APC and the EAGLE 5 ISS.

If the **ipsg=yes** and **adapter=m3ua** parameters are specified, then the **multgc=yes** parameter cannot be specified.

The ISLSBR feature must be enabled before the **islsrsb** parameter can be specified.

The FLOBR feature must be turned on before a value of **fcd**, **fcg**, **fcgfc**, or **fcdfcg** can be specified for the **gttmode** parameter.

The **rsls8=yes** parameter (see the **chg-lsopts** command) must be specified for an ANSI linkset before a value greater than **5** can be specified for the **islsrsb** parameter.

If an ITU linkset is used, then a value of **1–4** must be specified for the **islsrsb** parameter.

## Notes

Of the 1024 maximum linksets supported, up to 255 of the linksets can be gateway linksets.

The system supports a maximum of 700 links. If more than 700 linksets are defined, a maximum of 700 of the defined linksets can be in use at any one time.

The links that directly connect the system with an adjacent node are grouped into one or more linksets. A linkset can contain up to 8 (international standards) or 16 (national standards) signaling links, depending on how the system was configured when the network was created.

Each linkset must be assigned the same physical links at both ends of the link (local and adjacent signaling points) and each link must be assigned the same link number.

Signaling link acknowledgments (SLTA) are the same type of maintenance message as the SLTMs received on the link.

If the **gwsa=off** and **gwsn=off** parameters are specified, all MSUs are passed.

If the **gwsa=off** and **gwsn=off** parameters are specified for all linksets, gateway screening and the GWS redirect function for the DTA feature are disabled.

If the **gwsa=off** and **gwsn=on** parameters are specified, all MSUs pass, but MRNs are generated if an MSU matches a screening condition.

If the **gwsa=on** and **gwsn=off** parameters are specified, MSUs are screened but messages are not generated.

If the **gwsa=on** and **gwsn=on** parameters are specified, MSUs are screened and MRNs are generated at the rate of one MRN every 20 seconds per link.

If the **asl8=yes** parameter is specified with the **lst=a** parameter (a linkset containing access signaling links), this indicates that the originator of the MSUs is generating 8-bit SLSs. For other linkset types, the **asl8=yes** parameter indicates that the adjacent STP is converting 5-bit SLSs to 8-bit SLSs. The SLS in MSUs received by the system on a linkset that has the **asl8=yes** parameter assigned to it will not be converted. These MSUs are assumed to contain 8-bit SLSs.

The Network Indicator Spare (**nis**) parameter can be specified only for ANSI and ITU-N links.

The **mtprse** parameter value can be specified independently of the value specified on the **mtprsi** parameter of the **chg-stpopts** command.

The MTP restart option (**mtprse**) is not a valid option on TCP/IP point-to-multipoint links (DCM cards equipped as SS7IPGW links).

When two linksets are used as a combined linkset, each linkset should have the same **slsci** and **asl8** values. MTP restart provides an orderly process for bringing signaling links back into service after the system has been isolated and restarted. A greater preference is given to restoring the STP to network service in an orderly fashion than to the speed of recovery. The time required is system dependent; Table 5-53 provides examples of some approximate times:

**Table 5-53.** Link Alignment Performance

| System Size (Number of LIMs) | Link Alignment Delay (seconds) |
|------------------------------|--------------------------------|
| up to 64                     | 62                             |
| 64 to 127                    | 97                             |
| 128 to 191                   | 132                            |
| more than 191                | 167                            |

The **slrsb** parameter alone does not provide an even distribution of ITU-ISUP messages across all links within a linkset. The system uses all four bits of the SLS to determine the actual link to route messages. Because the static bit is simply rotated within the SLS, all possible values of the SLS field are still not realized. The **slsochbit** parameter must also be specified to provide an even distribution across all links within the linkset. If both parameters are specified for a given linkset, the SLS field is processed in the following order.

1. The SLS is modified using the Other CIC Bit option.
2. The modified SLS is modified again using the Rotated SLS Bit option.
3. The modified SLS is used by the existing linkset and link selection algorithms to select a link

4. The ISUP message is sent out the link containing the original, unmodified SLS field.

If the ITU National Duplicate Point Code (ITUDUPPC) feature is turned on, for each group that is defined, a separate ITU national C linkset must be provisioned. The C linkset is used as the alternate route for point codes in the group.

In this command, only ITU-international and ITU national point codes support the spare point code subtype prefix (s-) and the private and spare point code subtype prefix (ps-). All of the point code types support the private (internal) point code subtype prefix (p-).

The ITU National and ITU National China Adjacent Point Code types indicate the format that is used for changeover and changeover acknowledgement messages. China specifies a 16-bit field for data in changeover messages. The FSN occupies the first 12 bits. The trailing 4 bits are spare and are coded as 0. ITU uses a 24-bit field for data in the extended changeover/changeover acknowledgement messages. The FSN is encoded in the first 12 bits. The last 12 bits of the field are spare and are coded as zero.

The **randsls** parameter value applies to SCCP ITU-T messages and Class0 and ISUP ANSI messages when random SLS generation is set to occur on a per linkset basis (the **randsls=perls** parameter is specified in the **chg-stpopts** command).

If the **randsls=perls** parameter is specified in the **chg-stpopts** command, it is recommended that the linksets in a combined linkset be provisioned with the same **randsls** value to avoid undesired SLS distribution.

The value specified for the **ppc** parameter must be a full point code. Cluster point codes and private point codes are not supported.

Invalid point codes (ANSI network = 0) can be used for the adjacent point code of an IPGWx linkset. Private point codes (p-) can be used for either IPGWx linksets, as either adjacent point codes (**ent-ls:apc=xxx**) or internal point codes (**ent-rmt-appl:ipc=xxx**). Ordinary point codes can be used in all cases as APCs or IPCs.

If the ISLSBR feature is turned on, and Incoming SLS Bit Rotation is applied to an MSU, then the outgoing SLS bit rotation is not applied for that MSU. If the ISLSBR feature is turned off, or Incoming SLS Bit Rotation is not applied to an MSU, then the outgoing SLS bit rotation is applied for that MSU.

The valid ISLSRSB values for ITU link sets are **1–4** and for ANSI link sets are **1–8**.

The **randsls** parameter is applied on an incoming linkset for ANSI messages and on an outgoing linkset for ITU messages.

## Output

Adds linkset **lsa** using the GTT mode **fcdfcg** when the FLOBR feature is turned on.

```
ent-ls:lsn=lsa:lst=a:apca=1-1-1:gttmode=fcdfcg
tekelecstp 09-03-22 12:14:11 EST EAGLE 41.0.0
Link set table is (1 of 1024) 1% full.
ENT-LS: MASP A - COMPLTD
;
```

## ent-map

### Enter Mate Applications

Use this command to create new entries in the MAP table, which allow the assignment of mated applications and Alternate RI Mate searches for use with SCCP network management. A mated application is used if the local application becomes unavailable. An Alternate RI Mate is used if all mated applications within a MAP Set become unavailable or congested.

**NOTE: A MAP set is a logical grouping of a set of PC/SSNs that already exist in the EAGLE 5 ISS MAP table. The Flexible GTT Load Sharing (FGTTLS) feature allows a PC/SSN**

combination to be part of more than one load-sharing group, with each PC/SSN combination defined by a different MAP set.

**NOTE:** If the FGTTLS feature is enabled, then all existing entries in the MAP table and all existing GTA translations in the GTT table with *ri=ssn* are stored in default MAP sets. Additional MAP sets can be provisioned, and GTT entries can be associated to the MAP sets.

**NOTE:** The GTT Load Sharing with Alternate Routing Indicator (GTT LS ARI) feature must be enabled to provision Alternate RI Mates.

**Keyword:** ent-map

**Related Commands:** chg-map, dlt-map, rtrv-map

**Command Class:** Database Administration

### Parameters

**NOTE:** See "Point Code Formats and Conversion" for a detailed description of point code formats, rules for specification, and examples.

**:pc=** (mandatory)

ANSI point code with subfields *network indicator-network cluster-network cluster member (ni-nc-ncm)*.

**Synonym:** pca

**Range:** 000-255

Specify a valid value for each subfield of the point code, and separate the subfields with a dash (-).

When **chg-sid:pctype=ansi** is specified, *ni = 000* is not valid.

When **chg-sid:pctype=ansi** is specified, *nc = 000* is not valid if *ni = 001-005*.

When **chg-sid:pctype=ansi** is specified, *nc = 000* is valid if *ni = 006-255*.

The point code **000-000-000** is not a valid point code.

**:pc/pca/pci/pcn/pcn24=** (mandatory)

Primary remote point code.

**:pci=** (mandatory)

ITU international point code with subfields *zone-area-id*. The *prefix* subfield indicates a spare point code (*prefix-zone-area-id*).

**Range:** s-, 0-255

Specify a valid value for each subfield of the point code, and separate the subfields with a dash (-).

*prefix*—s-

*zone*—0-7

*area*—000-255

*id*—0-7

The point code **0-000-0** is not a valid point code.

**:pcn=** (mandatory)

ITU national point code in the format of a 5-digit number (*nnnnn*); or 2, 3, or 4 numbers (members) separated by dashes (*m1-m2-m3-m4*) as defined by the **chg-stpopts:npcfmti** flexible point code option. A group code must be specified when the ITUDUPPC feature is turned on (*nnnnn-gc*, *m1-m2-m3-m4-gc*). The *prefix* subfield indicates a spare point code (*prefix-nnnnn*, *prefix-nnnnn-gc*, *prefix-m1-m2-m3-m4*, *prefix-m1-m2-m3-m4-gc*).

**Range:** s-, 0-16383, aa-zz



Specify a valid value for each subfield of the point code, and separate the subfields with a dash (-).

*prefix*—**s-**

*n1-n2-n3-n4*—**0-16383**

*gc*—**aa-zz**

*m1-m2-m3-m4*—**0-14** for each member; values must sum to 14

**:pcn24=** (mandatory)

24-bit ITU national point code with subfields *main signaling area-sub signaling area-signaling point (msa-ssa-sp)*.

**Range:** **000-255**

Specify a valid value for each subfield of the point code, and separate the subfields with a dash (-).

*msa*—**000-255**

*ssa*—**000-255**

*sp*—**000-255**

**:ssn=** (mandatory)

Subsystem number. This parameter identifies the application's subsystem number. This attribute is composed of the decimal representation of the 1-byte field used in the SS7 protocol.

**Range:** **2-255**

**:grp=** (optional)

Concerned point code broadcast list (CSPC) group name. This parameter specifies the name of a group of point codes that should be notified of the subsystem status. A different CSPC group can be assigned to each mated PC/SSN. For ANSI, the EAGLE 5 ISS broadcasts SSP or SSA to the mate subsystem only if the mate's point code is provisioned as part of the CSPC group to receive an SSP or SSA. This parameter must be provisioned for a node if the node is to receive SSP or SSA broadcasts, even if the node is a mated application.

**Range:** *ayyyyyyy*

1 alphabetic character followed by up to 7 alphanumeric characters

**Default:** No broadcast list for this mated application.

**:mapset=** (optional)

MAP Set ID.

This parameter is mandatory when the Flexible GTT Loadsharing feature is enabled.

**Range:** **dflt, new**

**Default:** **dflt** - If the FGTTLS feature is not enabled, the default value is **dflt**.

**:materc=** (optional)

Mate relative cost. This parameter specifies the RC assigned to the mate PC/SSN that is being added to the entity set. The EAGLE 5 ISS determines the multiplicity mode based on the relative costs (the **rc** and **materc** parameters) of the subsystem.

**Range:** **0-99**

**Default:** **50**

**:mpc=** (optional)

ANSI point code with subfields *network indicator-network cluster-network cluster member (ni-ncm)*.

**Synonym:** **mpca**

**Range:** **000-255**

Specify a valid value for each subfield of the point code, and separate the subfields with a dash (-).

When **chg-sid:pctype=ansi** is specified, *ni* = **000** is not valid.

When **chg-sid:pctype=ansi** is specified, *nc* = **000** is not valid if *ni* = **001-005**.

When **chg-sid:pctype=ansi** is specified, *nc* = **000** is valid if *ni* = **006-255**.

The point code **000-000-000** is not a valid point code.

**Default:**     **000-000-000**

**:mpc/mpca/mpci/mpcn/mpcn24=** (optional)

Mate remote point code.

**:mpci=** (optional)

ITU international destination point code with subfields *zone-area-id*. The *prefix* subfield indicates a spare point code (*prefix-zone-area-id*).

**Range:**     **s-, 0-255**

Specify a valid value for each subfield of the point code, and separate the subfields with a dash (-).

*prefix*—**s-**

*zone*—**0-7**

*area*—**000-255**

*id*—**0-7**

The point code **0-000-0** is not a valid point code.

**Default:**     **0-000-0**

**:mpcn=** (optional)

ITU national point code with subfield ITU number (*nnnnn*). The *prefix* subfield indicates a spare point code.

**Range:**     **s-, 0-16383, aa-zz**

Specify a valid value for each subfield of the point code, and separate the subfields with a dash (-).

*prefix*—**s-**

*nnnnn*—**0-16383**

*gc*—**aa-zz**

*m1-m2-m3-m4*—**0-14** for each member; values must sum to 14

**Default:**     **00000**

**:mpcn24=** (optional)

24-bit ITU national point code with subfields *main signaling area-sub signaling area-signaling point* (*msa-ssa-sp*).

**Range:**     **000-255**

Specify a valid value for each subfield of the point code, and separate the subfields with a dash (-).

*msa*—**000-255**

*ssa*—**000-255**

*sp*—**000-255**

**Default:**     **000-000-000**

**:mrc=** (optional)

Message routing under congestion. This parameter defines the handling of Class 0 messages during congestion conditions.

This value can be provisioned in any of the multiplicity modes, but its value only affects traffic if the multiplicity mode is *DOM*. See the *Notes* section for more information on multiplicity modes.

**Range:**     **yes, no**  
**Default:**   **yes**—if ANSI  
               **no**—if ITU

**:mrnpc=** (optional)

ANSI point code with subfields *network indicator-network cluster-network cluster member (ni-nc-ncm)*.

**Synonym:** **mrnpca**

**Range:**     **000-255**

Specify a valid value for each subfield of the point code, and separate the subfields with a dash (-).

When **chg-sid:pctype=ansi** is specified, *ni* = **000** is not valid.

When **chg-sid:pctype=ansi** is specified, *nc* = **000** is not valid if *ni* = **001-005**.

When **chg-sid:pctype=ansi** is specified, *nc* = **000** is valid if *ni* = **006-255**.

The point code **000-000-000** is not a valid point code.

**Default:**   **000-000-000**

**:mrnpc\mrnpca\mrnpca\mrnpcn\mrnpcn24=** (optional)

Alternate RI Mate point code.

**:mrnpci=** (optional)

ITU international point code with subfields *zone-area-id*. The *prefix* subfield indicates a spare point code (*prefix-zone-area-id*).

**Range:**     **s-, 0-255**

Specify a valid value for each subfield of the point code, and separate the subfields with a dash (-).

*prefix*—**s-**

*zone*—**0-7**

*area*—**000-255**

*id*—**0-7**

The point code **0-000-0** is not a valid point code.

**Default:**   **0-000-0**

**:mrnpcn=** (optional)

ITU national point code with subfield ITU number (*nnnnn*). The *prefix* subfield indicates a spare point code.

**Range:**     **s-, 0-16383, aa-zz**

Specify a valid value for each subfield of the point code, and separate the subfields with a dash (-).

*prefix*—**s-**

*nnnnn*—**0-16383**

*gc*—**aa-zz**

*m1-m2-m3-m4*—**0-14** for each member; values must sum to 14

**Default:**   **00000**

**:mrnpcn24=** (optional)

24-bit ITU national point code with subfields *main signaling area-sub signaling area-signaling point (msa-ssa-sp)*.

**Range:**       **000-255**  
Specify a valid value for each subfield of the point code, and separate the subfields with a dash (-).

*msa*—**000-255**

*ssa*—**000-255**

*sp*—**000-255**

**Default:**     **000-000-000**

**:mrnset=** (optional)

Alternate RI Mate MRN Set ID. This parameter specifies the MRN Set where the Alternate RI Mate search is performed.

**Range:**       **1-6000 dflt**  
**dflt**—default MRN Set

If the **mrnpc** parameter is specified, and the **mrnset** parameter is not specified, then the value for the **mrnset** parameter is automatically set to **dflt**.

**:mssn=** (optional)

Mate subsystem number. This parameter specifies the mate application's subsystem number. This attribute is the decimal representation of the one-byte field used in the SS7 protocol.

**Range:**       **2-255**  
**Default:**     Parameter is not used

**:mwt=** (optional)

Mate point code weight. This parameter specifies the weight assigned to the mate PC/SSN that is being added to a weighted entity set. The Weighted GTT Loadsharing feature must be turned on before this parameter can be specified.

The **mwt** parameter can be specified only if the **wt** parameter is specified, and the **rc** parameter value equals the **materc** parameter value.

**Range:**       **1-99**

**:rc=** (optional)

Relative cost. The EAGLE 5 ISS determines the multiplicity mode based on the relative costs (the **rc** and **materc** parameters) of the subsystem. (See Notes for additional information on multiplicity modes.)

**Range:**       **0-99**  
**Default:**     **10**

**:srm=** (optional)

Subsystem routing messages. This parameter specifies whether subsystem routing messages (SBR, SNR) are transmitted between the mated applications.

This value can be provisioned in any of the multiplicity modes, but its value only affects traffic if the multiplicity mode is *DOM* or *COM*. See the *Notes* section for more information on multiplicity modes.

**Range:**       **yes, no**  
**Default:**     **yes**—if ANSI  
                  **no**—if ITU

**:sso=** (optional)

Subsystem status option. This parameter specifies whether or not the PC/SSN is to initiate a subsystem test when a RESUME is received for the PC.

**Range:**       **on, off**  
**Default:**     **off**

**:thr=** (optional)

Threshold. This parameter specifies the in-service threshold assigned to each PC/SSN in a weighted entity set or RC group. The Weighted GTT Loadsharing feature must be turned on before this parameter can be specified.

If the **thr** parameter is not specified, a value of **1%** is assigned to each weighted PC/SSN.

**Range: 1-100**

**:wt=** (optional)

Weight. This parameter specifies the weight assigned to the primary PC/SSN that is being added to the weighted entity set. The Weighted GTT Loadsharing feature must be turned on before this parameter can be specified.

The **wt** parameter can be specified only if the **mwt** parameter is specified, and the **rc** parameter value equals the **materc** parameter value.

**Range: 1-99**

### Example

As shown in the following example, the **rc** parameter is not required for a solitary pc/ssn pair. If the **rc** parameter is not specified, the relative cost defaults to 10.

```
ent-map:pc=1-1-1:ssn=10:grp=xyz
```

The following example enters both 1-1-0/10 and 1-1-1/10 into the map table. both the **rc** and **materc** parameter are required for this command, which defines a map group.

```
ent-
```

```
map:pc=1-1-0:ssn=10:rc=10:mpc=1-1-1:mssn=10:materc=20:grp=xyz:srm=on
```

The following example enters a solitary point code in the MAP table with the Subsystem Status Option (sso) set to on.

```
ent-map:pc=1-1-3:ssn=20:grp=abc:sso=on
```

The following commands enters a solitary point code in the MAP table with the Subsystem Status Option (sso) set to off.

```
ent-map:pc=2-2-2:ssn=20:grp=abc:sso=off
```

```
ent-map:pc=2-2-3:ssn=20:grp=abc
```

The following example sets the Subsystem Status Option (sso) set to on for the primary and mate.

```
ent-map:pc=1-1-4:ssn=10:rc=10:mpc=1-1-1:mssn=10:materc=20:sso=on
```

The following example sets the Subsystem Status Option (sso) set to off (default) for the primary and mate:

```
ent-map:pc=1-1-5:ssn=10:rc=10:mpc=1-1-2:mssn=10:materc=20:sso=off
```

The following command enters a solitary point code in the MAP table with the Subsystem Status Option (sso) set to off (the default).

```
ent-map:pc=1-1-6:ssn=10:rc=10:mpc=1-1-7:mssn=10:materc=20
```

The following example creates a new MAP Set with Alternate RI Mate 1-1-3/1.

```
ent-
```

```
map:pc=1-1-1:ssn=15:rc=10:mpc=1-1-2:mssn=25:materc=20:mapset=new:mrnset=1:mrnpc=1-1-3
```

The following example creates a new MAP set, and enters 1-1-1/10 and 1-1-2/20 into the newly created MAP set.

```
ent-
```

```
map:pc=1-1-1:ssn=10:rc=10:mpc=1-1-2:mssn=20:materc=20:mapset=new
```

The following example enters both 1-1-1/15 and 1-1-2/25 into the default MAP set.

```
ent-
map:pc=1-1-1:ssn=15:rc=10:mpc=1-1-2:mssn=25:materc=20:mapset=df1t
```

The following example creates a new MAP set and enters a solitary PC/SSN value of 1-1-1/10.

```
ent-map:pc=1-1-1:ssn=10:mapset=new
```

The following example enters a solitary PC/SSN of 1-1-1/15 into the default MAP set.

```
ent-map:pc=1-1-2:ssn=15:mapset=df1t
```

The following example creates a new MAP set and enters a solitary PC/SSN 1-1-1/10 with the subsystem option ON. It specifies the sso=on parameter for all instances of PC/SSN 1-1-4/10.

```
ent-map:pc=1-1-1:ssn=10:sso=on:mapset=new
```

The following example enters a solitary PC/SSN of 1-1-1/15 into the default MAP set with the subsystem option ON. The sso=on parameter is specified for all instances of PC/SSN 1-1-4/10.

```
ent-map:pc=1-1-3:ssn=15:sso=on:mapset=df1t
```

The following examples create a weighted shared PC/SSN pair.

```
ent-
map:pc=1-1-1:ssn=10:rc=20:wt=30:mpc=1-2-1:mssn=10:materc=20:mwt=20
```

```
ent-
map:pc=1-1-1:ssn=10:rc=20:wt=30:mpc=1-2-1:mssn=10:materc=20:mwt=20:thr=40
```

The following example creates a new MAP Set with a different ITU network type point code for the Alternate RI Mate PC.

```
ent-
map:pci=1-001-1:ssn=15:rc=10:mpci=1-001-2:mssn=25:materc=20:mapset=new:mrnpcn=00126:mrnset=2
```

## Dependencies

The PC/SSN pair cannot already exist in the MAP table.

The specified MPC/MSSN pair cannot already exist in the MAP table.

The **apca** and **pcn24** parameters cannot be specified for the same MAP set. The **pci** and **pcn** parameters cannot be specified for the same MAP set if the MAP set contains a true point code.

If a subsystem is configured for a SSN value in the SS-APPL table, then the specified MAP table entry for that subsystem must be a valid point code type for that subsystem. The following point code types are not valid for the indicated subsystems:

- If the subsystem number is configured for the INP subsystem in the SS-APPL table, then the True Point code cannot be an ITU-I or ANSI point code.
- If the subsystem number is configured for the EIR subsystem in the SS-APPL table, then the True Point code cannot be an ANSI point code.
- If the subsystem number is configured for the ATINPQ or VFLEX subsystem in the SS-APPL table, then the True Point code can not be an ITU-N24 point code.

If the ANSI-ITU-China SCCP Conversion feature is not turned on, the network type of the CPC broadcast group must match the network type of the PC. If the ANSI-ITU-China SCCP Conversion feature is turned on, network types of the CPC broadcast group and the PC network types do not have to match.

If the **pci**, **pcn**, or **pcn24** parameter is specified, then the **srn=yes** parameter cannot be specified.

The primary remote point code must already exist in the Route table, as a destination in the ordered route entity set, or in a cluster destination for which ordered routes are specified.

If a CSPC broadcast list group name is specified, it must already exist.

A maximum of 1024 unique remote point codes are allowed.

A maximum of 12 SSNs per remote point code can be entered.

The primary subsystem DPCs must be full point codes.

The mate subsystem DPCs must be full point codes.

The LNP or V-Flex feature must be turned on, or the ATINP feature must be enabled before a value that is a true point code can be specified for the **pca/mpca** parameter.

The AINPQ, EIR, INP, or V-Flex feature must be turned on, or the ATINP feature must be enabled before a value that is a true point code can be specified for the **pcn/mpcn** parameter.

The EIR or V-Flex feature must be turned on, or the ATINP feature must be enabled before a value that is a true point code can be specified for the **pci/mpci** parameter.

If the **mpc/mpca/mpci/mpcn/mpcn24** parameter is specified, then the value must exist in the Routing table.

If the **mssn** or **materc** parameter is specified, then the **mpc** parameter must be specified.

If the **pc** parameter value is an EAGLE 5 ISS true point code, the subsystem must have a lower relative cost than all other mated subsystems in the group.

The **sso** parameter cannot be specified with a point code value that is the system true point code.

A true point code cannot be routed to itself.

The **mpc** and **mssn** parameters cannot have the same values as the **pc** and **ssn** parameters.

The point code (**pc**) must already exist in the Concerned Point Code (CSPC) group.

The number of MPC Subsystem entries must not exceed the table capacity.

If the Flexible GTT Load Sharing feature is not enabled, then the **mapset** parameter cannot be specified. If the Flexible GTT Load Sharing feature is enabled, then the **mapset** parameter must be specified.

The EAGLE 5 ISS True PC can be provisioned only in the default MAP set.

The Weighted GTT Loadsharing feature must be turned on before the **wt**, **mwt**, or **thr** parameters can be specified.

If the **thr** parameter is specified, the **wt** and **mwt** parameters must be specified.

If the **mpc** parameter is specified, the **rc** parameter must be specified.

The **wt** and **mwt** parameters must be specified together in the same command.

If the **materc** parameter value equals the **rc** parameter value, a Loadshared Group is indicated, and the **rc**, **mpc** **materc**, and **mwt** parameters must be specified.

If the **chg-sid:pctype=ansi** command is entered, a value of *ni=000* cannot be specified. If the **chg-sid:pctype=ansi** command is entered, and a value of *ni=001 – 005* is specified, a value of *nc=000* cannot be specified

Both OAM cards must be running GPSM II.

If the **mpc** parameter value is a true point code, the subsystem must have a lower RC than all other mated subsystems in the entity set.

One or more point codes in the command will exceed the maximum number of entries in the MAP table.

The maximum number of possible entries in the MAP table has been reached for the specified True Point code.

**Table 5-54.** Here below is the maximum limit of True PCs entries

| True Point Code Type | Maximum limit in MAP table                                                                                 |
|----------------------|------------------------------------------------------------------------------------------------------------|
| ANSI                 | 1 (With LNP)<br>2 (With ATINPQ and V-FLEX)<br>(LNP is mutually exclusive with ATINPQ, EIR, INP, and VFLEX) |
| ITU-I                | 3 (For ATINPQ, EIR, and V-FLEX)                                                                            |
| ITU-N                | 4 (For ATINPQ, EIR, INP, and V-FLEX)                                                                       |

If the **mwt** parameter is specified, the **mpc** parameter must be specified.

If the **mpc** parameter is specified, the **mssn** and **materc** parameters must be specified.

The entity set being created must be either solitary or dominant to use the true point code as a point code.

If the **thr** parameter is specified, the **rc1**, **rc2**, **rc3**, and **rc4** parameters must be of equal value.

If the **mpc** parameter is specified, then the **mssn** parameter must be specified.

SRM=YES cannot be entered with ITU point codes.

If the **mpc** or **mssn** parameter is specified, then the **materc** parameter must be specified.

If the **pc/ssn** parameters and the **mpc/mssn** parameters are specified, then the **rc** parameter must be specified.

If the **pcn** or **mpcn** parameter is specified, then the format of the parameter must match the format dictated by the **chg-stpopts:npcfnti** command.

True PC cannot be routed to itself.

The Spare Point Code support feature must be enabled to allow provisioning of an ITU-I or ITU-N spare point code.

The True Point Code can be provisioned only in default MAPSET.

Unable to access database. Severe database failure.

Failed reading SS APPL table.

The values specified for the **pc** and **mpc** parameters cannot be associated with proxy point codes.

If the **mrnset** parameter is specified, then the **mrnpc** parameter must be specified.

The GTT LS ARI feature must be enabled before the **mrnset** or **mrnpc** parameters can be specified.

The value specified for the **mrnpc**, **mrnpca**, **mrnpci**, **mrnpcn**, or **mrnpcn24** parameter must be full point code.

The point codes and alternate RI Mate point codes must have the same network type. Table 5-24 displays the allowed PC and Alternate RI Mate PC combinations.

The value specified for the **mrnset** parameter must already exist in the MRN table.

The value specified for the **mrnpc** parameter must already exist in the specified MRN Set.

The **mrnset** parameter cannot be specified if the MAP Set specified by the **mapset** parameter contains a True Point Code.



## Notes

Up to 32 PC/SSN pairs can be entered into a mated PC/SSN group.

**Multiplicity Modes**

For the **-map** commands, an entity set consists of a group of PC/SSNs that are used for traffic distribution, and an RC group consists of PC/SSNs within an entity set that have the same RC. In loadsharing mode, an entity set contains 1 RC group. In combined loadsharing /dominant mode, an entity set can contain multiple loadsharing groups.

The EAGLE 5 ISS supports the following multiplicity modes for nodes/subsystems:

- When a PC/SSN pair is not replicated, the pair is in *solitary* (SOL) mode. The subsystem acts as the only application, with no backup. If this subsystem fails, messages routed to it are discarded and SCCP management returns “Subsystem Unavailable” messages to the originator.
- A group of replicated PC/SSN pairs are in *dominant* (DOM) mode if each PC/SSN pair in the group has a unique RC. The specified subsystem with the lowest RC acts as the primary subsystem, while the mate subsystem acts as a backup. In the event of congestion, messages route to the mate subsystem. When the congestion subsides, messages are again routed to the primary (dominant) subsystem.
- A group of replicated PC/SSN pairs are in *load sharing* (SHR) mode if each PC/SSN pair in the group has the same RC. All messages are evenly distributed at the SCCP level to all nodes/subsystems in the group. In the event of congestion or failure, the non-affected subsystem assumes the load of its failed or congested mate.
- The *combined load sharing/dominant* (COM) mode supports a combination of load sharing and dominant mode. A group of PC/SSN pairs are in combined load sharing/dominant mode when at least two of the PC/SSN pairs have the same RC and another node subsystem in the group has a different RC. A combination of node accessibility and RC determines the preferred PC/SSN.

If the XMAP feature is enabled, the MAP table can have up to either 2000 or 3000 entries, depending on the controlled feature Part Number that is enabled. If XMAP is not enabled, the MAP table can contain up to 1024 user entries.

The **sso** parameter changes the initialization of the subsystem status (“prohibited” or “allowed”) for PC/SSN MAP entries. The EAGLE 5 ISS previously marked the subsystem status “allowed” for each PC/SSN entry. The **sso** parameter marks the subsystem status “prohibited” for each new entry that has **sso=on**. This causes the EAGLE 5 ISS to generate an SST to the remote point-code when an MTP-RESUME is received. Upon reception of an SSA, the subsystem status is marked “allowed”.

When the ANSI-ITU-China SCCP Conversion feature is turned on, the Concerned Point Code (CSPC) Group’s network type can be of a different network than the mated application’s network type. For example, the mated application’s network type could be ANSI and the CSPC Group could be ITU or mixed with ANSI, ITU, and ITUN concerned point codes.

In this command, only ITU-international and ITU national point codes support the spare point code subtype prefix (s-).

When the Flexible GTT Load Sharing feature is on, MAP load sharing sets are supported. Each set is identified by the **mapset** parameter.

When the Weighted GTT Loadsharing feature is turned on, weighted entity sets and RC groups are supported, and threshold values can be assigned to each PC/SSN.

When the GTT Load Sharing with Alternate Routing Indicator feature is enabled, an Alternate RI Mate can be provisioned.

**Output**

```

ent-
map:pc=1-1-1:ssn=10:rc=10:mpc=1-1-2:mssn=20:materc=20:mapset=new
tekelecstp 08-10-22 11:22:28 EST EAGLE 39.0.0
ent-map:pc=1-1-1:ssn=10:rc=10:mpc=1-1-2:mssn=20:materc=20:mapset=new
Command entered at terminal #4.

New MAPSET Created : MAPSETID = 362
ENT-MAP: MASP A - COMPLTD
;

ent-map:pc=1-1-1:ssn=10:rc=10:mapset=dfmt:mrnset=1:mrnpc=1-1-2
tekelecstp 08-12-12 11:22:28 EST EAGLE 40.1.0
ent-map:pc=1-1-1:ssn=10:rc=10:mapset=dfmt:mrnset=1:mrnpc=1-1-2
Command entered at terminal #4.
ENT-MAP: MASP A - COMPLTD
;

ent-map:pc=1-1-1:ssn=100:rc=10:mrc=no:srm=no
tekelecstp 09-08-12 11:22:28 EST EAGLE 41.1.0
ent-map:pc=1-1-1:ssn=100:rc=10:mrc=no:srm=no
Command entered at terminal #4.
CAUTION: THE VALUE OF SRM IS EFFECTIVE WHEN MULT IS COM OR DOM AND
THE VALUE OF MRC IS EFFECTIVE WHEN MULT IS DOM.
ENT-MAP: MASP A - COMPLTD
;

```

**ent-mrn****Enter Mated Relay Node**

Use this command to assign point codes and Alternate RI Mates in the Mated Relay Node (MRN) table. The Intermediate GTT Loadsharing feature must be on before this command can be entered. The GTT Load Sharing with Alternate Routing Indicator (GTT LS ARI) feature must be enabled to provision Alternate RI Mates.

If the Flexible GTT Loadsharing feature is enabled, use this command to create a new MRN set, or to add entries to an existing MRN set in the MRN table. If the Flexible GTT Loadsharing feature is turned on, then MRN sets are used.

**NOTE: If only the Intermediate GTT Loadsharing feature is turned on, the MRN table can contain a maximum of 3000 entries. If the Intermediate GTT Loadsharing feature is on and the Flexible GTT Loadsharing feature is enabled, the MRN table can contain a maximum of 6000 entries.**



**CAUTION: If any entries are provisioned in the SCCP-SERV table, the maximum number of entries that the MRN table can contain is reduced by that amount. Check the rtrv-sccp-serv command output to see if entries exist in the SCCP-SERV table.**

**NOTE: An MRN set is a logical grouping of PCs that already exist in the EAGLE 5 ISS MRN table. The Intermediate GTT Loadsharing feature allows PCs to be part of more than one load-sharing group, with each PC defined by a different MRN set. If the Intermediate GTT Loadsharing feature is enabled, then all existing entries in the MRN table and all existing GTA translations in the GTT table with ri=gt are stored in default MRN sets. Additional MRN sets can be provisioned, and GTT entries can be associated to the MRN sets.**

**Keyword:** ent-mrn

**Related Commands:** chg-mrn, dlt-mrn, rtrv-mrn

**Command Class:** Database Administration

## Parameters

**NOTE: See "Point Code Formats and Conversion" for a detailed description of point code formats, rules for specification, and examples.**

If a point code is being added to an existing weighted entity set, and the **dflwt** parameter is not specified, the **wt1/wt2/wt3/wt4** parameter must be specified.

The **wt1/wt2/wt3/wt4** parameter can only be specified if at least two of the **rc/rc1/rc2/rc3/rc4** parameters are equal, creating a weighted entity set.

**:pc=** (mandatory)

ANSI point code with subfields *network indicator-network cluster-network cluster member (ni-nc-ncm)*.

**Synonym:** **pca**

**Range:** **000-255**

Specify a valid value for each subfield of the point code, and separate the subfields with a dash (-).

When **chg-sid:pctype=ansi** is specified, *ni = 000* is not valid.

When **chg-sid:pctype=ansi** is specified, *nc = 000* is not valid if *ni = 001-005*.

When **chg-sid:pctype=ansi** is specified, *nc = 000* is valid if *ni = 006-255*.

The point code **000-000-000** is not a valid point code.

**:pc/pca/pci/pcn/pcn24=** (mandatory)

Post-GTT-translated point code.

**:pci=** (mandatory)

ITU international point code with subfields *zone-area-id*. The *prefix* subfield indicates a spare point code (*prefix-zone-area-id*).

**Range:** **s-, 0-255**

Specify a valid value for each subfield of the point code, and separate the subfields with a dash (-).

*prefix—s-*

*zone—0-7*

*area—000-255*

*id—0-7*

The point code **0-000-0** is not a valid point code.

**:pcn=** (mandatory)

ITU national point code in the format of a 5-digit number (*nnnnn*); or 2, 3, or 4 numbers (members) separated by dashes (*m1-m2-m3-m4*) as defined by the **chg-stpopts:npcfmti** flexible point code option. A group code must be specified when the ITUDUPPC feature is turned on (*nnnnn-gc*, *m1-m2-m3-m4-gc*). The *prefix* subfield indicates a spare point code (*prefix-nnnnn*, *prefix-nnnnn-gc*, *prefix-m1-m2-m3-m4*, *prefix-m1-m2-m3-m4-gc*).

**Range:** **s-, 0-16383, aa-zz**

Specify a valid value for each subfield of the point code, and separate the subfields with a dash (-).

*prefix—s-*

*nnnnn—0-16383*

*gc—aa-zz*

*m1-m2-m3-m4—0-14* for each member; values must sum to 14

**:pcn24=** (mandatory)

24-bit ITU national point code with subfields *main signaling area-sub signaling area-signaling point* (*msa-ssa-sp*).

**Range:**     **000-255**

Specify a valid value for each subfield of the point code, and separate the subfields with a dash (-).

*msa*—**000–255**

*ssa*—**000–255**

*sp*—**000–255**

**:dfitwt=** (optional)

Default weight. This parameter specifies the weight to be assigned to a specified PC that is not assigned a weight with the **wt/wt1/wt2/wt3/wt4** parameter.

If a PC weight is specified with the **wt/wt1/wt2/wt3/wt4** parameter and the **dfitwt** parameter is specified, the default weight is ignored, and the PC is assigned the weight specified by its respective weight parameter.

**Range:**     **1-99**

**:mappc=** (optional)

ANSI point code with subfields *network indicator-network cluster-network cluster member* (*ni-nc-ncm*).

**Synonym:** **mappca**

**Range:**     **000-255**

Specify a valid value for each subfield of the point code, and separate the subfields with a dash (-).

When **chg-sid:pctype=ansi** is specified, *ni* = **000** is not valid.

When **chg-sid:pctype=ansi** is specified, *nc* = **000** is not valid if *ni* = **001–005**.

When **chg-sid:pctype=ansi** is specified, *nc* = **000** is valid if *ni* = **006–255**.

The point code **000-000-000** is not a valid point code.

**Default:**   **000-000-000**

**:mappc\mappca\mappci\mappcn\mappcn24=** (optional)

Alternate RI Mate point code.

**:mappci=** (optional)

ITU international point code with subfields *zone-area-id*. The *prefix* subfield indicates a spare point code (*prefix-zone-area-id*).

**Range:**     **s-, 0-255**

Specify a valid value for each subfield of the point code, and separate the subfields with a dash (-).

*prefix*—**s-**

*zone*—**0-7**

*area*—**000-255**

*id*—**0-7**

The point code **0-000-0** is not a valid point code.

**Default:**   **0-000-0**

**:mappcn=** (optional)

ITU national point code in the format of a 5-digit number (*nnnnn*); or 2, 3, or 4 numbers (members) separated by dashes (*m1-m2-m3-m4*) as defined by the **chg-stpopts:npcfmti** flexible point code option. A group code must be specified when the ITUDUPPC feature is turned on (*nnnnn-gc*, *m1-m2-m3-m4-gc*). The *prefix* subfield indicates a spare point code (*prefix-nnnnn*, *prefix-nnnnn-gc*, *prefix-m1-m2-m3-m4*, *prefix-m1-m2-m3-m4-gc*).

**Range:** **s-, 0-16383, aa-zz**

Specify a valid value for each subfield of the point code, and separate the subfields with a dash (-).

*prefix*—s-

*nnnnn*—0-16383

*gc*—aa-zz

*m1-m2-m3-m4*—0-14 for each member; values must sum to 14

**Default:** **00000**

**:mappcn24=** (optional)

24-bit ITU national point code with subfields *main signaling area-sub signaling area-signaling point* (*msa-ssa-sp*).

**Range:** **000-255**

Specify a valid value for each subfield of the point code, and separate the subfields with a dash (-).

*msa*—000-255

*ssa*—000-255

*sp*—000-255

**Default:** **000-000-000**

**:mapset=** (optional)

Alternate RI Mate MAP Set ID. This parameter specifies the MAP Set where the Alternate RI Mate search is performed.

**Range:** **1-36000 dflt**

**dflt**—default MAP Set

If the **mappc** and **mapssn** parameters are specified, and the **mapset** parameter is not specified, then the **mapset** parameter is automatically set to a value of **dflt**.

**:mapssn=** (optional)

Alternate RI Mate subsystem number.

**Range:** **2-255 \*, none**

**Default:** **none**

**:mrnset=** (optional)

MRN set ID.

**Range:** **1-3000 dflt, new**

**dflt**—Default MRN set.

**new**—Create a new MRN set

**:pc1=** (optional)

ANSI point code with subfields *network indicator-network cluster-network cluster member* (*ni-nc-ncm*).

**Synonym:** **pca1**

**Range:** **000-255**

Specify a valid value for each subfield of the point code, and separate the subfields with a dash (-).

When **chg-sid:pctype=ansi** is specified, *ni* = **000** is not valid.

When **chg-sid:pctype=ansi** is specified, *nc* = **000** is not valid if *ni* = **001–005**.

When **chg-sid:pctype=ansi** is specified, *nc* = **000** is valid if *ni* = **006–255**.

The point code **000-000-000** is not a valid point code.

**:pc1/pca1/pci1/pcn1/pcn241=** (optional)

Alternate post-GTT-translated point code.

**:pc2=** (optional)

ANSI point code with subfields *network indicator-network cluster-network cluster member (ni-nc-ncm)*.

**Synonym:** **pca2**

**Range:** **000-255**

Specify a valid value for each subfield of the point code, and separate the subfields with a dash (-).

When **chg-sid:pctype=ansi** is specified, *ni* = **000** is not valid.

When **chg-sid:pctype=ansi** is specified, *nc* = **000** is not valid if *ni* = **001–005**.

When **chg-sid:pctype=ansi** is specified, *nc* = **000** is valid if *ni* = **006–255**.

The point code **000-000-000** is not a valid point code.

**:pc2/pca2/pci2/pcn2/pcn242=** (optional)

Alternate post-GTT-translated point code.

**:pc3=** (optional)

ANSI point code with subfields *network indicator-network cluster-network cluster member (ni-nc-ncm)*.

**Synonym:** **pca3**

**Range:** **000-255**

Specify a valid value for each subfield of the point code, and separate the subfields with a dash (-).

When **chg-sid:pctype=ansi** is specified, *ni* = **000** is not valid.

When **chg-sid:pctype=ansi** is specified, *nc* = **000** is not valid if *ni* = **001–005**.

When **chg-sid:pctype=ansi** is specified, *nc* = **000** is valid if *ni* = **006–255**.

The point code **000-000-000** is not a valid point code.

**:pc3/pca3/pci3/pcn3/pcn243=** (optional)

Alternate post-GTT-translated point code.

**:pc4=** (optional)

ANSI point code with subfields *network indicator-network cluster-network cluster member (ni-nc-ncm)*.

**Synonym:** **pca4**

**Range:** **000-255**

Specify a valid value for each subfield of the point code, and separate the subfields with a dash (-).

When **chg-sid:pctype=ansi** is specified, *ni* = **000** is not valid.

When **chg-sid:pctype=ansi** is specified, *nc* = **000** is not valid if *ni* = **001–005**.

When **chg-sid:pctype=ansi** is specified, *nc* = **000** is valid if *ni* = **006-255**.  
The point code **000-000-000** is not a valid point code.

**:pc4/pca4/pci4/pcn4/pcn244=** (optional)

Alternate post-GTT-translated point code.

**:pci1=** (optional)

ITU international point code with subfields *zone-area-id*. The *prefix* subfield indicates a spare point code, (*prefix-zone-area-id*).

**Range:** **s-, 0-255**

Specify a valid value for each subfield of the point code, and separate the subfields with a dash (-).

*prefix*—**s-**

*zone*—**0-7**

*area*—**000-255**

*id*—**0-7**

The point code **0-000-0** is not a valid point code.

**:pci2=** (optional)

ITU international point code with subfields *zone-area-id*. The *prefix* subfield indicates a spare point code (*prefix-zone-area-id*).

**Range:** **s-, 0-255**

Specify a valid value for each subfield of the point code, and separate the subfields with a dash (-).

*prefix*—**s-**

*zone*—**0-7**

*area*—**000-255**

*id*—**0-7**

The point code **0-000-0** is not a valid point code.

**:pci3=** (optional)

ITU international point code with subfields *zone-area-id*. The *prefix* subfield indicates a spare point code (*prefix-zone-area-id*).

**Range:** **s-, 0-255**

Specify a valid value for each subfield of the point code, and separate the subfields with a dash (-).

*prefix*—**s-**

*zone*—**0-7**

*area*—**000-255**

*id*—**0-7**

The point code **0-000-0** is not a valid point code.

**:pci4=** (optional)

ITU international point code with subfields *zone-area-id*. The *prefix* subfield indicates a spare point code (*prefix-zone-area-id*).

**Range:** **s-, 0-255**

Specify a valid value for each subfield of the point code, and separate the subfields with a dash (-).

*prefix*—s-  
*zone*—0-7  
*area*—000-255  
*id*—0-7

The point code **0-000-0** is not a valid point code.

**:pcn1=** (optional)

ITU national point code in the format of a 5-digit number (*nnnnn*); or 2, 3, or 4 numbers (members) separated by dashes (*m1-m2-m3-m4*) as defined by the **chg-stpopts:npcfmti** flexible point code option. A group code must be specified when the ITUDUPPC feature is turned on (*nnnnn-gc*, *m1-m2-m3-m4-gc*). The *prefix* subfield indicates a spare point code (*prefix-nnnnn*, *prefix-nnnnn-gc*, *prefix-m1-m2-m3-m4*, *prefix-m1-m2-m3-m4-gc*).

**Range:** s-, 0-16383, aa-zz

Specify a valid value for each subfield of the point code, and separate the subfields with a dash (-).

*prefix*—s-  
*nnnnn*—0-16383  
*gc*—aa-zz  
*m1-m2-m3-m4*—0-14 for each member; values must sum to 14

**:pcn2=** (optional)

ITU national point code in the format of a 5-digit number (*nnnnn*); or 2, 3, or 4 numbers (members) separated by dashes (*m1-m2-m3-m4*) as defined by the **chg-stpopts:npcfmti** flexible point code option. A group code must be specified when the ITUDUPPC feature is turned on (*nnnnn-gc*, *m1-m2-m3-m4-gc*). The *prefix* subfield indicates a spare point code (*prefix-nnnnn*, *prefix-nnnnn-gc*, *prefix-m1-m2-m3-m4*, *prefix-m1-m2-m3-m4-gc*).

**Range:** s-, 0-16383, aa-zz

Specify a valid value for each subfield of the point code, and separate the subfields with a dash (-).

*prefix*—s-  
*nnnnn*—0-16383  
*gc*—aa-zz  
*m1-m2-m3-m4*—0-14 for each member; values must sum to 14

**:pcn241=** (optional)

24-bit ITU national point code with subfields *main signaling area-sub signaling area-signaling point* (*msa-ssa-sp*).

**Range:** 000-255

Specify a valid value for each subfield of the point code, and separate the subfields with a dash (-).

*msa*—000-255  
*ssa*—000-255  
*sp*—000-255

**:pcn242=** (optional)

24-bit ITU national point code with subfields *main signaling area-sub signaling area-signaling point* (*msa-ssa-sp*).

**Range:** 000-255

Specify a valid value for each subfield of the point code, and separate the subfields with a dash (-).



*msa*—**000–255**

*ssa*—**000–255**

*sp*—**000–255**

**:pcn243=** (optional)

24-bit ITU national point code with subfields *main signaling area-sub signaling area-signaling point* (*msa-ssa-sp*).

**Range:** **000-255**

Specify a valid value for each subfield of the point code, and separate the subfields with a dash (-).

*msa*—**000–255**

*ssa*—**000–255**

*sp*—**000–255**

**:pcn244=** (optional)

24-bit ITU national point code with subfields *main signaling area-sub signaling area-signaling point* (*msa-ssa-sp*).

**Range:** **000-255**

Specify a valid value for each subfield of the point code, and separate the subfields with a dash (-).

*msa*—**000–255**

*ssa*—**000–255**

*sp*—**000–255**

**:pcn3=** (optional)

ITU national point code in the format of a 5-digit number (*nnnnn*); or 2, 3, or 4 numbers (members) separated by dashes (*m1-m2-m3-m4*) as defined by the **chg-stpopts:npcfmti** flexible point code option. A group code must be specified when the ITUDUPPC feature is turned on (*nnnnn-gc*, *m1-m2-m3-m4-gc*). The *prefix* subfield indicates a spare point code (*prefix-nnnnn*, *prefix-nnnnn-gc*, *prefix-m1-m2-m3-m4*, *prefix-m1-m2-m3-m4-gc*).

**Range:** **s-, 0-16383, aa-zz**

Specify a valid value for each subfield of the point code, and separate the subfields with a dash (-).

*prefix*—**s-**

*nnnnn*—**0-16383**

*gc*—**aa-zz**

*m1-m2-m3-m4*—**0-14** for each member; values must sum to 14

**:pcn4=** (optional)

ITU national point code in the format of a 5-digit number (*nnnnn*); or 2, 3, or 4 numbers (members) separated by dashes (*m1-m2-m3-m4*) as defined by the **chg-stpopts:npcfmti** flexible point code option. A group code must be specified when the ITUDUPPC feature is turned on (*nnnnn-gc*, *m1-m2-m3-m4-gc*). The *prefix* subfield indicates a spare point code (*prefix-nnnnn*, *prefix-nnnnn-gc*, *prefix-m1-m2-m3-m4*, *prefix-m1-m2-m3-m4-gc*).

**Range:** **s-, 0-16383, aa-zz**

Specify a valid value for each subfield of the point code, and separate the subfields with a dash (-).

*prefix*—**s-**

*nnnnn*—**0-16383**

*gc*—**aa-zz**

*m1-m2-m3-m4*—**0-14** for each member; values must sum to 14

**:rc=** (optional)

Relative cost. This parameter specifies the relative cost of the route for the primary PC.

**Range:** 0-99

**:rc1=** (optional)

Relative cost 1. This parameter specifies the relative cost of the route for mate PC 1.

**Range:** 0-99

**:rc2=** (optional)

Relative cost 2. This parameter specifies the relative cost of the route for mate PC 2.

**Range:** 0-99

**:rc3=** (optional)

Relative cost 3. This parameter specifies the relative cost of the route for mate PC 3.

**Range:** 0-99

**:rc4=** (optional)

Relative cost 4. This parameter specifies the relative cost of the route for mate PC 4.

**Range:** 0-99

**:thr=** (optional)

Threshold. This parameter specifies the in-service threshold of all PCs in a weighted entity set or RC group. The Weighted GTT Loadsharing feature must be turned on before this parameter can be specified.

If a threshold value is not specified when creating a new RC group in an existing entity set, the new RC group is assigned a threshold value of 1%.

**Range:** 1-100

**:wt=** (optional)

Weight. This parameter specifies the weight assigned to the primary PC. The Weighted GTT Loadsharing feature must be turned on before this parameter can be specified.

If PCs are being added to an existing entity set, the **wt** parameter cannot be specified. If a new entity set is being created, the **wt** parameter can only be specified if at least two of the specified RC values are equal, which creates a weighted entity set.

**Range:** 1-99

**:wt1=** (optional)

Weight 1. This parameter specifies the weight assigned to the mate PC 1 that is being added to the weighted entity set. The Weighted GTT Loadsharing feature must be turned on before this parameter can be specified.

**Range:** 1-99

**:wt2=** (optional)

Weight 2. This parameter specifies the weight assigned to the mate PC 2 that is being added to the weighted entity set. The Weighted GTT Loadsharing feature must be turned on before this parameter can be specified.

**Range:** 1-99

**:wt3=** (optional)

Weight 3. This parameter specifies the weight assigned to the mate PC 3 that is being added to the weighted entity set. The Weighted GTT Loadsharing feature must be turned on before this parameter can be specified.

**Range:** 1-99

**:wt4=** (optional)

Weight 4. This parameter specifies the weight assigned to the mate PC 4 that is being added to the weighted entity set. The Weighted GTT Loadsharing feature must be turned on before this parameter can be specified.

**Range:** 1-99

### Example

The following example enters point code 1-1-0 into the MRN table with a relative cost of 10 and associates point code 1-1-1 with it as a point code with a relative cost of 20.

```
ent-mrn:pc=1-1-0:rc=10:pc1=1-1-1:rc1=20
```

The following example updates the group containing point code 1-1-0 in the MRN table, to add point code 1-1-2 with relative cost of 20 and point code 1-1-10 with relative cost of 30 to the group.

```
ent-mrn:pc=1-1-0:rc=10:pc1=1-1-1:rc1=20:pc2=1-1-10:rc2=30
```

The following examples include spare point codes.

```
ent-mrn:pci=s-2-2-1:rc=10:pci1=s-2-2-2:rc1=11:pci2=2-100-1:rc2=12
```

```
ent-mrn:pcn=s-1-1-1-123-aa:rc=1:pcn1=1-1-1-235-
```

```
aa:rc1=2:pcn2=s-1-1-1-235-aa:rc2=3
```

```
ent-mrn:pc=1-1-1:rc=10:pc1=1-1-2:rc1=10:mrnset=df1t
```

```
ent-
```

```
mrn:pc=1-1-1:rc=10:pc1=1-1-2:rc1=20:pc2=1-1-3:rc2=30:apc3=1-1-4:r  
c3=40:apc4=1-1-5:rc4=50:mrnset=new
```

```
ent-mrn:pc=1-1-3:pc1=1-1-6:rc1=60:pc2=1-1-7:rc2=70:mrnset=111
```

The following examples create a new weighted entity set.

```
ent-mrn:pc=1-1-0:rc=10:wt=30:pc1=1-1-1:rc1=10:wt1=10
```

```
ent-mrn:pc=1-1-0:rc=10:wt=30:pc1=1-1-1:rc1=10:wt1=10:thr=50
```

```
ent-
```

```
mrn:pc=1-1-0:rc=10:pc1=1-1-1:rc1=10:pc2=1-3-2:rc2=20:wt2=30:pc3=1  
-10-2:rc3=20:dfltw=20
```

```
ent-
```

```
mrn:pc=1-1-0:rc=10:pc1=1-1-1:rc1=10:wt1=30:pc2=1-3-2:rc2=10:dfltw  
t=20:thr=60
```

```
ent-
```

```
mrn:pc=1-1-0:pc1=2-2-2:rc1=20:pc2=1-1-10:rc2=30:pc3=1-3-2:rc3=10:  
wt3=20:dfltw=30
```

```
ent-
```

```
mrn:pc=1-1-0:pc1=2-2-2:rc1=20:wt1=10:pc2=1-1-10:rc2=20:wt2=40:thr  
=30
```

```
ent-
```

```
mrn:pc=1-1-0:pc1=2-2-2:rc1=20:wt1=40:pc2=1-1-10:rc2=20:pc3=1-3-2:  
rc3=20:dfltw=25:thr=30
```

```
ent-mrn:pc=1-1-0:pc1=2-2-2:rc1=20:wt1=10:pc2=1-1-10:rc2=30:wt2=40
```

```
ent-
```

```
mrn:pc=1-1-0:rc=10:pc1=1-1-1:rc1=20:pc2=1-1-10:rc2=30:mapset=1:ma  
ppc=2-1-1:mapssn=*
```

```
ent-
mrn:pc=1-1-0:rc=10:pc1=1-1-1:rc1=20:pc2=1-1-10:rc2=30:mappc=2-1-1
:mapssn=*
ent-
mrn:pci=1-001-0:rc=10:pci1=1-001-1:rc1=20:pci2=1-001-10:rc2=30:ma
pset=1:mappcn=00126:mapssn=12
```

## Dependencies

The Intermediate Global Title Translation Loadsharing feature must be turned on before this command can be entered.

The **apca** and **pcn24** parameters cannot be specified for the same MRN set.

When a point code parameter is specified, its relative cost parameter must be specified.

Point codes cannot have the same value as the EAGLE 5 ISS SID.

The same point code value cannot be entered more than once in the MRN table.

ITU-N point codes must be in the format set by the **npcfnti** parameter of the **chg-stpopts** command. (Use the **rtvr-stpopts** command to display the STP option settings.)

Remote point codes must already exist as destinations in the Ordered Route entity set or reside in a cluster destination for which ordered routes are specified.

One or more point codes in the command will exceed the maximum number of point codes that can be entered into the MRN table (3000 if the IGTTLS feature is turned on and 6000 if the IGTTLS and FGTTLS features are turned on)..

The Flexible GTT Load-Sharing feature must be enabled before the **mrnset** parameter can be specified.

If the Flexible GTT Loadsharing feature is enabled, then the specified PC must already exist in the specified MRN set.

The specified MRN set must already exist in the MRN table.

When creating a new weighted entity set, the **mrnset=new** or **mrnset=dflt** parameter must be specified.

Each point code group can contain a maximum of 32 point codes.

The Weighted GTT Loadsharing feature must be turned on before the **wt/wt1/wt2/wt3/wt4**, **thr**, and **dflwt** parameters can be specified.

If the **wt/wt1/wt2/wt3/wt4** parameter is specified, the corresponding **pc/pc1/pc2/pc3/pc4** parameter must be specified.

When creating or modifying a weighted entity set, the **dflwt** parameter must be specified, or an individual weight must be specified for each PC.

Entity sets in a solitary or dominant loadsharing mode cannot have weights assigned to the PCs. When creating an entity set, if all of the RC values are unique, the **wt/wt1/wt2/wt3/wt4** and **thr** parameters cannot be specified.

If the **thr** parameter is specified, the **rc1**, **rc2**, **rc3**, and **rc4** parameters must be of equal value.

If the **thr** parameter is specified, the associated **wt/wt1/wt2/wt3/wt4** parameter or the **dflwt** parameter must be specified.

At least one additional point code must be specified.

Any specified point code must be a full point code.

If the **chg-sid:pctype=ansi** command is entered, a value of *ni=000* cannot be specified. If the **chg-sid:pctype=ansi** command is entered, and a value of *ni=001 – 005* is specified, a value of *nc=000* cannot be specified

If a new point code is being added to the MRN table, the **pc** and **rc** parameters must be specified together in the command. If the Flexible GTT Loadsharing feature is enabled, and the **mrnset=new** parameter is specified, the **pc** and **rc** parameters must be specified together in the command.

If the **pc1/pc2/pc3/pc4** parameter is specified, the **pc** parameter value must already exist in the MRN table.

A new point code that is specified in the command must not already exist in the MRN table.

If the **rc** parameter is not specified, the **wt** parameter cannot be specified.

If PCs are being added to a weighted entity set, the **wt/wt1/wt2/wt3/wt4** parameter or the **dflwt** parameter must be specified.

If PCs are being added to a non-weighted entity set, the **wt/wt1/wt2/wt3/wt4** and the **dflwt** parameters cannot be specified.

At least one optional parameter must be specified.

If the **wt/wt1/wt2/wt3/wt4** parameters are specified, the **dflwt** parameter cannot be specified.

The value specified for the **pc/pc1/pc2/pc3/pc4** parameter cannot be associated with a proxy point code.

The GTT LS ARI feature must be enabled before the **mapset**, **mappc**, or **mapssn** parameter can be specified.

The value specified for the **mappc**, **mappca**, **mappci**, **mappcn**, or **mappcn24** parameter must be full point code.

The point codes and alternate RI Mate point codes must have the same network type. Table 5-24 displays the allowed PC and Alternate RI Mate PC combinations.

The specified MAPSET must already exist in the MAP table.

If the **mapset** parameter is specified, then the **mappc** and **mapssn** parameters must be specified.

The **mappc** and **mapssn** parameters must be specified together in the command.

The values specified for the **mappc** and **mapssn** parameters must already exist in the specified MAP Set.

The values specified for the **mapset** and **mappc** parameters must already exist in the MAP table.

The value specified for the **mappc** parameter cannot match an STP point code.

The **ent-mrn** command cannot be used to change an Alternate RI Mate that has already been specified for an MRN Set. Use the **chg-mrn** command to modify the Alternate RI Mate.

## Notes

For the **-mrn** commands, an entity set consists of a group of PCs that are used for traffic distribution, and an RC group consists of PCs within an entity set that have the same RC. In loadsharing mode, an entity set contains 1 RC group. In combined/dominant loadsharing mode, an entity set can contain multiple loadsharing groups.

The EAGLE 5 ISS supports the following modes for nodes and subsystems:

- A group of replicated PCs are in *dominant* mode if each PC in the group has a unique RC. The specified subsystem with the lowest RC acts as the primary subsystem, while the mate subsystem acts as a backup. In the event of congestion, messages route to the mate subsystem. When the congestion subsides, messages are again routed to the primary (dominant) subsystem.
- A group of replicated PCs are in *load sharing* mode if each PC in the group has the same RC. All messages are evenly distributed at the SCCP level to all nodes/subsystems in the group.

In the event of congestion or failure, the non-affected subsystem assumes the load of its failed or congested mate.

- The *combined load sharing/dominant* mode supports a combination of load sharing and dominant mode. A group of PCs are in combined load sharing/dominant mode when at least two of the PCs have the same RC and another node subsystem in the group has a different RC. A combination of node accessibility and RC determines the preferred PC.

The **ent-mrn** command cannot be used to change the relative cost value for a point code; the **chg-mrn** command must be used.

In this command, only ITU-international and ITU national point codes support the spare point code subtype prefix (s-).

If the **ent-mrn** command is used to add PCs to an existing weighted entity set, and the threshold is specified, all RC group values specified with **rc**, **rc1**, **rc2**, **rc3** and **rc4** parameters for the alternate post-GTT-translated point codes must be equal.

The following rules apply when the **ent-mrn** command is used to add PCs to RC groups:

- If a threshold value is specified and the PCs are being added to an existing RC group in the existing entity set, the RC group threshold is changed to the specified threshold value and both pre-existing and new PCs in the RC group assume the new threshold value.
- If a threshold value is specified and the PCs are creating a new RC group in the existing entity set, the new RC group assumes the specified threshold value.
- If a threshold value is not specified and the PCs are being added to an existing RC group in the existing entity set, the RC group threshold does not change and the PC assumes the threshold value of the existing RC group.

When the Weighted GTT Loadsharing feature is turned on, weighted entity sets and RC groups are supported, and threshold values can be assigned to each PC.

Entries cannot be provisioned in the MRN table unless routes are also provisioned for corresponding point codes. However, an entry without a configured route may result from upgrading to a new EAGLE 5 ISS release. If such an entry occurs, then traffic will not be routed to the corresponding point code. The entry can be deleted, or a route for the entry can be configured.

When a node is marked congested in the MRN or MAP table, traffic continues to be routed to that node. When the congested node becomes prohibited, traffic is diverted to another node.

**Output**

```

ent-
mrn:pc=1-1-1:rc=10:pc1=1-1-2:rc1=20:pc2=1-1-3:rc2=30:apc3=1-1-4:r
c3=40:apc4=1-1-5:rc4=50:mrnset=new
tekelecstp 09-01-04 12:59:14 EST EAGLE 40.1.0
ent-
mrn:pc=1-1-1:rc=10:pc1=1-1-2:rc1=20:pc2=1-1-3:rc2=30:apc3=1-1-4:rc3=40:apc4=1-1-
5:rc4=50:mrnset=new
Command entered at terminal #4.

New MRNSET Created : MRNSETID = 112
ENT-MRN : MASP A - COMPLTD
;

ent-
mrn:pc=1-1-0:rc=10:pc1=1-1-1:rc1=10:mrnset=dflt:mapset=dflt:mappc
=1-1-2:mapssn=10
tekelecstp 09-01-04 12:15:32 EST EAGLE 40.1.0
ent-
mrn:pc=1-1-0:rc=10:pc1=1-1-1:rc1=10:mrnset=dflt:mapset=dflt:mappc=1-1-2:mapssn=1
0
Command entered at terminal #4.
ENT-MRN : MASP A - COMPLTD
;

```

**ent-na****Enter Network Appearance**

Use this command to enter a new network appearance in the Network Appearance table.

**Keyword:** ent-na

**Related Commands:** dlt-na, rtrv-na

**Command Class:** Database Administration

**Parameters**

**:na=** (mandatory)  
Network appearance.  
**Range:** 0-4294967295

**:type=** (mandatory)  
Type of the network appearance.  
**Range:** ansi, itui, ituis, itun, ituns, itun24

**:gc=** (optional)  
Group Code of the network appearance.  
**Range:** yy

**Example**

```

ent-na:type=ansi:na=10
ent-na:type=itui:na=11
ent-na:type=itun:na=10
ent-na:type=itun:na=11:gc=fr
ent-na:type=itun24:na=3
ent-na:type=ituis:na=4

```

**Dependencies**

The network appearance (**na**) must not already exist in the Network appearance table.

The Network Appearance table can contain a maximum of 45 entries.

Group Code (**gc**) must not already be equipped.

Group Code (**gc**) is not allowed with network types **ansi**, **itui**, **ituis**, and **itun24**.

Group Code (**gc**) is required for network type **itun** or **ituns** when the ITUDUPPC feature is turned on.

Group Code (**gc**) is not allowed for network type **itui** when the ITUDUPPC feature is turned off.

Group Code (**gc**) must be in the SID or SPC table.

The Spare Point Code Support feature must be enabled before the **ituis** or **ituns** network type can be specified.

The specified network appearance must exist in the Network Appearance table.

### Notes

Network Appearance identifies the SS7 network context of the message, for the purposes of logically separating signaling traffic between the SGP and ASP over a common SCTP association. A unique network appearance value can be associated with ANSI, ITUI, 14-bit ITU-N or 24-bit ITU-N networks. When the ITUDUPPC (ITU National Duplicate Point Code) feature is turned on, network appearance can be associated with a specific 14-bit ITU-N group code.

### Output

```
ent-na:type=ansi:na=10
  r1ghncxa03w 04-02-20 09:07:58 EST EAGLE 31.3.0
  ENT-NA: MASP A - COMPLTD
;
```

## ent-npp-as

### Enter an NPP Action Set

Use this command to enter a Numbering Plan Processor (NPP) Action Set (AS). An AS is a collection of Conditioning Actions (CAs), Service Actions (SAs), and Formatting Actions (FAs).

**Keyword:** ent-npp-as

**Related Commands:** chg-npp-as, dlt-npp-as, rtrv-npp-as

**Command Class:** Database Administration

### Parameters

**NOTE:** Release 41.1 introduces the ability to provision the CA, FA, and SA values using either a comma-separated list or individual caX, saX, and faX parameters.

**NOTE:** CAs and FAs are processed in consecutive order. If the comma-separated list is used, then the CAs and FAs are processed in the order that they are specified in the list. If individual parameters are used, then the CAs and FAs do not have to be specified in consecutive numerical order in the command. However, the parameters specified in the command must be consecutively numbered and must contain ca1 or fa1, respectively.

**NOTE:** SAs are processed in order of high-to-low precedence. If the comma separated list is used, then the SAs must be specified in high-to-low precedence order in the list, and cannot be duplicated in the list. If multiple SAs in the list have the same precedence, then those SAs are processed in the order in which they appear in the list. If individual parameters are used, then the SA with the highest precedence must be assigned as the value for sa1, and additional SAs must be assigned in descending precedence to consecutively numbered parameters after sa1 (sa2 through sa8). The SA parameters do not have to be specified in consecutive numerical order in the command. However, they must be consecutively numbered within the



command and must include sa1. If multiple SAs have the same precedence, then those SAs are processed in consecutive numerical order of the parameters that specify them.

**NOTE:** The ac\*, dn\*, sn\*, and cc\* values refer to all CAs that begin with ac, dn, sn, or cc, respectively.

**NOTE:** Refer to the *Numbering Plan Processor (NPP) Overview* and to the Feature Manual for the feature of interest for more information on provisioning Action Sets and for definitions for the CA, FA, and SA values.

**:asn=** (mandatory)

Action set name. This parameter specifies the name of the AS.

**Range:** zzzzzzzzzz  
10 alphanumeric characters

**:ca=** (optional)

Conditioning Action list. This parameter specifies a comma-separated CA list that can be applied to an incoming digit string. Up to 12 CAs can be specified in the list. The CAs are processed in the order in which they are specified in the list.

**Range:** ign1, ign2, ign3, ign4, ign5, ign6, ign7, ign8, ign9, ign10, fpx, pfxa1, pfxa2, pfxa3, pfxa4, pfxa5, pfxa6, pfxa7, pfxa8, pfb1, pfb2, pfb3, pfb4, pfb5, pfb6, pfb7, pfb8, pfc1, pfc2, pfc3, pfc4, pfc5, pfc6, pfc7, pfc8, pfd1, pfd2, pfd3, pfd4, pfd5, pfd6, pfd7, pfd8, pfe1, pfe2, pfe3, pfe4, pfe5, pfe6, pfe7, pfe8, pxf1, pxf2, pxf3, pxf4, pxf5, pxf6, pxf7, pxf8, cc1, cc2, cc3, cdef, ac1, ac2, ac3, ac4, ac5, ac6, ac7, ac8, sn1, sn2, sn3, sn4, sn5, sn6, sn7, sn8, sn9, sn10, sn11, sn12, sn13, sn14, sn15, snx, dn1, dn2, dn3, dn4, dn5, dn6, dn7, dn8, dn9, dn10, dn11, dn12, dn13, dn14, dn15, dnx, znx, aclac, accgpn, acdef, cccgpn

**:ca1=** (optional)

Conditioning action 1. This parameter specifies the first CA that can be applied to an incoming digit string.

**Range:** ign1, ign2, ign3, ign4, ign5, ign6, ign7, ign8, ign9, ign10, fpx, pfxa1, pfxa2, pfxa3, pfxa4, pfxa5, pfxa6, pfxa7, pfxa8, pfb1, pfb2, pfb3, pfb4, pfb5, pfb6, pfb7, pfb8, pfc1, pfc2, pfc3, pfc4, pfc5, pfc6, pfc7, pfc8, pfd1, pfd2, pfd3, pfd4, pfd5, pfd6, pfd7, pfd8, pfe1, pfe2, pfe3, pfe4, pfe5, pfe6, pfe7, pfe8, pxf1, pxf2, pxf3, pxf4, pxf5, pxf6, pxf7, pxf8, cc1, cc2, cc3, cdef, ac1, ac2, ac3, ac4, ac5, ac6, ac7, ac8, sn1, sn2, sn3, sn4, sn5, sn6, sn7, sn8, sn9, sn10, sn11, sn12, sn13, sn14, sn15, snx, dn1, dn2, dn3, dn4, dn5, dn6, dn7, dn8, dn9, dn10, dn11, dn12, dn13, dn14, dn15, dnx, znx, aclac, accgpn, acdef, cccgpn

**:ca10=** (optional)

Conditioning action 10. This parameter specifies the tenth CA that can be applied to an incoming digit string.

**Range:** ign1, ign2, ign3, ign4, ign5, ign6, ign7, ign8, ign9, ign10, fpx, pfxa1, pfxa2, pfxa3, pfxa4, pfxa5, pfxa6, pfxa7, pfxa8, pfb1, pfb2, pfb3, pfb4, pfb5, pfb6, pfb7, pfb8, pfc1, pfc2, pfc3, pfc4, pfc5, pfc6, pfc7, pfc8, pfd1, pfd2, pfd3, pfd4, pfd5, pfd6, pfd7, pfd8, pfe1, pfe2, pfe3, pfe4, pfe5, pfe6, pfe7, pfe8, pxf1, pxf2, pxf3, pxf4, pxf5, pxf6, pxf7, pxf8, cc1, cc2, cc3, cdef, ac1, ac2, ac3, ac4, ac5, ac6, ac7, ac8, sn1, sn2, sn3, sn4, sn5, sn6, sn7, sn8, sn9, sn10, sn11, sn12, sn13, sn14, sn15, snx, dn1, dn2, dn3, dn4, dn5, dn6, dn7, dn8, dn9, dn10, dn11, dn12, dn13, dn14, dn15, dnx, znx, aclac, accgpn, acdef, cccgpn

**:ca11=** (optional)

Conditioning action 11. This parameter specifies the eleventh CA that can be applied to an incoming digit string.

**Range:** ign1, ign2, ign3, ign4, ign5, ign6, ign7, ign8, ign9, ign10, fpx, pfxa1, pfxa2, pfxa3, pfxa4, pfxa5, pfxa6, pfxa7, pfxa8, pfb1, pfb2, pfb3, pfb4, pfb5, pfb6, pfb7, pfb8, pfc1, pfc2, pfc3, pfc4, pfc5, pfc6, pfc7, pfc8, pfd1, pfd2, pfd3, pfd4, pfd5, pfd6, pfd7, pfd8, pxe1, pxe2, pxe3, pxe4, pxe5, pxe6, pxe7, pxe8, pxf1, pxf2, pxf3, pxf4, pxf5, pxf6, pxf7, pxf8, cc1, cc2, cc3, cdef, ac1, ac2, ac3, ac4, ac5, ac6, ac7, ac8, sn1, sn2, sn3, sn4, sn5, sn6, sn7, sn8, sn9, sn10, sn11, sn12, sn13, sn14, sn15, snx, dn1, dn2, dn3, dn4, dn5, dn6, dn7, dn8, dn9, dn10, dn11, dn12, dn13, dn14, dn15, dnx, znx, aclac, accgpn, acdef, cccgpn

**:ca12=** (optional)

Conditioning action 12. This parameter specifies the twelfth CA that can be applied to an incoming digit string.

**Range:** ign1, ign2, ign3, ign4, ign5, ign6, ign7, ign8, ign9, ign10, fpx, pfxa1, pfxa2, pfxa3, pfxa4, pfxa5, pfxa6, pfxa7, pfxa8, pfb1, pfb2, pfb3, pfb4, pfb5, pfb6, pfb7, pfb8, pfc1, pfc2, pfc3, pfc4, pfc5, pfc6, pfc7, pfc8, pfd1, pfd2, pfd3, pfd4, pfd5, pfd6, pfd7, pfd8, pxe1, pxe2, pxe3, pxe4, pxe5, pxe6, pxe7, pxe8, pxf1, pxf2, pxf3, pxf4, pxf5, pxf6, pxf7, pxf8, cc1, cc2, cc3, cdef, ac1, ac2, ac3, ac4, ac5, ac6, ac7, ac8, sn1, sn2, sn3, sn4, sn5, sn6, sn7, sn8, sn9, sn10, sn11, sn12, sn13, sn14, sn15, snx, dn1, dn2, dn3, dn4, dn5, dn6, dn7, dn8, dn9, dn10, dn11, dn12, dn13, dn14, dn15, dnx, znx, aclac, accgpn, acdef, cccgpn

**:ca2=** (optional)

Conditioning action 2. This parameter specifies the second CA that can be applied to an incoming digit string.

**Range:** ign1, ign2, ign3, ign4, ign5, ign6, ign7, ign8, ign9, ign10, fpx, pfxa1, pfxa2, pfxa3, pfxa4, pfxa5, pfxa6, pfxa7, pfxa8, pfb1, pfb2, pfb3, pfb4, pfb5, pfb6, pfb7, pfb8, pfc1, pfc2, pfc3, pfc4, pfc5, pfc6, pfc7, pfc8, pfd1, pfd2, pfd3, pfd4, pfd5, pfd6, pfd7, pfd8, pxe1, pxe2, pxe3, pxe4, pxe5, pxe6, pxe7, pxe8, pxf1, pxf2, pxf3, pxf4, pxf5, pxf6, pxf7, pxf8, cc1, cc2, cc3, cdef, ac1, ac2, ac3, ac4, ac5, ac6, ac7, ac8, sn1, sn2, sn3, sn4, sn5, sn6, sn7, sn8, sn9, sn10, sn11, sn12, sn13, sn14, sn15, snx, dn1, dn2, dn3, dn4, dn5, dn6, dn7, dn8, dn9, dn10, dn11, dn12, dn13, dn14, dn15, dnx, znx, aclac, accgpn, acdef, cccgpn

**:ca3=** (optional)

Conditioning action 3. This parameter specifies the third CA that can be applied to an incoming digit string.

**Range:** ign1, ign2, ign3, ign4, ign5, ign6, ign7, ign8, ign9, ign10, fpx, pfxa1, pfxa2, pfxa3, pfxa4, pfxa5, pfxa6, pfxa7, pfxa8, pfb1, pfb2, pfb3, pfb4, pfb5, pfb6, pfb7, pfb8, pfc1, pfc2, pfc3, pfc4, pfc5, pfc6, pfc7, pfc8, pfd1, pfd2, pfd3, pfd4, pfd5, pfd6, pfd7, pfd8, pxe1, pxe2, pxe3, pxe4, pxe5, pxe6, pxe7, pxe8, pxf1, pxf2, pxf3, pxf4, pxf5, pxf6, pxf7, pxf8, cc1, cc2, cc3, cdef, ac1, ac2, ac3, ac4, ac5, ac6, ac7, ac8, sn1, sn2, sn3, sn4, sn5, sn6, sn7, sn8, sn9, sn10, sn11, sn12, sn13, sn14, sn15, snx, dn1, dn2, dn3, dn4, dn5, dn6, dn7, dn8, dn9, dn10, dn11, dn12, dn13, dn14, dn15, dnx, znx, aclac, accgpn, acdef, cccgpn

**:ca4=** (optional)

Conditioning action 4. This parameter specifies the fourth CA that can be applied to an incoming digit string.

**Range:** ign1, ign2, ign3, ign4, ign5, ign6, ign7, ign8, ign9, ign10, fpx, pfxa1, pfxa2, pfxa3, pfxa4, pfxa5, pfxa6, pfxa7, pfxa8, pfb1, pfb2, pfb3, pfb4, pfb5, pfb6, pfb7, pfb8, pfc1, pfc2, pfc3, pfc4, pfc5, pfc6, pfc7, pfc8, pfd1, pfd2, pfd3, pfd4, pfd5, pfd6, pfd7, pfd8, pxe1, pxe2, pxe3, pxe4, pxe5, pxe6, pxe7, pxe8, pxf1, pxf2, pxf3, pxf4, pxf5, pxf6, pxf7, pxf8, cc1, cc2, cc3, cdef, ac1, ac2, ac3, ac4, ac5, ac6, ac7, ac8, sn1, sn2, sn3, sn4, sn5, sn6, sn7, sn8, sn9, sn10, sn11, sn12, sn13, sn14, sn15, snx, dn1, dn2, dn3, dn4, dn5, dn6, dn7, dn8, dn9, dn10, dn11, dn12, dn13, dn14, dn15, dnx, znx, aclac, accgpn, acdef, cccgpn

**:ca5=** (optional)

Conditioning action 5. This parameter specifies the fifth CA that can be applied to an incoming digit string.

**Range:** ign1, ign2, ign3, ign4, ign5, ign6, ign7, ign8, ign9, ign10, fpx, pfxa1, pfxa2, pfxa3, pfxa4, pfxa5, pfxa6, pfxa7, pfxa8, pfb1, pfb2, pfb3, pfb4, pfb5, pfb6, pfb7, pfb8, pfc1, pfc2, pfc3, pfc4, pfc5, pfc6, pfc7, pfc8, pfd1, pfd2, pfd3, pfd4, pfd5, pfd6, pfd7, pfd8, pxe1, pxe2, pxe3, pxe4, pxe5, pxe6, pxe7, pxe8, pxf1, pxf2, pxf3, pxf4, pxf5, pxf6, pxf7, pxf8, cc1, cc2, cc3, cdef, ac1, ac2, ac3, ac4, ac5, ac6, ac7, ac8, sn1, sn2, sn3, sn4, sn5, sn6, sn7, sn8, sn9, sn10, sn11, sn12, sn13, sn14, sn15, snx, dn1, dn2, dn3, dn4, dn5, dn6, dn7, dn8, dn9, dn10, dn11, dn12, dn13, dn14, dn15, dnx, znx, aclac, accgpn, acdef, cccgpn

**:ca6=** (optional)

Conditioning action 6. This parameter specifies the sixth CA that can be applied to an incoming digit string.

**Range:** ign1, ign2, ign3, ign4, ign5, ign6, ign7, ign8, ign9, ign10, fpx, pfxa1, pfxa2, pfxa3, pfxa4, pfxa5, pfxa6, pfxa7, pfxa8, pfb1, pfb2, pfb3, pfb4, pfb5, pfb6, pfb7, pfb8, pfc1, pfc2, pfc3, pfc4, pfc5, pfc6, pfc7, pfc8, pfd1, pfd2, pfd3, pfd4, pfd5, pfd6, pfd7, pfd8, pxe1, pxe2, pxe3, pxe4, pxe5, pxe6, pxe7, pxe8, pxf1, pxf2, pxf3, pxf4, pxf5, pxf6, pxf7, pxf8, cc1, cc2, cc3, cdef, ac1, ac2, ac3, ac4, ac5, ac6, ac7, ac8, sn1, sn2, sn3, sn4, sn5, sn6, sn7, sn8, sn9, sn10, sn11, sn12, sn13, sn14, sn15, snx, dn1, dn2, dn3, dn4, dn5, dn6, dn7, dn8, dn9, dn10, dn11, dn12, dn13, dn14, dn15, dnx, znx, aclac, accgpn, acdef, cccgpn

**:ca7=** (optional)

Conditioning action 7. This parameter specifies the seventh CA that can be applied to an incoming digit string.

**Range:** ign1, ign2, ign3, ign4, ign5, ign6, ign7, ign8, ign9, ign10, fpx, pfxa1, pfxa2, pfxa3, pfxa4, pfxa5, pfxa6, pfxa7, pfxa8, pfb1, pfb2, pfb3, pfb4, pfb5, pfb6, pfb7, pfb8, pfc1, pfc2, pfc3, pfc4, pfc5, pfc6, pfc7, pfc8, pfd1, pfd2, pfd3, pfd4, pfd5, pfd6, pfd7, pfd8, pxe1, pxe2, pxe3, pxe4, pxe5, pxe6, pxe7, pxe8, pxf1, pxf2, pxf3, pxf4, pxf5, pxf6, pxf7, pxf8, cc1, cc2, cc3, cdef, ac1, ac2, ac3, ac4, ac5, ac6, ac7, ac8, sn1, sn2, sn3, sn4, sn5, sn6, sn7, sn8, sn9, sn10, sn11, sn12, sn13, sn14, sn15, snx, dn1, dn2, dn3, dn4, dn5, dn6, dn7, dn8, dn9, dn10, dn11, dn12, dn13, dn14, dn15, dnx, znx, aclac, accgpn, acdef, cccgpn

**:ca8=** (optional)

Conditioning action 8. This parameter specifies the eighth CA that can be applied to an incoming digit string.

**Range:** ign1, ign2, ign3, ign4, ign5, ign6, ign7, ign8, ign9, ign10, fpx, pfxa1, pfxa2, pfxa3, pfxa4, pfxa5, pfxa6, pfxa7, pfxa8, pfb1, pfb2, pfb3, pfb4, pfb5, pfb6, pfb7, pfb8, pfc1, pfc2, pfc3, pfc4, pfc5, pfc6, pfc7, pfc8, pfd1, pfd2, pfd3, pfd4, pfd5, pfd6, pfd7, pfd8, pxe1, pxe2, pxe3, pxe4, pxe5, pxe6, pxe7, pxe8, pxf1, pxf2, pxf3, pxf4, pxf5, pxf6, pxf7, pxf8, cc1, cc2, cc3, cdef, ac1, ac2, ac3, ac4, ac5, ac6, ac7, ac8, sn1, sn2, sn3, sn4, sn5, sn6, sn7, sn8, sn9, sn10, sn11, sn12, sn13, sn14, sn15, snx, dn1, dn2, dn3, dn4, dn5, dn6, dn7, dn8, dn9, dn10, dn11, dn12, dn13, dn14, dn15, dnx, znx, aclac, accgpn, acdef, cccgpn

**:ca9=** (optional)

Conditioning action 9. This parameter specifies the ninth CA that can be applied to an incoming digit string.

**Range:** ign1, ign2, ign3, ign4, ign5, ign6, ign7, ign8, ign9, ign10, fpx, pfxa1, pfxa2, pfxa3, pfxa4, pfxa5, pfxa6, pfxa7, pfxa8, pfb1, pfb2, pfb3, pfb4, pfb5, pfb6, pfb7, pfb8, pfc1, pfc2, pfc3, pfc4, pfc5, pfc6, pfc7, pfc8, pfd1, pfd2, pfd3, pfd4, pfd5, pfd6, pfd7, pfd8, pxe1, pxe2, pxe3, pxe4, pxe5, pxe6, pxe7, pxe8, pxf1, pxf2, pxf3, pxf4, pxf5, pxf6, pxf7, pxf8, cc1, cc2, cc3, cdef, ac1, ac2, ac3, ac4, ac5, ac6, ac7, ac8, sn1, sn2, sn3, sn4, sn5, sn6, sn7, sn8, sn9, sn10, sn11, sn12, sn13, sn14, sn15, snx, dn1, dn2, dn3, dn4, dn5, dn6, dn7, dn8, dn9, dn10, dn11, dn12, dn13, dn14, dn15, dnx, znx, aclac, accgpn, acdef, cccgpn

**:fa=** (optional)

Formatting Action list. This parameter specifies a comma-separated FA list that can be applied to the outgoing digit string. Up to 12 FAs can be specified in the list. The FAs are processed in the order they are specified in the list and cannot be duplicated.

**Range:** sn, dn, zn, ac, rn, sp, cc, fpx, pfxa, pfb, pfc, pfd, pxe, pxf, dlma, dlmb, dlmc, asd, orig, grn, vmid, srfimsi, dlmd, dlme, dlmf, dlmg, dlmh, dlmi, dlmj, dlmk, dlml, dlmm, dlmn, dlmo, dlmp, rnospodn, rnospoz, rnosposn

**Default:** orig

**:fa1=** (optional)

Formatting action 1. This parameter specifies the first FA that can be applied to the outgoing digit string.

**Range:** sn, dn, zn, ac, rn, sp, cc, fpx, pfxa, pfb, pfc, pfd, pxe, pxf, dlma, dlmb, dlmc, asd, orig, grn, vmid, srfimsi, dlmd, dlme, dlmf, dlmg, dlmh, dlmi, dlmj, dlmk, dlml, dlmm, dlmn, dlmo, dlmp, rnospodn, rnospoz, rnosposn

**System**

**Default:** orig

**:fa10=** (optional)

Formatting action 10. This parameter specifies the tenth FA that can be applied to the outgoing digit string.

**Range:** sn, dn, zn, ac, rn, sp, cc, fpx, pfxa, pfb, pfc, pfd, pxe, pxf, dlma, dlmb, dlmc, asd, orig, grn, vmid, srfimsi, dlmd, dlme, dlmf, dlmg, dlmh, dlmi, dlmj, dlmk, dlml, dlmm, dlmn, dlmo, dlmp, rnospodn, rnospoz, rnosposn

**:fa11=** (optional)

Formatting action 11. This parameter specifies the eleventh FA that can be applied to the outgoing digit string.

- Range:** sn, dn, zn, ac, rn, sp, cc, fpx, pfxa, pfxb, pfxc, pfxd, pfxe, pfxf, dlma, dlmb, dlmc, asd, orig, grn, vmid, srfimsi, dlmd, dlme, dlmf, dlmg, dlmh, dlmi, dlmj, dlmk, dlml, dlmm, dlmn, dlmo, dlmp, rnospodn, rnospoz, rnosposn
- :fa12=** (optional)  
 Formatting action 12. This parameter specifies the twelfth FA that can be applied to the outgoing digit string.
- Range:** sn, dn, zn, ac, rn, sp, cc, fpx, pfxa, pfxb, pfxc, pfxd, pfxe, pfxf, dlma, dlmb, dlmc, asd, orig, grn, vmid, srfimsi, dlmd, dlme, dlmf, dlmg, dlmh, dlmi, dlmj, dlmk, dlml, dlmm, dlmn, dlmo, dlmp, rnospodn, rnospoz, rnosposn
- :fa2=** (optional)  
 Formatting action 2. This parameter specifies the second FA that can be applied to the outgoing digit string.
- Range:** sn, dn, zn, ac, rn, sp, cc, fpx, pfxa, pfxb, pfxc, pfxd, pfxe, pfxf, dlma, dlmb, dlmc, asd, orig, grn, vmid, srfimsi, dlmd, dlme, dlmf, dlmg, dlmh, dlmi, dlmj, dlmk, dlml, dlmm, dlmn, dlmo, dlmp, rnospodn, rnospoz, rnosposn
- :fa3=** (optional)  
 Formatting action 3. This parameter specifies the third FA that can be applied to the outgoing digit string.
- Range:** sn, dn, zn, ac, rn, sp, cc, fpx, pfxa, pfxb, pfxc, pfxd, pfxe, pfxf, dlma, dlmb, dlmc, asd, orig, grn, vmid, srfimsi, dlmd, dlme, dlmf, dlmg, dlmh, dlmi, dlmj, dlmk, dlml, dlmm, dlmn, dlmo, dlmp, rnospodn, rnospoz, rnosposn
- :fa4=** (optional)  
 Formatting action 4. This parameter specifies the fourth FA that can be applied to the outgoing digit string.
- Range:** sn, dn, zn, ac, rn, sp, cc, fpx, pfxa, pfxb, pfxc, pfxd, pfxe, pfxf, dlma, dlmb, dlmc, asd, orig, grn, vmid, srfimsi, dlmd, dlme, dlmf, dlmg, dlmh, dlmi, dlmj, dlmk, dlml, dlmm, dlmn, dlmo, dlmp, rnospodn, rnospoz, rnosposn
- :fa5=** (optional)  
 Formatting action 5. This parameter specifies the fifth FA that can be applied to the outgoing digit string.
- Range:** sn, dn, zn, ac, rn, sp, cc, fpx, pfxa, pfxb, pfxc, pfxd, pfxe, pfxf, dlma, dlmb, dlmc, asd, orig, grn, vmid, srfimsi, dlmd, dlme, dlmf, dlmg, dlmh, dlmi, dlmj, dlmk, dlml, dlmm, dlmn, dlmo, dlmp, rnospodn, rnospoz, rnosposn
- :fa6=** (optional)  
 Formatting action 6. This parameter specifies the sixth FA that can be applied to the outgoing digit string.
- Range:** sn, dn, zn, ac, rn, sp, cc, fpx, pfxa, pfxb, pfxc, pfxd, pfxe, pfxf, dlma, dlmb, dlmc, asd, orig, grn, vmid, srfimsi, dlmd, dlme, dlmf, dlmg, dlmh, dlmi, dlmj, dlmk, dlml, dlmm, dlmn, dlmo, dlmp, rnospodn, rnospoz, rnosposn
- :fa7=** (optional)  
 Formatting action 7. This parameter specifies the seventh FA that can be applied to the outgoing digit string.
- Range:** sn, dn, zn, ac, rn, sp, cc, fpx, pfxa, pfxb, pfxc, pfxd, pfxe, pfxf, dlma, dlmb, dlmc, asd, orig, grn, vmid, srfimsi, dlmd, dlme, dlmf, dlmg, dlmh, dlmi, dlmj, dlmk, dlml, dlmm, dlmn, dlmo, dlmp, rnospodn, rnospoz, rnosposn
- :fa8=** (optional)  
 Formatting action 8. This parameter specifies the eighth FA that can be applied to the outgoing digit string.

**Range:** sn, dn, zn, ac, rn, sp, cc, fpx, pfxa, pfxb, pfxc, pfxd, pfxe, pfxf, dlma, dlmb, dlmc, asd, orig, grn, vmid, srfimsi, dlmd, dlme, dlmf, dlmg, dlmh, dlmi, dlmj, dlmk, dlml, dlmm, dlmn, dlmo, dlmp, rnospodn, rnospozn, rnosposn

**:fa9=** (optional)

Formatting action 9. This parameter specifies the ninth FA that can be applied to the outgoing digit string.

**Range:** sn, dn, zn, ac, rn, sp, cc, fpx, pfxa, pfxb, pfxc, pfxd, pfxe, pfxf, dlma, dlmb, dlmc, asd, orig, grn, vmid, srfimsi, dlmd, dlme, dlmf, dlmg, dlmh, dlmi, dlmj, dlmk, dlml, dlmm, dlmn, dlmo, dlmp, rnospodn, rnospozn, rnosposn

**:ofnai=** (optional)

Outgoing filter nature of address indicator. This parameter specifies the filter nature of address indicator (FNAI) class of the outgoing digit string.

**Range:** intl, natl, nai1, nai2, nai3, unkn, inc  
**intl**—intl value provisioned in the **chg-npp-serv** command  
**natl**—natl value provisioned in the **chg-npp-serv** command  
**nai1**—nai1 value provisioned in the **chg-npp-serv** command  
**nai2**—nai2 value provisioned in the **chg-npp-serv** command  
**nai3**—nai3 value provisioned in the **chg-npp-serv** command  
**unkn**—unkn value provisioned in the **chg-npp-serv** command  
**inc**—NAI of the incoming digit string

**Default:** inc

**:sa=** (optional)

Service Action list. This parameter specifies a comma-separated SA list that can be applied to an incoming digit string. Up to 8 SAs can be specified in the list. The SAs must be specified in high-to-low precedence order in the list, and cannot be duplicated in the list.

SAs are service-specific.

**Range:** rtdbtrn, rtdbtsp, rtdbtrnsp, cdial, ccncchk, cdpnnp, cgpnp, cgpnsverqd, lacck, fwdscs, npnrls, nprelay, nprls, crp, snsngpn, fraudchk, pprelay, migrate, asdlkup, grnlkup, cgpnasdrqd, cgpngrnrqd, nscgpn, nscdpn, blklstqry, blklstly, cgpnrng, none  
**none**—Deletes ALL SAs from the Action Set.

**:sa1=** (optional)

Service action 1. This parameter specifies the first SA that can be applied to an incoming digit string. SAs are service-specific.

**Range:** rtdbtrn, rtdbtsp, rtdbtrnsp, cdial, ccncchk, cdpnnp, cgpnp, cgpnsverqd, lacck, fwdscs, npnrls, nprelay, nprls, crp, snsngpn, fraudchk, pprelay, migrate, asdlkup, grnlkup, cgpnasdrqd, cgpngrnrqd, nscgpn, nscdpn, blklstqry, blklstly, cgpnrng, none  
**none**—Not used in the **ent-npp-as** command.

**:sa2=** (optional)

Service action 2. This parameter specifies the second SA that can be applied to an incoming digit string.

SAs are service-specific.

**Range:** rtdbtrn, rtdbtsp, rtdbtrnsp, cdial, ccncchk, cdpnnp, cgpnp, cgpnsverqd, lacck, fwdscs, npnrls, nprelay, nprls, crp, snsngpn, fraudchk, pprelay, migrate, asdlkup, grnlkup, cgpnasdrqd, cgpngrnrqd, nscgpn, nscdpn, blklstqry, blklstly, cgpnrng, none  
**none**—Not used in the **ent-npp-as** command.

**:sa3=** (optional)

Service action 3. This parameter specifies the third SA that can be applied to an incoming digit string. SAs are service-specific.

**Range:** **rtdbtrn, rtdbtsp, rtdbtrnsp, cdial, ccnchck, cdpnnp, cgpnpn, cgpnsverqd, lacck, fwdscs, npnrls, nprelay, nprls, crp, snscegn, fraudchk, pprelay, migrate, asdlkup, grnlkup, cgpnasdrqd, cgpngrnrqd, nscgpn, nscdpn, blklstqry, blklstrly, cgpnrtdg, none**  
**none**—Not used in the **ent-npp-as** command.

**:sa4=** (optional)

Service action 4. This parameter specifies the fourth SA that can be applied to an incoming digit string.

SAs are service-specific.

**Range:** **rtdbtrn, rtdbtsp, rtdbtrnsp, cdial, ccnchck, cdpnnp, cgpnpn, cgpnsverqd, lacck, fwdscs, npnrls, nprelay, nprls, crp, snscegn, fraudchk, pprelay, migrate, asdlkup, grnlkup, cgpnasdrqd, cgpngrnrqd, nscgpn, nscdpn, blklstqry, blklstrly, cgpnrtdg, none**  
**none**—Not used in the **ent-npp-as** command.

**:sa5=** (optional)

Service action 5. This parameter specifies the fifth SA that can be applied to an incoming digit string. SAs are service-specific.

**Range:** **rtdbtrn, rtdbtsp, rtdbtrnsp, cdial, ccnchck, cdpnnp, cgpnpn, cgpnsverqd, lacck, fwdscs, npnrls, nprelay, nprls, crp, snscegn, fraudchk, pprelay, migrate, asdlkup, grnlkup, cgpnasdrqd, cgpngrnrqd, nscgpn, nscdpn, blklstqry, blklstrly, cgpnrtdg, none**  
**none**—Not used in the **ent-npp-as** command.

**:sa6=** (optional)

Service action 6. This parameter specifies the sixth SA that can be applied to an incoming digit string. SAs are service-specific.

**Range:** **rtdbtrn, rtdbtsp, rtdbtrnsp, cdial, ccnchck, cdpnnp, cgpnpn, cgpnsverqd, lacck, fwdscs, npnrls, nprelay, nprls, crp, snscegn, fraudchk, pprelay, migrate, asdlkup, grnlkup, cgpnasdrqd, cgpngrnrqd, nscgpn, nscdpn, blklstqry, blklstrly, cgpnrtdg, none**  
**none**—Not used in the **ent-npp-as** command.

**:sa7=** (optional)

Service action 7. This parameter specifies the seventh SA that can be applied to an incoming digit string.

SAs are service-specific.

**Range:** **rtdbtrn, rtdbtsp, rtdbtrnsp, cdial, ccnchck, cdpnnp, cgpnpn, cgpnsverqd, lacck, fwdscs, npnrls, nprelay, nprls, crp, snscegn, fraudchk, pprelay, migrate, asdlkup, grnlkup, cgpnasdrqd, cgpngrnrqd, nscgpn, nscdpn, blklstqry, blklstrly, cgpnrtdg, none**  
**none**—Not used in the **ent-npp-as** command.

**:sa8=** (optional)

Service action 8. This parameter specifies the eighth SA that can be applied to the incoming digit string.

SAs are service-specific.

**Range:** **rtdbtrn, rtdbtsp, rtdbtrnsp, cdial, ccnchck, cdpnnp, cgpnpn, cgpnsverqd, lacck, fwdscs, npnrls, nprelay, nprls, crp, snscegn, fraudchk, pprelay,**

**migrate**, **asdlkup**, **grnlkup**, **cgpnasdrqd**, **cgpngrnrqd**, **nscgpn**, **nscdpn**,  
**blklstqry**, **blkltrly**, **cgpnrtdg**, **none**  
**none**—Not used in the **ent-npp-as** command.

### Example

```
ent-npp-as:asn=asn1:ca1=ign1:ca2=ign2:fa1=zn:ca3=ign4:ca4=znx
ent-npp-
as:asn=asn4:ca1=fpx:ca2=cc2:ca3=ign3:ca4=dn4:fa1=dn:fa2=cc
ent-npp-
as:asn=asn5:fa1=sn:ca1=ac8:ca2=sn8:ca3=cc3:fa2=ac:fa3=cc:sa1=rtbdb
trn:sa2=rtdbtsp:sa3=rtdbtrnsp:sa4=cdial
ent-npp-as:asn=asn1:ca1=znx:fa1=asd:sa1=asdlkup
ent-npp-as:asn=asn2:ca1=znx:fa1=grn:sa1=grnlkup
ent-npp-
as:asn=asn10:ca1=cc2:ca2=ac2:ca3=snx:sa1=migrate:sa2=cdpnp:fa1=c
c:fa2=rnosposn
ent-npp-
as:asn=asn9:ca1=fpx:ca2=cc2:ca3=dnx:sa1=fraudchk:sa2=pprelay:fa1
=cc:fa2=dn
ent-npp-
as:asn=asn6:ca1=znx:sa1=nscdpn:sa2=nscgpn:fa1=zn:ofnai=intl
ent-npp-as:asn=asn1:ca=ign1,ign2,ign4,znx:fa=zn
ent-npp-as:asn=asn4:ca=fpx,cc2,ign3,dn4:fa=dn,cc
ent-npp-
as:asn=asn5:ca=ac8,sn8,cc3:fa=sn,ac,cc:sa=rtdbtrn,rtdbtsp,rtdbtrn
sp,cdial
ent-npp-as:asn=asn1:ca=znx:fa=asd:sa=asdlkup
ent-npp-as:asn=asn2:ca=znx:fa=grn:sa=grnlkup
ent-npp-
as:asn=asn10:ca=cc2,ac2,snx:sa=migrate,cdpnp:fa=cc,rnosposn
ent-npp-as:asn=asn9:ca=fpx,cc2,dnx:sa=fraudchk,pprelay:fa=cc,dn
ent-npp-as:asn=asn6:ca=znx:sa=nscdpn,nscgpn:fa=zn:ofnai=intl
```

### Dependencies

The value specified for the **asn** parameter cannot already exist in the NPP AS table.

One of the following combinations of CA values must be specified for the AS:

- **znx**
- **cc\***, **dn\***
- **cc\***, **ac\***, **sn\***

The FAs specified for the AS must contain the corresponding FA that a CA will populate or load.

The AS must contain a CA that can load or populate the specified FA.

If specified, the **caX** parameters must be consecutively numbered, always including **ca1**. The parameters do not have to be entered in sequential order in the command.



If specified, the **saX** parameters must be consecutively numbered, always including **sa1**. The parameters do not have to be entered in sequential order in the command. The SA with the highest precedence must be assigned as the value for **sa1**.

If specified, the **faX** parameters must be consecutively numbered, always including **fa1**. The parameters do not have to be entered in sequential order in the command.

The CAs within an AS cannot condition more than 32 digits.

The AS cannot contain CAs that load or populate the same FA.

If the ZNX CA is specified, then the AC\* and DNX CAs cannot be specified in the same Action Set. Each AC\*, CC\*, DN\*, and SN\* CA can be specified only once in the Action Set.

The same value cannot be specified for the **faX** parameters within an AS.

The AS cannot contain the following combinations of FAs:

- If the DN FA is specified, then the AC\*, SN\*, and ZN FAs cannot be specified.
- If the ZN FA is specified, then the AC\*, CC\*, SN\*, and DN FAs cannot be specified.
- If the SN FA is specified, then the ZN and DN\* FAs cannot be specified.
- If the RNOSPODN, RNOSPOSN, or RNOSPOZN FA is specified, then the RN, SP, SN, DN, and ZN FAs cannot be specified.
- The RNOSPODN, RNOSPOSN, and RNOSPOZN FAs cannot be specified together in the command.

If specified, the FPFX CA must be the first value (**fpfx**) in the **ca** list or **caX** parameter sequence.

If specified, the ZNX, SNX, or DNX CA must be the final value (**znx**, **snx**, or **dnx**) in the **ca** list or **caX** parameter sequence.

A maximum of 1024 (1K) AS entries can be specified in the NPP system.

The same value cannot be specified for the **saX** parameters within an AS.

The **ca** and **caX**, **fa** and **faX**, and **sa** and **saX** parameters cannot be specified together in the command.

## Notes

None.

## Output

```
ent-npp-as:asn=asn6:ca=znx:sa=nscdpn,nscgpn:fa=zn:ofnai=intl
tekelecstp 09-08-18 11:25:31 EAGLE 41.1.0
NPP-AS table is (5 of 1024) 1% full.

ENT-NPP-AS: MASP A - COMPLTD
;
```

## ent-npp-srs

### Create a NPP Service Rule Set

Use this command to enter a Numbering Plan Processor (NPP) Service Rule Set entry. A Service Rule Set (SRS) is a collection of NPP Rules that are associated with a NPP Service. A NPP Rule is an association between a single NPP filter and a single NPP Action Set.

**Keyword:** ent-npp-srs

**Related Commands:** chg-npp-as, chg-npp-srs, dlt-npp-srs, ent-npp-as, rtrv-npp-as, rtrv-npp-srs

**Command Class:** Database Administration

## Parameters

**:asn=** (mandatory)

Action set name. This parameter specifies the name of the AS.

**Range:** `ayyyyyyyyy`  
1 alphabetic character followed by up to 9 alphanumeric characters

**:fdl=** (mandatory)

Filter digit length. This parameter specifies the number of digits on the incoming digit string that is filtered by the NPP.

**Range:** `1-32 *`  
\*—multiple lengths of digit strings can be filtered

**:fnai=** (mandatory)

Filter nature of address indicator. This parameter specifies the filter Nature of Address Indicator (NAI) class.

**Range:** `intl, natl, nai1, nai2, nai3, unkn`  
**intl** — filter messages with NAI=INTL  
**natl** — filter messages with NAI=NATL  
**nai1** — filter messages with NAI=NAI1  
**nai2** — filter messages with NAI=NAI2  
**nai3** — filter messages with NAI=NAI3  
**unkn** — filter messages when NAI=UNKN  
 The **chg-npp-serv** command is used to assign values to the various FNAI classes.

**:fpfx=** (mandatory)

Filter prefix. This parameter specifies the prefix used to filter incoming digit strings.

**Range:** `1-16 digits, *, ?`  
 1 - 16 hexadecimal digits inclusive of single digit wildcard (?); or wildcard (\*) matching the entire digit string; valid digits are **?, 0-9, a-f, A-F**.

**:srvn=** (mandatory)

Service name. This parameter specifies the name of the NPP service.

**Range:** `nppt, idprcdpn, idprcgpn, tif, tif2, tif3, mosmsicgpn, mosmsicdpn, mosmsgcgpn, mosmsgcdpn, iarcdpn, iarcgpn`  
**nppt** — NPP Test Service  
**idprcdpn** — IDPRCDPN Service  
**idprcgpn** — IDPRCGPN Service  
**tif** — TIF NPP Service  
**tif2** — TIF2 NPP Service  
**tif3** — TIF3 NPP Service  
**mosmsicgpn** — MOSMSICGPN Service  
**mosmsicdpn** — MOSMSICDPN Service  
**mosmsgcgpn** — MOSMSGCGPN Service  
**mosmsgcdpn** — MOSMSGCDPN Service  
**iarcdpn** — IARCDPN Service  
**iarcgpn** — IARCGPN Service

## Example

```
ent-npp-srs:srvn=nppt:fpfx=a:fdl=10:fnai=intl:asn=asn2
ent-npp-srs:srvn=tif:fnai=INTL:fpfx=9090:fdl=*:asn=set1
ent-npp-srs:srvn=nppt:asn=testzn1:fnai=nai2:fdl=*:fpfx=1?2?3
```

## Dependencies

The value specified for the **asn** parameter must exist in the NPP AS table.

The AS specified by the **asn** parameter cannot contain CAs that are not supported by the service specified by the **srvn** parameter.

The AS specified by the **asn** parameter cannot contain SAs that are not supported by the service specified by the **srvn** parameter.

The AS specified by the **asn** parameter cannot contain FAs that are not supported by the service specified by the **srvn** parameter.

The AS specified by the **asn** parameter cannot contain SAs that do not conform to the precedence order that is supported by the service specified by the **srvn** parameter.

The CAs in the AS specified by the **asn** parameter cannot condition more digits than allowed by the **fdl** parameter.

If the **fdl=\*** parameter is specified, then the AS specified by the **asn** parameter must contain CAs that support variable digit string conditioning.

A maximum of 8192 (8K) rules can be specified in the NPP system.

A maximum of 4096 (4K) service rules can be specified in the NPP system.

The NPP Rule cannot already exist within the NPP Rule table.

If the values specified for the **fpfx** and the **fdl** parameters are not \*, then the value specified for the **fpfx** parameter cannot be greater than the value specified for the **fdl** parameter.

All of the features that are associated with the SAs in the AS that is specified by the **asn** parameter must be turned on before the AS can be used.

The SAs in the AS specified by the **asn** parameter cannot violate mutual exclusivity rules defined by the service specified by the **srvn** parameter.

The AS specified by the **asn** parameter cannot contain an OFNAI class with a value of **none**.

At least one TIF feature must be turned on before an AS containing the **cdial** SA can be specified.

The TIF SCS Forwarding feature must be turned on before an AS containing the **fwdsacs** SA can be specified.

The TIF Simple Number Substitution feature must be turned on before an AS containing the **snsacgn** SA can be specified.

The TIF Number Portability feature must be turned on before an AS containing the **crp**, **npnrls**, **cgpnprqd**, **nprelay**, or **npnrls** SA can be specified.

The IDPR ASD feature must be enabled before an AS containing the **asdlkup** or **cgpnasdrqd** SA can be specified as a value for the **asn** parameter with the IDPRCDPN or IDPRCGPN service.

The IDPR GRN feature must be enabled before an AS containing the **grnlkup** or **cgpngrnrqd** SA can be specified as a value for the **asn** parameter with the IDPRCDPN or IDPRCGPN service.

An AS containing the **asdlkup** and **cgpnasdrqd** SAs cannot be specified as a value for the **asn** parameter.

An AS containing the **grnlkup** and **cgpngrnrqd** SAs cannot be specified as a value for the **asn** parameter.

The TIF GRN feature must be enabled before an AS containing the **grnlkup** or **cgpngrnrqd** SAs can be specified as a value for the **asn** parameter with the TIF services.

The TIF ASD feature must be enabled before an AS containing the **asdlkup** or **cgpnasdrqd** SA can be specified as value for the **asn** parameter with the TIF services.

The MO SMS ASD feature must be enabled before an AS containing the **asdlkup** or **cgpnasdrqd** SA can be specified as a value for the **asn** parameter with the MOSMSGCDPN, MOSMSGCGPN, MOSMSICDPN, or MOSMSICGPN service.

The MO SMS GRN feature must be enabled before an AS containing the **cgpngnrnrqd** or **grnlkup** SA can be specified as a value for the **asn** parameter with the MOSMSGCDPN, MOSMSGCGPN, MOSMSICDPN, or MOSMSICGPN service.

If a rule contains an FPFX with a wildcard value, then the rule cannot contain an AS where the **fpfx** CA is specified.

The value specified for the **fpfx** parameter cannot have a **?** as the final character.

The TIF Number Substitution feature must be enabled before an AS containing the **nscgpn** or **nscdpn** SA can be specified.

The AS specified by the **asn** parameter cannot contain both the **nscgpn** and **sncgpn** SAs.

The Prepaid SMS Intercept Ph1 feature must be enabled before an AS containing the **pprelay** SA can be specified as a value for the **asn** parameter with the MOSMSGCDPN or MOSMSGCGPN service.

The Portability Check for MO SMS feature must be enabled before an AS containing the **fraudchk** SA can be specified as a value for the **asn** parameter with the MOSMSGCGPN service.

The MO SMS IS41-to-GSM Migration feature must be enabled before an AS containing the **migrate** SA can be specified as a value for the **asn** parameter with the MOSMSICDPN service.

The MO-based IS41 SMS NP feature must be enabled before an AS containing the **cdpnp** SA can be specified as a value for the **asn** parameter with the MOSMSICDPN service.

The MO-based GSM SMS NP feature must be enabled an AS containing the **cdpnp** SA can be specified as a value for the **asn** parameter with the MOSMSGCDPN service.

The IDP A-Party Routing feature must be enabled before the **saX=cgpnrtg** parameter can be specified.

The IDP A-Party Blacklist feature must be enabled before the **saX=blklstqry** or **saX=blklstrly** parameter can be specified.

If the **sa1=blklstqry** SA is specified, then no other SA can be specified.

A single digit wildcard (?) can be specified as a value for the **fpfx** parameter a maximum of 25 times across all of the rules for an NPP service.

The **caX=accgpn** and **caX=cccgpn** parameters cannot be specified together in the command.

The IAR ASD feature must be enabled before an AS containing the **asdlkup** or **cgpnasdrqd** SA can be specified as a value for the **asn** parameter with the IARCDPN or IARCGPN service.

The IAR GRN feature must be enabled before an AS containing the **grnlkup** or **cgpngnrnrqd** SA can be specified as a value for the **asn** parameter with the IARCDPN or IARCGPN service.

The IAR Base feature must be enabled before an AS containing the **ccncchk**, **cdial** or **cgpnsvrrqd** SA can be specified as a value for the **asn** parameter with the IARCDPN or IARCGPN service.

The IAR NP feature must be enabled before an AS containing the **cdpnp** or **cgpnp** SA can be specified as a value for the **asn** parameter with the IARCDPN or IARCGPN service.

## Notes

None

**Output**

```

ent-npp-srs:svrn=nppt:fpfx=abc:fdl=16:fnai=intl:asn=asn3
tekelecstp 09-02-19 13:57:09 EST EAGLE 40.1.0
NPP-SRS table is (1 of 8192) 1% full.

ENT-NPP-SRS: MASP A - COMPLTD
;

```

**ent-rmt-appl****Enter Remote Application**

Use this command to assign user parts to an internal point code that, in turn, assigns user parts to an End Office node.

**Keyword:** ent-rmt-appl

**Related Commands:** dlt-rmt-appl, rtrv-rmt-appl

**Command Class:** Database Administration

**Parameters**

**NOTE:** See "Point Code Formats and Conversion" for a detailed description of point code formats, rules for specification, and examples.

**:ipc=** (mandatory)

ANSI point code with subfields network indicator-network cluster-network cluster member (*ni-nc-ncm*). The *prefix* subfield indicates a private point code (*prefix-ni-nc-ncm*).

**Synonym:** ipca

**Range:** p-, 000-255

Specify a valid value for each subfield of the point code, and separate the subfields with a dash (-).

*prefix*—p-

When **chg-sid:pctype=ansi** is specified, *ni* = 000 is not valid.

When **chg-sid:pctype=ansi** is specified, *nc* = 000 is not valid if *ni* = 001-005.

When **chg-sid:pctype=ansi** is specified, *nc* = 000 is valid if *ni* = 006-255.

The point code 000-000-000 is not a valid point code.

**:ipc/ipca/ipci/ipcn/ipcn24=** (mandatory)

End Node's internal point code.

**:ipci=** (mandatory)

ITU international destination point code with subfields *zone-area-id*. The *prefix* subfield indicates a spare point code, private point code, or private and spare point code (*prefix-zone-area-id*).

**Range:** s-, p-, ps-, 0-255

Specify a valid value for each subfield of the point code, and separate the subfields with a dash (-).

*prefix*—s-, p-, ps-

*zone*—0-7

*area*—000-255

*id*—0-7

The point code 0-000-0 is not a valid point code.

**:ipcn=** (mandatory)

ITU national point code with subfield ITU number (*nnnnn*). The *prefix* subfield indicates a spare point code, private point code, or private and spare point code (*prefix-nnnnn*, *prefix-nnnnn-gc*, *prefix-m1-m2-m3-m4*, *prefix-m1-m2-m3-m4-gc*).

**Range:** **s-, p-, ps-, 0-16383, aa-zz**

Specify a valid value for each subfield of the point code, and separate the subfields with a dash (-).

*prefix*—**s-, p-, ps-**

*nnnnn*—**0-16383**

*gc*—**aa-zz**

*m1-m2-m3-m4*—**0-14** for each member; values must sum to 14

**:ipcn24=** (mandatory)

24-bit ITU national point code with subfields *main signaling area-sub signaling area-signaling point* (*msa-ssa-sp*). The *prefix* indicates a private point code (*prefix-msa-ssa-sp*).

**Range:** **p-, 000-255**

Specify a valid value for each subfield of the point code, and separate the subfields with a dash (-).

*prefix*—**p-**

*msa*—**000-255**

*ssa*—**000-255**

*sp*—**000-255**

**:si=** (mandatory)

Service indicator value that designates which user part is assigned to the IPC.

**Range:** **3-15**

**:ssn=** (optional)

SCCP subsystem number. Valid **only** if **si=3**. Use **ssn** as the starting value of the range if **ssne** is specified.

**Range:** **0-255**

**:ssne=** (optional)

Specifies the end of the range of subsystem numbers.

**Range:** **0-255**

**Example**

```
ent-rmt-appl:ipc=0-0-1:si=3:ssn=5
ent-rmt-appl:ipc=0-0-1:si=3:ssn=5:ssne=100
ent-rmt-appl:ipc=0-0-1:si=5
ent-rmt-appl:ipcn24=1-100-1:si=5
ent-rmt-appl:ipc=p-1-1-1:si=3:ssn=5:ssne=102
ent-rmt-appl:ipci=ps-2-2-2:si=5
```

**Dependencies**

Partial point codes are not allowed.

The **ssn** parameter is required if **si=3**.

The **ssn** and **ssne** parameters are not allowed unless **si=3**.

The **ssne** parameter value must be greater than the **ssn** parameter value.

The specified IPC **must** be previously defined in the destination table.

The new entry cannot conflict with an existing entry.

### Notes

To specify a range of subsystem numbers, specify the **ssn** parameter value as the start of the range and the **ssne** parameter value as the end of the range.

In this command, only ITU-international and ITU national point codes support the spare point code subtype prefix (**s-**) and the private and spare point code subtype prefix (**ps-**). All of the point code types support the private (internal) point code subtype prefix (**p-**).

### Output

```
ent-rmt-appl:ipc=0-0-1:si=3:ssn=5
rlghncxa03w 04-01-07 11:11:28 EST EAGLE 31.3.0
ENT-RMT-APPL: MASP A - COMPLTD
;
```

## ent-rte

## Enter Route

Use this command to add a route to the system.



**CAUTION:** When using the Network Routing feature, limited network management is provided for point codes not covered by full point code routing, Cluster Routing, or Nested Cluster Routing.

**Keyword:** ent-rte

**Related Commands:** chg-dstn, dlt-dstn, dlt-rte, ent-dstn, rept-stat-dstn, rept-stat-rte, rtrv-dstn, rtrv-rte

**Command Class:** Database Administration

### Parameters

**NOTE:** See "Point Code Formats and Conversion" for a detailed description of point code formats, rules for specification, and examples.

**:lsn=** (mandatory)

The linkset name associated with this route.

**Range:** ayyyyyyyyy

1 alphabetic character followed by 9 alphanumeric characters

**:rc=** (mandatory)

The relative cost of the route

**Range:** 0-99

**:dpc=** (optional)

ANSI destination point code with subfields *network indicator-network cluster-network cluster member (ni-nc-ncm)*. The *prefix* subfield indicates a private point code (*prefix-ni-nc-ncm*).

**Synonym:** dpca

**Range:** p-, 000-255, \*

Specify a valid value for each subfield of the point code, and separate the subfields with a dash (-).

*prefix*—p-

The asterisk value (\*) is not valid for the *ni* subfield.

When **chg-sid:pctype=ansi** is specified, *ni = 000* is not valid.

When **chg-sid:pctype=ansi** is specified, **nc = 000** is not valid if **ni = 001–005**.

When **chg-sid:pctype=ansi** is specified, **nc = 000** is valid if **ni = 006–255**.

The point code **000-000-000** is not a valid point code.

**:dpc/dpca/dpci/dpcn=** (optional)

Destination point code.

**:dpci=** (optional)

ITU international point code with subfields *zone-area-id*. The *prefix* subfield indicates a spare point code, private point code, or private and spare point code (*prefix-zone-area-id*).

**Range:** **s-, p-, ps-, 0-255**

Specify a valid value for each subfield of the point code, and separate the subfields with a dash (-).

*prefix*—**s-, p-, ps-**

*zone*—**0-7**

*area*—**000-255**

*id*—**0-7**

The point code **0-000-0** is not a valid point code.

**:dpcn=** (optional)

ITU national point code in the format of a 5-digit number (*nnnnn*); or 2, 3, or 4 numbers (members) separated by dashes (*m1-m2-m3-m4*) as defined by the **chg-stpopts:npcfnti** flexible point code option. A group code must be specified when the ITUDUPPC feature is turned on (*nnnnn-gc*, *m1-m2-m3-m4-gc*). The *prefix* subfield indicates a spare point code, private point code, or private and spare point code (*prefix-nnnnn*, *prefix-nnnnn-gc*, *prefix-m1-m2-m3-m4*, *prefix-m1-m2-m3-m4-gc*).

**Range:** **s-, p-, ps-, 0-16383, aa-zz**

Specify a valid value for each subfield of the point code, and separate the subfields with a dash (-).

*prefix*—**s-, p-, ps-**

*nnnnn*—**0-16383**

*gc*—**aa-zz**

*m1-m2-m3-m4*—**0-14** for each member; values must sum to 14

**:dpcn24=** (optional)

24-bit ITU national point code with subfields *main signaling area-sub signaling area-signaling point* (*msa-ssa-sp*). The *prefix* indicates a private point code (*prefix-msa-ssa-sp*).

**Range:** **p-, 000-255**

Specify a valid value for each subfield of the point code, and separate the subfields with a dash (-).

*prefix*—**p-**

*msa*—**000-255**

*ssa*—**000-255**

*sp*—**000-255**

**:force=** (optional)

This parameter allows a route to be added to the database even if the linkset to be assigned to the route does not have any signaling links in it.

**Range:** **yes, no**

**Default:** **no**



**Example**

Adds route for dpc1-1-1 to linkset we123642:

```
ent-rte:dpc=1-1-1:lsn=we123642:rc=25
```

Adds route for dpc21-\*-\* to linkset we123642:

```
ent-rte:dpc=21-*-*:lsn=we123642:rc=25
```

Adds route for dpcn2410-100-14 to linkset we123624:

```
ent-rte:dpcn24=10-100-14:lsn=we123624:rc=10
```

Adds route for private dpcp-1-1-1 to linkset we123642.

```
ent-rte:dpc=p-1-1-1:lsn=we123642:rc=25
```

Adds route for private and spare dpcnps-4082-ge to linkset eIntitun.

```
ent-rte:dpc=ps-4082-ge:lsn=eIntitun:rc=10
```

Adds route for private dpcn24p-10-100-14 to linkset we123642.

```
ent-rte:dpcn24=p-10-100-1:lsn=we123642:rc=10
```

Adds route for private and spare dpcis-1-100-1 to linkset ue123642.

```
ent-rte:dpci=s-10-100-1:lsn=ue123642:rc=10
```

**Dependencies**

The value of the **lsn** parameter must exist in the STP database.

The DPC must be in the Destination Point Code table.

The destination point code of a route must be a full point code (*ni-nc-ncm*), a cluster point code (*ni-nc-\**), or a network point code (*ni-\*-\**).

If the specified destination address is a full point code address (*ni-nc-ncm*) and is a member of a provisioned cluster (*ni-nc-\**), whether ordered routes can be assigned is determined by the destination address's NCAI (nested cluster allowed indicator). The **ncai= yes/no** parameter is set with the **ncai** parameter of the **ent/chg-dstn** commands.

- If the **ncai=no** parameter is specified, destinations comprising a cluster inherit their ordered routes from the cluster.
- If the **ncai=yes** parameter is specified, then the destination address is a member of a provisioned nested cluster where ordered routes can be assigned to a provisioned member.

If the specified destination address is a network cluster address (*ni-nc-\**), the assignment of the specified ordered route attributes is determined by the setting of the destination address's NCAI (nested cluster allowed indicator). The **ncai= yes/no** parameter is set with the **ncai** parameter of the **ent/chg-dstn** commands.

- If the **ncai=no** parameter is specified, the collection of signaling point codes having the same network identifier (the **ni** parameter) and network cluster (the **nc** parameter) code are assigned the specified ordered route.
- If the **ncai=yes** parameter is specified, then the specified destination is a network cluster address where provisioned members's signaling point codes can be assigned the same or different ordered routes from the cluster.

If the **dpcn** parameter is specified, the format of the point code(s) must match the format that was assigned with the **chg-stpopts:npcfmti** parameter.

The **dpc/dpca/dpci/dpcn/dpcn24** parameter cannot be specified with a private point code (-p) unless the route is an IPGW route.

The route destination's type must match the route's linkset adjacent point code or the route's linkset secondary adjacent point code type.

If the **ipgwapc=yes** parameter is specified for the linkset, then the associated **dpc/dpca/dpci/dpcn/dpcn24** parameter cannot have a cluster route assigned.

The linkset must be defined with at least one link. To override this requirement, specify **force=yes**.

The 6-Way Loadsharing on Routesets feature must be turned on before more than 2 routes can be provisioned with the same relative cost.

A linkset can be entered only once as a route for each destination or for a routeset.

If the specified destination address is a network address (*ni-\*-\**), or network cluster address (*ni-nc-\**), the linkset type (see the **chg-ls** command) used in the route must be **b**, **c**, or **d**.

Combined linksets are not allowed for X.25 destinations. Routes of equal cost destined for X.25 domains are not allowed.

If the value of the **dpc/dpca/dpci/dpcn/dpcn24** parameter is assigned to an X.25 domain, then the **lsn** parameter cannot be assigned to an adjacent point code that is assigned to the SS7 domain.

If the value of the **dpc/dpca/dpci/dpcn/dpcn24** parameter is assigned to an SS7 domain, then the **lsn** parameter cannot be assigned to an adjacent point code that is assigned to the X.25 domain.

All routes with ANSI DPCs must use ANSI linkset APCs. A route with an ITU-I DPC can go over an ITU-N APC and an ITU-N DPC can go over an ITU-I APC.

If the link set name (the **lsn** parameter) references a link set that has the **ipgwapc=yes** parameter specified, the DPC must not be a cluster route.

The NRT feature must be turned on before the **dpc/dpca/dpci/dpcn/dpcn24** parameter can be specified.

When using network routing, if the DPC has a value of \* in the *nc* field, the *ncm* field must also be \* (for example, **dpc= 21-\*-\***).

The value of the **dpc/dpca/dpci/dpcn/dpcn24** parameter cannot be the same as the EAGLE 5 ISS capability point code.

The value of the **dpc/dpca/dpci/dpcn/dpcn24** parameter cannot be the same as the EAGLE 5 ISS capability point code.

The value of the **dpc/dpca/dpci/dpcn/dpcn24** parameter cannot have already been assigned to an APC or SAPC for an IPGWx linkset. The entered route must include the APC or SAPC's linkset with the destination equal to the APC or SAPC.

If **dpcn** is specified then the format of **dpcn** must match the format dictated by the **npcfmti** parameter via the **chg-stpopts** command

The STP shall ensure that the ITU-N ordered route destination's group code must match the route's Link Set Adjacent PC's group code for all linksets other than IPGWI and IPLIMI.

The group code must match for all linksets because the ITU Duplicate Point Code feature is on.

All linksets in a routeset must have the same network type. The network type of the routeset must be the same as the network type of the destination point code.

If multiple routes are defined for the destination point code, and if a proxy point code is assigned to the destination point code, then the first route defined in the **ent-rte** command must use the proxy linkset.

If the **dpc** parameter has a network cluster address (*ni-nc-\**) or network address (*ni-\*-\**), then the **lst=prx** parameter cannot be specified.

**Notes**

In this command, only ITU-international and ITU national point codes support the spare point code subtype prefix (**s-**) and the private and spare point code subtype prefix (**ps-**). All of the point code types support the private (internal) point code subtype prefix (**p-**).

**Output**

```
ent-rte:dpc=1-1-1:lsn=we123642:rc=25
rlghncxa03w 04-01-07 11:11:28 EST EAGLE 31.3.0
ENT-RTE: MASP A - COMPLTD
;
```

**ent-rtx****Enter Exception Route**

Use this command to enter an exception route entry. An exception route is associated with an entry in the Routing table. When the Origin-Based MTP Routing feature is enabled and turned on, the least cost route available for an MSU to be routed to a Destination Point Code over a specified linkset is used. See the *Database Administration - Features* manual for more information about determining routes for linksets.

Up to 6 routes can be defined to a single entry in the Routing table. Up to 8000 routesets can be defined for an STP. This total must include at least one normal route (not an exception route). The remaining 7999 routesets can include any combination of normal and exception routes.

**NOTE: A routeset is a collection of routes to a destination. Each routeset can have up to 6 routes, with 16 links on each route. An exception routeset is a collection of up to 6 exception routes that have the same DPC, exception class, and criteria.**

**Keyword:** ent-rtx

**Related Commands:** chg-rtx, dlt-rtx, rept-stat-rtx, rtrv-rtx

**Command Class:** Database Administration

**Parameters**

**:dpc=** (mandatory)

ANSI destination point code with subfields *network indicator-network cluster-network cluster member (ni-nc-ncm)*. The *prefix* subfield indicates a private point code (*prefix-ni-nc-ncm*).

**Synonym:** dpca

**Range:** p-, 000-255

Specify a valid value for each subfield of the point code, and separate the subfields with a dash (-).

*prefix—p-*

When **chg-sid:pctype=ansi** is specified, *ni = 000* is not valid.

When **chg-sid:pctype=ansi** is specified, *nc = 000* is not valid if *ni = 001-005*.

When **chg-sid:pctype=ansi** is specified, *nc = 000* is valid if *ni = 006-255*.

The point code **000-000-000** is not a valid point code.

**:dpc/dpca/dpci/dpcn/dpcn24=** (mandatory)

Destination point code.

**:dpci=** (mandatory)

ITU international point code with subfields *zone-area-id*. The *prefix* subfield indicates a spare point code, private point code, or private and spare point code (*prefix-zone-area-id*).

**Range:** s-, p-, ps-, 0-255

Specify a valid value for each subfield of the point code, and separate the subfields with a dash (-).

*prefix*—**s-, p-, ps-**

*zone*—**0-7**

*area*—**000-255**

*id*—**0-7**

The point code **0-000-0** is not a valid point code.

**:dpcn=** (mandatory)

ITU national point code in the format of a 5-digit number (*nnnnn*); or 2, 3, or 4 numbers (members) separated by dashes (*m1-m2-m3-m4*) as defined by the **chg-stpopts:npcfmit** flexible point code option. A group code must be specified when the ITUDUPPDC feature is turned on (*nnnnn-gc, m1-m2-m3-m4-gc*). The *prefix* subfield indicates a spare point code, private point code, or private and spare point code (*prefix-nnnnn, prefix-nnnnn-gc, prefix-m1-m2-m3-m4, prefix-m1-m2-m3-m4-gc*).

**Range:** **s-, p-, ps-, 0-16383, aa-zz**

Specify a valid value for each subfield of the point code, and separate the subfields with a dash (-).

*prefix*—**s-, p-, ps-**

*nnnnn*—**0-16383**

*gc*—**aa-zz**

*m1-m2-m3-m4*—**0-14** for each member; values must sum to 14

**:dpcn24=** (mandatory)

24-bit ITU national point code with subfields *main signaling area-sub signaling area-signaling point* (*msa-ssa-sp*). The *prefix* subfield indicates a private point code (*prefix-msa-ssa-sp*).

**Range:** **p-, 000-255**

Specify a valid value for each subfield of the point code, and separate the subfields with a dash (-).

*prefix*—**p-**

*msa*—**000-255**

*ssa*—**000-255**

*sp*—**000-255**

**:lsn=** (mandatory)

Linkset Name. This parameter specifies the name of the linkset that is associated with the specified exception route.

**Range:** *ayyyyyyyyy*

1 alphabetic character followed by up to 9 alphanumeric characters.

**:rc=** (mandatory)

Relative Cost. This parameter is the relative cost associated with the specified exception route.

**Range:** **0-99**

**:cic=** (optional)

Starting Circuit Identification Code. This parameter is used alone or together with the **ecic** parameter as exception routing criteria for the specified exception route.

**Range:** **0-16383**

**:ecic=** (optional)

Ending Circuit Identification Code. This parameter, together with the **cic** parameter, defines the CIC range that is used as exception routing criteria for the specified exception route.

**Range:** **0-16383**

**:force=** (optional)

The **force=yes** parameter must be specified when the **ilsn** parameter value is the same as the **lsn** parameter value.

**Range:**     **yes**

**:ilsn=** (optional)

Incoming Link Set Name. This parameter contains the name of the originating linkset. The parameter value is used as part of the exception routing criteria for the specified exception route.

**Range:**     *ayyyyyyyyy*  
1 alphabetic character followed by up to 9 alphanumeric characters.

**:opc=** (optional)

ANSI origination point code with subfields *network indicator-network cluster-network cluster member (ni-nc-ncm)*. The *prefix* subfield indicates a private point code (*prefix-ni-nc-ncm*).

**Synonym:** **opca**

**Range:**     **p-, 000-255**

Specify a valid value for each subfield of the point code, and separate the subfields with a dash (-).

*prefix*—**p-**

When **chg-sid:pctype=ansi** is specified, *ni = 000* is not valid.

When **chg-sid:pctype=ansi** is specified, *nc = 000* is not valid if *ni = 001-005*.

When **chg-sid:pctype=ansi** is specified, *nc = 000* is valid if *ni = 006-255*.

The point code **000-000-000** is not a valid point code.

**:opci=** (optional)

ITU international point code with subfields *zone-area-id*. The *prefix* subfield indicates a spare point code, private point code, or private and spare point code (*prefix-zone-area-id*).

**Range:**     **s-, p-, ps-, 0-255**

Specify a valid value for each subfield of the point code, and separate the subfields with a dash (-).

*prefix*—**s-, p-, ps-**

*zone*—**0-7**

*area*—**000-255**

*id*—**0-7**

The point code **0-000-0** is not a valid point code.

**:opcn=** (optional)

ITU national point code in the format of a 5-digit number (*nnnnn*); or 2, 3, or 4 numbers (members) separated by dashes (*m1-m2-m3-m4*) as defined by the **chg-stpopts:npfmit** flexible point code option. A group code must be specified when the ITUDUPPDC feature is turned on (*nnnnn-gc*, *m1-m2-m3-m4-gc*). The *prefix* subfield indicates a spare point code, private point code, or private and spare point code (*prefix-nnnnn*, *prefix-nnnnn-gc*, *prefix-m1-m2-m3-m4*, *prefix-m1-m2-m3-m4-gc*).

**Range:**     **s-, p-, ps-, 0-16383, aa-zz**

Specify a valid value for each subfield of the point code, and separate the subfields with a dash (-).

*prefix*—**s-, p-, ps-**

*nnnnn*—**0-16383**

*gc*—**aa-zz**

*m1-m2-m3-m4*—**0-14** for each member; values must sum to 14

**:opcn24=** (optional)

24-bit ITU national point code with subfields *main signaling area-sub signaling area-signaling point (msa-ssa-sp)*. The *prefix* subfield indicates a private point code (*prefix-msa-ssa-sp*).

**Range:** **p-, 000-255**

Specify a valid value for each subfield of the point code, and separate the subfields with a dash (-).

*prefix*—**p-**

*msa*—**000-255**

*ssa*—**000-255**

*sp*—**000-255**

**:si=** (optional)

Service Indicator. This parameter is used as part of the exception routing criteria for the specified exception route.

**Range:** **3-15**

### Example

```
ent-rtx:dpc=1-1-1:opca=2-3-3:lsn=1set1:rc=30
```

```
ent-rtx:dpc=1-3-1:ilsn=1set2:lsn=1set3:rc=20
```

```
ent-rtx:dpc=2-100-1:si=5:lsn=1set5:rc=50
```

### Dependencies

Only one of the **opc**, **ilns**, **cic**, or **si** parameters can be specified for an exception route entry.

For an ANSI origination point code that is defined using asterisks (**nnn-\*-\***), the value of the *network identifier* subfield (*nnn*) must be greater than **5**.

If the **ecic** parameter is specified, the **cic** parameter must also be specified.

The **ecic** parameter value cannot be less than the **cic** parameter value.

The **opc** parameter value cannot be the same as the **dpc** parameter value.

The Origin-Based MTP Routing feature must be enabled and turned on before this command can be entered.

The point code specified by the **dpc**, **dpca**, **dpci**, **dpcn**, or **dpcn24** parameter must already exist in the Route table.

The value specified for the **dpc** parameter cannot already be used as an adjacent point code (APC).

The linkset name, as defined by the **ilsn** or **lsn** parameter, must exist.

An exception route entry cannot already exist with the same input parameter values, other than the relative cost.

The 6-Way Loadsharing on Routesets feature must be turned on before more than 2 routes can be provisioned with the same relative cost for a given exception route criteria.

A maximum of 6 exception routes can be associated with the specified DPC and criteria.

A maximum total of 8000 exception routes and normal routes can be defined for the EAGLE 5 ISS. At least one route must be a normal (not exception) route. The remaining routes (up to 7999) can be all normal routes, all exception routes, or any combination of normal and exception routes.

The network domain of the adjacent point code in the linkset or of the routes in the specified routeset must be the same as the network domain of the specified destination point code or its alias.

The adjacent or secondary point code type and group code of the linkset or linksets in the specified routeset must match the point code type and group code of the destination point code.

The specified CIC/ECIC range must not overlap an existing range.

If the **ilsn** and **lsn** parameter have the same value, or if the value specified for the **opc** parameter is the same as the APC of the linkset specified by the **lsn** parameter, then the **force=yes** parameter must be specified.

The **opcn** parameter must be in the same ITU-N group as the **dpcn** parameter.

The Group Code of the APCN in the **ilsn** parameter must be the same as the Group Code of the **dpcn** parameter.

ANSI network routing and cluster point codes as OPC exception route criteria are not allowed for ITU destinations.

ITU point codes as OPC exception route criteria are not allowed for ANSI Network and Cluster destination.

If the **lsn** parameter is specified, then the **rc** parameter must be specified.

If a proxy destination is used, then this command cannot be entered.

The value specified for the destination point code must be a full point code and not a cluster or network point code.

The destination point code specified by the **dpc** parameter must have routes provisioned.

An exception route cannot be assigned to cluster members.

An exception route cannot be assigned to cluster members.

The value specified for the **opc** parameter cannot be the same as the adjacent point code of the linkset specified by the **lsn** parameter.

## Output

```
ent-rtx:dpci=2-100-1:si=5:lsn=1set5:rc=50
stdcfg2b 06-05-19 18:20:11 EST EAGLE 35.0.0
ENT-RTX: MASP A - COMPLTD
```

## ent-scr-aftpc

### Enter Allowed Affected Point Code

Use this command to add a specific allowed affected point code (AFTPC) screening reference in the AFTPC entity set.

**Keyword:** ent-scr-aftpc

**Related Commands:** chg-scr-aftpc, dlt-scr-aftpc, rtrv-scr-aftpc

**Command Class:** Database Administration

## Parameters

**NOTE:** See "Point Code Formats and Conversion" for a detailed description of point code formats, rules for specification, and examples.

**:nsfi=** (mandatory)

This parameter specifies the next screening category that is used in the gateway screening process. If specified, the parameter value must be **stop**.

**Range:** stop

**stop**— The gateway screening process ends and the message proceeds through normal routing.

**:sr=** (mandatory)

Screening reference. This parameter specifies the point code's unique screening reference name.

**Range:** ayyy

1 alphabetic character followed by up to 3 alphanumeric characters

- :ssn=** (mandatory)  
The subsystem number. An asterisk (\*) indicates the full range of values from **1-255**.  
**Range:** **1-255 \***
- :actname=** (optional)  
The name of the gateway screening stop action set. Stop actions must be administered using the **actname** parameter in conjunction with the gateway screening stop action table (see **chg-gws-actset** and **rtrv-gws-actset**).  
**Range:** *ayyyyy*  
1 alphabetic character followed by up to 5 alphanumeric characters.
- :area=** (optional)  
The ITU international area. The area is specified in the point code. The format of the point code is *zone-area-id*. An asterisk (\*) indicates the full range of values from **000-255**.  
**Range:** **000-255 \***
- :id=** (optional)  
The ITU international ID. The parameter specifies the ID in the point code represented by format *zone-area-id*. An asterisk (\*) indicates the full range of values from **0-7**.  
**Range:** **0-7, \***
- :msa=** (optional)  
The 24-bit ITU-national main signaling area (msa) value. It specifies the **msa** of the point code represented by *msa-ssa-sp*. An asterisk (\*) indicates the full range of values from **000-255**.  
**Range:** **000-255 \***
- :nc=** (optional)  
The network cluster (nc) value. This parameter specifies one or more nc values for the network indicator (ni) and network cluster member (ncm) values specified in the **ni** and **ncm** parameters. It specifies the *nc* of the point code represented by *ni-nc-ncm*. A single value or a range of values can be specified. An asterisk (\*) indicates the full range of values from **000-255**.  
**Range:** **000-255 \***
- :ncm=** (optional)  
The network cluster member (ncm) value. This parameter specifies one or more ncm values for the network indicator (ni) and network cluster (nc) values identified in the **ni** and **nc** parameters. It specifies the *ncm* of the point code represented by *ni-nc-ncm*. A single value or a range of values can be specified. An asterisk (\*) indicates the full range of values from **000-255**.  
**Range:** **0-255 \***
- :ni=** (optional)  
The network indicator (ni) value. This parameter specifies one or more ni values for the network cluster (nc) and network cluster member (ncm) values identified in the **nc** and **ncm** parameters. It specifies the *ni* of the point code represented by *ni-nc-ncm*. A single value or a range of values can be specified. An asterisk (\*) indicates the full range of values from **000-255**.  
**Range:** **0-255 \***
- :npc=** (optional)  
The ITU national point code. An asterisk (\*) indicates the full range of values from **00000-16383**.  
**NOTE: Gateway screening allows the ITU national point code to be displayed and entered in the database only as a single number. If you are using multiple-part ITU national point codes, see "Converting ITU National Point Code Formats" in Appendix A for information on converting the point code format.**  
**Range:** **00000-16383 \***



**:nsr=** (optional)

Next screening reference (nsr). The parameter indicates which screening reference in the specified screening category (**nsfi**) is to be used in the screening process. If **nsfi=stop**, the **nsr** parameter cannot be specified.

**Range:** *ayyy*

1 alphabetic character followed by up to 3 alphanumeric characters

**Default:** Current value

**:pcst=** (optional)

Point code subtype. This parameter indicates whether the specified ITU international or ITU national point code has no subtype prefix or has the spare point code prefix (**s-**).

**Range:** **none, s**

**Default:** **none**

**:sp=** (optional)

The 24-bit ITU national signaling point. This parameter specifies the signaling point (**sp**) in the point code represented by *msa-ssa-sp*. An asterisk (\*) indicates the full range of values from **000-255**.

**Range:** **000-255 \***

**:ssa=** (optional)

The 24-bit ITU national sub signaling area. This parameter specifies the sub signaling area (**ssa**) in the point code represented by the format *msa-ssa-sp*. An asterisk (\*) indicates the full range of values from **000-255**.

**Range:** **000-255 \***

**:zone=** (optional)

The ITU international zone. The parameter specifies the zone in the point code represented by format *zone-area-id*. An asterisk (\*) indicates the full range of values from **0-7**.

**Range:** **0-7 \***

**Example**

```
ent-scr-aftpc:sr=iec:ni=240:nc=010:ncm=010:ssn=012:nsfi=stop
```

```
ent-scr-
```

```
aftpc:sr=iec:ni=240:nc=010:ncm=010:ssn=012:nsfi=stop:actname=copy
```

```
ent-scr-aftpc:nsfi=stop:sr=af01:ssn=1:msa=255:ssa=255:sp=255
```

```
ent-scr-aftpc:sr=aft1:zone=1:area=2:id=3:nsfi=stop:ssn=1:pcst=s
```

**Dependencies**

**CAUTION:** Even though gateway screening is in the screen test mode, as defined by the parameters **gwsa=off** and **andgws=on**, the gateway screening action in the stop action set specified by the **actname** parameter of the screen set *will* be performed at the end of the screening process.

A complete point code must be specified, and must be one, and only one of the four point code parameter combinations: **ni-nc-ncm**; **zone-area-id**; **msa-ssa-sp**; or **npc**.

ANSI point code value **000-000-000** and ITU-International point code value **0-000-0** are not allowed.

The value of the **actname** parameter must already be defined in the Gateway Screening Stop Action table with the **chg-gws-actset** command. These values are shown in the *ACTNAME* field of the **rtrv-gws-actset** command output.

The character **c** is not a valid value for the **ni**, **nc**, **ncm**, **zone**, **area**, **id**, **msa**, **ssa**, **sp**, and **npc** parameters.

If **zone=\*** is specified, **area=\*** and **id=\*** must be specified.

If **area=\*** is specified, **id=\*** must be specified.

If **msa=\*** is specified, **ssa=\*** and **sp=\*** must be specified.

If **ssa=\*** is specified, **sp=\*** must be specified.

If specified, the **nsfi** parameter value must be **stop**.

If the **nsfi=stop** parameter is specified, the **nsr** parameter cannot be specified.

If the screening reference exists (**sr**), the new affected point code and subsystem number to be added cannot already exist in the AFTPC entity set.

The Spare Point Code Support feature must be enabled before the **pcst** parameter can be specified.

The spare point code subtype prefix (**s-**) is not supported for ANSI point codes (parameters **ni**, **nc**, **ncm**) or for 24-bit ITU national point codes (parameters **msa**, **ssa**, **sp**). The **pcst** and **npcst** parameters cannot be specified for ANSI and ITU-N24 point codes.

The Gateway Screening Rules table can contain a maximum of 372,600 rules.

If the **nc** parameter is specified as a range, the **ncm** parameter must be specified as an asterisk or as the full range **000–255**

If the **nc** parameter is specified as a single value or a range, a single value must be specified for the **ni** parameter.

If the **nc** parameter is specified as an asterisk (**nc=\***), the **ncm** parameter must be specified as an asterisk or as the full range **000–255**.

If the **ncm** parameter is specified as a single value, or a range other than the full range of **000–255**, the **ni** and the **nc** parameters must be specified with a single value.

If the **ni** parameter is specified as an asterisk (**ni=\***) or as a range, the **nc** and **ncm** parameters must be specified as an asterisk or as the full range **000–255**.

## Notes

A range of values is specified by separating the values that define the range by two ampersands (**&&**); for example, **:ni=025&&100** specifies all network indicators for ANSI point codes from **25** to **100**.

If the screening reference is valid, but does not exist, a new AFTPC screen is created.

If the screening reference exists, a new rule is added to the AFTPC screening table.

If asterisks or ranges are specified for the allowed AFTPCs, nothing that matches the specified range of AFTPCs can already exist in the AFTPC screen for the screening reference.

If the screen set reaches 100% capacity (indicated by the 100% Full message), the system allows subsequent entries. An error occurs, however, when downloading the screen set to an LIM. Ensure that screen sets do not exceed 100% capacity. Remove screen set entries until the capacity is below 100%.

An asterisk cannot not be specified for a parameter value in this command unless an asterisk was specified for the parameter value in the original **ent-scr-aftpc** command.

The spare point code subtype prefix **s-** is supported only for ITU international and ITU national point codes. The **pcst** parameter indicates whether the specified point code has no subtype prefix to has the spare point code prefix.

**Output**

```
ent-scr-aftpc:sr=iec:ni=240:nc=010:ncm=010:ssn=012:nsfi=stop
rlghncxa03w 04-01-07 11:43:04 EST EAGLE 31.3.0
ENT-SCR-AFTPC: SCREEN SET AFFECTED - IEC 25% FULL
ENT-SCR-AFTPC: MASP A - COMPLTD
;
```

**Legend**

**ENT-SCR-AFTPC**—The command entered that caused this output. This is echoed to the printer as a reference.

**SCREEN SET AFFECTED - IEC**—Identifies the screen set that was affected by the command. The screen set name is provided.

**25% FULL**—Indicates the relative size of the screen set.

**ent-scr-blkdpc****Enter Blocked DPC**

Use this command to add a specific blocked destination point code (BLKDPC) screening reference, and associated attributes, to the BLKDPC's table. The associated attributes are: destination point code, next screening function identifier, and next screening reference. The destination point codes listed on this screen are prohibited from sending SS7 messages to the network.

**Keyword:** ent-scr-blkdpc

**Related Commands:** chg-scr-blkdpc, dlt-scr-blkdpc, rtrv-scr-blkdpc

**Command Class:** Database Administration

**Parameters**

**:nsfi=** (mandatory)

This parameter specifies the next screening category that is used in the gateway screening process, or it indicates that the gateway screening process should stop.

**Range:** cgpa, destfld, fail, isup, stop

**cgpa**— Allowed CGPA is the next screening category.

**destfld**— Allowed destination field (DESTFLD) is the next screening category.

**fail**— Discard the received message.

**isup**— ISUP message type (ISUP) is the next screening category.

**stop**— The gateway screening process ends and the message proceeds through normal routing.

**:sr=** (mandatory)

Screening reference. This parameter specifies the point code's unique screening reference name.

**Range:** ayyy

1 alphabetic character followed by up to 3 alphanumeric characters

**:actname=** (optional)

The name of the gateway screening stop action set. Stop actions must be administered using the **actname** parameter in conjunction with the gateway screening stop action table (see **chg-gws-actset** and **rtrv-gws-actset**).

**Range:** ayyyyy

1 alphabetic character followed by up to 5 alphanumeric characters.

**:area=** (optional)

The ITU international area. The area is specified in the point code. The format of the point code is *zone-area-id*. An asterisk (\*) indicates the full range of values from **000-255**.

**Range:** 000-255 \*

**:id=** (optional)

The ITU international ID. The parameter specifies the ID in the point code represented by format *zone-area-id*. An asterisk (\*) indicates the full range of values from **0–7**.

**Range:** **0-7, \***

**:msa=** (optional)

The 24-bit ITU-national main signaling area (msa) value. It specifies the **msa** of the point code represented by *msa-ssa-sp*. An asterisk (\*) indicates the full range of values from **000-255**.

**Range:** **000-255 \*, C**

**:nc=** (optional)

The network cluster (nc) value. This parameter specifies one or more nc values for the network indicator (ni) and network cluster member (ncm) values specified in the **ni** and **ncm** parameters. It specifies the *nc* of the point code represented by *ni-nc-ncm*. A single value or a range of values can be specified. An asterisk (\*) indicates the full range of values from **000–255**.

**Range:** **000-255 \*, C**

**:ncm=** (optional)

The network cluster member (ncm) value. This parameter specifies one or more ncm values for the network indicator (ni) and network cluster (nc) values identified in the **ni** and **nc** parameters. It specifies the *ncm* of the point code represented by *ni-nc-ncm*. A single value or a range of values can be specified. An asterisk (\*) indicates the full range of values from **000–255**.

**Range:** **0-255 \*, C**

**:ni=** (optional)

The network indicator (ni) value. This parameter specifies one or more ni values for the network cluster (nc) and network cluster member (ncm) values identified in the **nc** and **ncm** parameters. It specifies the *ni* of the point code represented by *ni-nc-ncm*. A single value or a range of values can be specified. An asterisk (\*) indicates the full range of values from **000–255**.

**Range:** **0-255 \*, C**

**:npc=** (optional)

The ITU national point code. An asterisk (\*) indicates the full range of values from **00000–16383**.

**NOTE: Gateway screening allows the ITU national point code to be displayed and entered in the database only as a single number. If you are using multiple-part ITU national point codes, see "Converting ITU National Point Code Formats" in Appendix A for information on converting the point code format.**

**Range:** **00000-16383 \*, C**

**:nsr=** (optional)

The next screening reference parameter indicates which screening reference in the specified screening category (**nsfi**) is to be used in the screening process. This parameter is mandatory if **nsfi** is other than **stop** or **fail**. The **nsr** parameter cannot be specified if **nsfi** is **stop** or **fail**.

**Range:** *ayyy*

1 alphabetic character followed by up to 3 alphanumeric characters

**Default:** No value given

**:pcst=** (optional)

Point code subtype. This parameter indicates whether the specified ITU international or ITU national point code has no subtype prefix or has the spare point code prefix (**s-**).

**Range:** **none, s**

**Default:** **none**

**:sp=** (optional)

The 24-bit ITU national signaling point. This parameter specifies the signaling point (sp) in the point code represented by *msa-ssa-sp*. An asterisk (\*) indicates the full range of values from **000-255**.

**Range:** **000-255** \*, C

**:ssa=** (optional)

The 24-bit ITU national sub signaling area. This parameter specifies the sub signaling area (ssa) in the point code represented by the format *msa-ssa-sp*. An asterisk (\*) indicates the full range of values from **000-255**.

**Range:** **000-255** \*, C

**:zone=** (optional)

The ITU international zone. The parameter specifies the zone in the point code represented by format *zone-area-id*. An asterisk (\*) indicates the full range of values from **0-7**.

**Range:** **0-7**, \*, C

### Example

```
ent-scr-blkdpc:sr=iec:ni=c:nc=c:ncm=c:nsfi=cgpa:nsr=wrds5
ent-scr-blkdpc:sr=iec:ni=c:nc=c:ncm=c:nsfi=stop
ent-scr-blkdpc:sr=iec:ni=c:nc=c:ncm=c:nsfi=stop:actname=copy
ent-scr-blkdpc:sr=iec:ni=240:nc=*:ncm=*:nsfi=fail
ent-scr-blkdpc:sr=bdp1:zone=1:area=2:id=3:nsfi=fail:pcst=none
ent-scr-blkdpc:sr=bdp1:zone=2:area=2:id=3:nsfi=fail:pcst=s
ent-scr-blkdpc:sr=bdp1:npc=128:nsfi=fail:pcst=s
```

### Dependencies



**CAUTION:** Even though gateway screening is in the screen test mode, as defined by the parameters **gwsa=off** and **andgws=on**, the gateway screening action in the stop action set specified by the **actname** parameter of the screen set *will* be performed at the end of the screening process.

The Gateway Screening Rules table can contain a maximum of 362, 700 rules.

A complete point code must be specified, using the **ni-nc-ncm**, **zone-area-id**, **msa-ssa-sp**, or **npc** combination unless a value of **c** for “continue” is specified.

ANSI point code value **000-000-000** and ITU-International point code value **0-000-0** are not allowed.

At least one optional parameter must be specified.

When a blocked DPC screen is created, the first entry for the **ni-nc-ncm zone-area-id**, or **msa-ssa-sp** must be **c-c-c** or **npc** must be **c**. Subsequent entries can be specific point codes.

If the **actname** parameter is specified, then the **nsfi=stop** parameter must be specified.

The value of the **actname** parameter must already be defined in the Gateway Screening Stop Action table with the **chg-gws-actset** command. These values are shown in the *ACTNAME* field of the **rtrv-gws-actset** command output.

If the **area=\*** parameter is specified, then the **id=\*** parameter must be specified.

If the **msa=\*** parameter is specified, then the **ssa=\*** and the **sp=\*** parameters must be specified.

If the **msa=c** parameter is specified, then the **ssa** and the **sp** parameters must have a value of **c** or must not be specified. If the **msa=c** parameter is specified, and the **ssa** and the **sp** parameters are not specified, then the **ssa** and **sp** parameters default to a value of **c**.

If the **nc** parameter is specified as a range, the **ncm** parameter must be specified as an asterisk or as the full range **000–255**

If the **nc** parameter is specified as a single value or a range, a single value must be specified for the **ni** parameter.

If the **nc** parameter is specified as an asterisk (**nc=\***), the **ncm** parameter must be specified as an asterisk or as the full range **000–255**.

If the **ncm** parameter is specified as a single value, or a range other than the full range of **000–255**, the **ni** and the **nc** parameters must be specified with a single value.

If the **ni** parameter is specified as an asterisk (**ni=\***) or as a range, the **nc** and **ncm** parameters must be specified as an asterisk or as the full range **000–255**.

If the **ni=c** parameter is specified, then the **nc** and the **ncm** parameters must have a value of **c** or must not be specified. If the **ni=c** parameter is specified, and the **nc** and the **ncm** parameters are not specified, then the **nc** and **ncm** parameters default to a value of **c**.

If the specified **ni-nc-ncm**, **zone-area-id**, or **msa-ssa-sp** is not equal to **c-c-c**, or if the **npc=c** parameter is not specified, then the **nsfi=fail** parameter must be specified, and the **nsr** parameter cannot be specified.

If the **nsfi** parameter has a value other than **stop** or **fail**, the **nsr** parameter must be specified and must exist.

The **nsfi** and **nsr** parameters must point to an existing screen, or the **nsfi=stop** parameter must be specified, and the **nsr** parameter cannot be specified.

If the **sr** does not exist, then the **ni-nc-ncm**, **zone-area-id**, or **msa-ssa-sp** parameters must equal **c-c-c**, or the **npc=c** parameter must be specified, and the **nsfi=fail** parameter cannot be specified.

If the specified screening reference (**sr**) exists:

- The **ni-nc-ncm zone-area-id** , or **msa-ssa-sp must equal c-c-c** or **npc** must not equal **c**.
- The **nsfi** parameter must be **fail** .
- The **nsr** parameter cannot be specified.
- The blocked DPC, given by **ni-nc-ncm** (or **zone-area-id** or **npc**), to be added to the BLKDPC screening table for the blocked DPC screening reference cannot exist as defined or within an existing range of DPCs.

The Spare Point Code Support feature must be enabled before the **pcst** parameter can be specified.

The **pcst** parameter cannot be specified with **c** for a blocked screen reference (**sr**).

The spare point code subtype prefix (**s-**) is not supported for ANSI point codes (parameters **ni**, **nc**, **ncm**) or for 24-bit ITU national point codes (parameters **msa**, **ssa**, **sp**). The **pcst** parameter cannot be specified for ANSI and ITU-N24 point codes.

If the **ssa=\*** parameter is specified, then the **sp=\*** parameter must be specified.

If the **zone=\*** parameter is specified, then the **area=\*** and the **id=\*** parameters must be specified.

If the **zone=c** parameter is specified, then the **area** and the **id** parameters must have a value of **c** or must not be specified. If the **zone=c** parameter is specified, and the **area** and the **id** parameters are not specified, then the **area** and **id** parameters default to a value of **c**.

The value of the **nsfi** parameter must be valid for the BLKDPC entity type.

If a blocked screen reference exists, then the **ni**, **zone**, **msa**, and **npc** parameters cannot have a value of **c**.

## Notes

When a blocked DPC screening reference is created, the first entry for a point code must be **c-c-c**, or **c** for the **npc** parameter. Subsequent entries must be specific point codes.

The character **c** is used in the blocked DPC screens to allow the screening process to continue for messages with point codes that do not match any point codes in the blocked DPC screens. When screening for a blocked DPC and the point code being screened does not match any of the point codes in the blocked DPC screens, the message is not rejected and the screening process continues.

There must be an entry in the blocked DPC screens to allow the screening process to continue. This entry consists of a screening reference, point code, **nsfi**, and **nsr**. The point code is in the form of **npc=c** or of subfields equal to **c-c-c**. When the character **c** is specified, the **nsfi** and **nsr** parameters must be specified.

If the character **c** is specified for the parameters **ni-nc-ncm** or **zone-area-id** or **msa-ssa-sp**, the character **c** is the only value that can be specified for all three parameters. No other values can be used. For example, a point code **c-c-255** is not allowed. The point code must be **c-c-c**. The asterisk (\*) value cannot be used with the character **c** (for example, a point code **c-c-\*** is not allowed).

When the point code does not match any entries in the blocked DPC screens, the screening process is directed to the screening reference with the point code **c-c-c** or **npc=c**. The **nsfi** and **nsr** in this entry are examined to determine the next step in the screening process.

If the current **ni-nc-ncm** or **zone-area-id** or **msa-ssa-sp** is equal to **c-c-c** or **npc=c**, only the **nsfi** and **nsr** parameters can be changed. Otherwise, only the blocked DPC can be changed.

A range of values is specified by separating the values that define the range by two ampersands (&&); for example, **: ni=025&&100** specifies all network indicators for ANSI point codes from **25** to **100**.

An asterisk cannot not be specified for a parameter value in this command unless an asterisk was specified for the parameter value in the original **ent-scr-blkdpc** command.

If the screen set reaches 100% capacity (indicated by the 100% Full message), the system allows subsequent entries. An error occurs, however, when downloading the screen set to an LIM. Ensure that screen sets do not exceed 100% capacity. Remove screen set entries until the capacity is below 100%.

The spare point code subtype prefix **s-** is supported only for ITU international and ITU national point codes. The **pcst** parameter indicates whether the specified point code has no subtype prefix or has the spare point code prefix.

## Output

```
ent-scr-blkdpc:sr=iec:ni=c:nc=c:ncm=c:nsfi=cgpa:nsr=wrds5
rlghncxa03w 04-01-07 11:43:04 EST EAGLE 31.3.0
ENT-SCR-BLKDPC: SCREEN SET AFFECTED - IEC 25% FULL
ENT-SCR-BLKDPC: MASP A - COMPLTD
;
```

### Legend

**ENT-SCR-BLKDPC**—The command entered that caused this output. This is echoed to the printer as a reference.

**SCREEN SET AFFECTED - SS01**—Identifies the screen set that was affected by the command. The screen set name is provided.

**25% FULL**—Indicates the relative size of the screen set.

**ent-scr-blkopc****Enter Blocked OPC**

Use this command to add a specific blocked originating point code (BLKOPC) screening reference and associated attributes OPC, **nsfi**, and **nsr** to the BLKOPC entity set. Any messages received on the link assigned to this screening reference that match the attributes in this table are blocked from entering the network.

**Keyword:** ent-scr-blkopc

**Related Commands:** chg-scr-blkopc, dlt-scr-blkopc, rtrv-scr-blkopc

**Command Class:** Database Administration

**Parameters**

**:nsfi=** (mandatory)

This parameter specifies the next screening category that is used in the gateway screening process, or it indicates that the gateway screening process should stop.

**Range:** **blkdpc, cgpa, dpc, fail, sio, stop**

**blkdpc**— Blocked DPC is the next screening category.

**cgpa**— Allowed CGPA is the next screening category.

**dpc**— Allowed DPC is the next screening category.

**fail**— Discard the received message.

**sio**— Allowed SIO is the next screening category.

**stop**— The gateway screening process ends and the message proceeds through normal routing.

**:sr=** (mandatory)

Screening reference. This parameter specifies the point code's unique screening reference name.

**Range:** *ayyy*

1 alphabetic character followed by up to 3 alphanumeric characters

**:actname=** (optional)

The name of the gateway screening stop action set. Stop actions must be administered using the **actname** parameter in conjunction with the gateway screening stop action table (see **chg-gws-actset** and **rtrv-gws-actset**).

**Range:** *ayyyyy*

1 alphabetic character followed by up to 5 alphanumeric characters.

**:area=** (optional)

The ITU international area. The area is specified in the point code. The format of the point code is *zone-area-id*. An asterisk (\*) indicates the full range of values from **000–255**.

**Range:** **000-255** \*, C

**:id=** (optional)

The ITU international ID. The parameter specifies the ID in the point code represented by format *zone-area-id*. An asterisk (\*) indicates the full range of values from **0–7**.

**Range:** **0-7** \*, C

**:msa=** (optional)

The 24-bit ITU-national main signaling area (msa) value. It specifies the **msa** of the point code represented by *msa-ssa-sp*. An asterisk (\*) indicates the full range of values from **000–255**.

**Range:** **000-255** \*, C

**:nc=** (optional)

The network cluster (nc) value. This parameter specifies one or more nc values for the network indicator (ni) and network cluster member (ncm) values specified in the **ni** and **ncm** parameters. It



specifies the *nc* of the point code represented by *ni-nc-ncm*. A single value or a range of values can be specified. An asterisk (\*) indicates the full range of values from **000–255**.

**Range:** **000-255** \*, C, && (Allow intervals)

**:ncm=** (optional)

The network cluster member (ncm) value. This parameter specifies one or more ncm values for the network indicator (ni) and network cluster (nc) values identified in the **ni** and **nc** parameters. It specifies the *ncm* of the point code represented by *ni-nc-ncm*. A single value or a range of values can be specified. An asterisk (\*) indicates the full range of values from **000–255**.

**Range:** **0-255** \*, C, && (Allow intervals)

**:ni=** (optional)

The network indicator (ni) value. This parameter specifies one or more ni values for the network cluster (nc) and network cluster member (ncm) values identified in the **nc** and **ncm** parameters. It specifies the *ni* of the point code represented by *ni-nc-ncm*. A single value or a range of values can be specified. An asterisk (\*) indicates the full range of values from **000–255**.

**Range:** **0-255** \*, C, && (Allow intervals)

**:npc=** (optional)

The ITU national point code. An asterisk (\*) indicates the full range of values from **00000–16383**.

**NOTE: Gateway screening allows the ITU national point code to be displayed and entered in the database only as a single number. If you are using multiple-part ITU national point codes, see "Converting ITU National Point Code Formats" in Appendix A for information on converting the point code format.**

**Range:** **00000-16383** \*, C

**:nsr=** (optional)

Next screening reference (nsr). The parameter indicates which screening reference in the specified screening category (**nsfi**) is to be used in the screening process. If **nsfi=stop**, the **nsr** parameter cannot be specified.

**Range:** *ayyy*

1 alphabetic character followed by up to 3 alphanumeric characters

**Default:** No value given

**:pct=** (optional)

Point code subtype. This parameter indicates whether the specified ITU international or ITU national point code has no subtype prefix or has the spare point code prefix (**s-**).

**Range:** **none, s**

**Default:** **none**

**:sp=** (optional)

The 24-bit ITU national signaling point. This parameter specifies the signaling point (sp) in the point code represented by *msa-ssa-sp*. An asterisk (\*) indicates the full range of values from **000–255**.

**Range:** **000-255** \*, C

**:ssa=** (optional)

The 24-bit ITU national sub signaling area. This parameter specifies the sub signaling area (ssa) in the point code represented by the format *msa-ssa-sp*. An asterisk (\*) indicates the full range of values from **000–255**.

**Range:** **000-255** \*, C

**:zone=** (optional)

The ITU international zone. The parameter specifies the zone in the point code represented by format *zone-area-id*. An asterisk (\*) indicates the full range of values from **0–7**.

**Range:** **0-7** \*, C

**Example**

```

ent-scr-blkopc:sr=iec:ni=c:nc=c:ncm=c:nsfi=cgpa:nsr=wrds
ent-scr-blkopc:sr=iec:ni=c:nc=c:ncm=c:nsfi=stop
ent-scr-blkopc:sr=iec:ni=c:nc=c:ncm=c:nsfi=stop:actname=copy
ent-scr-blkopc:sr=iec:ni=240:nc=:ncm=:nsfi=fail
ent-scr-blkopc:sr=bo30:nsfi=stop:msa=c:ssa=c:sp=c
ent-scr-blkopc:sr=bo30:nsfi=fail:msa=1:ssa=2:sp=3
ent-scr-blkopc:sr=bo30:nsfi=fail:msa=3:ssa=:sp=*
ent-scr-blkopc:sr=bo30:nsfi=fail:msa=255:ssa=2:sp=3
ent-scr-blkopc:sr=bop1:zone=1:area=2:id=3:nsfi=fail:pcst=none
ent-scr-blkopc:sr=bop1:zone=2:area=2:id=3:nsfi=fail:pcst=s
ent-scr-blkopc:sr=bop1:npc=128:nsfi=fail:pcst=s

```

**Dependencies**

**CAUTION:** Even though gateway screening is in the screen test mode, as defined by the parameters `gwsa=off` and `andgws=on`, the gateway screening action in the stop action set specified by the `actname` parameter of the screen set *will* be performed at the end of the screening process.

The Gateway Screening Rules table can contain a maximum of 362,700 rules.

A complete point code must be specified, using the **ni-nc-ncm**, **zone-area-id**, **msa-ssa-sp**, or **npc** combination unless a value of **c** for “continue” is specified.

The ANSI point code value **000-000-000** and the ITU-International point code value **0-000-0** cannot be specified.

At least one optional parameter must be specified.

When a blocked OPC screen is created, the first entry for the **ni-nc-ncm zone-area-id**, or **msa-ssa-sp** must be **c-c-c** or **npc** must be **c**. Subsequent entries can be specific point codes.

If asterisks or ranges are specified for the blocked OPCs, nothing that matches the specified range of blocked OPCs can already exist in the BLKOPC screening table for the screening reference.

If the **actname** parameter is specified, then the **nsfi=stop** parameter must be specified.

The value of the **actname** parameter must exist in the Gateway Screening Stop Action table.

If **area=\*** is specified, **id=\*** must be specified.

If **msa=\*** is specified, **ssa=\*** and **sp=\*** must be specified.

If the **msa=c** parameter is specified, then the **ssa** and the **sp** parameters must have a value of **c** or must not be specified. If the **msa=c** parameter is specified, and the **ssa** and the **sp** parameters are not specified, then the **ssa** and **sp** parameters default to a value of **c**.

If the **nc** parameter is specified as a range, the **ncm** parameter must be specified as an asterisk or as the full range **000-255**

If the **nc** parameter is specified as a single value or a range, a single value must be specified for the **ni** parameter.

If the **nc** parameter is specified as an asterisk (**nc=\***), the **ncm** parameter must be specified as an asterisk or as the full range **000-255**.

If the **ncm** parameter is specified as a single value, or a range other than the full range of **000-255**, the **ni** and the **nc** parameters must be specified with a single value.

If the **ni** parameter is specified as an asterisk (**ni=\***) or as a range, the **nc** and **ncm** parameters must be specified as an asterisk or as the full range **000–255**.

If the **ni=c** parameter is specified, then the **nc** and the **ncm** parameters must have a value of **c** or must not be specified. If the **ni=c** parameter is specified, and the **nc** and the **ncm** parameters are not specified, then the **nc** and **ncm** parameters default to a value of **c**.

If the specified **ni-nc-ncm**, **zone-area-id**, or **msa-ssa-sp** is not equal to **c-c-c**, or if the **npc=c** parameter is not specified, then the **nsfi=fail** parameter must be specified, and the **nsr** parameter cannot be specified.

If the value of the **nsfi** parameter is not **stop** or **fail**, then the **nsr** parameter must be specified.

The **nsfi** and **nsr** parameters must point to an existing screen, or the **nsfi=stop** parameter must be specified, and the **nsr** parameter cannot be specified.

If the **sr** does not exist, then the **ni-nc-ncm**, **zone-area-id**, or **msa-ssa-sp** parameters must equal **c-c-c**, or the **npc=c** parameter must be specified, and the **nsfi=fail** parameter cannot be specified.

If the specified screening reference (**sr**) exists:

- The **ni-nc-ncm**, **zone-area-id**, or **msa-ssa-sp** must equal **c-c-c** or **npc** must not equal **c**.
- The **nsfi** parameter must be **fail**.
- The **nsr** parameter cannot be specified.
- The blocked OPC, specified by **ni-nc-ncm**, **zone-area-id**, **msa-ssa-sp**, or **npc**, to be added to the BLKOPC screening table for the blocked OPC screening reference cannot exist as defined or within an existing range of OPCs.

The Spare Point Code Support feature must be enabled before the **pcst** parameter can be specified.

The **pcst** parameter cannot be specified with **c** for a blocked screen reference (**sr**).

The spare point code subtype prefix (**s-**) is not supported for ANSI point codes (parameters **ni**, **nc**, **ncm**) or for 24-bit ITU national point codes (parameters **msa**, **ssa**, **sp**). The **pcst** parameter cannot be specified for ANSI and ITU-N24 point codes.

If **ssa=\*** is specified, **sp=\*** must be specified.

If **zone=\*** is specified, **area=\*** and **id=\*** must be specified.

If the **zone=c** parameter is specified, then the **area** and the **id** parameters must have a value of **c** or must not be specified. If the **zone=c** parameter is specified, and the **area** and the **id** parameters are not specified, then the **area** and **id** parameters default to a value of **c**.

The specified **nsfi** parameter value must be valid for the BLKOPC entity type.

If a blocked screen reference exists, then the **ni**, **zone**, **msa**, and **npc** parameters cannot have a value of **c**.

## Notes

When a blocked DPC screening reference is created, the first entry for a point code must be **c-c-c**, or **c** for the **npc** parameter. Subsequent entries must be specific point codes.

The character **c** is used in the blocked DPC screens to allow the screening process to continue for messages with point codes that do not match any point codes in the blocked DPC screens. When screening for a blocked DPC and the point code being screened does not match any of the point codes in the blocked DPC screens, the message is not rejected and the screening process continues.

There must be an entry in the blocked DPC screens to allow the screening process to continue. This entry consists of a screening reference, point code, **nsfi**, and **nsr**. The point code is in the form of

npc=c or subfields equal to **c-c-c** . When the character **c** is specified, the **nsfi** and **nsr** parameters must be specified.

If the character **c** is specified for the parameters **ni-nc-ncm** or **zone-area-id** or **msa-ssa-sp**, the character **c** is the only value that can be specified for all three parameters. No other values can be used. For example, a point code **c-c-255** is not allowed. The point code must be **c-c-c**. The asterisk (\*) value cannot be used with the character **c** (for example, a point code **c-c-\*** is not allowed).

When the point code does not match any entries in the blocked DPC screens, the screening process is directed to the screening reference with the point code **c-c-c** or **npc=c**. The **nsfi** and **nsr** in this entry are examined to determine the next step in the screening process.

If the current **ni-nc-ncm** or **zone-area-id** or **msa-ssa-sp** is equal to **c-c-c** or **npc=c**, only the **nsfi** and **nsr** can be changed. Otherwise, only the blocked DPC can be changed.

A range of values is specified by separating the values that define the range by two ampersands (&&); for example, **: ni=025&&100** specifies all network indicators for ANSI point codes from **25** to **100**.

An asterisk cannot not be specified for a parameter value in this command unless an asterisk was specified for the parameter value in the original **ent-scr-blkopc** command.

If the screen set reaches 100% capacity (indicated by the 100% Full message), the system allows subsequent entries. An error occurs, however, when downloading the screen set to an LIM. Ensure that screen sets do not exceed 100% capacity. Remove screen set entries until the capacity is below 100%.

The spare point code subtype prefix **s-** is supported only for ITU international and ITU national point codes. The **pcst** parameter indicates whether the specified point code has no subtype prefix or has the spare point code prefix.

## Output

```
ent-scr-blkopc:sr=iec:ni=c:nc=c:ncm=c:nsfi=cgpa:nsr=wrds
rlghncxa03w 04-01-07 11:43:04 EST EAGLE 31.3.0
ENT-SCR-BLKOPC: SCREEN SET AFFECTED - IEC 25% FULL
ENT-SCR-BLKOPC: MASP A - COMPLTD
;
```

### Legend

**ENT-SCR-BLKOPC**—The command entered that caused this output. This is echoed to the printer as a reference.

**SCREEN SET AFFECTED - IEC**—Identifies the screen set that was affected by the command. The screen set name is provided.

**25% FULL**—Indicates the relative size of the screen set.

## ent-scr-cdpa

### Enter Allowed Called Party Address

Use this command to add a specific allowed called party address (CDPA) screening reference in the CDPA entity set.

**Keyword:** ent-scr-cdpa

**Related Commands:** chg-scr-cdpa, dlt-scr-cdpa, rtrv-scr-cdpa

**Command Class:** Database Administration

## Parameters

### **:nsfi=** (mandatory)

This parameter specifies the next screening category that is used in the gateway screening process, or it indicates that the gateway screening process should stop.

**Range:** **aftpc, stop**

**aftpc**— Allowed affected point code is the next screening category.

**stop**— The gateway screening process ends and the message proceeds through normal routing.

### **:sr=** (mandatory)

Screening reference. This parameter specifies the screening reference name for the CdPA.

**Range:** *ayyy*

1 alphabetic character followed by up to 3 alphanumeric characters.

### **:ssn=** (mandatory)

The subsystem number. An asterisk (\*) indicates the full range of values from **1-255**.

**Range:** **1-255 \***

### **:actname=** (optional)

The name of the gateway screening stop action set. Stop actions must be administered using the **actname** parameter in conjunction with the gateway screening stop action table (see **chg-gws-actset** and **rtrv-gws-actset**).

**Range:** *ayyyyy*

1 alphabetic character followed by up to 5 alphanumeric characters.

### **:area=** (optional)

The ITU international area. The area is specified in the point code. The format of the point code is *zone-area-id*. An asterisk (\*) indicates the full range of values from **000-255**.

**Range:** **000-255 \***

### **:id=** (optional)

The ITU international ID. The parameter specifies the ID in the point code represented by format *zone-area-id*. An asterisk (\*) indicates the full range of values from **0-7**.

**Range:** **0-7 \***

### **:msa=** (optional)

The 24-bit ITU-national main signaling area (msa) value. It specifies the **msa** of the point code represented by *msa-ssa-sp*. An asterisk (\*) indicates the full range of values from **000-255**.

**Range:** **000-255 \***

### **:nc=** (optional)

The network cluster (nc) value. This parameter specifies one or more nc values for the network indicator (ni) and network cluster member (ncm) values specified in the **ni** and **ncm** parameters. It specifies the *nc* of the point code represented by *ni-nc-ncm*. A single value or a range of values can be specified. An asterisk (\*) indicates the full range of values from **000-255**.

**Range:** **000-255 \***

### **:ncm=** (optional)

The network cluster member (ncm) value. This parameter specifies one or more ncm values for the network indicator (ni) and network cluster (nc) values identified in the **ni** and **nc** parameters. It specifies the *ncm* of the point code represented by *ni-nc-ncm*. A single value or a range of values can be specified. An asterisk (\*) indicates the full range of values from **000-255**.

**Range:** **0-255 \***

**:ni=** (optional)

The network indicator (ni) value. This parameter specifies one or more ni values for the network cluster (nc) and network cluster member (ncm) values identified in the **nc** and **ncm** parameters. It specifies the *ni* of the point code represented by *ni-nc-ncm*. A single value or a range of values can be specified. An asterisk (\*) indicates the full range of values from **000–255**.

**Range:**     **0-255 \***

**:npc=** (optional)

The ITU national point code. An asterisk (\*) indicates the full range of values from **00000–16383**.

**NOTE: Gateway screening allows the ITU national point code to be displayed and entered in the database only as a single number. If you are using multiple-part ITU national point codes, see "Converting ITU National Point Code Formats" in Appendix A for information on converting the point code format.**

**Range:**     **00000-16383 \***

**:nsr=** (optional)

Next screening reference (nsr). The parameter indicates which screening reference in the specified screening category (**nsfi**) is to be used in the screening process. If **nsfi=stop**, the **nsr** parameter cannot be specified.

**Range:**     *ayyy*

1 alphabetic character followed by up to 3 alphanumeric characters

**Default:**   No value given

**:pcst=** (optional)

Point code subtype. This parameter indicates whether the specified ITU international or ITU national point code has no subtype prefix or has the spare point code prefix (s-).

**Range:**     **none, s**

**Default:**   **none**

**:scmgfid=** (optional)

The SCMG Format ID. A single value or a range of values can be specified. An asterisk (\*) indicates the full range of values from **1–255**. The following SCCP message types are screened against the Allowed CDPA table and all others are passed: UDT, UDTS, XUDT, XUDTS.

**Range:**     **1-255 \***

**:sp=** (optional)

The 24-bit ITU national signaling point. This parameter specifies the signaling point (sp) in the point code represented by *msa-ssa-sp*. An asterisk (\*) indicates the full range of values from **000-255**.

**Range:**     **000-255 \***

**:ssa=** (optional)

The 24-bit ITU national sub signaling area. This parameter specifies the sub signaling area (ssa) in the point code represented by the format *msa-ssa-sp*. An asterisk (\*) indicates the full range of values from **000-255**.

**Range:**     **000-255 \***

**:zone=** (optional)

The ITU international zone. The parameter specifies the zone in the point code represented by format *zone-area-id*. An asterisk (\*) indicates the full range of values from **0–7**.

**Range:**     **0-7 \***

**Example**

```
ent-scr-
cdpa:sr=iec:ni=240:nc=010:ncm=*:ssn=224:nsfi=aftpc:nsr=wrtd5
```

```
ent-scr-
cdpa:sr=iec:ni=240:nc=010:ncm=*:ssn=224:nsfi=stop:actname=copy
ent-scr-
cdpa:sr=cdp1:zone=1:area=2:id=3:ssn=1:nsfi=stop:scmgfid=1:pcst=s
```

## Dependencies



**CAUTION:** Even though gateway screening is in the screen test mode, as defined by the parameters `gwsa=off` and `gws=on`, the gateway screening action in the stop action set specified by the `actname` parameter of the screen set *will* be performed at the end of the screening process.

The Gateway Screening Rules table can contain a maximum of 372,600 rules.

A complete point code must be specified, and must be one and only one of the four point code parameter combinations: **ni-nc-ncm**; **zone-area-id**; **msa-ssa-sp**; or **npc**, except in the special case of entering `c` for "continue."

ANSI point code value **000-000-000** and ITU-International point code value **0-000-0** are not allowed.

At least one optional parameter must be specified.

The new CDPA entry to be added cannot match any specific, range, or asterisk entry already existing in the specified screening table.

The character `c` is not a valid value for the **ni**, **nc**, **ncm**, **zone**, **area**, **id**, **msa**, **ssa**, **sp**, and **npc** parameters.

The value of the **actname** parameter must already be defined in the Gateway Screening Stop Action table with the **chg-gws-actset** command. These values are shown in the *ACTNAME* field of the **rtrv-gws-actset** command output.

When the **actname** parameter is specified, the **nsfi=stop** parameter must be specified.

If the **nc** parameter is specified as a range, the **ncm** parameter must be specified as an asterisk or as the full range **000-255**.

If the **nc** parameter is specified as a single value or a range, a single value must be specified for the **ni** parameter.

If the **nc** parameter is specified as an asterisk (**nc=\***), the **ncm** parameter must be specified as an asterisk or as the full range **000-255**.

If the **ncm** parameter is specified as a single value, or a range other than the full range of **000-255**, the **ni** and the **nc** parameters must be specified with a single value.

If the **ni** parameter is specified as an asterisk (**ni=\***) or as a range, the **nc** and **ncm** parameters must be specified as an asterisk or as the full range **000-255**.

If the **nnc** parameter is specified as a range, the **nncm** parameter must be specified as an asterisk or as the full range **000-255**.

When **nsfi=aftpc** is specified, the **ssn=1** parameter must be specified.

When **nsfi** is a value other than **stop**, the **nsr** parameter must be specified.

When **nsfi=stop** is specified, the **nsr** parameter cannot be specified.

When **ssn=1** is specified, the **scmgfid** parameter must be specified.

When **ssn** is not **1**, the **scmgfid** parameter cannot be specified.

The Spare Point Code Support feature must be enabled before the **pcst** parameter can be specified.

The spare point code subtype prefix (**s-**) is not supported for ANSI point codes (parameters **ni**, **nc**, **ncm**) or for 24-bit ITU national point codes (parameters **msa**, **ssa**, **sp**). The **pcst** parameter cannot be specified for ANSI and ITU-N24 point codes.

The specified value for the **nsfi** parameter is not valid for **cdpa** screen.

The next screening function identifier (**nsfi**) and the next screening reference (**nsr**) must point to an existing screen, or the **nsfi** must be equal to **stop** and the **nsr** must not be specified.

### Notes

If the screening reference is valid, but does not exist, a new CDPA screen is created.

If the screening reference exists, a new rule is added to the CDPA screening table.

A range of values is specified by separating the values that define the range by two ampersands (**&&**); for example, **:ni=025&&100** specifies all network indicators for ANSI point codes from **25** to **100**.

If the screen set reaches 100% capacity (indicated by the 100% Full message), the system will allow subsequent entries. An error will occur, however, when downloading the screen set to a LIM. Screen sets should not exceed 100% capacity. Remove screen set entries until the capacity is below 100%.

An asterisk cannot not be specified for a parameter value in this command unless an asterisk was specified for the parameter value in the original **ent-scr-cdpa** command.

The spare point code subtype prefix **s-** is supported only for ITU international and ITU national point codes. The **pcst** parameter indicates whether the specified point code has no subtype prefix or has the spare point code prefix.

### Output

```
ent-scr-
cdpa:sr=iec:ni=240:nc=010:ncm=*:ssn=224:nsfi=aftpc:nsr=wrds
  rlgncxa03w 04-01-07 11:43:04 EST EAGLE 31.3.0
  ENT-SCR-CDPA:  SCREEN SET AFFECTED - IEC  25% FULL
  ENT-SCR-CDPA:  MASP A - COMPLTD
;
```

### Legend

**ENT-SCR-CDPA**—The command entered that caused this output. This is echoed to the printer as a reference.

**SCREEN SET AFFECTED - IEC**—Identifies the screen set that was affected by the command. The screen set name is provided.

**25% FULL**—Indicates the relative size of the screen set.

## ent-scr-cgpa

### Enter Allowed Calling Party Address

Use this command to add a specific allowed calling party address (CGPA) screening reference in the CGPA entity set.

**Keyword:** **ent-scr-cgpa**

**Related Commands:** **chg-scr-cgpa, dlt-scr-cgpa, rtrv-scr-cgpa**

**Command Class:** Database Administration

### Parameters

**:nsfi=** (mandatory)

This parameter specifies the next screening category that is used in the gateway screening process, or it indicates that the gateway screening process should stop.

**Range:** **cdpa, stop, tt**  
**cdpa** — Allowed called party address is the next screening category.



**stop**— The gateway screening process ends and the message proceeds through normal routing.

**tt**— Allowed translation type is the next screening category.

**:ri=** (mandatory)

The routing indicator provides routing instructions to the receiving signaling point. In gateway screening, messages may be screened based on the value of the routing indicator.

**Range:** **dpc, gt, \***

**dpc**— Allow a called party address with a routing indicator value of “DPC/SSN.”

**gt**— Screening stops and gateway screening is bypassed as a forced pass.

**\***— A full range of values.

**:sr=** (mandatory)

Screening reference. This parameter specifies the screening reference name for the CgPA.

**Range:** *ayyy*

1 alphabetic character followed by up to 3 alphanumeric characters

**:ssn=** (mandatory)

The subsystem number. An asterisk (\*) indicates the full range of values from **1-255**.

**Range:** **1-255 \***

**:actname=** (optional)

The name of the gateway screening stop action set. Stop actions must be administered using the **actname** parameter in conjunction with the gateway screening stop action table (see **chg-gws-actset** and **rtrv-gws-actset**).

**Range:** *ayyyyy*

1 alphabetic character followed by up to 5 alphanumeric characters.

**:area=** (optional)

The ITU international area. The area is specified in the ITU point code. The format of the point code is *zone-area-id*. An asterisk (\*) indicates the full range of values from **000-255**.

**Range:** **000-255 \***

**:id=** (optional)

The ITU international ID. The parameter specifies the ID in the point code represented by format *zone-area-id*. An asterisk (\*) indicates the full range of values from **0-7**.

**Range:** **0-7, \***

**:msa=** (optional)

The 24-bit ITU-national main signaling area (msa) value. It specifies the **msa** of the point code represented by *msa-ssa-sp*. An asterisk (\*) indicates the full range of values from **000-255**.

**Range:** **000-255 \***

**:nc=** (optional)

The network cluster (*nc*) value. This parameter specifies one or more *nc* values for the network indicator (*ni*) and network cluster member (*ncm*) values specified in the **ni** and **ncm** parameters. It specifies the *nc* of the point code represented by *ni-nc-ncm*. A single value or a range of values can be specified. An asterisk (\*) indicates the full range of values from **000-255**.

**Range:** **000-255 \***

**:ncm=** (optional)

The network cluster member (*ncm*) value. This parameter specifies one or more *ncm* values for the network indicator (*ni*) and network cluster (*nc*) values identified in the **ni** and **nc** parameters. It specifies the *ncm* of the point code represented by *ni-nc-ncm*. A single value or a range of values can be specified. An asterisk (\*) indicates the full range of values from **000-255**.

**Range:** **0-255 \***

**:ni=** (optional)

The network indicator (*ni*) value. This parameter specifies one or more *ni* values for the network cluster (*nc*) and network cluster member (*ncm*) values identified in the **nc** and **ncm** parameters. It specifies the *ni* of the point code represented by *ni-nc-ncm*. A single value or a range of values can be specified. An asterisk (\*) indicates the full range of values from **000–255**.

**Range:**     **0-255 \***

**:npc=** (optional)

The ITU national point code. An asterisk (\*) indicates the full range of values from **00000–16383**.

**NOTE: Gateway screening allows the ITU national point code to be displayed and entered in the database only as a single number. If you are using multiple-part ITU national point codes, see "Converting ITU National Point Code Formats" in Appendix A for information on converting the point code format.**

**Range:**     **00000-16383 \***

**:nsr=** (optional)

Next screening reference (*nsr*). The parameter indicates which screening reference in the specified screening category (**nsfi**) is to be used in the screening process. If **nsfi=stop**, the **nsr** parameter cannot be specified.

**Range:**     *ayyy*

1 alphabetic character followed by up to 3 alphanumeric characters

**Default:**   No value given.

**:pcst=** (optional)

Point code subtype. This parameter indicates whether the specified ITU international or ITU national point code has no subtype prefix or has the spare point code prefix (s-).

**Range:**     **none, s**

**Default:**   **none**

**:sccpmt=** (optional)

The SCCP message type. An asterisk (\*) indicates all possible allowed values.

**Range:**     **9, 10, 17, 18, \***

9, \* — UDT

10, \* — UDTS

17, \* — XUDT

18, \* — XUDTS

**Default:**   **\***

**:sp=** (optional)

The 24-bit ITU national signaling point. This parameter specifies the signaling point (*sp*) in the point code represented by *msa-ssa-sp*. An asterisk (\*) indicates the full range of values from **000-255**.

**Range:**     **000-255 \***

**:ssa=** (optional)

The 24-bit ITU national sub signaling area. This parameter specifies the sub signaling area (*ssa*) in the point code represented by the format *msa-ssa-sp*. An asterisk (\*) indicates the full range of values from **000-255**.

**Range:**     **000-255 \***

**:zone=** (optional)

The ITU international zone. The parameter specifies the zone in the point code represented by format *zone-area-id*. An asterisk (\*) indicates the full range of values from **0–7**.

**Range:**     **0-7 \***

**Example**

```
ent-scr-
cgpa:sr=iec:ni=240:nc=010:ncm=*:ssn=224:nsfi=aftpc:nsr=wr5:ri=dp
c
ent-scr-
cgpa:sr=iec:ni=240:nc=010:ncm=*:ssn=224:nsfi=stop:ri=dpc:actname=
copy
ent-scr-
cgpa:sr=cdp1:ni=5:nc=5:ncm=5:ssn=1:ri=dpc:sccpmt=9:nsfi=sdpa:nsr=
cdp1
ent-scr-
cgpa:sr=cgpa:zone=1:area=2:id=3:ssn=1:sccpmt=9:ri=*:nsfi=stop:pcst=
s
```

**Dependencies**

**CAUTION:** Even though gateway screening is in the screen test mode, as defined by the parameters `gwsa=off` and `andgws=on`, the gateway screening action in the stop action set specified by the `actname` parameter of the screen set *will* be performed at the end of the screening process.

The Gateway Screening Rules table can contain a maximum of 372,600 rules.

A complete point code must be specified, and must be one, and only one of the four point code parameter combinations: **ni-nc-ncm**; **zone-area-id**; **msa-ssa-sp**; or **npc**.

ANSI point code value **000-000-000** and ITU-International point code value **0-000-0** are not allowed.

The new CGPA point code, **ri**, **sccpmt**, and subsystem number (**ssn**) to be added can not already exist in the CGPA entity set.

The character **c** is not a valid value for the **ni**, **nc**, **ncm**, **zone**, **area**, **id**, **msa**, **ssa**, **sp**, and **npc** parameters.

The value of the **actname** parameter must already be defined in the Gateway Screening Stop Action table with the **chg-gws-actset** command. These values are shown in the *ACTNAME* field of the **rtrv-gws-actset** command output.

When the **actname** parameter is specified, the **nsfi=stop** parameter must be specified.

If **area=\*** is specified, **id=\*** must be specified.

If **msa=\*** is specified, **ssa=\*** and **sp=\*** must be specified.

If the **nc** parameter is specified as a range, the **ncm** parameter must be specified as an asterisk or as the full range **000-255**

If the **nc** parameter is specified as a single value or a range, a single value must be specified for the **ni** parameter.

If the **nc** parameter is specified as an asterisk (**nc=\***), the **ncm** parameter must be specified as an asterisk or as the full range **000-255**.

If the **ncm** parameter is specified as a single value, or a range other than the full range of **000-255**, the **ni** and the **nc** parameters must be specified with a single value.

If the **ni** parameter is specified as an asterisk (**ni=\***) or as a range, the **nc** and **ncm** parameters must be specified as an asterisk or as the full range **000-255**.

The Spare Point Code Support feature must be enabled before the **pcst** parameter can be specified.

The spare point code subtype prefix (**s-**) is not supported for ANSI point codes (parameters **ni**, **nc**, **ncm**) or for 24-bit ITU national point codes (parameters **msa**, **ssa**, **sp**). The **pcst** parameter cannot be specified for ANSI and ITU-N24 point codes.

The screen referenced by **nsfi** and **nsr** must already exist.

The **nsr** parameter must be specified, if **nsfi** is not equal to **stop**.

When **nsfi=stop** is specified, the **nsr** parameter cannot be specified.

The **nsfi=tt** parameter can be specified only if the **ri=gt** parameter or the **ri=\*** parameter is specified.

The **nsfi=cdpa** parameter can be specified only if the **ri=dpc** parameter or the **ri=\*** parameter is specified.

If **ssa=\*** is specified, **sp=\*** must be specified.

If **zone=\*** is specified, **area=\*** and **id=\*** must be specified.

The specified value for the **nsfi** parameter is not valid for **cgpa** screen.

The **nsccpmt** and **sccpmt** parameter value must be specified in the range of {**9, 10, 17, 18, and \***}.

## Notes

A range of values is specified by separating the values that define the range by two ampersands (**&&**); for example, **:ni=025&&100** specifies all network indicators for ANSI point codes from **25** to **100**.

If the screening reference is valid, but does not exist, a new CGPA screening table is created.

If the screening reference exists, a new rule is added to the CGPA screening table. Only one rule may exist for a given **ni-nc-ncm/ssn/ri/sccpmt** (or **zone-area-id** or **npc**) combination. This implies that for a given **ni-nc-ncm/ssn/ri/sccpmt** (or **zone-area-id** or **npc**), only one value of **ri** may be specified. The **ri** for a given combination can be **dpc**, **gt**, or **\***, but not **dpc** and **gt** independently.

If the screen set reaches 100% capacity (indicated by the 100% Full message), the system will allow subsequent entries. An error will occur, however, when downloading the screen set to a LIM. Screen sets should not exceed 100% capacity. Remove screen set entries until the capacity is below 100%.

An asterisk cannot not be specified for a parameter value in this command unless an asterisk was specified for the parameter value in the original **ent-scr-cgpa** command.

The spare point code subtype prefix **s-** is supported only for ITU international and ITU national point codes. The **pcst** parameter indicates whether the specified point code has no subtype prefix or has the spare point code prefix.

**Output**

```

ent-scr-
cgpa: sr=iec: ni=240: nc=010: ncm=: ssn=224: nsfi=aftpc: nsr= wrd5: ri=dp
c
  rlgncxa03w 04-01-07 11:43:04 EST EAGLE 31.3.0
  ENT-SCR-CGPA: SCREEN SET AFFECTED - IEC 25% FULL
  ENT-SCR-CGPA: MASP A - COMPLTD
;

```

**Legend**

**ENT-SCR-CGPA**—The command entered that caused this output. This is echoed to the printer as a reference.

**SCREEN SET AFFECTED - IEC**—Identifies the screen set that was affected by the command. The screen set name is provided.

**25% FULL**—Indicates the relative size of the screen set.

**ent-scr-destfld****Add an Allowed DESTFLD**

Use this command to add an allowed affected destination field (DESTFLD) screening reference and associated attributes (destination point code, next screening function identifier, and next screening reference) to the allowed DESTFLD entity set. One or more point codes can be associated with the allowed DESTFLD screening reference. MTP Network Management messages regarding the DESTFLDs listed in this entity set are accepted from another network.

**Keyword:** ent-scr-destfld

**Related Commands:** chg-scr-destfld, dlt-scr-destfld, rtrv-scr-destfld

**Command Class:** Database Administration

**Parameters**

**:nsfi=** (mandatory)

This parameter indicates that the gateway screening process should stop. If this parameter is specified for this command, it must have the value of **stop**.

**Range:** stop

**stop**— The gateway screening process ends and the message proceeds through normal routing.

**:sr=** (mandatory)

Screening reference. This parameter specifies the point code's unique screening reference name.

**Range:** ayyy

1 alphabetic character followed by up to 3 alphanumeric characters.

**:actname=** (optional)

The name of the gateway screening stop action set. Stop actions must be administered using the **actname** parameter in conjunction with the gateway screening stop action table (see **chg-gws-actset** and **rtrv-gws-actset**).

**Range:** ayyyyy

1 alphabetic character followed by up to 5 alphanumeric characters.

**:area=** (optional)

The ITU international area. The area is specified in the point code. The format of the point code is *zone-area-id*. An asterisk (\*) indicates the full range of values from **000-255**.

**Range:** 000-255 \*

**:id=** (optional)

The ITU international ID. The parameter specifies the ID in the point code represented by format *zone-area-id*. An asterisk (\*) indicates the full range of values from **0-7**.

**Range:** **0-7, \***

**:msa=** (optional)

The 24-bit ITU-national main signaling area (*msa*) value. It specifies the **msa** of the point code represented by *msa-ssa-sp*. An asterisk (\*) indicates the full range of values from **000-255**.

**Range:** **000-255 \***

**:nc=** (optional)

The network cluster (*nc*) value. This parameter specifies one or more *nc* values for the network indicator (*ni*) and network cluster member (*ncm*) values specified in the **ni** and **ncm** parameters. It specifies the *nc* of the point code represented by *ni-nc-ncm*. A single value or a range of values can be specified. An asterisk (\*) indicates the full range of values from **000-255**.

**Range:** **000-255 \***

**:ncm=** (optional)

The network cluster member (*ncm*) value. This parameter specifies one or more *ncm* values for the network indicator (*ni*) and network cluster (*nc*) values identified in the **ni** and **nc** parameters. It specifies the *ncm* of the point code represented by *ni-nc-ncm*. A single value or a range of values can be specified. An asterisk (\*) indicates the full range of values from **000-255**.

**Range:** **0-255 \***

**:ni=** (optional)

The network indicator (*ni*) value. This parameter specifies one or more *ni* values for the network cluster (*nc*) and network cluster member (*ncm*) values identified in the **nc** and **ncm** parameters. It specifies the *ni* of the point code represented by *ni-nc-ncm*. A single value or a range of values can be specified. An asterisk (\*) indicates the full range of values from **000-255**.

**Range:** **0-255 \***

**:npc=** (optional)

The ITU national point code. An asterisk (\*) indicates the full range of values from **00000-16383**.

**NOTE: Gateway screening allows the ITU national point code to be displayed and entered in the database only as a single number. If you are using multiple-part ITU national point codes, see "Converting ITU National Point Code Formats" in Appendix A for information on converting the point code format.**

**Range:** **00000-16383 \***

**:nsr=** (optional)

Next screening reference (*nsr*). The parameter indicates which screening reference in the specified screening category (**nsfi**) is to be used in the screening process. If **nsfi=stop**, the **nsr** parameter cannot be specified.

**Range:** *ayyy*  
1 alphabetic character followed by up to 3 alphanumeric characters

**Default:** No value given

**:pcst=** (optional)

Point code subtype. This parameter indicates whether the specified ITU international or ITU national point code has no subtype prefix or has the spare point code prefix (**s-**).

**Range:** **none, s**

**Default:** **none**

**:sp=** (optional)

The 24-bit ITU national signaling point. This parameter specifies the signaling point (sp) in the point code represented by *msa-ssa-sp*. An asterisk (\*) indicates the full range of values from **000-255**.

**Range:** **000-255 \***

**:ssa=** (optional)

The 24-bit ITU national sub signaling area. This parameter specifies the sub signaling area (ssa) in the point code represented by the format *msa-ssa-sp*. An asterisk (\*) indicates the full range of values from **000-255**.

**Range:** **000-255 \***

**:zone=** (optional)

The ITU international zone. The parameter specifies the zone in the point code represented by format *zone-area-id*. An asterisk (\*) indicates the full range of values from **0-7**.

**Range:** **0-7, \***

### Example

```
ent-scr-destfld:sr=iec:ni=240:nc=010:ncm=010-012:nsfi=stop
```

```
ent-scr-destfld:sr=iec1:ni=1:nc=1:ncm=1:nsfi=stop:actname=copy
```

```
ent-scr-destfld:sr=dst1:zone=1:area=2:id=3:nsfi=stop:pcst=s
```

### Dependencies



**CAUTION:** Even though gateway screening is in the screen test mode, as defined by the parameters **gwsa=off** and **andgws=on**, the gateway screening action in the stop action set specified by the **actname** parameter of the screen set *will* be performed at the end of the screening process.

The Gateway Screening Rules table can contain a maximum of 362,700 rules.

The destination point code specified by **ni-nc-ncm**, **zone-area-id**, **msa-ssa-sp**, or the **npc** parameter must not already exist in the screening reference or within an existing range of DPCs.

ANSI point code value **000-000-000** and ITU-International point code value **0-000-0** are not allowed.

If the **actname** parameter is specified, then the **nsfi=stop** parameter must be specified.

The value of the **actname** parameter must already be defined in the Gateway Screening Stop Action table with the **chg-gws-actset** command. These values are shown in the *ACTNAME* field of the **rtrv-gws-actset** command output.

If the **area=\*** parameter is specified, then the **id=\*** parameter must be specified.

If the **msa=\*** parameter is specified, then the **ssa=\*** and the **sp=\*** parameters must be specified.

If the **nc** parameter is specified as a range, the **ncm** parameter must be specified as an asterisk or as the full range **000-255**.

If the **nc** parameter is specified as a single value or a range, a single value must be specified for the **ni** parameter.

If the **nc** parameter is specified as an asterisk (**nc=\***), the **ncm** parameter must be specified as an asterisk or as the full range **000-255**.

If the **ncm** parameter is specified as a single value, or a range other than the full range of **000-255**, the **ni** and the **nc** parameters must be specified with a single value.

If the **ni** parameter is specified as an asterisk (**ni=\***) or as a range, the **nc** and **ncm** parameters must be specified as an asterisk or as the full range **000-255**.

The **nsfi=stop** parameter must be specified in the command.

If the **nsfi=stop** parameter is specified, then the **nsr** parameter cannot be specified.

If the **ssa=\*** parameter is specified, then the **sp=\*** parameter must be specified.

If the **zone=\*** parameter is specified, then the **area=\*** and the **id=\*** parameters must be specified.

The Spare Point Code Support feature must be enabled before the **pcst** parameter can be specified.

The spare point code subtype prefix (**s-**) is not supported for ANSI point codes (parameters **ni**, **nc**, **ncm**) or for 24-bit ITU national point codes (parameters **msa**, **ssa**, **sp**). The **pcst** and **npcst** parameters cannot be specified for ANSI and ITU-N24 point codes.

If the **nsfi=fail** parameter is specified, then the **nni**, **nc**, **nncm**, **narea**, **nzone**, **nid**, **nmsa**, **nssa**, **nsp**, and **npc** parameters cannot have a value of **c**.

## Notes

A range of values is specified by separating the values that define the range by two ampersands (**&&**); for example, **:ni=025&&100** specifies all network indicators for ANSI point codes from **25** to **100**.

An asterisk cannot not be specified for a parameter value in this command unless an asterisk was specified for the parameter value in the original **ent-scr-destfld** command.

The spare point code subtype prefix **s-** is supported only for ITU international and ITU national point codes. The **pcst** parameter indicates whether the specified point code has no subtype prefix or has the spare point code prefix.

## Output

```
ent-scr-destfld:sr=iec:ni=240:nc=010:ncm=010-012:nsfi=stop
rlghncxa03w 04-02-13 11:49:47 EST EAGLE 31.3.0
ENT-SCR-DESTFLD: SCREEN SET AFFECTED - IEC 25% FULL
ENT-SCR-DESTFLD: MASP A - COMPLTD
;
```

## ent-scr-dpc

### Enter Allowed DPC

Use this command to add an allowed DPC screening reference and associated attributes (destination point code, next screening function identifier, next screening function reference) to the allowed DPC entity set. One or more DPCs may be associated with the allowed DPC screening reference. The DPCs listed in this entity set are allowed to receive SS7 messages from another network.

**Keyword:** **ent-scr-dpc**

**Related Commands:** **chg-scr-dpc**, **dlt-scr-dpc**, **rtrv-scr-dpc**

**Command Class:** Database Administration

## Parameters

**:nsfi=** (mandatory)

This parameter specifies the next screening category that is used in the gateway screening process, or it indicates that the gateway screening process should stop.

**Range:** **blkdpc**, **cgpa**, **destfld**, **isup**, **stop**

**blkdpc**— Blocked DPC is the next screening category.

**cgpa**— Allowed CGPA is the next screening category.

**destfld**— Allowed destination field (DESTFLD) is the next screening category.

**isup**— ISUP message type (ISUP) is the next screening category.

**stop**— The gateway screening process ends and the message proceeds through normal routing.

**:sr=** (mandatory)

The allowed DPC screening reference name. This parameter identifies a set of one or more allowed destination point codes.



**Range:** *ayyy*  
1 alphabetic character followed by up to 3 alphanumeric characters.

**:actname=** (optional)

The name of the gateway screening stop action set. Stop actions must be administered using the **actname** parameter in conjunction with the gateway screening stop action table (see **chg-gws-actset** and **rtrv-gws-actset**).

**Range:** *ayyyyy*  
1 alphabetic character followed by up to 5 alphanumeric characters.

**:area=** (optional)

The ITU international area. The area is specified in the point code. The format of the point code is *zone-area-id*. An asterisk (\*) indicates the full range of values from **000-255**.

**Range:** **000-255 \***

**:id=** (optional)

The ITU international ID. The parameter specifies the ID in the point code represented by format *zone-area-id*. An asterisk (\*) indicates the full range of values from **0-7**.

**Range:** **0-7, \***

**:msa=** (optional)

The 24-bit ITU-national main signaling area (msa) value. It specifies the **msa** of the point code represented by *msa-ssa-sp*. An asterisk (\*) indicates the full range of values from **000-255**.

**Range:** **000-255 \***

**:nc=** (optional)

The network cluster (*nc*) value. This parameter specifies one or more *nc* values for the network indicator (*ni*) and network cluster member (*ncm*) values specified in the **ni** and **ncm** parameters. It specifies the *nc* of the point code represented by *ni-nc-ncm*. A single value or a range of values can be specified. An asterisk (\*) indicates the full range of values from **000-255**.

**Range:** **000-255 \***

**:ncm=** (optional)

The network cluster member (*ncm*) value. This parameter specifies one or more *ncm* values for the network indicator (*ni*) and network cluster (*nc*) values identified in the **ni** and **nc** parameters. It specifies the *ncm* of the point code represented by *ni-nc-ncm*. A single value or a range of values can be specified. An asterisk (\*) indicates the full range of values from **000-255**.

**Range:** **0-255 \***

**:ni=** (optional)

The network indicator (*ni*) value. This parameter specifies one or more *ni* values for the network cluster (*nc*) and network cluster member (*ncm*) values identified in the **nc** and **ncm** parameters. It specifies the *ni* of the point code represented by *ni-nc-ncm*. A single value or a range of values can be specified. An asterisk (\*) indicates the full range of values from **000-255**.

**Range:** **0-255 \***

**:npc=** (optional)

The ITU national point code. An asterisk (\*) indicates the full range of values from **00000-16383**.

**NOTE: Gateway screening allows the ITU national point code to be displayed and entered in the database only as a single number. If you are using multiple-part ITU national point codes, see "Converting ITU National Point Code Formats" for information on converting the point code format.**

**Range:** **00000-16383 \***

**:nsr=** (optional)

Next screening reference (nsr). The parameter indicates which screening reference in the specified screening category (**nsfi**) is to be used in the screening process. If **nsfi=stop**, the **nsr** parameter cannot be specified.

**Range:** *ayyy*  
1 alphabetic character followed by up to 3 alphanumeric characters

**Default:** No value given

**:pcst=** (optional)

Point code subtype. This parameter indicates whether the specified ITU international or ITU national point code has no subtype prefix or has the spare point code prefix (**s-**).

**Range:** **none, s**

**Default:** **none**

**:sp=** (optional)

The 24-bit ITU national signaling point. This parameter specifies the signaling point (*sp*) in the point code represented by *msa-ssa-sp*. An asterisk (\*) indicates the full range of values from **000-255**.

**Range:** **000-255 \***

**:ssa=** (optional)

The 24-bit ITU national sub signaling area. This parameter specifies the sub signaling area (*ssa*) in the point code represented by the format *msa-ssa-sp*. An asterisk (\*) indicates the full range of values from **000-255**.

**Range:** **000-255 \***

**:zone=** (optional)

The ITU international zone. The parameter specifies the zone in the point code represented by format *zone-area-id*. An asterisk (\*) indicates the full range of values from **0-7**.

**Range:** **0-7, \*, C**

**Example**

```
ent-scr-dpc:sr=iec:ni=240:nc=010:ncm=010:nsfi=stop:actname=cncf
ent-scr-dpc:sr=iec:ni=240:nc=010:ncm=010:nsfi=blkdpc:nsr=bdp1
ent-scr-dpc:sr=dpc1:zone=1:area=2:id=3:nsfi=fail:pcst=none
ent-scr-dpc:sr=dpc1:zone=2:area=2:id=3:nsfi=fail:pcst=s
ent-scr-dpc:sr=dpc1:npc=128:nsfi=fail:pcst=s
```

**Dependencies**

**CAUTION:** Even though gateway screening is in the screen test mode, as defined by the parameters **gwsa=off** and **gws=on**, the gateway screening action in the stop action set specified by the **actname** parameter of the screen set *will* be performed at the end of the screening process.

The Gateway Screening Rules table can contain a maximum of 362,700 rules.

The destination point code specified by **ni-nc-ncm**, **zone-area-id**, **msa-ssa-sp**, or the **npc** parameter must not already exist in the screening reference or within an existing range of DPCs.

If the **actname** parameter is specified, then the **nsfi=stop** parameter must be specified.

ANSI point code value **000-000-000** and ITU-International point code value **0-000-0** are not allowed.

The value of the **actname** parameter must already be defined in the Gateway Screening Stop Action table with the **chg-gws-actset** command. These values are shown in the *ACTNAME* field of the **rtrv-gws-actset** command output.

If the **area=\*** parameter is specified, then the **id=\*** parameter must be specified.

If the **msa=\*** parameter is specified, then the **ssa=\*** and the **sp=\*** parameters must be specified.

If the **nc** parameter is specified as a range, the **ncm** parameter must be specified as an asterisk or as the full range **000–255**.

If the **nc** parameter is specified as a single value or a range, a single value must be specified for the **ni** parameter.

If the **nc** parameter is specified as an asterisk (**nc=\***), the **ncm** parameter must be specified as an asterisk or as the full range **000–255**.

If the **ncm** parameter is specified as a single value, or a range other than the full range of **000–255**, the **ni** and the **nc** parameters must be specified with a single value.

If the **ni** parameter is specified as an asterisk (**ni=\***) or as a range, the **nc** and **ncm** parameters must be specified as an asterisk or as the full range **000–255**.

The **nsfi** and **nsr** parameters must point to an existing screen, or the **nsfi=stop** parameter must be specified, and the **nsr** parameter cannot be specified.

If the **nsfi=stop** parameter is not specified, then the **nsr** parameter must be specified.

If the **ssa=\*** parameter is specified, then the **sp=\*** parameter must be specified.

If the **zone=\*** parameter is specified, then the **area=\*** and the **id=\*** parameters must be specified.

The Spare Point Code Support feature must be enabled before the **pcst** parameter can be specified.

The spare point code subtype prefix (**s-**) is not supported for ANSI point codes (parameters **ni**, **nc**, **ncm**) or for 24-bit ITU national point codes (parameters **msa**, **ssa**, **sp**). The **pcst** parameter cannot be specified for ANSI and ITU-N24 point codes.

If the **nsfi=fail** parameter is specified, then the **nmi**, **nc**, **ncm**, **narea**, **nzone**, **nid**, **nmsa**, **nssa**, **nsp**, and **npc** parameters cannot have a value of **c**.

The value of the **nsfi** parameter must be valid for the BLKDPC entity type.

## Notes

When a DPC screening reference is created, the first entry for a point code must be **c-c-c**, or **c** for the **npc** parameter. Subsequent entries must be specific point codes.

The character **c** is used in the DPC screens to allow the screening process to continue for messages with point codes that do not match any point codes in the DPC screens. When screening for a DPC and the point code being screened does not match any of the point codes in the DPC screens, the message is not rejected and the screening process continues.

There must be an entry in the DPC screens to allow the screening process to continue. This entry consists of a screening reference, point code, **nsfi**, and **nsr**. The point code is in the form of **npc=c** or subfields equal to **c-c-c**. When the character **c** is specified, the **nsfi** and **nsr** parameters must be specified.

If the character **c** is specified for the parameters **ni-nc-ncm** or **zone-area-id** or **msa-ssa-sp**, the character **c** is the only value that can be specified for all three parameters. No other values can be used. For example, a point code **c-c-255** is not allowed. The point code must be **c-c-c**. The asterisk (\*) value cannot be used with the character **c** (for example, a point code **c-c-\*** is not allowed).

When the point code does not match any entries in the blocked DPC screens, the screening process is directed to the screening reference with the point code **c-c-c** or **npc=c**. The **nsfi** and **nsr** in this entry are examined to determine the next step in the screening process.

If the current **ni-nc-ncm** or **zone-area-id** or **msa-ssa-sp** is equal to **c-c-c** or **npc=c**, only the **nsfi** and **nsr** can be changed. Otherwise, only the blocked DPC can be changed.

A range of values is specified by separating the values that define the range by two ampersands (&&); for example, **:ni=025&&100** specifies all network indicators for ANSI point codes from **25** to **100**.

An asterisk cannot not be specified for a parameter value in this command unless an asterisk was specified for the parameter value in the original **ent-scr-dpc** command.

If the screen set reaches 100% capacity (indicated by the 100% Full message), the system allows subsequent entries. An error occurs, however, when downloading the screen set to an LIM. Ensure that screen sets do not exceed 100% capacity. Remove screen set entries until the capacity is below 100%.

The spare point code subtype prefix **s-** is supported only for ITU international and ITU national point codes. The **pcst** parameter indicates whether the specified point code has no subtype prefix or has the spare point code prefix.

### Output

```
ent-scr-dpc:sr=iec:ni=240:nc=010:ncm=010:nsfi=stop:actname=cncf
rlghncxa03w 04-01-07 11:43:04 EST EAGLE 31.3.0
ENT-SCR-DPC: SCREEN SET AFFECTED - IEC 25% FULL
ENT-SCR-DPC: MASP A - COMPLTD
;
```

### Legend

**ENT-SCR-DPC**—Command entered that caused this output. This is echoed to the printer.

**SCREEN SET AFFECTED - IEC**—Identifies the screen set that was affected by the command. The screen set name is provided.

**25% FULL**—Indicates the relative size of the screen set.

## ent-scr-isup

### Enter Allowed ISUP Screening Reference

Use this command to add an allowed ISUP or TUP screening reference to the Allowed ISUP entity set. One or more message types can be associated with the allowed ISUP screening reference. The ISUP message types listed in this entity set are accepted from another network.

**Keyword:** **ent-scr-isup**

**Related Commands:** **chg-scr-isup**, **dlt-scr-isup**, **rtrv-scr-isup**

**Command Class:** Database Administration

### Parameters

**:isupmt/tupmt=** (mandatory)

ISUP message type or TUP message type. A single value or range of values can be entered. An asterisk (\*) indicates the entire range of **000-255**. TUP is not valid for SEAS.

**Range:** **000-255 \***

**:sr=** (mandatory)

The the individual ISUP screening reference to which this rule will be added. If the specified **sr** does not exist, it will be created

**Range:** *ayyy*  
1 alphabetic character followed by up to 3 alphanumeric characters.

**:actname=** (optional)

The name of the gateway screening stop action set. Stop actions must be administered using the **actname** parameter in conjunction with the gateway screening stop action table (see **chg-gws-actset** and **rtrv-gws-actset**).

**Range:** *ayyyyy*  
1 alphabetic character followed by up to 5 alphanumeric characters.

**:nsfi=** (optional)

This parameter specifies the next screening category that is used in the gateway screening process. If specified, the parameter value must be **stop**.

**Range:** **stop**  
**stop**— The gateway screening process ends and the message proceeds through normal routing.

**:nsr=** (optional)

Next screening reference. The parameter indicates which screening reference in the specified screening category (**nsfi**) is to be used in the screening process. If **nsfi=stop**, the **nsr** parameter cannot be specified.

**Range:** *ayyy*  
1 alphabetic character followed by up to 3 alphanumeric characters

**Default:** No value given

### Example

```
ent-scr-isup:sr=iec:isupmt=1:nsfi=stop
ent-scr-isup:sr=iec:isupmt=9:nsfi=stop
ent-scr-isup:sr=ibig:isupmt=1&&128:nsfi=stop
ent-scr-isup:sr=iall:isupmt=*:nsfi=stop
ent-scr-isup:tupmt=20:sr=tu01:nsfi=stop
```

### Dependencies

If the **actname** parameter is specified, the **nsfi=stop** parameter must be specified.

The value of the **actname** parameter must already be defined in the Gateway Screening Stop Action table with the **chg-gws-actset** command. These values are shown in the *ACTNAME* field of the **rtrv-gws-actset** command output.

The specified **isupmt** parameter or **tupmt** parameter value must not already exist in the specified **sr**.

If the **nsfi** parameter is specified, the value must be **stop**.

The **nsr** parameter cannot be specified if the **nsfi=stop** parameter is specified.

### Notes

A range of values can be specified for the **isupmt** parameter or **tupmt** parameter, by separating the values that define the range by two ampersands (&&); for example, **:isupmt=025&&100** specifies all ISUP message types from **25** to **100**. The value to the left of the && must be less than the value to the right of the && in the range.

An asterisk cannot not be specified for a parameter value in this command unless an asterisk was specified for the parameter value in the original **ent-scr-isup** command.

TUP does not apply to SEAS. ISUP Message Type is the default.

To use TUP message type screening, an SIO screening reference with **si=04** (TUP) must exist in the SIO table. The TUP screening reference specifies the SIO screening reference as the next screening reference parameter (**nsr**) value.

To use ISUP message type screening, an SIO screening reference with **si=05** (ISUP) must exist in the SIO table. The ISUP screening reference specifies the ISUP SIO screening reference as the next screening reference parameter (**nsr**) value.

To screen for TUP and ISUP message types using a combined ISUP/TUP screen set, the SIO screening reference with **si=4** and the SIO screening reference with **si=5** must be two different screening references. The TUP screening reference specifies the SIO screening reference as the next screening reference parameter (**nsr**) value, and the ISUP screening reference specifies the SIO ISUP screening reference as the next screening reference parameter (**nsr**) value.

### Output

When a screen reference is specified that is not yet associated with a screen set, the following output appears:

```
ent-scr-isup:sr=iec:isupmt=1:nsfi=stop
tekelecstp 04-09-02 09:39:13 EST EAGLE 31.3.0
ENT-SCR-ISUP: MASP A - COMPLTD
;
```

When a screen reference is specified that is already associated with one or more screen sets, the following output appears:

```
ent-scr-isup:tupmt=20:sr=tu01:nsfi=stop
tekelecstp 04-11-17 16:22:27 EST EAGLE 31.4.0
Extended Processing Time Required -- Please Wait
Notice: The number of screensets affected is 2.
ENT-SCR-ISUP: SCREEN SET AFFECTED - ist1 1% FULL
ENT-SCR-ISUP: SCREEN SET AFFECTED - ist2 1% FULL
ENT-SCR-ISUP: MASP A - COMPLTD
;
```

### ent-scr-opc

### Enter Allowed OPC

Use this command to add an allowed OPC screening reference and associated attributes (originating point code, next screening function identifier, next screening function reference) to the allowed OPC entity set. One or more OPCs may be associated with the allowed OPC screening reference. Each OPC listed in this entity set is allowed to send SS7 messages to the customer's network.

**Keyword:** ent-scr-opc

**Related Commands:** chg-scr-opc, dlt-scr-opc, rtrv-scr-opc

**Command Class:** Database Administration

### Parameters

**:nsfi=** (mandatory)

This parameter specifies the next screening category that is used in the gateway screening process, or it indicates that the gateway screening process should stop.

**Range:** **blkdpc, blkopc, cgpa, dpc, sio, stop**

**blkdpc**— Blocked DPC is the next screening category.

**blkopc**— Blocked OPC is the next screening category.

**cgpa**— Allowed CGPA is the next screening category.

**dpc**— Allowed DPC is the next screening category.

**sio**— Allowed SIO is the next screening category.

**stop**— The gateway screening process ends and the message proceeds through normal routing.

**:sr=** (mandatory)

Screening reference. This parameter identifies a set of one or more allowed OPCs.

**Range:** *ayyy*

1 alphabetic character followed by up to 3 alphanumeric characters

**:actname=** (optional)

The name of the gateway screening stop action set. Stop actions must be administered using the **actname** parameter in conjunction with the gateway screening stop action table (see **chg-gws-actset** and **rtrv-gws-actset**).

**Range:** *ayyyyy*

1 alphabetic character followed by up to 5 alphanumeric characters.

**:area=** (optional)

The ITU international area. The area is specified in the point code. The format of the point code is *zone-area-id*. An asterisk (\*) indicates the full range of values from **000-255**.

**Range:** **000-255 \***

**:id=** (optional)

The ITU international ID. The parameter specifies the ID in the point code represented by format *zone-area-id*. An asterisk (\*) indicates the full range of values from **0-7**.

**Range:** **0-7, \***

**:msa=** (optional)

The 24-bit ITU-national main signaling area (*msa*) value. It specifies the **msa** of the point code represented by *msa-ssa-sp*. An asterisk (\*) indicates the full range of values from **000-255**.

**Range:** **000-255 \***

**:nc=** (optional)

The network cluster (*nc*) value. This parameter specifies one or more *nc* values for the network indicator (*ni*) and network cluster member (*ncm*) values specified in the **ni** and **ncm** parameters. It specifies the *nc* of the point code represented by *ni-nc-ncm*. A single value or a range of values can be specified. An asterisk (\*) indicates the full range of values from **000-255**.

**Range:** **000-255 \***

**:ncm=** (optional)

The network cluster member (*ncm*) value. This parameter specifies one or more *ncm* values for the network indicator (*ni*) and network cluster (*nc*) values identified in the **ni** and **nc** parameters. It specifies the *ncm* of the point code represented by *ni-nc-ncm*. A single value or a range of values can be specified. An asterisk (\*) indicates the full range of values from **000-255**.

**Range:** **0-255 \***

**:ni=** (optional)

The network indicator (*ni*) value. This parameter specifies one or more *ni* values for the network cluster (*nc*) and network cluster member (*ncm*) values identified in the **nc** and **ncm** parameters. It specifies the *ni* of the point code represented by *ni-nc-ncm*. A single value or a range of values can be specified. An asterisk (\*) indicates the full range of values from **000-255**.

**Range:** **0-255 \***

**:npc=** (optional)

The ITU national point code. An asterisk (\*) indicates the full range of values from **00000-16383**.

**NOTE: Gateway screening allows the ITU national point code to be displayed and entered in the database only as a single number. If you are using multiple-part ITU national point codes, see "Converting ITU National Point Code Formats" in Appendix A for information on converting the point code format.**

**Range:** **00000-16383 \***

**:nsr=** (optional)

Next screening reference (*nsr*). The parameter indicates which screening reference in the specified screening category (**nsfi**) is to be used in the screening process. If **nsfi=stop**, the **nsr** parameter cannot be specified.

**Range:** *ayyy*  
1 alphabetic character followed by up to 3 alphanumeric characters

**Default:** No value given

**:pcst=** (optional)

Point code subtype. This parameter indicates whether the specified ITU international or ITU national point code has no subtype prefix or has the spare point code prefix (s-).

**Range:** **none, s**  
**Default:** **none**

**:sp=** (optional)

The 24-bit ITU national signaling point. This parameter specifies the signaling point (*sp*) in the point code represented by *msa-ssa-sp*. An asterisk (\*) indicates the full range of values from **000-255**.

**Range:** **000-255 \***

**:ssa=** (optional)

The 24-bit ITU national sub signaling area. This parameter specifies the sub signaling area (*ssa*) in the point code represented by the format *msa-ssa-sp*. An asterisk (\*) indicates the full range of values from **000-255**.

**Range:** **000-255 \***

**:zone=** (optional)

The ITU international zone. The parameter specifies the zone in the point code represented by format *zone-area-id*. An asterisk (\*) indicates the full range of values from **0-7**.

**Range:** **0-7, \***

### Example

```
ent-scr-opc:sr=iec:nsfi=stop
ent-scr-opc:sr=iec:ni=240:nsfi=sio:nsr=iec
ent-scr-opc:sr=iec:ni=240:nc=010:ncm=010:nsfi=stop:actname=copy
ent-scr-opc:sr=iec:ni=240:nc=010:ncm=010:nsfi=dpc:nsr=iec
ent-scr-opc:sr=opc1:zone=1:area=2:id=3:nsfi=fail:pcst=none
ent-scr-opc:sr=opc1:zone=2:area=2:id=3:nsfi=fail:pcst=s
ent-scr-opc:sr=opc1:npc=128:nsfi=fail:pcst=s
```

### Dependencies



**CAUTION:** Even though gateway screening is in the screen test mode, as defined by the parameters **gwsa=off** and **gws=on**, the gateway screening action in the stop action set specified by the **actname** parameter of the screen set *will* be performed at the end of the screening process.

The Gateway Screening Rules table can contain a maximum of 362,700 rules.

A complete point code must be specified, using the **ni-nc-ncm**, **zone-area-id**, **msa-ssa-sp**, or **npc** combination unless a value of **c** for “continue” is specified.

The OPC specified by **ni-nc-ncm**, **zone-area-id**, **msa-ssa-sp**, or the **npc** parameter must already exist in the screening reference or within an existing range of OPCs.

ANSI point code value **000-000-000** and ITU-International point code value **0-000-0** are not allowed.

If the **actname** parameter is specified, then the **nsfi=stop** parameter must be specified.

The value of the **actname** parameter must already be defined in the Gateway Screening Stop Action table with the **chg-gws-actset** command. These values are shown in the **ACTNAME** field of the **rtrv-gws-actset** command output.



If the **area=\*** parameter is specified, then the **id=\*** parameter must be specified.

If the **msa=\*** parameter is specified, then the **ssa=\*** and the **sp=\*** parameters must be specified.

If the **nc** parameter is specified as a range, the **ncm** parameter must be specified as an asterisk or as the full range **000–255**.

If the **nc** parameter is specified as a single value or a range, a single value must be specified for the **ni** parameter.

If the **nc** parameter is specified as an asterisk (**nc=\***), the **ncm** parameter must be specified as an asterisk or as the full range **000–255**.

If the **ncm** parameter is specified as a single value, or a range other than the full range of **000–255**, the **ni** and the **nc** parameters must be specified with a single value.

If the **ni** parameter is specified as an asterisk (**ni=\***) or as a range, the **nc** and **ncm** parameters must be specified as an asterisk or as the full range **000–255**.

The **nsfi** and **nsr** parameters must point to an existing screen, or the **nsfi=stop** parameter must be specified, and the **nsr** parameter cannot be specified.

If the **nsfi=stop** parameter is not specified, then the **nsr** parameter must be specified.

The **nsr** parameter must be specified if **nsfi** is not equal to **stop**.

If the **ssa=\*** parameter is specified, then the **sp=\*** parameter must be specified.

If the **zone=\*** parameter is specified, then the **area=\*** and the **id=\*** parameters must be specified.

The Spare Point Code Support feature must be enabled before the **pcst** parameter can be specified.

The spare point code subtype prefix (**s-**) is not supported for ANSI point codes (parameters **ni**, **nc**, **ncm**) or for 24-bit ITU national point codes (parameters **msa**, **ssa**, **sp**). The **pcst** parameter cannot be specified for ANSI and ITU-N24 point codes.

If the **nsfi=fail** parameter is specified, then the **nni**, **nc**, **ncm**, **narea**, **nzone**, **nid**, **nmsa**, **nssa**, **nsp**, and **npc** parameters cannot have a value of **c**.

The value of the **nsfi** parameter must be valid for the OPC entity type.

## Notes

When an OPC screening reference is created, the first entry for a point code must be **c-c-c**, or **c** for the **npc** parameter. Subsequent entries must be specific point codes.

The character **c** is used in the OPC screens to allow the screening process to continue for messages with point codes that do not match any point codes in the OPC screens. When screening for a DPC and the point code being screened does not match any of the point codes in the DPC screens, the message is not rejected and the screening process continues.

There must be an entry in the OPC screens to allow the screening process to continue. This entry consists of a screening reference, point code, **nsfi**, and **nsr**. The point code is in the form of **npc=c** or subfields equal to **c-c-c**. When the character **c** is specified, the **nsfi** and **nsr** parameters must be specified.

If the character **c** is specified for the parameters **ni-nc-ncm** or **zone-area-id** or **msa-ssa-sp**, the character **c** is the only value that can be specified for all three parameters. No other values can be used. For example, a point code **c-c-255** is not allowed. The point code must be **c-c-c**. The asterisk (\*) value cannot be used with the character **c** (for example, a point code **c-c-\*** is not allowed).

When the point code does not match any entries in the blocked OPC screens, the screening process is directed to the screening reference with the point code **c-c-c** or **npc=c**. The **nsfi** and **nsr** in this entry are examined to determine the next step in the screening process.

If the current **ni-nc-ncm** or **zone-area-id** or **msa-ssa-sp** is equal to **c-c-c** or **npc=c**, only the **nsfi** and **nsr** can be changed. Otherwise, only the OPC can be changed.

A range of values is specified by separating the values that define the range by two ampersands (&&); for example, **:ni=025&&100** specifies all network indicators for ANSI point codes from **25** to **100**.

An asterisk cannot not be specified for a parameter value in this command unless an asterisk was specified for the parameter value in the original **ent-scr-opc** command.

If the screen set reaches 100% capacity (indicated by the 100% Full message), the system allows subsequent entries. An error occurs, however, when downloading the screen set to an LIM. Ensure that screen sets do not exceed 100% capacity. Remove screen set entries until the capacity is below 100%.

The spare point code subtype prefix **s-** is supported only for ITU international and ITU national point codes. The **pcst** parameter indicates whether the specified point code has no subtype prefix or has the spare point code prefix.

## Output

```
ent-scr-opc:sr=iec:nsfi=stop
rlghncxa03w 04-01-07 11:43:04 EST EAGLE 31.3.0
ENT-SCR-OPC: SCREEN SET AFFECTED - IEC 25% FULL
ENT-SCR-OPC: MASP A - COMPLTD
;
```

### Legend

**ENT-SCR-OPC**—The command entered that caused this output. This is echoed to the printer as a reference.

**SCREEN SET AFFECTED - IEC**—Identifies the screen set that was affected by the command. The screen set name is provided.

**25% FULL**—Indicates the relative size of the screen set.

## ent-scr-sio

### Enter Allowed SIO

Use this command to add an allowed SIO screening reference and associated attributes (network indicator, service indicator, message priority, H0 heading code, H1 heading code, next screening function identifier, next screening function reference) to the allowed SIO entity set.

**NOTE: To use TUP message type screening, an SIO screening reference with si=04 (TUP) must be defined in the SIO table. This SIO screening reference is specified in the ent-scr-isup command as the next screening reference (nsr) value in a screening reference for TUP message types**

**Keyword:** ent-scr-sio

**Related Commands:** chg-scr-sio, dlt-scr-sio, rtrv-scr-sio

**Command Class:** Database Administration

### Parameters

**:nic=** (mandatory)

Network indicator code (NIC). This parameter specifies an NIC for the SIO screening reference specified in the **sr** parameter. The NIC is the last 2 bits of the subservice field of an SIO. A single value or a range of values can be specified. An asterisk (\*) indicates the full range of values from **0-3**.

**Range:** 0-3 \*

**:nsfi=** (mandatory)

This parameter specifies the next screening category that is used in the gateway screening process, or it indicates that the gateway screening process should stop.

**Range:** **blkdpc, cdpa, cgpa, destfld, dpc, isup, stop**

**blkdpc**— Blocked DPC is the next screening category.

**cgpa**— Allowed CGPA is the next screening category.

**destfld**— Allowed destination field (DESTFLD) is the next screening category.

**dpc**— Allowed DPC is the next screening category.

**isup**— ISUP message type (ISUP) is the next screening category.

**stop**— The gateway screening process ends and the message proceeds through normal routing.

**:pri=** (mandatory)

Message priority. This parameter specifies a single priority, or the beginning of a range of priorities for the SIO screening reference specified by the **sr** parameter. A single value or a range of values can be specified. An asterisk (\*) indicates the full range of values from **0–3**.

**Range:** **0-3 \***

**:si=** (mandatory)

Service indicator. This parameter specifies an SI for the SIO screening reference specified in the **sr** parameter. The SI is the first 4 bits of an SIO. The SS7 code directs the message to the MTP-user at the destination code.

**Range:** **00-15**

**:sr=** (mandatory)

The allowed SIO screening reference name. This parameter identifies a set of one or more **si/nic/pri** combinations.

**Range:** *ayyy*

1 alphabetic character followed by up to 5 alphanumeric characters.

**:actname=** (optional)

The name of the gateway screening stop action set. Stop actions must be administered using the **actname** parameter in conjunction with the gateway screening stop action table (see **chg-gws-actset** and **rtrv-gws-actset**).

**Range:** *ayyyyy*

1 alphabetic character followed by up to 5 alphanumeric characters.

**:h0=** (optional)

H0 heading code. This parameter specifies a new H0 heading code for the screening reference specified in the **sr** parameter. A single value or a range of values can be specified. An asterisk (\*) indicates the full range of values from **0–15**.

**Range:** **0-15 \***

**Default:** Value given if **si** value is **00, 01, or 02**

**:h1=** (optional)

H1 Heading Code. This parameter specifies an H1 heading code for the screening reference specified in the **sr** parameter. A single value or a range of values can be specified. An asterisk (\*) indicates the full range of values from **0–15**.

**Range:** **0-15 \***

**Default:** Value given if **si** value is **00, 01, or 02**

**:nsr=** (optional)

Next screening reference (NSR). The parameter indicates which screening reference in the specified screening category (**nsfi**) is to be used in the screening process. If **nsfi=stop**, the **nsr** parameter cannot be specified.

**Range:** *ayyy*  
1 alphabetic character followed by up to 3 alphanumeric characters

**Default:** No value given

### Example

```
ent-scr-
sio:sr=iec:nic=1:si=1:h0=01&&03:h1=*:pri=*:nsfi=dpc:nsr=abc
ent-scr-sio:sr=iec:nic=1:si=3:pri=2:nsfi=stop
ent-scr-sio:sr=iec:nic=1:si=4:pri=3:nsfi=stop:actname=cncf
```

### Dependencies



**CAUTION:** Even though gateway screening is in the screen test mode, as defined by the parameters **gwsa=off** and **andgws=on**, the gateway screening action in the stop action set specified by the **actname** parameter of the screen set *will* be performed at the end of the screening process.

If the **actname** parameter is specified, then the **nsfi=stop** parameter must be specified.

The value of the **actname** parameter must already be defined in the Gateway Screening Stop Action table with the **chg-gws-actset** command. These values are shown in the *ACTNAME* field of the **rtrv-gws-actset** command output.

If the **si** parameter is equal to **00**, **01**, or **02**, the **h0** and **h1** parameters must be specified. Otherwise, the **h0** parameter cannot be specified.

Table 5-55 shows the valid combinations of the **h0/h1** parameters:

**Table 5-55.** Valid Combinations for the **h0/h1** Parameters (**ent-scr-sio**)

| If the <b>h0</b> parameter is specified as: | The <b>h1</b> parameter can be specified as: |
|---------------------------------------------|----------------------------------------------|
| A single value                              | A single value                               |
| A single value                              | A range                                      |
| A single value                              | An asterisk (*) entry                        |
| A range                                     | An asterisk (*) entry                        |
| An asterisk (*) entry                       | An asterisk (*) entry                        |

When the **chg-scr-sio** command is entered with the **nh0** or **nh1** parameters, the specified values must be valid with the **h0** or **h1** values currently in the database.

If the screening reference exists, the **nic**, **si**, **h0/h1**, and priorities to be added to the allowed SIO entity set for the SIO screening reference cannot exist in that allowed SIO entity set.

If asterisks or ranges are specified for the heading codes, nothing that matches the combination of **nic**, **si**, and the specified heading codes can already exist in the allowed SIO entity set for the screening reference.

If the screening reference does not exist, a new screening reference for the allowed SIO entity set is created.

The **nsfi** and **nsr** parameters must point to an existing screen, or the **nsfi=stop** parameter must be specified, and the **nsr** parameter cannot be specified.

Use Table 5-56 to determine an acceptable combination of the **nsfi** and **si** parameters:

**Table 5-56.** Valid **ent-scr-sio nsfi** and **si** Parameter Combinations

| If the nsfi parameter is... | ...the si parameter must be: |
|-----------------------------|------------------------------|
| destfld                     | 00                           |
| cdpa                        | 03                           |
| cgpa                        | 03                           |
| isup                        | 05                           |

Use Table 5-57 to determine the acceptable combination of the specified parameter values:

**Table 5-57.** Additional Valid **ent-scr-sio** Parameter Combinations

| si value:                                                                                                                                                                        | nic value | pri value | h0 value: | h1 value: |
|----------------------------------------------------------------------------------------------------------------------------------------------------------------------------------|-----------|-----------|-----------|-----------|
| 00                                                                                                                                                                               | s, *      | s, *, r   | s         | s, *, r   |
| 00                                                                                                                                                                               | s, *      | s, *, r   | *, r      | *         |
| 01, 02                                                                                                                                                                           | s, *      | s, *, r   | s         | s, *, r   |
| 01, 02                                                                                                                                                                           | s, *      | s, *, r   | *, r      | *         |
| 03-15                                                                                                                                                                            | s, *      | s, *, r   | u         | u         |
| <p><b>Legend</b><br/>                     s = single value<br/>                     r = range<br/>                     * = asterisk<br/>                     u = unspecified</p> |           |           |           |           |

If the **nsfi** parameter has a value other than **stop** or **fail**, the **nsr** parameter must be specified and must exist.

If the **nsfi=stop** parameter is specified, then the **nsr** parameter must be specified.

If the **si** parameter is greater than **2**, the **h0** and **h1** parameters must not be specified.

The Gateway Screening Rules table can contain a maximum of 362,700 rules.

**Notes**

A range of values is specified by separating the values that define the range by two ampersands (&&); for example, **pri=0&&2** specifies all message priorities for the range **0** to **2**.

If the screen set reaches 100% capacity (indicated by the **100% Full** message), the system will allow subsequent entries. An error will occur, however, when downloading the screen set to a LIM. Screen sets should not exceed 100% capacity. Remove screen set entries until the capacity is below 100%.

To use TUP message type screening, an SIO screening reference with **si=04** (TUP) must be defined in the SIO table. To use ISUP message type screening, a rule with **si=05** (ISUP) must be defined in the SIO table. To use a combined ISUP/TUP screen set for TUP and ISUP message screening, the

SIO screening reference with **si=4** and the SIO screening reference with **si=5** must be two different screening references.

The **h0** and **h1** parameters cannot be specified if **si** is not equal to **00**, **01**, or **02**.

An asterisk cannot not be specified for a parameter value in this command unless an asterisk was specified for the parameter value in the original **ent-scr-sio** command.

## Output

```
ent-scr-
sio:sr=iec:nic=1:si=1:h0=01&&03:h1=*:pri=*:nsfi=dpc:nsr=abc
  rlgncxa03w 04-02-14 16:45:50 EST EAGLE 31.3.0
  ENT-SCR-SIO: SCREEN SET AFFECTED - SS01 25% FULL
  ENT-SCR-SIO: SCREEN SET AFFECTED - SS04 35% FULL
  ENT-SCR-SIO: MASP A - COMPLTD
;
```

### Legend

**ENT-SCR-SIO**—The command entered that caused this output. This is echoed to the printer as a reference.

**SCREEN SET AFFECTED - SS01**—Identifies the screen set that was affected by the command. The screen set name is provided.

**25% FULL**—Indicates the relative size of the screen set.

## ent-scr-tt

### Enter Allowed Translation Type

Use this command to add a specific allowed translation type (TT) screening reference in the TT entity set.

**Keyword:** ent-scr-tt

**Related Commands:** chg-scr-tt, dlt-scr-tt, rtrv-scr-tt

**Command Class:** Database Administration

### Parameters

**:nsfi=** (mandatory)

This parameter specifies the next screening category that is used in the gateway screening process, or it indicates that the gateway screening process should stop.

**Range:** cdpa, stop

**cdpa**— Allowed CDPA is the next screening category.

**stop**— The gateway screening process ends and the message proceeds through normal routing.

**:sr=** (mandatory)

Name of the screening reference.

**Range:** ayyy

1 alphabetic character followed by up to 3 alphanumeric characters

**:type=** (mandatory)

Translation type. The translation type identifies the global title translation type value in the called party address. It is the decimal representation of the 1-byte field used in SS7. A single value or a range of values can be specified. An asterisk (\*) indicates the full range of values from **0–255**.

**Range:** 000-255 \*

**:actname=** (optional)

The name of the gateway screening stop action set. Stop actions must be administered using the **actname** parameter in conjunction with the gateway screening stop action table (see **chg-gws-actset** and **rtrv-gws-actset**).

**Range:** *ayyyyy*

1 alphabetic character followed by up to 5 alphanumeric characters.

**:nsr=** (optional)

Next screening reference (nsr). The parameter indicates which screening reference in the specified screening category (**nsfi**) is to be used in the screening process. This parameter is mandatory if **nsfi** is other than **stop**. The **nsr** parameter cannot be entered if **nsfi** is **stop**. If **nsfi=stop**, the **nsr** parameter cannot be specified.

**Range:** *ayyy*

1 alphabetic character followed by up to 3 alphanumeric characters

**Default:** No value given

### Example

```
ent-scr-tt:sr=iec:type=012:nsfi=cdpa:nsr=wrds
```

```
ent-scr-tt:sr=iec:type=012:nsfi=stop:actname=copy
```

### Dependencies



**CAUTION:** Even though gateway screening is in the screen test mode, as defined by the parameters **gwsa=off** and **andgws=on**, the gateway screening action in the stop action set specified by the **actname** parameter of the screen set *will* be performed at the end of the screening process.

If the screening reference is valid, but does not exist, a new TT screen is created.

If the screening reference exists, a new rule is added to the TT screening table.

An asterisk cannot not be specified for a parameter value in this command unless an asterisk was specified for the parameter value in the original **ent-scr-tt** command.

If the **actname** parameter is specified, the **nsfi=stop** parameter must be specified.

The value of the **actname** parameter must already be defined in the Gateway Screening Stop Action table with the **chg-gws-actset** command. These values are shown in the *ACTNAME* field of the **rtrv-gws-actset** command output.

If the **nsfi=stop** parameter is specified, the **nsr** parameter cannot be specified.

If the **nsfi** parameter has a value other than **stop**, the **nsr** parameter must be specified.

If the **nsr** parameter is specified, the specified screening reference must exist.

If the screening reference (**sr**) exists, the single value or range specified for the allowed **type** to be added to the TT screen for the allowed TT screening reference must not already exist in that TT screen.

If an asterisk is specified for the allowed **type**, nothing can already exist in the TT screen for the screening reference.

The specified value for the **nsfi** parameter is not valid for TT screen.

The screen referenced by **nsfi** and **nsr** must already exist.

The Gateway Screening Rules table can contain a maximum of 362,700 rules.

**Notes**

If the screen set reaches 100% capacity (indicated by the 100% Full message), the system will allow subsequent entries. An error will occur, however, when downloading the screen set to a LIM. Screen sets should not exceed 100% capacity. Remove screen set entries until the capacity is below 100%.

**Output**

```
ent-scr-tt:sr=iec:type=012:nsfi=cdpa:nsr=wrds5
rlghncxa03w 04-01-07 11:43:04 EST EAGLE 31.3.0
ENT-SCR-TT: SCREEN SET AFFECTED - IEC 25% FULL
ENT-SCR-TT: MASP A - COMPLTD
;
```

**Legend**

**ENT-SCR-TT**—The command entered that caused this output. This is echoed to the printer as a reference.

**SCREEN SET AFFECTED - IEC**—Identifies the screen set that was affected by the command. The screen set name is provided.

**25% FULL**—Indicates the relative size of the screen set.

**ent-scrset****Enter Screen Set**

Use this command to create a new screen set and point it to its first screen. A screen set is a set of screens (filters) that can be assigned to a linkset. SS7 messages transmitted on a linkset assigned to a screen set require screening by the system, if screening is enabled.

**Keyword:** ent-scrset

**Related Commands:** chg-scrset, dlt-scrset, rtrv-scrset

**Command Class:** Database Administration

**Parameters**

**:nsfi=** (mandatory)

This parameter specifies the next screening category that is used in the gateway screening process, or it indicates that the gateway screening process should stop.

**Range:** blkdpc, blkopc, dpc, opc, sio, stop

**blkdpc**—Blocked DPC is the next screening category.

**blkopc**—Blocked OPC is the next screening category.

**dpc**—Allowed DPC is the next screening category.

**opc**—Allowed OPC is the next screening category.

**sio**—Allowed SIO is the next screening category.

**stop**—The gateway screening process ends and the message proceeds through normal routing.

**:scrn=** (mandatory)

Screenset name.

**Range:** ayyy

1 alphabetic character followed by up to 3 alphanumeric characters

**:actname=** (optional)

The name of the gateway screening stop action set. Stop actions must be administered using the **actname** parameter in conjunction with the gateway screening stop action table (see **chg-gws-actset** and **rtrv-gws-actset**).



**Range:** *ayyyyy*  
1 alphabetic character followed by up to 5 alphanumeric characters.

**:destfld=** (optional)

This parameter turns on and off the automatic allowed affected destination screening for network management messages against the routing table, self point codes, and capability point codes. When this parameter is **on**, the automatic screening is applied at the end of the provisioned screen set.

**Range:** **yes, no**

**Default:** **yes**

**:nsr=** (optional)

Next screening reference (**nsr**). The parameter indicates which screening reference in the specified screening category (**nsfi**) is to be used in the screening process. If **nsfi=stop**, the **nsr** parameter cannot be specified.

**Range:** *ayyy*

1 alphabetic character followed by up to 3 alphanumeric characters

**Default:** No value given

### Example

```
ent-scrset:scrn=ss01:nsfi=opc:nsr=iec
ent-scrset:scrn=ss02:nsfi=stop
ent-scrset:scrn=empt:nsfi=stop:destfld=yes
ent-scrset:scrn=scr1:nsfi=stop:actname=copy
```

### Dependencies

Even though gateway screening is in the screen test mode, as defined by the parameters **gwsa=off** and **gws=on**, the gateway screening action in the stop action set specified by the **actname** parameter of the screen set *will* be performed at the end of the screening process.

The **nsfi=stop** parameter must be specified before the **actname** parameter can be specified.

The value of the **actname** parameter must already be defined in the Gateway Screening Stop Action table with the **chg-gws-actset** command. These values are shown in the *ACTNAME* field of the **rtrv-gws-actset** command output.

If the **nsfi=stop** parameter is specified, then the **nsr** parameter cannot be specified.

The specified screen set name cannot be in use by another screen set.

A maximum of 63 user-defined screen sets can be defined in the database.

The **nsfi** and **nsr** parameters must point to one or more existing entities in another entity set, or the **nsfi=stop** parameter must be specified, and the **nsr** parameter cannot be specified.

If the **nsfi=stop** parameter is not specified, then the **nsr** parameter must be specified.

The Gateway Screening (GWS)/Global Title Translation (GTT) shared database resource (DBMM.TBL) may not be full.

### Notes

Entering a new screen set may take a few minutes of processor time. The following message appears in the scroll area:

```
Extended processing time required-please wait
```

If the screen set reaches 100% capacity (indicated by the 100% Full message), the system will allow subsequent entries. An error will occur, however, when downloading the screen set to a LIM. Screen sets should not exceed 100% capacity. Remove screen set entries until the capacity is below 100%.

**Output**

```
ent-scrset:scrn=ss01:nsfi=opc:nsr=iec
  rlgncxa03w 04-01-07 11:43:04 EST EAGLE 31.3.0
  ENT-SCRSET: SCREEN SET AFFECTED - SS01 25% FULL
  ENT-SCRSET: MASP A - COMPLTD
;
```

**Legend**

**ENT-SCRSET**—The command entered that caused this output. This is echoed to the printer as a reference.

**SCREEN SET AFFECTED**—Identifies the screen set that was affected by the command. The screen set name is shown.

**% FULL**—Indicates the relative size of the screen set.

**ent-serial-num****Enter Serial Number**

Use this command to enter and lock the NT serial number into the database for an EAGLE 5 ISS STP.

You must enter the serial number at least once without specifying the **lock** parameter. As long as you enter the command without the **lock** parameter, you can enter the system serial number as many times as needed. After the correct serial number is entered, you must use the **lock=yes** parameter to lock the serial number table. You cannot change the serial number with administration commands after the table is locked.

**Keyword:** ent-serial-num

**Related Commands:** rtrv-serial-num

**Command Class:** Database Administration

**Parameters**

**:serial=** (mandatory)

The system NT Serial Number.

**Range:** aayyyyyyy

Up to 15 alphanumeric characters; mixed case is allowed.

The first two characters (the prefix) must be letters.

The remaining characters must be numbers.

The serial number cannot contain spaces or special characters.

**:lock=** (optional)

This parameter is used to lock the Serial Number table when the serial number is entered for the system.



**CAUTION:** After the serial number is locked, you cannot enter it again or change it in the database. You can use the command without the lock parameter to enter the serial number as many times as needed; then enter the command with the lock parameter and the correct serial number to lock the serial number table.

**Range:** yes

**Default:** Not locked

**Example**

```
ent-serial-num:serial=nt00000123
```

```
ent-serial-num:serial=nt00000123:lock=yes
```

**Dependencies**

The serial number must be entered at least once without specifying the **lock** parameter.

The system serial number that is entered when the **lock** parameter is specified must match the serial number that was previously entered in the Serial Number table by using the command without the **lock** parameter.

The system serial number cannot be entered again after the Serial Number table is locked.

**Notes**

None

**Output**

```
ent-serial-num:serial=nt0000123
  rlgncxa03w 04-01-05 16:40:40 EST EAGLE 31.3.0
  ENT-SERIAL-NUM: MASP A - COMPLTD
;
```

**ent-shlf****Enter Shelf**

Use this command to add an equipment shelf to the database.

**Keyword:** ent-shlf

**Related Commands:** dlt-shlf, rtrv-shlf

**Command Class:** Database Administration

**Parameters**

**:loc=** (mandatory)

The shelf location.

**Range:** 1200, 1300, 2100, 2200, 2300, 3100, 3200, 3300, 4100, 4200, 4300, 5100, 5200, 5300, 6100

**:type=** (mandatory)

The type of equipment shelf to be configured.

**Range:** ext

**Example**

```
ent-shlf:type=ext:loc=1200
```

**Dependencies**

The frame and shelf values of the shelf location parameter (**loc**) must be within the valid range (xyzz, where x=frame and y=shelf; zz is always 00 for this command).

The specified shelf location must not have been configured previously.

**Notes**

None

**Output**

```
ent-shlf:type=ext:loc=1200
  rlgncxa03w 04-01-07 11:11:28 EST EAGLE 31.3.0
  ENT-SHLF: MASP A - COMPLTD
;
```

**ent-sid****Enter Self Identification**

Use this command to define additional true point codes for an STP. This command allows newly defined true point codes to be distributed to the cards without requiring system initialization.

**Keyword:** ent-sid

**Related Commands:** chg-sid, rtrv-sid

**Command Class:** Database Administration

**Parameters**

**:pc=** (optional)

ANSI point code with subfields *network indicator-network cluster-network cluster member (ni-nc-ncm)*.

**Synonym:** pca

**Range:** 000-255

Specify a valid value for each subfield of the point code, and separate the subfields with a dash (-).

When **chg-sid:pctype=ansi** is specified, *ni = 000* is not valid.

When **chg-sid:pctype=ansi** is specified, *nc = 000* is not valid if *ni = 001-005*.

When **chg-sid:pctype=ansi** is specified, *nc = 000* is valid if *ni = 006-255*.

The point code **000-000-000** is not a valid point code.

**:pc/pca/pci/pcn/pcn24=** (optional)

STP true point code.

**:pci=** (optional)

ITU international point code with subfields *zone-area-id*. The *prefix* subfield indicates a spare point code (*prefix-zone-area-id*).

**Range:** s-, 0-255

Specify a valid value for each subfield of the point code, and separate the subfields with a dash (-).

*prefix*—s-

*zone*—0-7

*area*—000-255

*id*—0-7

The point code **0-000-0** is not a valid point code.

**:pcn=** (optional)

ITU national point code in the format of a 5-digit number (*nnnnn*); or 2, 3, or 4 numbers (members) separated by dashes (*m1-m2-m3-m4*) as defined by the **chg-stpopts:npfmt** flexible point code option. A group code must be specified when the ITUDUPPC feature is turned on (*nnnnn-gc*, *m1-m2-m3-m4-gc*). The *prefix* subfield indicates a spare point code (*prefix-nnnnn*, *prefix-nnnnn-gc*, *prefix-m1-m2-m3-m4*, *prefix-m1-m2-m3-m4-gc*).

**Range:** s-, 0-16383, aa-zz

Specify a valid value for each subfield of the point code, and separate the subfields with a dash (-).

*prefix*—s-

*nnnnn*—0-16383

*gc*—aa-zz

$m1-m2-m3-m4$ —**0-14** for each member; values must sum to 14

**:pcn24=** (optional)

24-bit ITU national point code with subfields *main signaling area-sub signaling area-signaling point (msa-ssa-sp)*.

**Range:** **000-255**

Specify a valid value for each subfield of the point code, and separate the subfields with a dash (-).

*msa*—**000-255**

*ssa*—**000-255**

*sp*—**000-255**

### Example

To create a site identification STP PC for ITU-N and ITU-I:

```
ent-sid:pcn=123:pci=1-1-1
```

To create a site identification STP PC for ITU-N Spare and ITU-I Spare:

```
ent-sid:pcn=s-123:pci=s-1-1-1
```

### Dependencies

At least one optional parameter must be specified.

The Spare Point Code Support feature must be enabled before an ITU-I or ITU-N spare point code can be specified.

If the system is configured for ANSI format point codes, the specified network indicator value (*ni*) of the **pc** parameter must be **6** or greater when the specified cluster value is **0** (*nc*).

The **pcn** and **pcn24** parameters cannot be specified together in the command.

The specified STP point code must not have been previously defined as a capability point code.

An STP point code cannot exist that is the same type (ANSI, ITU-I, ITU-N, ITU-N24, ITU-ISpare, or ITU-NSpare) as the specified STP point code or must not have been previously defined as a capability point code.

The value of the **pc/pca/pci/pcn/pcn24** parameter must be a full point code.

ITU-N STP destination point codes can be specified only as full point codes.

Invalid parameter was specified.

### Notes

The SID Table can simultaneously contain the node's true point codes of any following point code types: ANSI, ITU-I, ITU-N or ITU-N24, ITU-ISpare, and ITU-NSpare. (Only ITU-N or ITU-N24, not both, can be defined in the SID Table.)

In this command, only ITU-international and ITU national point codes support the spare point code subtype prefix (s-).

### Output

```
ent-sid:pcn=123:pci=1-1-1
  rlgncxa03w 05-01-07 11:11:28 EST  EAGLE 31.12.0
  ENT-SID: MASP A - COMPLTD
;
```

**ent-slk****Enter Signaling Link**

Use this command to add a low-speed or high-speed (ATM or IP) signaling link to a linkset in the database.

Signaling links are the only elements in the database directly supported by a hardware device. When a link is added to a linkset, the link remains in the state OOS-MT-DSBLD (out of service maintenance disabled) until it is activated.

For E1/T1 MIM cards, HC-MIM cards, Channel cards, or E5-E1T1 cards, use this command to associate a signaling link and a timeslot with the E1 or T1 interface that will service the timeslot.

For HC-MIM cards used for SE-HSL links, use this command to assign links **a** and **b** on any 2 of the 8 HC-MIM card ports. For E5-E1T1 cards used for SE-HSL links, use this command to assign link **a** on any 1 of the 8 E5-E1T1 card ports.

Up to 8 signaling links can be assigned to one E1/T1 MIM card, allowing links **a**, **a1** through **a3**, **b**, and **b1** through **b3** to be provisioned. Up to 64 signaling links can be assigned to one HC-MIM card, allowing links **a**, **a1** through **a31**, **b**, and **b1** through **b31** to be provisioned. Up to 32 signaling links can be assigned to one E5-E1T1 card, allowing links **a**, **a1** through **a15**, **b**, and **b1** through **b15** to be provisioned.

**NOTE: The link parameter has been added as a synonym for the port parameter. Either port or link can be used for a few more EAGLE 5 ISS releases; then the port parameter will be removed.**

**Keyword:** ent-slk

**Related Commands:** act-slk, blk-slk, canc-slk, dact-slk, dlt-slk, inh-slk, rept-stat-slk, rtrv-slk, tst-slk, ublk-slk, unhb-slk

**Command Class:** Database Administration

**Parameters**

The following parameters are valid for all types of links: **loc**, **lsn**, **link**, **slc**, **bps**, **ecm**

The following parameters are valid for low-speed links: **l2tset**, **pcrn1**, **pcrn2**

The following parameter is valid only for IP links: **ipliml2**

The following parameters are valid for ATM ANSI high-speed links: **atmtsel**, **ll**, **lpset**, **vci**, **vpi**

The following parameters are valid for E1 ATM links: **atmtsel**, **e1atmcr4**, **e1atmsi**, **e1atmsn**, **lpset**, **vci**, **vpi**

The following parameters are valid for E1 links: **l2tset**, **ecm**, **pcrn1**, **pcrn2**, **e1loc**, **e1port**, **ts**

The following parameters are valid for T1 links: **l2tset**, **ecm**, **pcrn1**, **pcrn2**, **t1loc**, **t1port**, **ts**

The following parameters are valid for SE-HSL links: **l2tset**, **e1port**

The following parameters are valid for ST-HSL-A links: **l2tset**, **t1port**, **ecm**, **pcrn1**, **pcrn2**

The following parameter is valid only for IPSG links: **aname**

**NOTE: As of Release 41.1, the llmode and tset parameters are obsolete.**

**:link=** (mandatory)

The signaling link on the card specified in the **loc** parameter. The links can be specified in any sequence or pattern.

**Synonym:** port

**Range:** **a**, **b**, **a1-a31**, **b1-b31**

Not all card types support all **link** parameter values.

See Table A-1 for valid **link** parameter range values for each type of card that can have a location specified in the **loc** parameter.

**:loc=** (mandatory)

The card location as stenciled on the shelf of the system.

If the signaling link is being assigned to an E1 or T1 card for a Channel card, specify the location of the Channel card. If the link is being assigned for the E1 or T1 card itself, specify the location of the E1 or T1 card.

**Range:** 1101-1108, 1111-1112, 1201-1208, 1211-1218, 1301-1308, 1311-1318, 2101-2108, 2111-2118, 2201-2208, 2211-2218, 2301-2308, 2311-2318, 3101-3108, 3111-3118, 3201-3208, 3211-3218, 3301-3308, 3311-3318, 4101-4108, 4111-4118, 4201-4208, 4211-4218, 4301-4308, 4311-4318, 5101-5108, 5111-5118, 5201-5208, 5211-5218, 5301-5308, 5311-5318, 6101-6108, 6111-6118

**:lsn=** (mandatory)

The name of the linkset. The linkset name must be unique.

**Range:** ayyyyyyyyy  
1 alphabetic character followed by up to 9 alphanumeric characters

**:slc=** (mandatory)

The signaling link code.

The SLC must be unique within the linkset. It must be the same at both the system location and the distant node.

**Range:** 0-15

**:aname=** (optional)

Association name. This parameter specifies the association assigned to the signaling link added in an IPSG linkset.

**Range:** ayyyyyyyyyyyyyy  
Up to 15 alphanumeric characters; the first character must be a letter

**:atmtsel=** (optional)

ATM timing selector. The timing source for the ATM signaling link—internal, line, or external. Internal timing is derived from an internal clock source operating at 1.544 MHz  $\pm$  200 Hz for ANSI links and 2.048 MHz  $\pm$  103 Hz for ITU links. External timing is derived from the High-Speed Master Clock (T1 or E1). Line timing is derived from its received data stream, if present.



**CAUTION: The internal timing source is used for debug purposes only, and is not to be used for production operation.**

If you are using the 2.048 MHz reference clock as the timing source for E1 signaling links, the **atmtsel=external** parameter must be specified for high-speed ATM signaling links. The **atmtsel** parameter is not valid in the command when the **e1loc** or **e1port** parameter is specified for an E1 signaling link. For information on the E1 interface, see Appendix A, “E1 Interface” in the *Database Administration Manual - SS7*.

**Range:** external, internal, line  
**Default:** line

**:bps=** (optional)

The transmission rate for the link in bits per second.

Low speed links running at 4800 bps, 9600 bps and 19,200 bps must be in a linkset that contains only that transmission rate. All other links running rates other than those three speeds can be mixed

within a linkset. Mixing of high speed links and low speed links in a linkset is supported for migration purposes and is not recommended for standard provisioning.

See Table 5-58.

**Range:** 4800, 9600, 19200, 56000, 64000, 1544000, 1984000, 2048000, 1536000

**Default:** 56000

**:e1atmcr4=** (optional)

CRC4 multi-frame structure enable/disable indicator.

**Range:** on, off

**Default:** on

**:e1atmsi=** (optional)

Value of two Spare International bits of NFAS data.

**Range:** 0-3

**Default:** 3

**:e1atmsn=** (optional)

Value of five Spare National bits of NFAS data.

**Range:** 0-31

**Default:** 0

**:e1loc=** (optional)

Card location of an E1 card with an E1 interface that will service the link assigned for a Channel card. This parameter cannot be specified for an HC-MIM card.

**Range:** 1101-1108, 1111-1112, 1201-1208, 1211-1218, 1301-1308, 1311-1318, 2101-2108, 2111-2118, 2201-2208, 2211-2218, 2301-2308, 2311-2318, 3101-3108, 3111-3118, 3201-3208, 3211-3218, 3301-3308, 3311-3318, 4101-4108, 4111-4118, 4201-4208, 4211-4218, 4301-4308, 4311-4318, 5101-5108, 5111-5118, 5201-5208, 5211-5218, 5301-5308, 5311-5318, 6101-6108, 6111-6118

**:e1port=** (optional)

The port for the E1 interface on the E1 card to which a signaling link and timeslot are being assigned, or to which an SE-HSL link is being assigned.

**Range:** 1-8

Ports 3 through 8 can be specified only for HC-MIM and E5-E1T1 cards.

Any 2, but no more than 2, of the 8 ports on an HC-MIM card can be specified when the card is used as an SE-HSL card.

Any 1, but no more than 1, of the 8 ports on an E5-E1T1 card can be specified when the card is used as an SE-HSL card.

**Default:** 1

**:ecm=** (optional)

Error correction method.

**Range:** basic, pcr

**Default:** basic

**:ipliml2=** (optional)

IPLIM level 2 stack.

**Range:** m2pa

**Default:** m2pa

**:l2tset=** (optional)

Level 2 timer set

A signaling link can be assigned to any of the thirty-five timer sets.



**Range:** **1-35**  
**1-10** for ANSI low speed links  
**11-20** for ITU low speed links  
**21-25** for ITUN China high speed links  
**26-30** for ITUN Q703.A high speed links  
**31-35** for Unchannelized T1 high speed links

**Default:** **1** for ANSI low speed links  
**11** for ITU low speed links  
**21** for ITUN China high speed links (SE-HSL link in a linkset defined with the **apctype=ituchina** parameter)  
**26** for ITUN Q703.A high speed links (SE-HSL link in a linkset defined with the **apctype=itun** parameter)  
**31** for Unchannelized T1 high speed links

**:ll=** (optional)

ATM line length in feet.

**Range:** **0-7**  
**0**—0-110 feet  
**1**—110-220 feet  
**2**—220-330 feet  
**3**—330-440 feet  
**4**—440-550 feet  
**5**—550-660 feet  
**6**—More than 660 feet  
**7**—Allows use of external line buildout networks

**Default:** **0**

**:lpset=** (optional)

Link parameter set identifier.

**Range:** **1-30**  
**Default:** **1**—for ANSI  
**21**—for ITU

**:pcrn1=** (optional)

The threshold of the number of MSUs available for retransmission. If the error correction method being used is PCR and this threshold is reached, no new MSUs or FISUs are sent. The retransmission cycle is continued up to the last MSU entered into the retransmission buffer in the order in which they were originally transmitted.

**Range:** **1-1023**  
For low speed E1/T1 links: **1 - 127**  
For unchannelized T1 links: **1 - 1023**

**Default:** **76** - For low speed E1/T1 links.  
**608** - For unchannelized T1 links.

**:pcrn2=** (optional)

The threshold of the number of MSU octets available for retransmission. If the error correction method being used is PCR, and this threshold is reached, no new MSUs or FISUs are sent. The retransmission cycle is continued up to the last MSU entered into the retransmission buffer in the order in which they were originally transmitted.

**Range:**     **300-287744**  
                   For low speed E1/T1 links: **300 - 35500**  
                   For unchanelized T1 links: **7200 - 287744**

**Default:**   **3800** - For low speed E1/T1 links.  
                   **32224** - For unchannelized T1 links.

**:t1loc=** (optional)

Card location of a T1 card with a T1 interface that will service the signaling link assigned for a Channel card. This parameter cannot be specified for an HC-MIM card.

**Range:**     **1101-1108, 1111-1112, 1201-1208, 1211-1218, 1301-1308, 1311-1318, 2101-2108, 2111-2118, 2201-2208, 2211-2218, 2301-2308, 2311-2318, 3101-3108, 3111-3118, 3201-3208, 3211-3218, 3301-3308, 3311-3318, 4101-4108, 4111-4118, 4201-4208, 4211-4218, 4301-4308, 4311-4318, 5101-5108, 5111-5118, 5201-5208, 5211-5218, 5301-5308, 5311-5318, 6101-6108, 6111-6118**

**:t1port=** (optional)

The port for the T1 interface on the T1 card to which a signaling link and timeslot are being assigned, or to which an ST-HSL-A link is being assigned.

**Range:**     **1-8**  
                   Ports 3 through 8 can be specified only for HC-MIM and E5-E1T1 cards.  
                   Any 2, but no more than 2, of the 8 ports on an HC-MIM card can be specified when the card is used as an ST-HSL-A card.  
                   Any 1, but no more than 1, of the 8 ports on an E5-E1T1 card can be specified when the card is used as an ST-HSL-A card.

**Default:**   **1**

**:ts=** (optional)

E1 or T1 timeslot for the assigned signaling link.

**Range:**     **1-31**  
                   E1 range: **1—31**  
                   T1 range: **1—24**

**:vci=** (optional)

Virtual channel identifier.

**Range:**     **5, 32-65535**  
                   **0-4** and **6-31** are reserved values; they cannot be specified in the command.

**Default:**   **5**

**:vpi=** (optional)

Virtual path identifier.

**Range:**     **0-4095**  
**Default:**   **0**

**:l1mode=** (obsolete)

The mode of operation used to select the link clocking source at layer 1. One end of a V.35 link must be DTE and the other end must be DCE.

This parameter is obsolete.

**Range:**     **dte, dce**  
**Default:**   **dte**

**:tset=** (obsolete)

Transmitter signal element timing.

This parameter is obsolete.

**Range:**     **on, off**

**Default:** off

### Example

```
ent-
slk:loc=1201:link=a:slc=3:lsn=c1201001:l2tset=3:bps=64000:ecm=bas
ic
```

```
ent-
slk:loc=1201:link=a:slc=3:lsn=c1201001:l2tset=3:ecm=pcr:pcrn1=50:
pcrn2=4000
```

The following example adds signalling link a to linkset lshcap on an HCAP card.

```
ent-slk:loc=1304:link=a:slc=0:lsn=lshcap:lpset=3:vci=5:vpi=15
```

```
ent-
slk:loc=1302:link=a:slc=5:lsn=atm1302a:lpset=3:vci=10:vpi=15 :l1=0
:atmtsel=external
```

The following example adds a link to linkset ls1 at 56 KB for a multi-port LIM:

```
ent-slk:loc=1205:link=a1:slc=0:lsn=ls1
```

The following example assigns a timeslot for the signaling link on an E1 card that uses E1 port 1.

```
ent-slk:loc=1206:link=a:slc=0:lsn=e1jwk:ts=1
```

The following example assigns a timeslot for a signaling link on an E1 card that uses E1 port 2.

```
ent-slk:loc=1205:link=b:slc=0:lsn=e1typ:ts=1:e1port=2
```

The following example assigns a timeslot for a signaling link on a Channel card in the location specified by the loc parameter. The Channel card is serviced by the E1 assigned to the E1 card in the location specified by the e1loc parameter.

```
ent-slk:loc=1206:link=a:slc=0:lsn=e1jwk:ts=2:e1loc=1205
```

The following example adds a timeslot for a signaling link on an E1/T1 MIM card using E1 port 2 and signaling link b2.

```
ent-slk:loc=1205:link=b2:slc=0:lsn=e1typ:ts=1:e1port=2
```

The following example adds a timeslot for a signaling link on an E1/T1 MIM card used as an E1 Channel card in card location 1206. The command specifies signaling link port a1. The E1 interface that services the Channel card is on the E1 card in card location 1205 (e1loc parameter).

```
ent-slk:loc=1206:link=a1:slc=1:lsn=e1jwk:ts=2:e1loc=1205
```

The following example adds a timeslot for a signaling link on an E1/T1 MIM card using signaling link a2. The T1 interface defaults to the interface defined for T1 port 1 (t1port parameter not specified)

```
ent-slk:loc=1207:link=a2:slc=0:lsn=t1jwk:bps=64000:ts=1
```

The following example adds a timeslot for a signaling link on an E1/T1 MIM card using T1 port 2 and signaling link b2.

```
ent-slk:loc=1207:link=b2:slc=0:lsn=t1typ:ts=1:t1port=2
```

The following example adds a timeslot for a signaling link on an E1/T1 MIM card used as an T1 Channel card in card location 1208. The command specifies signaling link a1. The T1 interface that services the Channel card is on the T1 card in card location 1207 (t1loc parameter).

```
ent-
slk:loc=1208:link=a3:slc=1:lsn=t1jwk:bps=64000:ts=2:t1loc=1207
```

The following example adds a signaling link to linkset ls1 at 2048000 bps for an E1 ATM card that will use the CRC4 multi-frame structure

```
ent-
slk:loc=1205:link=a:slc=0:lsn=ls1:bps=2048000:atmsel=line:elatmcr
c4=on
```

The following example adds a link to link set ls1 at 56 Kbps for an HC-MIM card that is provisioned as an E1 card:

```
ent-slk:loc=1205:link=a31:slc=0:lsn=ls1:elport=4:ts=4
```

The following example adds a link to link set l21 at 64 Kbps for an HC-MIM card that is provisioned as a T1 card:

```
ent-slk:loc=1207:link=b27:slc=3:lsn=ls2:t1port=8:ts=6:bps=64000
```

The following example adds signalling link b to linkset lse5atm on an E5-ATM card.

```
ent-slk:loc=1305:link=b:slc=1:lsn=lse5atm:lpset=3:vci=5:vpi=15
```

The following example adds a signaling link to an IPSG linkset for an E5-ENET card that is running the ipsg application and hosting an association.

```
ent-slk:loc=1204:port=b:lsn=lsipsg:slc=3:aname=assocsg1204
```

## Dependencies

Card locations **1113** - **1118** cannot be specified.

The **pcrn1** parameter and the **pcrn2** parameter can be specified for the **ss7ansi** and **ccs7itu** applications only when the **ecm=pcr** parameter is specified.

Use Table 5-58 to select a valid transmission rate for the **bps** parameter.

**Table 5-58.** Transmission Rate for the **bps** Parameter

| Card Application                            | bps Transmission Rate | Domain |
|---------------------------------------------|-----------------------|--------|
| <b>ss7ansi</b>                              | 56000 or 64000        | SS7    |
| <b>ccs7itu</b>                              | 56000 or 64000        | SS7    |
| <b>atmansi</b>                              | 1544000               | SS7    |
| <b>ss7ansi, ccs7itu</b> (E1 SE-HSL cards)   | 1984000               | SS7    |
| <b>ss7ansi, ccs7itu</b> (T1 ST-HSL-A cards) | 1536000               | SS7    |
| <b>atmitu</b>                               | 2048000               | SS7    |

If the card application is **ss7ansi** or **ccs7itu**, then a value of **56000** or **64000**, respectively, must be specified for the **bps** parameter. If SE-HSL or ST-HSL-A cards are used, then a value of **1984000** or **1536000**, respectively, must be specified for the **bps** parameter.

The value of the **bps** parameter must be **56000** if the card type is **limds0**.

The value of the **bps** parameter must be **1544000** if the card application is **atmansi**.

The value of the **bps** parameter must be **56000** if the card is a multi-port LIM.

The value of the **bps** parameter must be **2048000** if the card type is **lime1atm**.

The card application must be **atmansi** (see the **ent-card** command) before the **bps=1544000** parameter can be specified. The card application must be **atmitu** before the **bps=2048000** parameter can be specified.

The value of the **bps** parameter must be **1984000** or **1536000** if the card is an HC-MIM or E5-E1T1 card used for SE-HSL or ST-HSL-A links (the **linkclass=unchan** parameter is specified in the **ent-e1** or **ent-t1** command) respectively.

Low speed links running at 4800 bps, 9600 bps and 19,200 bps must be in a linkset that contains only that transmission rate. All other links running rates other than those three speeds can be mixed within a linkset. Mixing of high speed links and low speed links in a linkset is supported for migration purposes and is not recommended for standard provisioning.

The values **0 - 4** and **6 - 31** cannot be specified for the **vci** parameter; these values are reserved system values.

The linkset type must be valid for the card:

- The linkset adjacent point code (APC) type must be the same as the card application type (ANSI or ITU).
- IPSP-M2PA linksets cannot contain IPGWx and IPSP-M3UA link types. During migration to an IPSP-M2PA linkset, link types other than IPGWx or IPSP-M3UA can be added to the linkset. After the linkset is transitioned to IPSP-M2PA, only IPSP-M2PA and IPLIMx links can be added.
- IPSP-M3UA linksets cannot contain SS7IPGW, IPGWI, and IPGHC link types. After the linkset is transitioned to IPSP-M3UA, only IPSP-M3UA links can be added to the linkset.

The specified linkset name must exist in the database.

The value of the **slc** parameter cannot be used by more than one link in the linkset.

A card must be equipped in the specified card location.

The card in the specified card location must be a LIM or MIM and must exist.

A link is already assigned to the specified port.

The parameters that are specified for the command must be valid for the type of card in the specified card location.

When a low-speed link is assigned to a card (card application is not **atmansi** or **atmitu**), the ATM high-speed link and E1 ATM parameters (**atmtsel**, **e1atmrc4**, **etatmsi**, **e1atmsn**, **ll**, **lpset**, **vci**, and **vpi**) cannot be specified.

If an ATM high-speed link is assigned to a card (card application is **atmansi**), then the low-speed link parameters (**ecm**, **l2tset**, **pcrn1** and **pcrn2**) cannot be specified.

When an IP link is assigned to a card (card application is **ss7ipgw**, **ipgwi**, **iplim**, or **iplimi**), the following low-speed link parameters, ATM high-speed link parameters, and E1 ATM high-speed link parameters cannot be specified: **lpset**, **vci**, **vpi**, **ll**, **atmtsel**, **e1atmrc4**, **e1atmsi**, **e1atmsn**, **ecm**, **l2tset**, **pcrn1** and **pcrn2**.

The following **link** parameter values can be specified for the following cards that support more than 2 links per card:

- **a1-a3, b1-b3**—Multi-port LIM (MPL), SSEDCCM card running the **iplim** or **iplimi** application with links having **ipliml2=m2pa**, E1/T1 MIM card
- **a1-a31, b1-b31**—HC-MIM card
- **a1-a15, b1-b15**—E5-E1T1 card
- **a1-a7, b1-b7**—E5-ENET card running the **iplim** or **iplimi** application that supports 16 links.
- **a1-a15, b1-b15**—E5-ENET card running the **ipsg** application.

The **link** parameter values **a1**, **b1**, **a2**, **b2**, **a3**, and **b3** can be specified only when:

- The card type is **limds0**, and the card application is **ss7ansi**.
- The card type is **lime1**, **limt1**, or **limch**, and the card application is **ss7ansi** or **ccs7itu**.
- The card is an SSEDCCM, and the card application is **iplim** or **iplimi**.
- The card type is **lime1**, **limt1**, or **limch** (and the card is not an SE-HSL or ST-HSL-A card), and the card application is **ss7ansi** or **ccs7itu**.
- The card is an SSEDCCM card (IPLIM to 8 points) and the card application is **iplim**, **iplimi**, or an E5-ENET card and the card application is **iplim**, **iplimi**, or **ipsg**.

The **link** parameter values **a4-a7** and **b4-b7** can be specified for E5-ENET cards running the **iplim** or **iplimi** application, and for E1/T1 MIM cards running the **ss7ansi** or **ccs7itu** application. The **link** parameter values **a4-a15** and **b4-b15** can be specified only when the card type is **lime1** or **limt1** for E5-E1T1 cards and the card application is **ss7ansi** or **ccs7itu**. The **link** parameter values **a4-a31** and **b4-b31** can be specified only when the card type is **lime1** or **limt1** for an HC-MIM card and the card application is **ss7ansi** or **ccs7itu**. The **link** parameter values **a4-a15** and **b4-b15** can be specified for E5-ENET cards running the **ipsg** application.

The **link** parameter values **a4-a15** and **b4-b15** are valid when the card type is **lime1** or **limt1** for either an E5-E1T1 card or an HC-MIM card that is used as an E1 or T1 card, and the card application is **ss7ansi** or **ccs7itu**. The **link** parameter values **a16-a31** and **b16-b31** can be specified only when the card type is **lime1** or **limt1** for an HC-MIM card that is used as an E1 or T1 card, and the card application is **ss7ansi** or **ccs7itu**. The **link** parameter values **a4-a31** and **b4-b31** cannot be specified for a Channel card or an SE-HSL card or an ST-HSL-A card. The **link** parameter values **a**, **b**, **a1-a7**, **b1-b7** are valid for E5-ENET cards running **iplim** or **iplimi** application. The link parameter values **a**, **a1-a15** and **b**, **b1-b15** are valid for E5-ENET cards running the **ipsg** application.

HIPR cards must be in card locations **xy 09** and **xy 10** on any shelf that contains one or more HC-MIM, E5-E1T1, or E5-ENET cards. When **link** parameter values **a4-a31** and **b4-b31** are specified, the system verifies that HIPR cards are in card locations **xy 09** and **xy 10** on the same shelf with the specified HC-MIM, E5-E1T1, or E5-ENET card.

Links **a16-a31** and **b16-b31** cannot be specified for even-numbered card locations. HC-MIM cards are dual-slot cards. These links are assigned only to the cards in odd-numbered locations.

If the card application is **ss7ipgw** or **ipgwi**, then the **link=a** parameter must be specified.

If an HC-MIM card is used for SE-HSL or ST-HSL-A links, then only the **link=a** parameter or **link=b** parameter can be specified. If an E5-E1T1 card is used for SE-HSL or ST-HSL-A links, then only the **link=a** parameter can be specified.

If the specified linkset has a mate linkset, only 1 SS7IPGW or IPGWI signaling link can be assigned to the specified linkset. The assigned link must be an SS7IPGW or IPGWI link.

Up to 8 IPGWx signaling links can be assigned to one linkset if the linkset is not mated.

The associated location must be empty, or an E5-ATM card must be provisioned in the location before the **link=b** parameter can be specified. Upon initialization, the E5-ATM card is in **boot phase-0** for up to 30 secs. During this period, the E5-ATM hardware is not detected, which may result in a lack of support for signalling link **b**.

When an IP link is assigned to a card running card application **ss7ipgw**, the **lsn** parameter must reference a linkset that specifies an IP gateway adjacent point code (**ent-ls:ipgwapc=yes**).

When an IP link is assigned to a card running card application **ipgwi**, the **lsn** parameter must reference a linkset that specifies an IP gateway adjacent point code (**ent-ls:ipgwapc=yes**).

If the **multgc=yes** parameter is specified, then all links assigned to the linkset must be of the same type.

If **multgc=yes** parameter is specified, then the card in the specified card location must be running the **ipgwi**, **iplimi**, or **ipsg** application.

The **ipliml2** parameter can be specified only for IPLIM cards.

Linksets with 14-bit ITU-N and 24-bit ITU-N APCs or SAPCs can contain only IPGWI or IPLIMI M3UA links. These links support 14-bit ITU-N and 24-bit ITU-N traffic simultaneously. Linksets containing 24-bit ITU-N APCs or SAPCs cannot contain E1 ATM links. These links do not support 24-bit ITU-N traffic.

A maximum of 1200, 1500, 2000, or 2800 links is allowed in the system. The maximum depends on the enabled Large System # Links quantity (see the **rtrv-ctrl-feat** command output). A FAK is required to enable support for more than 1200 links. A mixture of T1 ATM high-speed, E1 ATM high-speed, SE-HSL, IP, and low-speed signaling links is supported.

HC-MIM and E5-E1T1 cards cannot be used as or with Channel cards. The **e1loc** and **t1loc** parameters cannot be specified for HC-MIM or E5-E1T1 cards.

If a card location is specified for a Channel card (card type **limch**) assigned to an E1 interface, then the **e1loc** parameter must be specified. If a card location is specified for a Channel card (card type **limch**) assigned to a T1 interface, then the **t1loc** parameter must be specified. If a card location is specified for an E1, T1, or Channel card (card type **lime1**, **limt1**, or **limch**), then the **ts** parameter must be specified for the link.

A specific timeslot can be assigned in the **ts** parameter to only one E1 signaling link for the E1 interface that services that timeslot.

A specific timeslot can be assigned in the **ts** parameter to only one T1 signaling link for the T1 interface that services that timeslot.

The **ts** parameter value for a T1 link must be in the range **1-24**.

The **ts** parameter cannot be specified for HC-MIM or E5-E1T1 cards that are used for SE-HSL or ST-HSL-A links (the **linkclass=unchan** parameter is specified in the **ent-e1** or **ent-t1** command).

If the E1 interface has CAS multi-framing enabled for an E1 card or a Channel card, timeslot 16 cannot be specified.

A maximum of 180 ATM links (E1-ATM, LIM-ATM, E5-ATM, etc.) can be provisioned in the system.

If the card is an IPSPG card, then the **ipsg=yes** parameter must be specified (see the **ent-ls** command).

If an IPSPG linkset and card are used, then the **aname** parameter must be specified.

If the **aname=m3ua** parameter is specified, then a maximum of 16 signaling links can be assigned.

If the **aname=m2pa** parameter is specified, then only one signaling link can be assigned.

The resulting total TPS of all signaling links configured for an IPSPG card cannot exceed 5000 TPS.

The total TPS of all signaling links configured in the EAGLE 5 ISS cannot exceed 500,000 TPS.

The value specified for the **aname** parameter must already exist in the database.

The adapter assigned to the association must be the same as the adapter assigned to the linkset.

The value specified for the **aname** parameter must be associated with the value specified for the **loc** parameter.

Linksets must have same routing context to share an association.

The **aname** parameter can be specified only for IPSPG links.

The **e1loc** and **t1loc** or **e1port** and **t1port** parameters cannot be specified together in the command.

The **e1port** parameter is valid only for E1/T1 MIM, HC-MIM, or E5-E1T1 cards used as E1 cards. The **t1port** parameter is valid only for E1/T1 MIM, HC-MIM, or E5-E1T1 cards used as T1

cards. The **e1loc** and **t1loc** parameters are only valid for E1/T1 MIM cards used as E1/T1 channel cards. The **ts** parameter is only valid for E1/T1 MIM, HC-MIM or E5-E1T1 cards used as E1/T1 cards, and E1/T1 MIM cards used as E1/T1 channel cards. The **lsn**, **slc**, **loc**, **port**, **bps**, **lpset**, **atmsel**, **vci**, **vpi**, **e1atmcrc4**, **e1atmsi**, and **e1atmsn** parameters are only valid for LIM E1 ATM cards. Low-speed link parameters (**ecm**, **l2tset**, **pcrn1**, and **pcrn2**) cannot be specified. The **e1port** and **l2tset** parameters are allowed for HC-MIM or E5-E1T1 cards used as SE-HSL cards. The **t1port** and **l2tset** parameters are allowed for HC-MIM or E5-E1T1 cards used as ST-HSL-A cards.

The E1 interface for the card at the location specified by the **loc** parameter must be defined (see the **ent-e1** command) before a signaling link can be assigned to the port.

If an E1/T1 MIM card is used as an E1 channel card, then the **e1port=1** parameter must be specified.

If an E1/T1 MIM card is used as a T1 channel card, then the **t1port=1** parameter must be specified.

The same value must be specified for the **e1loc** or **t1loc** parameter for all provisioned links on an E1 or T1 channel card, respectively.

The card location specified by the **e1loc** parameter must contain an HC-MIM, E5-E1T1, or E1/T1 MIM card that is used as an E1 card.

The specified card slot must be equipped with the valid card type.

If the value specified for the **loc** parameter indicates a Channel card, then the Channel card must be installed on the same shelf as the E1 card that is specified by the **e1loc** parameter

The E1 interface for the E1 port specified by **e1loc** parameter must already be defined (see the **ent-e1** command) before a signaling link can be assigned to the card.

A channel bridged slave port (see the **chg-e1** or **chg-t1** command) cannot be specified as a value for the **e1port** or **t1port** parameter.

The value specified for the **ts** parameter cannot already be in use by the E1 card.

The T1 interface of the T1 card specified by the **t1loc** parameter must already be defined (see the **ent-t1** command) before a signaling link can be assigned to the card.

If the **loc** parameter is used to specify a Channel card, then the channel card must be installed on the same shelf as the T1 card that is specified by the **t1loc** parameter.

The T1 interface for the T1 port specified by **t1loc** parameter must already be defined (see the **ent-t1** command) before a signaling link can be assigned to the card.

All available links on the specified IPLIM card have already been provisioned.

If a multi-port LIM card is used, then the **bps=56000** parameter must be specified.

If the **loc** parameter indicates an ST-HSL-A card, then the **t1port** parameter must be specified.

The **fan** feature bit (see the **chg-feat** command) must be turned on before links **a16-a31** and **b16-b31** can be provisioned.

If the **loc** parameter indicates an SE-HSL card, then the **e1port** parameter must be specified.

If the link is In-Service, then this command cannot be entered.

Links must be available in the linkset that is specified by the **lsn** parameter.

The domain of the linkset specified by the **lsn** parameter must match the domain of the link specified by the **link** parameter.

The link capacity cannot exceed the maximum allowed by the SE-HSL or ST-HSL-A FAK (see the **rtrv-ctrl-feat** command output).

The L2 timer range must be valid for the type of signaling link being provisioned.



**Table 5-59.** Valid L2 Timer Ranges

| SLK type       | Range   |
|----------------|---------|
| ANSI LSL       | 1 - 10  |
| ITU LSL        | 11 - 20 |
| E1-HSL (China) | 21 - 25 |
| E1-HSL (ITUN)  | 26 - 30 |
| T1-HSL-A       | 31 - 35 |

The same value cannot be specified for the **aname** parameter for multiple links in the same linkset.

The same value must be specified for the **ecm** parameter for all links in a linkset.

The T1 interface on the card at the location specified by the **loc** parameter must be defined (see the **ent-t1** command) before a signaling link can be assigned to the port.

The N1/N2 thresholds for PCR Error Correction Mode (ECM) specified by the **pcrn1** and **pcrn2** parameters must be within the range specified for the link type. Only low speed E1/T1 (LSL) and Unchannelized T1 links support PCR ECM.

**Table 5-60.** LSL link thresholds

|       | Minimum | Maximum | Default |
|-------|---------|---------|---------|
| PCRN1 | 1       | 127     | 76      |
| PCRN2 | 300     | 35,500  | 3,800   |

**Table 5-61.** Unchannelized T1 link thresholds

|       | Minimum | Maximum | Default |
|-------|---------|---------|---------|
| PCRN1 | 1       | 1023    | 608     |
| PCRN2 | 7,200   | 287,744 | 32,224  |

**Notes**

The **ll** parameter is not available in the SEAS database.

When a signaling link is assigned to a card that is running the **atmansi** application or the **atmitu** application, and the **bps**, **vci**, **vpi**, **e1atmcr4**, **e1atmsi**, **e1atmsn**, **ll**, **atmsel**, and **lpset** parameters are not specified, the ATM default values are assigned for these parameters.

The MTP Level 2 timers (**l2tset** parameter) are not valid for IP links or for ATM links.

A link is *equipped* when it is physically operational, that is, when the hardware is in place that is needed to support the link .

***Signaling Links for E1/T1 MIM Cards***

One E1/T1 MIM card can be used for E1 card functions or T1 card functions, but not both at the same time. E1 cards and T1 cards can coexist in the same EAGLE 5 ISS.

If you are configuring signaling links for an E1, T1, or Channel card, each signaling link must be associated with a timeslot assigned in the command. Each signaling link/timeslot assigned for an E1, T1, or Channel card must be associated with an E1 or T1 interface that has been defined for one of the ports on the E1/T1 MIM card (see the **ent-e1** or **ent-t1** command).

Timeslots and signaling links are defined in the **ent-slk** command by a combination of card location (**loc** parameter), the signaling link that uses the timeslot, the signaling link port (**a**, **a1**, **a2**, **a3**, **b**, **b1**, **b2**, or **b3**), the timeslot number, and the card location and port for the servicing E1 or T1 interface on the E1 or T1 card (**e1loc** and **e1port** or **t1loc** and **t1port** parameters). Timeslot numbers must be unique to the E1 or T1 interface that services the timeslot; that is, the same timeslot cannot be assigned to the same E1 or T1 interface for different signaling links.

If the link and timeslot are for a Channel card, the Channel card location is specified in the **loc** parameter, and the associated E1 or T1 card is specified in the **e1loc** or **t1loc** parameter.

If the link and timeslot are for the E1 or T1 card itself, the E1 or T1 card location is specified in the **loc** parameter, and the E1 or T1 interface port (1 or 2) that will service the link is specified in the **e1port** or **t1port** parameter.

The E1/T1 MIM used as an E1 card can service 8 timeslots assigned to signaling links for itself, and 1-31 timeslots assigned to signaling links for Channel cards on the same shelf. If the E1 card is not servicing any Channel cards, 8 links with associated timeslots can be defined—all on the interface on port 1, all on the interface on port 2, or some on the interface on each port. If the E1 card is servicing Channel card links, the links for the E1 card itself can be assigned either to the port 1 interface or the port 2 interface. But for each E1 link assigned to the port 1 interface, the number of links is decreased by one that can be assigned to that port interface for a Channel card. All links for any Channel cards serviced by an the E1 card must be serviced by the interface on port 1. Each Channel card can have up to 8 links assigned to the E1 interface on port 1, for a total of up to 31 links (Timeslot 0 cannot be used). used.) All links for a Channel card must be assigned to the same E1 card. If the E1 card is servicing any Channel cards, the 8 links for the E1 card itself can all be assigned to the interface on port 2 (which cannot service Channel card links and can service only 8 links).

The E1/T1 MIM used as a T1 card can service 8 timeslots assigned to signaling links for itself, and 1-24 timeslots assigned to signaling links for Channel cards on the same shelf. If the T1 card is not servicing any Channel cards, 8 links with associated timeslots can be defined—all on the interface on port 1, all on the interface on port 2, or some on the interface on each port. If the T1 card is servicing Channel card links, the links for the T1 card itself can be assigned either to the port 1 interface or the port 2 interface. But for each T1 link assigned to the port 1 interface, the number of links is decreased by one that can be assigned to that port interface for a Channel card. All links for any Channel cards serviced by the T1 card must be serviced by the interface on port 1. Each Channel card can have up to 8 links assigned to the T1 interface on port 1, for a total of up to 24 links. All links for a Channel card must be assigned to the same T1 card. If the T1 card is servicing any Channel cards, the 8 links for the T1 card itself can all be assigned to the interface on port 2 (which cannot service Channel card links and can service only 8 links).

#### ***Signaling Links for HC-MIM Cards***

An HC-MIM card can be used for E1 card functions or T1 card functions, but not both at the same time. E1 cards and T1 cards can coexist in the same EAGLE 5 ISS.

Each signaling link for an E1 card or a T1 card must be associated with a timeslot assigned in the **ent-slk** command. Each signaling link and timeslot assigned for an E1 card or a T1 card must be associated with an E1 or T1 interface that has been defined for one of the ports on the HC-MIM card (see the **ent-e1** command or the **ent-t1** command).

Timeslots and signaling links are defined in the **ent-slk** command by a combination of card location (**loc** parameter), the signaling link that uses the timeslot (**a**, **a 1-a31**, **b**, **b1-b31**), the timeslot number (**ts**), and the port for the servicing E1 or T1 interface on the E1 or T1 card (**e1port** or **t1port** parameter). Timeslot numbers must be unique to the E1 or T1 interface that services the timeslot; that is, the same timeslot cannot be assigned to the same E1 or T1 interface for more than one signaling link.

Each HC-MIM used as an E1 card can have up to 64 signaling links assigned to the card. Each E1 interface on an HC-MIM card can service 1-31 timeslots.

Each HC-MIM used as a T1 card can have up to 64 signaling links assigned to the card. Each T1 interface on an HC-MIM card can service 1-24 timeslots.

#### *Signaling Links for E5-E1T1 Cards*

An E5-E1T1 card can be used for E1 card functions or T1 card functions, but not both at the same time. E1 cards and T1 cards can coexist in the same EAGLE 5 ISS.

Each signaling link for an E1 card or a T1 card must be associated with a timeslot assigned in the **ent-slk** command. Each signaling link and timeslot assigned for an E1 card or a T1 card must be associated with an E1 or T1 interface that has been defined for one of the ports on the E5-E1T1 card (see the **ent-e1** command or the **ent-t1** command).

Timeslots and signaling links are defined in the **ent-slk** command by a combination of card location (**loc** parameter), the signaling link that uses the timeslot (**a**, **a 1-a15**, **b**, **b1-b15**), the timeslot number (**ts**), and the port for the servicing E1 or T1 interface on the E1 or T1 card (**e1port** or **t1port** parameter). Timeslot numbers must be unique to the E1 or T1 interface that services the timeslot; that is, the same timeslot cannot be assigned to the same E1 or T1 interface for more than one signaling link.

Each E5-E1T1 used as an E1 card can have up to 32 signaling links assigned to the card. Each E1 interface on an E5-E1T1 card can service 1-31 timeslots.

Each E5-E1T1 used as a T1 card can have up to 32 signaling links assigned to the card. Each T1 interface on an E5-E1T1 card can service 1-24 timeslots.

#### *Signaling Links for E5-ATM Cards*

An E5-ATM card can support either E1 or T1 card functions: however, the card cannot support both functions at the same time. E5-ATM cards running E1 and T1 functions can coexist in the same EAGLE 5 ISS. Each E5-ATM card can have up to 2 signaling links assigned to the card. Only the **a** or **b** link can be used. The **a** and **b** links can be configured for a location if a card is not seated in that location. However, if a card other than the E5-ATM card is inserted in this location, the card is auto-inhibited.

#### *Signaling Links for IPSG Cards*

An IPSG card supports both M2PA and M3UA signaling links.

The card supports up to 32 signaling links per card, 16 M3UA links per association, and 32 associations per card.

Multiple M3UA signaling links with routing context (different linksets/AS, up to 16) can use a single association.

Each M3UA AS-ASP instance maps to a signaling link. Signaling link state depends upon AS-ASP state, as well as administrative action.

The IPSG card **can** share M2PA linksets with IPLIM, IPLIMI, and IPLHC cards, but the card **cannot** share M3UA linksets with SS7IPGW, IPGWI, and IPGHC cards.

The IPSPG card supports ANSI and ITU and ITUN/ITUN24 signaling links simultaneously on one card and on one association. Each signaling link resides in a set of networks determined by the APC and SAPCs of the assigned linkset.

The **slktps** parameter specified for the IPSPG linkset (see the **ent-ls/chg-ls** command) specifies the TPS for each link provisioned for that linkset.

Mixing of high speed links and low speed links in a linkset is supported for migration purposes and is not recommended for standard provisioning.

#### **Card Locations and Requirements**

See Table A-1 for the permitted ranges for the link parameter.

### **Output**

The following example adds signalling link **b** to linkset **lse5atm** on an E5-ATM card.

```
ent-slk:loc=1305:link=b:slc=6:lsn=1se5atm:lpset=3:vci=5:vpi=15
tekelecstp 08-02-14 13:17:13 EST EAGLE 38.0.0
ENT-SLK: MASP A - COMPLTD
```

## **ent-spc**

### **Enter Secondary Point Code**

Use this command to enter an SPC (secondary point code) into the database.

**Keyword:** ent-spc

**Related Commands:** dlt-spc, rtrv-spc

**Command Class:** Database Administration

### **Parameters**

**:spc=** (mandatory)

ANSI point code with subfields network indicator-network cluster-network cluster member (*ni-nc-ncm*).

**Synonym:** spca

**Range:** 000-255

Specify a valid value for each subfield of the point code, and separate the subfields with a dash (-).

When **chg-sid:pctype=ansi** is specified, *ni* = 000 is not valid.

When **chg-sid:pctype=ansi** is specified, *nc* = 000 is not valid if *ni* = 001-005.

When **chg-sid:pctype=ansi** is specified, *nc* = 000 is valid if *ni* = 006-255.

The point code 000-000-000 is not a valid point code.

**:spc/spca/spci/spcn/spcn24=** (mandatory)

Secondary point code.

**NOTE:** See "Point Code Formats and Conversion" for a detailed description of point code formats, rules for specification, and examples.

**:spci=** (mandatory)

ITU international secondary point code with subfields *zone-area-id*. The *prefix* subfield indicates a spare point code (*prefix-zone-area-id*).

**Range:** s-, 0-255

Specify a valid value for each subfield of the point code, and separate the subfields with a dash (-).

*prefix*—s-

*zone*—**0-7**  
*area*—**000-255**  
*id*—**0-7**

The point code **0-000-0** is not a valid point code.

**:spcn=** (mandatory)

ITU national point code in the format of a 5-digit number (*nnnnn*); or 2, 3, or 4 numbers (members) separated by dashes (*m1-m2-m3-m4*) as defined by the **chg-stpopts:npcfmti** flexible point code option. A group code must be specified when the ITUDUPPC feature is turned on (*nnnnn-gc*, *m1-m2-m3-m4-gc*). The *prefix* subfield indicates a spare point code (*prefix-nnnnn*, *prefix-nnnnn-gc*, *prefix-m1-m2-m3-m4*, *prefix-m1-m2-m3-m4-gc*).

**Range:** **s-, 0-16383, aa-zz**

Specify a valid value for each subfield of the point code, and separate the subfields with a dash (-).

*prefix*—**s-**  
*nnnnn*—**0-16383**  
*gc*—**aa-zz**  
*m1-m2-m3-m4*—**0-14** for each member; values must sum to 14

**:spcn24=** (mandatory)

24-bit ITU national point code with subfields *main signaling area-sub signaling area-signaling point* (*msa-ssa-sp*).

**Range:** **000-255**

Specify a valid value for each subfield of the point code, and separate the subfields with a dash (-).

*msa*—**000-255**  
*ssa*—**000-255**  
*sp*—**000-255**

## Example

The following example adds a secondary point code:

**ent-spc:spc=10-20-30**

The following example adds a 24-bit ITU-N secondary point code:

**ent-spc:spcn24=99-99-99**

The following example adds a spare ITU-N secondary point code:

**ent-spc:spcn=s-12345**

## Dependencies

The Spare Point Code Support feature must be enabled before a spare point code (prefix *s-*) can be specified in the command.

The value specified for the **spc** parameter must be a full point code.

The ANSI point code range requirements have been violated for an ANSI SID. For the ANSI secondary point code with subfields *ni-nc-ncm*, the *ni* component cannot equal **000**, the *nc* component cannot equal **000** if the *ni* component is **001 - 005**.

The specified secondary point code to be added must not already exist as a secondary point code.

A maximum of 40 secondary point codes may be defined.

The MPC feature must be turned on before a secondary point code can be added using this command.

The value specified for the **spc** parameter cannot already exist in the Destination table as a destination point code, true point code, or concerned point code.

The specified secondary point code cannot match an existing true point code or capability point code in the Site Identification table.

### Notes

If the **spcn** parameter is specified, its format must match the format that was assigned with the **chg-stpopts:npcfmti** parameter.

In this command, only ITU-international and ITU national point codes support the spare point code subtype prefix (s-).

### Output

```
ent-spc:spc=10-20-30
  rlghncxa03w 04-02-18 08:50:12 EST EAGLE 31.3.0
  Secondary Point Code table is (7 of 40) 17% full
  ENT-SPC: MASP A - COMPLTD
;
```

## ent-srvsel

## Enter Service Selector

Use this command to assign the applicable service selectors required to specify a service entry for DSM services.

**Keyword:** ent-srvsel

**Related Commands:** chg-srvsel, dlt-srvsel, rtrv-srvsel

**Command Class:** Database Administration

### Parameters

**:gti/gtia/gtii/gtin/gtin24=** (mandatory)

Global title indicator. For all service selector commands, the domain is defined as **gti** and **gtia** (ANSI), **gtii** (ITU international), and **gtin** (ITU national). For the service selector commands, **gti** and **gtia** are equivalent.

**Range:** Supported value for ANSI: **gti=2** and **gtia=2**  
Supported values for ITU: **gtii= 2, 4 ; gtin= 2, 4 ; gtin24 = 2, 4**

**:serv=** (mandatory)

DSM service.

**NOTE: The gport service cannot be used for the Prepaid SMS Intercept Phase 1 (PPSMS) or the Portability Check for Mobile Originated SMS feature; use the smsmr service. The mnp service includes the G-Port, A-Port, and IS41 GSM Migration services.**

**Range:** **eir, gflex, gport, inpq, inpmr, smsmr, idps, idpr, mnp, vflex, atinp, ttr**

**eir** — Equipment Identity Register

**gflex** — GSM flexible numbering

**gport** — GSM number portability

**inpq** — INP query

**inpmr** — INP message relay

**smsmr** — MO SMS ASD, MO SMS B-Party Routing, MO SMS GRN, MO-based GSM SMS NP, MO-based IS41 SMS NP, MO SMS IS41-to-GSM Migration, Portability Check for MO SMS, Prepaid SMS Intercept Phase 1

**idps** — IDP Screening for Prepaid

**idpr** — Prepaid IDP Query Relay

**mnp** — Mobile Number Portability

**vflex** — Voice Mail Router

**atinp**— ATI Number Portability Query (ATINP)

**ttr**— Triggerless TCAP Relay

**:ssn=** (mandatory)

Subsystem number.

**Range:** 0-255 \*

**:tt=** (mandatory)

Translation type.

**Range:** 0-255

**:nai=** (optional)

Nature of Address indicator. The Nature of Address indicator can be specified by supplying either a mnemonic value (**nai** parameter) or an explicit numeric value (**naiv** parameter). Either the **nai** parameter or the **naiv** parameter, but not both, can be specified in the command. Table A-5 shows the mapping between the **naiv** and the **nai** parameter values.

**Range:** sub, rsvd, natl, intl

**:naiv=** (optional)

Nature of Address indicator value. The Nature of Address indicator can be specified by supplying either a mnemonic value (**nai** parameter) or an explicit numeric value (**naiv** parameter). Either the **nai** parameter or the **naiv** parameter, but not both, can be specified in the command. Table A-5 shows the mapping between the **naiv** and the **nai** parameter values.

**Range:** 0-127

**:np=** (optional)

Numbering Plan. The numbering plan can be specified by supplying either a mnemonic value (**np** parameter) or an explicit numeric value (**npv** parameter). Either the **np** parameter or the **npv** parameter, but not both, can be specified in the command. Table A-6 shows the mapping between the **npv** and the **np** parameter values.

**Range:** e164, generic, x121, f69, e210, e212, e214, private

**:npv=** (optional)

Numbering Plan value. The numbering plan can be specified by supplying either a mnemonic value (**np** parameter) or an explicit numeric value (**npv** parameter). Either the **np** parameter or the **npv** parameter, but not both, can be specified in the command. Table A-6 shows the mapping between the **npv** and the **np** parameter values.

**Range:** 0-15

**:snai=** (optional)

The service nature of address indicator.

**Range:** sub, natl, intl, rnidn, rnrndn, rnsdn, ccrndn

**natl**— National significant number

**intl**— International number

**rnidn**— Routing number prefix and international dialed/directory number

**rnrndn**— Routing number prefix and national dialed/directory number

**rnsdn**— Routing number prefix and subscriber dialed/directory number

**ccrndn**— Country code, routing number, and national directory number

**sub**—Subscriber number

**:snp=** (optional)

The service numbering plan.

**Range:** e164, e212, e214

## Example

```
ent-srvsel:gtii=4:tt=20:np=e164:nai=intl:serv=eir:ssn=*
```

```

ent-
srvsel:gtin24=4:tt=4:np=e164:nai=intl:serv=gport:snp=e164:snai=intl:ssn=9
ent-srvsel:gtii=4:tt=4:np=e164:nai=intl:serv=eir:ssn=11
ent-
srvsel:gtin=4:tt=9:np=e214:nai=natl:snp=e164:snai=intl:serv=gflex:ssn=250
ent-srvsel:gtii=4:tt=20:np=e164:nai=intl:serv=eir:ssn=*
ent-srvsel:gtii=4:tt=0:np=e164:nai=intl:serv=atinp:ssn=11
ent-srvsel:gtii=2:tt=6:snai=intl:snp=e164:serv=smsmr:ssn=10

```

## Dependencies

The G-Flex feature must be turned on before the **serv=gflex** parameter can be specified.

The INP feature must be turned on before the **serv=inpnr** or **serv=inpq** parameter can be specified.

The G-Port feature must be turned on before the **serv=gport** parameter can be specified.

The Equipment Identity Register (EIR) feature must be turned on before the **serv=eir** parameter can be specified.

The **np** and **npv** parameters cannot be specified together in the command.

The **nai** and **naiv** parameters cannot be specified together in the command.

The **gtia=4** parameter cannot be specified. The value **4** is not valid for the **gtia** parameter.

The values **1** and **3** are not valid for the **gti/gtia/gtii/gtin/gtin24** parameters.

If the **gti/gtia/gtii/gtin/gtin24=2** parameter is specified, then the **np(v)** and **nai(v)** parameter combinations cannot be specified.

If the **gtii/gtin/gtin24=4** parameter is specified, then an **np(v)** and **nai(v)** parameter combination must be specified. The parameters can be specified in the following combinations: **np** and **naiv**, **npv** and **nai**, **np** and **nai**, or **npv** and **naiv**.

If the **serv** parameter has a value of **inpnr**, **inpq**, **gport**, or **eir**, then the **gtia** and **gti** parameters cannot be specified.

If the **serv=inpnr** parameter is specified, then the **snp=e164** parameter must be specified.

If the **serv=inpq** parameter is specified, then the **gtii** parameter cannot be specified.

If the value specified for the **snai** parameter is **rnidn**, **rnsdn**, or **rnsdn**, then the value specified for the **serv** parameter must be **inpnr**, **gport**, or **smsmr**.

If the value specified for the **serv** parameter is **gflex**, **gport**, **inpnr**, or **smsmr**, then the **snai** and **snp** parameters must be specified.

If the value specified for the **serv** parameter is **atinp**, **eir**, **idpr**, **inpq**, **trr**, or **vflex**, then the **snai** and **snp** parameters cannot be specified.

If the **snai=ccrnsdn** parameter is specified, then the value specified for the **serv** parameter must be **gport** or **smsmr**.

If the value specified for the **serv** parameter is **gport** or **smsmr**, then the **snp=e164** parameter must be specified.

An entry cannot already exist that matches the new **gti/gtia/gtii/gtin/gtin24**, **tt**, **ssn**, **np(v)**, and **nai(v)** combination of parameters.

For the specified **gti/gtia/gtii/gtin**, **tt**, **np(v)**, **nai(v)**, and **ssn=\*** parameters, an entry matching a specific **ssn** cannot already exist.



For the specified **gti/gtia/gtii/gtin**, **tt**, **np(v)**, **nai(v)**, and **ssn** parameters, an entry matching the **ssn=\*** parameter cannot already exist.

If the **ansigflex** STP option is enabled (see the **chg-stpotps** command), then an ITU service selector cannot be entered.

The IDP Screening for Prepaid feature must be on before the **serv=idps** parameter can be specified.

If the **serv=idps** parameter is specified, then the supported mandatory parameters are **tt**, **serv**, **ssn**, **gtin**, and **gtii**. Supported optional parameters are **np** and **nai**.

The Prepaid IDP Query Relay feature must be turned on or the IAR Base feature must be enabled before the **serv=ttr** parameter can be specified.

If a value of **idpr** or **ttr** is specified for the **serv** parameter, then the only valid mandatory service parameters are **tt**, **serv**, **ssn**, **gtii**, and **gtin**, and the only valid optional parameters are **np** and **nai**.

If the A-Port or IGM feature is enabled, then the **serv=gport** parameter cannot be specified.

An entry cannot already exist that matches the new **gti/gtii/gtin/gtin24**, **tt**, **ssn**, **np(v)**, and **nai(v)** combination of parameters.

An entry cannot already exist that matches the new **gti/gtii/gtin/gtin24**, **tt**, **ssn**, **np(v)**, and **nai(v)** combination of parameters.

An entry cannot already exist that matches the new **gti/gtii/gtin/gtin24**, **tt**, **ssn**, **np(v)**, and **nai(v)** combination of parameters.

The V-Flex feature must be turned on before the **serv=vflex** parameter can be specified.

The ATINP feature must be enabled before the **serv=atinp** parameter can be specified.

The PPSMS or Portability Check for Mobile Originated SMS feature must be turned on, or the MO SMS ASD, MO SMS GRN, MO SMS B-Party Routing, MO SMS IS41-to-GSM Migration, MO-based GSM SMS NP, or MO-based IS41 SMS NP feature must be enabled before the **serv=smsmr** parameter can be specified.

If the **serv=atinp** parameter is specified, then the **gtin24** parameter cannot be specified.

The Prepaid IDP Query Relay feature must be turned on before the **serv=idpr** parameter can be specified.

The A-Port or IGM feature must be turned on, or the A-Port or IGM feature must be enabled and the G-Port feature must be turned on before the **serv=mnp** parameter can be specified.

## Output

```
ent-srvsel:gtia=2:tt=9:ssn=250:snp=e212:snai=nat1:serv=gflex
  rlgncxa03w 07-10-05 16:40:40 EST EAGLE 37.5.0
  Service Selector table is (114 of 1024) 11% full
  ENT-SRVSEL: MASP A - COMPLTD
;
```

## ent-ss-appl

### Enter Subsystem Application

Use this command to reserve a subsystem number for an application and set the application status to be online or offline. You can define only one subsystem per application. The application must be unique.

**Keyword:** ent-ss-appl

**Related Commands:** chg-ss-appl, dlt-ss-appl, rtrv-ss-appl

**Command Class:** Database Administration

## Parameters

- :appl=** (mandatory)  
Application type.  
**Range:** **lnp, inp, eir, vflex, atinpq**
- :ssn=** (mandatory)  
Primary subsystem number.  
**Range:** **2-255**
- :stat=** (optional)  
Status.  
**Range:** **offline, online**  
**Default:** **offline**

## Example

```
ent-ss-appl:appl=lnp:ssn=16:stat=online
ent-ss-appl:appl=inp:ssn=15:stat=offline
```

## Dependencies

The LNP feature must be turned on (see the **enable-ctrl-feat** command) before the **ent-ss-appl:appl=lnp** command can be entered.

The INP feature must be turned on before the **ent-ss-appl:appl=inp** command can be entered.

The Equipment Identity Register (EIR) feature must be turned on before the **ent-ss-appl:appl=eir** command can be entered.

The specified application (**appl** parameter) must not already be assigned.

The maximum number of applications must not already be assigned.

For LNP, the STP true point code and LNP subsystem must exist in the MAP table.

For INP, the STP true point code and INP subsystem must exist in the MAP table.

For EIR, the STP true point code and EIR subsystem must exist in the MAP table.

STP True Point Code must exist in MAP table

If the V-Flex feature is turned on, then the STP true point code and V-Flex subsystem must exist in the MAP table.

The V-Flex feature must be turned on before the **appl=vflex** parameter can be specified.

The ATINP feature must be enabled before the **appl=atinpq** parameter can be specified.

For ATINP, the STP true point code and ATINPQ subsystem must exist in the MAP table.

The value specified for the **ssn** parameter cannot already exist in the SS-APPL table.

The specified MAP table entry for the subsystem must be a valid point code type for that subsystem.

The following point code types are not valid for the indicated subsystems:

- If the subsystem number is configured for the INP subsystem in the SS-APPL table, then the True Point code cannot be an ITU-I or ANSI point code.
- If the subsystem number is configured for the EIR subsystem in the SS-APPL table, then the True Point code cannot be an ANSI point code.
- If the subsystem number is configured for the ATINPQ or VFLEX subsystem in the SS-APPL table, then the True Point code can not be an ITU-N24 point code.

**Notes**

If not specified, the application subsystem status defaults to **offline**. When the application is **offline**, the application subsystem is down.

The LNP application status applies to both message relay and LNP query.

**Output**

```
ent-ss-appl:appl=lnp:ssn=16:stat=online
  r1ghncxa03w 04-01-05 16:40:40 EST EAGLE 31.3.0
  ENT-SS-APPL: MASP A - COMPLTD
;
```

**ent-subnetid****Enter Subnet ID**

Use this command to enter elements into the Subnet ID list, for the ISUP NP with EPAP feature. Each entry is identified by the Subnet ID and the Subnet number.

The Subnet ID length (**subnetidlen** parameter) must be entered first, before the command is entered the second time to enter the Subnet ID and Subnet Number.

**Keyword:** ent-subnetid

**Related Commands:** dlt-subnetid, rtrv-subnetid

**Command Class:** Database Administration

**Parameters**

**:subnetid=** (optional)

Vendor Subnet ID

**Range:** 1-15 digits

This number must contain the number of digits defined by the **subnetidlen** parameter value.

Valid digits are **0-9, a-f, A-F**.

**:subnetidlen=** (optional)

Subnet ID Length.

**Range:** 1-15

All Subnet IDs defined for the ISUP NP with EPAP feature must contain this number of digits.

**:subnetnum=** (optional)

Subnet Number. The Subnet Number is used as a reference to the prefix number for the ISUP NP with EPAP feature.

**Range:** 1-5

**1**—Corresponds to the prefix defined with prefix number 1 (see the **chg-prefix** command).

**2**—Corresponds to the prefix defined with prefix number 2 (see the **chg-prefix** command).

**3**—Corresponds to the prefix defined with prefix number 3 (see the **chg-prefix** command).

**4**—Corresponds to the prefix defined with prefix number 4 (see the **chg-prefix** command).

**5**—Corresponds to the prefix defined with prefix number 5 (see the **chg-prefix** command).

**Example**

```
ent-subnetid:subnetidlen=6
ent-subnetid:subnetid=886933:subnetnum=1
```

**Dependencies**

The value **none** cannot be specified for the **subnetid** parameter.

The ISUP NP with EPAP feature must be enabled before this command can be entered.

The SUBNETID table can contain a maximum of 50 entries.

The specified ID entry cannot already exist in the SUBNETID table.

All SUBNETID table entries must have the number of digits defined by the **subnetidlen** parameter value.

The prefix with the same prefix number as the specified Subnet Number must already be provisioned for the ISUP NP with EPA feature.

The Subnet ID length cannot be changed unless the SUBNETID table is empty. All Subnet IDs must be deleted from the table before a different Subnet ID length can be entered.

The Subnet ID length must be entered before any Subnet IDs can be defined.

The **subnetidlen** parameter cannot be specified in the same command with the **subnetid** and **subnetnum** parameters.

Either the **subnetidlen** parameter, or the **subnetid** and **subnetnum** parameters can be specified in one command.

**Notes**

None.

**Output**

The Subnet ID length must be entered first.

```
ent-subnetid:subnetidlen=6
  rlghncxa03w 04-10-07 11:11:28 EST  EAGLE 31.11.0
  ENT-SUBNETID: MASP A - COMPLTD
;
```

The first Subnet ID and Subnet number can be entered after the Subnet ID length has been entered.

```
ent-subnetid:subnetid=886933:subnetnum=1
  rlghncxa03w 04-10-07 11:11:28 EST  EAGLE 31.11.0
  VENDID table is (6 of 50) 11% full
  ENT-SUBNETID: MASP A - COMPLTD
;
```

**ent-t1****Enter T1 Interface**

Use this command to enter an interface for an E1/T1 MIM card, an HC-MIM or E5-E1T1 card used as a T1 card or an ST-HSL-A card.

**NOTE: The T1 port number on the card and the T1 card location in the EAGLE 5 ISS must be specified.**

**NOTE: Framing, line length, encoding, master/slave clocking options, and the signaling bit setting can be set with this command.**

**NOTE:** On an HC-MIM or E5-E1T1 card, T1 ports 1, 3, 5, and 7 (master ports) can be independently channel bridged with their adjacent even-numbered (slave) T1 ports 2, 4, 6, and 8 to allow non-signaling data pass-through.

**NOTE:** Any of the 8 ports on an HC-MIM or E5-E1T1 card can be specified when the card is used as a standard HC-MIM or E5-E1T1 card, respectively. No more than 2 ports on the HC-MIM card or 1 port on the E5-E1T1 card when used as an ST-HSL-A card can have defined T1 interfaces.

**Keyword:** ent-t1

**Related Commands:** chg-t1, dlt-t1, rtrv-t1, tst-t1

**Command Class:** Database Administration

## Parameters

**:loc=** (mandatory)

The card location as stenciled on the shelf of the system.

**Range:** 1101-1108, 1111-1112, 1201-1208, 1211-1218, 1301-1308, 1311-1318, 2101-2108, 2111-2118, 2201-2208, 2211-2218, 2301-2308, 2311-2318, 3101-3108, 3111-3118, 3201-3208, 3211-3218, 3301-3308, 3311-3318, 4101-4108, 4111-4118, 4201-4208, 4211-4218, 4301-4308, 4311-4318, 5101-5108, 5111-5118, 5201-5208, 5211-5218, 5301-5308, 5311-5318, 6101-6108, 6111-6118

**:t1port=** (mandatory)

T1 card port number. The value must be a T1 port for which an interface has not been configured on the specified T1 card.

**Range:** 1-8

Ports 3 through 8 can be specified only for HC-MIM and E5-E1T1 cards.

Any 2 of the 8 ports on an HC-MIM card can be specified when the card is used as an ST-HSL-A card.

Any 1 of the 8 ports on an E5-E1T1 card can be specified when the card is used as an ST-HSL-A card.

**:chanbrdg=** (optional)

Port bridging status. This parameter specifies whether an odd-numbered T1 port on an HC-MIM or E5-E1T1 card is channel bridged with its adjacent even-numbered T1 port for non-signaling data pass through.

**Range:** on, off

**Default:** off

**:encode=** (optional)

Indicator for use of B8ZS or AMI encoding/decoding.

**Range:** b8zs, ami

**Default:** b8zs

**:force=** (optional)

This parameter specifies to provision an odd-numbered T1 port to channel bridging mode if the adjacent next higher even-numbered port is already provisioned with a T1 interface.

**Range:** yes, no

**:framing=** (optional)

Indicator for framing format.

**Range:** sf, esf, esfperf

esfperf — esf framing format with performance monitoring

**Default:** sf

**:linkclass=** (optional)

This parameter specifies the link class for links that are assigned to HC-MIM and E5-E1T1 cards (channelized links) or ST-HSL-A cards (unchannelized links).

**Range:** **chan, unchan**

**Default:** **chan**

**:ll=** (optional)

T1 cable length in feet between the EAGLE 5 ISS and the connecting node.

**Range:** **0-655**

**Default:** **133**

**:minsurate=** (optional)

Minimum signal unit rate. This parameter specifies the minimum number of SUs present on a link uniformly distributed.

The **linkclass=unchan** parameter must be specified for an ST-HSL-A card before this parameter can be specified.

**Range:** **400-1600**

**Default:** **1000**

**:t1tsel=** (optional)

Timing source

**Range:** **line, external, recovered**

**line** — slave timing source

**external** — master timing source

**recovered** — timing source recovered from the paired master port for channel bridged slave ports

**Default:** **line**

**Example**

```
ent-
t1:loc=1205:t1port=1:encode=ami:t1tsel=external:framing=sf:ll=100
ent-t1:loc=1205:t1port=2:encode=b8zs:t1tsel=external:framing=esf
ent-t1:loc=1203:t1port=1:chanbrdg=on:t1tsel=recovered
ent-t1:loc=1203:t1port=3:chanbrdg=on:t1tsel=external
ent-t1:loc=1203:t1port=2:linkclass=unchan:minsurate=1200
```

**Dependencies**

The specified card location (**loc** parameter) must be equipped.

The card specified by the **loc** parameter must be a **limt1** card type.

The port specified by the **t1port** parameter must not be already equipped with a T1 interface.

The **chanbrdg=on** parameter can be specified only for HC-MIM and E5-E1T1 cards.

The **chanbrdg=on** parameter cannot be specified for even-numbered T1 ports (**t1port** parameter).

The timing source parameter **t1tsel** must be specified if the **chanbrdg=on** parameter is specified.

The **t1tsel=line** parameter cannot be specified for a T1 port (**t1port** parameter) when the **chanbrdg=on** parameter is specified.

The **t1tsel=recovered** parameter cannot be specified for a T1 port (**t1port** parameter) unless the **chanbrdg=on** parameter is specified.

When provisioning an odd-numbered T1 port (**t1port** parameter) on an HC-MIM or E5-E1T1 card to channel bridging mode using the **chanbrdg=on** parameter, the **force=yes** parameter must be specified if the adjacent even-numbered port is already provisioned with a T1 interface.

Before the **chanbrdg=on** parameter can be specified for an odd-numbered T1 port on an HC-MIM or E5-E1T1 card, all signaling links assigned to the adjacent even-numbered T1 port must be deleted (see the **dlt-slk** command).

The **fan** feature bit must be on (see the **chg-feat** command) before HC-MIM cards (used as T1 or ST-HSL-A cards) can be used in an EAGLE 5 ISS shelf.

HIPR cards must be equipped in card locations *xy09* and *xy10* (*x* is the frame, *y* is the shelf) on each EAGLE 5 ISS shelf that contains one or more HC-MIM or E5-E1T1 cards that are used as T1 cards or ST-HSL-A cards.

T1 ports **3 - 8** (**t1port** parameter) can be specified only for HC-MIM and E5-E1T1 cards.

If the **linkclass=unchan** parameter is specified, then the **chanbrdg=on** parameter cannot be specified. The **linkclass=unchan** parameter must be specified before the **minsurate** parameter can be specified.

An ST-HSL-A feature quantity (**enable-ctrl-feat** command) must be enabled before the **linkclass=unchan** parameter can be specified for an ST-HSL-A card.

The **linkclass=unchan** parameter can be specified only for HC-MIM and E5-E1T1 cards.

Channelized and unchannelized T1 ports (mixed mode) cannot be specified on a single HC-MIM or E5-E1T1 card (the card cannot be used as a T1 card and an ST-HSL-A card at the same time).

Only 2 of the 8 ports can be used for T1 interfaces on an HC-MIM card that is used as an ST-HSL-A card.

Only 1 of the 8 ports can be used for T1 interfaces on an E5-E1T1 card that is used as an ST-HSL-A card.

The ST-HSL-A feature must be turned on before the **framing=esfperf** parameter can be specified.

## Notes

One or two T1 interfaces must be defined on a T1 card after the T1 and any associated Channel card types (**limt1** and **limch**) are defined in the database (see the **ent-card** command), and before the signaling links and associated timeslots are defined for the T1 card and any associated Channel cards (see the **ent-slk** command).

External timing is derived from the EAGLE 5 ISS High-Speed Master Clock (1.544 MHz for T1 or 2.048 MHz for E1); therefore, the Master Timing feature is required. Line timing is derived from its received data stream, if present.

Up to 8 T1 interfaces can be defined on an HC-MIM or E5-E1T1 card used as a T1 card after the T1 card type (**limt1**) is defined in the database (with the **ent-card** command), and before the signaling links and associated timeslots are defined for the T1 card.

On an HC-MIM or E5-E1T1 card, T1 ports 1, 3, 5, and 7 (master ports) can be independently channel bridged with their adjacent even-numbered (slave) ports 2, 4, 6, and 8 to allow non-signaling data pass-through. The **chanbrdg=on** parameter must be specified for the odd-numbered T1 port.

For an ST-HSL-A card, the **minsurate** parameter indicates the least number of SUs present on a link uniformly distributed. The number of SUs present is the **minsurate** parameter value (without link traffic) and the **minsurate** parameter value minus the number of MSUs (with link traffic).

**Output**

```

ent-
t1:loc=1205:t1port=1:encode=ami:t1tsel=external:framing=sf:l1=100
  rlgncxa03w 04-02-20 09:07:58 EST EAGLE 31.3.0
  ENT-T1: MASP A - COMPLTD
;

```

**ent-tt****Enter Translation Type**

Use this command to add a translation type to the system database.

**NOTE: If the EGTT (Enhanced Global Title Translation) feature is turned on in the system, the system will no longer accept GTT (Global Title Translation) and TT (Translation Type) commands. Refer to the new command sets that replace the GTT and TT commands: GTT Selector commands (ent/chg/dlt/rtrv-gttset), GTT Set commands (ent/dlt/rtrv-gttset), and GTA commands (ent/chg/dlt/rtrv-gta).**

**Keyword:** ent-tt

**Related Commands:** dlt-tt, rtrv-tt

**Command Class:** Database Administration

**Parameters**

**:type/typea/typei/typen/typen24=** (mandatory)

A translation type numeric value may be entered as ANSI type (**type** or **typea**) and also as an ITU type (**typei** or **typen**). However, they are separate entities.

**Range:** 000-255

**Default:** No translation type is specified

**:alias=** (optional)

The alias of the global title translation type

**Range:** 000-255

**Default:** No alias assignment is made.

**:ndgt=** (optional)

The number of digits contained in the global title translation. This parameter is not valid if the VGTT (variable length GTT) feature is turned on.

**Range:** 1-21

**Default:** 6

(not applicable if the VGTT feature is on)

**:ttn=** (optional)

Translation type name.

**Range:** ayyyyyyyy

1 alphabetic character followed by up to 7 alphanumeric characters

**Default:** No translation name is given

**Example**

```
ent-tt:type=230:ttn=lidb:ndgt=5
```

```
ent-tt:type=230:ttn=lidb:alias=007
```

```
ent-tt:type=2:ndgt=5
```

```
ent-tt:type=3
```

**Dependencies**

This command is not valid when the EGTT feature is turned on.



Asterisk (\*) parameter values are not allowed for this command.

The translation type specified by **type** or **typea** cannot already exist in the database containing the ANSI types. A translation type specified by **typei**, **typen**, or **typen24** cannot already exist in the database containing the ITU types.

The translation name cannot already exist in either the ANSI or ITU database.

If an alias is specified, the translation type must be specified and must already exist in the database for the network type. If the translation name is specified when defining an alias, the name must already be associated with the translation type.

The translated signaling point code must be a full point code (*ni-nc-ncm*).

The translated signaling point code must have been specified previously as a full point code destination, or it must be a member of a previously specified cluster.

The **alias** parameter and the **ndgt** parameter cannot be specified together in the command.

If an alias is specified, the **alias** value cannot already be defined as either a translation type or an alias for the respective (ANSI or ITU) type.

The translation type name must be unique.

The **ndgt** parameter is not valid if the VGTT (variable length GTT) feature is turned on.

## Notes

The new translation type is entered into the translation type table along with the translation name and the number of digits used by the translation type.

The **ttn** parameter always refers to a translation type. Aliases do not have translation type names.

## Output

```
ent-tt:type=2:ndgt=5
  rlgncxa03w 04-01-07 11:43:04 EST EAGLE 31.3.0
  ENT-TT: MASP A - COMPLTD
;
```

## ent-ttmap

### Enter Translation Type Mapping

Use this command to add a mapped SS7 message translation type (TT) for a given gateway linkset name. With this command you can add to the database the identification of the type of allowed global title translation in the SS7 message before and after translation type mapping. For example, you can use this command to add to the database that you want the SS7 message translation type 001 (before TT mapping) mapped to 254 (after TT mapping).

**Keyword:** ent-ttmap

**Related Commands:** chg-ttmap, dlt-ttmap, rtrv-ttmap

**Command Class:** Database Administration

## Parameters

**:ett=** (mandatory)

Translation type before mapping. The identification of the type of global title translation in the SS7 message *before* translation type mapping. This attribute is the decimal representation of the 1-octet binary field used by the SS7 protocol to identify the translation type.

**Range:** 000-255

**:io=** (mandatory)

Incoming or outgoing. The system uses this parameter to indicate whether the translation type mapping data provisioned for the gateway linkset is for SS7 messages *received* or *sent* on the linkset.

**Range:** i, o

**i**— incoming  
**o**— outgoing

**:lsn=** (mandatory)

Linkset name. The unique network identifier for the gateway linkset.

**Range:** *ayyyyyyyyy*  
 1 alphabetic character followed by 9 alphanumeric characters

**:mtt=** (mandatory)

Mapped translation type. The identification of the type of global title translation in the SS7 message *after* translation type mapping. This attribute is the decimal representation of the 1-octet binary field used by the SS7 protocol to identify the translation type.

**Range:** **000-255**

**Example**

```
ent-ttmap:lsn=nc001:io=i:ett=128:mtt=16
```

**Dependencies**

The linkset must be defined.

The Translation Type Mapping table must not be full for the linkset specified in the **lsn** parameter.

**Notes**

None

**Output**

```
ent-ttmap:lsn=nc001:io=i:ett=128:mtt=16
rlghncxa03w 04-02-21 13:09:27 EST EAGLE 31.3.0
ENT-TTMAP: MASP A - COMPLTD

TTMAP table for nc001 is (2 of 64) 3% full
;
```

**ent-user****Enter User**

Use this command to add a user to the database. When you first enter the command, the system prompts you for the user's password, which must follow the administered password guidelines. For security reasons, the password is not displayed. After successfully entering a user password, you are prompted to verify it by entering it again.

**NOTE: As of Release 40.1, the lnpbas parameter is obsolete.**

**Keyword:** **ent-user**

**Related Commands:** **act-user, chg-pid, chg-user, dact-user, dlt-user, login, logout, rept-stat-user, rtrv-secu-user, rtrv-user**

**Command Class:** Security Administration

**Parameters****:uid=** (mandatory)

User ID

**Range:** *azzzzzzzzzzzzzzz*  
 1 alphabetic character followed by up to 15 alphanumeric characters (including asterisks, single quotes, and commas)

**:all=** (optional)

Specifies whether or not the user ID is assigned all non-configurable command classes (LINK, SA, SYS, PU, DB, DBG, LNP).

**Range:**     **yes, no**

**Default:**   **no**

**:cc1=** (optional)

Configurable command class name (*ayy*), and an indicator (**-yes** or **-no**) to specify whether the User ID can enter commands assigned to the specified command class.

**Range:**     *ayy*

Specify the parameter value in the format *ayy -no* or *ayy -yes*.

*ayy*—Configurable command class name of 1 alphabetic character followed by 2 alphanumeric characters

**-no**—Indicates that the command class is not allowed.

**-yes**—Indicates that the command class is allowed.

**:cc2=** (optional)

Configurable command class name (*ayy*), and an indicator (**-yes** or **-no**) to specify whether the User ID can enter commands assigned to the specified command class.

**Range:**     *ayy*

Specify the parameter value in the format *ayy -no* or *ayy -yes*.

*ayy*—Configurable command class name of 1 alphabetic character followed by 2 alphanumeric characters

**-no**—Indicates that the command class is not allowed.

**-yes**—Indicates that the command class is allowed.

**:cc3=** (optional)

Configurable command class name (*ayy*), and an indicator (**-yes** or **-no**) to specify whether the User ID can enter commands assigned to the specified command class.

**Range:**     *configcmdclassname, bool*

*configcmdclass—; value*

*bool—; value yes, no*

**:cc4=** (optional)

Configurable command class name (*ayy*), and an indicator (**-yes** or **-no**) to specify whether the User ID can enter commands assigned to the specified command class.

**Range:**     *ayy*

Specify the parameter value in the format *ayy -no* or *ayy -yes*.

*ayy*—Configurable command class name of 1 alphabetic character followed by 2 alphanumeric characters

**-no**—Indicates that the command class is not allowed.

**-yes**—Indicates that the command class is allowed.

**:cc5=** (optional)

Configurable command class name (*ayy*), and an indicator (**-yes** or **-no**) to specify whether the User ID can enter commands assigned to the specified command class.

**Range:**     *ayy*

Specify the parameter value in the format *ayy -no* or *ayy -yes*.

*ayy*—Configurable command class name of 1 alphabetic character followed by 2 alphanumeric characters

**-no**—Indicates that the command class is not allowed.

**-yes**—Indicates that the command class is allowed.

**:cc6=** (optional)

Configurable command class name (*ayy*), and an indicator (**-yes** or **-no**) to specify whether the User ID can enter commands assigned to the specified command class.

**Range:** *ayy*

Specify the parameter value in the format *ayy -no* or *ayy -yes*.

*ayy*—Configurable command class name of 1 alphabetic character followed by 2 alphanumeric characters

**-no**—Indicates that the command class is not allowed.

**-yes**—Indicates that the command class is allowed.

**:cc7=** (optional)

Configurable command class name (*ayy*), and an indicator (**-yes** or **-no**) to specify whether the User ID can enter commands assigned to the specified command class.

**Range:** *ayy*

Specify the parameter value in the format *ayy -no* or *ayy -yes*.

*ayy*—Configurable command class name of 1 alphabetic character followed by 2 alphanumeric characters

**-no**—Indicates that the command class is not allowed.

**-yes**—Indicates that the command class is allowed.

**:cc8=** (optional)

Configurable command class name (*ayy*), and an indicator (**-yes** or **-no**) to specify whether the User ID can enter commands assigned to the specified command class.

**Range:** *ayy*

Specify the parameter value in the format *ayy -no* or *ayy -yes*.

*ayy*—Configurable command class name of 1 alphabetic character followed by 2 alphanumeric characters

**-no**—Indicates that the command class is not allowed.

**-yes**—Indicates that the command class is allowed.

**:db=** (optional)

Access to all commands in command class Database Administration.

**Range:** **yes, no**

**Default:** **no**

**:dbg=** (optional)

Access to all commands in command class Debug.

**Range:** **yes, no**

**Default:** **no**

**:link=** (optional)

Access to all commands in command class Link Maintenance.

**Range:** **yes, no**

**Default:** **no**

**:page=** (optional)

The maximum age of the password, in days. The STP automatically prompts the user for a new password at login if the user's password is older than the value specified for the **page** parameter.

**Range:** **0-999** days

**Default:** The value specified for the **page** parameter on the **chg-secu-dflt** command

- :pu=** (optional)  
Access to all commands in command class Program Update.  
**Range:**     **yes, no**  
**Default:**    **no**
- :revoke=** (optional)  
Revoke the user ID. The system rejects login attempts for a revoked user ID.  
**Range:**     **yes, no**  
**Default:**    **no**
- :sa=** (optional)  
Access to all commands in command class Security Administration.  
**Range:**     **yes, no**  
**Default:**    **no**
- :sys=** (optional)  
Access to all commands in command class System Maintenance.  
**Range:**     **yes, no**  
**Default:**    **no**
- :uout=** (optional)  
User ID aging interval. The number of successive days a user ID can go unused (that is, no successful login) before the system denies login of that user ID.  
**Range:**     **0-999**  
**Default:**     The value specified for the **uout** parameter on the **chg-secu-dflt** command
- :lnpbas=** (obsolete)  
Access to all commands in the command class LNP Basic  
**Range:**     **yes, no**  
**Default:**    **no**

### Example

```
ent-user:uid=john:db=yes
ent-user:uid=john*mayer:db=yes
ent-user:uid=user123:cc5=u21-yes:cc8=u32-yes
```

### Dependencies

Passwords cannot be created or modified from a telnet terminal (terminal IDs 17-40) without the OA&M IP Security Enhancements feature turned on.

All new users are given access to the command class Basic as a default.

The LNP feature must be turned on (see the **enable-ctrl-feat** command) before the **lnpbas** parameter can be specified.

If the **all=yes** parameter is specified, and the LNP feature has not been turned on, then the **lnpbas** parameter value defaults to **no**.

The **revoke=yes** parameter cannot be specified for a user ID with system administration authorization.

The Command Class Management feature must be enabled before a configurable command class name can be specified in the **cc1-cc8** parameters.

The **cc1-cc8** parameter values must have valid default or provisioned configurable command class names. Default names are **u01-u32**.

**Notes**

To disable user ID aging, specify the **uout=0** parameter.

The *Database Administration Manual - System Management* provides a list of all commands allowed within each command class.

Up to 8 configurable command class name parameters can be specified in one command. Additional commands can be entered to assign user access for more than 8 names. To assign user access for all 32 available configurable command class names, four commands could be entered with 8 names specified in each command.

A password must be entered for the newly-created userID. The system issues a separate prompt for this password and disables character echo at the terminal so that the entered password is not displayed on the screen.

After the password has been entered, the system issues a second prompt, and the password must be entered again. This ensures that no typing mistakes were made on the first entry.

Use the following rules for creating passwords:

- A new password cannot contain more than 12 characters.
- A new password must contain at least the number of characters that is specified in the **minlen** parameter of the **chg-secu-dflt** command.
- A new password must contain at least the number of alphabetic (**alpha** parameter), numeric (**num** parameter), and punctuation (**punc** parameter) characters that is specified in the **chg-secu-dflt** command.
- A new password cannot contain the associated user ID.

**Output**

```
ent-user:uid=john*mayer:db=yes
rlghncxa03w 04-01-07 11:11:28 EST EAGLE 31.3.0
ENT-USER: MASP A - COMPLTD
;
```

**ent-vendid****Enter Vendor ID**

Use this command to enter elements into the Vendor ID list, for the GSM MAP SRI Redirect to Serving HLR (also called GSM MAP SRI Redirect) feature. Each entry is identified by the Vendor ID and the Vendor number.

The Vendor ID length (**vendidlen** parameter) must be entered first, before the command is entered the second time to enter the Vendor ID and Vendor Number.

**Keyword:** ent-vendid

**Related Commands:** dlt-vendid, rtrv-vendid

**Command Class:** Database Administration

**Parameters**

**:vendid=** (optional)  
Vendor ID  
**Range:** 1-15 digits

**:vendidlen=** (optional)

Vendor ID Length. All Vendor IDs defined for the GSM MAP SRI Redirect for Serving HLR feature must contain this number of digits.

**Range:**     **0-15**

**:vendnum=** (optional)

Vendor Number. The Vendor Number is used as a reference to the prefix for the GSM MAP SRI Redirect for Serving HLR feature.

**Range:**     **1-3**

**1**—Corresponds to the prefix defined with prefix number 1 (see the **chg-prefix** command).

**2**—Corresponds to the prefix defined with prefix number 2 (see the **chg-prefix** command).

**3**—Corresponds to the prefix defined with prefix number 3 (see the **chg-prefix** command).

**:vendtype=** (optional)

Vendor Type. The Vendor Type is used with the GSM MAP SRI Redirect for Serving HLR feature to allow multiple networks for the same equipment vendor.

**Range:**     **1-2**

### Example

```
ent-vendidvend:len=6
```

```
ent-vendid:vendid=886933:vendnum=1:vendtype=1
```

### Dependencies

The value **none** cannot be specified for the **vendid** parameter.

The GSM MAP SRI Redirect feature must be enabled before this command can be entered.

The VENDID table can contain a maximum of 200 entries.

The specified ID entry cannot already exist in the VENDID table.

All VENDID table entries must have the number of digits defined by the **vendidlen** parameter value.

The prefix with the same prefix number as the specified Vendor Number must already be provisioned for the GSM MAP SRI Redirect feature.

The Vendor ID length cannot be changed unless the VENDID table is empty. All Vendor IDs must be deleted from the table before a different Vendor ID length can be entered.

The Vendor ID length must be entered before any Vendor IDs can be defined.

The **vendidlen** parameter cannot be specified in the same command with the **vendid**, **vendidlen**, and **vendtype** parameters. Either the **vendidlen** parameter, or the **vendid**, **vendidlen**, and **vendtype** parameters can be specified in one command.

### Notes

None.

**Output**

The Vendor ID length must be entered first, before any Vendor IDs can be entered.

```
ent-vendid:vendidlen=6
  rlghncxa03w 04-10-07 11:11:28 EST  EAGLE 31.11.0
  ENT-VENDID: MASP A - COMPLTD
;

ent-vendid:venid=886933:vendnum=1:vendtype=1
  rlghncxa03w 04-10-07 11:11:28 EST  EAGLE 31.11.0
  VENDID table is (6 of 200) 3% full
  ENT-VENDID: MASP A - COMPLTD
;
```

**ent-vflx-cd****Enter VFLEX Call Decision Entry**

Use this command to provision the call decision criteria that is used to create a voice mail routing number. This command creates a new entry in the V-Flex Call Decision Table.

**NOTE: The V-Flex feature must be enabled before this command can be entered.**

**Keyword:** ent-vflx-cd

**Related Commands:** chg-vflx-cd, dlt-vflx-cd, rtrv-vflx-cd

**Command Class:** Database Administration

**Parameters**

**:bcap=** (mandatory)

This parameter specifies the INAP/CAP bearer capabilities for the call.

The INAP/CAP bearer capabilities are used to determine the type of mail that is used by the call, such as voice, video, multimedia, etc.

**Range:**     **0-31, none**  
                   **none**—BCAP is not present in the incoming MSU.

**:cdn=** (mandatory)

Call decision name. This parameter specifies an entry in the call decision table.

**Range:**     *ayyy*  
                   1 alphabetic character followed by 3 alphanumeric characters

**:dnstat=** (mandatory)

Dialed number status. This parameter specifies whether the MSISDN is found in the EPAP RTDB.

**Range:**     **fnd, nfnd, \***  
                   **fnd** — DN found in RTDB  
                   **nfnd** — DN not found in RTDB  
                   **\*** — It does not matter whether the DN is found in RTDB

**:rnidx=** (mandatory)

Routing number index. This parameter specifies the index associated with the generated voice mail routing number.

**Range:**     **0-9**

**:vmdig=** (mandatory)

Voice mail number or voice mail prefix digits. This parameter specifies a voice mail number or voice mail digits for the call decision entry.

If the call is redirected (the **rdi=redir** parameter is specified), then the value specified for the **vmdig** parameter represents a voice mail number. If the call is not redirected (the **rdi=dir** parameter is specified), then the value specified for the **vmdig** parameter represents a set of voice mail digits.



**Range:** 1-15 digits  
Valid digits are **0-9, A-F, a-f**.

**:rdi=** (optional)  
Redirection indicator. This parameter specifies whether the call is redirected.  
**Range:** **dir, redir**  
**dir** — call is not redirected  
**redir** — call is redirected  
**Default:** **dir**

### Example

```
ent-vflx-
cd:dnstat=fnd:rdi=redir:bcap=31:vmdig=abcdef123456abc:rnidx=0:cdn
=cdn1
```

### Dependencies

The V-Flex feature must be enabled before this command can be entered.

The value specified for the **cdn** parameter cannot be a reserved word, such as **none**.

The value specified for the **cdn** parameter cannot already exist in the Call Decision table.

An entry with the specified **dnstat**, **rdi**, **bcap** and **vmdig** parameters cannot already exist in the Call Decision table.

The value specified for the **vmdig** parameter cannot differ from a value that already exists in the Call Decision table by only the value of the **dnstat** parameter. The values specified for the **rdi** and **bcap** parameters must differ as well.

The maximum number of 25 entries cannot already be provisioned for a given **rdi**, **dnstat**, and **bcap**.

### Output

```
ent-vflx-
cd:dnstat=fnd:rdi=redir:bcap=31:vmdig=abcdef123456abc:rnidx=0:cdn
=cdn1
  rlgncxa03w 08-05-07 11:11:28 EST EAGLE 39.0.0
  ENT-VFLX-CD: MASP A - COMPLTD
;

ent-vflx-
cd:dnstat=nfnd:bcap=none:vmdig=dadbeefeed:rnidx=9:cdn=cdn2
  rlgncxa03w 08-05-07 11:11:28 EST EAGLE 39.0.0
  ENT-VFLX-CD: MASP A - COMPLTD
;
```

### ent-vflx-rn

### Enter VFLEX Routing Number

Use this command to associate a routing number name to a set of voice mail routing numbers. This command creates an entry in the Routing Number table.

**NOTE: The V-Flex feature must be enabled before this command can be entered.**

**Keyword:** **ent-vflx-rn**

**Related Commands:** **chg-vflx-rn, dlt-vflx-rn, rtrv-vflx-rn**

**Command Class:** Database Administration

**Parameters****:rn=** (mandatory)

Routing number. This parameter specifies the voice mail routing number.

**Range:** 1-15 digits  
Valid digits are **0-9, A-F, a-f**.**:rnname=** (mandatory)

Routing number name. This parameter specifies the name associated with the voice mail routing number.

**Range:** *ayyyyyyy*  
1 alphabetic character followed by 7 alphanumeric characters.**Example**

```
ent-vflx-rn:rnname=rn01:rn=123ABCD012
```

**Dependencies**

The V-Flex feature must be enabled before this command can be specified.

The Routing Number table cannot contain more than 10,000 entries.

The value specified for the **rnname** parameter cannot already exist in the database.The value specified for the **rn** parameter cannot already exist in the database.The value specified for the **rnname** parameter cannot be a reserved word, such as **none**.**Output**

```
ent-vflx-rn:rnname=rn01:rn=1234ABCD56
rlghncxa03w 08-05-07 11:11:28 EST EAGLE 39.0.0
ENT-VFLX-RN: MASP A - COMPLTD
;
```

**ent-vflx-vmsid****Enter VFLEX VMS ID Entry**

Use this command to provision a voice mail server ID and associate up to 10 routing number names with the ID. This command creates an entry in the VMSID table.

**NOTE: The V-Flex feature must be enabled before this command can be entered.****Keyword:** ent-vflx-vmsid**Related Commands:** chg-vflx-vmsid, dlt-vflx-vmsid, rtrv-vflx-vmsid**Command Class:** Database Administration**Parameters****:id=** (mandatory)

This parameter specifies the ID of the voice mail server.

**Range:** 1-15 digits, **dflt**  
Valid digits are **0-9, A-F, a-f**.**dflt**—a set of routing numbers that is used when a query is received with an invalid MSISDN or an MSISDN that is not found in the RTDB.**:idx0=** (optional)

Index 0. This parameter specifies the routing number name for index 0.

**Range:** *ayyyyyyy*  
1 alphabetic character followed by up to 7 alphanumeric characters

**:idx1=** (optional)

Index 1. This parameter specifies the routing number name for index 1.

**Range:** *ayyyyyyy*  
1 alphabetic character followed by up to 7 alphanumeric characters

**:idx2=** (optional)

Index 2. This parameter specifies the routing number name for index 2.

**Range:** *ayyyyyyy*  
1 alphabetic character followed by upto 7 alphanumeric characters

**:idx3=** (optional)

Index 3. This parameter specifies the routing number name for index 3.

**Range:** *ayyyyyyy*  
1 alphabetic character followed by up to 7 alphanumeric characters

**:idx4=** (optional)

Index 4. This parameter specifies the routing number name for index 4.

**Range:** *ayyyyyyy*  
1 alphabetic character followed by up to 7 alphanumeric characters

**:idx5=** (optional)

Index 5. This parameter specifies the routing number name for index 5.

**Range:** *ayyyyyyy*  
1 alphabetic character followed by up to 7 alphanumeric characters

**:idx6=** (optional)

Index 6. This parameter specifies the routing number name for index 6.

**Range:** *ayyyyyyy*  
1 alphabetic character followed by up to 7 alphanumeric characters

**:idx7=** (optional)

Index 7. This parameter specifies the routing number name for index 7.

**Range:** *ayyyyyyy*  
1 alphabetic character followed by up to 7 alphanumeric characters

**:idx8=** (optional)

Index 8. This parameter specifies the routing number name for index 8.

**Range:** *ayyyyyyy*  
1 alphabetic character followed by up to 7 alphanumeric characters

**:idx9=** (optional)

Index 9. This parameter specifies the routing number name for index 9.

**Range:** *ayyyyyyy*  
1 alphabetic character followed by up to 7 alphanumeric characters

**Example**

The following command provisions a VMS ID and associates a routing number name with index 0.

```
ent-vflx-vmsid:id=123456abcdef123:idx0=RN45
```

The following command provisions a VMS ID and associates routing number names with index 0 and index 5.

```
ent-vflx-vmsid:id=DADBEEFEED:idx0=rn15:idx5=rn30
```

**Dependencies**

The V-Flex feature must be enabled before this command can be entered.

The values specified for the **idx\*** parameters must already exist in the Routing Number table.

The value specified for the **id** parameter cannot already exist in the VMSID table.

The **idx\*=none** parameter cannot be specified.

The VMSID table contains a maximum of 1000 entries.

The value specified for the **rname** parameter must already exist in the Routing Number table.

## Output

```
ent-vflx-vmsid:id=123456abcdef123:idx0=rn45
rlghncxa03w 08-05-07 11:11:28 EST EAGLE 39.0.0
ENT-VFLX-VMSID: MASP A - COMPLTD
;

ent-vflx-vmsid:id=DADBEEFEED:idx0=rn15:idx5=rn30
rlghncxa03w 08-05-07 11:11:28 EST EAGLE 39.0.0
ENT-VFLX-VMSID: MASP A - COMPLTD
;
```

## ent-x25-dstn

## Enter X.25 Destination

Use this command to associate an X.25 network address with an existing SS7 point code in the routing table, and optionally, a subsystem within that point code. If the node is actually in the X.25 domain, the X.25 address is a real network address and the point code is a dummy point code. If the node is in the SS7 domain, the point code is a real SS7 point code and the X.25 address is a dummy address.

**NOTE: This command is obsolete.**

**Keyword:** ent-x25-dstn

**Related Commands:** chg-x25-dstn, dlt-x25-dstn, rtrv-x25-dstn

**Command Class:** Database Administration

## Parameters

**:dpc=** (mandatory)

This parameter is the real SS7 point code assigned to a real SS7 node or the dummy point code for an X.25 destination entity. The value for this parameter is a point code with subfields network indicator-network cluster-network cluster member (*ni-nc-ncm*).

**Synonym:** dpca

**Range:** 000-255

Specify a valid value for each subfield of the point code, and separate the subfields with a dash (-).

When **chg-sid:pctype=ansi** is specified, *ni* = 000 is not valid.

When **chg-sid:pctype=ansi** is specified, *nc* = 000 is not valid if *ni* = 001-005.

When **chg-sid:pctype=ansi** is specified, *nc* = 000 is valid if *ni* = 006-255.

The point code 000-000-000 is not a valid point code.

**:xaddr=** (mandatory)

The X.25 network address of the X.25 destination entity or the SS7 node.

**Range:** 1-15 digits

**:ssn=** (optional)

The subsystem number of the destination that is assigned to the X.25 address or the SS7 address.

**Range:** 1-255

**Default:** 5

**Example**

```
ent-x25-dstn:xaddr=220525586456772:dpc=133-013-001:ssn=123
ent-x25-dstn:xaddr=255864567:dpc=033-001-013
```

**Dependencies**

Each X.25 address must have at least four digits.

The DPC must exist in the destination table.

The X.25 SS7 ANSI destination point code must be a full point code (*ni-nc-ncm*).

The X.25 address cannot exist in X.25 destination table.

The maximum number of X.25 destinations is 1024.

**Notes**

None

**Output**

```
ent-x25-dstn:xaddr=220525586456772:dpc=133-013-001:ssn=123
rlghncxa03w 04-02-10 11:43:04 EST EAGLE 31.3.0
X.25 DSTN TABLE 45 % FULL
ENT-X25-DSTN: MASP A - COMPLTD
;
```

**ent-x25-rte****Enter X.25 Route**

Use this command to define the routing parameters needed by the gateway portion of the LIMs with the LIMs with the **ss7gx25** application for establishing a virtual circuit that is permanently maintained by the system STP.

**NOTE: This command is obsolete.**

**Keyword:** ent-x25-rte

**Related Commands:** chg-x25-rte, dlt-x25-rte, rtrv-x25-rte

**Command Class:** Database Administration

**Parameters**

**:saddr=** (mandatory)

The alias X.25 address assigned to the SS7 destination entity on the SS7 side of the circuit.

**Range:** 1-15 digits

**:type=** (mandatory)

The type of X.25 connection that the link is expected to maintain.

**Range:** pvc, svca, svcr

**pvc** — —Permanent virtual circuit

**svca** — automatic virtual circuit

**svcr** — remote virtual circuit

**:xaddr=** (mandatory)

The X.25 address assigned to the X.25 destination entity on the X.25 side of the circuit.

**Range:** 1-15 digits

**:lc=** (optional)

The number of the logical channel on the X.25 signaling link to which the PVC connection is assigned.

This parameter is mandatory if the **type=pvc** parameter is specified. If the **type=svca** or

**type=svcr** parameters are specified, the logical channel number is arbitrary and cannot be specified.

**Range:** 1-255  
**Default:** The logical channel is not given.

**:lc2nm=** (optional)

Invokes SS7 MTP network management for failures and recoveries of logical channels.

**Range:** yes, no  
**Default:** yes—if **rt=xpc** is specified  
no—if **rt=pc** is specified  
no—if **rt** is not specified

**:loc=** (optional)

The card location containing the X.25 signaling link that will maintain the connection. For an automatic virtual circuit, this link is the link on which the system STP initially attempts the connection. However, if this attempt fails, the connection may be established by the X.25 destination entity on any other link in this link's linkset.

**Range:** 1101-1108, 1111-1112, 1201-1208, 1211-1218, 1301-1308, 1311-1318, 2101-2108, 2111-2118, 2201-2208, 2211-2218, 2301-2308, 2311-2318, 3101-3108, 3111-3118, 3201-3208, 3211-3218, 3301-3308, 3311-3318, 4101-4108, 4111-4118, 4201-4208, 4211-4218, 4301-4308, 4311-4318, 5101-5108, 5111-5118, 5201-5208, 5211-5218, 5301-5308, 5311-5318, 6101-6108, 6111-6118

**Default:** The card location is not given

**:port=** (optional)

The port on the card containing the X.25 signaling link.

**Range:** a  
**Default:** The port is not given

**:rt=** (optional)

The type of routing to perform for messages originating in the SS7 domain and destined for the X.25 domain. Two types of routing are available: (1) Route on X.25 destination point code (XPC) and (2) Route using X.25 origination and destination point code combinations (PC).

**Range:** xpc, pc  
**Default:** pc

### Example

```
ent-x25-
rte:xaddr=225255:saddr=133131:type=pvc:loc=1201:port=a:lc=3
ent-x25-rte:xaddr=225255:saddr=133132:type=svca:loc=1201:port=a
ent-x25-rte:xaddr=225255:saddr=133132:type=svcr
ent-x25-rte:xaddr=225255:saddr=133132:type=svcr:rt=xpc:lc2nm=yes
```

### Dependencies

Each X.25 address must have at least four digits.

The **limds0**, **limdscs**, **limocu** and **limv35** card types are the only valid card types for this command. These card types must be running the **ss7gx25** GPL type.

The shelf and card must be equipped.

The logical channel number cannot be specified if the connection type is an automatic virtual circuit or a remote virtual circuit (**type=svca** or **type=svcr**).

The logical channel number must be specified if the connection type is PVC (**type=pvc**).

If **lc2nm=yes** is specified, **rt=xpc** must be specified.

If the X.25 domain destination is an adjacent entity, **lc2nm=no** must be specified.

The **loc** and **port** parameters cannot be specified if the connection type is a remote switched virtual circuit (**type=svcr**). The far end initiates a remote switched virtual circuit and sends the system the location and port information.

The card location (**loc**) must be specified if the connection type is a permanent virtual circuit or an automatic virtual circuit (**type=pvc** or **type=svca**).

Each X.25 address must exist in X.25 destination table.

The X.25 address must be assigned to a destination in the X.25 domain.

The SS7 address must be assigned to a destination in the SS7 domain.

The combination of the two X.25 addresses must be unique in the X.25 route table.

The combination of point code/SSNs assigned to the two X.25 addresses must be unique in the X.25 route table.

The maximum number of X.25 routes in a system is 1024.

The point codes assigned to each of the X.25 destinations must also be assigned to routes.

The signaling link must be assigned to a LIM with the **ss7gx25** application.

The signaling link assigned to the X.25 route must be in the database and must be assigned to a linkset. The linkset must be assigned to a route associated with an X.25 destination and must contain an APC in the X.25 domain. This can be verified by entering the following commands:

- **rtrv-slk**—Displays the signaling links
- **rtrv-ls**—Displays the linksets
- **rtrv-rte**—Displays the routes
- **rtrv-x25-dstn**—Displays the X.25 destinations
- **rtrv-dstn**—Displays the destination point codes.

The logical channel number cannot be greater than the maximum number of permanent virtual circuits allowed for the signaling link. For example, if the total number of permanent virtual circuits allowed for the signaling link is 15, the logical channel number for this signaling link cannot be greater than 15.

The logical channel of the signaling link cannot already be assigned to an X.25 route.

The number of permanent virtual circuits cannot exceed the maximum number of permanent virtual circuits defined for the signaling link.

The number of automatic virtual circuits cannot exceed the maximum number of switched virtual circuits defined for the signaling link.

If **rt=xpc** is specified, the **xaddr** parameter's alias SS7 point code must be unique in the X.25 route table.

## Notes

The connection can be one of three types, a permanent virtual circuit, an automatic virtual circuit, or a remote virtual circuit.

Permanent virtual circuits are permanent X.25 virtual connections between two signaling points established on one of the logical channels of an X.25 signaling link. This connection is setup by the network, therefore no setup is required by the system to establish a permanent virtual circuit connection.

Automatic virtual circuits are essentially the same as permanent virtual circuits, except that the connection must be established by either the system or the X.25 destination entity.

Remote virtual circuits are also essentially the same as automatic virtual circuits, except that the connection can be established only by the X.25 destination entity.

All LIMs with the **ss7gx25** application share this information. Even though these connections apply to only one card, they are used by all cards.

### Output

```
ent-x25-
rte:xaddr=225255:saddr=133131:type=pvc:loc=1201:port=a:lc=3
  rlghncxa03w 04-02-10 11:43:04 EST EAGLE 31.3.0
  ENT-X25-RTE: MASP A - X.25 Route table 45% full
  ENT-X25-RTE: MASP A - COMPLTD
;
```

## flash-card

## Flash-Card

Use this command to load all flash images (GPL) supported by a specified card. This command performs the same functions as the **init-flash** and the **act-flash** commands.

**Keyword:** flash-card

**Related Commands:** act-flash, init-flash

**Command Class:** System Maintenance

### Parameters

**:code=** (mandatory)

The GPL type to be loaded.

**Range:** **appr**, **trial**  
**appr** — Approved GPL  
**trial** — Trial GPL

**:loc=** (mandatory)

Card address. The location of the card as stenciled on the shelf of the system.

**Range:** **1101-1108, 1111-1113, 1115, 1201-1208, 1211-1218, 1301-1308, 1311-1318, 2101-2108, 2111-2118, 2201-2208, 2211-2218, 2301-2308, 2311-2318, 3101-3108, 3111-3118, 3201-3208, 3211-3218, 3301-3308, 3311-3318, 4101-4108, 4111-4118, 4201-4208, 4211-4218, 4301-4308, 4311-4318, 5101-5108, 5111-5118, 5201-5208, 5211-5218, 5301-5308, 5311-5318, 6101-6108, 6111-6118**

**:force=** (optional)

This parameter is used to force the command to work on an IS-NR card. Links provisioned on the card are inhibited during command execution. The card and inhibited links are restored to their previous state when the command is completed.

**Range:** **yes**, **no**  
**Default:** **no**

### Example

```
flash-card:loc=1105:code=trial
flash-card:loc=1105:code=appr:force=yes
```

### Dependencies

Cards do not have to be provisioned to use the **flash-card** command. However, if the specified card is provisioned and not inhibited, use of the **force** parameter is required.

The specified card locations must be running a flashable software image.



This command cannot be used to load flash images for HMUX or HIPR cards. Use the **init-flash** command.

If the even-numbered TDM (1114,1116) is specified, the flash occurs on the odd-numbered GPSM-II running OAM (1113,1115).

The specified card location cannot be the active MASP (either the active GPSM-II or the active TDM).

No other action command can be in progress when this command is entered.

The card specified in the location parameter must be present and able to communicate over the IMT. The card do not have to be provisioned in the database.

If the card is already running the specified code load, it cannot be loaded by this command.

This command cannot be entered if an IMT Rate Change sequence is in progress.

### Notes

The specified card must be present and able to communicate over the IMT.

A card that is already running the specified code load cannot be reflashed using the **force** parameter. The **act-flash** and **init-flash** commands must then be used to reload the same code level.

## Output

```
flash-card:loc=1105:code=appr:force=yes
tekelecstp 08-05-11 01:52:11 EST EAGLE5 39.0.0
Flash Card: Downloading BLBIOS on card 1105.
;
tekelecstp 08-05-11 01:52:11 EST EAGLE5 39.0.0
Flash Card: Card 1105 download BLBIOS complete.
;
tekelecstp 08-05-11 01:52:11 EST EAGLE5 39.0.0
Flash Card: Downloading BLDIAG6 on card 1105.
;
tekelecstp 08-05-11 01:52:11 EST EAGLE5 39.0.0
Flash Card: Card 1105 download BLDIAG6 complete.
;
tekelecstp 08-05-11 01:52:11 EST EAGLE5 39.0.0
Flash Card: Downloading PLDE1T1 on card 1105.
;
tekelecstp 08-05-11 01:52:11 EST EAGLE5 39.0.0
Flash Card: Card 1105 download PLDE1T1 complete.
;
tekelecstp 08-05-11 01:52:11 EST EAGLE5 39.0.0
Flash Card: Downloading IMTPCI on card 1105.
;
tekelecstp 08-05-11 01:52:11 EST EAGLE5 39.0.0
Flash Card: Card 1105 download IMTPCI complete.
;
tekelecstp 08-05-11 01:52:11 EST EAGLE5 39.0.0
Flash Card: Downloading BLVXW6 on card 1105.
;
tekelecstp 08-05-11 01:52:11 EST EAGLE5 39.0.0
Flash Card: Card 1105 download BLVXW6 complete.
;
tekelecstp 08-05-11 01:52:11 EST EAGLE5 39.0.0
Flash Card: Downloading PLDPMC1 on card 1105.
;
tekelecstp 08-05-11 01:52:11 EST EAGLE5 39.0.0
Flash Card: Card 1105 download PLDPMC1 complete.
;
tekelecstp 08-05-11 01:52:11 EST EAGLE5 39.0.0
Flash Card: Activating BLBIOS on card 1105.
;
tekelecstp 08-05-11 01:52:11 EST EAGLE5 39.0.0
Flash Card: Card 1105 activation BLBIOS complete.
;
tekelecstp 08-05-11 01:52:11 EST EAGLE5 39.0.0
Flash Card: Activating BLDIAG6 on card 1105.
;
tekelecstp 08-05-11 01:52:11 EST EAGLE5 39.0.0
Flash Card: Card 1105 activation BLDIAG6 complete.
;
tekelecstp 08-05-11 01:52:11 EST EAGLE5 39.0.0
Flash Card: Activating PLDE1T1 on card 1105.
;
tekelecstp 08-05-11 01:52:11 EST EAGLE5 39.0.0
Flash Card: Card 1105 activation PLDE1T1 complete.
;
tekelecstp 08-05-11 01:52:11 EST EAGLE5 39.0.0
Flash Card: Activating IMTPCI on card 1105.
;
tekelecstp 08-05-11 01:52:11 EST EAGLE5 39.0.0
Flash Card: Card 1105 activation IMTPCI complete.
;
tekelecstp 08-05-11 01:52:11 EST EAGLE5 39.0.0
Flash Card: Activating BLVXW6 on card 1105.
```

## Commands

## format-disk

```
;
tekelecstp 08-05-11 01:52:11 EST EAGLE5 39.0.0
Flash Card: Card 1105 activation BLVXW6 complete.
;
tekelecstp 08-05-11 01:52:11 EST EAGLE5 39.0.0
Flash Card: Activating PLDPMC1 on card 1105.
;
tekelecstp 08-05-11 01:52:11 EST EAGLE5 39.0.0
Flash Card: Card 1105 activation PLDPMC1 complete.
;
tekelecstp 08-05-11 01:52:11 EST EAGLE5 39.0.0
Flash Card: Downloading BLCPLD on card 1105.
;
tekelecstp 08-05-11 01:52:11 EST EAGLE5 39.0.0
Flash Card: Card 1105 download BLCPLD complete.
;
tekelecstp 08-05-11 01:52:11 EST EAGLE5 39.0.0
Flash Card: Activating BLCPLD on card 1105.
;
tekelecstp 08-05-11 01:52:11 EST EAGLE5 39.0.0
Flash Card: Card 1105 activation BLCPLD complete.
;
tekelecstp 08-05-11 01:52:11 EST EAGLE5 39.0.0
Command Completed.
;
tekelecstp 08-05-11 01:52:11 EST EAGLE5 39.0.0
Flash Card: Canceling links on card 1105.
;
tekelecstp 08-05-11 01:52:11 EST EAGLE5 39.0.0
Flash Card: Inhibiting card 1105.
;
tekelecstp 08-05-11 01:52:11 EST EAGLE5 39.0.0
Flash Card: Downloading BPMPPL on card 1105.
;
tekelecstp 08-05-11 01:52:11 EST EAGLE5 39.0.0
Flash Card: Card 1105 download BPMPPL complete.
;
tekelecstp 08-05-11 01:52:11 EST EAGLE5 39.0.0
Flash Card: Allowing card 1105.
;
tekelecstp 08-05-11 01:52:11 EST EAGLE5 39.0.0
Flash Card: Activating BPMPPL on card 1105.
;
tekelecstp 08-05-11 01:52:11 EST EAGLE5 39.0.0
Flash Card: Card 1105 activation BPMPPL complete.
;
tekelecstp 08-05-11 01:52:11 EST EAGLE5 39.0.0
Flash Card: Activating links on card 1105.
;
tekelecstp 08-05-11 01:52:11 EST EAGLE5 39.0.0
Command Completed.
;
```

## format-disk

## Format Disk

Use this command to format and initialize a removable cartridge, removable drive, or standby Terminal Disk Module (TDM).

**NOTE:** The `format-disk` command leaves the disk unusable until the `chg-db` and `copy-gpl` commands are entered.

**Keyword:** `format-disk`

**Related Commands:** `chg-db`, `copy-disk`, `copy-gpl`, `copy-meas`, `disp-disk-dir`, `rept-stat-db`, `rtrv-gpl`

**Command Class:** System Maintenance

### Parameters

**:type=** (mandatory)

This parameter specifies the type of fixed drive, removable drive, or removable cartridge to format.

**Range:** **fixed, meas, system, usb**

**fixed** — The standby fixed disk on the standby TDM

**meas** — The measurement cartridge

**system** — The removable system cartridge or drive

**usb** — Argument to be used by Tekelec personnel only.

**:force=** (optional)

This parameter provides some protection against data loss due to reformatting a used system removable cartridge.

**Range:** **yes, no**

**Default:** **no**

**:loc=** (optional)

This parameter specifies the location of the disk that is being formatted.

**Range:** **1114, 1116, 1117, 1113, 1115**

**1114** — The TDM

**1116** — The TDM

**1117** — The removable cartridge drive

**1113** — The latched USB port

**1115** — The latched USB port

**:low=** (optional)

This parameter provides control over whether a low-level format will be performed on the target disk. Specifying **low=no** can be used to decrease formatting time.

**Range:** **yes, no**

**Default:** **yes**

**:prtnggrp=** (optional)

Partition group. This parameter indicates which disk partition group is to be formatted. Specifying the inactive group is relevant only when **type=fixed** is specified.



CAUTION

**CAUTION:** Do not enter the `format-disk:prtnggrp=inactive` command unless directed to by Tekelec Technical Services to avoid possible loss of a previously archived software release.

**Range:** **active, inactive**

**Default:** **active**

### Example

```
format-disk:type=system
```

```
format-disk:type=meas:force=yes
```

## Dependencies

The EOAM GPL version that is running in the active OAM card location must be the same GPL version that is running in the standby OAM card location.

To format a cartridge that already contains system data, the **force=yes** parameter must be specified.

The **force=yes** parameter must be specified if the cartridge to be formatted is recognized as a system removable cartridge. This parameter is optional if the cartridge is not recognized as a system removable cartridge. Only cartridges that have a **dms.cfg** file are recognized as system removable cartridges. A removable cartridge must be inserted and made ready before the **type=meas** or **type=system** parameter can be specified in the command.

Measurements collection must be inhibited during execution of the **format-disk** command. If measurements are not inhibited, **format-disk** cannot be executed.

- Do not enter the **chg-measopts:collect=on** command while the **format-disk** command is in progress. This results in read and write errors, because the standby disk is not accessible.
- Do not enter **format-disk** until the 30 minute measurements processing or the midnight measurements processing has completed, because inhibiting measurements during these periods results in the loss of measurement data for the period being processed.

OAM Measurements collection cannot be in progress when this command is entered. Retry the command after a period of waiting for the measurements collection to complete.

If the **force=yes** parameter is specified, the disk should not require low-level formatting, and the **format=no** parameter should be specified.

The card with the standby OAM must be available when this command is entered.

The standby fixed disk contains security log entries that have not yet been uploaded. Upload the log entries before formatting the disk to avoid loss of log data.

The **type=fixed** parameter must be specified before the **prtnggrp** parameter can be specified. If the **prtnggrp** parameter is specified, then the **low=no** parameter must be specified.

A value of **1114** or **1116** must be specified for the **loc** parameter, before the **type=fixed** parameter can be specified.

## Notes

The **low=no** parameter should be specified when upgrading a spare TDM. The **low=yes** parameter should be specified when there is a suspected hardware problem.

When the **type=meas** parameter is specified, a measurements removable cartridge or removable drive is built.

When the **type=system** parameter is specified, a system removable cartridge, removable drive, or credit card drive is built.

A system removable cartridge or drive can contain only GPLs and the database, not measurement data. After formatting, the cartridge or drive does not contain any data, but can be used as the destination disk of the **copy-gpl** and **chg-db:action=backup:dest=remove** commands. The **copy-gpl** command copies all approved GPLs from the fixed disk on the active TDM to the system removable cartridge or drive, providing a backup copy of the approved GPLs. The **chg-db:action=backup:dest=remove** command copies the database from the current partition of the fixed disk on the active TDM to a system removable cartridge or drive, providing a backup copy of the database.

A measurements removable cartridge or drive can contain only measurement data, not database information and GPLs. After formatting, the cartridge or drive does not contain any data, but can be used as the destination disk of the **copy-meas** command. The **copy-meas** command copies all

measurement data from the fixed disk on the active TDM to a measurements removable cartridge or drive for offline processing of the measurement data.

The database audit and GPL audit facilities are automatically disabled during execution of this command. When this command has completed (successful or not), the database and GPL audit facilities are automatically re-enabled.

All commands that affect the database are disallowed for the duration of the command. Attempts to use such commands are rejected, and an error message is displayed explaining that the command has been rejected.

During the upgrade process, files made obsolete by the upgrade process are deleted, freeing up disk space.

The format of magneto-optical removable cartridges allows the cartridges to be used in DOS/Windows environments in addition to being used on the system.

If the **format-disk** command is initiated and the standby OAM initialization is not complete, command processing is delayed. If standby initialization fails, the command proceeds to allow the standby TDM to recover from a previous **format-disk** or **copy-disk** failure. In such cases, the following messages appear:

```
Standby MASP has not finished initializing - please wait...
Standby MASP initialization timed out - continuing...
```

The **dms.cfg** file on either the active TDM or a system formatted removable cartridge is used by the **format-disk** command when formatting the target disk. The location of the **dms.cfg** file cannot be specified by the **format-disk** command. The value of the **type** parameter is used to determine the target disk to format and the location of the **dms.cfg** file on which to base the format. Table 5-62 shows the location of the **dms.cfg** file based on the value of the **type** parameter for the **format-disk** command.

**Table 5-62. DMS.CFG File Location for format-disk Command**

| <b>Value of the type Parameter</b> | <b>Target Disk (Card Location)</b>                               | <b>Location of the DMS.CFG File</b>                              |
|------------------------------------|------------------------------------------------------------------|------------------------------------------------------------------|
| <b>fixed</b>                       | Standby TDM (1114 or 1116)                                       | Removable Cartridge Drive (1117) Latched USB Port (1113 or 1115) |
| <b>system</b>                      | Removable Cartridge Drive (1117) Latched USB Port (1113 or 1115) | Active TDM (1114 or 1116)                                        |
| <b>meas</b>                        | Removable Cartridge Drive (1117) Latched USB Port (1113 or 1115) | Active TDM (1114 or 1116)                                        |

The **format-disk** command can create a maximum disk partition size of 2047 Mbytes, based on a 16-bit cluster size. A cluster is composed of 64 512-Kilobyte sectors. The physical capacity of the disk being formatted determines the formatted size of the disk and the number of partitions created on the disk.

Table 5-63 shows the format capacities of each type of disk used on the system and the number of partitions created on each disk.

**Table 5-63.** Disk Format Capacity

| <b>Target Disk Type</b>                                                                                                                                                                                                                                                                                                                                                                                                                                     | <b>Disk Location</b> | <b>Target Capacity</b> | <b>Number of Partitions</b> | <b>Formatted Size of the Partition</b> |
|-------------------------------------------------------------------------------------------------------------------------------------------------------------------------------------------------------------------------------------------------------------------------------------------------------------------------------------------------------------------------------------------------------------------------------------------------------------|----------------------|------------------------|-----------------------------|----------------------------------------|
| Magneto-Optical Removable Cartridge                                                                                                                                                                                                                                                                                                                                                                                                                         | 1117                 | 1096 Mbytes*           | 1                           | 1024 Mbytes                            |
| Latched USB Port                                                                                                                                                                                                                                                                                                                                                                                                                                            | 1113 or 1115         | 2 Gigabytes            | 1                           | 1.9 GB                                 |
| TDM                                                                                                                                                                                                                                                                                                                                                                                                                                                         | 1114 or 1116         | 540 Mbytes             | 1                           | 507 Mbytes                             |
| TDM                                                                                                                                                                                                                                                                                                                                                                                                                                                         | 1114 or 1116         | 2 Gigabytes            | 1                           | 2014 Mbytes                            |
| TDM                                                                                                                                                                                                                                                                                                                                                                                                                                                         | 1114 or 1116         | 4 Gigabytes            | 2                           | 2047 Mbytes                            |
| <p>* The magneto-optical removable cartridge is a double-sided cartridge that contains 2.3 gigabytes of data. Only one side of the disk can be formatted and used when the cartridge is inserted into the removable cartridge drive. The target capacity given for the magneto-optical removable cartridge is for one side of the disk in the cartridge and is approximately one half of the total capacity of the magneto-optical removable cartridge.</p> |                      |                        |                             |                                        |

**Output****format-disk:type=system**

```

rlghncxa03w 04-01-07 00:57:31 EST  EAGLE 31.3.0
Format-disk of system removable cartridge started.

rlghncxa03w 04-01-07 00:57:31 EST  EAGLE 31.3.0
Format-disk (removable cartridge) format in progress.

rlghncxa03w 04-01-07 00:57:31 EST  EAGLE 31.3.0
Format-disk (removable cartridge) format in progress.

rlghncxa03w 04-01-07 00:57:31 EST  EAGLE 31.3.0
Format-disk (removable cartridge) format is complete.

rlghncxa03w 04-01-07 00:57:31 EST  EAGLE 31.3.0
Format-disk of system removable cartridge completed.
Measurements collection may be turned on now if desired.
;

```

**format-disk:type=fixed:low=no:force=yes**

```

rlghncxa03w 04-01-07 00:57:31 EST  EAGLE 31.3.0
Format-disk of standby fixed disk started.
Extended processing required, please wait.
;

rlghncxa03w 04-01-07 00:57:31 EST  EAGLE 31.3.0
Format-disk (fixed) format in progress.

rlghncxa03w 04-01-07 00:57:31 EST  EAGLE 31.3.0
Format-disk (fixed) format is complete.

rlghncxa03w 04-01-07 00:57:31 EST  EAGLE 31.3.0
Format-disk of standby fixed disk completed.
Measurements collection may be turned on now if desired.
;

```

**inh-alm****Inhibit Alarm Reporting**

Use this command to inhibit the reporting of alarms for the given device. Inhibited alarms will not generate unsolicited output or cause alarm indicators to be turned on. All **rept-stat-xxx** commands continue to display the alarm with an indication that the device has its alarms inhibited.

The frame alarm LEDs are off for the inhibited alarm. This command does not affect the alarm counts on the VT320 banner. The fourth box on the right of the VT320 Control Area indicates the number of devices in the system with inhibited alarms.

**Keyword:** inh-alm

**Related Commands:** rept-stat-alm, rept-stat-card, rept-stat-cdt, rept-stat-dlk, rept-stat-dstn, rept-stat-ls,, rept-stat-rte, rept-stat-rtx, rept-stat-seas, rept-stat-slk, rept-stat-sys, rept-stat-trbl, rept-stat-trm, rtrv-log, unhb-alm

**Command Class:** System Maintenance



**Parameters**

**NOTE: See "Point Code Formats and Conversion" for a detailed description of point code formats, rules for specification, and examples.**

**:dev=** (mandatory)

Device. This parameter specifies the device where the reporting of alarms is to be inhibited.

**Range:** **applsock, as, card, cdt, clock, dlk, e1port, ls, lsmsconn, route, seasx25, slk, t1port, trm, rtx, enet, rs**  
**applsock** — IP gateway application socket  
**as** — IP gateway application Application Server  
**card** — Cards in the database  
**cdt** — Customer defined troubles  
**clock** — System clock  
**dlk** — TCP/IP data links  
**e1port** — E1 port on E1/T1 MIM or HC MIM cards  
**ls** — Linksets  
**lsmsconn** — Communication link between the LSMS and the EMS  
**route** — Route  
**seasx25** — The SEAS X.25 links  
**slk** — Signaling links  
**t1port** — T1 port on E1/T1 MIM or HC MIM cards  
**trm** — Terminals  
**rtx** — Exception Route  
**enet** — Ethernet  
**rs** — Routesets

**:asname=** (optional)

Gateway Application Server name. When used with the **dev=as** parameter, this parameter can be used to inhibit alarms for the named Application Server.

**Range:** *ayyyyyyyyyyyyyyy*  
 Up to 15 alphanumeric characters; the first character must be a letter.

**:cic=** (optional)

Starting Circuit Identification Code. This parameter is used with the **ecic** parameter to define the CIC range that is used as an exception routing criterion for the specified exception route.

**Range:** **0-16383**

**:dpc=** (optional)

ANSI destination point code with subfields network indicator-network cluster-network cluster member (*ni-nc-ncm*). The *prefix* subfield indicates a private point code (*prefix-ni-nc-ncm*).

**Synonym:** **dpca**

**Range:** **p-, 000-255, \***

Specify a valid value for each subfield of the point code, and separate the subfields with a dash (-).

*prefix*—**p-**

The asterisk value (\*) is not valid for the *ni* subfield.

When **chg-sid:pctype=ansi** is specified, *ni* = **000** is not valid.

When **chg-sid:pctype=ansi** is specified, *nc* = **000** is not valid if *ni* = **001-005**.

When **chg-sid:pctype=ansi** is specified, *nc* = **000** is valid if *ni* = **006-255**.

The point code **000-000-000** is not a valid point code.

**:dpc/dpca/dpci/dpcn/dpcn24=** (optional)  
Destination Point Code

**:dpci=** (optional)

ITU international destination point code with subfields *zone-area-id*. The *prefix* subfield indicates a spare point code, private point code, or private and spare point code (*prefix-zone-area-id*).

**Range:** **s-, p-, ps-, 0-255**

Specify a valid value for each subfield of the point code, and separate the subfields with a dash (-).

*prefix*—**s-, p-, ps-**

*zone*—**0-7**

*area*—**000-255**

*id*—**0-7**

The point code **0-000-0** is not a valid point code.

**:dpcn=** (optional)

ITU national destination point code in the format of a 5-digit number (*nnnnn*); or 2, 3, or 4 numbers (members) separated by dashes (*m1-m2-m3-m4*) as defined by the **chg-stpopts:npcfnti** flexible point code option. A group code must be specified when the ITUDUPPC feature is turned on (*nnnnn-gc*, *m1-m2-m3-m4-gc*). The *prefix* subfield indicates a spare point code, private point code, or private and spare point code (*prefix-nnnnn*, *prefix-nnnnn-gc*, *prefix-m1-m2-m3-m4*, *prefix-m1-m2-m3-m4-gc*).

**Range:** **s-, p-, ps-, 0-16383, aa-zz**

Specify a valid value for each subfield of the point code, and separate the subfields with a dash (-).

*prefix*—**s-, p-, ps-**

*nnnnn*—**0-16383**

*gc*—**aa-zz**

*m1-m2-m3-m4*—**0-14** for each member; values must sum to 14

**:dpcn24=** (optional)

24-bit ITU national destination point code with subfields *main signaling area-sub signaling area-signaling point*. The *prefix* subfield indicates a private point code.

**Range:** **p-, 000-255**

Specify a valid value for each subfield of the point code, and separate the subfields with a dash (-).

*prefix*—**p-**

*msa*—**000-255**

*ssa*—**000-255**

*sp*—**000-255**

**:dur=** (optional)

Duration. The period for which the alarms are inhibited. If the **dur=temp** parameter is specified, the clearing of the event that caused an alarm also clears the alarm inhibit, and the alarms become uninhibited on the device.

**Range:** **perm, temp, timed**

**perm**— A permanent inhibition of an alarm.

**temp**— A temporary inhibition of an alarm.

**timed**— An inhibition of an alarm for a specified duration.

**Default:** **perm**

**:e1port=** (optional)

Port ID. The E1 port on the specified E1 card.

The **e1port** parameter is mandatory if the **dev=e1port** parameter is specified.

**Range:** 1-8

Ports 3 - 8 can be specified only for HC-MIM cards and E5-E1T1 cards.

**:ecic=** (optional)

Ending Circuit Identification Code. This parameter, together with the **cic** parameter, defines the CIC range that is used as exception routing criteria for the specified exception route.

**Range:** 0-16383

**:edate=** (optional)

Expiry date. The date on which a timed alarm inhibit expires, at the time specified in the **etime** parameter value.

The **edate** parameter is valid and required when the **dur=timed** parameter is specified.

**Range:** 101-991231

Specify the date in the format of *year*, followed by *month*, followed by *day* (*yymmdd*).

**:etime=** (optional)

Expiry time. The time at which a timed alarm inhibit expires, on the date specified in the **edate** parameter value.

The **etime** parameter is valid and required when the **dur=timed** parameter is specified.

**Range:** 0-2359

Specify the time in the format of *hour* followed by *minute* (*hhmm*).

**:force=** (optional)

Allows critical alarms to be inhibited on a device.

The **force** parameter is mandatory if the **lvl=crit** parameter is specified.

The **criticalminh** STP option must be turned on before the **force** parameter can be specified.

**Range:** yes, no

**Default:** no

**:id=** (optional)

Identification number of the customer-defined trouble (5 - 16). Customer-defined troubles 1 - 4 are generated critical alarms and cannot be specified as values for the **id** parameter.

**Range:** 5-16

**:ilsn=** (optional)

Incoming Link Set Name. This parameter contains the name of the originating linkset. The parameter value is used as part of the exception routing criteria for the specified exception route.

**Range:** ayyyyyyy

1 alphabetic character followed by up to 9 alphanumeric characters

**:link=** (optional)

Signaling link on the card specified in the **loc** parameter.

**Synonym:** port

**Range:** a, b, a1-a31, b1-b31

a, b—For **dev=dlk**, **dev=slk** for a two-port LIM

a1, a2, b1, b2—For **dev=ndclk/seasx25/lsmconn**

a, b, a1, b1, a2, b2, a3, b3—For **dev=slk** for a multi-port LIM

a, b, a1-a31, b1-b31—For **dev=slk** for an HC MIM

**:loc=** (optional)

The card location as stenciled on the shelf of the system.

**Range:** 1101-1113, 1115, 1201-1218, 1301-1318, 2101-2118, 2201-2218, 2301-2318, 3101-3118, 3201-3218, 3301-3318, 4101-4118, 4201-4218, 4301-4318, 5101-5118, 5201-5218, 5301-5318, 6101-6118

**:lsn=** (optional)

Linkset name. The name of the linkset for which the report information is to be displayed.

**Range:** ayyyyyyyy

1 alphabetic character followed by up to 9 alphanumeric characters.

**:lvl=** (optional)

The alarm severity level (critical, major, or minor).

**Range:** crit, majr, minr

**Default:** majr

**:opc=** (optional)

ANSI point code with subfields *network indicator-network cluster-network cluster member (ni-nc-ncm)*. The *prefix* subfield indicates a private point code (*prefix-ni-nc-ncm*).

**Synonym:** opca

**Range:** 000-255

Specify a valid value for each subfield of the point code, and separate the subfields with a dash (-).

When **chg-sid:pctype=ansi** is specified, *ni = 000* is not valid.

When **chg-sid:pctype=ansi** is specified, *nc = 000* is not valid if *ni = 001-005*.

When **chg-sid:pctype=ansi** is specified, *nc = 000* is valid if *ni = 006-255*.

The point code **000-000-000** is not a valid point code.

**:opc/opca/opci/opcn/open24=** (optional)

Origination point code.

**:opci=** (optional)

ITU international destination point code with subfields *zone-area-id*. The *prefix* subfield indicates a spare point code, private point code, or private and spare point code (*prefix-zone-area-id*).

**Range:** s-, p-, ps-, 0-255

Specify a valid value for each subfield of the point code, and separate the subfields with a dash (-).

*prefix—s-, p-, ps-*

*zone—0-7*

*area—000-255*

*id—0-7*

The point code **0-000-0** is not a valid point code.

**:open=** (optional)

ITU national destination point code in the format of a 5-digit number (*nnnnn*); or 2, 3, or 4 numbers (members) separated by dashes (*m1-m2-m3-m4*) as defined by the **chg-stpopts:npcfmti** flexible point code option. A group code must be specified when the ITUDUPPC feature is turned on (*nnnnn-gc, m1-m2-m3-m4-gc*). The *prefix* subfield indicates a spare point code, private point code, or private and spare point code (*prefix-nnnnn, prefix-nnnnn-gc, prefix-m1-m2-m3-m4, prefix-m1-m2-m3-m4-gc*).

**Range:** s-, p-, ps-, 0-16383, aa-zz

Specify a valid value for each subfield of the point code, and separate the subfields with a dash (-).

*prefix*—**s-, p-, ps-**  
*nnnnn*—**0-16383**  
*gc*—**aa-zz**  
*m1-m2-m3-m4*—**0-14** for each member; values must sum to 14

**:open24=** (optional)

24-bit ITU national destination point code with subfields *main signaling area-sub signaling area-signaling point (msa-ssa-sp)*. The *prefix* subfield indicates a private point code (*prefix-msa-ssa-sp*).

**Range:** **p-, 000-255**

Specify a valid value for each subfield of the point code, and separate the subfields with a dash (-).

*prefix*—**p-**  
*msa*—**000-255**  
*ssa*—**000-255**  
*sp*—**000-255**

**:si=** (optional)

Service Indicator. This parameter is used as the exception routing criterion for the specified exception route.

**Range:** **0-15**

**:sname=** (optional)

Gateway application socket. When used with the **dev=applsock** parameter, this parameter can be used to inhibit alarms for the named application socket.

**Range:** *aaaaaaaaaaaaaaaa*  
 1 to 15 alphanumeric characters.

**:t1port=** (optional)

Port ID. This parameter is mandatory if the **dev=t1port** parameter is specified.

**Range:** **1-8**  
 Ports **3 - 8** can be specified only for HC MIM cards.

**:trm=** (optional)

Terminal ID. This parameter specifies the ID number of the terminal whose characteristics are to be retrieved and displayed.

**Range:** **1-40**

### Example

```
inh-alm:dev=route:dpc=1-1-1:dur=perm:lvl=crit:force=yes
inh-alm:dev=rtx:dpc=1-101-1:opc=4-4-4
inh-
alm:dev=route:dpc=1-1-1:dur=timed:lvl=crit:edate=050515:etime=230
0:force=yes
inh-alm:dev=enet:loc=1201:port=a
inh-alm:dev=enet:loc=1101:port=a:dur=temp:lvl=minr
```

### Dependencies

This command is not allowed in upgrade mode.

Table 5-64 shows the valid parameter combinations for the **inh-alm** command. The **dur** and **lvl** parameters are valid with all **dev** parameter values.

Table 5-64. Parameter Combinations for the **inh-alm** command

| Value (:dev)                       | a | a | c | c | d | e | l | l | n | n | r | s | s | t | t | e | r |
|------------------------------------|---|---|---|---|---|---|---|---|---|---|---|---|---|---|---|---|---|
| Device Parameter                   | p | s | a | d | l | l | s | s | d | d | o | e | l | l | r | n | s |
|                                    | p | r | t | o | k | p | m | c | c | u | a | k | p | m | e | t |   |
|                                    | l | d | c | o | s | l | q | t | s | o | r | t |   |   |   |   |   |
|                                    | s |   | k | r | c | k | 3 | e | x | 2 |   |   |   |   |   |   |   |
|                                    | o |   |   | t | o |   |   |   | 5 |   |   |   |   |   |   |   |   |
|                                    | c |   |   |   | n |   |   |   |   |   |   |   |   |   |   |   |   |
|                                    | k |   |   |   | n |   |   |   |   |   |   |   |   |   |   |   |   |
| No Parameters                      |   |   |   | X |   |   |   |   |   | X |   |   |   |   |   |   |   |
| :asname                            | X |   |   |   |   |   |   |   |   |   |   |   |   |   |   |   |   |
| :dpc/dpca/dpci/dpcn/dpcn24         |   |   |   |   |   |   |   |   |   |   | X |   |   |   |   |   |   |
| :id                                |   |   | X |   |   |   |   |   |   |   |   |   |   |   |   |   |   |
| :loc                               |   | X |   |   | X | X |   |   |   |   |   | X | X |   | X |   |   |
| :lsn                               |   |   |   |   |   |   | X |   |   |   |   |   |   |   |   |   |   |
| :e1port=1-8                        |   |   |   |   |   | X |   |   |   |   |   |   |   |   |   |   |   |
| :link=a, b                         |   |   |   |   | X |   |   |   |   |   |   | X |   |   | X |   |   |
| :link=a, b, a1, a2, b1, b2, a3, a3 |   |   |   |   |   |   |   |   |   |   |   | X |   |   |   |   |   |
| :link=a1, a2, b1, b2               |   |   |   |   |   |   | X | X |   | X |   |   |   |   |   |   |   |
| :sname                             | X |   |   |   |   |   |   |   |   |   |   |   |   |   |   |   |   |
| :t1port=1-8                        |   |   |   |   |   |   |   |   |   |   |   |   |   | X |   |   |   |
| :trm                               |   |   |   |   |   |   |   |   |   |   |   |   |   |   |   | X |   |

No other action command can be in progress when this command is entered.

The linkset specified by the **lsn** parameter must be equipped in the database.

This command will not execute while the signaling link is running either a Link Fault Sectionalization test or a Loopback test. An AST of LFS or LPBK must be cleared before signaling link alarms can be inhibited.

This command cannot be used to permanently inhibit XLIST point codes.

Before critical alarms can be inhibited, the STP option **criticalminh** must be enabled. The **chg-stpopts:criticalminh=yes** command enables this option.

Alarms already inhibited for the specified device.

When the **lvl=crit** parameter is specified, the **force=yes** parameter must be specified.

When the **dev=card** parameter is specified, the **loc** parameter must be specified.

When the **dev=dlk** parameter is specified, the **loc** parameter must be specified.

When the **dev=slk** parameter is specified, the **loc** parameter and the **link** parameter must be specified.

When the **dev=e1port** parameter is specified, the **loc** parameter and the **e1port** parameter must be specified.

When the **dev=t1port** parameter is specified, the **loc** parameter and the **t1port** parameter must be specified.

When the **dev=ls** parameter is specified, the **lsn** parameter must be specified.

When the **dev=trm** parameter is specified, the **trm** parameter must be specified.

When the **dev=cdt** parameter is specified, the **id** parameter must be specified.

When the **dev=seasx25** parameter is specified, the **link** parameter must be specified.

When the **dev=lsmsconn** parameter is specified, the **link** parameter must be specified.

When the **dev=route** parameter is specified, a **dpc/dpca/dpci/dpcn/dpcn24** parameter must be specified.

When the **dev=applsock** parameter is specified, the **sname** parameter must be specified.

When the **dev=as** parameter is specified, the **asname** parameter must be specified.

If the **sname** parameter is specified, the socket name must exist in the IPAPSOCK table.

If a point code parameter is specified, the point code must exist in the Routing table.

If the **dev=slk** parameter or **dev=dlk** parameter is specified, the specified **link** must exist in the database.

The card location that is specified in the **loc** parameter must be equipped.

The specified device type must be supported by the card in the specified card location.

The Origin-Based MTP Routing feature must be on before the **dev=rtx** parameter can be specified.

Permanent alarm inhibit is not allowed on the cluster PC because either the cluster or a member PC of the cluster is already alarm inhibited.

When the **dur=timed** parameter is specified, the **edate** and **etime** parameters must be specified.

When a **dur** parameter value other than **timed** is specified, the **edate** and **etime** parameters cannot be specified.

The **edate** parameter value must be a date equal to or later than the current system date. If the current system date is specified, then the **etime** parameter value must be a time later than the current system time. If a date later than the current system date is specified, then the **etime** parameter value can be any valid time in the format *hhmm*.

The **inh-alm** command cannot be used to change the level of inhibition on a device.

If the **dev=enet** parameter is specified, then the **loc** parameter and the **port** parameter must be specified.

The card must be an IPLIMx or IPGWx card.

The value specified for the **port** parameter is out of range.

When the **dev=ndclk** parameter is specified, the **link** parameter must be specified.

The **link** parameter must be valid for the selected device type.

## Notes

If critical alarms are inhibited, all alarms (critical, major, and minor) are disabled. Likewise, if major alarms are inhibited, both major and minor alarms are disabled.

The **dur** parameter allows alarms to be inhibited on a temporary basis. If a device has its alarms temporarily disabled, the device's alarms are automatically enabled after the alarm clears.

In this command, only ITU-international and ITU national point codes support the spare point code subtype prefix (s-) and the private and spare point code subtype prefix (ps-). All of the point code types support the private (internal) point code subtype prefix (p-).

### Output

```

inh-alm:dev=route:dpc=1-1-1:dur=perm:lvl=crit
  rlghncxa03w 04-02-23 13:20:59 EST  EAGLE 31.3.0
  Alarms are permanently inhibited.
;
  rlghncxa03w 04-02-23 13:20:59 EST  EAGLE 31.3.0
  Command Completed.
;
inh-alm:dev=rtx:dpc=1-101-1:opc=4-4-4
  stdcfg2b 06-05-27 20:20:35 EST  EAGLE 35.0.0
  Alarms are permanently inhibited
  Command Completed.
;
inh-alm:dev=route:dpc=1-1-1:dur=timed:lvl=crit:edate=050515:etime=2300:force=yes
  tekelecstp 07-02-27 13:20:59 EST  EAGLE 35.6.0
  Alarms are timed inhibited.
;
  tekelecstp 07-02-27 13:20:59 EST  EAGLE 35.6.0
  Command Completed
;
inh-alm:dev=enet:loc=1201:port=a
  stdcfg2b 07-02-07 20:20:35 EST  EAGLE 35.6.0
  Alarms are permanently inhibited
  Command Completed.
;
inh-alm:dev=enet:loc=1101:port=a:dur=temp:lvl=minr
  stdcfg2b 07-02-07 20:20:35 EST  EAGLE 35.6.0
  Temporary alarm inhibit level less than alarm level on device
  Command Completed.
;

```

### inh-card

### Inhibit Card

Use this command to change the state of the card from in-service normal (IS-NR) to Out-of-Service Maintenance-Disabled (OOS-MT-DSBLD). A user can then test the card or physically remove it from the shelf.

**Keyword:** inh-card

**Related Commands:** alw-card, dlt-card, ent-card, init-card, rept-stat-card, rmv-card, rst-card, rtrv-card

**Command Class:** System Maintenance

### Parameters

**:loc=** (mandatory)

Card address. The card location as stenciled on the shelf of the system.

**Range:** 1101-1108, 1111-1112, 1201-1208, 1211-1218, 1301-1308, 1311-1318, 2101-2108, 2111-2118, 2201-2208, 2211-2218, 2301-2308, 2311-2318, 3101-3108, 3111-3118, 3201-3208, 3211-3218, 3301-3308, 3311-3318, 4101-4108, 4111-4118, 4201-4208, 4211-4218, 4301-4308, 4311-4318, 5101-5108, 5111-5118, 5201-5208, 5211-5218, 5301-5308, 5311-5318, 6101-6108, 6111-6118



**:force=** (optional)

Force indicator. This parameter is required for the following conditions:

- The specified card is the last card supporting a linkset, SCCP subsystem, MPS-to-DSM connection, E1, T1, Measurements Platform subsystem, or GLS
- The TDM contains a security log with un-uploaded entries or any other TDM process in progress
- The specified HC MIM card or E5-E1T1 card is in channel bridging mode
- The specified card has the last in-service SEAS terminal configured.

**Range:**     **yes, no**

**Default:**   **no**

### Example

```
inh-card:loc=1101
```

```
inh-card:loc=1201:force=yes
```

### Dependencies

No other action commands can be in progress when this command is entered.

The card must be a TSM, DCM, Service Module, GPSM-II, E1/T1 MIM, HC MIM, E5-E1T1, or E5-ATM. The card location cannot be 1114, 1116, or 1117.

If the card is the only linkset, SCCP, Service Module, or GLS card remaining, the **force=yes** parameter must be specified in the command to inhibit the card.

If the card contains signaling or data links, all links must be out of service (OOS-MT-DSBLD) before the card can be inhibited.

If the card is type **lime1**, all signaling links providing timeslots serviced by the E1 interfaces assigned to the card must be deactivated, unless **force=yes** is specified.

If the card is type **limt1**, all signaling links providing timeslots serviced by the T1 interfaces assigned to the card must be deactivated, unless **force=yes** is specified.

The shelf and card must be equipped.

If the specified card is the only in-service MPS-DSM, the **force=yes** parameter must be specified.

If the specified card is the only in-service TSM, LIM, or MCPM, the **force=yes** parameter is required.

If the specified HC-MIM or E5-E1T1 card is in channel bridging mode, the **force=yes** parameter is required.

If inhibiting the Service Module card would cause less than 80% of the in-service normal (IS-NR) LIM cards to have VSCCP service (i.e., cause the system to enter an unstable loading mode), the **force=yes** parameter must be specified.

The card that is specified cannot be running the active OAM.

If the specified card has the last in-service SEAS Terminal configured, then the **force=yes** parameter must be specified to inhibit the card.

The card location (**loc**) must be within the allowed range.

The standby fixed disk cannot be initialized while un-uploaded security log entries exist.

The card cannot be inhibited as the terminals are still in use.

### Notes

The function of this command is the same as the **rmv-card** command.

When this command is entered, the card is initialized and enters the OOS-MT-DSBLD state. It has no affect if the card is already OOS-MT-DSBLD.



**CAUTION:** This command can be used to disable Measurements Platform measurements collection after the collection function has been enabled with the `chg-measopts:platformenable=on` command. To disable collection, ALL MPCM cards in the system must be inhibited. THIS CAN RESULT IN LOSING ALL PAST MEASUREMENT DATA ON THE CARDS. Use the `alw-card` command to enable measurements collection after the MPCM cards have been inhibited.

When an E5-IPSM Card is inhibited, the active SEAS terminals are set to the state OOS-MT/FLT.

### Output

```
inh-card:loc=1101
  rlghncxa03w 04-01-07 11:11:28 EST  EAGLE 31.3.0
  Card has been inhibited.
;
```

## inh-imt

### Inhibit IMT

The interprocessor message transport bus (IMT bus) is the main communications artery between all subsystems in the system. This command removes the IMT bus from service.



**CAUTION:** Use this command only when directed by the Tekelec Customer Care Center at (888) FOR-TKLC.

**Keyword:** `inh-imt`

**Related Commands:** `alw-imt`, `clr-imt-stats`, `conn-imt`, `disc-imt`, `rept-imt-lvl1`, `rept-imt-lvl2`, `rept-stat-imt`, `rmv-imt`, `rst-imt`

**Command Class:** System Maintenance

### Parameters

**:bus=** (mandatory)  
IMT bus to be inhibited  
**Range:** a, b

### Example

```
inh-imt:bus=a
```

### Dependencies

The alternate IMT bus must be in-service normal (IS-NR) in order for the specified bus to be inhibited.

This command cannot be entered during an IMT Fault Isolation Test.

This command cannot be entered if an IMT Rate Change sequence is in progress.

### Notes

Cards not connected to the other IMT bus will reinitialize.

All traffic is rerouted to the alternate IMT bus.

The function of this command is the same as the `rmv-imt` command.

**Output**

```

inh-imt:bus=a
rlghncxa03w 04-01-07 11:11:28 EST EAGLE 31.3.0
Inhibit IMT Bus A command issued

rlghncxa03w 04-01-07 13:12:41 EST EAGLE 31.3.0
3116.0098      IMT BUS A          IMT inhibited
;

```

**inh-map-ss****Inhibit Mated Application Subsystem**

Use this command to shut down (inhibit) a mated application subsystem. The command requires a parameter specifying the SSN to be inhibited. Currently, the LNP, INP, INPQS, Equipment Identity Register (EIR), Voice Mail Router (V-Flex), and ATI Number Portability Query (ATINPQ) subsystems can be inhibited. The specified subsystem attempts a coordinated shutdown. If the coordinated shutdown fails, a UIM is issued indicating the shutdown failed. If the **force** parameter is specified, the subsystem is forced to shut down, and a coordinated shutdown is not performed.

**Keyword:** inh-map-ss

**Related Commands:** alw-map-ss, rept-stat-lnp, rept-stat-sccp

**Command Class:** System Maintenance

**Parameters**

**:ssn=** (mandatory)

This parameter specifies the ATINPQ, EIR, INP, LNP, or V-Flex subsystem number.

**Range:** 2-255

**:force=** (optional)

This parameter forces the shutdown of the ATINPQ, EIR, INP, LNP, or V-Flex subsystem.

**Range:** yes, no

**Default:** no

**Example**

```

inh-map-ss:ssn=10
inh-map-ss:ssn=10:force=yes

```

**Dependencies**

The EIR, INP, LNP, or V-Flex feature must be turned on, or the ATINP feature must be enabled before this command can be entered.

No other action command can be in progress when this command is entered.

The specified **ssn** parameter value must represent the ATINPQ, EIR, INP, LNP, or V-Flex subsystem.

The EAGLE 5 ISS must be configured with at least one card running the **sccp** application.

**Notes**

If the LNPQS subsystem is disabled, any GTT requiring Message Relay is also disabled because they both use the same database. This causes the EAGLE 5 ISS to generate a TFP for the EAGLE 5 ISS CPCs. Traffic is then routed to the mate. If both Message Relay GTT and non Message Relay GTT use the same CPC, this could affect the GTT.

**Table 5-65.** Route Set Test When LNP is Offline

| Network Management | Concerned PC | Network Management     |
|--------------------|--------------|------------------------|
| RSP                | CPC          | TFA concerning CPC     |
| RSP                | LNP CPC      | None                   |
| RSP                | TPC          | TFA concerning TPC     |
| RSR                | CPC          | TFA concerning CPC     |
| RSR                | LNP CPC      | TFP concerning LNP CPC |
| RSR                | TPC          | TFA concerning TPC     |

Table 5-66 shows what actions EAGLE 5 ISS takes when LNP is offline and a message arrives requiring LNP. This table assumes that SCCP cards are available.

**Table 5-66.** Receiving Messages when LNP is Offline

| Routing Indicator in Incoming Message | DPC           | Result of GTT            | Message Handling | Network Management     |
|---------------------------------------|---------------|--------------------------|------------------|------------------------|
| rt-on-gt                              | Capability PC | rt-on-ssn, LNP subsystem | Reroute to mate  | TFP concerning CPC     |
| rt-on-gt                              | True PC       | rt-on-ssn, LNP subsystem | Reroute to mate  | None                   |
| rt-on-gt                              | Capability PC | Message Relay required   | Generate UDTS    | TFP concerning CPC     |
| rt-on-gt                              | True PC       | Message Relay required   | Generate UDTS    | None                   |
| rt-on-ssn                             | Capability PC | Not applicable           | Generate UDTS    | None                   |
| rt-on-ssn                             | True PC       | Not applicable           | Generate UDTS    | SSP concerning True PC |

## Output

### **inh-map-ss:ssn=30**

```
rlghncxa03w 04-02-24 10:37:22 EST EAGLE5 31.0.0
Inhibit map subsystem command sent to all SCCP cards.
Command Completed.
```

;

### **inh-map-ss:ssn=30:force=yes**

```
rlghncxa03w 04-02-24 10:37:22 EST EAGLE5 31.0.0
Inhibit map subsystem command sent to all SCCP cards.
Command Completed.
```

;

**inh-slk****Inhibit Signaling Link**

Use this command to prevent message signal units (MSU) from being transmitted on a specified, previously uninhibited signaling link.

**NOTE: The signaling link's inhibited status is not preserved across a LIM reboot.**

**Keyword:** inh-slk

**Related Commands:** act-slk, blk-slk, dact-slk, dlt-slk, ent-slk, rept-stat-slk, rtrv-slk, tst-slk, ublk-slk, unhb-slk

**Command Class:** Link Maintenance

**Parameters**

**:link=** (mandatory)

The signaling link on the card that is specified in the **loc** parameter. The links can be specified in any sequence or pattern.

**Synonym:** port

**Range:** a, b, a1-a31, b1-b31

Not all card types support all **link** parameter values.

See Table A-1 in Appendix A for valid **link** parameter range values for each type of card that can have a location specified in the **loc** parameter.

**:loc=** (mandatory)

The card location as stenciled on the shelf of the system.

**Range:** 1101-1108, 1111-1112, 1201-1208, 1211-1218, 1301-1308, 1311-1318, 2101-2108, 2111-2118, 2201-2208, 2211-2218, 2301-2308, 2311-2318, 3101-3108, 3111-3118, 3201-3208, 3211-3218, 3301-3308, 3311-3318, 4101-4108, 4111-4118, 4201-4208, 4211-4218, 4301-4308, 4311-4318, 5101-5108, 5111-5118, 5201-5208, 5211-5218, 5301-5308, 5311-5318, 6101-6108, 6111-6118

**Example**

```
inh-slk:loc=1307:link=b
```

**Dependencies**

A card location must be specified that is valid and defined in the database.

No other action command can be in progress when this command is entered.

The card must be equipped and must be one of the following cards:

- An E1 ATM card running the **atmitu** application
- An E1/T1 MIM, E5-E1T1, or HC MIM card running the **ss7ansi** or **ccs7itu** application
- An E5 ATM card running the **atmansi** or **atmitu** application
- An E5-ENET card running the **ipsg** application
- An E5-ENET card or SSEDCCM card running the **iplim** or **iplimi** application with links having **ipliml2=m2pa**
- A LIM card running the **ss7ansi**, **ss7gx25**, or **ccs7itu** application
- A LIM ATM card running the **atmansi** application

The card must contain signaling links.

The signaling link must be equipped in the database.

The following **link** parameter values can be specified for the following cards that support more than 2 links per card:

- **a1-a3, b1-b3**—Multi-port LIM (MPL, MPL-T), SSEDCCM card running the **iplim** or **iplimi** application with links having **ipliml2=m2pa**, E1/T1 MIM card
- **a1-a31, b1-b31**—HC-MIM card
- **a1-a15, b1-b15**—E5-E1T1 card
- **a1-a7, b1-b7**—E5-ENET card running the **iplim** or **iplimi** application that supports 16 links.
- **a1-a15, b1-b15**—E5-ENET card running the **ipsg** application

The link parameter values **a4-a15** and **b4-b15** can be specified only for the HC-MIM card and the E5-E1T1 card. The link parameter values **a16-a31** and **b16-b31** can be specified only for the HC MIM card. The link parameter values **a4-a15** and **b4-b15** can be specified only for the E5-ENET card.

If an IPSP-M3UA signaling link is used, then this command cannot be entered.

This command is not valid on TCP/IP point-to-multipoint links (SSEDCCM or E5-ENET cards equipped as IPGWI links).

### Notes

If the link is already inhibited, the system does not execute the command.

If the link is aligned, it attempts to perform a changeover to alternate links. If it is not aligned, it cannot carry traffic.

If the link is the last link in the linkset, or if the node assigned to the link is inaccessible by another route, the inhibit request is denied. If a command request is denied, it is because the SS7 changeover procedure cannot take place.

If the **inh-slk** command is followed by the **init-card** command, the inhibition of the signaling link is not preserved after the **init-card** command completes.

Card locations are illustrated in the *Installation Manual – EAGLE 5 ISS*.

The **inh-slk** command might time out if a far-end remote does not respond to the inhibit message.

### Output

```
inh-slk:loc=1301:link=a
  rlghncxa03w 05-01-07 11:11:28 EST  EAGLE5 33.0.0
  Inhibit Link message sent to card
;
```

## inh-trm

### Inhibit Terminal

Use this command to set the primary state of a serial port to OOS-MT-DSBLD. It sets the secondary state to MANUAL. The serial port is not available to perform service functions. There is no outgoing traffic from the serial port, and all incoming traffic is ignored.

**Keyword:** **inh-trm**

**Related Commands:** **act-echo, alw-trm, canc-echo, chg-trm, dact-echo, rept-stat-trm, rmv-trm, rst-trm, rtrv-trm**

**Command Class:** System Maintenance

**Parameters****:trm=** (mandatory)

The ID of serial port to be inhibited

**Range:** 1-40**:force=** (optional)

The parameter forces the removal of a specified terminal, even if it is the last in-service OAP port or last in-service SEAS terminal available.

**Range:** yes, no**Default:** no**Example****inh-trm:trm=5****inh-trm:trm=1:force=yes****Dependencies**

No other action command can be in progress when this command is entered.

The IP User Interface feature must be enabled before terminal ports 17 through 40 can be specified in the **trm** parameter.The terminal specified by the **trm** parameter must be equipped.The **force=yes** parameter must be specified to inhibit the last in-service OAP port.

This command cannot be used to inhibit the terminal from which the command is entered.

The **force=yes** parameter must be specified to inhibit the last in-service SEAS terminal.**Notes**

When inhibiting an already inhibited terminal, a warning message is echoed to the scroll area, but no action is taken.

**Output****inh-trm:trm=5**

rlghncxa03w 04-01-07 11:11:28 EST EAGLE 31.3.0

Inhibit message sent to terminal

;

**inh-trm:trm=17:force=yes**

tekelecstp 07-01-23 18:46:01 EST EAGLE 37.5.0

Inhibit message sent to terminal

;

**init-card****Initialize Card**

Use this command to cause a soft reset of a card. It has the same result as a hard reset (card boots, application, and data load), except that connect status is not affected; that is, if a card is not connected, it stays that way.

When the command is issued to the OAM software, there is a 10-second wait before the card is reset. This wait period is intended to ensure that all database updates are complete before the card is reset.



**CAUTION: When a LIME1 or LIMT1 card has associated channel cards (LIMCH) with provisioned links, the init-card command entered for the LIME1 or LIMT1 card causes all links on the associated channel cards to go out of service.**



**CAUTION:** Resetting more than 8 Service Module cards via the **init-card** command at once may result in an extended reload time for the Service Module cards.

**Keyword:** **init-card**

**Related Commands:** **dlt-card**, **ent-card**, **init-sys**, **rept-stat-card**, **rmv-card**, **rst-card**, **rtrv-card**

**Command Class:** System Maintenance

### Parameters

**:appl=** (optional)

Application. This parameter specifies the type of application residing on the card.



**CAUTION:** Because the **appl** parameter causes all LIMs running the assigned application to reload, it should be used only during periods of low traffic.

**Range:**

*xyyyyyy*

1 alphabetic character followed by up to 6 alphanumeric characters. Valid applications are:

**atmansi**—This application is used by LIM-ATM cards and E5-ATM cards to support high-speed ATM signaling links. It is also used by the E5-ATM card to support T1 functions.

**atmitu**—This application is used by E1-ATM cards and E5-ATM cards to support E1 high-speed signaling links. It is also used by the E5-ATM card to support E1 functions.

**cs7itu**—This application is used by E1/T1 MIM cards, HC-MIM cards, and E5-E1T1 cards for ITU-TSS MTP functions.

**eroute**—This application is used by STC cards and E5-STC cards for EAGLE 5 Integrated Monitoring Support functions.

**gls**—This application is used by TSM cards and E5-TSM cards for downloading gateway screening to LIM cards and Service Module cards.

**ipgwi**—This application is used by SSEDCCM cards and E5-ENET cards for TCP/IP point-to-multipoint connectivity for ITU point codes. The system allows a maximum of 125 cards to be assigned the **ipgwi** application.

**iplim**—This application is used by SSEDCCM cards and E5-ENET cards for TCP/IP point-to-point connectivity for ANSI point codes.

**iplimi**—This application is used by SSEDCCM cards and E5-ENET cards for TCP/IP point-to-point connectivity for ITU point codes.

**ips**—This application is used by IPSM cards and E5-IPSM cards for the IP User Interface feature.

**ipsg**—This application is used by E5-ENET cards (IPSG cards) to support the combined functionality of IPLIMx M2PA and IPGWx M3UA.

**mcp**—This application is used by MCPM cards for the Measurements Platform feature.

**ss7ansi**—This application is used by E1/T1 MIM cards, HC-MIM cards, and E5-E1T1 cards for the MTP functions.

**ss7ipgw**—The application software for TCP/IP point-to-multipoint connectivity. The system allows a maximum of 125 cards to be assigned the **ss7ipgw** application.

**stplan**—This application is used by DCM cards and E5-ENET cards to support the STP LAN functions.



**vsccp**—This application is used by Service Module cards to support EPAP-based features and LNP features. If no EPAP-based features or LNP features are turned on, and a Service Module card is present, the **vsccp** GPL processes normal GTT traffic.

**Default:** The application assigned to the card

**:data=** (optional)

High memory refresh. This parameter causes data to be reloaded to the specified card. This parameter is used to reload data if the LNP feature or an EPAP-based feature is on or the ATINP feature is enabled. This parameter is applicable only to Service Module cards that run the **vsccp** application and contain an RTDB.

**Range:** **refresh, persist**

**refresh**— Causes data to be reloaded to the specified card.

**persist**— Indicates that the database is not to be reloaded to the card. Used to request that the EAGLE 5 ISS perform a warm restart of the requested cards. The EAGLE 5 ISS performs various checks to ensure that all conditions necessary to initiate the warm restart are in place. The **force** parameter is required if all of the specified cards do not meet the warm restart requirements. During the card initialization and loading sequence, a warm restart is performed for all cards that meet the warm restart conditions.

**Default:** **refresh**

**:force=** (optional)

Force indicator. Enables the command to be processed under the following conditions:

- If **serial=yes** and all cards of the specified GPL type are not IS-NR or OOS-MT-DSBLD.
- If **initclk=yes** and the TDM card specified in the **loc** parameter is the only good HS clock source that is currently active. A temporary clock outage will occur.
- If **initclk=yes** and **appl=eoam** is specified (bitfiles on both TDMs will be initialized). A temporary clock outage will occur.

**Range:** **yes, no**

**Default:** **no**

**:initclk=** (optional)

Initialize TDM Bitfile indicator. If TDM reload would cause a system clock outage, the **initclk** parameter cannot be specified unless **force=yes** is also specified.



**CAUTION: The resulting clock outage will probably cause loss of traffic on all links.**

The following scenarios will cause such clock outages:

- Simplex MASP configuration (a system with a single TDM).
- Bad clock status on the remaining TDM.

**Range:** **yes, no**

If **initclk=yes** is specified with a single TDM card location, the bitfile for the specified TDM reloads.

If **initclk=yes** is specified with **appl=eoam** and **force=yes**, the bitfile reloads on both TDMs.

**:loc=** (optional)

Card address. The card location as stenciled on the shelf of the system.

**Range:** 1101-1108, 1111-1116, 1201-1208, 1211-1218, 1301-1308, 1311-1318, 2101-2108, 2111-2118, 2201-2208, 2301-2318, 3101-3108, 3111-3118, 3201-3208, 3211-3218, 3301-3308, 3311-3318, 4101-4108, 4111-4118, 4201-4208, 4211-4218, 4301-4308, 4311-4318, 5101-5108, 5111-5118, 5201-5208, 5211-5218, 5301-5308, 5311-5318, 6101-6108, 6111-6118

When the **initclk** parameter is not specified, the listed card locations are valid.

When the **initclk** parameter is specified with the **loc** parameter, only card locations **1113**, **1114**, **1115**, and **1116** are valid. Entering locations **1114** and **1116** results in the same action as entering **1113** and **1115**.

**Default:** All valid card locations are initialized.

**:prtnggrp=** (optional)

Partition group. This parameter specifies the disk partition group that is used as the source for downloading the appropriate GPL.

A value of **1113** or **1115** must be specified for the **loc** parameter before this parameter can be specified.

**Range:** **active**, **inactive**  
**active** — the active partition group  
**inactive** — the inactive partition group

**Default:** **active**

**:serial=** (optional)

Controls the manner in which cards are initialized. If **serial=yes** is specified, cards of the specified APPL type are initialized one at a time. If **serial=no** is specified, cards of the specified APPL type are initialized simultaneously.

**Range:** **yes**, **no**

**Default:** **no**

### Example

```
init-card:Loc=1113:prtnggrp=inactive
init-card:loc=1101:data=persist
init-card:loc=1113:initclk=yes
init-card:appl=eoam:initclk=yes:force=yes
init-card:appl=ipsg
```

### Dependencies

The shelf and card must be equipped.

Either the **loc** or **appl** parameter, but not both parameters, must be specified in the command.

The following card locations (**loc** parameter) are not allowed for this command: **1117**, **1118**, and all **xy09** and **xy10** card locations (where *x* is the frame and *y* is the shelf).

If the **loc** parameter is specified with the **initclk** parameter, the **loc** parameter value must be card location **1113** or **1115**. If the **appl** parameter is specified with the **initclk** parameter, the **appl** parameter value must be **eoam**.

If TDM reload would cause system clocks to fail that are required to keep links active or TSCSYNC available, the **initclk** parameter cannot be specified unless **force=yes** is also specified.

**CAUTION: The resulting clock outage will probably cause loss of traffic on all links.**



CAUTION

Clocks are required in the following situations:

- When at least one DS0 card is provisioned, one BITS clocks is required.

- When a high speed link is being master-timed, at least one high speed clock is required.
- When TSCSYNC is turned on, both SYSTEM clocks (A&B) are required.

The **initclk** parameter can be specified only for TDM cards that support bitfile reloading (TDM-15 or later).

The **force** parameter must be specified for the cards that are not in the In-service Normal state.

The **serial** parameter is valid only when used with the **appl** parameter.

The **appl=all** parameter can be specified only when the **serial=yes** parameter is also specified.

The following applications are valid for the **appl** parameter: **ss7ansi**, **gls**, **ccs7itu**, **stplan**, **atmansi**, **iplim**, **iplimi**, **ss7ipgw**, **vsccp**, **atmitu**, **ipgwi**, **ips**, **eroute**, **ipsg**, or **mcp**.

The **force** parameter can be specified only when the **initclk**, **appl**, and **data** parameters are specified.

The **data** parameter is valid only for SCCP card locations or GPLs, or MPS database (VSCCP) card locations or GPLs.

The card location (**loc**) must be within the allowed range.

The specified card does not exist or is not a logical processing element.

An EPAP-based feature or an LNP feature that is warm-restart-capable must be enabled before this command can be entered with the **data=persist** parameter.

If the **serial=yes** parameter is specified, the **appl** parameter must specify a network type application value or must be equal to **all**.

The A-Port, EIR, G-Flex, G-Port, INP, IS41 GSM Migration (IGM), LNP ELAP Configuration, PPSMS, Prepaid IDP Relay Query (IDP Relay), or V-Flex feature must be turned on, or the ATINP feature must be enabled before the **data** parameter can be specified.

If a removable cartridge is inserted in the system, then the **prtnggrp=inactive** parameter cannot be specified.

The **loc** parameter must be specified with a value of **1113** or **1115** before the **prtnggrp** parameter can be specified.

## Notes

The TDM card has a processor but no application.

## Output

**init-card:loc=1201**

Init Card command issued to card 1201

3021.0013 \* CARD 1201 CCS7ITU Card is isolated from the system

3022.0201 \* SLK 1201,A lsnssp2 SLK unavailable for traffic  
SLC=0 FECLLI=-----3023.1201 \* SLK 1201,B lsnstpi SLK unavailable for traffic  
SLC=0 FECLLI=-----

;

**init-card:appl=all:serial=yes**

Command entered at terminal #3.

Init Card command issued to card 1201

\* 3021.0013 \* CARD 1201 SS7ANSI Card is isolated from the system

\*\* 3022.0236 \*\* SLK 1201,A lsnssp2 REPT-LKF: not aligned  
SLC=0 FECLLI=----- CLASS=MTP2

3023.0014 CARD 1201 SS7ANSI Card is present

3024.0200 SLK 1201,A lsnssp2 RCVRY-LKF: link available  
SLC=0 FECLLI=----- CLASS=MTP2

Init Card command issued to card 1202

\* 3026.0013 \* CARD 1202 ATMANSI Card is isolated from the system

\*\* 3026.0236 \*\* SLK 1202,A lsnssp3 REPT-LKF: not aligned  
SLC=0 FECLLI=----- CLASS=SAAL

3027.0014 CARD 1202 ATMANSI Card is present

3028.0200 SLK 1202,A lsnssp3 RCVRY-LKF: link available  
SLC=0 FECLLI=----- CLASS=SAAL

;

**init-card:loc=1101:data=refresh**

Command entered at terminal #10.

Init Card command issued to card 1101

\*\* 1127.0013 \*\* CARD 1101 SCCP Card is isolated from the system  
ASSY SN: 97361659

1128.0329 SCCP SYSTEM SCCP capacity normal, card(s) abnormal

1129.0014 CARD 1101 SCCP Card is present  
ASSY SN: 973616591234.1238 SYSTEM INFO Full LNP database reload initiated:  
CARD=1101 GPL=SCCP CAUSE=USER REQUEST  
Report Date: 00-02-24 Time: 16:27:195402.1241 SYSTEM INFO REPT EVT: LNP Incremental Loading.  
database levels loaded : 0 of 1145  
Report Date: 00-02-24 Time: 16:52:041234.1239 SYSTEM INFO LNP updates inhibited: loading stability  
Report Date: 00-02-24 Time: 16:52:07

1234.1240 SYSTEM INFO LNP updates allowed: loading stability

```

Report Date: 00-02-24 Time: 16:52:09

1130.0096 CARD 1101 SCCP Card has been reloaded

1131.0328 SCCP SYSTEM SCCP is available
;

init-card:loc=1115:initclk=yes
tekelecstp 04-07-17 13:01:59 EST EAGLE 31.6.0
Init Card command issued to card 1115
;

tekelecstp 04-07-17 13:01:59 EST EAGLE 31.6.0
* 3021.0013 * CARD 1115 EOAM Card is isolated from the system
;

tekelecstp 04-07-17 13:03:10 EST EAGLE 31.6.0
3022.0014 CARD 1115 EOAM Card is present
ASSY SN: 1216115
;

```

**init-flash**

**Initialize Flash**

Use this command to load the Board PROM to the inactive FLASH memory of a specified card or range of cards. When a card is reinitialized, it runs this version of the GPL in the card's inactive FLASH memory.

**Keyword:** **init-flash**

**Related Commands:** **act-flash, clr-imt-stats, flash-card, init-imt-gpl, rept-imt-info, rept-imt-lvl1, rept-imt-lvl2, tst-imt**

**Command Class:** System Maintenance

**Parameters**

**:code=** (mandatory)

The version of the GPL being loaded onto the card.

**Range:** **appr, trial**

**appr** — The approved GPL version

**trial** — The trial GPL version

**:boot=** (optional)

This parameter indicates whether the HC-MIM or EPM based card should boot or not boot after the command successfully completes.

Multiple images can be flashed without having to boot after each flash. If multiple images are being flashed to the HC-MIM or EPM based card, this parameter can be used to prevent the card from booting after each image is flashed. If multiple images are being flashed and the card is allowed to boot after each flash, an image that is not activated after the card boots will be lost on a subsequent reset of the card.

**Range:** **yes, no**

**yes** — Reboot the card after the command completes successfully

**no** — Do not reboot the card after the command completes successfully.

**Default:** **yes**

**:eloc=** (optional)

End location. Location of the last card of a range of cards to be initialized.

**Range:** **1101-1113, 1115, 1201-1218, 1301-1318, 2101-2118, 2201-2218, 2301-2318, 3101-3118, 3201-3218, 3301-3318, 4101-4118, 4201-4218, 4301-4318, 5101-5118, 5201-5218, 5301-5318, 6101-6118**

**:force=** (optional)

This parameter is required to force the TDM-GTI bitfile reload if a clock outage will occur when **initclk=yes** is specified.

**Range:**     **yes, no**

**Default:**   **no**

**:gpl=** (optional)

Generic program load. This parameter specifies the flash GPL type that is running on the cards in the specified range of cards.

**Range:**     xyyyyyy

1 alphabetic character followed by up to 6 alphanumeric characters.

Valid GPLs are: **blbios, blbepm, blbsmg, blepld, bldiag6, blmcap, blrom1, blvxw6, bpdcm, bpdcm2, bphcap, bphcapt, bphmux, bpmpl, bpmplt, hipr, hipr2, imtpci, and pldpmc1.**

**:initclk=** (optional)

If this parameter is specified for an EOAM card location (1113 or 1115), it determines whether or not the TDM-GTI bitfile should be reloaded, causing a clock initialization.

The command will be accepted if the TDM being initialized is a TDM-GTI and the following conditions are true:

- The card being flashed is in location 1113 or 1115.
- Any required clocks from the mate OAM are valid, or the **force=yes** parameter is used.

**Range:**     **yes, no**

**Default:**   **no**

**:loc=** (optional)

The location of a single card to be initialized.

**Range:**     **1101-1113, 1115, 1201-1218, 1301-1318, 2101-2118, 2201-2218, 2301-2318, 3101-3118, 3201-3218, 3301-3318, 4101-4118, 4201-4218, 4301-4318, 5101-5118, 5201-5218, 5301-5318, 6101-6118**

**:sloc=** (optional)

Start location. Location of the first card of a range of cards to be initialized.

**Range:**     **1101-1113, 1115, 1201-1218, 1301-1318, 2101-2118, 2201-2218, 2301-2318, 3101-3118, 3201-3218, 3301-3318, 4101-4118, 4201-4218, 4301-4318, 5101-5118, 5201-5218, 5301-5318, 6101-6118**

**Example**

```
init-flash:loc=1105:code=trial
init-flash:sloc=1101:eloc=1112:gpl=bpdcm:code=appr
init-flash:loc=1113:code=appr:initclk=yes
init-flash:loc=1115:code=appr:initclk=yes:force=yes
init-flash:loc=1115:code=trial:initclk=no
```

**Dependencies**

The specified card must be an HCAP, HCAP-T, DCM, E1/T1 MIM, HC-MIM, E5-E1T1, E5-ENET, GPSM-II, MPL, E5-TSM, or Service Module card. An HMUX, HIPR, or HIPR2 card can be specified, but only for locations xy09 and xy10 (x is the frame and y is the shelf).

Each specified card does not have to be defined in the database, but it does have to be aligned on the IMT bus.

If the card in the specified card location is provisioned, the card must be inhibited before this command is entered (unless the card is an HMUX, HIPR, or HIPR2 card).

If the target card is an HMUX, HIPR, or HIPR2 card, then both card locations specified in the **sloc** and **eloc** parameters must contain HMUX, HIPR, or HIPR2 cards on the same IMT bus. For these cards, the bus is implicit based on the specified location. Location *xy09* specifies an HMUX, HIPR, or HIPR2 A Bus, and location *xy10* specifies an HMUX, HIPR, or HIPR2 B Bus (*x* is the frame and *y* is the shelf). For example, **sloc=1109:eloc=6109** specifies all HMUX, HIPR, or HIPR2 cards on the A Bus only; **sloc=1110:eloc=6110** specifies all HMUX, HIPR, or HIPR2 cards on the B Bus only. HMUX, HIPR, or HIPR2 cards from both the A bus and B bus cannot be flash downloaded simultaneously.

If the target card is an HC-MIM or EPM based card, the **gpl** parameter must be specified when the **loc** parameter is specified.

The **boot** parameter can be specified only if the target is an HC-MIM or EPM based card.

The **boot** parameter cannot be specified for the **blcpld** HC-MIM GPL.

A card location that contains the active MASP cannot be specified for the **loc**, **sloc**, or **eloc** parameter.

The provisioning subsystem mode (simple, duplex) must be established prior to executing the command.

The **loc** parameter cannot be specified with the **eloc** and **sloc** parameters.

Either the **loc** parameter or the **eloc** and **sloc** parameters must be specified.

If the **eloc** and **sloc** parameters are specified, the **gpl** parameter must be specified. The cards in the locations specified in the **sloc** and **eloc** parameters must be running the specified general program load (**gpl**). Other cards in the range of card locations can be running other GPLs, but will not be initialized. Only the cards within the range that are running the specified GPL will be initialized.

The **sloc** parameter value must be less than the **eloc** parameter value, when the two parameters are specified.

The specified card cannot be running an inactive flash GPL when the command is executed.

If **initclk** is specified, the card location parameter value must be **1113** or **1115**.

If TDM reload would cause a system clock outage, the **initclk** parameter cannot be specified unless **force=yes** is also specified.



**CAUTION: The resulting clock outage will probably cause loss of traffic on all links.**

The command will be accepted if the TDM being initialized is a TDM-GTI and the following conditions are true:

- The card being flashed is in location 1113 or 1115.
- Any required clocks from the mate OAM are valid, or the **force=yes** parameter is used.

The **initclk** parameter can be specified only for TDM cards that support bitfile reloading (TDM-15 or later).

EPM-based cards cannot support a valid trial version of the **blbepm** GPL and **blcpld** GPL at the same time. One of these GPLs must be downloaded and activated before the other one can be downloaded. The HC-MIM card cannot support a valid trial version of the **blbios** GPL and **blcpld** GPL at the same time. One of these GPLs must be downloaded and activated before the other one can be downloaded.

No other related command can be in progress when this command is entered.

A card location that is valid and defined in the database must be specified.

The **eloc** and **sloc** parameters must be specified together in the command; one parameter cannot be specified without the other parameter.

The cards specified in the **sloc** and **eloc** location parameters must be running the specified general program load (gpl).

If the **loc** parameter is specified with the **initclk** parameter, the **loc** parameter value must be card location **1113** or **1115**. If the **appl** parameter is specified with the **initclk** parameter, the **appl** parameter value must be **eoam**.

This command cannot be entered if an IMT Rate Change sequence is in progress.

## Notes

Card locations **1114**, **1116**, and **1117** are not valid and cannot be specified.

For the HC-MIM or EPM based cards, multiple images can be flashed without having to boot the card after each flash. If multiple images are being flashed to the card the **boot=no** parameter can be used to prevent the card from booting after each image is flashed. After flashing any number of images, the card can be reset either by entering the **init-flash** command with the **boot=yes** parameter or by entering the **init-card** command. If multiple images are being flashed and the card is allowed to boot after each flash, any images that are not activated after the card boots will be lost on a subsequent reset of the card.

## Output

```

init-flash:loc=1105:code=trial
  rlghncxa03w 04-01-05 13:05:05 EST  EAGLE 31.3.0
  FLASH Memory Downloading for card 1105 Started.

  rlghncxa03w 04-01-05 13:05:05 EST  EAGLE 31.3.0
  BPHCAP Downloading for card 1105 Complete.

  rlghncxa03w 04-01-05 13:05:05 EST  EAGLE 31.3.0
  Command Completed.
;

init-flash:sloc=1101:eloc=1112:gpl=bpdc:code=appr
  rlghncxa03w 05-01-02 13:05:05 EST  EAGLE 33.0.0
  FLASH Memory Download for cards 1101 - 1112 Started.
;

  rlghncxa03w 05-01-02 13:05:05 EST  EAGLE 33.0.0
  FLASH Memory Download for cards 1101 - 1112 Completed.
  LOC 1101 : PASSED
  LOC 1102 : PASSED
  LOC 1112 : PASSED

  ALL CARD RESULTS PASSED
;

  rlghncxa03w 05-01-02 13:05:05 EST  EAGLE 33.0.0
  Command Completed.
;

init-flash:loc=1113:code=appr:initclk=yes
  rlghncxa03w 04-03-08 10:02:04 EST  EAGLE 31.6.0
  FLASH Memory Download for card 1113 Started.
;

  rlghncxa03w 04-03-08 10:02:23 EST  EAGLE 31.6.0
  FLASH Memory Download for card 1113 Completed.
;

```



**init-imt-gpl****Initialize IMT GPL**

Use this command to load the specified IMT GPL software to the specified card and to reset that card. The application software is reloaded following IMT reset.

**Keyword:** **init-imt-gpl**

**Related Commands:** **alw-card, inh-card, init-card, rept-stat-card**

**Command Class:** System Maintenance

**Parameters**

**:code=** (mandatory)

Specifies which IMT GPL to load to the card.

**Range:** **appr, refresh, trial**

**appr** — The approved GPL version

**refresh** — Reload approved GPL version without card reset

**trial** — The trial GPL version

**:loc=** (optional)

Specifies the address of the card to be initialized.

**Range:** **1101-1108, 1111-1112, 1201-1208, 1211-1218, 1301-1308, 1311-1318, 2101-2108, 2111-2118, 2201-2208, 2211-2218, 2301-2308, 2311-2318, 3101-3108, 3111-3118, 3201-3208, 3211-3218, 3301-3308, 3311-3318, 4101-4108, 4111-4118, 4201-4208, 4211-4218, 4301-4308, 4311-4318, 5101-5108, 5111-5118, 5201-5208, 5211-5218, 5301-5308, 5311-5318, 6101-6108, 6111-6118**

**Default:** All locations

**Example**

```
init-imt-gpl:loc=1201:code=trial
```

```
init-imt-gpl:code=refresh
```

```
init-imt-gpl:code=appr
```

**Dependencies**

The card location shelf must be within the allowed ranges as specified on the **loc** parameter. The shelf is the first two digits of the **loc** parameter.

The card location slot must be within the allowed ranges as specified on the **loc** parameter. The slot is the second two digits of the **loc** parameter.

The card location cannot contain a card with flash memory (HCAP, HCAP-T, DCM, MPL, HC MIM, HIPR, or HMUX).

When this command is entered, no other action command can be in progress.

If the **code=appr** or **code=trial** parameter is specified, the **loc** parameter must be specified.

If the **code=trial** parameter is specified, the **loc** parameter must be specified, and the specified card location must be equipped and in service.

If the **code=appr** or the **code=refresh** parameter is specified, the card must be connected to at least one IMT bus and communicating with the active MASP when the command is entered.

The **init-imt-gpl** command cannot be entered if any of the following commands is running: **clr-imt-stats, rept-imt-info, rept-imt-lvl1, rept-imt-lvl2, tst-imt**.

This command must not be entered during IMT statistics collection following an hourly boundary.

A card location that is valid and defined in the database must be specified.

**Notes**

None

**Output**

```

init-imt-gpl:loc=1201:code=trial
rlghncxa03w 04-02-27 16:53:22 EST  EAGLE 31.3.0
Initializing IMT GPL for card 1201.

rlghncxa03w 04-02-27 16:53:22 EST  EAGLE 31.3.0
* 0192.0013 * CARD 1201 SS7ANSI    Card is isolated from the system

rlghncxa03w 04-02-27 16:53:22 EST  EAGLE 31.3.0
0193.0014   CARD 1201 SS7ANSI    Card is present

rlghncxa03w 04-02-27 16:53:22 EST  EAGLE 31.3.0
0194.0096   CARD 1201 SS7ANSI    Card has been reloaded
;

```

**init-mux****Initialize High-Speed Multiplexer**

Use this command to reset a single HMUX, HIPR, or HIPR2 card or all HMUX, HIPR, or HIPR2 cards on the specified bus.

If the command is entered between the **init-flash** command and the **act-flash** command, then the command boots the HMUX, HIPR, or HIPR2 processor and brings down the respective IMT bus temporarily (approximately 10 seconds) until the HMUX, HIPR, or HIPR2 card or cards come back into service.

If the command entry is not between the **init-flash** command and the **act-flash** command, the command boots the processor without bringing down the respective IMT bus.

**Keyword:** **init-mux**

**Related Commands:** **act-flash, init-flash**

**Command Class:** System Maintenance

**Parameters**

**:bus=** (optional)

This parameter specifies the HMUX, HIPR, or HIPR2 bus to be reset. All HMUX, HIPR, or HIPR2 cards on the specified bus are reset.

**Range:** a, b

**Default:** a

**:force=** (optional)

Use this parameter to override normal safeguards. The **force=yes** parameter can be used to:

- Reset an entire HMUX, HIPR, or HIPR2 bus when the alternate bus is non-functional
- Reset one HMUX, HIPR, or HIPR2 card during a fault isolation test (**tst-imt**) command

**Range:** yes, no

**Default:** no

**:loc=** (optional)

The card location of a single HMUX, HIPR, or HIPR2 card to be reset.

**Range:** 1109-1110, 1209-1210, 1309-1310, 2109-2110, 2209-2210, 2309-2310, 3109-3110, 3209-3210, 3309-3310, 4109-4110, 4209-4210, 4309-4310, 5109-5110, 5209-5210, 5309-5310, 6109-6110

**Default:** If not specified, all HMUX or HIPR cards on bus A or bus B are reset

### Example

```
init-mux:bus=a
init-mux:loc=1109
```

### Dependencies

An **act-flash** or **init-flash** command cannot be in progress when this command is entered.

Either the **bus** parameter or the **loc** parameter, but not both, must be specified.

This command is not allowed during an IMT Fault Isolation test (**tst-imt**), unless the **force=yes** parameter is specified.

This command is not allowed during the IMT statistics collection period following an hourly boundary (IMT performance monitoring).

The STP options **hmuxabus** or **hmuxbbus** must have their value set to **yes** before this command can be executed.

This command cannot be entered if an IMT Rate Change sequence is in progress.

### Notes

None

### Output

```
init-mux:loc=1109
rlghncxa03w 05-07-13 08:15:10 EST EAGLE 31.3.0
Command Completed.
;
```

## init-network

### Initialize the Network

Use this command to reset all the network cards. The network cards are ACMs, TSMs, and LIMs; that is, anything not part of the Maintenance and Administration Subsystem (MAS). This command resets all the network cards by reloading GPLs and data to the cards. Use of this command requires maintenance personnel to be located at the site.



**CAUTION:** Using this command causes network nodal isolation; however, if the network nodal isolation is less than two seconds, it may not be detected and may not be reported. Also, in some cases when network nodal isolation has been detected and a large number of maintenance troubles are being reported, the network nodal isolation message may not be reported. An alarm is generated, however.

**Keyword:** **init-network**

**Related Commands:**

**Command Class:** System Maintenance

### Parameters

**:force=** (optional)  
Force the resetting of all the network cards.  
**Range:** yes, no  
**Default:** no

### Example

```
init-network
```

### Dependencies

The MASP must be in either *Upgrade Phase 3* mode or *Full Function* mode. (See the “Notes” section for this command for more information.)

The system database must be coherent when this command is entered.

At least one card with either the **ss7ansi** or the **ccs7itu** application installed must exist with an in-service active signaling link.

The **force=yes** parameter must be specified to override the required four-card **ss7ansi** or **ccs7itu** configuration. The system then selects the best available of the remaining **ss7ansi** or **ccs7itu** cards.

### Notes

#### *Upgrade Phase 3*

*Upgrade Phase 3* mode means that the MASPs are running GPLs that match the major revision defined for the approved GPLs, but the other network processors are only prepared to be upgraded.

#### *Full Function*

*Full Function* mode means that all MASPs are running GPLs that match the major revision defined for the approved GPLs. *Full Function* mode is the normal operating mode for the MASP.

**Output**

The command output scrolls into the scroll area of your display contiguously. However, for purposes of this example, each part has an explanation preceding it.

**init-network**

```
rlghncxa03w 06-05-27 08:15:10 EST EAGLE 35.0.0
(Reports the selection of an alternate card.)
rlghncxa03w 06-05-27 08:15:10 EST EAGLE 35.0.0
1234.1107 SYSTEM INFO INW ALT card as first to be preloaded
CARD=1201 GPL=SS7ANSI
Report Date: 06-05-27 Time: 16:29:15
```

Reports the selection of a main card.

**init-network**

```
rlghncxa03w 06-05-27 08:15:10 EST EAGLE 35.0.0
1234.1108 SYSTEM INFO INW MAIN card as last to be reset
CARD=1202 GPL=SS7ANSI
Report Date: 06-05-27 Time: 16:29:17
```

Reports that the card cross loading is inhibited.

**init-network**

```
rlghncxa03w 06-05-27 16:30:02 EST EAGLE 35.0.0
1234.1109 SYSTEM INFO Asserted DDL inhibition
CARD=1113 GPL=OAM
Report Date: 06-05-27 Time: 16:27:18
```

Reports that a card reset has been issued.

**init-network**

```
rlghncxa03w 06-05-27 16:30:02 EST EAGLE 35.0.0
1234.1110 SYSTEM INFO Card reset command issued
CARD=1204 GPL=SS7ANSI
Report Date: 06-05-27 Time: 16:30:18
```

Reports that a card is being allowed to load.

**init-network**

```
rlghncxa03w 06-05-27 16:30:02 EST EAGLE 35.0.0
1234.1111 SYSTEM INFO Allowing card to load
CARD=1204 GPL=SS7ANSI
Report Date: 06-05-27 Time: 16:30:18
```

Reports that INW is waiting for validation of card loading.

**init-network**

```
rlghncxa03w 06-05-27 16:30:02 EST EAGLE 35.0.0
1234.1112 SYSTEM INFO Waiting for validation of card loading
CARD=1204 GPL=SS7ANSI
Report Date: 06-05-27 Time: 16:30:18
```

Reports that INW has detected successful completion of card loading.

**init-network**

```
rlghncxa03w 06-05-27 16:30:02 EST EAGLE 35.0.0
1234.1113 SYSTEM INFO Detected card loaded
CARD=1204 GPL=SS7ANSI
Report Date: 06-05-27 Time: 16:30:18
```

Reports that INW has detected the reset or removal of a card.

**init-network**

```
rlghncxa03w 06-05-27 16:30:02 EST EAGLE 35.0.0
1234.1114 SYSTEM INFO Detected card reset or removed
CARD=1204 GPL=SS7ANSI
Report Date: 06-05-27 Time: 16:30:18
```

Reports that the card is being allowed to crossload.

**init-network**

```
rlghncxa03w 06-05-27 16:30:02 EST EAGLE 35.0.0
1234.1115    SYSTEM          INFO Allowed card to skip DDL inhibited
              CARD=1204      GPL=SS7ANSI
              Report Date: 06-05-27 Time: 16:30:18
```

Reports that DDL inhibition has been removed.

**init-network**

```
rlghncxa03w 06-05-27 16:30:02 EST EAGLE 35.0.0
1234.1116    SYSTEM          INFO Removed DDL inhibition
              CARD=1113      GPL=OAM
              Report Date: 06-05-27 Time: 16:30:18
```

If **init-network** is entered during an upgrade, reports that the upgrade is to continue.

**init-network**

```
rlghncxa03w 06-05-27 16:30:02 EST EAGLE 35.0.0
1234.1117    SYSTEM          INFO Initialize OAMs to continue upgrade
              CARD=1113      GPL=OAM
              Report Date: 06-05-27 Time: 16:30:18
```

Reports that a card must be reset manually or removed.

**init-network**

```
rlghncxa03w 06-05-27 16:30:02 EST EAGLE 35.0.0
1234.1118    SYSTEM          INFO Card must be manually reset/removed
              CARD=1204      GPL=SS7ANSI
              Report Date: 06-05-27 Time: 16:30:18
```

Reports that a card has failed to reset.

**init-network**

```
rlghncxa03w 06-05-27 16:30:02 EST EAGLE 35.0.0
1234.1119    SYSTEM          INFO Card failed to reset
              CARD=1204      GPL=SS7ANSI
              Report Date: 06-05-27 Time: 16:30:18
```

Reports that a DDL inhibition assertion has failed.

**init-network**

```
rlghncxa03w 06-05-27 16:30:02 EST EAGLE 35.0.0
1234.1120    SYSTEM          INFO Failed to assert DDL inhibition
              CARD=1113      GPL=OAM
              Report Date: 06-05-27 Time: 16:30:18
```

Reports that an internal error has stopped an **init-network**.

**init-network**

```
rlghncxa03w 06-05-27 16:30:02 EST EAGLE 35.0.0
Command Aborted : Internal error.
```

Reports that a failure to load a card has stopped an **init-network**.

**init-network**

```
rlghncxa03w 06-05-27 16:30:02 EST EAGLE 35.0.0
Command Aborted : Card 1206 failed to load.
```

## init-oap

## Initialize OAP Processor

Use this command to send a hardware signal to the indicated OSS/Application Processor (OAP), causing it to reset and reinitialize its operational software.

**NOTE: This command cannot be used for EOAPs (Enhanced Operation System Support Application Processes).**

**Keyword:** `init-oap`

**Related Commands:** `chg-trm`, `rept-stat-seas`

**Command Class:** System Maintenance

## Parameters

**:oap=** (mandatory)

The OAP that is to be initialized. Any value (**a**, **b**, or **both**) can be specified, regardless of the actual or intended OAP configuration.

**Range:** **a, b, both**

**:force=** (optional)

If the specified OAP is operational (that is, if its state is IS-NR or IS-ANR), and it is the only operational OAP, then the **force=yes** parameter must be specified to reset it. If the specified OAP is not operational, then **force=yes** is not required.

**Range:** **yes, no**

**Default:** **no**

## Example

```
init-oap:oap=a
```

```
init-oap:oap=both:force=yes
```

## Dependencies

The SEAS feature must be turned on before this command can be entered.

No other action command can be in progress when this command is entered.

The **force=yes** parameter must be specified to reset the last OAP.

The SEAS Over IP feature must be turned off before this command can be entered.

## Notes

The EAGLE 5 ISS determines the OAP configuration (single vs. dual) by querying the OAP. If one or both of the OAPs are not operational, then the EAGLE 5 ISS might receive incorrect information about the OAP configuration. Furthermore, if no OAP terminals are defined, no OAP queries are sent, the OAM defaults to a single configuration, and this information may be incorrect.

To allow an OAP to be reset by an OAM not configured for it or when no OAP terminals are yet defined, the **init-oap** command can be used to specify either OAP or both OAPs, even if doing so conflicts with the actual OAP configuration.

## Output

```
init-oap:oap=a
```

```
rlghncxa03w 05-07-01 16:40:40 EST EAGLE 31.3.0
```

```
Initialization signal sent to OAP A
```

```
Command Completed.
```

```
init-oap:oap=both:force=yes
```

```
rlghncxa03w 05-07-01 16:40:40 EST EAGLE 31.3.0
```

```
Initialization signal sent to OAP A
```

```
Initialization signal sent to OAP B
```

```
Command Completed.
```

In the following example, assume that the MDAL is malfunctioning when the command is entered.

```
init-oap:oap=b
```

```
rlghncxa03w 05-07-01 16:40:40 EST EAGLE 31.3.0
```

```
Info: MDAL is not operational. OAP initialization may not occur.
```

```
Initialization signal sent to OAP B
```

```
Command Completed.
```

```
;
```

**init-sys****Initialize System**

Use this command to reset all cards in the system (except HMUX and HIPR cards). When you first enter this command, a caution message is displayed in the scroll area requesting that you re-enter the command to confirm the operation. You have 30 seconds to re-enter the command. The only valid commands that you can enter after entering the **init-sys** command the *second* time are the commands **login** and **act-user**.



**CAUTION:** This command causes a complete system reload, and you should use it only during periods of low traffic. Use this command only when directed by Tekelec Technical Service at (888) FOR-TKLC.



**CAUTION:** When the **init-sys** command executes, the system does not retain the manually initiated state (for example, OOS-MT-DSBLD) for the signaling link, card, or the terminal. After the command executes, the system attempts to bring all provisioned links, cards, and terminals on line, including those that were previously out of service. You will need to manually put each device back into its previous state after the system is back on line. It is, therefore, advisable to print or electronically capture the output of the **rept-stat-slk**, **rept-stat-card**, and **rept-stat-trm** commands for reference prior to issuing the **init-sys** command. To restore a device to its previous state, issue the appropriate inhibit/deactivate command listed in this manual in the section for each of the above **rept-stat** commands.

**Keyword:** **init-sys**

**Related Commands:** **act-gpl**, **chg-db**, **chg-gpl**, **copy-gpl**, **copy-meas**, **disp-disk-dir**, **rept-stat-db**

**Command Class:** System Maintenance

**Parameters**

**NOTE:** The **force** parameter is no longer available.

**:data=** (optional)

High memory refresh. This parameter causes data to be reloaded to the specified card. This parameter is used to reload data if the G-Flex, G-Port, INP, or LNP feature is on, or the ATINP feature is enabled. This parameter is applicable only to network cards containing the MPS database (VSCCP).

**Range:** **refresh**, **persist**

**refresh** — Causes data to be reloaded to the specified card.

**persist** — Indicates that the database is not to be reloaded to the card. Used to request that the EAGLE 5 ISS perform a warm restart of the requested cards. The EAGLE 5 ISS performs various checks to ensure that all conditions necessary to initiate the warm restart are in place.

**Default:** **refresh**

**Example**

```
init-sys
```

```
init-sys:data=persist
```

**Dependencies**

When this command is entered, another **init-sys** command cannot be in progress on another port.

The G-Flex, G-Port, INP, LNP, or V-Flex feature must be turned on, or the ATINP feature must be enabled before the **data** parameter can be specified.

The value specified for the **data** parameter for the confirmation command must be the same value that was specified the first time.



This command cannot be entered if an IMT Rate Change sequence is in progress.

### Notes

When the **init-sys** command is entered the first time, you have 30 seconds to enter the command again. After the command is accepted, a delay of 10 seconds gives the system time to broadcast the information message regarding the system initialization.

From the time that the **init-sys** command is accepted, you must wait approximately two minutes before you can log into the system. If the system terminal is in the VT-100/VT-320 mode, the terminal display will be refreshed with nonzero alarm counts. During this 2-minute interval, an intermediate screen refresh caused by the MASPs' role change from active to standby, and from standby to active. This screen refresh is typically a partial refresh and the alarm indicators are set to zero.

If you are logged into the system in the KSR mode, you receive UAM 0009 (MASP became active) to indicate that you are now able to log into the system. UAM 0009 could be issued twice due to possible transient MASP role change (switching from active to standby). Following the execution of the **init-sys** command, the MASP that was active before the **init-sys** command was entered will be the active MASP when the system has finished reinitializing. TSM cards are reloaded only in the event of power failure or hardware reboot. The execution of this command does not require the TSM cards to be reloaded.

When the OA&M IP Security feature is turned on, and an IPSM card is inserted and initialized for the first time or is removed, inserted, and initialized again, the "SSH Host Keys Regenerated" UIM is displayed. The UIM shows the generated SSH Host Key fingerprint that must be provided at the secure client in order for secure information transfer to occur. The SSH Host Key fingerprint is changed whenever power is lost and restored to an IPSM card.

```
rlghncxa03 03-07-11 07:05:00 EST EAGLE 30.2.0
0021.1493 CARD 1111 INFO SSH Host Keys Regenerated
DSA Server Host Key FTRA-formatted Fingerprint=
84 7c 92 8b c 7c ds 19 1c 6 4b de 5c 8f c5 4d
Report Date:03-07-11 Time:22:27:36
```

When the OA&M IP Security feature is turned on, and an IPSM card is restarted with this command, the "SSH Host Keys Loaded" UIM is displayed. The UIM shows the current SSH Host Key fingerprint. The SSH Host Key fingerprint is not changed if the IPSM card does not lose power.

```
rlghncxa03 01-07-11 07:05:00 EST EAGLE 30.2.0
0021.1493 CARD 1111 INFO SSH Host Keys Loaded
DSA Server Host Key FTRA-formatted Fingerprint=
84 7c 92 8b c 7c ds 19 1c 6 4b de 5c 8f c5 4d
Report Date:03-07-11 Time:22:27:36
```

**Output**

The following example shows what happens when you enter the **init-sys** command once and enter the **init-sys** command a second time within 30 seconds, causing the system to start resetting all of its cards.

**init-sys**

```
rlghncxa03w 04-01-07 07:05:00 EST  EAGLE 31.3.0
Command entered at terminal #3
```

```
rlghncxa03w 04-01-07 07:05:01 EST  EAGLE 31.3.0
CAUTION: This command causes a complete system reload, and
will result in traffic loss.
Re-enter command within 30 seconds to confirm.
```

**init-sys**

```
rlghncxa03w 04-01-07 07:05:16 EST  EAGLE 31.3.0
Command entered at terminal #3
```

```
rlghncxa03w 04-01-07 07:05:17 EST  EAGLE 31.3.0
Init System command issued at terminal #3
```

The following example shows what happens when you enter the **init-sys** command once and allow more than 30 seconds to pass with no other keyboard entry.

**init-sys**

```
rlghncxa03w 04-01-05 07:05:00 EST  EAGLE 31.3.0
Command entered at terminal #3.
```

```
rlghncxa03w 04-01-05 07:05:01 EST  EAGLE 31.3.0
CAUTION: This command causes a complete system reload, and
will result in traffic loss.
Re-enter command within 30 seconds to confirm.
```

```
rlghncxa03w 04-01-05 07:05:31 EST  EAGLE 31.3.0
Init System command aborted due to confirmation timeout
```

The following example shows what happens when you enter the **init-sys** command once and enter a different command (**rls-alm:lvl=minr**), letting the 30-second timer expire for the second entry of the **init-sys** command.

**init-sys**

```
rlghncxa03w 04-01-05 07:05:00 EST  EAGLE 31.3.0
Command entered at terminal #3
```

```
rlghncxa03w 04-01-05 07:05:01 EST  EAGLE 31.3.0
CAUTION: This command causes a complete system reload, and
will result in traffic loss.
Re-enter command within 30 seconds to confirm.
```

**rls-alm:lvl=minr**

```
rlghncxa03w 04-01-05 07:05:10 EST  EAGLE 31.3.0
Command entered at terminal #3
```

```
rlghncxa03w 04-01-05 07:05:11 EST  EAGLE 31.3.0
All the minor alarms are released
```

```
rlghncxa03w 04-01-05 07:05:12 EST  EAGLE 31.3.0
Command Completed
```

```
rlghncxa03w 04-01-05 07:05:31 EST  EAGLE 31.3.0
Init System command aborted due to confirmation timeout
```

The following example shows what happens when the **init-sys** command is entered twice within 30 seconds, and specifies the **data=persist** parameter to perform a warm restart of the requested cards without reloading the database to the cards.

**init-sys:data=persist**

```
rlghncxa03w 04-01-05 07:05:31 EST EAGLE 31.3.0
Command entered at terminal #3
```

```
rlghncxa03w 04-01-05 07:05:31 EST EAGLE 31.3.0
CAUTION: This command causes a complete system reload, and will result in
traffic loss.
Re-enter command within 30 seconds to confirm.
```

```
init-sys:data=persist
rlghncxa03w 04-01-05 07:05:31 EST EAGLE 31.3.0
Command entered at terminal #3
rlghncxa03w 04-01-05 07:05:31 EST EAGLE 31.3.0
Init System command issued at terminal #3
```

## lock

## Lock Keyboard

Use this command to lock a terminal's keyboard. When the keyboard is locked, the system accepts no keyboard commands other than the **unlock** command. The keyboard remains locked until the logged on user's login password is entered at the UNLOCK prompt. When the keyboard is locked, any idle terminal monitor in effect for the terminal is suspended temporarily.

**Keyword:** lock

**Related Commands:** unlock

**Command Class:** Basic

### Parameters

This command has no parameters.

### Example

```
lock
```

### Dependencies

The terminal cannot be an OAP terminal.

The terminal cannot be an **mgmt** terminal used for Network Surveillance.

The terminal cannot be a **telnet** terminal (terminal IDs 17-40).

### Notes

As an alternative, you can unlock a locked terminal by entering the **inh-trm** command, followed by the **alw-trm** command.

### Output

**lock**

```
rlghncxa03w 04-02-17 16:02:05 EST EAGLE 31.3.0
Terminal keyboard is locked. Enter UNLOCK command to unlock.
;
```

## login

## Login

Use this command to log into the system. After you enter this command, the system requests a password. For security reasons, the password is not displayed at the terminal.

**Keyword:** login

**Related Commands:** act-user, chg-pid, chg-secu-dflt, chg-user, dact-user, dlt-user, ent-user, logout, rept-stat-user, rtrv-secu-dflt, rtrv-secu-user, rtrv-user

**Command Class:** Basic

### Parameters

**:uid=** (mandatory)

User ID. The system prompts the user for a valid password after entering in this ID.

**Range:** *azzzzzzzzzzzzzzz*

1 alphabetic character followed by up to 15 alphanumeric characters

### Example

```
login:uid=john
```

### Dependencies

All the following dependencies assume the appropriate features are turned **on**.

The user ID must not be logged in to another port already, and it must not be revoked.

The user ID must have been logged in successfully within the number of days specified on the **uout** parameter of the **ent-user** command.

If the OA&M IP Security Enhancements feature is not turned on, you cannot change the password at the prompt from an IP User Interface telnet terminal (IDs 17-40) when:

- It is the first time the user is logging in with the assigned Userid and password
- The password has expired because of aging out.  
You must log in with a new Userid and password for the first time or change an expired password from a serial terminal (terminal IDs 1-16).

Use the following rules for creating passwords:

- A new password cannot contain more than 12 characters.
- A new password must contain at least the number of characters that you specify on the **minlen** parameter of the **chg-secu-dflt** command.
- A new password must contain at least the number of alphabetic (**alpha** parameter), numeric (**num** parameter), and punctuation (**punc** parameter) characters that you specify on the **chg-secu-dflt** command.
- A new password cannot contain the associated user ID.

### Notes

The **act-user** command can be used in place of **login**. The **act-user** command has been provided in compliance with TL1 standards.

When a new system is shipped, the user ID and password are set to the system. These should be changed immediately to ensure system security.

### Output

Not applicable.

## logout

## Logout

Use this command to end a user session. The **logout** command has the same affect as the **dact-user** and **canc-user** commands.

**Keyword:** logout

**Related Commands:** act-user, chg-pid, chg-user, dact-user, dlt-user, ent-user, login, rept-stat-user, rtrv-secu-user, rtrv-user

**Command Class:** Basic

**Parameters**

This command has no parameters.

**Example**

logout

**Dependencies**

This command cannot be entered from a terminal that is configured as an OAP terminal.

**Notes**

The **dact-user** or **canc-user** commands can be used in place of **logout**.

**Output**

```
logout
rlghncxa03w 06-06-05 07:05:31 EST EAGLE 35.0.0
Command Completed.
;
```

**pass**

**Pass**

Use this command to pass a command string to an individual card for processing. This command reduces the reliance on the OAM build for card and on application-specific information.

**Keyword:** pass

**Related Commands:**

**Command Class:** System Maintenance

**Parameters**

**:loc=** (mandatory)

Card address. The card location as stenciled on the shelf of the system.

**Range:** 1101-1108, 1111-1112, 1201-1208, 1211-1218, 1301-1308, 1311-1318, 2101-2108, 2111-2118, 2201-2208, 2211-2218, 2301-2308, 2311-2318, 3101-3108, 3111-3118, 3201-3208, 3211-3218, 3301-3308, 3311-3318, 4101-4108, 4111-4118, 4201-4208, 4211-4218, 4301-4308, 4311-4318, 5101-5108, 5111-5118, 5201-5208, 5211-5218, 5301-5308, 5311-5318, 6101-6108, 6111-6118

**:cmd=** (optional)

Command string including quotes (“ ”). The command represented in the quoted string is sent to the specified card. Maximum command string length including quotes is 132 characters.

**Range:** ~~~~~

Any string of characters that represent a pass-through command. The string must be enclosed in double quotation marks.

The valid pass-through commands are **arp**, **aslog**, **asplog**, **assocrtt**, **conmmgr**, **drklog**, **ftptest**, **help**, **linkinfo**, **msucount**, **msuroute**, **msutrace**, **netstat**, **nslookup**, **ping**, **sctp**, **sockrtt**, **sockstate**, **traceroute**, **ualog**, **soipdata**, **soiplog**.

See "Pass-Through Commands" for information on pass-through commands.

**NOTE: Pass-through commands shown in online help that are not documented in Chapter 7 are not supported at this time.**

**:proc=** (optional)  
Processor type.  
**Range:** **appl, com**  
**appl**— Application processor  
**com**— Communication processor  
**Default:** **appl**

### Example

```
pass:loc=1201:cmd="ping 198.89.1.2"  
pass:loc=1201:cmd="help"  
pass:loc=1111:cmd="soipdata -f"
```

### Dependencies

The **loc** parameter value must correspond to a card location for:

- An SSED CM or E5-ENET card that runs the **ss7ipgw**, **ipgwi**, **iplim**, or **iplimi** application
- An STC card or E5-STC card that runs the **eroute** application
- An IPSM card or E5-IPSM card that runs the **ips** application
- An SSED CM card or E5-SLAN card that runs the **stplan** application
- A Service Module card that runs the **vsccp** application
- An E5-TSM card that runs the **gls** application

The specified card location is out of range.

Syntax error found in the **pass** command.

Card is not in service

**Pass** command not found.

### Notes

See "Pass-Through Commands" for information on pass-through commands.

**Output**

The following example is not definitive of the output of the **ping** command. It is intended to show how **pass** command output from a card might appear.

```
pass:loc=1201:cmd="ping 198.89.1.2"
  rlghncxa03w 04-02-17 15:35:05 EST EAGLE 31.3.0
  ping - Command Accepted by 1201.
  PASS: MASP A - COMPLTD
;
  OUTPUT FROM 1201:
  Pinging 192.168.100.4 with 32 bytes of data:
  Reply from 192.168.100.3: bytes=32 time<10ms TTL=255
  Reply from 192.168.100.3: bytes=32 time<10ms TTL=255
  Reply from 192.168.100.3: bytes=32 time=140ms TTL=255
  Reply from 192.168.100.3: bytes=32 time=10ms TTL=255
  ping - Command Completed.
  END OUTPUT FROM 1201.
```

The following example is not definitive of the output of the **soipdata** command. It is intended to show how **pass** command output from a card might appear.

```
pass:loc=1111:cmd="soipdata -f"
  tekelecstp 02-12-18 22:14:02 IST EAGLE 37.5.0
  SOIPDATA: SR-5129 Operational Data Report

  Operational Data
  -----
  Reason                                     Count
  -----
  Message Received with Bad Source          673
  Message Received with Bad Destination     205
  Message Received with Bad Version         194
  Number of Goodday Message Received       5387
  Number of Error Messages Sent             45
  Number of UPL Messages Received          78666
  Number of UPL Messages Sent              83577

  SOIPDATA: Command complete.
```

**rept-ftp-meas**

**Report Measurements to FTP**

Use this command to manually initiate generation and FTP transfer of a measurements report from the Measurements Platform MCPM to the customer's FTP server.

- Keyword:** **rept-ftp-meas**
- Related Commands:** **rept-meas**
- Command Class:** Link Maintenance

**Parameters**

- :enttype=** (mandatory)  
Entity type to report on in the measurements report.
- Range:** **eir, link, lnkset, lnp, lsdestni, lsonismt, lsorigni, mapscrn, np, origni, origninc, stp, stplan, tt, sctpasoc, sctpcard, ua, vflex, atinpq**  
  - eir** — Measurements for Equipment Identity Register
  - link** — Measurements for signaling links
  - lnkset** — Measurements for linksets
  - lnp** — Measurements for local number portability
  - lsdestni** — Measurements for linkset destination network identifiers

**lsonismt**— Measurements for ISUP message type screening  
**lsorigni**— Measurements for linkset originating network identifiers  
**mapscrn**— Measurements for GSM MAP message screening  
**np**— Measurements for INP, INP CRP, G-Port, A-Port, MO-based GSM SMS NP, MO-based IS41 SMS NP, IGM, MT-Based GSM SMS NP, and MT-Based IS41 SMS NP  
**origni**— Measurements for originating network identifiers greater than 5  
**origninc**— Measurements for originating network identifiers (less than 5, small networks) for network clusters  
**stp**— Measurements pertaining to the Signaling Transfer Point in general or summarized totals recorded on the STP  
**stplan**— Measurements for STP Local Area Network data links  
**tt**— Measurements for translation types  
**sctpasoc**— Measurements per association for the SCTP protocol (used to carry M3UA, M2PA, and SUA traffic)  
**sctpcard**— Measurements per card for the SCTP protocol (used to carry M3UA, M2PA, and SUA traffic)  
**ua**— Measurements per application server/association for the M3UA and SUA protocols  
**vflex**— Measurements for V-Flex  
**atinpq**— Measurements for ATINP

**:type=** (mandatory)

The measurement report type.

**Range:** **avl, avld, avldth, comp, gtwy, mtcd, mtcddth, mtch, mtcs, nm, rbase, systot**

**avl**— Availability measurements

**avld**— Daily availability measurements

**avldth**— Day to hour availability measurements.

**comp**— Component measurements

**gtwy**— Internetwork gateway-related data from the STP for ANSI and ITU measurements. ANSI gateway measurements are pegged on a per-linkset, per-Network Indicator basis, whereas ITU measurements are pegged on a per-linkset basis.

**mtcd**— Daily maintenance measurements

**mtcddth**— Day-to-hour maintenance measurements

**mtch**— Hourly maintenance measurements

**mtcs**— Link/linkset maintenance status

**nm**— Network management, on-demand

**rbase**— Schedule-report type record base measurements

**systot**— STP system totals

**:day=** (optional)

Day of the week for the specified daily measurement report.

**Range:** **mon, tue, wed, thu, fri, sat, sun**

**Default:** If not specified, the previous single day is reported.

**:hh=** (optional)

The specific half-hour for the specified report. The entry implies the ending time for the collection interval. For example, the parameter **hh=0300** generates a report for the interval 2:30-3:00.

**Range:** **0000-2400**

*hhmm* where *hh* = **00-24** (hour) and *mm* = **00** or **30** (minute)

**:period=** (optional)

The relative period for the report.

**Range:** **active, last, specific**



**:qh=** (optional)

The specific quarter-hour for the specified report. The entry implies the ending time for the collection interval. For example, the parameter **qh=0315** generates a report for the interval **3:00-3:15**.

**Range:** **0000-2400**

*hhmm* where *hh* = **00-24** (hour) and *mm* = **00, 15, 30, or 45** (minute)

### Example

```
rept-ftp-meas:type=systot:enttype=stp
```

```
rept-ftp-meas:type=mtch:enttype=lnp
```

```
rept-ftp-meas:type=mtcd:enttype=sctpasoc
```

### Dependencies

The **rept-ftp-meas** command cannot be used to specify a report type if that report type is currently printing.

The Measurements Platform feature must be turned on (**chg-feat** command) before this command can be entered.

A primary MCPM card must be available when this command is entered.

The 15 Minute Measurements feature must be turned on and the 15 Minute Measurements collection option (**chg-measopts:collect15min=on** command) must be on before the **qh** parameter can be specified.

The LNP feature must be turned on (see the **enable-ctrl-feat** command) before:

- The **mtchlnp=on** parameter or the **mtcdlnp=on** parameter can be specified
- Entity type **lnp** can be specified

The GSM Map Screening feature (see the **enable-ctrl-feat** and **chg-ctrl-feat** commands) must be turned on before:

- The **mtcdmap=on** parameter can be specified.
- Entity type **mapscrn** can be specified

The Equipment Identity Register (EIR) feature must be enabled and turned on before the **enttype=eir** parameter can be specified,.

The **hh** parameter must specify a half-hourly boundary (the end of the requested half-hour for the report) for valid report types (**avld(th)**, **mtcd(th)**, **mtch**, **nm**, **rbase**, and **mtcs** are excluded with message “**E2307: QH or HH is not valid for this TYPE**”).

The **qh** parameter must specify a quarter-hourly boundary (the end of the requested quarter-hour for the report) for valid report types (**avld(th)**, **mtcd(th)**, **mtch**, **nm**, **rbase**, and **mtcs** cannot be specified.

Hourly collection and report processing cannot be in progress when report type **mtch** is specified.

Day-to-hour collection and report processing cannot be in progress

- When report type **mtcd** is specified
- When report type **mtcdth** is specified

Daily collection and report processing cannot be in progress when report type **mtcd** is specified.

Half-hourly collection and report processing cannot be in progress when report type **comp**, **systot**, **avl**, or **gtwy** is specified.

Quarter-hourly collection and report processing cannot be in progress when report type **comp**, **systot**, **avl**, or **gtwy** is specified.

5-minute collection and report processing cannot be in progress when report type **nm** is specified.

The **mtcdth** report type is unavailable between midnight and 1:00 AM (0100).

The **day** parameter can be specified only for report type **mtcd** and entity types **eir**, **lnp**, **np**, **vflex**, and **mapscrn**.

The **hh** and **qh** parameters cannot be specified together in the command.

When the **period=last** parameter is specified, the **hh** parameter, the **qh** parameter, and the **day** parameter cannot be specified.

When the **period=active** parameter is specified, the **hh** parameter, the **qh** parameter, and the **day** parameter cannot be specified.

When the **period=specific** parameter is specified, the **hh** parameter, the **qh** parameter, or the **day** parameter must be specified.

A half-hour boundary must be specified for the **hh** parameter, except for report type **mtch**; an hourly boundary must be specified for report type **mtch**.

A quarter-hour boundary must be specified for the **qh** parameter, except for report type **mtch**.

Table 5-67 indicates with an X valid parameter combinations for measurements reports; invalid combinations will generate an error message.

**Table 5-67. rept-ftp-meas Valid and Invalid Parameter Combinations**

| Parameter Value | :type Parameter Values |      |        |      |      |      |        |      |      |    |        |       |
|-----------------|------------------------|------|--------|------|------|------|--------|------|------|----|--------|-------|
|                 | avl                    | avld | avldth | comp | gtwy | mtcd | mtcdth | mtch | mtcs | nm | systot | rbase |
| <b>:entity</b>  |                        |      |        |      |      |      |        |      |      |    |        |       |
| <b>atinq</b>    |                        |      |        |      |      | X    |        | X    |      |    |        |       |
| <b>eir</b>      |                        |      |        |      |      | X    |        | X    |      |    |        |       |
| <b>link</b>     | X                      | X    | X      | X    |      | X    | X      |      | X    | X  |        | X     |
| <b>lnkset</b>   |                        |      |        | X    | X    | X    | X      |      | X    | X  |        | X     |
| <b>lnp</b>      |                        |      |        |      |      | X    |        | X    |      | X  |        |       |
| <b>lsdestni</b> |                        |      |        |      | X    |      |        |      |      |    |        |       |
| <b>lsorigni</b> |                        |      |        |      | X    |      |        |      |      |    |        |       |
| <b>lsonismt</b> |                        |      |        |      | X    |      |        |      |      |    |        |       |
| <b>mapscrn</b>  |                        |      |        |      |      | X    |        | X    |      |    |        |       |
| <b>np</b>       |                        |      |        |      |      | X    |        | X    |      |    |        |       |
| <b>origni</b>   |                        |      |        |      | X    |      |        |      |      |    |        |       |
| <b>origninc</b> |                        |      |        |      | X    |      |        |      |      |    |        |       |
| <b>sctpasoc</b> |                        |      |        | X    |      | X    | X      |      |      |    |        |       |

**Table 5-67. rept-ftp-meas Valid and Invalid Parameter Combinations**

| Parameter Value | :type Parameter Values |      |        |      |      |      |        |      |      |    |        |       |
|-----------------|------------------------|------|--------|------|------|------|--------|------|------|----|--------|-------|
|                 | avl                    | avld | avldth | comp | gtwy | mtcd | mtcdth | mtch | mtcs | nm | systot | rbase |
| sctpcard        |                        |      |        | X    |      | X    | X      |      |      |    | X      | X     |
| stp             |                        |      |        |      | X    | X    | X      |      |      | X  | X      | X     |
| stplan          | X                      |      |        |      |      | X    | X      |      |      |    | X      |       |
| tt              |                        |      |        |      |      |      |        |      |      |    | X      |       |
| ua              |                        |      |        | X    |      | X    | X      |      |      |    |        |       |
| :period         |                        |      |        |      |      |      |        |      |      |    |        |       |
| last            | X                      | X    | X      | X    | X    | X    | X      | X    |      | X  | X      |       |
| specific        | X                      |      |        | X    | X    | X    |        | X    |      |    | X      |       |
| active          |                        |      |        |      |      |      |        |      | X    |    |        | X     |

An hourly boundary must be specified for report type **mtch**.

The Measurements Platform collection function (**chg-measopts:platformenable=on** command) must be enabled before this command can be entered.

The V-Flex feature must be turned on before the **enttype=vflex** parameter can be specified.

The A-Port, G-Port, IS41 GSM Migration, Prepaid SMS Intercept Ph1, TIF ASD, TIF GRN, TIF Number Portability, or TIF Simple Number Substitution feature must be enabled, or the INP, MO SMS IS41-to-GSM Migration, MO-based GSM SMS NP, or MO-based IS41 SMS NP feature must be turned on before the **mtchnp=on** parameter or the **mtcdnp=on** parameter can be specified.

**Notes**

None

**Output**

**NOTE: Refer to the *Measurements Manual (910-5452-001)* for the EAGLE 5 ISS to obtain current output examples for the rept-ftp-meas command.**

**rept-imt-info**

**Display IMT Error and Use Statistics**

Use this command to display the following statistics:

- The IMT bus error statistics currently stored in the IMT fault isolation hourly statistics
- The current IMT bus use statistics. Bus use is the percentage of the capacity of the IMT bus that is used for data during a particular time.
- The HMUX, HIPR, and HIPR2 card error statistics

**Keyword:** rept-imt-info

**Related Commands:** clr-imt-stats, init-imt-gpl, rept-imt-lvl1, rept-imt-lvl2, tst-imt

**Command Class:** System Maintenance

## Parameters

**:report=** (mandatory)

Type of report to generate.

**Range:** **err, util, hmutexerr, hiprerr, hipr2err**

**err** — Produces a report of the IMT bus error statistics

**util** — Produces a report of the IMT bus use (utilization) statistics

**hmutexerr** — Produces a report of the HMUX card error statistics

**hiprerr** — Produces a report of the HIPR card error statistics

**hipr2err** — Produces a report for the HIPR2 card error statistics

**:ebucket=** (optional)

End bucket. Specifies the last one-hour time period (*bucket*) for which error statistics are reported.

This parameter cannot be specified when **report=util** is specified.

**Range:** **0-15**

**Default:** If **sbucket** is specified—current **sbucket** value; information for only that time period is displayed.

If **sbucket** is not specified—**15**, the report includes statistics for all 16 time periods

**:eloc=** (optional)

End location. Specifies the card location of the last card in the range for the report.

**Range:** **1101-1113, 1115, 1201-1218, 1301-1318, 2101-2118, 2201-2218, 2301-2318, 3101-3118, 3201-3218, 3301-3318, 4101-4118, 4201-4218, 4301-4318, 5101-5118, 5201-5218, 5301-5318, 6101-6118**

**Default:** If **sloc** is specified—current **sloc** value; displays information for one card

If **sloc** is not specified—**1115**, which corresponds to IMT address 251 (**e=251**); displays information for entire range of locations.

**:erroronly=** (optional)

Use this parameter to filter output to display only non-zero counts in the error report.

This parameter can be specified only if **report=err** is specified.

**Range:** **yes, no**

**Default:** **yes**

**:eshelf=** (optional)

This parameter specifies the end shelf location for HMUX, HIPR, or HIPR2 statistics. This shelf location is the last shelf in the range.

**Range:** **1100, 1200, 1300, 2100, 2200, 2300, 3100, 3200, 3300, 4100, 4200, 4300, 5100, 5200, 5300, 6100**

**Default:** If **sshelf** is specified—current **sshelf** value.

If **sshelf** is not specified—**6100**, displays information for entire range of shelves.

**:eslot=** (optional)

This parameter specifies the end slot location for HIPR or HIPR2 statistics for the cards in the HIPR or HIPR2 shelf.

**Range:** **1-18**

**Default:** If **sslot** is specified—current **sslot** value.

If **sslot** is not specified—not used.

**:mode=** (optional)

Display mode to use for error report.

This parameter can be specified only if **report=err** is specified.

**Range:** **full, stats, summary**  
**full** — Displays information for each card along with a summary report  
**stats** — Displays only individual card statistics  
**summary** — Displays the summary portion of the report  
**Default:** **summary**

**:sbucket=** (optional)

Start bucket. Specifies the first one-hour time period (bucket) for which error statistics are reported.

This parameter cannot be specified when **report=util** is specified.

**Range:** **0-15**  
**Default:** **0**

**:sloc=** (optional)

Start location. Specifies the card location of the first card in the range for the report.

**Range:** **1101-1113, 1115, 1201-1218, 1301-1318, 2101-2118, 2201-2218, 2301-2318, 3101-3118, 3201-3218, 3301-3318, 4101-4118, 4201-4218, 4301-4318, 5101-5118, 5201-5218, 5301-5318, 6101-6118**

**Default:** If **eloc** is specified—current **eloc** value.  
 If **eloc** is not specified—**1201**, which corresponds to IMT address 0; displays information for entire range of card locations.

**:sshelf=** (optional)

This parameter specifies the starting shelf location for HMUX, HIPR, or HIPR2 statistics. This location is the first shelf in the range.

**Range:** **1100, 1200, 1300, 2100, 2200, 2300, 3100, 3200, 3300, 4100, 4200, 4300, 5100, 5200, 5300, 6100**

**Default:** If **eshelf** is specified—current **eshelf** value.  
 If **eshelf** is not specified—**1100**, displays information for entire range of shelves.

**:slot=** (optional)

Starting slot location for HIPR or HIPR2 statistics for the cards in the HIPR or HIPR2 shelf.

**Range:** **1-18**  
**Default:** If **eslot** is specified—current **eslot** value.  
 If **eslot** is not specified—not used.

**:trm=** (optional)

The serial port (printer location) to which the report is to be sent.

**Range:** **1-16**  
**Default:** Report displays on the terminal where the command is issued

### Example

```
rept-imt-info:report=err
rept-imt-info:report=err:sloc=1101:eloc=1102:mode=stats
rept-imt-info:report=err:sloc=1101:eloc=1102:mode=full:erronly=no
rept-imt-info:report=util
rept-imt-info:report=hmuxerr
rept-imt-info:report=hiprerr:sbucket=0
rept-imt-info:
rept-imt-info:report=hiprerr:sshelf=1100:slot=1:eslot=2:sbucket=0
rept-imt-info:report=hipr2err
```

## Dependencies

No related IMT command can be in progress when the **rept-imt-info** command is entered. Only one report can be active at a time.

This command cannot be entered at a telnet terminal (terminal ID 17-40).

The **rept-imt-info** command cannot be entered during an IMT statistics collection period following an hourly boundary (IMT performance monitoring).

If the **report=util** parameter is specified, then the **ebucket**, **erronly**, **mode**, and **sbucket** parameters cannot be specified. If a value of **hmuxerr**, **hiprerr**, or **hipr2err** is specified for the **report** parameter, then the **erronly** and **mode** parameters cannot be specified. If a value of **err**, **util**, or **hmuxerr** is specified for the **report** parameter, then the **sslot** and **eslot** parameters cannot be specified.

The ending hourly time period cannot be less than the starting hourly time period. For example, **rept-imt-info:report=err:sbucket=5:ebucket=3** cannot be specified.

When the **sslot** and **eslot** parameters are specified, the **sshelf** parameter must be specified and the **eshelf** parameter cannot be specified (slot information is reported for a single shelf).

A value of **hmuxerr**, **hiprerr**, or **hipr2err** must be specified for the **report** parameter before the **sshelf** and **eshelf** parameters can be specified.

The HIPR or HIPR2 card slots (**09** and **10**) cannot be specified for the **sslot** and **eslot** parameter values.

The STP options **hmuxabus** or **hmuxbbus** must have their value set to **yes** when the **sshelf** and **eshelf** parameters are specified.

A card location that is valid and defined in the database must be specified.

## Notes

This command can be canceled using the **F9** function key or the **canc-cmd** command. See **canc-cmd** for more information.

**IMT Bus Error Statistics:** Each hourly time period (*bucket*) contains the IMT bus error statistics for a single hour. A total of 16 hourly time periods, numbered **0** to **15**, exist. Hourly time period **0** is the most-recent (current), and hourly time period **15** is the least-recent (oldest).

Each hour the statistics for the current hourly time period expire, and the hourly time periods advance. That is, after the advance, the statistics previously reported in hourly time period **0** are now reported in the hourly time period **1**, and so on. The statistics reported in the hourly time period **15** are no longer available after the change.

When a card is reinitialized, it begins collecting statistics in hourly time period **0** and changes to hourly time period **1** at the start of the next hour. Thus, the first statistics that a card collects after being reinitialized may be for a partial hour.

**IMT Bus Use Statistics:** The statistics are calculated for all cards in the specified range and summarized. Only the summarized statistics are displayed. *IMT bus use* is the percentage of the capacity of the IMT bus that is used for data during a particular time.

### **HMUX, HIPR, or HIPR2 Statistics (Bucket Summary)**

Each hourly time period (*bucket*) contains the HMUX, HIPR, or HIPR2 statistics for a single hour. A total of 16 hourly buckets, numbered **0** to **15**, exist. Bucket **0** is the most-recent (current) bucket; bucket **15** is the least-recent (oldest).

Each hour on the hour, the least-recent bucket expires and the hourly time periods advance. That is, after the advance, the statistics previously reported in bucket **0** are now reported in bucket **1**, and so on. The statistics that were reported in bucket **15** are no longer available after the change.

If a card booted within the past 16 hours, a message is displayed indicating that no data is available for that card. When a card boots, it starts to collect statistics in bucket 0. It changes to bucket 1 at the start of the next hour. Thus, the first bucket of statistics that a card collects after booting might be for part of an hour.

A HIPR or HIPR2 card stores the statistics separately for each card on its shelf. If the **sloc** and **eloc** parameters are specified, then the HIPR or HIPR2 card sends the statistics for each card to the OAM application for display. If the **sloc** and **eloc** parameters are not specified, then the HIPR or HIPR2 card sends an aggregate number to the OAM application to represent statistics for all cards on its shelf.

**HMUX, HIPR, or HIPR2 Statistics (Cumulative)**

HMUX, HIPR, or HIPR2 cumulative statistics maintain running totals of the error count for each parameter from card initialization. The error counts can be cleared by entering a **clr-imt-stats:all=yes** command to clear all HMUX, HIPR, and HIPR2 cards, or a **clr-imt-stats** command to clear a specific card.

Table 5-68 explains the **rept-imt-info:report=hmuxerr** statistics.

"Excessive" is primarily determined by the operator, based upon:

- Overall system behavior
- Duration of time since the last statistics were taken
- Statistics of an individual card in relation to other cards

**Table 5-68.** Explanation of **rept-imt-info:report=hmuxerr** Statistics

| IMT Statistic              | Explanation Of Statistic                                                                                      | Probable Causes                                                             | Recommended Action                                                                                                                       |
|----------------------------|---------------------------------------------------------------------------------------------------------------|-----------------------------------------------------------------------------|------------------------------------------------------------------------------------------------------------------------------------------|
| <b>LOW SPEED STATS</b>     |                                                                                                               |                                                                             |                                                                                                                                          |
| IMT Rx Packet CRC Error    | Bad Checksum in received IMT packet. Usually caused by corrupted data. Detected by hardware.                  | Card insertion/ removal or boot. May occur infrequently in a normal system. | None if card has booted or was just inserted. Otherwise, call the Customer Care Center if count is excessive in relation to other cards. |
| IMT Rx Packet Format Error | Occurs when the Start of Message byte of the IMT packet is followed by unexpected data. Detected by hardware. | Card insertion/removal or boot.                                             | None if card has booted or was just inserted. Otherwise call Customer Care Center if count is excessive in relation to other cards.      |
| IMT Rx Violation Error     | Received an illegal character from the IMT. Detected by hardware.                                             | Card insertion/removal or boot.                                             | None if card has booted or was just inserted. Otherwise call Customer Care Center if count is excessive in relation to other cards.      |

Table 5-68. Explanation of **rept-imt-info:report=hmuxerr** Statistics

| IMT Statistic                | Explanation Of Statistic                                                                                                                                                              | Probable Causes                                                                                                                        | Recommended Action                                                                                                                                                                                    |
|------------------------------|---------------------------------------------------------------------------------------------------------------------------------------------------------------------------------------|----------------------------------------------------------------------------------------------------------------------------------------|-------------------------------------------------------------------------------------------------------------------------------------------------------------------------------------------------------|
| CPU Rx FIFO Full             | HMUX's IMT interface is congested. Detected by hardware.                                                                                                                              | Data was received at a higher rate than could be processed                                                                             | Call Customer Care Center if count is excessive in relation to other HMUX cards.                                                                                                                      |
| CPU Rx FIFO Half Full        | HMUX's IMT interface is becoming congested. Detected by hardware.                                                                                                                     | Data was received at a higher rate than could be switched for a short period.                                                          | None. FIFO half full is an indication; no action is required.                                                                                                                                         |
| CPU Rx FIFO Empty Before SOM | Occurs when valid packet data is read from the CPU Rx FIFO by the FPGA but the FPGA cannot locate the beginning (SOM) of the packet before all the data was read.                     | The SOM was corrupted while being written into the CPU Rx FIFO from the low speed link.                                                | None. This error automatically empties the FIFO so that it is ready to continue receiving data. If the problem persists, there may be an FPGA issue. Call the Customer Care Center.                   |
| CPU Rx FIFO Empty Before EOM | Valid packet data is read from the CPU Rx FIFO by the FPGA but the FPGA cannot locate the end (EOM) of the packet before all of the data was read.                                    | The SOM was corrupted while being written into the CPU Rx FIFO, or a partial packet was written into the FIFO from the low speed link. | None. This error automatically empties the FIFO so that it is ready to continue receiving data. If the problem persists, an FPGA or high-speed link problem may exist. Call the Customer Care Center. |
| CPU Rx Packet SOM Before EOM | A Start of Message was received when an End of Message was expected from the IMT bus.                                                                                                 | Packet was corrupted in the system (EOM lost) and another packet is appended to it.                                                    | None.                                                                                                                                                                                                 |
| CPU Rx Packet CRC Error      | Valid packet data is read from the CPU Rx FIFO by the FPGA and transferred to the processor memory, and the FPGA calculated CRC does NOT match the CRC word at the end of the packet. | The data was corrupted while being written into the CPU Rx FIFO, or data coming from the low speed link is corrupted.                  | None. If the problem persists, an FPGA or high-speed link problem may exist. Call the Customer Care Center.                                                                                           |
| DMA Terminal                 | Received IMT packet length is longer than the                                                                                                                                         | Card insertion/removal or boot.                                                                                                        | None if card has booted or was just inserted. Otherwise, call the                                                                                                                                     |



**Table 5-68.** Explanation of **rept-imt-info:report=hmuxerr** Statistics

| <b>IMT Statistic</b>      | <b>Explanation Of Statistic</b>                                                                                                | <b>Probable Causes</b>                                                                                                                   | <b>Recommended Action</b>                                                                                                                                            |
|---------------------------|--------------------------------------------------------------------------------------------------------------------------------|------------------------------------------------------------------------------------------------------------------------------------------|----------------------------------------------------------------------------------------------------------------------------------------------------------------------|
| Count Interrupt           | max allowed. Detected by hardware.                                                                                             |                                                                                                                                          | Customer Care Center if count is excessive in relation to other cards.                                                                                               |
| CPU Tx Buffer EOB         | A packet being transmitted from the CPU Tx Buffer did not have an EOM. The full 512 bytes from the Tx buffer were transmitted. | The data was corrupted while being written into or being read from the FIFO.                                                             | None. If the problem persists, an FPGA problem may exist. Call the Customer Care Center.                                                                             |
| CPU Tx Buffer Full        | The Tx Buffer has had 512 bytes written to it and can accept no more.                                                          | A packet is being sent that is too large.                                                                                                | Write the EOM insert command to send the packet, and write an abort command to reset the Tx buffer control interface, or issue a Tx Buffer reset from the processor. |
| CPU Tx Buffer Half Full   | The Tx Buffer has had 256 bytes written to it.                                                                                 | 256 bytes have been written to the Tx Buffer.                                                                                            | None.                                                                                                                                                                |
| IMT Bypass FIFO Full      | The IMT Bypass FIFO has 32K bytes of data in it.                                                                               | The low-speed link is experiencing very heavy traffic conditions, or the HMUX IMT Transmitter is disabled or is not operating correctly. | Determine why IMT traffic is so heavy. Make sure the HMUX IMT Transmitter is enabled.                                                                                |
| IMT Bypass FIFO Half Full | The IMT Bypass FIFO has 16K bytes of data in it.                                                                               | The low-speed link is experiencing very heavy traffic conditions, or the HMUX IMT Transmitter is disabled or is not operating correctly. | Determine why IMT traffic is so heavy. Make sure the HMUX IMT Transmitter is enabled. Under normal operation, this condition should clear itself.                    |
| IMT Tx FIFO Full          | HMUX's IMT Transmitter FIFO Full                                                                                               | TAXI transmitter logic for this channel is not operating properly.                                                                       | Reset Tx FIFO. If all channels exhibit this problem, an internal FPGA problem with the 125MHz clock may exist. Call the Customer Care Center.                        |

Table 5-68. Explanation of `rept-imt-info:report=hmuxerr` Statistics

| IMT Statistic              | Explanation Of Statistic                                                                                                       | Probable Causes                                                                                           | Recommended Action                                                                                                                             |
|----------------------------|--------------------------------------------------------------------------------------------------------------------------------|-----------------------------------------------------------------------------------------------------------|------------------------------------------------------------------------------------------------------------------------------------------------|
| IMT Tx FIFO Half Full      | HMUX's IMT Transmit Half FIFO Full                                                                                             | High burst rate or multiple large packet transmissions from IXP1250.                                      | None                                                                                                                                           |
| <b>HIGH SPEED STATS</b>    |                                                                                                                                |                                                                                                           |                                                                                                                                                |
| IMT Rx Packet Format Error | Packet was received with a format error (for example, no EOM)                                                                  | Packet was transmitted incorrectly or was corrupted by another device in the system.                      | None                                                                                                                                           |
| IMT Rx Disparity Error     | Fibre Channel transceiver received a disparity error on a character.                                                           | Noisy high-speed ring.                                                                                    | Hardware issue. If the error persists, detailed high-speed bus analysis is required. Call the Customer Care Center.                            |
| IMT Rx Sync Lost Error     | Fibre Channel transceiver is not receiving sync characters                                                                     | Noisy high-speed ring.<br>High-speed cable was disconnected.<br>One of the HMUXs in the ring was removed. | Hardware issue. If the error persists, detailed high-speed bus analysis is required. Call the Customer Care Center.                            |
| IMT Rx Code Word Error     | Fibre Channel transceiver has received an invalid code word.                                                                   | Noisy high-speed ring.<br>Wrong command transmitted.                                                      | Hardware issue. If the error persists, detailed high-speed bus analysis is required. Call the Customer Care Center.                            |
| CPU Receive FIFO Full      | Communication CPU on the card is congested. Detected by hardware                                                               | Data was received at a higher rate than could be processed by the Communications processor.               | Call the Customer Care Center. if count is excessive in relation to other cards.                                                               |
| CPU Receive FIFO Half Full | Communication CPU on the card is becoming congested. Detected by hardware.                                                     | Data was received at a higher rate than could be processed for a short period.                            | None. FIFO half full is an indication; no action is required.                                                                                  |
| CPU Rx FIFO Empty          | Valid packet data is read from the CPU Rx FIFO by the FPGA, but the FPGA is unable to locate the beginning (SOM) of the packet | The SOM was corrupted while being written into                                                            | None. This error automatically empties the FIFO so it is ready to continue receiving data. If the problem persists, an FPGA problem may exist. |

Table 5-68. Explanation of **rept-imt-info:report=hmuxerr** Statistics

| IMT Statistic                | Explanation Of Statistic                                                                                                                                  | Probable Causes                                                                                                                         | Recommended Action                                                                                                                                                                                   |
|------------------------------|-----------------------------------------------------------------------------------------------------------------------------------------------------------|-----------------------------------------------------------------------------------------------------------------------------------------|------------------------------------------------------------------------------------------------------------------------------------------------------------------------------------------------------|
| Before SOM                   | before all the data was read.                                                                                                                             | the CPU Rx FIFO from the high speed link.                                                                                               | Call the Customer Care Center.                                                                                                                                                                       |
| CPU Rx FIFO Empty Before EOM | Valid packet data is read from the CPU Rx FIFO by the FPGA, but the FPGA is unable to locate the end (EOM) of the packet before all of the data was read. | The SOM was corrupted while being written into the CPU Rx FIFO, or a partial packet was written into the FIFO from the high speed link. | None. This error automatically empties the FIFO so that it is ready to continue receiving data. If the problem persists, an FPGA or low-speed link problem may exist. Call the Customer Care Center. |
| CPU Rx Packet SOM Before EOM | A Start of Message was received when an End of Message was expected from the Fibre Channel bus.                                                           | Packet was corrupted in the system (EOM lost) and has another packet appended to it.                                                    | None.                                                                                                                                                                                                |
| CPU Rx Packet CRC Error      | A packet received for this shelf contains a CRC error.                                                                                                    | Packet was transmitted incorrectly or was corrupted by another device in the system.                                                    | Discard packet. If this problem persists, a more detailed analysis of the system is needed. Call the Customer Care Center.                                                                           |
| DMA Terminal Count Interrupt | Received IMT packet length (on Fibre Channel) is longer than the maximum allowed. Detected by hardware.                                                   | Card insertion/removal or boot.                                                                                                         | None if card has booted or was just inserted. Call the Customer Care Center. if count is excessive in relation to other cards.                                                                       |
| CPU Tx Buffer EOB            | A packet that was being transmitted from the CPU Tx Buffer did not have an EOM. Therefore, the full 512 bytes from the Tx buffer were transmitted.        | The data was corrupted while being written into or being read from the FIFO.                                                            | None. If the problem persists, an FPGA problem may exist. Call the Customer Care Center.                                                                                                             |
| CPU Tx Buffer Full           | The Tx Buffer has had 512 bytes written to it and can accept no more.                                                                                     | A packet is being sent that is too large.                                                                                               | Write the EOM insert command to send the packet, write an abort command to reset the Tx buffer control interface, or issue a Tx Buffer reset from the processor.                                     |

Table 5-68. Explanation of `rept-imt-info:report=hmuxerr` Statistics

| IMT Statistic                          | Explanation Of Statistic                                                            | Probable Causes                                                                                                                                                    | Recommended Action                                                                                                                                             |
|----------------------------------------|-------------------------------------------------------------------------------------|--------------------------------------------------------------------------------------------------------------------------------------------------------------------|----------------------------------------------------------------------------------------------------------------------------------------------------------------|
| CPU Tx FIFO Half Full                  | The Tx Buffer has had 256 bytes written to it.                                      | 256 bytes have been written to the Tx Buffer.                                                                                                                      | None.                                                                                                                                                          |
| IMT (High-speed) Bypass FIFO Full      | The High-speed Bypass FIFO has 2K bytes of data in it.                              | The high-speed link is experiencing very heavy traffic conditions, or the HMUX High-speed Transmitter is disabled or is not operating correctly.                   | Determine why high-speed traffic is so heavy. Make sure the HMUX High-speed Transmitter is enabled.                                                            |
| IMT (High-speed) Bypass FIFO Half Full | The High-speed Bypass FIFO has 1K bytes of data in it.                              | The high-speed link is experiencing very heavy traffic conditions or the HMUX High-speed Transmitter is disabled or is not operating correctly.                    | Determine why high-speed traffic is so heavy. Make sure HMUX High-speed Transmitter is enabled. Under normal operation this condition should clear itself.     |
| IMT (High-speed) Rx FIFO Full          | The High-speed Rx FIFO has 128K bytes of data in it.                                | The high-speed link is experiencing heavy traffic conditions. The Low-speed Transmitter is disabled, experiencing heavy traffic loads, or not operating correctly. | Determine why high-speed and low-speed traffic is so heavy. Make sure the HMUX Low-speed Transmitter is enabled.                                               |
| IMT (High-speed) Rx FIFO Half Full     | The High-speed Rx FIFO has 1K bytes of data in it.                                  | The high-speed link is experiencing heavy traffic conditions. The Low-speed Transmitter is disabled, experiencing heavy traffic loads, or not operating correctly. | Determine why high-speed traffic is so heavy. Make sure the HMUX Low-speed Transmitter is enabled. Under normal operation, this condition should clear itself. |
| <b>MISC STATS</b>                      |                                                                                     |                                                                                                                                                                    |                                                                                                                                                                |
| Shelf ID UART Framing Error            | UART Framing error received by HMUX in Shelf address data stream received from OAM. | Noisy or bad clock cable from Control Shelf to shelf in which error is reported.                                                                                   | Occasionally occurs. This count should be low. Only if this count is VERY HIGH, bring it to the attention of the Customer Care Center.                         |
| Shelf ID UART                          | UART Overrun error received by HMUX in                                              | Noisy or bad clock cable from Control Shelf to                                                                                                                     | Occasionally occurs. This count should be low. Only                                                                                                            |

**Table 5-68.** Explanation of **rept-imt-info:report=hmuxerr** Statistics

| <b>IMT Statistic</b> | <b>Explanation Of Statistic</b>              | <b>Probable Causes</b>            | <b>Recommended Action</b>                                                          |
|----------------------|----------------------------------------------|-----------------------------------|------------------------------------------------------------------------------------|
| Overrun Error        | Shelf address data stream received from OAM. | shelf in which error is reported. | if this count is VERY HIGH, bring it to the attention of the Customer Care Center. |

Table 5-69 explains the **rept-imt-info:report=hiprerr** statistics.

"Excessive" is primarily determined by the operator, based upon:

- Overall system behavior
- Duration of time since the last statistics were taken
- Statistics of an individual card in relation to other cards

**Table 5-69.** Explanation of **rept-imt-info:report=hiprerr** Statistics

| <b>IMT Statistic</b>       | <b>Explanation Of Statistic</b>                                                                               | <b>Probable Causes</b>                                                      | <b>Recommended Action</b>                                                                                                                  |
|----------------------------|---------------------------------------------------------------------------------------------------------------|-----------------------------------------------------------------------------|--------------------------------------------------------------------------------------------------------------------------------------------|
| <b>LOW SPEED STATS</b>     |                                                                                                               |                                                                             |                                                                                                                                            |
| IMT Rx Packet CRC Error    | Bad Checksum in received IMT packet. Usually caused by corrupted data. Detected by hardware.                  | Card insertion, removal or boot. May occur infrequently in a normal system. | None if card has booted or was just inserted. Otherwise, call Tekelec Technical Services if count is excessive in relation to other cards. |
| IMT Rx Packet Format Error | Occurs when the Start of Message byte of the IMT packet is followed by unexpected data. Detected by hardware. | Card insertion/removal or boot.                                             | None if card has booted or was just inserted. Otherwise call Tekelec Technical Services if count is excessive in relation to other cards.  |
| IMT Rx Violation Error     | Received an illegal character from the IMT. Detected by hardware.                                             | Card insertion/removal or boot.                                             | None if card has booted or was just inserted. Otherwise, call Tekelec Technical Services if count is excessive in relation to other cards. |
| IMT Rx Command Error       | An invalid TAXI command detected in a received packet.                                                        | Packet was corrupted in the system.                                         | None.                                                                                                                                      |

Table 5-69. Explanation of `rept-imt-info:report=hiprerr` Statistics

| IMT Statistic              | Explanation Of Statistic                                             | Probable Causes                                                                                           | Recommended Action                                                                                                  |
|----------------------------|----------------------------------------------------------------------|-----------------------------------------------------------------------------------------------------------|---------------------------------------------------------------------------------------------------------------------|
| IMT Rx FIFO Full           | HIPR's IMT interface is congested. Detected by hardware.             | Indicates that data was received at a higher rate than could be processed                                 | Call Tekelec Technical Services if count is excessive in relation to other HIPR cards.                              |
| IMT Rx FIFO Half Full      | HIPR's IMT interface is becoming congested. Detected by hardware.    | Indicates that data was received at a higher rate than could be switched for a short period.              | None. FIFO half full is just an indication; no action is required.                                                  |
| IMT Tx FIFO Full           | HIPR's IMT Transmitter FIFO Full                                     | TAXI transmitter logic for this channel is not operating properly.                                        | Reset Tx FIFO. If all channels exhibit this problem, there might be an internal FPGA problem with the 125MHz clock. |
| IMT Tx FIFO Half Full      | HIPR's IMT Transmitter Half FIFO Full                                | High burst rate or multiple large packet transmissions from IXP1250.                                      | None                                                                                                                |
| <b>HIGH SPEED STATS</b>    |                                                                      |                                                                                                           |                                                                                                                     |
| IMT Rx Packet Format Error | Packet was received with a format error (for example, no EOM)        | Packet was transmitted incorrectly or was corrupted by another device in the system.                      | None                                                                                                                |
| IMT Rx Disparity Error     | Fibre Channel transceiver received a disparity error on a character. | Noisy high-speed ring.                                                                                    | This is hardware level issue. If the error persists, more detailed high-speed bus analysis is required.             |
| IMT Rx Sync Lost Error     | Fibre Channel transceiver is not receiving sync characters           | Noisy high-speed ring.<br>High-speed cable was disconnected.<br>One of the HIPRs in the ring was removed. | This is hardware level issue. If the error persists, more detailed high-speed bus analysis is required.             |
| IMT Rx Code Word Error     | Fibre Channel transceiver has received an invalid code word.         | Noisy high-speed ring.<br>Wrong command transmitted.                                                      | This is hardware level issue. If the error persists, more detailed high-speed bus analysis is required.             |

**Table 5-69.** Explanation of **rept-imt-info:report=hiprerr** Statistics

| IMT Statistic                | Explanation Of Statistic                                                                        | Probable Causes                                                                                                                                                                  | Recommended Action                                                                          |
|------------------------------|-------------------------------------------------------------------------------------------------|----------------------------------------------------------------------------------------------------------------------------------------------------------------------------------|---------------------------------------------------------------------------------------------|
| IMT Rx Packet SOM Before EOM | A Start of Message was received when an End of Message was expected from the Fibre Channel bus. | Packet was corrupted in the system (EOM lost) and has another packet appended to it.                                                                                             | None.                                                                                       |
| IMT Rx Packet CRC Error      | A packet received for this shelf contains a CRC error.                                          | Packet was transmitted incorrectly or was corrupted by another device in the system                                                                                              | Discard packet. If this problem persists, a more detailed analysis of the system is needed. |
| IMT Bypass FIFO Full         | The high-speed shelf bypass FIFO has been overflowed with data.                                 | Fibre Channel transmit logic not operating correctly. Very high simultaneous data traffic rates on the high-speed ring and on the low-speed to high-speed path within the shelf. | System is operating above limits.<br>Reduce data traffic.<br>Reset FIFO.                    |
| IMT Bypass FIFO Half Full    | The high-speed shelf bypass FIFO is half full.                                                  | Data traffic burst on the high-speed bus.                                                                                                                                        | None                                                                                        |
| IMT Rx FIFO Full             | The 128k FIFO has been overflowed with data.                                                    | IXP1250 not removing data from FPGA.                                                                                                                                             | Reset FIFO. Determine why IXP1250 not removing data.                                        |
| IMT Rx FIFO Half Full        | The 128k FIFO has gone half full with data.                                                     | Large burst of traffic on high-speed ring.                                                                                                                                       | None                                                                                        |
| IMT Tx FIFO Full             | The high-speed transmit FIFO has been overflowed with data.                                     | The Fibre Channel transmit logic is not operating.<br>The 106.25MHz is not operating.<br>The data in the FIFO is incorrectly formatted (no EOM).                                 | Reset Tx FIFO.                                                                              |
| IMT Tx FIFO Half Full        | The high-speed transmit FIFO is half full with data.                                            | High burst rate or multiple large packet transmissions from IXP1250.                                                                                                             | None                                                                                        |

**Table 5-69.** Explanation of **rept-imt-info:report=hiprerr** Statistics

| <b>IMT Statistic</b>           | <b>Explanation Of Statistic</b>                                                     | <b>Probable Causes</b>                                                                      | <b>Recommended Action</b>                                                                                                                 |
|--------------------------------|-------------------------------------------------------------------------------------|---------------------------------------------------------------------------------------------|-------------------------------------------------------------------------------------------------------------------------------------------|
| IXP Rx FIFO Full               | IXP1250 FIFO has been overflowed with data.                                         | IXP1250 not removing data from the FPGA.<br>Data coming in faster than IXP1250 can process. | Reset the IXP1250 FIFO.                                                                                                                   |
| IXP Rx FIFO Half Full          | IXP1250 FIFO is half full with data                                                 | Large burst of data on the high-speed ring.                                                 | None                                                                                                                                      |
| <b>MISC STATS</b>              |                                                                                     |                                                                                             |                                                                                                                                           |
| Shelf ID<br>UART Framing Error | UART Framing error received by HIPR in Shelf address data stream received from OAM. | Noisy or bad clock cable from Control Shelf to shelf in which error is reported.            | Occasionally happens. This count should be low. Only if this count is VERY HIGH, bring it to the attention of Tekelec Technical Services. |
| Shelf ID<br>UART Overrun Error | UART Overrun error received by HIPR in Shelf address data stream received from OAM. | Noisy or bad clock cable from Control Shelf to shelf in which error is reported.            | Occasionally happens. This count should be low. Only if this count is VERY HIGH, bring it to the attention of Tekelec Technical Services. |

Statistics displayed for the HIPR2 card are explained in Table 5-70 and Table 5-71.

**Table 5-70.** HIPR2 Statistics

| <b>IMT Statistic</b>      | <b>Explanation of statistic</b>                                                                                                                                          |
|---------------------------|--------------------------------------------------------------------------------------------------------------------------------------------------------------------------|
| Byte Count                | Number of bytes coming into the HIPR2 on the Fibre-Channel. Reported as: Running average over 60 seconds and Minimum, Average, and Maximum count updated every second.   |
| Packet Count              | Number of packets coming into the HIPR2 on the Fibre-Channel. Reported as: Running average over 60 seconds and Minimum, Average, and Maximum count updated every second. |
| Packet Signal Unit Counts | Reported as: Minimum, Average, and Maximum count updated every second for the MSU, ASU, and DSU signal units.                                                            |



**Table 5-71.** HIPR2 Advanced Statistics

| <b>IMT Statistic</b>                                                     | <b>Explanation of statistic</b>                                                                                                                                                              |
|--------------------------------------------------------------------------|----------------------------------------------------------------------------------------------------------------------------------------------------------------------------------------------|
| Bytes received from the High Speed Ring.                                 | Number of bytes coming into the HIPR2 on the high-speed ring. Sorted by the following packet types: MSU, ASU, DSU, HSU, LSSU, TSU, SSU, BSU, other, and the sum total.                       |
| Packets received from the High Speed Ring.                               | Number of packets coming into the HIPR2 on the high-speed ring. Sorted by the following packet types: MSU, ASU, DSU, HSU, LSSU, TSU, SSU, BSU, other, and the sum total.                     |
| Packets received from the High Speed ring with a safety count of 0.      | Number of packets with safety count 0 coming into the HIPR2 on the high-speed ring. Sorted by the following packet types: MSU, ASU, DSU, HSU, LSSU, TSU, SSU, BSU, other, and the sum total. |
| Packets received from the High Speed that are flagged as being in error. | Number of packets in error coming into the HIPR2 on the high-speed ring. Sorted by the following error types: CRC, Violation, Missing EOM, Missing SOM, and discarded messages.              |

## Output

**rept-imt-info:report=err**

rlghncxa03w 04-02-27 12:47:07 EST EAGLE 31.3.0

IMT Fault Isolation Error Statistics

=====

SUMMARY REPORT: Totals accumulated from all requested cards for all buckets

| Statistic           | Bus A Value | Bus B Value |
|---------------------|-------------|-------------|
| Rcv CRC Err         | 12          | 1           |
| Primary Ctl Rcv Err | 23          | 3           |
| Violation Err       | 34          | 5           |
| CPU Rcv FIFO Full   | 45          | 12          |

;

**rept-imt-info:report=err:sloc=1101:eloc=1102:mode=stats**

rlghncxa03w 04-02-27 12:47:07 EST EAGLE 31.3.0

IMT Fault Isolation Error Statistics

-----

Totals accumulated from all requested cards for each bucket

| Bucket | Statistic         | Bus A Value | Bus B Value |
|--------|-------------------|-------------|-------------|
| 00     | Rcv CRC Err       | 1           | 2           |
|        | Rcv Invalid Len   | 1012345678  | 0           |
|        | CPU Rcv FIFO Full | 23          | 123         |

01 No errors in this bucket.

.

. (data continues for each hourly time period)

;

**rept-imt-info:report=err:sloc=1101:eloc=1102:mode=full:erronly=no**

rlghncxa03w 04-02-27 12:47:07 EST EAGLE 31.3.0

IMT Fault Isolation Error Statistics

-----

Totals accumulated from all requested cards for each bucket

| Bucket | Statistic              | Bus A Value | Bus B Value |
|--------|------------------------|-------------|-------------|
| 00     | Rcv CRC Err            | 0           | 0           |
|        | Rcv Format Err         | 0           | 0           |
|        | Rcv Invalid Len        | 1           | 0           |
|        | Primary Ctl Rcv Err    | 0           | 0           |
|        | Primary Ctl Tx Err     | 0           | 0           |
|        | Primary Ctl Sanity Err | 0           | 0           |
|        | Violation Err          | 1           | 0           |
|        | IMT Rcv FIFO Half Full | 0           | 0           |
|        | IMT Rcv FIFO Full      | 0           | 0           |
|        | CPU Rcv FIFO Half Full | 0           | 0           |
|        | CPU Rcv FIFO Full      | 0           | 0           |
|        | MSU Retransmitted      | 0           | 0           |
|        | DMA Terminal Ct Intrpt | 0           | 0           |
|        | SSU Pkts Txd           | 0           | 0           |
|        | SSU Pkts Rcvd          | 0           | 0           |
| 01     | Rcv CRC Err            | 3           | 0           |
|        | Rcv Format Err         | 0           | 0           |
|        | Rcv Invalid Len        | 0           | 0           |
|        | Primary Ctl Rcv Err    | 0           | 0           |
|        | Primary Ctl Tx Err     | 0           | 0           |
|        | Primary Ctl Sanity Err | 0           | 0           |
|        | Violation Err          | 0           | 0           |
|        | IMT Rcv FIFO Half Full | 0           | 0           |
|        | IMT Rcv FIFO Full      | 0           | 0           |
|        | CPU Rcv FIFO Half Full | 0           | 0           |

```

CPU Rcv FIFO Full          0          0
MSU Retransmitted         0          0
DMA Terminal Ct Intrpt    0          0
SSU Pkts Txd              0          0
SSU Pkts Rcvd             0          0

```

(data continues for each hourly time period)

=====

SUMMARY REPORT: Totals accumulated from all requested cards for all buckets

| Statistic              | Bus A Value | Bus B Value |
|------------------------|-------------|-------------|
| Rcv CRC Err            | 3           | 0           |
| Rcv Format Err         | 0           | 0           |
| Rcv Invalid Len        | 1           | 0           |
| Primary Ctl Rcv Err    | 1012345678  | 0           |
| Primary Ctl Tx Err     | 0           | 0           |
| Primary Ctl Sanity Err | 0           | 0           |
| Violation Err          | 1           | 0           |
| IMT Rcv FIFO Half Full | 0           | 0           |
| IMT Rcv FIFO Full      | 0           | 0           |
| CPU Rcv FIFO Half Full | 23          | 0           |
| CPU Rcv FIFO Full      | 0           | 0           |
| MSU Retransmitted      | 0           | 0           |
| DMA Terminal Ct Intrpt | 0           | 0           |
| SSU Pkts Txd           | 1           | 0           |
| SSU Pkts Rcvd          | 0           | 0           |

**rept-imt-info:report=util**

```

rlghncxa03w 04-02-27 12:47:07 EST EAGLE 31.3.0
IMT Utilization Statistics

```

=====

SUMMARY REPORT: Combined statistics from all requested cards.

| Statistic              | Bus A Value | Bus B Value |
|------------------------|-------------|-------------|
| Utilization            | 10%         | 9%          |
| Pkts Tx                | 1234        | 613         |
| Avg MSU Length (bytes) | 73          | 152         |

Table 5-68 explains the meaning of each statistic that can be displayed in the **rept-imt-info:report=hmuxer r** output.

**rept-imt-info:report=hmuxerr:sbucket=0**

```

rlghncxa03w 04-02-27 12:47:07 EST EAGLE 31.3.0
HMUX SUMMARY REPORT: Summed across all requested shelves and buckets

```

HMUX Hourly Bucket Statistics

| Bucket | Low Speed Statistic          | Bus A      | Bus B      |
|--------|------------------------------|------------|------------|
| 00     | IMT Rx Packet CRC Error      | 0123456789 | 0123456789 |
|        | IMT Rx Packet Format Error   | 0123456789 | 0123456789 |
|        | IMT Rx Violation Error       | 0123456789 | 0123456789 |
|        | CPU Rx FIFO Full             | 0123456789 | 0123456789 |
|        | CPU Rx FIFO Half Full        | 0123456789 | 0123456789 |
|        | CPU Rx FIFO Empty Before SOM | 0123456789 | 0123456789 |
|        | CPU Rx FIFO Empty Before EOM | 0123456789 | 0123456789 |
|        | CPU Rx Packet SOM Before EOM | 0123456789 | 0123456789 |
|        | CPU Rx Packet CRC Error      | 0123456789 | 0123456789 |
|        | DMA terminal count           | 0123456789 | 0123456789 |
|        | CPU Tx Buffer EOB            | 0123456789 | 0123456789 |
|        | CPU Tx Buffer Full           | 0123456789 | 0123456789 |

|                           |            |            |
|---------------------------|------------|------------|
| CPU Tx FIFO Half Full     | 0123456789 | 0123456789 |
| IMT Bypass FIFO Full      | 0123456789 | 0123456789 |
| IMT Bypass FIFO Half Full | 0123456789 | 0123456789 |
| IMT Rx FIFO Full          | 0123456789 | 0123456789 |
| IMT Rx FIFO Half Full     | 0123456789 | 0123456789 |

| High Speed Statistic         | Bus A      | Bus B      |
|------------------------------|------------|------------|
| -----                        | -----      | -----      |
| IMT Rx Packet Format Error   | 0123456789 | 0123456789 |
| IMT Rx Disparity Error       | 0123456789 | 0123456789 |
| IMT Rx Sync Lost Error       | 0123456789 | 0123456789 |
| IMT Rx Code Word Error       | 0123456789 | 0123456789 |
| CPU Rx FIFO Full             | 0123456789 | 0123456789 |
| CPU Rx FIFO Half Full        | 0123456789 | 0123456789 |
| CPU Rx FIFO Empty Before SOM | 0123456789 | 0123456789 |
| CPU Rx FIFO Empty Before EOM | 0123456789 | 0123456789 |
| CPU Rx Packet SOM Before EOM | 0123456789 | 0123456789 |
| CPU Rx Packet CRC Error      | 0123456789 | 0123456789 |
| DMA terminal count           | 0123456789 | 0123456789 |
| CPU Tx Buffer EOB            | 0123456789 | 0123456789 |
| CPU Tx Buffer Full           | 0123456789 | 0123456789 |
| CPU Tx Buffer Half Full      | 0123456789 | 0123456789 |
| IMT Bypass FIFO Full         | 0123456789 | 0123456789 |
| IMT Bypass FIFO Half Full    | 0123456789 | 0123456789 |
| IMT Rx FIFO Full             | 0123456789 | 0123456789 |
| IMT Rx FIFO Half Full        | 0123456789 | 0123456789 |

| Misc Speed Statistic        | Bus A      | Bus B      |
|-----------------------------|------------|------------|
| -----                       | -----      | -----      |
| Shelf ID UART Framing Error | 0123456789 | 0123456789 |
| Shelf ID UART Overrun Error | 0123456789 | 0123456789 |

## HMUX Cumulative Statistics

=====

| Low Speed Statistic          | Bus A      | Bus B      |
|------------------------------|------------|------------|
| -----                        | -----      | -----      |
| IMT Rx Packet CRC Error      | 0123456789 | 0123456789 |
| IMT Rx Packet Format Error   | 0123456789 | 0123456789 |
| IMT Rx Violation Error       | 0123456789 | 0123456789 |
| CPU Rx FIFO Full             | 0123456789 | 0123456789 |
| CPU Rx FIFO Half Full        | 0123456789 | 0123456789 |
| CPU Rx FIFO Empty Before SOM | 0123456789 | 0123456789 |
| CPU Rx FIFO Empty Before EOM | 0123456789 | 0123456789 |
| CPU Rx Packet SOM Before EOM | 0123456789 | 0123456789 |
| CPU Rx Packet CRC Error      | 0123456789 | 0123456789 |
| DMA terminal count           | 0123456789 | 0123456789 |
| CPU Tx Buffer EOB            | 0123456789 | 0123456789 |
| CPU Tx Buffer Full           | 0123456789 | 0123456789 |
| CPU Tx FIFO Half Full        | 0123456789 | 0123456789 |
| IMT Bypass FIFO Full         | 0123456789 | 0123456789 |
| IMT Bypass FIFO Half Full    | 0123456789 | 0123456789 |
| IMT Rx FIFO Full             | 0123456789 | 0123456789 |
| IMT Rx FIFO Half Full        | 0123456789 | 0123456789 |

| High Speed Statistic         | Bus A      | Bus B      |
|------------------------------|------------|------------|
| -----                        | -----      | -----      |
| IMT Rx Packet Format Error   | 0123456789 | 0123456789 |
| IMT Rx Disparity Error       | 0123456789 | 0123456789 |
| IMT Rx Sync Lost Error       | 0123456789 | 0123456789 |
| IMT Rx Code Word Error       | 0123456789 | 0123456789 |
| CPU Rx FIFO Full             | 0123456789 | 0123456789 |
| CPU Rx FIFO Half Full        | 0123456789 | 0123456789 |
| CPU Rx FIFO Empty Before SOM | 0123456789 | 0123456789 |

```

CPU Rx FIFO Empty Before EOM 0123456789 0123456789
CPU Rx Packet SOM Before EOM 0123456789 0123456789
CPU Rx Packet CRC Error      0123456789 0123456789
DMA terminal count           0123456789 0123456789
CPU Tx Buffer EOB            0123456789 0123456789
CPU Tx Buffer Full           0123456789 0123456789
CPU Tx Buffer Half Full      0123456789 0123456789
IMT Bypass FIFO Full        0123456789 0123456789
IMT Bypass FIFO Half Full   0123456789 0123456789
IMT Rx FIFO Full            0123456789 0123456789
IMT Rx FIFO Half Full       0123456789 0123456789

Misc Speed Statistic        Bus A      Bus B
-----
Shelf ID UART Framing Error 0123456789 0123456789
Shelf ID UART Overrun Error 0123456789 0123456789
    
```

```

rlghncxa03w 04-02-27 12:47:07 EST EAGLE 31.3.0
HMUX Maintenance Statistics
    
```

```

=====
HMUX SUMMARY REPORT: Summed across all requested shelves and buckets
    
```

| Low Speed Statistic          | Bucket Summary |            | Cumulative |            |
|------------------------------|----------------|------------|------------|------------|
|                              | Bus A          | Bus B      | Bus A      | Bus B      |
| IMT Rx Packet CRC Error      | 0123456789     | 0123456789 | 0123456789 | 0987654321 |
| IMT Rx Packet Format Error   | 0123456789     | 0123456789 | 0123456789 | 0987654321 |
| IMT Rx Violation Error       | 0123456789     | 0123456789 | 0123456789 | 0987654321 |
| CPU Rx FIFO Full             | 0123456789     | 0123456789 | 0123456789 | 0987654321 |
| CPU Rx FIFO Half Full        | 0123456789     | 0123456789 | 0123456789 | 0987654321 |
| CPU Rx FIFO Empty Before SOM | 0123456789     | 0123456789 | 0123456789 | 0987654321 |
| CPU Rx FIFO Empty Before EOM | 0123456789     | 0123456789 | 0123456789 | 0987654321 |
| CPU Rx Packet SOM Before EOM | 0123456789     | 0123456789 | 0123456789 | 0987654321 |
| CPU Rx Packet CRC Error      | 0123456789     | 0123456789 | 0123456789 | 0987654321 |
| CPU Tx Buffer EOB            | 0123456789     | 0123456789 | 0123456789 | 0987654321 |
| CPU Tx Buffer Full           | 0123456789     | 0123456789 | 0123456789 | 0987654321 |
| CPU Tx FIFO Half Full        | 0123456789     | 0123456789 | 0123456789 | 0987654321 |
| IMT Bypass FIFO Full         | 0123456789     | 0123456789 | 0123456789 | 0987654321 |
| IMT Bypass FIFO Half Full    | 0123456789     | 0123456789 | 0123456789 | 0987654321 |
| IMT Rx FIFO Full             | 0123456789     | 0123456789 | 0123456789 | 0987654321 |
| IMT Rx FIFO Half Full        | 0123456789     | 0123456789 | 0123456789 | 0987654321 |
| IMT Rx FIFO Sanity           | 0123456789     | 0123456789 | 0123456789 | 0987654321 |

| High Speed Statistic         | Bucket Summary |            | Cumulative |            |
|------------------------------|----------------|------------|------------|------------|
|                              | Bus A          | Bus B      | Bus A      | Bus B      |
| IMT Rx Packet Format Error   | 0123456789     | 0123456789 | 0123456789 | 0987654321 |
| IMT Rx Disparity Error       | 0123456789     | 0123456789 | 0123456789 | 0987654321 |
| IMT Rx Sync Lost Error       | 0123456789     | 0123456789 | 0123456789 | 0987654321 |
| IMT Rx Code Word Error       | 0123456789     | 0123456789 | 0123456789 | 0987654321 |
| CPU Rx FIFO Full             | 0123456789     | 0123456789 | 0123456789 | 0987654321 |
| CPU Rx FIFO Half Full        | 0123456789     | 0123456789 | 0123456789 | 0987654321 |
| CPU Rx FIFO Empty Before SOM | 0123456789     | 0123456789 | 0123456789 | 0987654321 |
| CPU Rx FIFO Empty Before EOM | 0123456789     | 0123456789 | 0123456789 | 0987654321 |
| CPU Rx Packet SOM Before EOM | 0123456789     | 0123456789 | 0123456789 | 0987654321 |
| CPU Rx Packet CRC Error      | 0123456789     | 0123456789 | 0123456789 | 0987654321 |
| CPU Tx Buffer EOB            | 0123456789     | 0123456789 | 0123456789 | 0987654321 |
| CPU Tx Buffer Full           | 0123456789     | 0123456789 | 0123456789 | 0987654321 |
| CPU Tx Buffer Half Full      | 0123456789     | 0123456789 | 0123456789 | 0987654321 |
| IMT Bypass FIFO Full         | 0123456789     | 0123456789 | 0123456789 | 0987654321 |
| IMT Bypass FIFO Half Full    | 0123456789     | 0123456789 | 0123456789 | 0987654321 |
| IMT Bypass FIFO Sanity       | 0123456789     | 0123456789 | 0123456789 | 0987654321 |
| IMT Rx FIFO Full             | 0123456789     | 0123456789 | 0123456789 | 0987654321 |

```

IMT Rx FIFO Half Full          0123456789 0123456789 0123456789 0987654321

Misc Statistic                  Bucket Summary                Cumulative
                               Bus A      Bus B                Bus A      Bus B
-----
Shelf ID UART Framing Error    0123456789 0123456789 0123456789 0987654321
Shelf ID UART Overrun Error    0123456789 0123456789 0123456789 0987654321
    
```

;
  
Table 5-69 explains the meaning of each statistic that can be displayed in the **rept-imt-info:report=hiprerr** output.

**rept-imt-info:report=hiprerr:sbucket=0**

```

tekelecstp 05-01-12 14:01:34 EST EAGLE 33.0.0
HIPR Maintenance Statistics
    
```

```

=====
HIPR SUMMARY REPORT: Summed across all requested shelves and buckets
    
```

HIPR Hourly Bucket Statistics

```

=====
BUCKET  LOC  Low Speed Statistic                Bus A      Bus B
00      ---  -----
IMT Rx Packet CRC Error            0123456789 0123456789
IMT Rx Packet Format Error          0123456789 0123456789
IMT Rx Violation Error              0123456789 0123456789
IMT Rx Command Error                0123456789 0123456789
IMT Rx Packet CRC Error            0123456789 0123456789
IMT Rx FIFO Full                    0123456789 0123456789
IMT Rx FIFO Half Full               0123456789 0123456789
IMT Tx FIFO Full                    0123456789 0123456789
IMT Tx FIFO Half Full               0123456789 0123456789

High Speed Statistic                Bus A      Bus B
-----
IMT Rx Packet Format Err            0123456789 0123456789
IMT Rx Disparity Error              0123456789 0123456789
IMT Rx Sync Lost Error              0123456789 0123456789
IMT Rx Code Word Error              0123456789 0123456789
IMT Rx Packet SOM Before EOM        0123456789 0123456789
IMT Rx Packet CRC Error            0123456789 0123456789
IMT Bypass FIFO Full                0123456789 0123456789
IMT Bypass FIFO Half Full           0123456789 0123456789
IMT Rx FIFO Full                    0123456789 0123456789
IMT Rx FIFO Half Full               0123456789 0123456789
IMT Tx FIFO Full                    0123456789 0123456789
IMT Tx FIFO Half Full               0123456789 0123456789
IXP Rx FIFO Full                    0123456789 0123456789
IXP Rx FIFO Half Full               0123456789 0123456789

Misc Statistic                      Bus A      Bus B
-----
Shelf ID UART Framing Error          0123456789 0123456789
Shelf ID UART Overrun Error          0123456789 0123456789
    
```

HIPR CUMULATIVE Statistics

```

=====
Low Speed Statistic                Bus A      Bus B
-----
IMT Rx Packet CRC Error            0123456789 0123456789
IMT Rx Packet Format Error          0123456789 0123456789
IMT Rx Violation Error              0123456789 0123456789
IMT Rx Command Error                0123456789 0123456789
IMT Rx Packet CRC Error            0123456789 0123456789
    
```

```

IMT Rx FIFO Full          0123456789 0123456789
IMT Rx FIFO Half Full    0123456789 0123456789
IMT Tx FIFO Full         0123456789 0123456789
IMT Tx FIFO Half Full    0123456789 0123456789

High Speed Statistic      Bus A      Bus B
-----
IMT Rx Packet Format Err  0123456789 0123456789
IMT Rx Disparity Error   0123456789 0123456789
IMT Rx Sync Lost Error   0123456789 0123456789
IMT Rx Code Word Error   0123456789 0123456789
IMT Rx Packet SOM Before EOM 0123456789 0123456789
IMT Rx Packet CRC Error  0123456789 0123456789
IMT Bypass FIFO Full     0123456789 0123456789
IMT Bypass FIFO Half Full 0123456789 0123456789
IMT Rx FIFO Full         0123456789 0123456789
IMT Rx FIFO Half Full    0123456789 0123456789
IMT Tx FIFO Full         0123456789 0123456789
IMT Tx FIFO Half Full    0123456789 0123456789
IXP Rx FIFO Full         0123456789 0123456789
IXP Rx FIFO Half Full    0123456789 0123456789

Misc Statistic            Bus A      Bus B
-----
Shelf ID UART Framing Error 0123456789 0123456789
Shelf ID UART Overrun Error 0123456789 0123456789
;

```

Table 5-69 explains the meaning of each statistic that can be displayed in the **rept-  
info:report=hiprerr** output.

**rept-  
imt-**

**info:report=hiprerr:sshelf=1100:sslot=1:eslot=2:sbucket=0**

```

tekelecstp 05-01-12 14:01:34 EST  EAGLE 33.0.0
HIPR Maintenance Statistics
;
=====
HIPR SUMMARY REPORT: Summed across all requested shelves and buckets

HIPR Hourly Bucket Statistics
=====

BUCKET LOC Low Speed Statistic      Bus A      Bus B
  00    1101 -----
          IMT Rx Packet CRC Error    0123456789 0123456789
          IMT Rx Packet Format Error  0123456789 0123456789
          IMT Rx Violation Error      0123456789 0123456789
          IMT Rx Command Error        0123456789 0123456789
          IMT Rx FIFO Full            0123456789 0123456789
          IMT Rx FIFO Half Full       0123456789 0123456789
          IMT Tx FIFO Full            0123456789 0123456789
          IMT Tx FIFO Half Full       0123456789 0123456789

BUCKET LOC Low Speed Statistic      Bus A      Bus B
  00    1102 -----
          IMT Rx Packet CRC Error    0123456789 0123456789
          IMT Rx Packet Format Error  0123456789 0123456789
          IMT Rx Violation Error      0123456789 0123456789
          IMT Rx Command Error        0123456789 0123456789
          IMT Rx FIFO Full            0123456789 0123456789
          IMT Rx FIFO Half Full       0123456789 0123456789
          IMT Tx FIFO Full            0123456789 0123456789
          IMT Tx FIFO Half Full       0123456789 0123456789

High Speed Statistic      Bus A      Bus B

```

|                              | Bus A      | Bus B      |
|------------------------------|------------|------------|
| IMT Rx Packet Format Err     | 0123456789 | 0123456789 |
| IMT Rx Disparity Error       | 0123456789 | 0123456789 |
| IMT Rx Sync Lost Error       | 0123456789 | 0123456789 |
| IMT Rx Code Word Error       | 0123456789 | 0123456789 |
| IMT Rx Packet SOM Before EOM | 0123456789 | 0123456789 |
| IMT Rx Packet CRC Error      | 0123456789 | 0123456789 |
| IMT Bypass FIFO Full         | 0123456789 | 0123456789 |
| IMT Bypass FIFO Half Full    | 0123456789 | 0123456789 |
| IMT Rx FIFO Full             | 0123456789 | 0123456789 |
| IMT Rx FIFO Half Full        | 0123456789 | 0123456789 |
| IMT Tx FIFO Full             | 0123456789 | 0123456789 |
| IMT Tx FIFO Half Full        | 0123456789 | 0123456789 |
| IXP Rx FIFO Full             | 0123456789 | 0123456789 |
| IXP Rx FIFO Half Full        | 0123456789 | 0123456789 |
| Misc Statistic               | Bus A      | Bus B      |
| Shelf ID UART Framing Error  | 0123456789 | 0123456789 |
| Shelf ID UART Overrun Error  | 0123456789 | 0123456789 |

HIPR CUMULATIVE Statistics

| Low Speed Statistic          |            |            |
|------------------------------|------------|------------|
|                              | Bus A      | Bus B      |
| IMT Rx Packet CRC Error      | 0123456789 | 0123456789 |
| IMT Rx Packet Format Error   | 0123456789 | 0123456789 |
| IMT Rx Violation Error       | 0123456789 | 0123456789 |
| IMT Rx Command Error         | 0123456789 | 0123456789 |
| IMT Rx FIFO Full             | 0123456789 | 0123456789 |
| IMT Rx FIFO Half Full        | 0123456789 | 0123456789 |
| IMT Tx FIFO Full             | 0123456789 | 0123456789 |
| IMT Tx FIFO Half Full        | 0123456789 | 0123456789 |
| High Speed Statistic         |            |            |
| IMT Rx Packet Format Err     | 0123456789 | 0123456789 |
| IMT Rx Disparity Error       | 0123456789 | 0123456789 |
| IMT Rx Sync Lost Error       | 0123456789 | 0123456789 |
| IMT Rx Code Word Error       | 0123456789 | 0123456789 |
| IMT Rx Packet SOM Before EOM | 0123456789 | 0123456789 |
| IMT Rx Packet CRC Error      | 0123456789 | 0123456789 |
| IMT Bypass FIFO Full         | 0123456789 | 0123456789 |
| IMT Bypass FIFO Half Full    | 0123456789 | 0123456789 |
| IMT Rx FIFO Full             | 0123456789 | 0123456789 |
| IMT Rx FIFO Half Full        | 0123456789 | 0123456789 |
| IMT Tx FIFO Full             | 0123456789 | 0123456789 |
| IMT Tx FIFO Half Full        | 0123456789 | 0123456789 |
| IXP Rx FIFO Full             | 0123456789 | 0123456789 |
| IXP Rx FIFO Half Full        | 0123456789 | 0123456789 |
| Misc Statistic               | Bus A      | Bus B      |
| Shelf ID UART Framing Error  | 0123456789 | 0123456789 |
| Shelf ID UART Overrun Error  | 0123456789 | 0123456789 |

rept-imt-info:report=hipr2err:sbucket=0

tekelecstp 09-06-12 14:01:34 EST EAGLE 41.1.0  
 HIPR2 Summary Report: Summed across all requested cards for each bucket

HIPR2 Hourly Bucket Statistics

Bucket Loc Low Speed Statistic BUS A Value BUS B Value



Commands

rept-imt-info

|    |                                |             |             |
|----|--------------------------------|-------------|-------------|
| 00 | IMT Rx Packet CRC Error        | 0123456789  | 0123456789  |
|    | IMT Rx Packet Format Error     | 0123456789  | 0123456789  |
|    | IMT Rx Violation Error         | 0123456789  | 0123456789  |
|    | IMT Rx Command Error           | 0123456789  | 0123456789  |
|    | IMT Rx FIFO Full               | 0123456789  | 0123456789  |
|    | IMT Rx FIFO Half Full          | 0123456789  | 0123456789  |
|    | IMT Tx FIFO Full               | 0123456789  | 0123456789  |
|    | IMT Tx FIFO Half Full          | 0123456789  | 0123456789  |
|    | High Speed Statistic           | BUS A Value | BUS B Value |
|    | IMT Rx Packet Format Error     | 0123456789  | 0123456789  |
|    | IMT Rx Disparity Error         | 0123456789  | 0123456789  |
|    | IMT Rx Sync Lost Error         | 0123456789  | 0123456789  |
|    | IMT Rx Code Word Error         | 0123456789  | 0123456789  |
|    | IMT Rx Packet SOM Before EOM   | 0123456789  | 0123456789  |
|    | IMT Rx Packet CRC Error        | 0123456789  | 0123456789  |
|    | IMT Bypass FIFO Full           | 0123456789  | 0123456789  |
|    | IMT Bypass FIFO Half Full      | 0123456789  | 0123456789  |
|    | IMT Rx FIFO Full               | 0123456789  | 0123456789  |
|    | IMT Rx FIFO Half Full          | 0123456789  | 0123456789  |
|    | IMT Tx FIFO Full               | 0123456789  | 0123456789  |
|    | IMT Tx FIFO Half Full          | 0123456789  | 0123456789  |
|    | IXP Rx FIFO Full               | 0123456789  | 0123456789  |
|    | IXP Rx FIFO Half Full          | 0123456789  | 0123456789  |
|    | IMT Rx Byte Per Minute AVG     | 0123456789  | 0123456789  |
|    | IMT Rx Byte Per Second AVG     | 0123456789  | 0123456789  |
|    | IMT Tx Byte Per Minute AVG     | 0123456789  | 0123456789  |
|    | IMT Tx Byte Per Second AVG     | 0123456789  | 0123456789  |
|    | IMT Rx Packet Per Minute AVG   | 0123456789  | 0123456789  |
|    | IMT Rx Packet Per Second AVG   | 0123456789  | 0123456789  |
|    | IMT Tx Packet Per Minute AVG   | 0123456789  | 0123456789  |
|    | IMT Tx Packet Per Second AVG   | 0123456789  | 0123456789  |
|    | IMT Rx Errors Per Minute AVG   | 0123456789  | 0123456789  |
|    | IMT Rx Errors Per Second AVG   | 0123456789  | 0123456789  |
|    | IMT Tx Errors Per Minute AVG   | 0123456789  | 0123456789  |
|    | IMT Tx Errors Per Second AVG   | 0123456789  | 0123456789  |
|    | IMT Rx Safety Per Minute AVG   | 0123456789  | 0123456789  |
|    | IMT Rx Safety Per Second AVG   | 0123456789  | 0123456789  |
|    | IMT Rx MSU Byte Per Minute AVG | 0123456789  | 0123456789  |
|    | IMT Rx MSU Byte Per Second AVG | 0123456789  | 0123456789  |
|    | IMT Rx ASU Byte Per Minute AVG | 0123456789  | 0123456789  |
|    | IMT Rx ASU Byte Per Second AVG | 0123456789  | 0123456789  |
|    | IMT Rx DSU Byte Per Minute AVG | 0123456789  | 0123456789  |
|    | IMT Rx DSU Byte Per Second AVG | 0123456789  | 0123456789  |
|    | IMT Rx MSU Byte Count          | 0123456789  | 0123456789  |
|    | IMT Rx ASU Byte Count          | 0123456789  | 0123456789  |
|    | IMT Rx DSU Byte Count          | 0123456789  | 0123456789  |
|    | IMT Rx HSU Byte Count          | 0123456789  | 0123456789  |
|    | IMT Rx LSSU Byte Count         | 0123456789  | 0123456789  |
|    | IMT Rx TSU Byte Count          | 0123456789  | 0123456789  |
|    | IMT Rx SSU Byte Count          | 0123456789  | 0123456789  |
|    | IMT Rx BSU Byte Count          | 0123456789  | 0123456789  |
|    | IMT Rx Byte Other              | 0123456789  | 0123456789  |
|    | IMT Rx Total Byte Count        | 0123456789  | 0123456789  |
|    | IMT Rx MSU Packet Count        | 0123456789  | 0123456789  |
|    | IMT Rx ASU Packet Count        | 0123456789  | 0123456789  |
|    | IMT Rx DSU Packet Count        | 0123456789  | 0123456789  |
|    | IMT Rx HSU Packet Count        | 0123456789  | 0123456789  |
|    | IMT Rx LSSU Packet Count       | 0123456789  | 0123456789  |
|    | IMT Rx TSU Packet Count        | 0123456789  | 0123456789  |
|    | IMT Rx SSU Packet Count        | 0123456789  | 0123456789  |
|    | IMT Rx BSU Packet Count        | 0123456789  | 0123456789  |
|    | IMT Rx Packet Other            | 0123456789  | 0123456789  |

|                                  |             |             |
|----------------------------------|-------------|-------------|
| IMT Rx Total Packet Count        | 0123456789  | 0123456789  |
| IMT Rx MSU Packet Safety Count   | 0123456789  | 0123456789  |
| IMT Rx ASU Packet Safety Count   | 0123456789  | 0123456789  |
| IMT Rx DSU Packet Safety Count   | 0123456789  | 0123456789  |
| IMT Rx HSU Packet Safety Count   | 0123456789  | 0123456789  |
| IMT Rx LSSU Packet Safety Count  | 0123456789  | 0123456789  |
| IMT Rx TSU Packet Safety Count   | 0123456789  | 0123456789  |
| IMT Rx SSU Packet Safety Count   | 0123456789  | 0123456789  |
| IMT Rx BSU Packet Safety Count   | 0123456789  | 0123456789  |
| IMT Rx Other Packet Safety Count | 0123456789  | 0123456789  |
| IMT Rx Total Packet Safety Count | 0123456789  | 0123456789  |
| IMT Rx Packet Violation Error    | 0123456789  | 0123456789  |
| IMT Rx Packet CRC Error          | 0123456789  | 0123456789  |
| IMT Rx Packet Format Error       | 0123456789  | 0123456789  |
| IMT Rx Packet Discard Error      | 0123456789  | 0123456789  |
| IMT Tx Packet Format Error       | 0123456789  | 0123456789  |
| IMT Tx Packet Discard Error      | 0123456789  | 0123456789  |
| Misc Speed Statistic             | BUS A Value | BUS B Value |
| -----                            | -----       | -----       |
| Shelf ID UART Framing Error      | 0123456789  | 0123456789  |
| Shelf ID UART Overrun Error      | 0123456789  | 0123456789  |

HIPR2 CUMULATIVE Statistics

```

=====
Low Speed Statistic
-----
IMT Rx Packet CRC Error          0123456789  0123456789
IMT Rx Packet Format Error       0123456789  0123456789
IMT Rx Violation Error          0123456789  0123456789
IMT Rx Command Error            0123456789  0123456789
IMT Rx FIFO Full                 0123456789  0123456789
IMT Rx FIFO Half Full           0123456789  0123456789
IMT Tx FIFO Full                 0123456789  0123456789
IMT Tx FIFO Half Full           0123456789  0123456789

High Speed Statistic
-----
IMT Rx Packet Format Error       0123456789  0123456789
IMT Rx Disparity Error          0123456789  0123456789
IMT Rx Sync Lost Error          0123456789  0123456789
IMT Rx Code Word Error          0123456789  0123456789
IMT Rx Packet SOM Before EOM    0123456789  0123456789
IMT Rx Packet CRC Error         0123456789  0123456789
IMT Bypass FIFO Full            0123456789  0123456789
IMT Bypass FIFO Half Full       0123456789  0123456789
IMT Rx FIFO Full                 0123456789  0123456789
IMT Rx FIFO Half Full           0123456789  0123456789
IMT Tx FIFO Full                 0123456789  0123456789
IMT Tx FIFO Half Full           0123456789  0123456789
IXP Rx FIFO Full                 0123456789  0123456789
IXP Rx FIFO Half Full           0123456789  0123456789
IMT Rx Byte Per Minute AVG      0123456789  0123456789
IMT Rx Byte Per Second AVG      0123456789  0123456789
IMT Tx Byte Per Minute AVG      0123456789  0123456789
IMT Tx Byte Per Second AVG      0123456789  0123456789
IMT Rx Packet Per Minute AVG    0123456789  0123456789
IMT Rx Packet Per Second AVG    0123456789  0123456789
IMT Tx Packet Per Minute AVG    0123456789  0123456789
IMT Tx Packet Per Second AVG    0123456789  0123456789
IMT Rx Errors Per Minute AVG    0123456789  0123456789
IMT Rx Errors Per Second AVG    0123456789  0123456789
IMT Tx Errors Per Minute AVG    0123456789  0123456789
=====

```

|                                  |             |             |
|----------------------------------|-------------|-------------|
| IMT Tx Errors Per Second AVG     | 0123456789  | 0123456789  |
| IMT Rx Safety Per Minute AVG     | 0123456789  | 0123456789  |
| IMT Rx Safety Per Second AVG     | 0123456789  | 0123456789  |
| IMT Rx MSU Byte Per Minute AVG   | 0123456789  | 0123456789  |
| IMT Rx MSU Byte Per Second AVG   | 0123456789  | 0123456789  |
| IMT Rx ASU Byte Per Minute AVG   | 0123456789  | 0123456789  |
| IMT Rx ASU Byte Per Second AVG   | 0123456789  | 0123456789  |
| IMT Rx DSU Byte Per Minute AVG   | 0123456789  | 0123456789  |
| IMT Rx DSU Byte Per Second AVG   | 0123456789  | 0123456789  |
| IMT Rx MSU Byte Count            | 0123456789  | 0123456789  |
| IMT Rx ASU Byte Count            | 0123456789  | 0123456789  |
| IMT Rx DSU Byte Count            | 0123456789  | 0123456789  |
| IMT Rx HSU Byte Count            | 0123456789  | 0123456789  |
| IMT Rx LSSU Byte Count           | 0123456789  | 0123456789  |
| IMT Rx TSU Byte Count            | 0123456789  | 0123456789  |
| IMT Rx SSU Byte Count            | 0123456789  | 0123456789  |
| IMT Rx BSU Byte Count            | 0123456789  | 0123456789  |
| IMT Rx Byte Other                | 0123456789  | 0123456789  |
| IMT Rx Total Byte Count          | 0123456789  | 0123456789  |
| IMT Rx MSU Packet Count          | 0123456789  | 0123456789  |
| IMT Rx ASU Packet Count          | 0123456789  | 0123456789  |
| IMT Rx DSU Packet Count          | 0123456789  | 0123456789  |
| IMT Rx HSU Packet Count          | 0123456789  | 0123456789  |
| IMT Rx LSSU Packet Count         | 0123456789  | 0123456789  |
| IMT Rx TSU Packet Count          | 0123456789  | 0123456789  |
| IMT Rx SSU Packet Count          | 0123456789  | 0123456789  |
| IMT Rx BSU Packet Count          | 0123456789  | 0123456789  |
| IMT Rx Packet Other              | 0123456789  | 0123456789  |
| IMT Rx Total Packet Count        | 0123456789  | 0123456789  |
| IMT Rx MSU Packet Safety Count   | 0123456789  | 0123456789  |
| IMT Rx ASU Packet Safety Count   | 0123456789  | 0123456789  |
| IMT Rx DSU Packet Safety Count   | 0123456789  | 0123456789  |
| IMT Rx HSU Packet Safety Count   | 0123456789  | 0123456789  |
| IMT Rx LSSU Packet Safety Count  | 0123456789  | 0123456789  |
| IMT Rx TSU Packet Safety Count   | 0123456789  | 0123456789  |
| IMT Rx SSU Packet Safety Count   | 0123456789  | 0123456789  |
| IMT Rx BSU Packet Safety Count   | 0123456789  | 0123456789  |
| IMT Rx Other Packet Safety Count | 0123456789  | 0123456789  |
| IMT Rx Total Packet Safety Count | 0123456789  | 0123456789  |
| IMT Rx Packet Violation Error    | 0123456789  | 0123456789  |
| IMT Rx Packet CRC Error          | 0123456789  | 0123456789  |
| IMT Rx Packet Format Error       | 0123456789  | 0123456789  |
| IMT Rx Packet Discard Error      | 0123456789  | 0123456789  |
| IMT Tx Packet Format Error       | 0123456789  | 0123456789  |
| IMT Tx Packet Discard Error      | 0123456789  | 0123456789  |
| Misc Speed Statistic             | BUS A Value | BUS B Value |
| -----                            | -----       | -----       |
| Shelf ID UART Framing Error      | 0123456789  | 0123456789  |
| Shelf ID UART Overrun Error      | 0123456789  | 0123456789  |

;

**Legend**

IMT Statistics:

**BUCKET**—The hourly time periods (*buckets*) for which a report was requested.

**STATISTIC**—The error statistic type for the IMT buses A and B.

**BUS A VALUE**—The number of occurrences of the type of error displayed in the STATISTIC column for the IMT bus A.

**BUS B VALUE**—The number of occurrences of the type of error displayed in the STATISTIC column for the IMT bus B.

**LOW SPEED STATISTIC**—The error statistic type for the low speed 125 Mbps secondary rings with HMUX cards installed on buses A (xy09 card locations) and B (xy10 card locations).

**HIGH SPEED STATISTIC**—The error statistic type for the high-speed 1 Gbps primary ring with HMUX cards installed on buses A (xy09 card locations) and B (xy10 card locations).

**MISC SPEED STATISTICS**—Shelf ID Universal Asynchronous Receiver Transmitter (UART) error counts on the HMUX cards installed on buses A (xy09 card locations) and B (xy10 card locations).

**BUCKET SUMMARY**—The error count for each parameter for one hour for HMUX cards installed on buses A (xy09 card locations) and B (xy10 card locations). (The count is for the most recent part of an hour if the card was booted within an hour of executing the **rept-imt-info** command.)

**CUMULATIVE**—The running total error count for each parameter since card initialization for HMUX cards installed on buses A (xy09 card locations) and B (xy10 card locations).

#### HMUX Statistics:

**BUCKET**—The hourly time periods (*buckets*) for which a report was requested.

**LOW SPEED STATISTIC**—The error statistic type for the low speed 125 Mbps secondary rings with HMUX cards installed on buses A (xy09 card locations) and B (xy10 card locations).

**HIGH SPEED STATISTIC**—The error statistic type for the high-speed 1 Gbps primary ring with HMUX cards installed on buses A (xy09 card locations) and B (xy10 card locations).

**MISC SPEED STATISTIC**—The miscellaneous error statistic type.

**BUS A**—The number of occurrences of the type of error displayed in the **STATISTIC** column for the IMT bus A.

**BUS B**—The number of occurrences of the type of error displayed in the **STATISTIC** column for the IMT bus B.

#### HIPR Statistics:

**BUCKET**—The hourly time periods (*buckets*) for which a report was requested.

**LOC**—The card location (shelf and slot) for which information is displayed.

**LOW SPEED STATISTIC**—The error statistic type for the low speed 125 Mbps secondary rings with HMUX cards installed on buses A (xy09 card locations) and B (xy10 card locations).

**HIGH SPEED STATISTIC**—The error statistic type for the high-speed 1 Gbps primary ring with HMUX cards installed on buses A (xy09 card locations) and B (xy10 card locations).

**MISC SPEED STATISTIC**—The miscellaneous error statistic type.

**BUS A**—The number of occurrences of the type of error displayed in the **STATISTIC** column for the IMT bus A.

**BUS B**—The number of occurrences of the type of error displayed in the **STATISTIC** column for the IMT bus B.

#### HIPR2 Statistics:

**BUCKET**—The hourly time periods (*buckets*) for which a report was requested.

**LOC**—The card location (shelf and slot) for which information is displayed.

**LOW SPEED STATISTIC**—The error statistic type for the low speed 125 Mbps secondary rings with HMUX cards installed on buses A (xy09 card locations) and B (xy10 card locations).

**HIGH SPEED STATISTIC**—The error statistic type for the high-speed 1 Gbps primary ring with HMUX cards installed on buses A (xy09 card locations) and B (xy10 card locations).

**MISC SPEED STATISTIC**—The miscellaneous error statistic type.

**BUS A**—The number of occurrences of the type of error displayed in the STATISTIC column for the IMT bus A.

**BUS B**—The number of occurrences of the type of error displayed in the STATISTIC column for the IMT bus B.

## rept-imt-lvl1

## Report IMT Level 1

Use this command to display the IMT level 1 statistics for a card or a range of cards. If more than one card is specified, a summary report of totals for all cards can be generated.

**Keyword:** `rept-imt-lvl1`

**Related Commands:** `clr-imt-stats`, `conn-imt`, `disc-imt`, `rept-imt-info`, `rept-imt-lvl2`, `rept-stat-imt`, `rmv-imt`, `rst-imt`, `tst-imt`

**Command Class:** System Maintenance

### Parameters

**:e=** (optional)

End address. This parameter specifies the IMT address of the last card in the range. A decimal value or a hexadecimal value can be specified for this parameter (see Table 5-72 to map the values by card location).

**Range:** **0-251**

The value can be specified in decimal (**0–251**) or hexadecimal (**h'00–h'fb**).

**Default:** If the start address (**s**) value is specified, the **e** parameter default value is the specified **s** parameter value.

If the **s** parameter is not specified, the **e** parameter is not specified and the **sloc** parameter must be specified.

**:eloc=** (optional)

End location. Specifies the card location of the last card in the range.

**Range:** **1101-1108, 1111-1113, 1115, 1201-1208, 1211-1218, 1301-1308, 1311-1318, 2101-2108, 2111-2118, 2201-2208, 2211-2218, 2301-2308, 2311-2318, 3101-3108, 3111-3118, 3201-3208, 3211-3218, 3301-3308, 3311-3318, 4101-4108, 4111-4118, 4201-4208, 4211-4218, 4301-4308, 4311-4318, 5101-5108, 5111-5118, 5201-5208, 5211-5218, 5301-5308, 5311-5318, 6101-6108, 6111-6118**

**Default:** If **sloc** is specified—current **sloc** value; displays information for one card

If **sloc** is not specified—**1115**, which corresponds to IMT address 251 (**e=251**); displays information for entire range of locations.

**:r=** (optional)

Report type value

**Range:** **full, stats, summary**

**full** — Displays information for each card along with a summary report.

**stats** — Displays only individual card statistics.

**summary** — Displays the summary portion of the report.

**Default:** **full**

**:s=** (optional)

Start address. This parameter specifies the IMT address of the first (or only) card in the range. A decimal value or a hexadecimal value can be specified for this parameter (see Table 5-72 to map the values by card location).

**Range:** **0-251**

The value can be specified in decimal (**0–251**) or hexadecimal (**h'00–h'fb**).

**:sloc=** (optional)

Start location. Specifies the card location of the first card in the range.

**Range:** 1101-1108, 1111-1113, 1115, 1201-1208, 1211-1218, 1301-1308, 1311-1318, 2101-2108, 2111-2118, 2201-2208, 2211-2218, 2301-2308, 2311-2318, 3101-3108, 3111-3118, 3201-3208, 3211-3218, 3301-3308, 3311-3318, 4101-4108, 4111-4118, 4201-4208, 4211-4218, 4301-4308, 4311-4318, 5101-5108, 5111-5118, 5201-5208, 5211-5218, 5301-5308, 5311-5318, 6101-6108, 6111-6118

**Default:** If **eloc** is specified—current **eloc** value  
If **eloc** is not specified—1201, which corresponds to IMT address 0 (**s=0**).

**:trm=** (optional)

The serial port (printer location) where the report is to be sent.

**Range:** 1-16

**Default:** Report displays on the terminal where the command was issued

### Example

```
rept-imt-lvl1:s=00:e=01
```

### Dependencies

Only one report status command can be in progress at a time.

Either the start address (**s** parameter) or the start location (**sloc** parameter) must be specified.

This command cannot be entered during IMT statistics collection following an hourly boundary.

The **rept-imt-lvl1** command cannot be entered if any of the following commands is running: **clr-imt-stats**, **rept-imt-info**, **rept-imt-lvl2**, **tst-imt**.

If the **s** and **e** parameters are specified, the **sloc** and **eloc** parameters cannot be specified; conversely, if the **sloc** and **eloc** parameters are specified, the **s** and **e** parameters cannot be specified.

A card location that is valid and defined in the database must be specified.

### Notes

Table 5-72 maps each card location to the decimal and hexadecimal "Converting ITU National Point Code Formats" values that can be specified for the **s** and **e** parameters.

**Table 5-72.** Hexadecimal/Decimal Values for **s** and **e** parameters

| Card Location      | Hexadecimal Value | Decimal Value | Card Location | Hexadecimal Value | Decimal Value |
|--------------------|-------------------|---------------|---------------|-------------------|---------------|
| Control Shelf 11   |                   |               |               |                   |               |
| 1101               | h'f0              | 240           | 1102          | h'f1              | 241           |
| 1103               | h'f2              | 242           | 1104          | h'f3              | 243           |
| 1105               | h'f4              | 244           | 1106          | h'f5              | 245           |
| 1107               | h'f6              | 246           | 1108          | h'f7              | 247           |
| 1111               | h'f8              | 248           | 1112          | h'f9              | 249           |
| 1113               | h'fa              | 250           | 1115          | h'fb              | 251           |
| Extension Shelf 12 |                   |               |               |                   |               |

**Table 5-72.** Hexadecimal/Decimal Values for s and e parameters

| <b>Card Location</b>      | <b>Hexadecimal Value</b> | <b>Decimal Value</b> | <b>Card Location</b> | <b>Hexadecimal Value</b> | <b>Decimal Value</b> |
|---------------------------|--------------------------|----------------------|----------------------|--------------------------|----------------------|
| 1201                      | h'00                     | 0                    | 1202                 | h'01                     | 1                    |
| 1203                      | h'02                     | 2                    | 1204                 | h'03                     | 3                    |
| 1205                      | h'04                     | 4                    | 1206                 | h'05                     | 5                    |
| 1207                      | h'06                     | 6                    | 1208                 | h'07                     | 7                    |
| 1211                      | h'08                     | 8                    | 1212                 | h'09                     | 9                    |
| 1213                      | h'0a                     | 10                   | 1214                 | h'0b                     | 11                   |
| 1215                      | h'0c                     | 12                   | 1216                 | h'0d                     | 13                   |
| 1217                      | h'0e                     | 14                   | 1218                 | h'0f                     | 15                   |
| <b>Extension Shelf 13</b> |                          |                      |                      |                          |                      |
| 1301                      | h'10                     | 16                   | 1302                 | h'11                     | 17                   |
| 1303                      | h'12                     | 18                   | 1304                 | h'13                     | 19                   |
| 1305                      | h'14                     | 20                   | 1306                 | h'15                     | 21                   |
| 1307                      | h'16                     | 22                   | 1308                 | h'17                     | 23                   |
| 1311                      | h'18                     | 24                   | 1312                 | h'19                     | 25                   |
| 1313                      | h'1a                     | 26                   | 1314                 | h'1b                     | 27                   |
| 1315                      | h'1c                     | 28                   | 1316                 | h'1d                     | 29                   |
| 1317                      | h'1e                     | 30                   | 1318                 | h'1f                     | 31                   |
| <b>Extension Shelf 21</b> |                          |                      |                      |                          |                      |
| 2101                      | h'20                     | 32                   | 2102                 | h'21                     | 33                   |
| 2103                      | h'22                     | 34                   | 2104                 | h'23                     | 35                   |
| 2105                      | h'24                     | 36                   | 2106                 | h'25                     | 37                   |
| 2107                      | h'26                     | 38                   | 2108                 | h'27                     | 39                   |
| 2111                      | h'28                     | 40                   | 2112                 | h'29                     | 41                   |
| 2113                      | h'2a                     | 42                   | 2114                 | h'2b                     | 43                   |
| 2115                      | h'2c                     | 44                   | 2116                 | h'2d                     | 45                   |
| 2117                      | h'2e                     | 46                   | 2118                 | h'2f                     | 47                   |
| <b>Extension Shelf 22</b> |                          |                      |                      |                          |                      |
| 2201                      | h'30                     | 48                   | 2202                 | h'31                     | 49                   |

Table 5-72. Hexadecimal/Decimal Values for s and e parameters

| Card Location      | Hexadecimal Value | Decimal Value | Card Location | Hexadecimal Value | Decimal Value |
|--------------------|-------------------|---------------|---------------|-------------------|---------------|
| 2203               | h'32              | 50            | 2204          | h'33              | 51            |
| 2205               | h'34              | 52            | 2206          | h'35              | 53            |
| 2207               | h'36              | 54            | 2208          | h'37              | 55            |
| 2211               | h'38              | 56            | 2212          | h'39              | 57            |
| 2213               | h'3a              | 58            | 2214          | h'3b              | 59            |
| 2215               | h'3c              | 60            | 2216          | h'3d              | 61            |
| 2217               | h'3e              | 62            | 2218          | h'3f              | 63            |
| Extension Shelf 23 |                   |               |               |                   |               |
| 2301               | h'40              | 64            | 2302          | h'41              | 65            |
| 2303               | h'42              | 66            | 2304          | h'43              | 67            |
| 2305               | h'44              | 68            | 2306          | h'45              | 69            |
| 2307               | h'46              | 70            | 2308          | h'47              | 71            |
| 2311               | h'48              | 72            | 2312          | h'49              | 73            |
| 2313               | h'4a              | 74            | 2314          | h'4b              | 75            |
| 2315               | h'4c              | 76            | 2316          | h'4d              | 77            |
| 2317               | h'4e              | 78            | 2318          | h'4f              | 79            |
| Extension Shelf 31 |                   |               |               |                   |               |
| 3101               | h'50              | 80            | 3102          | h'51              | 81            |
| 3103               | h'52              | 82            | 3104          | h'53              | 83            |
| 3105               | h'54              | 84            | 3106          | h'55              | 85            |
| 3107               | h'56              | 86            | 3108          | h'57              | 87            |
| 3111               | h'58              | 88            | 3112          | h'59              | 89            |
| 3113               | h'5a              | 90            | 3114          | h'5b              | 91            |
| 3115               | h'5c              | 92            | 3116          | h'5d              | 93            |
| 3117               | h'5e              | 94            | 3118          | h'5f              | 95            |
| Extension Shelf 32 |                   |               |               |                   |               |
| 3201               | h'60              | 96            | 3202          | h'61              | 97            |
| 3203               | h'62              | 98            | 3204          | h'63              | 99            |



**Table 5-72.** Hexadecimal/Decimal Values for s and e parameters

| <b>Card Location</b>      | <b>Hexadecimal Value</b> | <b>Decimal Value</b> | <b>Card Location</b> | <b>Hexadecimal Value</b> | <b>Decimal Value</b> |
|---------------------------|--------------------------|----------------------|----------------------|--------------------------|----------------------|
| 3205                      | h'64                     | 100                  | 3206                 | h'65                     | 101                  |
| 3207                      | h'66                     | 102                  | 3208                 | h'67                     | 103                  |
| 3211                      | h'68                     | 104                  | 3212                 | h'69                     | 105                  |
| 3213                      | h'6a                     | 106                  | 3214                 | h'6b                     | 107                  |
| 3215                      | h'6c                     | 108                  | 3216                 | h'6d                     | 109                  |
| 3217                      | h'6e                     | 110                  | 3218                 | h'6f                     | 111                  |
| <b>Extension Shelf 33</b> |                          |                      |                      |                          |                      |
| 3301                      | h'70                     | 112                  | 3302                 | h'71                     | 113                  |
| 3303                      | h'72                     | 114                  | 3304                 | h'73                     | 115                  |
| 3305                      | h'74                     | 116                  | 3306                 | h'75                     | 117                  |
| 3307                      | h'76                     | 118                  | 3308                 | h'77                     | 119                  |
| 3311                      | h'78                     | 120                  | 3312                 | h'79                     | 121                  |
| 3313                      | h'7a                     | 122                  | 3314                 | h'7b                     | 123                  |
| 3315                      | h'7c                     | 124                  | 3316                 | h'7d                     | 125                  |
| 3317                      | h'7e                     | 126                  | 3318                 | h'7f                     | 127                  |
| <b>Extension Shelf 41</b> |                          |                      |                      |                          |                      |
| 4101                      | h'80                     | 128                  | 4102                 | h'81                     | 129                  |
| 4103                      | h'82                     | 130                  | 4104                 | h'83                     | 131                  |
| 4105                      | h'84                     | 132                  | 4106                 | h'85                     | 133                  |
| 4107                      | h'86                     | 134                  | 4108                 | h'87                     | 135                  |
| 4111                      | h'88                     | 136                  | 4112                 | h'89                     | 137                  |
| 4113                      | h'8a                     | 138                  | 4114                 | h'8b                     | 139                  |
| 4115                      | h'8c                     | 140                  | 4116                 | h'8d                     | 141                  |
| 4117                      | h'8e                     | 142                  | 4118                 | h'8f                     | 143                  |
| <b>Extension Shelf 42</b> |                          |                      |                      |                          |                      |
| 4201                      | h'90                     | 144                  | 4202                 | h'91                     | 145                  |
| 4203                      | h'92                     | 146                  | 4204                 | h'93                     | 147                  |
| 4205                      | h'94                     | 148                  | 4206                 | h'95                     | 149                  |

Table 5-72. Hexadecimal/Decimal Values for s and e parameters

| Card Location      | Hexadecimal Value | Decimal Value | Card Location | Hexadecimal Value | Decimal Value |
|--------------------|-------------------|---------------|---------------|-------------------|---------------|
| 4207               | h'96              | 150           | 4208          | h'97              | 151           |
| 4211               | h'98              | 152           | 4212          | h'99              | 153           |
| 4213               | h'9a              | 154           | 4214          | h'9b              | 155           |
| 4215               | h'9c              | 156           | 4216          | h'9d              | 157           |
| 4217               | h'9e              | 158           | 4218          | h'9f              | 159           |
| Extension Shelf 43 |                   |               |               |                   |               |
| 4301               | h'a0              | 160           | 4302          | h'a1              | 161           |
| 4303               | h'a2              | 162           | 4304          | h'a3              | 163           |
| 4305               | h'a4              | 164           | 4306          | h'a5              | 165           |
| 4307               | h'a6              | 166           | 4308          | h'a7              | 167           |
| 4311               | h'a8              | 168           | 4312          | h'a9              | 169           |
| 4313               | h'aa              | 170           | 4314          | h'ab              | 171           |
| 4315               | h'ac              | 172           | 4316          | h'ad              | 173           |
| 4317               | h'ae              | 174           | 4318          | h'af              | 175           |
| Extension Shelf 51 |                   |               |               |                   |               |
| 5101               | h'b0              | 176           | 5102          | h'b1              | 177           |
| 5103               | h'b2              | 178           | 5104          | h'b3              | 179           |
| 5105               | h'b4              | 180           | 5106          | h'b5              | 181           |
| 5107               | h'b6              | 182           | 5108          | h'b7              | 183           |
| 5111               | h'b8              | 184           | 5112          | h'b9              | 185           |
| 5113               | h'ba              | 186           | 5114          | h'bb              | 187           |
| 5115               | h'bc              | 188           | 5116          | h'bd              | 189           |
| 5117               | h'be              | 190           | 5118          | h'bf              | 191           |
| Extension Shelf 52 |                   |               |               |                   |               |
| 5201               | h'c0              | 192           | 5202          | h'c1              | 193           |
| 5203               | h'c2              | 194           | 5204          | h'c3              | 195           |
| 5205               | h'c4              | 196           | 5206          | h'c5              | 197           |
| 5207               | h'c6              | 198           | 5208          | h'c7              | 199           |

**Table 5-72.** Hexadecimal/Decimal Values for s and e parameters

| <b>Card Location</b> | <b>Hexadecimal Value</b> | <b>Decimal Value</b> | <b>Card Location</b> | <b>Hexadecimal Value</b> | <b>Decimal Value</b> |
|----------------------|--------------------------|----------------------|----------------------|--------------------------|----------------------|
| 5211                 | h'c8                     | 200                  | 5212                 | h'c9                     | 201                  |
| 5213                 | h'ca                     | 202                  | 5214                 | h'cb                     | 203                  |
| 5215                 | h'cc                     | 204                  | 5216                 | h'cd                     | 205                  |
| 5217                 | h'ce                     | 206                  | 5218                 | h'cf                     | 207                  |
| Extension Shelf 53   |                          |                      |                      |                          |                      |
| 5301                 | h'd0                     | 208                  | 5302                 | h'd1                     | 209                  |
| 5303                 | h'd2                     | 210                  | 5304                 | h'd3                     | 211                  |
| 5305                 | h'd4                     | 212                  | 5306                 | h'd5                     | 213                  |
| 5307                 | h'd6                     | 214                  | 5308                 | h'd7                     | 215                  |
| 5311                 | h'd8                     | 216                  | 5312                 | h'd9                     | 217                  |
| 5313                 | h'da                     | 218                  | 5314                 | h'db                     | 219                  |
| 5315                 | h'dc                     | 220                  | 5316                 | h'dd                     | 221                  |
| 5317                 | h'de                     | 222                  | 5318                 | h'df                     | 223                  |
| Extension Shelf 61   |                          |                      |                      |                          |                      |
| 6101                 | h'e0                     | 224                  | 6102                 | h'e1                     | 225                  |
| 6103                 | h'e2                     | 226                  | 6104                 | h'e3                     | 227                  |
| 6105                 | h'e4                     | 228                  | 6106                 | h'e5                     | 229                  |
| 6107                 | h'e6                     | 230                  | 6108                 | h'e7                     | 231                  |
| 6111                 | h'e8                     | 232                  | 6112                 | h'e9                     | 233                  |
| 6113                 | h'ea                     | 234                  | 6114                 | h'eb                     | 235                  |
| 6115                 | h'ec                     | 236                  | 6116                 | h'ed                     | 237                  |
| 6117                 | h'ee                     | 238                  | 6118                 | h'ef                     | 239                  |

## Output

rept-imt-lvl1:s=00:e=01

```
rlghncxa03w 08-09-18 09:25:56 EST EAGLE 39.2.0
Retrieving data from cards...
```

;

```
rlghncxa03w 08-09-18 09:25:56 EST EAGLE 39.2.0
```

```
-----
```

```
Card: H'0000      Elapsed Time (day - h:m:s):  0 - 00:08:31.2
```

| Count                              | Bus A Value | Bus B Value |
|------------------------------------|-------------|-------------|
| -----                              | -----       | -----       |
| Transmit Packet                    | 0           | 0           |
| Transmit Byte                      | 0           | 0           |
| Receive Packet                     | 0           | 0           |
| Receive Byte                       | 0           | 0           |
| Receive Packet with CRC Error      | 36          | 2           |
| Receive Packet with Format Error   | 0           | 1           |
| Receive Packet with Invalid Length | 0           | 0           |
| Primary Control Receive Error      | 0           | 0           |
| Primary Control Transmit Error     | 0           | 0           |
| Primary Control Sanity Error       | 0           | 0           |
| Violation Error                    | 291         | 2           |
| CPU Receive FIFO Full              | 0           | 0           |
| IMT Error Interrupt                | 0           | 0           |
| Error Interrupt Overflow           | 0           | 0           |
| DMA Terminal Count Interrupt       | 0           | 0           |
| MSU Retransmitted                  | 0           | 0           |
| MSU Safety Packet                  | 0           | 0           |
| ASU Safety Packet                  | 0           | 0           |
| TSU Safety Packet                  | 0           | 0           |
| BSU Safety Packet                  | 0           | 0           |
| SSU Safety Packet                  | 0           | 0           |
| MSU Returned On Error              | 0           | 0           |
| MSU Dropped With No Report         | 0           | 0           |

;

```
Card: H'0001      Elapsed Time (day - h:m:s):  3 - 03:20:07.7
```

| Count                              | Bus A Value | Bus B Value |
|------------------------------------|-------------|-------------|
| -----                              | -----       | -----       |
| Transmit Packet                    | 0           | 0           |
| Transmit Byte                      | 0           | 0           |
| Receive Packet                     | 0           | 0           |
| Receive Byte                       | 0           | 0           |
| Receive Packet with CRC Error      | 14          | 2           |
| Receive Packet with Format Error   | 0           | 0           |
| Receive Packet with Invalid Length | 0           | 0           |
| Primary Control Receive Error      | 0           | 0           |
| Primary Control Transmit Error     | 0           | 0           |
| Primary Control Sanity Error       | 0           | 0           |
| Violation Error                    | 320         | 12          |
| CPU Receive FIFO Full              | 0           | 0           |
| IMT Receive FIFO Half Full         | 0           | 0           |
| CPU Receive FIFO Half Full         | 0           | 0           |
| DMA Terminal Count Interrupt       | 0           | 0           |
| MSU Retransmitted                  | 1           | 0           |
| MSU Safety Packet                  | 0           | 0           |
| ASU Safety Packet                  | 0           | 0           |
| TSU Safety Packet                  | 0           | 0           |
| IMT Receive FIFO Full              | 0           | 0           |
| SSU Safety Packet                  | 0           | 0           |
| MSU Returned On Error              | 0           | 0           |
| MSU Dropped With No Report         | 0           | 0           |

```

;
rlghncxa03w 08-09-18 09:25:56 EST EAGLE 39.2.0
=====
SUMMARY REPORT: Totals accumulated from all requested cards

Count          Bus A Value   Bus B Value
-----          -
Transmit Packet          0           0
Transmit Byte            0           0
Receive Packet          0           0
Receive Byte            0           0
Receive Packet with CRC Error      50           4
Receive Packet with Format Error    0           1
Receive Packet with Invalid Length  0           0
Primary Control Receive Error      0           0
Primary Control Transmit Error     0           0
Primary Control Sanity Error       0           0
Violation Error          611          14
CPU Receive FIFO Full      0           0
IMT Receive FIFO Half Full  0           0
CPU Receive FIFO Half Full  0           0
DMA Terminal Count Interrupt  0           0
MSU Retransmitted         1           0
MSU Safety Packet         0           0
ASU Safety Packet         0           0
TSU Safety Packet         0           0
IMT Receive FIFO Full      0           0
SSU Safety Packet         0           0
MSU Returned On Error      0           0
MSU Dropped With No Report  0           0
-----
;
END OF REPORT
;

```

**Legend**

**CARD**—The IMT address of the card in hexadecimal

**ELAPSED TIME ( day - h:m:s )**—The amount of time that has elapsed since a card reset has occurred or the IMT statistics were cleared with the **clr-imt-stats** command. This is shown in the format **day - h:m:s**, where **day** is the number of days that have elapsed, and **h:m:s** is the amount of time in the current day in hours, minutes, and seconds (and tenths of seconds).

**COUNT**—The IMT level 1 statistics displayed in this report.

**BUS A VALUE** and **BUS B VALUE**—The values of the IMT level 1 statistics on IMT bus A and IMT bus B.

Table 5-73 describes the statistics that are shown in the report for each card and in the Summary of totals for all requested cards, and their possible causes and corrective actions.

"Excessive" count is primarily determined by the operator based upon:

- Overall system behavior
- Duration of time from when the last statistics were taken
- Statistics of an individual card in relation to other cards

The following types of Safety Packets are included in the counts:

**SAFETY PACKET**—When an IMT packet goes around the IMT, a pre determined value in the packet is decremented by each card. When this value reaches zero, the card that receives the value equal to zero logs this as a safety packet and removes the IMT packet from the IMT.

**MESSAGE SIGNALING UNIT (MSU)**—IMT packet containing data

**ACKNOWLEDGEMENT SIGNALING UNIT (ASU)**—**ack** for an MSU that is sent from the destination card back to the originating card.

**TEST SIGNALING UNIT (TSU)**—Typically used to keep the card on the bus. There are many types of TSU's one of which performs a heartbeat function.

**BROADCAST SIGNALING UNIT (BSU)**—Function is the same as an MSU except that each card will process the BSU and then copy it to the next card for processing. Used for IMT maintenance functions.

**SAFETY SIGNALING UNIT (SSU)**—Anytime a packet times out (Safety Packet), the card that logged a safety packet sends an SSU to make sure the originating card is still on the IMT bus.

**Table 5-73. rept-imt-lvl1 Statistics Explanation**

| IMT Statistic                    | Explanation Of Statistic                                                                                         | Probable Causes                                                                | Recommended Action                                                                                                                                                                                |
|----------------------------------|------------------------------------------------------------------------------------------------------------------|--------------------------------------------------------------------------------|---------------------------------------------------------------------------------------------------------------------------------------------------------------------------------------------------|
| Transmit Packet                  | Number of transmitted IMT packets                                                                                | N/A                                                                            | N/A                                                                                                                                                                                               |
| Transmit Byte                    | Number of transmitted IMT Bytes                                                                                  | N/A                                                                            | N/A                                                                                                                                                                                               |
| Receive Packet                   | Number of received IMT Packets                                                                                   | N/A                                                                            | N/A                                                                                                                                                                                               |
| Receive Byte                     | Number of received IMT Bytes                                                                                     | N/A                                                                            | N/A                                                                                                                                                                                               |
| Receive Packet with CRC Error    | Bad Checksum in received IMT packet. Usually caused by corrupted data.<br>Detected by hardware                   | Card insertion, removal, or boot. Might occur infrequently in a normal system. | <ul style="list-style-type: none"> <li>• None if card has booted or was just inserted.</li> <li>• Contact Tekelec Technical Services if count is excessive in relation to other cards.</li> </ul> |
| Receive Packet with Format Error | Occurs when the Start of Message byte of the IMT packet is followed by unexpected data.<br>Detected by hardware. | Card insertion, removal, or boot                                               | <ul style="list-style-type: none"> <li>• None if card has booted or was just inserted.</li> <li>• Contact Tekelec Technical Services if count is excessive in relation to other cards.</li> </ul> |

Table 5-73. rept-imt-lvl1 Statistics Explanation

| IMT Statistic                      | Explanation Of Statistic                                                                                                                          | Probable Causes                  | Recommended Action                                                                                                                                                                                |
|------------------------------------|---------------------------------------------------------------------------------------------------------------------------------------------------|----------------------------------|---------------------------------------------------------------------------------------------------------------------------------------------------------------------------------------------------|
| Receive Packet with Invalid Length | Card received an IMT packet where the actual length of the packet did not match the length indicated in the length field.<br>Detected by software | Card insertion, removal, or boot | <ul style="list-style-type: none"> <li>• None if card has booted or was just inserted.</li> <li>• Contact Tekelec Technical Services if count is excessive in relation to other cards.</li> </ul> |
| Primary Control Receive Error      | Corrupted packet.<br>Detected by hardware                                                                                                         | Card insertion, removal, or boot | <ul style="list-style-type: none"> <li>• None if card has booted or was just inserted.</li> <li>• Contact Tekelec Technical Services if count is excessive in relation to other cards.</li> </ul> |
| Primary Control Transmit Error     | Transmitted IMT packet is greater than allowed size.<br>Detected by hardware                                                                      | Card insertion, removal, or boot | <ul style="list-style-type: none"> <li>• None if card has booted or was just inserted.</li> <li>• Contact Tekelec Technical Services if count is excessive in relation to other cards.</li> </ul> |

Table 5-73. rept-imt-lvl1 Statistics Explanation

| IMT Statistic                | Explanation Of Statistic                                                     | Probable Causes                                                                                            | Recommended Action                                                                                                                                                                                |
|------------------------------|------------------------------------------------------------------------------|------------------------------------------------------------------------------------------------------------|---------------------------------------------------------------------------------------------------------------------------------------------------------------------------------------------------|
| Primary Control Sanity Error | Internal hardware monitoring self check failed.<br>Detected by hardware      | Generally indicates Bad hardware or corrupt packets.                                                       | <ul style="list-style-type: none"> <li>• None if card has booted or was just inserted.</li> <li>• Contact Tekelec Technical Services if count is excessive in relation to other cards.</li> </ul> |
| Violation Error              | Received an illegal character from the IMT.<br>Detected by hardware          | Card insertion, removal, or boot                                                                           | <ul style="list-style-type: none"> <li>• None if card has booted or was just inserted.</li> <li>• Contact Tekelec Technical Services if count is excessive in relation to other cards.</li> </ul> |
| CPU Receive FIFO Full        | Communication CPU on the card is congested. Detected by hardware             | Indicates that data was received at a higher rate than could be processed by the Communications processor. | Contact Tekelec Technical Services if count is excessive in relation to other cards.                                                                                                              |
| IMT Receive FIFO Half Full   | IMT interface on the card is becoming congested.<br>Detected by hardware.    | Indicates that data was received at a higher rate than could be switched for a short period.               | None.<br>FIFO Half Full is just an indication; no action is required.                                                                                                                             |
| CPU Receive FIFO Half Full   | Communication CPU on the card is becoming congested.<br>Detected by hardware | Indicates that data was received at a higher rate than could be processed for a short period.              | None.<br>FIFO Half Full is just an indication; no action is required.                                                                                                                             |



**Table 5-73. rept-imt-lvl1 Statistics Explanation**

| IMT Statistic                | Explanation Of Statistic                                                                                                          | Probable Causes                                                                | Recommended Action                                                                                                                                                                                |
|------------------------------|-----------------------------------------------------------------------------------------------------------------------------------|--------------------------------------------------------------------------------|---------------------------------------------------------------------------------------------------------------------------------------------------------------------------------------------------|
| DMA Terminal Count Interrupt | Received IMT packet length is longer than the max allowed.<br>Detected by hardware                                                | Card insertion, removal, or boot                                               | <ul style="list-style-type: none"> <li>• None if card has booted or was just inserted.</li> <li>• Contact Tekelec Technical Services if count is excessive in relation to other cards.</li> </ul> |
| MSU Retransmitted            | Retransmissions occur typically when an MSU goes around the IMT bus and times out (safety packet issued).<br>Detected by software | Card insertion, removal, or boot. Might occur infrequently in a normal system. | <ul style="list-style-type: none"> <li>• None if card has booted or was just inserted.</li> <li>• Contact Tekelec Technical Services if count is excessive in relation to other cards.</li> </ul> |
| MSU Safety Packet            | MSU has timed out on the IMT.<br>Detected by hardware                                                                             | Card insertion, removal, or boot                                               | <ul style="list-style-type: none"> <li>• None if card has booted or was just inserted.</li> <li>• Contact Tekelec Technical Services if count is excessive in relation to other cards.</li> </ul> |

Table 5-73. rept-imt-lvl1 Statistics Explanation

| IMT Statistic     | Explanation Of Statistic                                   | Probable Causes                  | Recommended Action                                                                                                                                                                                |
|-------------------|------------------------------------------------------------|----------------------------------|---------------------------------------------------------------------------------------------------------------------------------------------------------------------------------------------------|
| ASU Safety Packet | ASU Unit has timed out on the IMT.<br>Detected by hardware | Card insertion, removal, or boot | <ul style="list-style-type: none"> <li>• None if card has booted or was just inserted.</li> <li>• Contact Tekelec Technical Services if count is excessive in relation to other cards.</li> </ul> |
| TSU Safety Packet | TSU Unit has timed out on the IMT.<br>Detected by hardware | Card insertion, removal, or boot | <ul style="list-style-type: none"> <li>• None if card has booted or was just inserted.</li> <li>• Contact Tekelec Technical Services if count is excessive in relation to other cards.</li> </ul> |
| BSU Safety Packet | BSU Unit has timed out on the IMT.<br>Detected by hardware | Card insertion, removal, or boot | <ul style="list-style-type: none"> <li>• None if card has booted or was just inserted.</li> <li>• Contact Tekelec Technical Services if count is excessive in relation to other cards.</li> </ul> |

Table 5-73. rept-imt-lvl1 Statistics Explanation

| IMT Statistic              | Explanation Of Statistic                                                                                                                                                                                                                                                                                                                                                                                                                                                                                                                   | Probable Causes                                       | Recommended Action                                                                                                                                                                            |
|----------------------------|--------------------------------------------------------------------------------------------------------------------------------------------------------------------------------------------------------------------------------------------------------------------------------------------------------------------------------------------------------------------------------------------------------------------------------------------------------------------------------------------------------------------------------------------|-------------------------------------------------------|-----------------------------------------------------------------------------------------------------------------------------------------------------------------------------------------------|
| SSU Safety Packet          | SSU Unit has timed out on the IMT. Detected by hardware                                                                                                                                                                                                                                                                                                                                                                                                                                                                                    | Card insertion, removal, or boot                      | <ul style="list-style-type: none"> <li>None if card has booted or was just inserted.</li> <li>Contact Tekelec Technical Services if count is excessive in relation to other cards.</li> </ul> |
| MSU Returned On Error      | Number of MSUs returned to the application as undeliverable. These are usually rerouted by the application. Detected by software.                                                                                                                                                                                                                                                                                                                                                                                                          | Destination card is not available to receive packets. | None. MSU Returned is just an indication; no action is required.                                                                                                                              |
| MSU Dropped With No Report | Number of MSUs discarded as undeliverable. Detected by software.<br><b>Note:</b> The "MSU Dropped With No Report" statistic may be non-zero after executing the <b>rept-imt-lvl1</b> or <b>clr-imt-stats</b> command. During execution of these commands, the active MASP generates MSUs to unpopulated card slots. These MSUs result in an "MSU Dropped With No Report" count. To determine the number of unexpected "MSU Dropped With No Report" occurrences, the active MASP must be excluded from the <b>rept-imt-lvl1</b> card range. | Destination card is not available to receive packets. | None. MSU Dropped is just an indication; no action is required.                                                                                                                               |

**rept-imt-lvl2**

**Report IMT Level 2**

Use this command to display the IMT level 2 statistics for a card. This report displays IMT traffic statistics for either one or both IMT busses in the system. The report can be filtered as follows:

- Report statistics between the source card (specified with the **loc** or **l** parameters), whose statistics pool is queried for report information, and another card (specified with the **sloc** or **s** parameter).

- Report statistics between the source card and a range of cards (specified with both the **sloc** and **eloc** or the **s** and **e** parameter combinations).

**Keyword:** rept-imt-lvl2

**Related Commands:** clr-imt-stats, conn-imt, disc-imt, rept-imt-info, rept-imt-lvl1, rept-stat-imt, rmv-imt, rst-imt, tst-imt

**Command Class:** System Maintenance

## Parameters

**:b=** (optional)

IMT bus identification.

**Range:** **a, b, both**

**a** — Displays statistics for IMT bus A.

**b** — Displays statistics for IMT bus B.

**both** — Displays statistics for both IMT busses, A and B.

**Default:** **both**

**:e=** (optional)

End address. This parameter specifies the IMT address of the last card in the range. A decimal value or a hexadecimal value can be specified for this parameter (see Table 5-72 to map the values by card location).

**Range:** **0-251**

The value can be specified in decimal (**0–251**) or hexadecimal (**h'00–h'fb**).

**Default:** If the **s** parameter is specified, the default is the **s** parameter value.

If the **s** parameter is not specified, the default is **251**.

**:eloc=** (optional)

End location. Specifies the card location of the last card in the range.

**Range:** **1101-1108, 1111-1113, 1115, 1201-1208, 1211-1218, 1301-1308, 1311-1318, 2101-2108, 2111-2118, 2201-2208, 2211-2218, 2301-2308, 2311-2318, 3101-3108, 3111-3118, 3201-3208, 3211-3218, 3301-3308, 3311-3318, 4101-4108, 4111-4118, 4201-4208, 4211-4218, 4301-4308, 4311-4318, 5101-5108, 5111-5118, 5201-5208, 5211-5218, 5301-5308, 5311-5318, 6101-6108, 6111-6118**

**Default:** If **sloc** is specified—current **sloc** value; displays information for one card

If **sloc** is not specified—**1115**, which corresponds to IMT address 251 (**e=251**); displays information for entire range of locations.

**:l=** (optional)

Source card IMT address. The IMT address of the card whose statistics pool is to be queried for report information.

**Range:** **0-251**

(See the *Installation Manual – EAGLE 5 ISS* for an illustration of the card locations.)

**:loc=** (optional)

Source card location. The location of the card whose "statistics pool" is to be queried for report information.

**Range:** **1101-1108, 1111-1113, 1115, 1201-1208, 1211-1218, 1301-1308, 1311-1318, 2101-2108, 2111-2118, 2201-2208, 2211-2218, 2301-2308, 2311-2318, 3101-3108, 3111-3118, 3201-3208, 3211-3218, 3301-3308, 3311-3318, 4101-4108, 4111-4118, 4201-4208, 4211-4218, 4301-4308, 4311-4318, 5101-5108, 5111-5118, 5201-5208, 5211-5218, 5301-5308, 5311-5318, 6101-6108, 6111-6118**

**:s=** (optional)

Start address. This parameter specifies the IMT address of the first (or only) card in the range. A decimal value or a hexadecimal value can be specified for this parameter (see Table 5-72 to map the values by card location).

**Range:**     **0-251**

The value can be specified in decimal (**0–251**) or hexadecimal (**h'00–h'fb**).

**Default:**    If **e** is specified—current **l** parameter value.  
                   If **e** is not specified—**0**.

**:sloc=** (optional)

Start location. Specifies the card location of the first card in the range.

**Range:**     **1101-1108, 1111-1113, 1115, 1201-1208, 1211-1218, 1301-1308, 1311-1318, 2101-2108, 2111-2118, 2201-2208, 2211-2218, 2301-2308, 2311-2318, 3101-3108, 3111-3118, 3201-3208, 3211-3218, 3301-3308, 3311-3318, 4101-4108, 4111-4118, 4201-4208, 4211-4218, 4301-4308, 4311-4318, 5101-5108, 5111-5118, 5201-5208, 5211-5218, 5301-5308, 5311-5318, 6101-6108, 6111-6118**

**Default:**    If **eloc** is specified—current **sloc** value.  
                   If **eloc** is not specified—IMT address 0 (**s=0**).

**:trm=** (optional)

The serial port (printer location) where the report is to be sent.

**Range:**     **1-40**

**Default:**    The report displays on the terminal where the command was issued.

**Example**

```
rept-imt-lvl2:l=00:s=00:e=02:b=a
```

**Dependencies**

If the **s** and **e** parameters are specified, the **sloc** and **eloc** parameters cannot be specified; conversely, if the **sloc** and **eloc** parameters are specified, the **s** and **e** parameters cannot be specified.

The **rept-imt-lvl2** command cannot be entered if any of the following commands is running: **clr-imt-stats**, **rept-imt-info**, **rept-imt-lvl1**, **tst-imt**.

Either the source address (**l** parameter) or the source location (**loc** parameter) must be specified.

This command cannot be entered during IMT statistics collection following an hourly boundary.

Either the source address (**l** parameter) or the source location (**loc** parameter) must be specified; but not both at the same time.

A card location must be specified that is valid and defined in the database.

**Notes**

None

## Output

If the source card location falls within the range of cards specified with the **sloc** and **eloc** parameters or the **s** and **e** parameters, the output report for the source card will show zeros. The zeros are reported because the source card location does not use the IMT to communicate with itself and, therefore, does not report any values or pegs for traffic routed to itself. This command reports only the values or pegs received or transmitted across the IMT bus.

In the following example, the output for the source card location (**loc=1213**) is shown in column 0a (the equivalent card location expressed as a hexadecimal digit). The 0a column displays zeros because **loc=1213**, falls within the range specified for the start and end card location (**sloc=1211** and **eloc=1215**). (Note that the Receive FSN row displays a value of **1**, which is not a count, but rather the initial sequence number of the FSN that the source card location expects to receive). Columns 09 and 0b display zeros because these slots are not provisioned with any card (the adjacent card slots (08 and 0c) contain DCM cards).

**rept-imt-lvl2:sloc=1211:eloc=1215:loc=1213**

```
rlghncxa03w 04-02-28 09:26:34 EST EAGLE 31.3.0
Retrieving data from card...
```

```
-----
Card:  H'000a      Bus:  A
```

| Field            |       | 08   | 09   | 0a   | 0b   | 0c   |
|------------------|-------|------|------|------|------|------|
| -----            |       | ---- | ---- | ---- | ---- | ---- |
| Link Status      |       | ALGN | -OS- | ALGN | -OS- | ALGN |
| OS Count         | (dec) | 0    | 0    | 0    | 0    | 0    |
| Transmit BSN     | (dec) | 84   | 0    | 0    | 0    | 0    |
| Transmit FSN     | (dec) | 99   | 0    | 0    | 0    | 34   |
| Receive BSN      | (dec) | 99   | 0    | 0    | 0    | 34   |
| Receive FSN      | (dec) | 85   | 1    | 1    | 1    | 1    |
| Unack Messages   | (dec) | 0    | 0    | 0    | 0    | 0    |
| Invalid Length   | (dec) | 0    | 0    | 0    | 0    | 0    |
| Invalid rx BSN   | (dec) | 0    | 0    | 0    | 0    | 0    |
| Invalid rx FSN   | (dec) | 0    | 0    | 0    | 0    | 0    |
| Invalid LSSU     | (dec) | 0    | 0    | 0    | 0    | 0    |
| Invalid ASU      | (dec) | 0    | 0    | 0    | 0    | 0    |
| RTB Address      | (hex) | 0000 | 0000 | 0000 | 0000 | 0000 |
| Average ack time | (ms)  | 0    | 0    | 0    | 0    | 0    |
| Minimum ack time | (ms)  | 0    | 0    | 0    | 0    | 0    |
| Maximum ack time | (ms)  | 0    | 0    | 0    | 0    | 0    |

```
rlghncxa03w 04-02-28 09:26:34 EST EAGLE 31.3.0
```

```
-----
Card:  H'00f4      Bus:  B
```

| Field            |       | f0   | f1   | f2   | f3   | f4   | f5   | f6   | f7   |
|------------------|-------|------|------|------|------|------|------|------|------|
| -----            |       | ---- | ---- | ---- | ---- | ---- | ---- | ---- | ---- |
| Link Status      |       | -OS- | -OS- | ALGN | ALGN | ALGN | -OS- | ALGN | -OS- |
| OS Count         | (dec) | 0    | 0    | 2    | 2    | 3    | 0    | 1    | 0    |
| Transmit BSN     | (dec) | 0    | 0    | 0    | 0    | 0    | 0    | 0    | 0    |
| Transmit FSN     | (dec) | 0    | 0    | 0    | 0    | 0    | 0    | 0    | 0    |
| Receive BSN      | (dec) | 0    | 0    | 0    | 0    | 0    | 0    | 0    | 0    |
| Receive FSN      | (dec) | 0    | 0    | 1    | 1    | 1    | 0    | 1    | 0    |
| Unack Messages   | (dec) | 0    | 0    | 0    | 0    | 0    | 0    | 0    | 0    |
| Invalid Length   | (dec) | 0    | 0    | 0    | 0    | 0    | 0    | 0    | 0    |
| Invalid rx BSN   | (dec) | 0    | 0    | 0    | 0    | 0    | 0    | 0    | 0    |
| Invalid rx FSN   | (dec) | 0    | 0    | 0    | 0    | 0    | 0    | 0    | 0    |
| Invalid LSSU     | (dec) | 0    | 0    | 0    | 0    | 0    | 0    | 0    | 0    |
| Invalid ASU      | (dec) | 0    | 0    | 0    | 0    | 0    | 0    | 0    | 0    |
| RTB Address      | (hex) | 0000 | 0080 | 0100 | 0180 | 0200 | 0280 | 0300 | 0380 |
| Average ack time | (ms)  | 0    | 0    | 0    | 0    | 0    | 0    | 0    | 0    |
| Minimum ack time | (ms)  | 0    | 0    | 0    | 0    | 0    | 0    | 1    | 1    |
| Maximum ack time | (ms)  | 2    | 2    | 3    | 3    | 3    | 3    | 3    | 3    |

```
-----
END OF REPORT
```

```
;
```

*Legend*

**CARD**—The IMT address of the card location specified by the **I** parameter in this command in hexadecimal.

**BUS**—The IMT bus for which the IMT level 2 statistics are being reported.

**FIELD**—The IMT level 2 statistics displayed in this report.

**00 - EF**—The IMT address of the cards on the IMT bus in hexadecimal.

**LINK STATUS**—The status of the link, either ALGN (aligned) or OS (out of service).

**OS COUNT**—The number of times the link has cycled between being aligned and being out of service.

**TRANSMIT BSN**—The number of BSNs transmitted.

**TRANSMIT FSN**—The number of FSNs transmitted.

**RECEIVE BSN**—The number of BSNs received.

**RECEIVE FSN**—The sequence number for the next FSN that the source card location expects to receive.

**UNACK MESSAGES**—The number of unacknowledged messages received.

**INVALID LENGTH**—The number of messages received with invalid length indicators.

**INVALID RX BSN**—The number of invalid BSNs received.

**INVALID RX FSN**—The number of invalid FSNs received.

**INVALID LSSU**—The number of invalid LSSUs received.

**INVALID ASU**—The number of invalid ASUs received.

**RTB ADDRESS**—The address of the retransmission buffer, in hexadecimal.

**AVERAGE ACK TIME**—The average amount of time for an acknowledgment, in milliseconds.

**MINIMUM ACK TIME**—The minimum amount of time for an acknowledgment, in milliseconds.

**MAXIMUM ACK TIME**—The maximum amount of time for an acknowledgment, in milliseconds.

**rept-meas****Report Measurements**

Use this command to generate measurement reports on demand. The reports display on the UI terminal, and are not transferred to the customer FTP server when the Measurements Platform feature is enabled.

**Keyword:** **rept-meas**

**Related Commands:** **chg-meas, copy-meas, rept-ftp-meas, rtrv-meas-sched**

**Command Class:** Link Maintenance

**Parameters**

**:enttype=** (mandatory)

The entity type to report on.

**Range:** **link, lnkset, lnp, lsdestni, lsonismt, lsorigni, mapscrn, np, origni, originnc, stp, stplan, tt, sctpasoc, sctpcard, ua**  
**link** — Measurements for signaling links  
**lnkset** — Measurements for linksets  
**lnp** — Measurements for local number portability  
**lsdestni** — Measurements for linkset destination network identifiers  
**lsonismt** — Measurements for ISUP message type screening  
**lsorigni** — Measurements for linkset originating network identifiers

**mapscrn**— Measurements for GSM MAP message screening  
**np**— Measurements for INP, INP CRP, G-Port, A-Port, MO-based GSM SMS NP, MO-based IS41 SMS NP, IGM, MT-Based GSM SMS NP, and MT-Based IS41 SMS NP  
**origni**— Measurements for originating network identifiers greater than 5  
**originic**— Measurements for originating network identifiers (less than 5, small networks) for network clusters  
**stp**— Measurements pertaining to the Signaling Transfer Point in general or summarized totals recorded on the STP  
**stplan**— Measurements for STP Local Area Network data links  
**tt**— Measurements for translation types  
**sctpasoc**— Measurements per association for the SCTP protocol (used to carry M3UA, M2PA, and SUA traffic)  
**sctpcard**— Measurements per card for the SCTP protocol (used to carry M3UA, M2PA, and SUA traffic)  
**ua**— Measurements per application server/association for the M3UA and SUA protocols

**:type=** (mandatory)

The type of measurement report.

**Range:** **avl, avld, avldth, comp, gtwy, mtcd, mtcdth, mtch, mtcs, nm, rbase, systot**

**avl**— Availability measurements

**avld**— Daily availability measurements

**avldth**— Day to hour availability measurements.

**comp**— Component measurements

**gtwy**— Internetwork gateway-related data from the STP for ANSI and ITU measurements. ANSI gateway measurements are pegged on a per-linkset, per-Network Indicator basis, whereas ITU measurements are pegged on a per-linkset basis.

**mtcd**— Daily maintenance measurements

**mtcdth**— Day-to-hour maintenance measurements

**mtch**— Hourly maintenance measurements

**mtcs**— Link/linkset maintenance status

**nm**— Network management, on-demand

**rbase**— Schedule-report type record base measurements

**systot**— STP system totals

**:aname=** (optional)

Association name. This parameter specifies the name assigned to the association in the IPAPSOCK table.

**Range:** *aaaaaaaaaaaaaaaa*

Up to 15 alphanumeric characters; the first character must be a letter.

**:appl=** (optional)

The GPL to report measurements on.

This parameter can be used only with the **stplan-avl (enttype=stplan:type=avl)** measurement report.

**Range:** *xyyyyyyy*

1 alphabetic character followed by up to 7 alphanumeric characters. Valid GPLs are:

**atmansi**—Used by the LIM cards to support the high-speed ATM signaling link feature

**atmhc**—Supports functionality for the E5-ATM card. The E5-ATM card runs either the ATMANSI or ATMITU application. The GPL allows the card to support up to 2 signaling links.

**atmitu**—Used by E1 ATM cards to support the high-speed E1 ATM signaling link feature



**blbepm**—Flash GPL containing the BIOS ROM image on E5-E1T1 and E5-ENET cards

**blbios**—Flash GPL containing the BIOS ROM image on HC-MIM cards that are used for E1 or T1 signaling links

**blbsmg**—Flash GPL containing the BIOS ROM image on E5-SM4G cards

**blcpld**—Flash GPL containing the bit files for the CPLD on HC-MIM, E5-E1T1, and E5-ENET cards that are used for E1 or T1 signaling links.

**bldiag6**—Flash GPL containing the diagnostic code on E5-E1T1 cards, HC-MIM cards, and E5-ENET cards

**blmcap**—Flash GPL containing a tar image with all code required on E5-MCAP cards

**blvxw6**—Flash GPL containing the VxWorks operating system on E5-E1T1 cards, HC-MIM cards, and E5-ENET cards

**blrom1**—Flash GPL containing the bootloader code for VxWorks operating system on HC-MIM cards

**bpdcn**—Used to support the flash memory Board PROM for DCM, DSM, and GPSM boards, original design

**bpdcn2**—Used to support the flash memory Board PROM for DCM and GPSM boards, revised design

**bphcap**—Used to support Board PROM for HCAP flash memory

**bphcapT**—Supports Board PROM for HCAP-T flash memory

**bphmux**—Supports Board PROM for HMUX flash memory

**bpmpl**—Supports Board PROM for MPL flash memory

**bpmlt**—Supports Board PROM for E1/T1 flash memory

**cdn**—Used in the card manufacturing process.

**eoam**—Used by the GPSM-II card for enhanced OAM functions

**eroute**—Used by the STC card for EAGLE 5 Integrated Monitoring Support functions

**erthc**—Used by the E5-ENET card when the card acts as an STC card (E5-STC card) for EAGLE 5 Integrated Monitoring Support functions

**gls**—Used by TSM cards to download gateway screening to LIM cards

**glshe**—Used by E5-TSM cards to download gateway screening to LIM and SCCP cards

**hipr**—Communication software used on the High Speed IMT Packet Router (HIPR) card

**hipr2**—Communication software used on the High Speed IMT Packet Router (HIPR2) card

**imt**—Communication processor on the logical processing element (LPE)

**imtpci**—Communication software that operates the IMT bus on HC-MIM, E5-E1T1, and E5-ENET cards

**ipghc**—Used by E5-ENET cards to support TCP/IP point-to-multipoint connectivity for both ANSI and ITU point codes

**ipgwi**—Used by SSEDCEM cards for TCP/IP point-to-point connectivity for ITU point codes

**iplhc**—Used by E5-ENET cards for TCP/IP point-to-point connectivity for both ANSI and ITU point codes

**iplim**—Used by SSEDCEM cards for TCP/IP point-to-point connectivity for ANSI point codes

**iplimi**—Used by SSEDCCM cards for TCP/IP point-to-point connectivity for ITU point codes

**ips**—Used by IPSM cards for the IP User Interface feature

**ipsg**—Used by E5-ENET cards to support the combined functionality of IPLIMx M2PA and IPGWx M3UA

**ipshc**—Used by E5-IPSM cards to support the IPS application

**mcp**—Used by MCPM cards for the Measurements Platform feature

**oamhc**—Used by E5-MCAP cards for enhanced OAM functions

**pldpmc1**—Flash GPL used on HC-MIM and E5-E1T1 cards for E1 and T1 signaling links

**sccphc**—Used by E5-SM4G cards to support the EPAP-based features and the LNP ELAP Configuration feature. If no EPAP-based or LNP ELAP Configuration feature is turned on, and if an E5-SM4G card when the card acts as an STC card (E5-STC card) for EAGLE 5 Integrated Monitoring Support functions.

**ss7hc**—Supports the functionality for HC-MIM or E5-E1T1 cards. The HC-MIM and E5-E1T1 cards run the SS7ANSI or CCS7ITU application; the GPL allows the card to support up to 64 signaling links for E1 and T1 functions.

**ss7ipgw**—Used by SSEDCCM cards to support TCP/IP point-to-multipoint connectivity

**ss7ml**—Support functionality for MPL and the E1/T1 MIM cards. MPL cards run the SS7ANSI application on a LIMDS0 card (as in the command **ent-**

**card:type=limds0:appl=ss7ansi**); the GPL allows the card to support 8 signaling links rather than the usual 2 links for LIM cards. MPL cards support only the DS0 interface. E1/T1 MIM card runs either the SS7ANSI or CCS7ITU application; the GPL allows the card to support 8 signaling links for E1 and T1 functions.

**utility**—Used by the factory for testing, and when directed by the Customer Care Center

**vcd**—Used in the card manufacturing process

**vsccp**—Used by Service Module cards to support the EPAP-based and the LNP ELAP Configuration features. If no EPAP-based or LNP ELAP Configuration feature is turned on, and if a Service Module card is present, then the GPL processes normal GTT traffic.

**vxwslan**—Used by SSEDCCM cards to support the STP LAN application

**:asname=** (optional)

Application server name. This parameter specifies the name of the application server.

**Range:** *aaaaaaaaaaaaaaaa*

Up to 15 alphanumeric characters; the first character must be a letter.

**:day=** (optional)

The specific day of the week for daily measurement reports.

**Range:** **mon, tue, wed, thu, fri, sat, sun**

**Default:** The previous single day report is generated.

**:hh=** (optional)

The specific half-hour interval. The **hh** parameter implies the ending time for the collection interval; for example, **hh=0300** generates a report for **2:30-3:00**.

**Range:** **0000-2400**

*hhmm* where *hh* = **00-24** (hour) and *mm* = **00** or **30** (minute)

**Default:** The **hh** parameter value is not given.

**:link=** (optional)

The link on the card specified in the **loc** parameter

**Synonym:** **port**

**Range:** **a, b, a1-a31, b1-b31**

Not all card types support all **link** parameter values.

See Table A-1 for valid **link** parameter range values for each type of card that can have assigned signaling link ports.

**Default:** The **link** parameter value is not given.

**:loc=** (optional)

The card location as stenciled on the shelf of the system.

**Range:** **1101-1108, 1111-1112, 1201-1208, 1211-1218, 1301-1308, 1311-1318, 2101-2108, 2111-2118, 2201-2208, 2211-2218, 2301-2308, 2311-2318, 3101-3108, 3111-3118, 3201-3208, 3211-3218, 3301-3308, 3311-3318, 4101-4108, 4111-4118, 4201-4208, 4211-4218, 4301-4308, 4311-4318, 5101-5108, 5111-5118, 5201-5208, 5211-5218, 5301-5308, 5311-5318, 6101-6108, 6111-6118**

**Default:** The **loc** parameter value is not given.

**:lsn=** (optional)

The name of the linkset for which link or linkset measurements are reported.

**Range:** *ayyyyyyyyy*

1 alphabetic character followed by up to 9 alphanumeric characters

**Default:** The **lsn** value is not given.

**:nc=** (optional)

The network cluster for the specified GTWY measurement report.

**Range:** **0-255**

**Default:** The **nc** parameter value is not given.

**:ni=** (optional)

The network indicator for the specified GTWY measurement report.

**Range:** **1-255**

**Default:** The **ni** parameter value is not given.

**:nzo=** (optional)

Print non-zero measurements only.

**Range:** **yes, no**

**Default:** **yes** for types **avl**, **avld**, and **avldth**.

This parameter is not used with the other report types.

**:period=** (optional)

The relative time period to report.

**Range:** **last, specific, active, all**

**last**— The previous collection interval

**specific**— A specific half-hourly interval (specified with the **hh** parameter)

**active**— The current collection interval

**all**— All collection intervals.

**Default:** The **period** parameter value is not given.

**:qh=** (optional)

The specific quarter-hour interval. The **qh** parameter implies the ending time for the collection interval; for example, **qh=0315** generates a report for **3:00-3:15**.

**Range:** **0000-2400**

*hhmm* where *hh* = **00-24** (hour) and *mm* = **00, 15, 30, or 45** (minute)

**Default:** The **qh** value is not given.

**:trm=** (optional)  
 The serial port (printer location) where the report is to be sent.  
**Range:** 1-16  
**Default:** The **trm** value is not given.

**:tt=** (optional)  
 A specific translation type to be reported.  
**Range:** 0-255  
**Default:** The **tt** parameter value is not given.

### Example

```
rept-meas:enttype=link:type=avl:loc=1201:link=a
rept-meas:enttype=lnp:type=mtch:period=specific:hh=1300
rept-meas:enttype=lnp:type=mtcd:period=specific:day=tue
rept-meas:type=systot:enttype=tt:tt=26
rept-meas:type=mtcd:enttype=sctpasoc:aname=assoc01
rept-meas:type=mtcdth:enttype=ua:aname=assoc01:asname=appserv01
```

### Dependencies

The **rept-meas** command cannot be used to specify a report type if that report type is currently printing.

The valid parameter combinations depend on the report type specified. These combinations are shown in Table 5-74. An X in a cell indicates that the parameter is valid for the report type shown.

When the Enhanced GSM MAP Screening (EGMS) feature is turned on, this command cannot be used to generate EGMS measurements reports.

The entity specified by the **loc** parameter must be in the database.

The link specified by the **loc** and **link** parameters must already be defined in the database.

Hourly collection and report processing cannot be in progress when report type **mtch** is specified.

Quarter-hourly collection and report processing cannot be in progress when report type **comp**, **systot**, **avl**, or **gtwy** is specified.

The **mtcdth** report type is unavailable between midnight and 1:00 AM (0100).

Day-to-hour collection and report processing cannot be in progress when report type **mtcd** or **mtcdth** is specified.

Daily collection and report processing cannot be in progress when report type **mtcd** is specified.

Half-hourly collection and report processing cannot be in progress when report type **comp**, **systot**, **avl**, or **gtwy** is specified.

5-minute collection and report processing cannot be in progress when report type **nm** is specified.

When **enttype=lnp**, only **mtcd** and **mtch** can be specified for the **type** parameter.

If the **nc** parameter is specified for origininc reports, then the **ni** parameter must be specified.

If the **ni** parameter is specified for origin reports, then measurements data must be available at the time the command is entered.

The **day** parameter can be specified only for report type **mtcd** and entity types **lnp** and **mapscrn**.

The **period=all** parameter can be specified only for **type=avl** and **enttype=lnp:type=mtcd** reports.

The LNP feature must be turned on (see the **enable-ctrl-feat** command) before the **enttype=lnp** parameter can be specified.

The GSM Map Screening feature must be turned on before the **enttype=mapscrn** parameter can be specified.

The 15 Minute Measurements feature must be turned on and the 15 Minute Measurements collection option must be on before the **qh** parameter can be specified.

The **qh** parameter must specify a quarter-hourly boundary (the end of the requested quarter-hour for the report) for valid report types (**avld**, **mtcd**, **nm**, **rbase**, and **mtcs** cannot be specified).

The **hh** parameter must specify a half-hourly boundary (the end of the requested half-hour for the report) for valid report types (**mtcd** and **nm** are excluded with message "E2307: QH or HH is not valid for this TYPE").

The **hh** and **qh** parameters cannot be specified together in the command.

When the **period=last** parameter is specified, the **hh** parameter, the **qh** parameter, or the **day** parameter cannot be specified.

If the **period=active** parameter is specified, then the **hh** and **qh** parameters cannot be specified.

When the **period=specific** parameter is specified, the **hh** parameter, the **qh** parameter, or the **day** parameter must be specified. The **hh**, **qh**, and **day** parameters can be specified only if the **period=specific** parameter is specified.

A half-hour boundary must be specified for the **hh** parameter, except for report type **mtch**; an hourly boundary must be specified for report type **mtch** (that is, only half hours ending in **00**, such as **0100**, **0200** or **0300**).

A quarter-hour boundary must be specified for the **qh** parameter, except for report type **mtch**; an hourly boundary must be specified for report type **mtch** (that is, only quarter hours ending in **00**, such as **0100**, **0200** or **0300**).

The **hh** parameter and the **qh** parameter cannot be specified when report type **avld**, **mtcd**, **nm**, **rbase**, or **mtcs** is specified.

If the **link** parameter is specified, the **loc** parameter must be specified.

The **lsn** and **loc** parameters cannot be specified together in the command.

If the **enttype=link** parameter is specified, then the **loc** and **port** parameters or the **lsn** parameter must be specified.

The **enttype=stplan** and the **type=avl** parameters must be specified before the **appl** parameter can be specified.

When the **appl** parameter is specified, the **period=active** parameter and the **period=all** parameter cannot be specified.

The **period=active** parameter cannot be specified when the **enttype=stp** parameter or the **enttype=tt** parameter is specified.

The **lsn** parameter cannot be specified with the following parameters: **enttype=stp/tt/stplan/origni/origninc/lnp/np/mapscrn** or **type=systot**.

For entity type **avl**, if **period=all** is specified, the **loc** and **port** parameters must be specified.

The **nzo** parameter is used only for entity types **avl**, **avld**, and **avldth**.

The **appl** and **loc** parameters cannot be specified in the same command line.

When **enttype=lnp**, the **trm** parameter cannot be specified because LNP measurements can be written only to the FTA. To retrieve this data, use the procedure described with the **act-file-trns** command information.

For the **stplan-avl** reports (**enttype=stplan** and **type=avl** parameters), if the **appl** parameter is specified, the **period=active** and **period=all** parameters cannot be specified.

The **type=systot** and **loc** parameters cannot be specified in the same command line.

When **enttype=lnp** and **type=mtch**, only **last** and **specific** can be specified for the **period** parameter.

When **enttype=lnp**, **nzo=yes** cannot be specified.

If the **enttype=lnp** parameter is specified, then the **appl** parameter cannot be specified.

The **tt** parameter must be specified when **enttype=tt**. The only time the **tt** parameter is valid is when it is specified with **enttype=tt**.

If the **type=gtwy** parameter is specified, and the value of the **enttype** parameter is **lsorigni**, **lsdestni**, or **lsonismt**, then the **ni** parameter cannot be specified for ITU linksets. The **ni** parameter is allowed only for ANSI linksets.

If the **type=gtwy:enttype=lsdestni** parameter combination is specified for an ITU linkset, only the **lsn** parameter can be specified.

If the **type=gtwy:enttype=lsorigni** parameter combination is specified for an ITU linkset, only the **lsn** parameter can be specified.

If the **type=gtwy:enttype=lsonismt** parameter combination is specified for an ITU linkset, only the **lsn** parameter can be specified.

**Table 5-74.** Valid Parameter Combinations for the **type** Parameter

| Parameter Value | Report Types (type parameter) |      |      |        |      |      |    |     |      |        |      |       |   |
|-----------------|-------------------------------|------|------|--------|------|------|----|-----|------|--------|------|-------|---|
|                 | systot                        | comp | mtcd | mtcdth | mtch | mtcs | nm | avl | avld | avldth | gtwy | rbase |   |
| <b>enttype=</b> |                               |      |      |        |      |      |    |     |      |        |      |       |   |
| stp             | X                             |      | X    | X      |      | X    |    |     |      |        | X    | X     |   |
| link            |                               | X    | X    | X      |      | X    | X  | X   | X    | X      |      |       | X |
| lnkset          |                               | X    | X    | X      |      | X    | X  |     |      |        | X    | X     |   |
| lnp             |                               |      | X    |        | X    |      |    |     |      |        |      |       |   |
| tt              | X                             |      |      |        |      |      |    |     |      |        |      |       |   |
| stplan          | X                             |      | X    | X      |      |      |    | X   |      |        |      |       |   |
| origni          |                               |      |      |        |      |      |    |     |      |        |      | X     |   |
| originic        |                               |      |      |        |      |      |    |     |      |        |      | X     |   |
| lsdestni        |                               |      |      |        |      |      |    |     |      |        |      | X     |   |
| lsonismt        |                               |      |      |        |      |      |    |     |      |        |      | X     |   |
| lsorigni        |                               |      |      |        |      |      |    |     |      |        |      | X     |   |
| np              |                               |      | X    |        | X    |      |    |     |      |        |      |       |   |
| mapscrn         |                               |      | X    |        | X    |      |    |     |      |        |      |       |   |
| sctpasoc        |                               | X    | X    | X      |      |      |    |     |      |        |      |       |   |
| sctpcard        |                               | X    | X    | X      |      |      |    |     |      |        |      |       |   |
| ua              |                               | X    | X    | X      |      |      |    |     |      |        |      |       |   |
| <b>period=</b>  |                               |      |      |        |      |      |    |     |      |        |      |       |   |
| last            | X                             | X    | X    | X      | X    |      | X  | X   | X    | X      | X    |       |   |
| specific        | X                             | X    |      |        | X    |      |    | X   |      |        |      | X     |   |
| active          |                               | X    |      |        |      | X    | X  | X   |      |        |      |       | X |

**Table 5-74.** Valid Parameter Combinations for the **type** Parameter

| Parameter Value | Report Types (type parameter) |      |      |        |      |      |    |     |      |        |      |       |  |
|-----------------|-------------------------------|------|------|--------|------|------|----|-----|------|--------|------|-------|--|
|                 | systot                        | comp | mtcd | mtcdth | mtch | mtcs | nm | avl | avld | avldth | gtwy | rbase |  |
| all             |                               |      | X    |        |      |      |    | X   |      |        |      |       |  |
| nzo             |                               |      |      |        |      |      |    | X   | X    | X      |      |       |  |

If the **enttype=sctpcard** parameter is specified, then the card in the location specified by the **loc** parameter must be an IPLIMx, IPGWx, or IPSG card.

The **enttype=sctpasoc** or **enttype=ua** parameter must be specified before the **aname** parameter can be specified.

The **enttype=ua** parameter must be specified before the **aname** parameter can be specified.

The G-Port, INP, or AINPQ feature must be turned on before the **entitytype=np** parameter can be specified.

If the **enttype=sctpcard** parameter is specified, then the **loc** parameter must be specified.

If the **enttype=sctpcard** parameter is specified, then a card must be installed in the location specified by the **loc** parameter.

The value of the **appl** parameter must apply to the reports specified in the **enttype** and **type** parameters.

The **enttype=link** parameter must be specified before the **link** parameter can be specified.

The linkset specified by the **lsn** parameter must contain the link specified by the **enttype=link** and **type** parameters.

The **type=gtwy** parameter and the **enttype=originic** parameter must be specified before the **nc** value can be specified. If the **enttype=lnp** parameter is specified, then the **nc** value cannot be specified.

The **type=gtwy** parameter must be specified, and a value of **lsdestni**, **lsonismt**, **lsoignic**, **origni**, or **originic** must be specified for the **enttype** parameter before the **ni** value can be specified. If the **enttype=lnp** parameter is specified, then the **ni** value cannot be specified.

The **enttype=tt** parameter must be specified before the **tt** parameter can be specified.

If a value of **sctpasoc** or **ua** is specified for the **enttype** parameter, then the **aname** parameter must be specified.

The association specified by the **aname** parameter must be provisioned in the system.

The card in the location specified by the **loc** parameter must match the type of card specified in the **enttype** parameter.

If the **enttype=ua** parameter is specified, then the **aname** parameter must be specified.

The application server specified by the **aname** parameter must be provisioned in the system.

The association specified by the **aname** parameter must be assigned to the application server specified by the **aname** parameter.

The **lsn** and **link** parameters cannot be specified together in the command.

If the **enttype=lnp** parameter is specified, then the **loc** parameter cannot be specified.

If the **enttype=lnp** parameter is specified, then the **link** parameter cannot be specified.

If the **enttype=lnp** parameter is specified, then the **lsn** parameter cannot be specified.

If the **period=all** parameter is specified, then the **hh** and **qh** parameters cannot be specified.

The value specified for the **lsn** parameter must already exist in the database.

The A-Port, G-Port, IS41 GSM Migration, Prepaid SMS Intercept Ph1, TIF ASD, TIF GRN, TIF Number Portability, or TIF Simple Number Substitution feature must be enabled, or the INP, MO SMS IS41-to-GSM Migration, MO-based GSM SMS NP, or MO-based IS41 SMS NP feature must be turned on before the **mtchnp=on** parameter or the **mtcdnp=on** parameter can be specified.

The value specified for the **appl** parameter must be a supported GPL. See the **appl** definition for a list of supported GPLs.

### Notes

INP, GSM MAP screening, LNP, G-Port, A-Port, and IGM measurements are sent to the FTA (file transfer area) rather than to the EAGLE 5 ISS terminal.

If an on-demand report is requested while the collection for that interval is in progress, the requested report will not be generated. The **rept-meas** command must be entered again.

When the **rept-meas** command is executed, the following warning message may appear:

```
Measurement data represents an incomplete interval
```

This message indicates that one or more cards did not respond to the request for measurements because the card was Out-Of-Service. The message does not indicate that data was lost.

### Output

**NOTE: Refer to the *Measurements Manual (910-5452-001)* for the EAGLE 5 ISS to obtain current output examples for the **rept-meas** command.**

## rept-stat-alm

## Report Status Alarm

Use this command to provide status of all alarms.

**Keyword:** **rept-stat-alm**

**Related Commands:** **dact-alm-trns, rept-stat-clk, rept-stat-trbl, rtrv-obit, rtrv-trbl**

**Command Class:** System Maintenance

### Parameters

**:cli=** (optional)

CLLI string. This parameter allows the user to see only alarms that pertain to a particular CLLI.

**Range:** *ayyyyyyyyyy*

**:dev=** (optional)

Device. This parameter provides the type of device for which alarms are displayed. The **display=inhb** parameter must be specified when this parameter is specified.

**Range:** **applsock, as, card, cdt, clock, dlk, ls, lsmconn, route, seasx25, slk, trm, rtx, elport, t1port, tps, enet**

**:display=** (optional)

Type of alarms to be displayed. When the **disply=inhb** parameter is specified, the Alarm Inhibit Report appears in the command output and provides information about inhibited alarms in the system. The **dev** parameter can be specified with this parameter to display the Alarm Inhibit Report for a specific device type.

**Range:** **inhb**



**:dur=** (optional)

Duration. This parameter indicates whether to display permanently inhibited alarms, temporarily inhibited alarms, or timed inhibited alarms. This parameter is valid only when the **display=inhb** parameter is specified.

**Range:** **perm, temp, timed**

**:edate=** (optional)

Expiry date. This parameter allows the user to see timed alarm inhibits that will expire on the specified date.

**Range:** **101-991231**

Specify the date in the format *year*, followed by *month*, followed by *day*.

**Example**

```
rept-stat-alm
rept-stat-alm:display=inhb:dev=card
rept-stat-alm:display=inhb:clli=slkset1:dev=ls
rept-stat-alm:display=inhb
rept-stat-alm:display=inhb:dur=timed
rept-stat-alm:display=inhb:dur=timed:edate=040520
```

**Dependencies**

No other **rept-stat-xxx** command can be in progress when this command is entered.

The **dur** parameter can be specified only if the **display=inhb** parameter is specified.

The **dur**, **dev** or **clli** parameter can be specified only if the **display=inhb** parameter is specified.

The **edate** parameter can be specified only if the **dur=timed** parameter is specified.

The **dev** parameter can have only the values **slk**, **ls**, or **route** if the **clli** parameter is specified.

The **dur** parameter must be compatible with the specified device.

The value specified for the **clli** parameter must already exist in the DSTN table.

The value specified for the **edate** parameter must be greater than the system date.

**Notes**

None

**Output**

The following example shows output when the system is clean and before a maintenance baseline has been established:

**rept-stat-alm**

```
rlghncxa03w 06-05-27 15:00:53 EST EAGLE 35.0.0
ALARM TRANSFER= LMC
ALARM MODE CRIT= SILENT MAJR= SILENT MINR= SILENT
ALARM FRAME 1 CRIT= 0 MAJR= 0 MINR= 0
ALARM FRAME 2 CRIT= 0 MAJR= 0 MINR= 0
ALARM FRAME 3 CRIT= 0 MAJR= 0 MINR= 0
ALARM FRAME 4 CRIT= 0 MAJR= 0 MINR= 0
ALARM FRAME 5 CRIT= 0 MAJR= 0 MINR= 0
ALARM FRAME 6 CRIT= 0 MAJR= 0 MINR= 0
ALARM FRAME OAP CRIT= 0 MAJR= 0 MINR= 0
ALARM FRAME GPF CRIT= 0 MAJR= 0 MINR= 0
TOTAL ALARMS CRIT= 0 MAJR= 0 MINR= 0
PERM. INH. ALARMS CRIT= 0 MAJR= 0 MINR= 0
TEMP. INH. ALARMS CRIT= 0 MAJR= 0 MINR= 0
TIMED. INH. ALARMS CRIT= 0 MAJR= 0 MINR= 0
ACTIVE ALARMS CRIT= 0 MAJR= 0 MINR= 0
```

Command Completed.

;

The following example shows output after critical and minor alarms are generated. Major alarms still show SILENT:

**rept-stat-alm**

```
rlghncxa03w 06-05-27 15:00:53 EST EAGLE 35.0.0
ALARM TRANSFER= LMC
ALARM MODE CRIT= AUDIBLE MAJR= SILENT MINR= AUDIBLE
ALARM FRAME 1 CRIT= 7 MAJR= 0 MINR= 10
ALARM FRAME 2 CRIT= 0 MAJR= 0 MINR= 0
ALARM FRAME 3 CRIT= 0 MAJR= 0 MINR= 0
ALARM FRAME 4 CRIT= 0 MAJR= 0 MINR= 0
ALARM FRAME 5 CRIT= 0 MAJR= 0 MINR= 0
ALARM FRAME 6 CRIT= 0 MAJR= 0 MINR= 0
ALARM FRAME OAP CRIT= 0 MAJR= 0 MINR= 0
ALARM FRAME GPF CRIT= 0 MAJR= 0 MINR= 0
PERM. INH. ALARMS CRIT= 2 MAJR= 0 MINR= 0
TEMP. INH. ALARMS CRIT= 3 MAJR= 0 MINR= 0
TIMED. INH. ALARMS CRIT= 0 MAJR= 0 MINR= 0
ACTIVE ALARMS CRIT= 2 MAJR= 0 MINR= 10
TOTAL ALARMS CRIT= 7 MAJR= 0 MINR= 10
```

Command Completed.

;

The following example shows inhibited alarms:

**rept-stat-alm**

```
rlghncxa03w 06-05-27 15:00:53 EST EAGLE 35.0.0
ALARM TRANSFER= RMC
ALARM MODE CRIT= AUDIBLE MAJR= SILENT MINR= AUDIBLE
ALARM FRAME 1 CRIT= 3 MAJR= 16 MINR= 22
ALARM FRAME 2 CRIT= 0 MAJR= 0 MINR= 0
ALARM FRAME 3 CRIT= 0 MAJR= 0 MINR= 0
ALARM FRAME 4 CRIT= 0 MAJR= 0 MINR= 0
ALARM FRAME 5 CRIT= 0 MAJR= 0 MINR= 0
ALARM FRAME 6 CRIT= 0 MAJR= 0 MINR= 0
ALARM FRAME OAP CRIT= 0 MAJR= 0 MINR= 0
ALARM FRAME GPF CRIT= 1 MAJR= 2 MINR= 1
```

```

PERM. INH. ALARMS CRIT= 0 MAJR= 10 MINR= 0
TEMP. INH. ALARMS CRIT= 0 MAJR= 8 MINR= 0
TIMED. INH. ALARMS CRIT= 0 MAJR= 0 MINR= 0
ACTIVE ALARMS CRIT= 4 MAJR= 0 MINR= 22
TOTAL ALARMS CRIT= 4 MAJR= 18 MINR= 23
    
```

Command Completed.

;

The following example includes the Alarm Inhibit report for the card in location 1301.

**rept-stat-alm:display=inhb:dev=card**

```

rlghncxa03w 06-05-27 15:00:53 EST EAGLE 35.0.0
ALARM TRANSFER= RMC
ALARM MODE CRIT= SILENT MAJR= SILENT MINR= SILENT
ALARM FRAME 1 CRIT= 11 MAJR= 24 MINR= 17
ALARM FRAME 2 CRIT= 0 MAJR= 0 MINR= 0
ALARM FRAME 3 CRIT= 0 MAJR= 0 MINR= 0
ALARM FRAME 4 CRIT= 0 MAJR= 0 MINR= 0
ALARM FRAME 5 CRIT= 0 MAJR= 0 MINR= 0
ALARM FRAME 6 CRIT= 0 MAJR= 0 MINR= 0
ALARM FRAME OAP CRIT= 1 MAJR= 6 MINR= 1
PERM. INH. ALARMS CRIT= 0 MAJR= 4 MINR= 2
TEMP. INH. ALARMS CRIT= 1 MAJR= 3 MINR= 1
TIMED. INH. ALARMS CRIT= 0 MAJR= 0 MINR= 0
ACTIVE ALARMS CRIT= 11 MAJR= 23 MINR= 15
TOTAL ALARMS CRIT= 13 MAJR= 30 MINR= 18
    
```

ALARM INHIBIT REPORT

```

-----
DEVICE DEVICE IDENTIFIER DURATION INH LVL ALM LVL DATE TIME
-----
CARD 1301 PERM MAJR MAJR --- ---
    
```

Command Completed.

;

The following example includes the Alarm Inhibit report for multiple device types. It includes point codes with point code subtype prefixes, and exception routes that require a second line of display to uniquely identify the exception class/criteria of the routes. A plus sign (+) following the alarm level indicates that the current alarm is not inhibited because the level of the inhibit is less than the level of the alarm.

**rept-stat-alm:display=inhb**

```

rlghncxa03w 07-02-10 15:00:53 EST EAGLE 35.6.0
ALARM TRANSFER= RMC
ALARM MODE CRIT= AUDIBLE MAJR= SILENT MINR= SILENT
ALARM FRAME 1 CRIT= 2 MAJR= 8 MINR= 0
ALARM FRAME 2 CRIT= 0 MAJR= 0 MINR= 0
ALARM FRAME 3 CRIT= 0 MAJR= 0 MINR= 0
ALARM FRAME 4 CRIT= 0 MAJR= 0 MINR= 0
ALARM FRAME 5 CRIT= 0 MAJR= 0 MINR= 0
ALARM FRAME 6 CRIT= 0 MAJR= 0 MINR= 0
ALARM FRAME OAP CRIT= 0 MAJR= 0 MINR= 0
PERM. INH. ALARMS CRIT= 0 MAJR= 1 MINR= 0
TEMP. INH. ALARMS CRIT= 0 MAJR= 1 MINR= 0
TIMED. INH. ALARMS CRIT= 0 MAJR= 0 MINR= 0
ACTIVE ALARMS CRIT= 2 MAJR= 6 MINR= 0
TOTAL ALARMS CRIT= 2 MAJR= 8 MINR= 0
    
```

ALARM INHIBIT REPORT

```

-----
DEVICE DEVICE IDENTIFIER DURATION INH LVL ALM LVL DATE TIME
-----
CARD 1101 PERM MINR MAJR+ --- ---
    
```

```

ENET      1201,A          PERM      MAJR      MAJR      ---      ---
ENET      1201,B          TEMP      MAJR      MAJR      ---      ---
ENET      1101,A          PERM      MINR      MAJR+     ---      ---

```

Command Completed.

;

The following example displays timed inhibited alarm information.

**rept-stat-alm:display=inhb:dur=timed**

```

rlghncxa03w 06-05-27 15:00:53 EST EAGLE 35.0.0
ALARM TRANSFER= RMC
ALARM MODE          CRIT= SILENT          MAJR= SILENT          MINR= SILENT
ALARM FRAME 1      CRIT= 5              MAJR= 3              MINR= 6
ALARM FRAME 2      CRIT= 0              MAJR= 0              MINR= 0
ALARM FRAME 3      CRIT= 0              MAJR= 0              MINR= 0
ALARM FRAME 4      CRIT= 0              MAJR= 0              MINR= 0
ALARM FRAME 5      CRIT= 0              MAJR= 0              MINR= 0
ALARM FRAME 6      CRIT= 0              MAJR= 0              MINR= 0
ALARM FRAME OAP    CRIT= 0              MAJR= 0              MINR= 0
PERM. INH. ALARMS CRIT= 0              MAJR= 0              MINR= 0
TEMP. INH. ALARMS CRIT= 0              MAJR= 0              MINR= 0
TIMED. INH. ALARMS CRIT= 1              MAJR= 2              MINR= 1
ACTIVE ALARMS      CRIT= 4              MAJR= 1              MINR= 5
TOTAL ALARMS       CRIT= 5              MAJR= 3              MINR= 6

```

ALARM INHIBIT REPORT

```

-----
DEVICE  DEVICE IDENTIFIER  DURATION  INH LVL  ALM LVL  DATE      TIME
-----
ROUTE ps-004-005-006      TIMED     CRIT     CRIT     06-08-01 1000
E1PORT 1101,1              TIMED     MAJR     MAJR     06-10-05 1200
T1PORT 1301,3              TIMED     MAJR     MAJR     06-08-01 1100
APPLSOCK sock1234567890      TIMED     MINR     MAJR     06-10-05 1100

```

Command Completed.

;

The following example displays timed inhibited alarm information for alarms that will expire on the specified date.

**rept-stat-alm:display=inhb:dur=timed:edate=061001**

```

upg1040403 06-05-27 14:09:58 EST EAGLE 35.0.0
ALARM TRANSFER= RMC
ALARM MODE          CRIT= SILENT          MAJR= SILENT          MINR= SILENT
ALARM FRAME 1      CRIT= 5              MAJR= 3              MINR= 6
ALARM FRAME 2      CRIT= 0              MAJR= 0              MINR= 0
ALARM FRAME 3      CRIT= 0              MAJR= 0              MINR= 0
ALARM FRAME 4      CRIT= 0              MAJR= 0              MINR= 0
ALARM FRAME 5      CRIT= 0              MAJR= 0              MINR= 0
ALARM FRAME 6      CRIT= 0              MAJR= 0              MINR= 0
ALARM FRAME OAP    CRIT= 0              MAJR= 0              MINR= 0
PERM. INH. ALARMS CRIT= 0              MAJR= 0              MINR= 0
TEMP. INH. ALARMS CRIT= 0              MAJR= 0              MINR= 0
TIMED. INH. ALARMS CRIT= 1              MAJR= 2              MINR= 1
ACTIVE ALARMS      CRIT= 4              MAJR= 1              MINR= 5
TOTAL ALARMS       CRIT= 5              MAJR= 3              MINR= 6

```

ALARM INHIBIT REPORT

```

-----
DEVICE  DEVICE IDENTIFIER  DURATION  INH LVL  ALM LVL  DATE      TIME
-----
ROUTE ps-004-005-006      TIMED     CRIT     CRIT     06-10-01 1000
E1PORT 1101,1              TIMED     MAJR     MAJR     06-10-01 1200

```

Command Completed.

;

The following example displays inhibited alarm information for the linksets with the specified CLLI.

**rept-stat-alm:display=inhb:clli=slkset1:dev=ls**

```
upg1040403 06-05-27 14:09:58 EST EAGLE 35.0.0
ALARM TRANSFER= RMC
ALARM MODE          CRIT= SILENT          MAJR= SILENT          MINR= SILENT
ALARM FRAME 1      CRIT= 5              MAJR= 3              MINR= 6
ALARM FRAME 2      CRIT= 0              MAJR= 0              MINR= 0
ALARM FRAME 3      CRIT= 0              MAJR= 0              MINR= 0
ALARM FRAME 4      CRIT= 0              MAJR= 0              MINR= 0
ALARM FRAME 5      CRIT= 0              MAJR= 0              MINR= 0
ALARM FRAME 6      CRIT= 0              MAJR= 0              MINR= 0
ALARM FRAME OAP    CRIT= 0              MAJR= 0              MINR= 0
PERM. INH. ALARMS CRIT= 0              MAJR= 0              MINR= 0
TEMP. INH. ALARMS CRIT= 0              MAJR= 0              MINR= 0
TIMED. INH. ALARMS CRIT= 1              MAJR= 2              MINR= 1
ACTIVE ALARMS      CRIT= 4              MAJR= 1              MINR= 5
TOTAL ALARMS       CRIT= 5              MAJR= 3              MINR= 6
```

ALARM INHIBIT REPORT

```
-----
DEVICE  DEVICE IDENTIFIER  DURATION  INH LVL  ALM LVL  DATE  TIME
-----  -
LS      slkset1              TIMED     MAJR     MAJR     06-10-01 1200
```

Command Completed.

**Legend**

**ALARM TRANSFER**—The destination of the alarms. LMC=Local Maintenance Center, RMC=Remote Maintenance Center.

**ALARM MODE**—Displays whether the critical, major, and minor alarms are silent or audible

**ALARM FRAME 1**—The number of critical, major, and minor alarms detected in the control frame CF-00 (frame 1).

**ALARM FRAME 2**—The number of critical, major, and minor alarms detected in extension frame EF-00 (frame 2).

**ALARM FRAME 3**—The number of critical, major, and minor alarms detected in extension frame EF-01 (frame 3).

**ALARM FRAME 4**—The number of critical, major, and minor alarms detected in extension frame EF-02 (frame 4).

**ALARM FRAME 5**—The number of critical, major, and minor alarms detected in extension frame EF-03 (frame 5).

**ALARM FRAME 6**—The number of critical, major, and minor alarms detected in extension frame EF-04 (frame 6).

**ALARM FRAME OAP**—The number of critical, major, and minor alarms detected in the OAP Frame.

**ALARM FRAME GPF**—The number of critical, major, and minor alarms detected at the MPS (multi-purpose server). If the LNP feature is turned on, the number includes alarms for any applications running on the MPS. If the G-Flex, G-Port, INP, or AINP Q feature is turned on, the number includes alarms for any applications running on the GSM subsystem and the DSM/EPAP links.

**PERM. INH. ALARMS**—The number of alarms that are permanently inhibited per alarm level.

**TEMP. INH. ALARMS**—The number of alarms that are temporarily inhibited per alarm level.

**TIMED. INH. ALARMS**—The number of alarms that are timed inhibited per alarm level.

**ACTIVE ALARMS**—The number of alarms still active per alarm level.

**TOTAL ALARMS**—The total number of alarms per alarm level. The inhibited alarm count plus the active alarm count equals the total alarm count.

**CRIT**—Critical alarms with silent/audible indicator.

**MAJOR**—Major alarms with silent/audible indicator.

**MINOR**—Minor alarms with silent/audible indicator.

Alarm Inhibit Report:

**DEVICE**—The device for which alarms are currently inhibited. Only devices that are alarm inhibited are shown.

**ELEMENT**—The element of the device for which alarms are inhibited (such as card location, port, routing key, socket or association name)

**DURATION**—Indicates whether the device is alarm inhibited permanently or temporarily or for a specific length of time

**INH LVL**—Level in which devices are alarm inhibited (Critical, Major, Minor). The **inh-alm** command defaults the level to Major. Devices cannot be alarm inhibited at a critical level unless the **chg-stpopt** command **criticalminh** parameter is turned on.

**CUR LVL**—Level of the current alarm on the device (Critical, Major, Minor). "None" indicates that there is currently no alarm on the device (DUR should show "PERM." A plus sign (+) seen following the alarm level indicates that the current alarm is not inhibited because the level of the inhibit is less than the level of the alarm.

**DATE**—The date on which a timed inhibited alarm will automatically clear at the specified time

**TIME**—The time at which a timed inhibited alarm will automatically clear on the specified date

## rept-stat-applsock

## Report Status Application Socket

Use this command to display the status of the IP application sockets.

**Keyword:** **rept-stat-applsock**

**Related Commands:** ,,

**Command Class:** System Maintenance

### Parameters

**:lhost=** (optional)

Local host name. The logical name assigned to the local host device.

**Range:** *xxxxxxxxxxxxxxxxxxxxxxxxxxxxxxxxxxxxxxxxxxxxxxxxxxxxxxxxxxxxxxxxxxxxxxxxxxxx*

A string of characters up to 60 characters in length. The first character must be a letter.

Valid characters are **a-z**, **A-Z**, **0-9**, - (dash), . (period)

**Default:** Current value

**:port=** (optional)

The signaling link port associated with this socket.

**Range:** **a, b, a1..a31, b1..b31**

Not all card types support all **port** parameter values.

See Table A-1 for valid **port** parameter range values for each type of card that can have signaling links.

**Default:** Current value

**:rhost=** (optional)

Remote host name. The logical name assigned to the remote host device.

**Range:** *aaaaaaaaaaaaaaaaaaaaaaaaaaaaaaaaaaaaaaaaaaaaaaaaaaaaaaaaaaaaaaaa*

A string of characters up to 60 characters in length. The first character must be a letter.

Valid characters are **a-z, A-Z, 0-9, -** (dash), **.** (period)

**Default:** Current value

**:sname=** (optional)

Socket name. The name of the IP application socket that is to be reported.

**Range:** *aaaaaaaaaaaaaaaa*

Up to 15 alphanumeric characters; the first character must be a letter

**Default:** All IP application sockets are reported

**Example**

**rept-stat-applsock**

**rept-stat-applsock:port=b**

**Dependencies**

The **sname** parameter value, if specified, must exist in the Socket table.

The value specified for the **host** parameter must begin with an alphabetic character and can contain **a..z, A..Z, 0..9, -** (hyphen), or **.** (period). If the host name contains a hyphen, then the host name must be enclosed within quotation marks.

**Notes**

This command displays the primary states (PST) and the secondary state (SST). Primary states are:

IS-NR—In-service normal

IS-ANR—In-service abnormal (congested)

OOS-MT—Out of service

OOS-MT-DSBLD—Out-of-service maintenance-disabled (provisioned to be out of service by closing, prohibiting, or deactivation)

Secondary states are:

ALMINH—Alarm inhibited

OOS—Out-of-service

NEA—Near-end allowed

FEA—Far-end allowed

NEP—Near-end prohibited

FEP—Far-end prohibited

**Output**

```

rept-stat-applsock
  rlghncxa03w 04-02-17 15:35:05 EST EAGLE 31.3.0
  SOCKET          PST          SST
  socred          OOS-MT       ALMINH
  socyellow       IS-ANR       ----
  socblue         OOS-MT-DSBLD ----
  Command Completed
;

rept-stat-applsock
  rlghncxa03w 04-02-17 15:35:05 EST EAGLE 31.3.0
  SOCKET          PST          SST
  ipg11051        IS-NR        NEA-FEA
  ipg11071        IS-NR        NEA-FEA
  ipl1201         IS-NR        NEA-FEA
  Command Completed.
;

rept-stat-applsock:link=b
  rlghncxa03w 04-02-17 15:35:05 EST EAGLE 34.0.0
  SOCKET          PST          SST
  ipl1201b        IS-NR        NEA-FEA
  Command Completed.
;

```

**rept-stat-as****Report Status AS Association**

Use this command to generate a report of the Application Server (AS) association status.

**Keyword:** **rept-stat-as**

**Related Commands:** **chg-as, ent-as, rtrv-as**

**Command Class:** System Maintenance

**Parameters**

**:aname=** (optional)

Association name to report on. When the **aname** parameter is specified, the **rept-stat-as** command will report the ASP states for a given association in all of the AS's that it is assigned to.

**Range:** *aaaaaaaaaaaaaaaa*

Up to 15 alphanumeric characters; the first character must be a letter.

**:asname=** (optional)

Application Server name; the AS name to report on. When the **asname** parameter is specified, the **rept-stat-as** command will report the PST, SST, ASP state, and ASP-ID for each association in the AS.

**Range:** *aaaaaaaaaaaaaaaa*

Up to 15 alphanumeric characters; the first character must be a letter

**Example**

```
rept-stat-as
```

**Dependencies**

If an association is specified in the command, the specified association must exist in the AS table.

**Notes**

This command can be canceled using the **F9** function key or the **canc-cmd** command. See **canc-cmd** for more information.





**Synonym: port****Range:** a, b, a1-a31, b1-b31Not all card types support all **link** parameter values.See Table A-1 for valid **link** parameter range values for each type of card that can have assigned signaling links ports.**:rhost=** (optional)

Name of Remote Host as defined in the IP Host table.

**Range:** ~~~~~

A string of characters up to 60 characters in length. The first character must be a letter.

Valid characters are **a-z, A-Z, 0-9, -** (dash), and **.** (period).**Example****rept-stat-assoc****rept-stat-assoc:aname= a23456789012345****Dependencies**

If an association is specified in the command, the specified association must exist in the AS table.

The value specified for the **host** parameter must begin with an alphabetic character and can contain **a..z, A..Z, 0..9, -** (hyphen), or **.** (period). If the host name contains a hyphen, then the host name must be enclosed within quotation marks.**Notes**This command can be canceled using the **F9** function key or the **canc-cmd** command. See **canc-cmd** for more information.

This command displays the primary states (PST) and the secondary state (SST).

Primary states are:

IS-NR—In-service normal

IS-ANR—In-service abnormal (congested)

OOS-MT—Out of service

OOS-MT-DSBLD—Out-of-service maintenance-disabled (provisioned to be out of service by closing, prohibiting, or deactivation)

Connection states are:

RESTRICTED

OUT-OF-SERVICE

CONNECTING

ESTABLISHED—Valid only for M2PA associations

The **LINK** field values in the output are displayed as:

- "\*\*\*"—If the association is assigned to multiple links.
- "--"—If the association is not assigned to any link.
- Appropriate LINK ID—If the association is assigned to only one link.

Output

**rept-stat-assoc**

```
eagle10212 08-01-29 10:41:52 EST EAGLE 38.0.0
CARD IPLNK
ANAME      LOC  PORT  LINK PST          SST          ASPID
ipgi1303a  1303 A    A    OOS-MT        OOS          undefined
ipl1301b   1301 A    B    IS-NR        ESTABLISHED
a1         1305 A    **   OOS-MT-DSBLD OOS          undefined
ipgl308a1  1308 A    A    OOS-MT-DSBLD OOS          undefined
sca        1306 A    A    IS-ANR        CONGESTED
a2         1304 A    A    IS-ANR        EXCESS RETRANS undefined
sca7       1307 A,B  A    IS-NR        ESTABLISHED  undefined
lavern     1305 A    A    IS-NR        ESTABLISHED
ipl1313b   1313 A    B    OOS-MT-DSBLD OOS
ipl1302a   1302 A    A    IS-NR        ESTABLISHED
n          1315 A    A    OOS-MT        CONNECTING
ipgl305a1  1305 A    A    OOS-MT-DSBLD OOS          undefined
ipl1301b3  1301 A    B3   IS-NR        ESTABLISHED
m2pa1107a0 1107 A    --   OOS-MT-DSBLD OOS
m2pa1107a1 1107 A    --   OOS-MT-DSBLD OOS
ipgl215a01 1215 A    **   IS-NR        ESTABLISHED  undefined
ipgl215a02 1215 A    **   IS-NR        ESTABLISHED  undefined
ipgl215a03 1215 A    --   OOS-MT-DSBLD OOS          undefined
ipgl215a04 1215 A    **   OOS-MT        OOS          undefined
ipgl215a05 1215 A    --   OOS-MT-DSBLD OOS          undefined
sg1305a    1305 A    A    IS-NR        ESTABLISHED  undefined
Command Completed.
```

The following example displays the resulting output when the **aname** parameter is specified for an IPGWx association:

**rept-stat-assoc:aname=a2**

```
eagle10212 08-01-29 10:41:52 EST EAGLE 38.0.0
CARD IPLNK
ANAME      LOC  PORT  LINK PST          SST          ASPID
a2         1304 A    A    IS-ANR        EXCESS RETRANS
undefined

ALARM STATUS = * 0536 IP Connection Excess Retransmits

ASNAME     ANAME     ASP-STATE
as1        a2        ASP-UP

Command Completed.
```

The following example displays the resulting output when the **aname** parameter is specified for an M2PA association:

**rept-stat-assoc:aname=assocm2pa**

```
eagle10212 07-05-29 10:41:52 EST EAGLE 37.0.0
CARD IPLNK
ANAME      LOC  PORT  LINK PST          SST
assocm2pa  1301 A    A    IS-NR        ESTABLISHED

Command Completed.
```

The following example displays the resulting output when the **aname** parameter is specified for an IPSG-M3UA association:

**rept-stat-assoc:aname=sg1305a**

```
eagle10212 08-02-06 17:00:42 EST EAGLE 38.0.0
CARD IPLNK
ANAME      LOC  PORT  LINK PST          SST          ASPID
sg1305a    1305 A    A    IS-NR        ESTABLISHED  undefined
```

|         |         |           |
|---------|---------|-----------|
| LSN     | ANAME   | ASP STATE |
| ls1305a | sg1305a | ACTIVE    |

Command Completed.

## rept-stat-card

## Report Status Card

Use this command to display the card status and maintenance activity states. The output includes card location, the GPL version being used by the card, device type, device primary state, device secondary state, and device associated state.

**Keyword:** `rept-stat-card`

**Related Commands:** `dlt-card`, `ent-card`, `init-card`, `rmv-card`, `rst-card`, `rtrv-card`

**Command Class:** System Maintenance

### Parameters

**:appl=** (optional)

Application. This parameter is specified to report the status of cards running the specified application.

**Range:** `xyyyyyy`

1 alphabetic character followed by up to 6 alphanumeric characters. Valid applications are:

**atmansi**—The application is used by LIM-ATM cards and E5-ATM cards to support ATM high-speed signaling links. It is also used by the E5-ATM card to support T1 functions.

**atmitu**—The application is used by E1 ATM cards and E5-ATM cards to support E1 high-speed signaling links. It is also used by the E5-ATM card to support E1 functions.

**ccs7itu**—This application is used by E1/T1 MIM cards, and HC-MIM cards for ITU MTP functions.

**eroute**—This application is used by STC cards and E5-STC cards for the EAGLE 5 Integrated Monitoring Support functions.

**gls**—This application is used by TSM cards and E5-TSM cards for downloading gateway screening to LIM and Service Module cards.

**ipgwi**—This application is used by SSEDCCM cards and E5-ENET cards for TCP/IP point-to-multipoint connectivity for ITU point codes. The system allows a maximum of 125 cards to be assigned the **ipgwi** application.

**iplim**—This application is used by SSEDCCM cards and E5-ENET cards for TCP/IP point-to-point connectivity for ANSI point codes.

**iplimi**—This application is used by SSEDCCM cards and E5-ENET cards for TCP/IP point-to-point connectivity for ITU point codes.

**ips**—This application is used by IPSM cards and E5-IPSM cards for the IP User Interface feature.

**ipsg**—This application is used by E5-ENET cards (IPSG cards) to support the combined functionality of IPLIMx M2PA and IPGWx M3UA.

**mcp**—This application is used by MCPM cards for the Measurements Platform feature.

**ss7ansi**—This application is used by MPL cards, E1/T1 MIM cards, HC-MIM cards, and E5-E1T1 cards for ANSI MTP functions.

**ss7ipgw**—The application software for TCP/IP point-to-multipoint connectivity. The system allows a maximum of 125 cards to be assigned the **ss7ipgw** application.

**stplan**—This application is used by DCM cards and E5-ENET cards to support STP LAN functions.

**vsccp**—This application is used by Service Module cards to support EPAP-based features, and LNP features. If no EPAP-based features or LNP features are turned on, and a Service Module card is present, the **vsccp** GPL processes normal GTT traffic.

**:links=** (optional)

Filter specification. Report the maximum number of links, only equipped links, or only unequipped links on the card in the specified card location (**loc**).

**Range:** **all, equip, unequip**

**all**— Reports the maximum number of links available on the card in the specified **loc**

**equip**— Reports only links that are equipped

**unequip**— Reports only links that are unequipped

**Default:** **equip**

**:loc=** (optional)

Card address. The card location as stenciled on the shelf of the system.

**Range:** **1101-1117, 1201-1218, 1301-1318, 2101-2118, 2201-2218, 2301-2318, 3101-3118, 3201-3218, 3301-3318, 4101-4118, 4201-4218, 4301-4318, 5101-5118, 5201-5218, 5301-5318, 6101-6118**

**Default:** A status of all cards is displayed.

**:mode=** (optional)

Mode. The type of report to display (full or summary).

**Range:** **full**

**Default:** A summary report is displayed.

**:stat=** (optional)

Primary state filter. This parameter cannot be used with the **loc** or **mode** parameters. This filter allows printing of cards in a specified state (all in-service cards, for example).

**Range:** **all, alminh, anr, dsbld, mt, nr**

**all**— All of the primary states

**alminh**— Alarms inhibited

**anr**— In service abnormal (IS-ANR)

**dsbld**— Out of service maintenance disabled (OOS-MT-DSBLD)

**mt**— Out of service maintenance (OOS-MT)

**nr**— In service normal (IS-NR)

**Default:** **all**

### Example

```
rept-stat-card
rept-stat-card:loc=1201
rept-stat-card:loc=1201:mode=full
rept-stat-card:stat=alminh
rept-stat-card:appl=ss7ansi
rept-stat-card:loc=1205:links=equip:mode=full
```

### Dependencies

No other command can be in progress when this command is entered.

The **mode** parameter can be specified only when the **loc** parameter is specified.

Only one of the **loc** parameter, the **stat** parameter, and the **appl** parameter can be specified in the command.

The shelf and card must be equipped.

The following applications are valid for the **appl** parameter: **ss7ansi**, **gls**, **ccs7itu**, **stplan**, **atmansi**, **iplim**, **iplimi**, **ss7ipgw**, **vsccp**, **atmitu**, **ipgwi**, **ips**, **ipsg**, **eroute**, **mcp**.

## Notes

LIM cards show TVG results for SNM (signaling network management), SCCP, and SLAN traffic. Service Module cards show only SNM traffic statistics for TVG.

This command can be canceled using the **F9** function key or the **canc-cmd** command. See **canc-cmd** for more information.

The **mode=full** parameter gives more information than the summary report.

In the output, the SCCP service card field shows which TSM is providing the specified card with GTT service.

The group ticket voucher (TVG) status for low-speed signaling links, ATM high-speed signaling links, and TSMs is displayed when the **mode=full** and **loc** parameters are specified. The status displayed is for the previous 5 minutes and the previous 24 hours.

A plus (+) symbol in the output indicates that the flash GPL currently being run has not yet been activated on the card. See the **act-flash** or **init-flash** command for a list of flash GPLs.

E1 alarms are displayed in the alarm status field. When the **mode=full** parameter is specified, separate fields display status information from the UAM for each E1 interface on the card. For each E1 interface, the display shows the highest priority E1 failure that exists on that E1 card. When no E1 errors exist, the clearing E1 UAM text is displayed. When an E1 interface is not assigned to the card, no output is generated for that E1 position.

T1 alarms are displayed in the alarm status field. When the **mode=full** parameter is specified, separate fields display status information from the UAM for each T1 interface on the card. For each T1 interface, the display shows the highest priority T1 failure that exists on that T1 card. When no T1 errors exist, the clearing T1 UAM text is displayed. When an T1 interface is not assigned to the card, no output is generated for that T1 position.

If the **links** parameter is set to **all**, then 64 links are displayed.

If the **links=unequip** parameter is specified, but the card has not been installed or loaded, then 64 unequipped links are displayed.

If the **links=unequip** parameter is specified, and the card is or has been installed or loaded, then the number of links displayed is equal to 64 minus the provisioned links.

If the **links=equip** parameter is specified, then only provisioned links are displayed.

The CARD WARNING field in the command output indicates a specific condition that can hinder the normal functioning of a card. For HC-MIM and E5-E1T1 cards, the "Obsolete Framer" warning indicates that a port configured on the card may get stuck in a Loss of Frame (LOF) state. If an HC-MIM card or E5-E1T1 card displaying this warning is reloaded, and one of the ports on the card is reporting LOF, then the OAM reboots the card up to 5 times to attempt to clear the LOF condition when the card changes state from IS-ANR to IS-NR.

### **Fast Copy Cards**

A card that can run the Fast Copy interface is referred to as an *FC-capable card*. Currently, E5-ENET cards running the **ipsg** application are the only supported FC-capable cards. After the **fmode=fcopy** parameter is specified (see the **chg-eisopts** command) for an FC-capable card, the card is referred to as an *FC-enabled card*.

**Output**

The clock status fields are reported when the **mode=full** report is selected. The clock status report includes a CLOCK A, CLOCK B, and CLOCK I status. The High Speed clock status report (displayed for ATM, E1 and T1 cards) includes HS CLOCK A, HS CLOCK B, and HS CLOCK I. The valid values for each clock status are ----, **Idle**, **Active**, and **Fault**. The meanings of these values are:

- (dashes)—Undefined, card must be OOS
- Idle**—Clock is available but is not being used by the card
- Active**—Clock is available and is being used by the card
- Fault**—Clock is unavailable

**Idle** and **Active** are shown when the CLK or HS CLK distribution to the card is good. The **Active** value does not denote that the card is actually using the clock source for link alignment. Use the **rt rv-slk**, **rtrv-e1**, and **rtrv-t1** commands to determine what clock source each card is using for link alignment.

If the **mode=full** parameter is specified for an FC-enabled card, then the Fast Copy status and the FC Link status is shown.

Abbreviated output is indicated by 3 vertical dots as shown:

.  
.  
.

Card TYPE "ENET" is displayed if an E5-ENET card is not installed for an IPSG application. If an E5-ENET card (IPSG card) is installed, card TYPE "E5ENET" appears.

**rept-stat-card**

rlghncxa03w 09-06-04 12:57:21 EST EAGLE5 41.1.0

| CARD | VERSION     | TYPE     | GPL     | PST          | SST     | AST   |
|------|-------------|----------|---------|--------------|---------|-------|
| 1101 | 125-020-000 | TSM      | GLS     | IS-NR        | Active  | ----- |
| 1102 | 128-002-000 | LIMATM   | ATMHC   | IS-NR        | Active  | ----- |
| 1103 | 125-020-000 | DSM      | VSCCP   | IS-NR        | Active  | ----- |
| 1105 | 125-020-000 | DSM      | VSCCP   | IS-NR        | Active  | ----- |
| 1106 | 130-001-000 | TSM      | GLSHC   | IS-NR        | Active  | ----- |
| 1107 | 125-020-000 | STC      | EROUTE  | IS-NR        | Active  | ----- |
| 1109 | 125-020-000 | HMUX     | BPHMUX  | IS-NR        | Active  | ----- |
| 1110 | 125-020-000 | HMUX     | BPHMUX  | IS-NR        | Active  | ----- |
| 1111 | 125-020-000 | IPSM     | IPS     | IS-NR        | Active  | ----- |
| 1112 | 125-020-000 | EDSM     | MCP     | IS-NR        | Active  | ----- |
| 1113 | 070-019-002 | GPSM     | EOAM    | IS-NR        | Standby | ----- |
| 1114 | -----       | TDM      |         | IS-NR        | Active  | ----- |
| 1115 | 070-019-002 | GPSM     | EOAM    | IS-NR        | Active  | ----- |
| 1116 | -----       | TDM      |         | IS-NR        | Active  | ----- |
| 1117 | -----       | MDAL     |         | IS-NR        | Active  | ----- |
| 1201 | 125-020-000 | LIMDS0   | SS7ANSI | IS-NR        | Active  | ----- |
| 1202 | -----       | LIMCH    | SS7ANSI | OOS-MT-DSBLD | Manual  | ----- |
| 1203 | 125-020-000 | LIMCH    | SS7ANSI | IS-NR        | Active  | ----- |
| 1205 | 125-020-000 | EDCM     | IPGWI   | IS-NR        | Active  | ----- |
| 1206 | 125-020-000 | EDCM     | SS7IPGW | IS-NR        | Active  | ----- |
| 1207 | 125-020-000 | EDCM     | IPLIM   | IS-NR        | Active  | ----- |
| 1208 | 125-020-000 | EDCM     | IPLIMI  | IS-NR        | Active  | ----- |
| 1209 | 125-020-000 | HMUX     | BPHMUX  | IS-NR        | Active  | ----- |
| 1210 | 125-020-000 | HMUX     | BPHMUX  | IS-NR        | Active  | ----- |
| 1211 | 125-020-000 | LIMATM   | ATMANSI | IS-NR        | Active  | ----- |
| 1213 | 125-020-000 | LIME1ATM | ATMITU  | IS-NR        | Active  | ----- |
| 1301 | 048-019-022 | LIME1    | SS7ANSI | IS-NR        | Active  | ----- |

```

1303 125-022-000 LIME1 SS7ANSI IS-NR Active -----
1305 125-022-000 LIME1 CCS7ITU IS-NR Active -----
1309 125-017-000 HIPR HIPR IS-NR Active -----
1310 125-017-000 HIPR HIPR IS-NR Active -----
1311 125-020-000 STC EROUTE IS-NR Active -----
1313 125-020-000 DCM STPLAN IS-NR Active -----
2101 104-002-000 LIMV35 CCS7ITU IS-NR Active -----
2103 128-018-000 DCM IPLHC IS-NR Active -----
2107 104-001-000 LIMCH CCS7ITU IS-NR Active -----
2108 128-018-000 DCM SLANHC IS-NR Active -----
2109 128-022-000 HIPR2 HIPR2 IS-NR Active -----
2110 128-022-000 HIPR2 HIPR2 IS-NR Active -----
2111 128-018-000 STC ERTHC IS-NR Active -----
1413 053-000-058 E5ENET IPSPG IS-NR Active -----
Command Completed.

```

;

This example displays the card status for the GPSM-II of MASP A located in slot 1113, which is currently active.

This example also shows a Hardware Verification Code. The HW VERIFICATION CODE field is shown only in the **mode=full** report. "-----" is shown for cards with valid hardware. A numerical value is shown when invalid hardware is detected. All such cards will be auto-inhibited. The numerical values are listed in Table 5-75. The MDAL and HMUX cards do not display the field in **mode=full** reports on their locations.

**rept-stat-card:loc=1113:mode=full**

```

tekelecstp 06-05-29 12:15:95 EST EAGLE 35.0.0
CARD  VERSION      TYPE      GPL      PST      SST      AST
1113  126-004-000  GPSM     EOAM     IS-NR    Active   -----
ALARM STATUS      = No Alarms.
BPDCM GPL version = 126-004-000
IMT BUS A         = Conn
IMT BUS B         = Conn
CLOCK A           = Active
CLOCK B           = Idle
CLOCK I           = Idle
MBD BIP STATUS   = Valid
MOTHER BOARD ID  = GPSM2
DBD STATUS        = Valid
DBD TYPE          = MEM
DBD MEMORY SIZE  = 1024M
HW VERIFICATION CODE = ----
TROUBLE TEXT VER. = Rev 1.6
Command Completed.

```

;

The following example displays all cards that have alarms inhibited in the system.

**rept-stat-card:stat=alminh**

```

rlghncxa03w 04-02-04 12:57:21 EST EAGLE 31.6.0
CARD  VERSION      TYPE      APPL     PST      SST      AST
1211  023-001-000  LIMATM  ATMANSI  IS-NR    Active   ALMINH
Command Completed.

```

;

The following example shows the output for a multi-port LIM (MPL) card. The GPL running on the MPL card is SS7ML; the card TYPE is LIMDS0. When the parameter **mode=full** is specified, the mother board ID is displayed. The MIM type is displayed for multi-port LIM cards.

**rept-stat-card:loc=1203:mode=full**

```

tekelecstp 06-05-21 11:19:03 EST EAGLE 35.0.0
CARD  VERSION      TYPE      GPL      PST      SST      AST
1203  125-053-068  LIMDS0  SS7ML    IS-NR    Active   -----
ALARM STATUS      = * 0022 Clock B for card failed

```



```

BPMLT  GPL version = 125-047-000
IMT BUS A      = Conn
IMT BUS B      = Conn
CLOCK A        = Active
CLOCK B        = Fault
CLOCK I        = Idle
HS CLOCK A     = Fault
HS CLOCK B     = Fault
HS CLOCK I     = Idle
MBD BIP STATUS = VALID
MOTHER BOARD ID = MIM
DBD STATUS     = Valid
DBD TYPE       = None
DBD MEMORY SIZE = 0M
HW VERIFICATION CODE = ----
SIGNALING LINK STATUS
  SLK   PST           LS           CLLI
  A     OOS-MT        ls1203a0   tklcb1203a0
  B     OOS-MT        ls1203a0   tklcb1203a0
  A1    OOS-MT        ls1203a1   tklcb1203a1
  B1    OOS-MT        ls1203a1   tklcb1203a1
  A2    OOS-MT        ls1203a2   tklcb1203a2
  B2    OOS-MT        ls1203a2   tklcb1203a2
  A3    OOS-MT        ls1203a3   tklcb1203a3
  B3    OOS-MT        ls1203a3   tklcb1203a3
TVG STATUS
SNM     TVG RESULT   = 24 hr: -----, 5 min: -----
SLAN    TVG RESULT   = 24 hr: -----, 5 min: -----
SCCP    TVG RESULT   = 24 hr: -----, 5 min: -----
INM     TVG RESULT   = 24 hr: -----, 5 min: -----
Command Completed.

```

;

The following example lists all possible links on an E1/T1 MIM card. Only link A is equipped.

**rept-stat-card:loc=1205:links=all**

```

rlghncxa03w 05-02-04 15:10:19 EST EAGLE5 33.0.0
CARD  VERSION   TYPE   GPL     PST           SST       AST
1205  060-002-004 LIME1  SS7ML   IS-NR        Active    -----
ALARM STATUS      = No Alarms.
BPMLT  GPL version = 002-103-004
IMT BUS A      = Conn
IMT BUS B      = Conn
SIGNALING LINK STATUS
  SLK   PST           LS           CLLI           E5IS
  A     OOS-MT        ls111        -----        INACTIVE
  B     OOS-MA        -----        -----        INACTIVE
  A1    OOS-MA        -----        -----        INACTIVE
  B1    OOS-MA        -----        -----        INACTIVE
  A2    OOS-MA        -----        -----        INACTIVE
  B2    OOS-MA        -----        -----        INACTIVE
  A3    OOS-MA        -----        -----        INACTIVE
  B3    OOS-MA        -----        -----        INACTIVE

```

Command Completed.

;

The following example shows details (**mode=full**) for an HC-MIM card.

**rept-stat-card:loc=1205:mode=full**

```

rlghncxa03w 08-05-01 16:46:07 EST EAGLE 39.0.0
CARD  VERSION   TYPE   GPL     PST           SST       AST
1205  126-004-000 LIME1  SS7HC   IS-NR        Active    -----
ALARM STATUS      = No Alarms.
IMTPCI  GPL version = 126-002-000
BLVXW6  GPL version = 075-000-005
BLDIAG6 GPL version = 125-039-000

```

```

BLBIOS  GPL version = 125-039-000
BLCPLD  GPL version = 125-039-000
PLDPMC1 GPL version = 125-039-000
BLROM1  GPL version = 125-039-000
IMT BUS A      = Conn
IMT BUS B      = Conn
CLOCK A       = Active
CLOCK B       = Idle
CLOCK I       = Idle
HS CLOCK A    = Active
HS CLOCK B    = Idle
HS CLOCK I    = Idle
MBD BIP STATUS = Valid
MOTHER BOARD ID = HC BLADE
DBD STATUS    = Valid
DBD TYPE      = E1T1
DBD MEMORY SIZE = 512M
HW VERIFICATION CODE = ----
CURRENT TEMPERATURE = 42C (108F) [ALARM TEMP: 75C (167F)]
PEAK TEMPERATURE:  = 43C (110F) [06-02-24 08:21]
SIGNALING LINK STATUS
  SLK   PST           LS           CLLI
  B31   OOS-MT-DSBLD   lsa0           -----
TVG STATUS
  SNM   TVG RESULT   = 24 hr: G-----, 5 min: -----
  SLAN  TVG RESULT   = 24 hr: -----, 5 min: -----
  SCCP  TVG RESULT   = 24 hr: -----, 5 min: -----
  INM   TVG RESULT   = 24 hr: G-----, 5 min: -----

```

Command Completed.

;

The following example shows details (**mode=full**) for the specified HMUX card.

**rept-stat-card:loc=1109:mode=full**

```

rlghncxa03w 07-07-04 15:10:19 EST EAGLE 37.0.0
CARD  VERSION  TYPE      GPL      PST           SST      AST
1109  239-009-010 HMUX      BPHMUX   IS-NR         Active   -----

ALARM STATUS      = No Alarms
TRIAL VERSION     = BPHMUX 101-009-000
FPGA VERSION      = BPHMUX 000-022-005

```

Command Completed.

;

The following example shows output for an STC card used by the EAGLE 5 Integrated Monitoring Support feature.

**rept-stat-card:loc=1107**

```

rlghncxa03w 07-02-04 15:10:19 EST EAGLE 37.0.0
CARD  VERSION  TYPE      GPL      PST           SST      AST
1107  128-015-000 STC        EROUTE   IS-NR         Active   -----

ALARM STATUS      = No Alarms.
BPDCM  GPL version = 128-108-000
IMT BUS A      = Conn
IMT BUS B      = Conn
EROUTE % OCCUP   = 0%
NTP broadcast = valid
STC IP PORT A:   OOS-MT           Unavail   -----
ALARM STATUS = ** 0084 IP Connection Unavailable
ERROR STATUS = DHCP Lease. Physical Link.
STC IP PORT B:   OOS-MT           Unavail   -----
ALARM STATUS = ** 0084 IP Connection Unavailable
ERROR STATUS = DHCP Lease. Physical Link.

```

Command Completed.

;

The following example shows details (**mode=full**) for an STC card.

**rept-stat-card:loc=1107:mode=full**

```
rlghncxa03w 07-02-04 15:10:19 EST EAGLE 37.0.0
CARD VERSION TYPE GPL PST SST AST
1107 128-015-000 STC EROUTE IS-NR Active -----
ALARM STATUS = No Alarms.
BPDCM GPL version = 128-108-000
IMT BUS A = Conn
IMT BUS B = Conn
CLOCK A = Active
CLOCK B = Idle
CLOCK I = Idle
MBD BIP STATUS = Valid
MOTHER BOARD ID = Invalid
DBD STATUS = Valid
DBD TYPE = Invalid
DBD MEMORY SIZE = 512M
HW VERIFICATION CODE = ----
EROUTE % OCCUP = 0%
NTP broadcast = VALID
STC IP PORT A: IS-NR Active -----
ALARM STATUS = No Alarms.
STC IP PORT B: OOS-MT Unavail -----
ALARM STATUS = ** 0084 IP Connection Unavailable
ERROR STATUS = DHCP Lease. Physical Link.
```

Command Completed.

;

The following example shows output for an MCPM card used by the Measurements Platform feature.

**rept-stat-card:loc=1105**

```
rlghncxa03w 09-01-04 15:10:19 EST EAGLE 40.0.0
CARD VERSION TYPE GPL PST SST AST
1105 128-001-000 EDSM MCP IS-NR Idle -----
ALARM STATUS = ** 0084 MCP A IP CONNECTION UNAVAILABLE
BPDCM GPL VERSION = 128-001-000
IMT BUS A = Conn
IMT BUS B = Conn
MCP IP CONNECTION OOS-MT Unavail
```

Command Completed.

;

The following example shows details (**mode=full**) for an MCPM card that is running the MCP application for the Measurements Platform feature.

**rept-stat-card:loc=1105:mode=full**

```
rlghncxa03w 09-01-04 15:10:19 EST EAGLE 40.0.0
CARD VERSION TYPE GPL PST SST AST
1105 128-001-000 EDSM MCP IS-NR Active -----
ALARM STATUS = No Alarms
BPDCM GPL VERSION = 128-001-000
IMT BUS A = Conn
IMT BUS B = Conn
CLOCK A = Active
CLOCK B = Fault
CLOCK I = Idle
MBD BIP STATUS = valid
MOTHER BOARD ID = SS EDCM
DBD STATUS = Valid
DBD TYPE = MEM
DBD MEMORY SIZE = 2048M
HW VERIFICATION CODE = ----
MCP IP CONNECTION IS-NR Available
```

Command Completed.

;

The following example shows details (**mode=full**) for a card that is running the IPGWI application.

**rept-stat-card:loc=1301:mode=full**

```

rlghncxa03w 07-07-04 15:10:19 EST EAGLE 37.0.0
CARD VERSION TYPE GPL PST SST AST
1301 128-001-000 DCM IPGWI IS-NR Active -----
ALARM STATUS = No Alarms.
BPDCM GPL = 128-001-000
IMT BUS A = Conn
IMT BUS B = Conn
CLOCK A = Active
CLOCK B = Idle
CLOCK I = idle
MBD BIP STATUS = Valid
MOTHER BOARD ID = SS EDCM
DBD STATUS = Valid
DBD TYPE = Ivalid
DBD MEMORY SIZE = 0M
HW VERIFICATION CODE = ----
SIGNALING LINK STATUS
SLK PST LS CLLI
IPLNK STATUS
IPLNK IPADDR STATUS
ASSOCIATION STATUS
ANAME PST SST ASPID
TVG STATUS
SNM TVG RESULT = 24 hr: -----, 5 min: -----
SLAN TVG RESULT = 24 hr: -----, 5 min: -----
SCCP TVG RESULT = 24 hr: -----, 5 min: -----
INM TVG RESULT = 24 hr: -----, 5 min: -----

```

Command Completed.

;

The following example shows output for an E5-ENET card used as an IPGWx card (running the IPGHC GPL) with assigned associations.

**rept-stat-card:loc=1103:mode=full**

```

rlghncxa03w 08-07-01 16:46:07 EST EAGLE 38.0.0
CARD VERSION TYPE GPL PST SST AST
1103 131-011-000 DCM IPGHC IS-NR Active ---
ALARM STATUS = No Alarms.
IMTPCI GPL version = 131-007-000
BLVXW6 GPL version = 131-009-000
BLDIAG6 GPL version = 131-008-000
BLBEPM GPL version = 128-021-000
BLCPLD GPL version = 128-021-000
IMT BUS A = Conn
IMT BUS B = Conn
CLOCK A = Active
CLOCK B = Idle
CLOCK I = Idle
MBD BIP STATUS = Valid
MOTHER BOARD ID = EPM A
DBD STATUS = Valid
DBD TYPE = 1G ENET
DBD MEMORY SIZE = 512M
HW VERIFICATION CODE = ----
CURRENT TEMPERATURE = 43C (110F)
PEAK TEMPERATURE: = 45C (113F) [08-07-08 11:00]
SIGNALING LINK STATUS
SLK PST LS CLLI
A IS-NR ipgwm3ua1 -----

```

```

IPLNK STATUS
  IPLNK  IPADDR      STATUS  PST
  A      10.254.101.92  UP      IS-NR
  B      -----      ----      OOS-MA
ASSOCIATION STATUS
  ANAME          PST          SST          ASPID
  ipgw1103a     OOS-MT      CONNECTING   undefined
TVG STATUS
  SNM    TVG RESULT = 24 hr: -----, 5 min: -----
  SLAN   TVG RESULT = 24 hr: -----, 5 min: -----
  SCCP   TVG RESULT = 24 hr: -----, 5 min: -----
  INM    TVG RESULT = 24 hr: -----, 5 min: -----
    
```

Command Completed.

;

The following example shows output when the IPLNK or associations for the card have not yet been provisioned.

**rept-stat-card:loc=1305:mode=full**

```

eagle10212 07-05-05 15:11:35 EST EAGLE 37.0.0
CARD  VERSION  TYPE  GPL  PST          SST          AST
1305  128-056-000  EDCM  SS7IPGW  IS-NR      Active       -----
ALARM STATUS      = No Alarms.
BPDCM  GPL version = 128-047-000
IMT BUS A          = Conn
IMT BUS B          = Conn
CLOCK A           = Active
CLOCK B           = Idle
CLOCK I           = Idle
MBD BIP STATUS    = valid
MOTHER BOARD ID   = Invalid
DBD STATUS        = valid
DBD TYPE          = Invalid
DBD MEMORY SIZE   =0M
HW VERIFICATION CODE=----
SIGNALING LINK STATUS
  SLK  PST          LS          CLLI
  A    IS-NR       ls1305     -----
IPLNK STATUS
  IPLNK  IPADDR      STATUS
  A      -----      ----
  B      -----      ----
ASSOCIATION STATUS
  ANAME          PST          SST          ASPID
TVG STATUS
  SNM    TVG RESULT = 24 hr: -----, 5 min: -----
  SLAN   TVG RESULT = 24 hr: -----, 5 min: -----
  SCCP   TVG RESULT = 24 hr: -----, 5 min: -----
  INM    TVG RESULT = 24 hr: -----, 5 min: -----
    
```

Command Completed.

The following example shows output for an IPLIM card.

**rept-stat-card:loc=1301**

```

rlghncxa03w 06-06-01 16:43:42 EST EAGLE 35.0.0
CARD  VERSION  TYPE  GPL  PST          SST          AST
1301  082-000-039  EDCM  IPLIM  IS-NR      Active       -----
ALARM STATUS      = No Alarms.
BPDCM  GPL version = 126-002-000
IMT BUS A          = Conn
IMT BUS B          = Disc
SIGNALING LINK STATUS
  SLK  PST          LS          CLLI          E5IS
  A    IS-NR       ls1m2pa     -----      INACTIVE
    
```

```

B      OOS-MT      ls1m2pa      -----      INACTIVE
A1     OOS-MT      ls1m2pa      -----      INACTIVE
B1     OOS-MT      ls1m2pa      -----      INACTIVE
A2     OOS-MT      ls1m2pa      -----      INACTIVE
B2     OOS-MT      ls1m2pa      -----      INACTIVE
A3     OOS-MT      ls1m2pa      -----      INACTIVE
B3     OOS-MT      ls1m2pa      -----      INACTIVE

```

Command Completed.

;

The following example displays a summary report for an HC-MIM card that is used as a T1 card. This example displays abbreviated output.

**rept-stat-card:loc=1101**

```

tklcl090203 08-05-10 13:59:34 EST EAGLE5 39.0.0
CARD  VERSION      TYPE      GPL      PST      SST      AST
1101  126-026-000  LIMT1    SS7HC    IS-NR    Active   -----
ALARM STATUS      = No Alarms.
IMTPCI  GPL version = 126-023-000
BLVXW6  GPL version = 126-026-000
BLDIAG6 GPL version = 126-017-000
BLBIOS  GPL version = 126-011-000
BLCPLD  GPL version = 126-011-000
PLDPMC1 GPL version = 126-026-000
IMT BUS A      = Conn
IMT BUS B      = Conn
CURRENT TEMPERATURE = 43C (110F)
PEAK TEMPERATURE:  = 43C (110F)      [06-08-10 11:56]
SIGNALING LINK STATUS
SLK     PST          LS          CLLI
B       IS-NR      scl1a047a   scl1a047a
A1      IS-NR      ls1101a1   tklcb1101a1
B1      IS-NR      sc2a048a   sc2a048a
A2      IS-NR      sc2a048a   sc2a048a
B2      IS-NR      stpa046a   stpa046a
A3      IS-NR      sc3a049a   sc3a049a
B3      IS-NR      sc3a049a   sc3a049a
A4      IS-NR      ls1101a08  tkb1101a8
B4      IS-NR      scl1a047a   scl1a047a
.
.
.
A30    OOS-MT      stpa046a   stpa046a
B30    IS-NR      stpa046a   stpa046a
A31    IS-NR      sc3a049a   sc3a049a
B31    IS-NR      sc3a049a   sc3a049a

```

Command Completed.

;

The following example displays a full report for an HC-MIM card that is used as a T1 card. This example displays abbreviated output.

**rept-stat-card:loc=1101:mode=full**

```

tklcl090203 08-05-10 13:59:48 EST EAGLE5 39.0.0
CARD  VERSION      TYPE      GPL      PST      SST      AST
1101  126-026-000  LIMT1    SS7HC    IS-NR    Active   -----
ALARM STATUS      = No Alarms.
IMTPCI  GPL version = 126-023-000
BLVXW6  GPL version = 126-026-000
BLDIAG6 GPL version = 126-017-000
BLBIOS  GPL version = 126-011-000
BLCPLD  GPL version = 126-011-000
PLDPMC1 GPL version = 126-026-000
BLROM1  GPL version = 126-026-000
IMT BUS A      = Conn

```

```

IMT BUS B          = Conn
CLOCK A           = Idle
CLOCK B           = Active
CLOCK I           = Idle
HS CLOCK A        = Active
HS CLOCK B        = Idle
HS CLOCK I        = Idle
MBD BIP STATUS    = Valid
MOTHER BOARD ID   = HC BLADE
DBD STATUS        = Valid
DBD TYPE          = E1T1
DBD MEMORY SIZE   = 512M
HW VERIFICATION CODE = ----
CURRENT TEMPERATURE = 43C (110F)
PEAK TEMPERATURE: = 43C (110F) [06-08-10 11:56]
SIGNALING LINK STATUS
  SLK   PST           LS           CLLI
  B     IS-NR         sc1a047a   sc1a047a
  A1    IS-NR         ls1101a1   tklcb1101a1
  B1    IS-NR         sc2a048a   sc2a048a
  A2    IS-NR         sc2a048a   sc2a048a
  B2    IS-NR         stpa046a   stpa046a
  A3    IS-NR         sc3a049a   sc3a049a
  B3    IS-NR         sc3a049a   sc3a049a
  A4    IS-NR         ls1101a08  tkb1101a8
  B4    IS-NR         sc1a047a   sc1a047a
  .
  .
  .
  A30   OOS-MT        stpa046a   stpa046a
  B30   IS-NR         stpa046a   stpa046a
  A31   IS-NR         sc3a049a   sc3a049a
  B31   IS-NR         sc3a049a   sc3a049a
TVG STATUS
  SNM    TVG RESULT   = 24 hr: G-----, 5 min: -----
  SLAN   TVG RESULT   = 24 hr: -----, 5 min: -----
  SCCP   TVG RESULT   = 24 hr: -----, 5 min: -----
  INM    TVG RESULT   = 24 hr: G-----, 5 min: -----

```

Command Completed.

;

The following example displays a summary report for an E5-E1T1 card that is used as an E1 card.

**rept-stat-card:loc=1106**

```

tklcl090203 08-05-10 14:00:43 EST EAGLE5 39.0.0
CARD  VERSION  TYPE      GPL      PST      SST      AST
1106  126-026-000 LIME1    SS7HC    IS-NR    Active   -----
ALARM STATUS = No Alarms.
IMTPCI  GPL version = 126-023-000
BLVXW6  GPL version = 126-026-000
BLDIAG6 GPL version = 126-017-000
BLBEPM  GPL version = 126-011-000
PLDPMC1 GPL version = 126-026-000
BLCPLD  GPL version = 126-011-000
IMT BUS A          = Conn
IMT BUS B          = Conn
CURRENT TEMPERATURE = 37C ( 99F)
PEAK TEMPERATURE:  = 37C ( 99F) [06-08-09 15:21]
SIGNALING LINK STATUS
  SLK   PST           LS           CLLI
  A     IS-NR         inet          -----

```

Command Completed.

;

The following example displays a full report for an E5-E1T1 card that is used as an E1 card.

**rept-stat-card:loc=1106:mode=full**

```
tklcl090203 08-05-10 14:00:53 EST EAGLE5 39.0.0
CARD   VERSION      TYPE      GPL      PST      SST      AST
1106   126-026-000   LIME1     SS7HC    IS-NR     Active   -----
ALARM STATUS          = No Alarms.
IMTPCI  GPL version = 126-023-000
BLVXW6  GPL version = 126-026-000
BLDIAG6 GPL version = 126-017-000
BLBEPM  GPL version = 126-011-000
PLDPMC1 GPL version = 126-026-000
BLCPLD  GPL version = 126-011-000
IMT BUS A              = Conn
IMT BUS B              = Conn
CLOCK A                = Idle
CLOCK B                = Active
CLOCK I                = Idle
HS CLOCK A             = Active
HS CLOCK B             = Idle
HS CLOCK I             = Idle
MBD BIP STATUS         = Valid
MOTHER BOARD ID       = EPM A
DBD STATUS             = Valid
DBD TYPE               = E1T1
DBD MEMORY SIZE       = 512M
HW VERIFICATION CODE = ----
CURRENT TEMPERATURE   = 37C ( 99F)
PEAK TEMPERATURE:    = 38C (101F)      [06-08-10 14:00]
SIGNALING LINK STATUS
  SLK   PST           LS           CLLI
  A     IS-NR         inet         -----
TVG STATUS
SNM     TVG RESULT   = 24 hr: G-----, 5 min: G-----
SLAN    TVG RESULT   = 24 hr: -----, 5 min: -----
SCCP    TVG RESULT   = 24 hr: -----, 5 min: -----
INM     TVG RESULT   = 24 hr: G-----, 5 min: G-----
```

Command Completed.

;

The following example shows output for an E5-STC card.

**rept-stat-card:loc=1103:mode=full**

```
tekelecstp 07-05-06 15:40:32 EST EAGLE 37.0.0
CARD   VERSION      TYPE      GPL      PST      SST      AST
1103   128-002-000   STC      ERTHC    IS-NR     Active   -----
ALARM STATUS          = No Alarms.
IMTPCI  GPL version = 128-002-000
BLVXW6  GPL version = 128-002-000
BLDIAG6 GPL version = 128-002-000
BLBEPM  GPL version = 128-002-000
BLCPLD  GPL version = 128-002-000
IMT BUS A              = Conn
IMT BUS B              = Conn
CLOCK A                = Active
CLOCK B                = Idle
CLOCK I                = Idle
MBD BIP STATUS         = Valid
MOTHER BOARD ID       = EPM A
DBD STATUS             = Valid
DBD TYPE               = 1G ENET
DBD MEMORY SIZE       = 512M
HW VERIFICATION CODE = ----
CURRENT TEMPERATURE   = 51C (124F)
```



```

PEAK TEMPERATURE:      = 51C (124F)      [02-09-20 10:48]
EROUTE % OCCUP          = 0%
NTP broadcast = VALID
STC IP PORT A:          IS-NR           Active      -----
    ALARM STATUS = No Alarms.
STC IP PORT B:          OOS-MT          Unavail     -----
    ALARM STATUS = ** 0084 IP Connection Unavailable
    ERROR STATUS = DHCP Lease. Physical Link.
    
```

Command Completed.

;

The following example shows output for an E5-SLAN card.

**rept-stat-card:loc=1103:mode=full**

```

tekelecstp 07-04-04 15:02:21 EST EAGLE 37.0.0
CARD  VERSION      TYPE      GPL      PST      SST      AST
1103  128-002-000  DCM      SLANHC   IS-NR    Active   -----
    ALARM STATUS      = No Alarms.
    IMTPCI  GPL version = 128-002-000
    BLVXW6  GPL version = 128-002-000
    BLDIAG6 GPL version = 128-002-000
    BLBEPM  GPL version = 128-002-000
    BLCPLD  GPL version = 128-002-000
    IMT BUS A      = Conn
    IMT BUS B      = Conn
    CLOCK A        = Active
    CLOCK B        = Idle
    CLOCK I        = Idle
    MBD BIP STATUS = Valid
    MOTHER BOARD ID = EPM A
    DBD STATUS     = Valid
    DBD TYPE       = 1G ENET
    DBD MEMORY SIZE = 512M
    HW VERIFICATION CODE = ----
    CURRENT TEMPERATURE = 50C (122F)
    PEAK TEMPERATURE:  = 50C (122F)      [02-09-14 14:49]
    DLK A  PST      = OOS-MT-DSBLD  SST = Manual  AST = -----
    SLAN % EAGLE CAPACITY = 0%
    SLAN % HOST CAPACITY  = 0%
    
```

Command Completed.

;

The following example shows output for an E5-SM4G card.

**rept-stat-card:loc=6111**

```

tklcl1110501 07-04-12 17:26:29 EST EAGLE5 37.0.0
CARD  VERSION      TYPE      GPL      PST      SST      AST
6111  128-015-000  DSM      SCCPHC   IS-NR    Active   -----
    ALARM STATUS      = No Alarms.
    IMTPCI  GPL version = 128-006-000
    BLVXW6  GPL version = 128-015-000
    BLDIAG6 GPL version = 128-014-000
    BLBSMG  GPL version = 128-007-000
    BLCPLD  GPL version = 128-006-000
    IMT BUS A      = Conn
    IMT BUS B      = Conn
    CURRENT TEMPERATURE = 31C ( 88F)
    PEAK TEMPERATURE:  = 32C ( 90F)      [07-04-12 15:55]
    SCCP % OCCUP      = 1%
    
```

Command Completed.

;

The following example shows a full report for an E5-SM4G card.

**rept-stat-card:loc=6111:mode=full**

```
tklc1110501 07-04-12 17:26:40 EST EAGLE5 37.0.0
CARD   VERSION      TYPE      GPL      PST      SST      AST
6111   128-015-000    DSM      SCCPHC   IS-NR    Active   -----
ALARM STATUS          = No Alarms.
IMTPCI  GPL version = 128-006-000
BLVXW6  GPL version = 128-015-000
BLDIAG6 GPL version = 128-014-000
BLBSMG  GPL version = 128-007-000
BLCPLD  GPL version = 128-006-000
IMT BUS A          = Conn
IMT BUS B          = Conn
CLOCK A           = Active
CLOCK B           = Idle
CLOCK I           = Idle
MBD BIP STATUS    = Valid
MOTHER BOARD ID   = SMXG A
DBD STATUS        = Valid
DBD TYPE          = 1G ENET
DBD MEMORY SIZE   = 4096M
HW VERIFICATION CODE = ----
CURRENT TEMPERATURE = 31C ( 88F)
PEAK TEMPERATURE:  = 32C ( 90F)      [07-04-12 15:55]
SCCP % OCCUP      = 1%
TVG STATUS
SNM    TVG RESULT   = 24 hr: -----, 5 min: -----
INM    TVG RESULT   = 24 hr: -----, 5 min: -----
```

Command Completed.

;

The following example shows output for all cards running the vsccp application.

**rept-stat-card:appl=vsccp**

```
tklc1110501 07-04-12 17:28:02 EST EAGLE5 37.0.0
CARD   VERSION      TYPE      GPL      PST      SST      AST
1107   128-015-000    DSM      SCCPHC   IS-NR    Active   -----
1317   -----        DSM      VS CCP   OOS-MT   Isolated -----
2217   128-015-000    DSM      SCCPHC   IS-NR    Active   -----
2317   -----        DSM      VS CCP   OOS-MT   Isolated -----
3103   -----        DSM      VS CCP   OOS-MT-DSBLD Manual   -----
3201   128-015-000    DSM      SCCPHC   IS-NR    Active   -----
3203   128-015-000    DSM      SCCPHC   IS-NR    Active   -----
3205   128-015-000    DSM      SCCPHC   IS-NR    Active   -----
3207   128-015-000    DSM      SCCPHC   IS-NR    Active   -----
3211   128-015-000    DSM      SCCPHC   IS-NR    Active   -----
3213   128-015-000    DSM      SCCPHC   IS-NR    Active   -----
3215   128-015-000    DSM      SCCPHC   IS-NR    Active   -----
3217   128-015-000    DSM      SCCPHC   IS-NR    Active   -----
5317   128-015-000    DSM      SCCPHC   IS-NR    Active   -----
6101   128-015-000    DSM      SCCPHC   IS-NR    Active   -----
6103   128-015-000    DSM      SCCPHC   IS-NR    Active   -----
6105   128-015-000    DSM      SCCPHC   IS-NR    Active   -----
6107   128-015-000    DSM      SCCPHC   IS-NR    Active   -----
6111   128-015-000    DSM      SCCPHC   IS-NR    Active   -----
6113   128-015-000    DSM      SCCPHC   IS-NR    Active   -----
6115   128-015-000    DSM      SCCPHC   IS-NR    Active   -----
6117   128-015-000    DSM      SCCPHC   IS-NR    Active   -----
```

Command Completed.

;

The following example shows a full report for a HIPR2 card.

**rept-stat-card:loc=2109:mode=full**

```
rlghncxa03w 09-06-04 15:10:19 EST EAGLE 5 41.1.0
CARD VERSION TYPE GPL PST SST AST
2109 128-022-000 HIPR2 HIPR2 IS-NR Active -----
ALARM STATUS = No Alarms.
TRIAL VERSION = HIPR2 023-099-008
FPGA VERSION = HIPR2 008-001-003-002
CURRENT TEMPERATURE = 73C (164F)
PEAK TEMPERATURE: = 73C (164F) [02-01-05 10:12]
```

Command Completed.

;

The following example shows a full report for an FC-enabled card.

**rept-stat-card:loc=1105:mode=full**

```
stp9021503 08-12-11 05:14:58 EST EAGLE5 40.1.0
CARD VERSION TYPE GPL PST SST AST
1105 055-016-012 E5ENET IPSG IS-NR Active -----
ALARM STATUS = * 0581 Loss of Heartbeat
IMTPCI GPL version = 131-007-000
BLVXW6 GPL version = 055-016-007
BLDIAG6 GPL version = 055-016-006
BLBEPM GPL version = 055-016-006
BLCPLD GPL version = 055-016-006
IMT BUS A = Conn
IMT BUS B = Conn
CLOCK A = Active
CLOCK B = Idle
CLOCK I = Idle
MBD BIP STATUS = Valid
MOTHER BOARD ID = EPM A
DBD STATUS = Valid
DBD TYPE = 1G ENET
DBD MEMORY SIZE = 512M
HW VERIFICATION CODE = ----
CURRENT TEMPERATURE = 56C (133F)
PEAK TEMPERATURE: = 58C (137F) [03-12-22 18:06]
SIGNALING LINK STATUS
SLK PST LS CLLI E5IS
A OOS-MT-DSBLD 1s333 ----- ACTIVE
A1 OOS-MT-DSBLD 1s555 ----- ACTIVE
IPLNK STATUS
IPLNK IPADDR STATUS PST
A 192.168.63.165 UP IS-NR
B 192.168.163.141 DOWN OOS-MT
FCLNK STATUS
A1 172.21.48.245 UP IS-NR
B1 172.22.48.245 UP IS-NR
FASTCOPY STATUS: ONLINE
ASSOCIATION STATUS
ANAME PST SST
assoc1 OOS-MT-DSBLD OOS
assoc5 OOS-MT-DSBLD OOS
TVG STATUS
SNM TVG RESULT = 24 hr: -----, 5 min: -----
SLAN TVG RESULT = 24 hr: -----, 5 min: -----
SCCP TVG RESULT = 24 hr: -----, 5 min: -----
EROUTE TVG RESULT = 24 hr: G-----, 5 min: G-----
INM TVG RESULT = 24 hr: -----, 5 min: -----
```

Command Completed.

;

The following example shows a full report for a card that is running the IPSG application.

**rept-stat-card:loc=1105:mode=full**

```
e1080403 08-07-10 14:46:53 EST EAGLE 38.0.0
CARD  VERSION      TYPE      GPL      PST      SST      AST
1105  131-011-000    E5ENET   IPSG     IS-NR    Active   -----
ALARM STATUS      = No Alarms.
IMTPCI  GPL version = 131-007-000
BLVXW6  GPL version = 131-009-000
BLDIAG6 GPL version = 131-008-000
BLBEPM  GPL version = 128-021-000
BLCPLD  GPL version = 128-021-000
IMT BUS A          = Conn
IMT BUS B          = Conn
CLOCK A           = Active
CLOCK B           = Idle
CLOCK I           = Idle
MBD BIP STATUS    = Valid
MOTHER BOARD ID   = EPM A
DBD STATUS        = Valid
DBD TYPE          = 1G ENET
DBD MEMORY SIZE   = 512M
HW VERIFICATION CODE = ----
CURRENT TEMPERATURE = 43C (110F)
PEAK TEMPERATURE:  = 45C (113F)      [08-07-08 10:18]
SIGNALING LINK STATUS
  SLK  PST          LS          CLLI
  B2   OOS-MT      ipsg1105b2  -----
IPLNK STATUS
  IPLNK IPADDR      STATUS    PST
  A     10.254.101.121  UP        IS-NR
  B     10.254.100.4   UP        IS-NR
ASSOCIATION STATUS
  ANAME          PST          SST
  m3ua1105b2    OOS-MT      CONNECTING
TVG STATUS
  SNM  TVG RESULT = 24 hr: -----, 5 min: -----
  SLAN TVG RESULT = 24 hr: -----, 5 min: -----
  SCCP TVG RESULT = 24 hr: -----, 5 min: -----
  INM  TVG RESULT = 24 hr: -----, 5 min: -----
```

Command Completed.

;

The following example shows a full report for an IPSM card.

**rept-stat-card:loc=1105:mode=full**

```
tekelecstp 08-07-10 04:18:36 EST EAGLE 39.0.0
CARD  VERSION      TYPE      GPL      PST      SST      AST
1105  131-010-000    IPSM     IPS      IS-NR    Active   -----
ALARM STATUS      = * 0021 Clock A for card failed, Clock B normal
BPDCM  GPL version = 130-029-000
IMT BUS A          = Conn
IMT BUS B          = Conn
CLOCK A           = Fault
CLOCK B           = Active
CLOCK I           = Idle
MBD BIP STATUS    = Valid
MOTHER BOARD ID   = SS EDMS
DBD STATUS        = Valid
DBD TYPE          = MEM
DBD MEMORY SIZE   = 1024M
HW VERIFICATION CODE = ----
IPLNK STATUS
  IPLNK IPADDR      STATUS    PST
  A     10.220.9.9   UP        IS-NR
```

Command Completed.

;

The following example shows a full report for an E5-IPSM card.

**rept-stat-card:loc=1107:mode=full**

```
tekelecstp 08-07-10 04:18:45 EST EAGLE 39.0.0
CARD VERSION TYPE GPL PST SST AST
1107 131-010-000 IPSM IPSHC IS-NR Active -----
ALARM STATUS = * 0021 Clock A for card failed, Clock B normal
IMTPCI GPL version = 131-005-000
BLVXW6 GPL version = 131-010-000
BLDIAG6 GPL version = 131-002-000
BLBEPM GPL version = 128-021-000
BLCPLD GPL version = 128-021-000
IMT BUS A = Conn
IMT BUS B = Conn
CLOCK A = Fault
CLOCK B = Active
CLOCK I = Idle
MBD BIP STATUS = Valid
MOTHER BOARD ID = EPM A
DBD STATUS = Valid
DBD TYPE = 1G ENET
DBD MEMORY SIZE = 2048M
HW VERIFICATION CODE = ----
CURRENT TEMPERATURE = 45C (113F)
PEAK TEMPERATURE: = 45C (113F) [11-12-12 03:57]
IPLNK STATUS
IPLNK IPADDR STATUS PST
A 10.254.101.121 UP IS-NR
```

Command Completed.

;

The following example shows a full report for an E5-E1T1 card when an obsolete framer IC version (v2.1) is used.

**rept-stat-card:loc=1204:mode=full**

```
tekelecstp 08-09-25 12:06:24 IST EST EAGLE 39.2.0
CARD VERSION TYPE GPL PST SST AST
1204 131-016-000 LIME1 SS7HC IS-NR Active -----
ALARM STATUS = No Alarms.
IMTPCI GPL version = 131-007-000
BLVXW6 GPL version = 131-009-000
BLDIAG6 GPL version = 131-008-000
BLBEPM GPL version = 128-021-000
PLDPMC1 GPL version = 128-021-000
BLCPLD GPL version = 128-021-000
IMT BUS A = Conn
IMT BUS B = Conn
CLOCK A = Active
CLOCK B = Fault
CLOCK I = Idle
HS CLOCK A = Fault
HS CLOCK B = Fault
HS CLOCK I = Idle
MBD BIP STATUS = Valid
MOTHER BOARD ID = EPM A
DBD STATUS = Valid
DBD TYPE = E1T1
DBD MEMORY SIZE = 512M
HW VERIFICATION CODE = ----
CARD WARNING = OBSOLETE FRAMER
CURRENT TEMPERATURE = 36C ( 97F)
PEAK TEMPERATURE: = 37C ( 99F) [04-01-05 11:33]
SIGNALING LINK STATUS
```

```

      SLK      PST              LS              CLLI
      A        OOS-MT-DSBLD    lsb        -----
TVG STATUS
      SNM      TVG RESULT    = 24 hr: -----, 5 min: -----
      SLAN     TVG RESULT    = 24 hr: -----, 5 min: -----
      SCCP     TVG RESULT    = 24 hr: -----, 5 min: -----
      INM      TVG RESULT    = 24 hr: -----, 5 min: -----

```

Command Completed.

;

The following example shows the output for E5-TSM card running the **glsbc** GPL.

**rept-stat-card:loc=1106:mode=full**

```

tekelecstp 08-10-05 19:15:28 EST EAGLE 40.0.0
CARD  VERSION      TYPE      GPL      PST      SST      AST
1106  130-001-000   TSM      GLSHC    IS-NR    Active   -----
ALARM STATUS      = No Alarms.
IMTPCI  GPL version = 130-001-000
BLVXW6  GPL version = 130-001-000
BLDIAG6 GPL version = 130-001-000
BLBEPM  GPL version = 130-001-000
BLCPLD  GPL version = 130-001-000
IMT BUS A      = Conn
IMT BUS B      = Conn
CLOCK A       = Active
CLOCK B       = Idle
CLOCK I       = Idle
MBD BIP STATUS = Valid
MOTHER BOARD ID = EPM A
DBD STATUS    = Valid
DBD TYPE      = None
DBD MEMORY SIZE = 512M
HW VERIFICATION CODE = ----
CURRENT TEMPERATURE = 44C (112F)
PEAK TEMPERATURE:   = 44C (112F)      [07-10-05 19:10]

```

Command Completed.

The following example shows the output when E5-MCAP, E5-TDM, and E5-MDAL cards are used.

**rept-stat-card**

```

e5oam 08-12-01 15:38:32 EST EAGLE 40.1.0
CARD  VERSION      TYPE      GPL      PST      SST      AST
1108  -----      MCPM     MCP      OOS-MT-DSBLD Manual   -----
1109  030-009-000   HIPR     HIPR     IS-NR    Active   -----
1110  030-009-000   HIPR     HIPR     IS-NR    Active   -----
1111  030-010-000   IPSM     IPS      IS-NR    Active   -----
1113  030-010-008   E5MCAP   OAMHC    IS-NR    Standby  -----
1114  -----      E5TDM    OAMHC    IS-NR    Active   -----
1115  030-010-008   E5MCAP   OAMHC    IS-NR    Active   -----
1116  -----      E5TDM    OAMHC    IS-NR    Active   -----
1117  -----      E5MDAL   OAMHC    OOS-MT   Isolated -----

```

Command Completed.

;

The following example shows output for a HIPR2 card, which does not support thermal monitoring.

**rept-stat-card:loc=2109**

```

rlghncxa03w 09-06-04 15:10:19 EST EAGLE 5 41.1.0
CARD  VERSION      TYPE      GPL      PST      SST      AST
2109  128-022-000   HIPR2    HIPR2    IS-NR    Active   -----
ALARM STATUS      = No Alarms.
TRIAL VERSION     = HIPR2 023-099-008
FPGA VERSION      = HIPR2 008-001-003-002
CURRENT TEMPERATURE = NA
PEAK TEMPERATURE: = NA

```

Command Completed.

;

The following example shows details for a HIPR2 card when the card is not in-service.

**rept-stat-card:loc=1109**

```
rlghncxa03w 09-06-04 15:10:19 EST EAGLE 5 41.1.0
CARD  VERSION      TYPE      GPL      PST      SST      AST
1209  -----      HIPR2    HIPR2    OOS-MT    Isolated  -----
ALARM STATUS      = No Alarms.
TRIAL VERSION      = HIPR2 023-099-008
FPGA VERSION       = HIPR2 -----
CURRENT TEMPERATURE = ----
PEAK TEMPERATURE: = ----
```

Command Completed.

;

**Legend**

- **CARD**—The location of the card.
- **VERSION**—The version number of the application loaded on the card. Dashes (- - - -) in the version column indicate one of the following conditions about the card:
  - The card is configured but is not physically present in the system.
  - The card does not run a GPL, such as TDM or MDAL cards.
  - The card is IS-ANR or is in the process of being loaded.
- **TYPE**—The card type entered in the database. (The DCM and SSEDCCM cards show card type DCM.)
- **APPL**—The application loaded on this card.
- **PST**—The primary state of the card. The possible values are described in "Possible Values for PST/SST/AST".
- **SST**—The secondary state of the card. The possible values are described in "Possible Values for PST/SST/AST".
- **AST**—The associated state of the card. The possible values are described in "Possible Values for PST/SST/AST".

The group ticket voucher status is displayed in these fields: SCCP TVG RESULT (for SCCP messages), SLAN TVG RESULT (for STPLAN messages), and SNM TVG RESULT (for SNM messages). Group ticket voucher status output is displayed as a series of these letters:

**G**—Service Granted. Indicates normal system behavior.

**D**—Service Denied. Indicates an overload, but the group ticket voucher hardware and software are working correctly.

**N**—No granter in the system. For GTT or STPLAN traffic, there can be no Service Module cards or STPLAN in the system. If there are Service Module cards or STPLAN in the system, then a serious failure is indicated (hardware or software bug or hardware failure).

**H**—Hardware time-out. Indicates the hardware timed out waiting for a group ticket voucher packet to return. Group ticket voucher packets can be lost when a card is plugged in or booted. This is a serious condition if cards have not been connecting or disconnecting from the IMT. If this occurs, the IMT must be scrubbed (see the Scrub IMT procedure in the *Maintenance Manual*) or the card must be replaced..

**S**—Software time-out. No result was ever returned from hardware, indicating a probable hardware failure.

**I**—Invalid result from hardware. If this occurs, the IMT must be scrubbed (see the Scrub IMT procedure in the *Maintenance Manual*) or the card must be replaced.

The HW VERIFICATION CODE field is shown only in the mode=full report. ---- is shown in the HW VERIFICATION CODE field for cards with valid hardware detected. One of the following numerical values is shown when invalid hardware is detected, and all such cards will be auto-inhibited.

\* It is possible that the card will continually boot in these cases, before the alarm is ever displayed.

**Table 5-75.** Auto-Inhibit Hardware Verification Codes

| <b>HW Verification Code</b> | <b>Card or Application Code</b> | <b>Description</b>                                                                                                                                                                                | <b>Associated UAM Code</b> |
|-----------------------------|---------------------------------|---------------------------------------------------------------------------------------------------------------------------------------------------------------------------------------------------|----------------------------|
| 002*                        | VSCCP                           | VSCCP card equipped with non-DSM MPS feature is on                                                                                                                                                | 99                         |
| 003*                        | VSCCP                           | VSCCP card equipped with non-DSM LNP and VGTT feature is on                                                                                                                                       | 99                         |
| 004*                        | VSCCP                           | VSCCP card equipped with non-DSM XGTT 1,000,000 is on                                                                                                                                             | 99                         |
| 005*                        | VSCCP                           | VSCCP card equipped w/non-DSM when EGMS enabled                                                                                                                                                   | 99                         |
| 050                         | VSCCP                           | VSCCP card equipped with no daughterboards                                                                                                                                                        | 99                         |
| 051                         | VSCCP                           | VSCCP card equipped with less than 4GB when LNP ported TNs key equal to or greater than 48 million is on                                                                                          | 422                        |
| 052                         | VSCCP                           | VSCCP card equipped with less than 3GB when LNP ported TNs key equal to or greater than 36 million is on                                                                                          | 422                        |
| 053                         | VSCCP                           | VSCCP card equipped with less than 2GB when LNP NPAXXX 150,000 or LNP LRN 100,000 feature key is on                                                                                               | 422                        |
| 059                         | VSCCP                           | MPS database has been detected to exceed capacity of DSM extended memory (only for GPORT, GFLEX, INP, EIR features). UAMs 281, 283, and 285 are used for LNP and LNP ELAP Configuration features. | 422                        |
| 060                         | VSCCP                           | VSCCP card equipped w/< 4GB when the ANSI-41 INP Query feature key is on.                                                                                                                         | 422                        |



Table 5-75. Auto-Inhibit Hardware Verification Codes

| HW Verification Code | Card or Application Code      | Description                                                                                                                                                                                                                                                                                                                                                                                                                | Associated UAM Code |
|----------------------|-------------------------------|----------------------------------------------------------------------------------------------------------------------------------------------------------------------------------------------------------------------------------------------------------------------------------------------------------------------------------------------------------------------------------------------------------------------------|---------------------|
| 099                  | E5-TSM                        | E5-TSM card equipped has one or more daughterboard.                                                                                                                                                                                                                                                                                                                                                                        | 99                  |
| 100                  | SS7IPGW, IPGWI                | DCM with IP connection on B port only when debug enabled                                                                                                                                                                                                                                                                                                                                                                   | 276                 |
| 101                  | SS7IPGW, IPGWI, IPLIM, IPLIMI | DCM only supports SLK link A and B<br>-or-<br>EDCM only supports SLK link A-A3 and B-B3<br>-or-<br>E5-ENET only supports SLK link A-7 and B-7                                                                                                                                                                                                                                                                              | 276                 |
| 102*                 | SS7IPGW, IPGWI                | Non-DCM detected in slot                                                                                                                                                                                                                                                                                                                                                                                                   | 99                  |
| 103                  | SS7IPGW, IPGWI, IPLIM, IPLIMI | DCM does not support >2 associations (IPLIM <sub>x</sub> )-OR-DCM does not support >4 associations (IPGW <sub>x</sub> )<br>-or-<br>EDCM does not support >8 associations (IPLIM <sub>x</sub> )<br>-or-<br>EDCM does not support >50 associations (IPGW <sub>x</sub> )<br>-or-<br>E5-ENET does not support >16 associations (IPLIM <sub>x</sub> )<br>-or-<br>E5-ENET does not support >50 associations (IPGW <sub>x</sub> ) | 276                 |

Table 5-75. Auto-Inhibit Hardware Verification Codes

| HW Verification Code | Card or Application Code            | Description                                                                                                                                                                                                                                                                                                                                                                                         | Associated UAM Code |
|----------------------|-------------------------------------|-----------------------------------------------------------------------------------------------------------------------------------------------------------------------------------------------------------------------------------------------------------------------------------------------------------------------------------------------------------------------------------------------------|---------------------|
| 104                  | SS7IPGW,<br>IPGWI, IPLIM,<br>IPLIMI | DCM does not support >2 sockets (IPLIM <sub>x</sub> )<br>-or-<br>DCM does not support >50 sockets (IPGW <sub>x</sub> )<br>-or-<br>EDCM does not support >8 sockets (IPLIM <sub>x</sub> )<br>-or-<br>EDCM does not support >50 sockets (IPGW <sub>x</sub> )<br>-or-<br>E5-ENET does not support >0 sockets (IPLIM <sub>x</sub> )<br>-or-<br>E5-ENET does not support >0 sockets (IPGW <sub>x</sub> ) | 276                 |
| 105                  | SS7IPGW,<br>IPGWI, IPLIM,<br>IPLIMI | DCM does not support >2 (sockets + associations) (IPLIM <sub>x</sub> )<br>-or-<br>DCM does not support >50 (sockets + assoc*) (IPGW <sub>x</sub> )<br>-or-<br>EDCM does not support >8 (sockets + associations) (IPLIM <sub>x</sub> )<br>-or-<br>EDCM does not support >50 (sockets + associations) (IPGW <sub>x</sub> )<br>Note: *assoc = 8 X associations                                         | 276                 |

Table 5-75. Auto-Inhibit Hardware Verification Codes

| HW Verification Code | Card or Application Code      | Description                                                                                                                                                                                                                                                                                                                                                                | Associated UAM Code |
|----------------------|-------------------------------|----------------------------------------------------------------------------------------------------------------------------------------------------------------------------------------------------------------------------------------------------------------------------------------------------------------------------------------------------------------------------|---------------------|
| 106                  | SS7IPGW, IPGWI, IPLIM, IPLIMI | DCM does not support >64Kb SCTP buffers (IPLIMx)<br>-or-<br>DCM does not support >64Kb SCTP buffers (IPGWx)<br>-or-<br>EDCM does not support >1600Kb SCTP buffers (IPLIMx)<br>-or-<br>EDCM does not support >800Kb SCTP buffers (IPGWx)<br>-or-<br>E5-ENET does not support >3200Kb SCTP buffers (IPLIMx)<br>-or-<br>E5-ENET does not support >3200Kb SCTP buffers (IPGWx) | 276                 |
| 110                  | SS7IPGW, IPGWI                | (SRKQ = DRKQ > 1000) not supported on DCM.                                                                                                                                                                                                                                                                                                                                 | 276                 |
| 122                  | MIM                           | Card is not a MIM - provisioned as a T1 card or as a T1 channel card associated with a T1 interface.                                                                                                                                                                                                                                                                       | 99                  |
| 123                  | MPL                           | MPL cannot run with port A or B provisioned for speeds not equal to 56K.                                                                                                                                                                                                                                                                                                   | 297                 |
| 124                  | MIM, HC-MIM                   | Card is not a MIM or HC-MIM and is provisioned as a T1 card.                                                                                                                                                                                                                                                                                                               | 99                  |
| 125                  | MIM, MPL                      | MIM or MPL card with a signaling link greater than B3 provisioned.                                                                                                                                                                                                                                                                                                         | 297                 |
| 127                  | MIM                           | MIM card with a signaling link provisioned on E1/T1 port 2-7.                                                                                                                                                                                                                                                                                                              | 297                 |
| 128                  | HC-MIM                        | Fan feature bit must be on for HC-MIM cards.                                                                                                                                                                                                                                                                                                                               | 43                  |
| 129                  | HC-MIM, E5-E1T1               | Card does not support CAS framing.                                                                                                                                                                                                                                                                                                                                         | 297                 |

Table 5-75. Auto-Inhibit Hardware Verification Codes

| HW Verification Code | Card or Application Code                                         | Description                                                                                | Associated UAM Code |
|----------------------|------------------------------------------------------------------|--------------------------------------------------------------------------------------------|---------------------|
| 130                  | LIME1, MIM                                                       | Card is not a LIME1 or MIM and is provisioned as an E1 channel card.                       | 99                  |
| 131                  | HC-MIM, E5-E1T1                                                  | Card has channel bridging mode active but is not running supported high capacity GPL       | 297                 |
| 132                  | MPL                                                              | Card is not a LIME1 or MIM and is provisioned as an E1 card.                               | 99                  |
| 133                  | LIME1, LIMDS0, MIM, MPL                                          | Card cannot support unchannelized mode.                                                    | 99                  |
| 134                  | E5-E1T1                                                          | E5-E1T1 card with SLK provisioned on link greater than 15.                                 | 99                  |
| 135                  | E5-E1T1                                                          | E5-E1T1 card supports only 1 SE-HSL link                                                   | 276                 |
| 136                  | LIM-ATM, LIME1- ATM                                              | Single Port ATM card with SLK provisioned on link B                                        | 297                 |
| 140                  | MCP                                                              | MCP card not running with D2G memory.                                                      | 422                 |
| 141                  | IPS                                                              | IPSM card not running with D2G memory.                                                     | 422                 |
| 150                  | ASM, EILA, LIM-AINF, LIM-DS0, LIM-E1, LIM-ILA, LIM-OCU, LIM-V.35 | Card is obsolete.                                                                          | 47                  |
| 160                  | MCP                                                              | MCP card has incorrect motherboard. The application must run on an EDSM card.              | 441                 |
| 165                  | VSCCP                                                            | Hardware configuration does not support configured feature set.                            | 99                  |
| 170                  | EROUTE                                                           | Non-DCM/Non-E5-ENET card detected in slot provisioned for <b>eroute</b> with card type DCM | 99                  |

Table 5-75. Auto-Inhibit Hardware Verification Codes

| HW Verification Code | Card or Application Code | Description                                                                         | Associated UAM Code |
|----------------------|--------------------------|-------------------------------------------------------------------------------------|---------------------|
| 171                  | STPLAN                   | Non-DCM/Non-E5-ENET card detected in slot provisioned for STPLAN with card type DCM | 99                  |
| 180                  | SCCP, SS7ANSI            | SCCP card equipped with DCM with MOBR on                                            | 441                 |

**rept-stat-cdl****Report Command Driven Loopback Status**

Use this command to generate a report of the signaling links currently in Command Driven Loopback (CDL) testing, including the amount of time the link has been in CDL testing.

Command Driven Loopback is the ability to locally drive a signaling link into a manual line loopback. The data received on the signaling link is echoed (transmitted) back. This is effectively the reverse of the **tst-slk:loopback=lxvr**, which loops the transmitted data back to the receive.

**Keyword:** **rept-stat-cdl**

**Related Commands:** **act-cdl**, **dact-cdl**

**Command Class:** Link Maintenance

**Parameters**

**:link=** (optional)

SS7 signaling links. The signaling links that is being tested.

**Synonym:** **port**

**Range:** **a, b, a1-a31, b1-b31**

Not all card types support all **link** parameter values.

See Table A-1 for valid **link** parameter range values for each type of card that can have assigned signaling link ports.

**Default:** All signaling links that are in CDL testing are displayed.

**:loc=** (optional)

The card location as stenciled on the shelf of the system.

**Range:** **1101-1108, 1111-1112, 1201-1208, 1211-1218, 1301-1308, 1311-1318, 2101-2108, 2111-2118, 2201-2208, 2211-2218, 2301-2308, 2311-2318, 3101-3108, 3111-3118, 3201-3208, 3211-3218, 3301-3308, 3311-3318, 4101-4108, 4111-4118, 4201-4208, 4211-4218, 4301-4308, 4311-4318, 5101-5108, 5111-5118, 5201-5208, 5211-5218, 5301-5308, 5311-5318, 6101-6108, 6111-6118**

**Default:** All cards containing signaling links that are in CDL testing are displayed.

**:loopback=** (optional)

Loopback test type.

**Range:** **line, payload**

The **payload** value is valid only on LIM-ATM and E1-ATM cards.

**Default:** All loopback tests are displayed.

**Example**

```
rept-stat-cdl
```

```
rept-stat-cdl:loc=1201
rept-stat-cdl:loc=1203:link=a
rept-stat-cdl:loopback=payload
```

### Dependencies

If the **link** parameter is specified, the **loc** parameter must be specified.

The card location specified in the **loc** parameter must be equipped.

The signaling link specified in the **link** parameter must be equipped.

This command is not available during upgrade.

The card location specified in the **loc** parameter cannot be reserved by the system.

### Notes

This command can be canceled using the **F9** function key or the **canc-cmd** command. See **canc-cmd** for more information

### Output

```
rept-stat-cdl
tekelecstp 03-11-27 01:29:06 EST EAGLE 31.3.0
SLK        CDL        CDL-TIME
1102,A1    LINE        00:04:01
1201,A     PAYLOAD    01:04:11
1203,A     LINE        00:22:21
1203,B     LINE        20:04:01
1208,A     LINE        01:05:22
1211,A     PAYLOAD    00:14:01
;
```

### Legend

**SLK**—The card and assigned signaling link that is in CDL testing.

**CDL**—Command Driven Loopback test type (LINE or PAYLOAD).

**CDL-TIME**—The time that the signaling link has been in CDL testing. This value can be up to 99:59:59. The test can run longer than 100 hours, but this field will not record times longer than 100 hours.

## rept-stat-cdt

### Report Status Customer Defined Troubles

Use this command to display the customer-defined troubles. The Customer-Definable Alarms feature can be used to connect up to 10 external devices to the system for alarm reporting. These devices are defined in the system database as customer-defined troubles, and they are monitored so that any change in the state of these devices is reported as an unsolicited alarm message (UAM).

**Keyword:** **rept-stat-cdt**

**Related Commands:** **act-alm-trns**, **canc-alm-trns**, **dact-alm-trns**, **rept-stat-clk**, **rept-stat-trbl**, **rls-alm**, **rtrv-obit**, **rtrv-trbl**

**Command Class:** System Maintenance

### Parameters

This command has no parameters.

### Example

```
rept-stat-cdt
```

**Dependencies**

No other status command can be in progress when this command is entered.

**Notes**

These troubles are customer-defined and configured by the factory.

**Output****rept-stat-cdt**

```
rlghncxa03w 04-01-07 20:20:43 EST EAGLE 31.3.0
ID          ALARM STATUS
1   *C 0058  Critical Customer Trouble detected
2   *C 0050  Critical Holdover Clock trouble detected
3   *C 0058  Critical Customer Trouble detected
4   *C 0058  Critical Customer Trouble detected
5   I ** 0059  Major Customer Trouble detected
6   ** 0052  Major Holdover Clock trouble detected
7   ** 0059  Major Customer Trouble detected
8   ** 0059  Major Customer Trouble detected
9   I * 0060  Minor Customer Trouble detected
10  * 0054  Minor Holdover Clock trouble detected
11  * 0060  Minor Customer Trouble detected
12  * 0060  Minor Customer Trouble detected
13  * 0060  Minor Customer Trouble detected
14  I * 0060  Minor Customer Trouble detected
15  * 0060  Minor Customer Trouble detected
16  * 0060  Minor Customer Trouble detected
;
```

**Legend**

**ID**—The customer defined trouble ID number followed by the status of the customer-defined trouble.

**ALARM STATUS**—The status of the alarm for the specified device.

**rept-stat-clk****Report Status Clock**

Use this command to display the clock status summary for cards in the system.

**Keyword:** `rept-stat-clk`

**Related Commands:** `rept-stat-card`, `rept-stat-dstn`, `rept-stat-imt`, `rept-stat-ls`, `rept-stat-sccp`, `rept-stat-slk`, `rept-stat-trbl`

**Command Class:** System Maintenance

**Parameters**

**:mode=** (optional)

Display mode. When **mode=full** is specified, the "Cards with bad clock source" section of the report is displayed

**Range:** `full`

**Example**

```
rept-stat-clk
rept-stat-clk:mode=full
```

**Dependencies**

No other `rept-stat-xxx` command can be in progress when this command is entered.

## Notes

The clock status report includes the status of all the clocks in the system (Clock A, Clock B, Clock I, High Speed (HS) Clock A, HS Clock B, etc).

The Time Slot Counter Synchronization (TSC) clock appears only if the Time Slot Counter Synchronization (TSCSYNC) feature is turned on. See the **chg-feat** command.

The Composite clock sections of the report are the *Primary Comp Clock (CLK)* and the *Secondary Comp CLK* fields in the COMPOSITE SYSTEM CLOCK section: the summary of the number of cards having bad status or using COMP CLKs; and the *CLK* columns in the "Cards with bad clock source" section that appears when the **mode=full** parameter is specified.

The HS clock sections of the report are the *Primary HS Clock (CLK)*, *Secondary HS CLK*, *HS CLK TYPE*, and *HS CLK LINELEN* fields in the HIGH SPEED SYSTEM CLOCK section: the summary of the number of cards having bad status or using HS CLKs; and the *HS CLK* columns in the "Cards with bad clock source" section that appears when the **mode=full** parameter is specified.

HS clock capable cards can support a link that is provisioned to use HS Master Timing. These cards include all cards with type **lime1** or **limt1** and all cards that run the **atmansi** or **atmitu** applications. The clock status values are the same as those listed in the **rept-stat-card:mode=full:loc=xxx** report. For a complete list of the cards and their applications, see Table A-7.

If HS clock A and B status is included in the "Cards with bad clock source" section, then cards that cannot be provisioned to use HS Master Timing display dashes for HS clock A and B status.

The PST/SST for the Primary Composite Clock (Comp Clk) 1114, Primary Comp Clk 1116, Secondary Comp Clk 1114, Secondary Comp Clk 1116, Primary HS Clk 1114, Primary HS Clk 1116, Secondary HS Clk 1114, and Secondary HS Clk 1116 can be one of the following values:

- IS-NR/active—clock source is valid, clock chosen as source
- IS-NR/idle—clock source is valid, clock not chosen as source
- OOS-MT/fault—clock source is invalid

The PST/ SST for the Composite System Clock and High Speed System Clock can be one of the following values:

- IS-NR/Idle—all cards showing good clock, clock not required
- IS-ANR/Idle—some cards showing bad clock, clock not required
- OOS-MT/Idle—all cards showing bad clock, clock not required
- IS-NR/Active—all cards "requiring clocks" showing good clock, clocks required
- IS-ANR/Fault—some cards "requiring clocks" showing bad clock, clocks required
- OOS-MT/Fault—all cards "requiring clocks" showing bad clock, clocks required



**NOTE: An asterisk (\*) indicates that the card requires the indicated clock.**

## Output

**NOTE: A TDM card can use a local clock that is generated independently on each TDM as a clock source for the corresponding internal system clock. The system does not report the “cards bad” status for these internal clocks.**

**NOTE: The use of HS CLK I is not automatic when both the high-speed primary and secondary clocks are invalid. A LIM-ATM card must be provisioned (using the ent-  
slk:atmtsel=internal parameter) to use the high-speed internal clock.**

**NOTE: The *Using* field in the Composite Clock section describes all of the cards that are using the Composite Clock, not just LIM-DS0, MPL, or HS clock capable cards.**

The following example shows output when two GPSM-II cards are configured, and LIM-DS0 cards, MPL cards, and HS clock capable cards are not configured. The TSCSYNC feature is not turned on.

### rept-stat-clk

```
tekelecstp 08-06-07 14:40:13 EST EAGLE 39.0.0
COMPOSITE                               PST           SST           AST
  SYSTEM CLOCK                           IS-NR         Idle          -----
ALARM STATUS = No Alarms.
  Primary Comp Clk 1114 (CLK A)          IS-NR         Active        -----
  Primary Comp Clk 1116 (CLK B)          IS-NR         Active        -----
  Secondary Comp Clk 1114 (CLK A)        IS-NR         Idle          -----
  Secondary Comp Clk 1116 (CLK B)        IS-NR         Idle          -----

Clock      Using      Bad
CLK A      2          0
CLK B      0          0
CLK I      0          --

HIGH SPEED                               PST           SST           AST
  SYSTEM CLOCK                           IS-NR         Idle          -----
ALARM STATUS = No Alarms.
  Primary HS Clk 1114 (HS CLK A)          IS-NR         Active        -----
  Primary HS Clk 1116 (HS CLK B)          IS-NR         Active        -----
  Secondary HS Clk 1114 (HS CLK A)        IS-NR         Idle          -----
  Secondary HS Clk 1116 (HS CLK B)        IS-NR         Idle          -----

HS CLK TYPE 1114      = RS422
HS CLK LINELEN 1114  = -----
HS CLK TYPE 1116      = RS422
HS CLK LINELEN 1116  = -----

Clock      Using      Bad
HS CLK A   0          0
HS CLK B   0          0
HS CLK I   0          --

Command Completed.
```

The following example shows output when two GPSM-II cards are configured, LIM-DS0 and MPL cards are not configured, and an HS clock capable card is configured. The TSCSYNC feature is not turned on.

### rept-stat-clk

```
tekelecstp 08-06-07 14:40:13 EST EAGLE 39.0.0
COMPOSITE                               PST           SST           AST
  SYSTEM CLOCK                           IS-NR         Idle          -----
ALARM STATUS = No Alarms.
```

```

Primary Comp Clk 1114 (CLK A) IS-NR Active -----
Primary Comp Clk 1116 (CLK B) IS-NR Active -----
Secondary Comp Clk 1114 (CLK A) IS-NR Idle -----
Secondary Comp Clk 1116 (CLK B) IS-NR Idle -----

```

```

Clock      Using      Bad
CLK A      3           0
CLK B      0           0
CLK I      0           --

```

```

HIGH SPEED                                PST      SST      AST
SYSTEM CLOCK                             IS-NR    Active  -----
ALARM STATUS = No Alarms.
Primary HS Clk 1114 (HS CLK A) IS-NR    Active  -----
Primary HS Clk 1116 (HS CLK B) IS-NR    Active  -----
Secondary HS Clk 1114 (HS CLK A) IS-NR    Idle    -----
Secondary HS Clk 1116 (HS CLK B) IS-NR    Idle    -----

```

```

HS CLK TYPE 1114 = RS422
HS CLK LINELEN 1114 = -----
HS CLK TYPE 1116 = RS422
HS CLK LINELEN 1116 = -----

```

```

Clock      Using      Bad
HS CLK A   1           0
HS CLK B   0           0
HS CLK I   0           --

```

Command Completed.

;

The following example shows output when two GPSM-II cards are configured, and LIM-DS0 cards, MPL cards, and HS clock capable cards are not configured. The TSCSYNC feature is turned on.

**rept-stat-clk**

```

tekelecstp 08-05-07 14:40:13 EST EAGLE 39.0.0
COMPOSITE                                PST      SST      AST
SYSTEM CLOCK                             IS-NR    Active  -----
ALARM STATUS = No Alarms.
Primary Comp Clk 1114 (CLK A) IS-NR    Active  -----
Primary Comp Clk 1116 (CLK B) IS-NR    Active  -----
Secondary Comp Clk 1114 (CLK A) IS-NR    Idle    -----
Secondary Comp Clk 1116 (CLK B) IS-NR    Idle    -----

```

```

Clock      Using      Bad
CLK A      2           0
CLK B      0           0
CLK I      0           --

```

Prefer Clock A for TSC CLOCK

```

HIGH SPEED                                PST      SST      AST
SYSTEM CLOCK                             IS-NR    Active  -----
ALARM STATUS = No Alarms.
Primary HS Clk 1114 (HS CLK A) IS-NR    Active  -----
Primary HS Clk 1116 (HS CLK B) IS-NR    Active  -----
Secondary HS Clk 1114 (HS CLK A) IS-NR    Idle    -----
Secondary HS Clk 1116 (HS CLK B) IS-NR    Idle    -----

```

```

HS CLK TYPE 1114 = RS422
HS CLK LINELEN 1114 = -----
HS CLK TYPE 1116 = RS422
HS CLK LINELEN 1116 = -----

```

```

Clock      Using      Bad
HS CLK A   0           0

```

```

HS CLK B      0          0
HS CLK I      0          --

```

Command Completed.

;

The following example shows output when two GPSM-II cards are configured, LIM-DS0 and MPL cards are not configured, and an HS clock capable card is configured. The TSCSYNC feature is turned on.

### rept-stat-clk

```

tekelecstp 08-06-07 14:40:13 EST  EAGLE 39.0.0
COMPOSITE                                PST          SST          AST
  SYSTEM CLOCK                            IS-NR        Active       -----
ALARM STATUS = No Alarms.
  Primary Comp Clk 1114 (CLK A)           IS-NR        Active       -----
  Primary Comp Clk 1116 (CLK B)           IS-NR        Active       -----
  Secondary Comp Clk 1114 (CLK A)         IS-NR        Idle         -----
  Secondary Comp Clk 1116 (CLK B)         IS-NR        Idle         -----

```

```

Clock      Using      Bad
CLK A      3          0
CLK B      0          0
CLK I      0          --

```

Prefer Clock A for TSC CLOCK

```

HIGH SPEED                                PST          SST          AST
  SYSTEM CLOCK                            IS-NR        Active       -----
ALARM STATUS = No Alarms.
  Primary HS Clk 1114 (HS CLK A)           IS-NR        Active       -----
  Primary HS Clk 1116 (HS CLK B)           IS-NR        Active       -----
  Secondary HS Clk 1114 (HS CLK A)         IS-NR        Idle         -----
  Secondary HS Clk 1116 (HS CLK B)         IS-NR        Idle         -----

```

```

HS CLK TYPE 1114 = RS422
HS CLK LINELEN 1114 = -----
HS CLK TYPE 1116 = RS422
HS CLK LINELEN 1116 = -----

```

```

Clock      Using      Bad
HS CLK A   1          0
HS CLK B   0          0
HS CLK I   0          --

```

Command Completed.

;

The following example shows output when the **mode=full** parameter is specified, LIM-DS0 or MPL cards are configured, and HS clock capable cards are configured. The TSCSYNC feature is turned on.

### rept-stat-clk:mode=full

```

tekelecstp 08-06-07 14:40:13 EST  EAGLE 39.0.0
COMPOSITE                                PST          SST          AST
  SYSTEM CLOCK                            IS-ANR       Fault        -----
ALARM STATUS = No Alarms.
  Primary Comp Clk 1114 (CLK A)           IS-NR        Active       -----
  Primary Comp Clk 1116 (CLK B)           -----     -----     -----
  Secondary Comp Clk 1114 (CLK A)         IS-NR        Idle         -----
  Secondary Comp Clk 1116 (CLK B)         -----     -----     -----

```

```

Clock      Using      Bad
CLK A      4          1
CLK B      0          5
CLK I      0          --

```

```

Prefer Clock A   for TSC CLOCK

HIGH SPEED                      PST          SST          AST
  SYSTEM CLOCK                  OOS-MT      Fault        -----
ALARM STATUS = No Alarms.
  Primary HS Clk 1114   (HS CLK A) IS-NR      Active       -----
  Primary HS Clk 1116   (HS CLK B) -----       -----
  Secondary HS Clk 1114 (HS CLK A) IS-NR      Idle         -----
  Secondary HS Clk 1116 (HS CLK B) -----       -----

HS CLK TYPE 1114   = E1 UNFRAMED
HS CLK LINELEN 1114 = SHORThAUL
HS CLK TYPE 1116   = -----
HS CLK LINELEN 1116 = -----

Clock      Using      Bad
HS CLK A   0          1
HS CLK B   0          1
HS CLK I   0          --

Cards with bad clock source:
CARD      CLK A      CLK B      HS CLK A   HS CLK B
1103      *Active    *Fault    -----   -----
1104      Active     Fault     *Fault     *Fault
1106      *Active    *Fault    -----   -----
1113      Active     Fault     -----   -----
1205      Fault      Fault     -----   -----

Command Completed.

```

The following example shows output when at least one LIM-DS0 or MPL card is configured, and HS clock capable cards are not configured. The TSCSYNC feature is not turned on.

**rept-stat-clk**

```

tekelecstp 08-06-07 14:40:13 EST EAGLE 39.0.0
COMPOSITE                      PST          SST          AST
  SYSTEM CLOCK                  IS-NR      Active       -----
ALARM STATUS = No Alarms.
  Primary Comp Clk 1114 (CLK A)  IS-NR      Active       -----
  Primary Comp Clk 1116 (CLK B)  IS-NR      Active       -----
  Secondary Comp Clk 1114 (CLK A) IS-NR      Idle         -----
  Secondary Comp Clk 1116 (CLK B) IS-NR      Idle         -----

Clock      Using      Bad
CLK A      3          0
CLK B      0          0
CLK I      0          --

HIGH SPEED                      PST          SST          AST
  SYSTEM CLOCK                  IS-NR      Idle         -----
ALARM STATUS = No Alarms.
  Primary HS Clk 1114   (HS CLK A) IS-NR      Active       -----
  Primary HS Clk 1116   (HS CLK B) IS-NR      Active       -----
  Secondary HS Clk 1114 (HS CLK A) IS-NR      Idle         -----
  Secondary HS Clk 1116 (HS CLK B) IS-NR      Idle         -----

HS CLK TYPE 1114   = RS422
HS CLK LINELEN 1114 = -----
HS CLK TYPE 1116   = RS422
HS CLK LINELEN 1116 = -----

Clock      Using      Bad
HS CLK A   0          0
HS CLK B   0          0

```

```

HS CLK I      0      --
Command Completed.
;

```

**Legend**

**COMPOSITE SYSTEM CLOCK** —Composite System clock status

**ALARM STATUS** —System clock alarms; "No alarms" is shown when there are no alarms.

**PRIMARY COMP CLK** —The status of the primary Composite clock input for a particular TDM

**SECONDARY COMP CLK** —The status of the secondary Composite clock input for a particular TDM

**CLK A** – Internal Eagle Clock sourced by the 1114 TDM from the selected clock source.

**CLK B** – Internal Eagle Clock sourced by the 1116 TDM from the selected clock source.

**CLK I** – Local clock generated independently on each LIM card.

**PREFER CLOCK X FOR TSC CLOCK** —The preferred clock source of the Time Slot Counter Synchronization (TSC) clock; appears only when the TSCSYNC feature is turned on.

**HIGH SPEED SYSTEM CLOCK** —HS system clock status

**ALARM STATUS** —HS System clock alarms; "No alarms" is shown when there are no alarms.

**PRIMARY HS CLK** —The status of the high-speed primary clock input for a particular TDM

**SECONDARY HS CLK** —The status of the high-speed secondary clock input for a particular TDM

**HS CLK TYPE** —HS clock source (see the chg-stpopts command) for a particular TDM

**HS CLK LINELEN** —HS clock line length (see the chg-stpopts command) for a particular TDM

**HS CLK A** – Internal Eagle High Speed Clock sourced by the 1114 TDM from the selected clock source.

**HS CLK B** – Internal Eagle High Speed Clock sourced by the 1116 TDM from the selected clock source.

**HS CLK I** – Local clock generated independently on each LIM card. The value for the internal high-speed clock (Cards using HSCLK I) is generated differently from the internal system clock (Cards using CLK I). The internal high speed clock is generated by the XILINX on the ATM applique's card. The internal system clock is generated by the Xilinx on the LIM main board when the LIM card does not have a valid system clock source (eg. both A system clock and B system clock are bad at the LIM card).

**rept-stat-cluster****Report Status Cluster-Related DPC**

Use this command to report summary status and statistical information for all provisioned clusters. Use this command also to report detailed routeset information for a specific cluster, provisioned cluster member, or dynamically-created x-list entry.

**NOTE: This command does not support 24-bit ITU national point codes.**

**Keyword:** rept-stat-cluster

**Related Commands:** chg-feat, chg-stpopts, rept-stat-cluster, rtrv-stpopts

**Command Class:** System Maintenance

## Parameters

**:dpc=** (optional)

ANSI destination point code of the cluster whose status is to be reported, with subfields *network indicator-network cluster-network cluster member (ni-nc-ncm)*. The *prefix* subfield indicates a private point code (prefix-ni-nc-ncm).

**Synonym:** **dpca**

**Range:** **p-, 000-255, \***

Specify a valid value for each subfield of the point code, and separate the subfields with a dash (-).

*prefix*—**p-**

The asterisk value (\*) is not valid for the *ni* subfield.

When **chg-sid:pctype=ansi** is specified, *ni* = **000** is not valid.

When **chg-sid:pctype=ansi** is specified, *nc* = **000** is not valid if *ni* = **001–005**.

When **chg-sid:pctype=ansi** is specified, *nc* = **000** is valid if *ni* = **006–255**.

The point code **000-000-000** is not a valid point code.

**Default:** Display summary for all provisioned clusters

**:mode=** (optional)

The type of display. Specify **mode=full** to display additional information for the specified DPC.

**Range:** **full**

**Default:** Display summary report

**:stat=** (optional)

This parameter reports on destinations whose status is the same as the state indicated by the parameter.

**Range:** **all, alminh, anr, dsbld, mt, nr**

**all**— All of the primary states

**alminh**— Alarms inhibited

**anr**— In service abnormal (IS-ANR)

**dsbld**— Out of service maintenance disabled (OOS-MT-DSBLD)

**mt**— Out of service maintenance (OOS-MT)

**nr**— In service normal (IS-NR)

**Default:** **all**

## Example

```
rept-stat-cluster
rept-stat-cluster:stat=alminh
rept-stat-cluster:stat=MT
rept-stat-cluster:dpc=20-2-*
rept-stat-cluster:dpc=20-2-*:mode=full
rept-stat-cluster:dpc=20-2-5
```

## Dependencies

If the **mode=full** parameter is specified, the **dpc/dpca** parameter must be specified.

The **stat** parameter cannot be specified with the **dpc/dpca** parameter in the command.

The Cluster Routing and Management Diversity (CRMD) feature must be turned on before this command can be entered.

The specified DPC must exist.

If a DPC is specified, it must be an x-list entry, a cluster DPC, or a member of a provisioned cluster.

The destination address must be a full point code or a cluster point code specified as *ni-nc-\**. A DPC as *ni-nc-\*\** or *ni-nc-\*\*\** cannot be specified for the **rept-stat-cluster** command.

No other **rept-stat-xxx** command can be in progress when this command is entered.

### Notes

If no parameters are specified, a summary report is produced, showing all provisioned clusters and their status.

If an FPC corresponding to a provisioned cluster member or an x-list entry is specified, then the status of only the specified FPC, along with routeset status, is displayed.

If a cluster destination is specified on the **dpc/dpca** parameter, then the status of the cluster and the routesets that have been defined for that cluster is displayed.

If the **mode=full** parameter and a DPC are specified, the Route/Destination table is searched, and all entries (cluster DPCs, provisioned cluster member DPCs, and x-list DPCs) belonging to the parent cluster are displayed along with their status. Also, if circular routing is in effect for the DPC, information useful in diagnosing and correcting the situation is displayed.

In the summary report, and in the detailed output when a cluster DPC is being reported, the number of provisioned members of the cluster, and the number of x-list entries that have been created for the cluster, are reported in the PROV and X-LIST columns, respectively.

When detailed information for an x-list entry is being reported, the reasons that the x-list entry was created, and the amount of time remaining on the x-list expiration timer, if applicable, in the format hh:mm is shown in the X-REASON and X-TIME columns, respectively. In x-list entries for which the expiration timer is not applicable, dashes "-----" are displayed.



**Output**

When no parameters are specified, summary information for all of the defined cluster DPCs is shown. Note that the report shows the number of provisioned and x-list members of each cluster.

**rept-stat-cluster**

```
rlghncxa03w 04-01-07 08:51:31 EST EAGLE 34.0.0
  DPCA          ORIG   PST    SST      AST      PROV  XLIST
  020-002-*    CLUST IS-NR  Allowed ACCESS    2     3
  020-020-*    CLUST IS-NR  Allowed ACCESS    3     5
  020-021-*    CLUST OOS-MT Prohibit INACCESS  5     2
  020-022-*    CLUST IS-NR  Allowed ALMINH    2     3
```

Command Completed.

;

When a provisioned cluster member DPC is specified, the report shows status information for the specified DPC plus route information.

**rept-stat-cluster:dpc=20-2-1**

```
rlghncxa03w 04-01-07 08:51:31 EST EAGLE 34.0.0
  DPCA          ORIG   PST    SST      AST
  020-002-001  PROV  IS-ANR Restrict ACCESS
ALARM STATUS          = No Alarms.
RTE COST  LSN      APCA          LS STAT  NON-ADJ  ROUTE STAT
  1   10   lsnppp  003-003-003  Allowed  Allowed  Allowed
  2   --   -----  ***-***-***  -----  -----  -----
  3   --   -----  ***-***-***  -----  -----  -----
  4   --   -----  ***-***-***  -----  -----  -----
  5   --   -----  ***-***-***  -----  -----  -----
  6   --   -----  ***-***-***  -----  -----  -----
```

Command Completed.

;

When a specific cluster DPC is specified, the report shows count information about the cluster's provisioned and x-list members, plus the route information.

**rept-stat-cluster:dpc=20-2-\***

```
rlghncxa03w 04-01-07 08:51:31 EST EAGLE 34.0.0
  DPCA          ORIG   PST    SST      AST      PROV  X-LIST
  020-002-*    CLUST IS-NR  Allowed ACCESS    2     3
ALARM STATUS          = No Alarms.
RTE COST  LSN      APCA          LS STAT  NON-ADJ  ROUTE STAT
  1   10   lsnppp  003-003-003  Allowed  Allowed  Allowed
  2   --   -----  ***-***-***  -----  -----  -----
  3   --   -----  ***-***-***  -----  -----  -----
  4   --   -----  ***-***-***  -----  -----  -----
  5   --   -----  ***-***-***  -----  -----  -----
  6   --   -----  ***-***-***  -----  -----  -----
```

Command Completed.

;

When an x-list cluster member DPC is specified, the report shows x-list related information (X-REASON, X-TIME) plus the route information. The output report identifies the specified DPC as an x-list DPC.

**rept-stat-cluster:dpc=20-2-5**

```
rlghncxa03w 04-01-07 08:51:31 EST EAGLE 34.0.0
  DPCA          ORIG   PST    SST      AST      X-REASON X-TIME
  020-002-005  X-LIST IS-ANR Restrict ACCESS  RT      08:20
ALARM STATUS          = No Alarms.
```

| RTE | COST | LSN    | APCA        | LS STAT | NON-ADJ | ROUTE STAT |
|-----|------|--------|-------------|---------|---------|------------|
| 1   | 10   | lsnppp | 003-003-003 | Allowed | Allowed | Allowed    |
| 2   | --   | -----  | ***-***-*** | -----   | -----   | -----      |
| 3   | --   | -----  | ***-***-*** | -----   | -----   | -----      |
| 4   | --   | -----  | ***-***-*** | -----   | -----   | -----      |
| 5   | --   | -----  | ***-***-*** | -----   | -----   | -----      |
| 6   | --   | -----  | ***-***-*** | -----   | -----   | -----      |

Command Completed.

;

Specifying a cluster **dpc** and **mode=full** expands the report to show summary status information for all of the provisioned and x-list DPCs that are members of the specified cluster.

**rept-stat-cluster:dpc=20-2-\*:mode=full**

```
rlghncxa03w 04-01-07 08:51:31 EST EAGLE 34.0.0
  DPCA          ORIG      PST      SST      AST      PROV  X-LIST
  020-002-*     CLUST   IS-NR   Allowed  ACCESS   2     3
ALARM STATUS    = No Alarms.
RTE COST  LSN      APCA          LS STAT  NON-ADJ  ROUTE STAT
  1  10  lsnppp    003-003-003  Allowed  Allowed  Allowed
  2  --  -----  ***-***-***  -----  -----  -----
  3  --  -----  ***-***-***  -----  -----  -----
  4  --  -----  ***-***-***  -----  -----  -----
  5  --  -----  ***-***-***  -----  -----  -----
  6  --  -----  ***-***-***  -----  -----  -----
  DPCA          ORIG      PST      SST      AST      X-REASON X-TIME
  020-002-*     CLUST   IS-NR   Allowed  ACCESS   -----  -----
  020-002-001   PROV    OOS-MT  Prohibit INACCESS -----  -----
  020-002-002   PROV    IS-ANR  Restrict ACCESS   -----  -----
  020-002-126   X-LIST  IS-ANR  Restrict ACCESS   RT      08:20
  020-002-127   X-LIST  OOS-MT  Prohibit INACCESS CR      -----
  020-002-128   X-LIST  IS-ANR  Restrict ACCESS   CG RT   05:40
CIRCULAR ROUTING
XMIT LSN= ----- RC=---
RCV LSN= -----
MEMBER = ***-***-***
```

Command Completed.

;

When the **stat** parameter is specified, only those clusters having a primary state (PST) matching the specified value are reported.

**rept-stat-cluster:stat=alminh**

```
rlghncxa03w 04-01-07 08:51:31 EST EAGLE 34.0.0
  DPCA          ORIG      PST      SST      AST      PROV  XLIST
  020-022-*     CLUST   IS-NR   Allowed  ALMINH   2     3
```

Command Completed.

;

If a circular routing alarm is raised for a cluster member DPC, specifying the **dpc** and **mode=full** parameters displays information pertinent to the cluster member that is experiencing the circular routing condition. This information may be useful in correcting the problem.

**rept-stat-cluster:dpc=20-2-127:mode=full**

```
rlghncxa03w 04-01-07 08:51:31 EST EAGLE 34.0.0
  DPCA          ORIG      PST      SST      AST
  020-002-127   PROV    OOS-MT  Prohibit INACCESS
ALARM STATUS    = *C 0319 Circular routing detected
RTE COST  LSN      APCA          LS STAT  NON-ADJ  ROUTE STAT
  1  10  lsnppp    003-003-003  Allowed  Allowed  Allowed
  2  --  -----  ***-***-***  -----  -----  -----
```

```

3  --  -----  ***-***-***  -----  -----  -----
4  --  -----  ***-***-***  -----  -----  -----
5  --  -----  ***-***-***  -----  -----  -----
6  --  -----  ***-***-***  -----  -----  -----
DPCA          ORIG      PST      SST      AST      X-REASON X-TIME
020-002-*     CLUST    IS-NR   Allowed  ACCESS   -----  -----
020-002-001   PROV     OOS-MT  Prohibit ACCESS   -----  -----
020-002-002   PROV     IS-ANR  Restrict ACCESS   -----  -----
020-002-126   X-LIST   IS-ANR  Restrict ACCESS   RT      08:20
020-002-127   X-LIST   OOS-MT  Prohibit INACCESS CG CR    -----
020-002-128   X-LIST   IS-ANR  Restrict ACCESS   CR CG RT 05:40
CIRCULAR ROUTING
XMIT LSN= lsnppp RC=--
RCV LSN= lsn01a
MEMBER = ***-***-***

```

Command Completed.

;

If a circular routing alarm is raised for a cluster DPC (that is, no x-list entry could be created for the cluster member), then specifying the **dpc** and **mode=full** parameters displays information pertinent to the cluster member that is experiencing the circular routing condition. This information may be useful in correcting the problem. The value for the MEMBER field in this example represents the cluster member that had the circular routing condition. This is the same member for which an x-list entry could not be created.

**NOTE: The circular routing member information shown in this output report displays as \*\*\*-\*\*\*-\*\*\* if the specified destination point code is not a cluster destination point code or the information is not known by maintenance at the time the report is generated.**

**rept-stat-cluster:dpc=20-2-\*:mode=full**

```

rlghncxa03w 04-01-07 08:51:31 EST EAGLE 34.0.0
DPCA          ORIG      PST      SST      AST      PROV X-LIST
020-002-*     CLUST    IS-NR   Allowed  ACCESS   2     3
ALARM STATUS  = *C 0319 Circular routing detected
RTE COST LSN      APCA          LS STAT  NON-ADJ  ROUTE STAT
1  10  lsnppp  003-003-003  Allowed  Allowed  Allowed
2  --  -----  ***-***-***  -----  -----  -----
3  --  -----  ***-***-***  -----  -----  -----
4  --  -----  ***-***-***  -----  -----  -----
5  --  -----  ***-***-***  -----  -----  -----
6  --  -----  ***-***-***  -----  -----  -----
DPCA          ORIG      PST      SST      AST      X-REASON X-TIME
020-002-*     CLUST    IS-NR   Allowed  ACCESS   -----  -----
020-002-001   PROV     OOS-MT  Prohibit INACCESS -----  -----
020-002-002   PROV     IS-ANR  Restrict ACCESS   -----  -----
020-002-126   X-LIST   IS-ANR  Restrict ACCESS   RT      08:20
020-002-127   X-LIST   OOS-MT  Prohibit INACCESS CR    -----
020-002-128   X-LIST   IS-ANR  Restrict ACCESS   CG RT   05:40
CIRCULAR ROUTING
XMIT LSN= lsnppp RC=--
RCV LSN= lsn01a
MEMBER = 020-002-129

```

Command Completed.

;

The following example includes private point codes:

**rept-stat-cluster:dpc=20-2-\*:mode=full**

```

rlghncxa03w 05-01-06 10:09:59 EST EAGLE 34.0.0
DPCA          ORIG      PST      SST      AST      PROV XLIST
020-002-*     CLUST    OOS-MT  Idle     INACCESS  0     0
ALARM STATUS  = No Alarms.

```

```

RTE COST  LSN          APCA          LS STAT  NON-ADJ  ROUTE STAT
1    10    ls11345678  p-001-001-003  Allowed  Allowed  Allowed
2    --    -----  ----*-*-*-*-*  -----  -----  -----
3    --    -----  ----*-*-*-*-*  -----  -----  -----
4    --    -----  ----*-*-*-*-*  -----  -----  -----
5    --    -----  ----*-*-*-*-*  -----  -----  -----
6    --    -----  ----*-*-*-*-*  -----  -----  -----
DPCA          ORIG    PST    SST    AST    X-REASON  X-TIME
020-002-*    CLUST  IS-NR  Allowed  ACCESS  -----  -----
p-020-002-001  PROV  OOS-MT  Prohibit  INACCESS  -----  -----
p-020-002-002  PROV  IS-ANR  Restrict  ACCESS  -----  -----
020-002-126  X-LIST  IS-ANR  Restrict  ACCESS  RT      08:20
020-002-127  X-LIST  OOS-MT  Prohibit  INACCESS  CR      -----
020-002-128  X-LIST  IS-ANR  Restrict  ACCESS  CG RT   05:40
CIRCULAR ROUTING INFO:
XMIT LSN=-----  RC=--
RCV LSN=-----
MEMBER =-----

```

Command Completed.

i

### Legend

**ORIG**—Indicates the origination of the destination point code being reported. The possible values that can appear in the column are:

**CLUST**—Entry is a provisioned cluster (*ni-nc-\**) DPC

**PROV**—Entry is a provisioned cluster member (*ni-nc-ncm*)

**X-LIST**—Entry is a non-provisioned (i.e. dynamically-created) x-list cluster member

**PST**—The primary state of the cluster. The possible values are described in "Possible Values for PST/SST/AST".

**SST**—The secondary state of the cluster. The possible values are described in "Possible Values for PST/SST/AST".

**AST**—The associated state of the cluster. The possible values are described in .

**X-REASON**—Indicates the reasons that the X-LIST entries currently exist. The two-letter indicator values that can appear in this column are:

**RT**—X-LIST entry created due to routing

**CG**—X-LIST entry created due to congestion

**CR**—X-LIST entry created due to circular routing

The circular routing transmit/receive linkset information shown in the **mode=full** detailed output report displays as "-----" if no circular routing alarm exists for the DPC or the information is not known by maintenance at the time the report is generated.

## rept-stat-db

### Report Status Database

Use this command to display a report showing various status indicators for the active and standby OAM database and the status of the database on each of the network cards.

If the AINPQ, G-Flex, G-Port, INP, LNP ELAP Configuration, Prepaid SMS Intercept Ph1 (PPSMS), or V-Flex feature is turned on, or the ATINP feature is enabled, then the status of the MPS databases and Service Module cards is displayed.

**Keyword:** rept-stat-db

**Related Commands:** chg-db, copy-meas, disp-disk-dir

**Command Class:** Database Administration

## Parameters

**:db=** (optional)

The report section or sections to display in the output. The content of each section depends on the specified or default value of the **display** parameter, MPS output appears only if a feature that uses the MPS is turned on in the system (G-Flex, G-Port, INP, PPSMS, or the LNP ELAP Configuration controlled feature) or the ATINP feature is enabled.

**Range:** **all, mps, stp**

**all** — Displays database and card output for both the STP and MPS report sections.

**mps** — Displays only the database and card output for the MPS report section.

**stp** — Displays only the database and card output for the STP report section.

**Default:** **all**

**:display=** (optional)

The type of output

**Range:** **all, brief, except, version**

**all** — Displays the operational status of all databases (MASP A, MASP B, and MDAL) and all cards equipped in the database on the system.

**brief** — Displays the operational status of the databases in the active and standby MASP, and of the MPS databases if a feature that uses the MPS is turned on.

**except** — Displays the operational status information contained in the **display=brief** output along with the cards whose database level does not match the active fixed disk current partition or active MPS database.

**version** — Displays all of the same information that is displayed with the **display=all** parameter except that the individual database status column is replaced with the database format version and status. In addition, details of the status of the backup databases are displayed for MASP cards. No version information is shown for MPS databases; use the **rept-stat-mps** command.

**Default:** **brief**

**:loc=** (optional)

The card location as stenciled on the shelf of the system.

**Range:** **1101-1108, 1111-1112, 1114, 1116, 1117, 1201-1208, 1211-1218, 1301-1308, 1311-1318, 2101-2108, 2111-2118, 2201-2208, 2211-2218, 2301-2308, 2311-2318, 3101-3108, 3111-3118, 3201-3208, 3211-3218, 3301-3308, 3311-3318, 4101-4108, 4111-4118, 4201-4208, 4211-4218, 4301-4308, 4311-4318, 5101-5108, 5111-5118, 5201-5208, 5211-5218, 5301-5308, 5311-5318, 6101-6108, 6111-6118**

## Example

```
rept-stat-db
rept-stat-db:display=all
rept-stat-db:loc=1207
rept-stat-db:db=stp
```

## Dependencies

The **db** and **loc** parameters cannot be specified at the same time.

The following card locations are not valid for this command: 1113, 1115, and all xy09 and xy10 locations (where x is the frame and y is the shelf).

One of the following features must be turned on, or the ATINP feature must be enabled before the **db=mps** parameter can be specified:

- A-Port
- AINPQ
- EIR
- G-Flex
- G-Port
- INP
- LNP ELAP Configuration
- Prepaid SMS Intercept Ph1
- V-Flex

The shelf and card must be equipped.

The card location slot must be between 1 and 18, but not 9 or 10.

The shelf location must be 11xx, 12xx, 13xx, 21xx, 22xx, 23xx, 31xx, 32xx, 33xx, 41xx, 42xx, 43xx, 51xx, 52xx, 53xx, or 61xx.

The frame value of the shelf location parameter (**loc**) must be within the valid range.

The **display** parameter can accept a value of **brief**, **all**, **version**, or **except** only.

## Notes

If the **display** parameter, the **db** parameter, or the **loc** parameter is specified and the database for a particular card location is not accessible, hyphens are displayed in place of the data.

The output of the **rept-stat-db** command with no parameters specified or with the **display=brief** parameter shows the following information:

- Activity status of both the active and standby MASP, the date and time the last backup was performed on the removable cartridge or drive (if inserted) and the fixed disk backup partition, coherency, the number of updates (level) to the backup partition of the fixed disk, and the current partition of the fixed disk
- If the EIR, G-Flex, G-Port, INP, PPSMS, or V-Flex feature is turned on, or the ATINP feature is enabled, EPAP A and EPAP B database status followed by Service Module card database status
- If the LNPELAP Configuration controlled feature is turned on, ELAP A and ELAP B database status followed by Service Module card database status

The output of the **rept-stat-db** command with the **display=except** parameter shows the coherency and the number of updates for all the cards whose database level does not match the active fixed disk current partition, reference database level, or is incoherent. All databases that are not accessible are also displayed. In addition, the time stamp for the last database update is displayed for every card.

The output of the **rept-stat-db** command with the **display=all** parameter shows the coherency and the number of updates for all of the distributed databases. In addition, the time stamp for the last database update is displayed for every card.

The output of the **rept-stat-db** command with the **display=version** parameter shows the coherency and the number of updates for the active and standby databases, along with the database version and

the operational status of each of these databases. If the LNP feature is turned on (see the **enable-ctrl-feat** command), the version of the LNP database is shown. No version is shown for EPAP or ELAP databases; use the **rept-stat-mps** command to display version information for these databases.

The output of the **rept-stat-db** command with the **loc** parameter specifying an equipped card shows the coherency and the number of updates to its database. In addition, the time stamp for the last database update is displayed for the specific card location.

The **db** parameter is used to limit the output of the **rept-stat-db** command to either just the EAGLE STP information or just the MPS information. The information is displayed as indicated by the **display** parameter value (**display=version** is not valid for **db=mps**; the command does not display the MPS database versions). The default **db** parameter value is **all**, which displays the information for the STP and MPS databases and cards as indicated by the **display** parameter value.

## Output

**NOTE: Credit card USB database information is shown only for the Active OAM slot, whether or not a credit card drive is inserted into the standby OAM.**

**NOTE: A status of 'OK' indicates that the database has no errors.**

The report for the specified card is displayed. The report shows that the disk is OFF-LINE indicating the disk has been dismounted. This is not necessarily a problem.

**rept-stat-db:loc=1114**

```
tekelecstp 08-08-29 08:38:25 NZST EAGLE 39.2.0
CARD/APPL LOC C T LEVEL TIME LAST UPDATE EXCEPTION
-----
TDM-CRNT 1114 - - - - - OFF-LINE
TDM-BKUP 1114 - - - - -
```

;

The report for the specified Service Module card used for EPAP or ELAP is displayed. The EIR, G-Flex, G-Port, INP, LNP ELAP Configuration, PPSMS, or V-Flex feature is turned on, or the ATINP feature is enabled.

**rept-stat-db:loc=1201**

```
tekelecstp 08-08-29 08:38:25 NZST EAGLE 39.2.0
CARD/APPL LOC C T LEVEL TIME LAST UPDATE EXCEPTION
-----
VSCCP 1201 Y N 12 08-05-29 08:53:48 -
```

```
EAGLE RTDB REPORT
CARD/APPL LOC C BIRTHDATE LEVEL EXCEPTION
-----
VSCCP 1201 Y 08-05-29 16:12:50 12345 -
```

;

The EIR, G-Flex, G-Port, INP, LNP ELAP Configuration, PPSMS, and V-Flex features are not turned on, and the ATINP feature is not enabled.

**rept-stat-db**

```
tekelecstp 08-08-29 08:38:25 NZST EAGLE 39.2.0
DATABASE STATUS: >> OK <<
      TDM 1114 ( ACTV )          TDM 1116 ( STDBY )
      C  LEVEL    TIME LAST BACKUP  C  LEVEL    TIME LAST BACKUP
-----
FD BKUP Y      11 08-05-29 08:20:13 NZST Y      11 08-05-29 08:20:13 NZST
FD CRNT Y      11
      MDAL 1117
-----
RD BKUP Y      1 08-05-29 15:44:20 NZST
```

;

The EIR, G-Flex, G-Port, INP, LNP ELAP Configuration, PPSMS, and V-Flex features are not turned on, and the ATINP feature is not enabled.

**rept-stat-db:display=all**

```
tekelecstp 08-08-29 08:39:24 NZST EAGLE 39.2.0
DATABASE STATUS: >> OK <<
      TDM 1114 ( ACTV )          TDM 1116 ( STDBY )
      C  LEVEL    TIME LAST BACKUP  C  LEVEL    TIME LAST BACKUP
-----
FD BKUP Y      11 08-05-29 08:20:13 NZST Y      11 08-05-29 08:20:13 NZST
FD CRNT Y      11
      MDAL 1117
```



```

;
RD BKUP Y          1 08-05-29 15:44:20 NZST
CARD/APPL LOC C T LEVEL          TIME LAST UPDATE  EXCEPTION
-----
SS7ANSI 1102 Y N 11          08-05-29 08:04:00      -
SS7ANSI 1103 Y N 11          08-05-29 08:04:00      -
VSCCP   1105 Y N 11          08-05-29 08:04:00      -
STPLAN  1107 Y N 11          08-05-29 08:04:00      -
TDM-CRNT 1114 Y N 11          08-05-29 08:04:00      -
TDM-BKUP 1114 Y - 11          08-05-29 08:04:00      -
TDM-CRNT 1116 Y N 11          08-05-29 08:04:00      -
TDM-BKUP 1116 Y - 11          08-05-29 08:04:00      -
MDAL     1117 Y - 1           08-05-29 15:06:29      DIFF LEVEL
VSCCP   1201 Y N 11          08-05-29 08:04:00      -
VSCCP   1203 Y N 11          08-05-29 08:04:00      -

```

The EIR, G-Flex, G-Port, INP, LNP ELAP Configuration, PPSMS, and V-Flex features are not turned on, and the ATINP feature is not enabled.

**NOTE: The rept-stat-db command does not display version information for MPS databases. Use the rept-stat-mps command to display the MPS database version information.**

**rept-stat-db:display=version**

```

tekelecstp 08-08-29 08:51:21 NZST EAGLE 39.2.0
DATABASE STATUS: >> OK <<
      TDM 1114 ( ACTV )          TDM 1116 ( STDBY)
      C  LEVEL    TIME LAST BACKUP    C  LEVEL    TIME LAST BACKUP
-----
FD BKUP Y          11 08-05-29 08:20:13 NZST Y          11 08-05-29 08:20:13 NZST
FD CRNT Y          11                      Y          11
      MDAL 1117
-----
RD BKUP Y          1 08-05-24 15:44:20 NZST

```

The LNP feature is turned on in the system (see the **enable-ctrl-feat** command).

**rept-stat-db:display=version**

```

tekelecstp 02-10-29 08:51:21 NZST EAGLE 30.0.0
DATABASE STATUS: >> OK <<
      TDM 1114 ( ACTV )          TDM 1116 ( STDBY)
      C  LEVEL    TIME LAST BACKUP    C  LEVEL    TIME LAST BACKUP
-----
FD BKUP Y          11 02-10-29 08:20:13 NZST Y          11 02-10-29 08:20:13 NZST
FD CRNT Y          11                      Y          11
      MDAL 1117
-----
RD BKUP Y          1 02-10-24 15:44:20 NZST
CARD/APPL LOC C T LEVEL          TIME LAST UPDATE  VERSION STATUS
-----
TDM-CRNT 1114 Y N 11          02-10-29 08:04:00      111-000-000  NORMAL
      LNP
TDM-BKUP 1114 Y - 11          02-10-29 08:04:00      111-000-000  NORMAL
      LNP
TDM-CRNT 1116 Y N 11          02-10-29 08:04:00      111-000-000  NORMAL
      LNP
TDM-BKUP 1116 Y - 11          02-10-29 08:04:00      111-000-000  NORMAL
      LNP
MDAL     1117 Y - 1           02-10-24 15:06:29      114-000-000  NORMAL
      LNP

```

The G-Flex, G-Port, EIR, INP, LNP ELAP Configuration, PPSMS, and V-Flex features are not turned on, and the ATINP feature is not enabled.

**rept-stat-db:display=except**

```
tekelecstp 08-08-29 08:55:54 NZST EAGLE 39.2.0
DATABASE STATUS: >> OK <<
      TDM 1114 ( ACTV )                TDM 1116 ( STDBY)
      C  LEVEL    TIME LAST BACKUP    C  LEVEL    TIME LAST BACKUP
-----
FD BKUP Y          11 08-05-29 08:20:13 NZST Y          11 08-05-29 08:20:13 NZST
FD CRNT Y           12                                Y           12
      MDAL 1117
-----
RD BKUP Y          1 07-10-24 15:44:20 NZST
CARD/APPL  LOC  C  T  LEVEL            TIME LAST UPDATE  EXCEPTION
-----
SS7ANSI    1103 Y  N  10                08-05-29 08:03:48  DIFF LEVEL
TDM-BKUP   1114 Y  -  11                08-05-29 08:04:00  DIFF LEVEL
TDM-BKUP   1116 Y  -  11                08-05-29 08:04:00  DIFF LEVEL
MDAL       1117 Y  -  1                08-05-24 15:06:29  DIFF LEVEL
```

;

The LNP ELAP Configuration controlled feature is turned on in the system, and ELAP is used.

**rept-stat-db**

```
tekelecstp 02-10-29 08:39:24 NZST EAGLE 30.0.0
DATABASE STATUS: >> OK <<
      TDM 1114 ( ACTV )                TDM 1116 ( STDBY)
      C  LEVEL    TIME LAST BACKUP    C  LEVEL    TIME LAST BACKUP
-----
FD BKUP Y          11 02-10-29 08:20:13 NZST Y          11 02-10-29 08:20:13 NZST
FD CRNT Y           11                                Y           11
      MDAL 1117
-----
RD BKUP Y          1 02-10-24 15:44:20 NZST
      ELAP A ( ACTV )
      C  BIRTHDATE            LEVEL            EXCEPTION
-----
RTDB                Y  02-10-29 08:20:04            12345            -
RTDB-EAGLE          Y  02-10-29 08:20:04            12345            -
      ELAP B ( STDBY )
      C  BIRTHDATE            LEVEL            EXCEPTION
-----
RTDB                Y  02-10-29 08:20:04            12345            -
RTDB-EAGLE          Y  02-10-29 08:20:04            12345            -
```

;

The LNP ELAP Configuration controlled feature is turned on in the system, and ELAP is used.

**rept-stat-db:display=all**

```
tekelecstp 02-10-29 08:39:24 NZST EAGLE 30.0.0
DATABASE STATUS: >> OK <<
      TDM 1114 ( ACTV )                TDM 1116 ( STDBY)
      C  LEVEL    TIME LAST BACKUP    C  LEVEL    TIME LAST BACKUP
-----
FD BKUP Y          11 02-10-29 08:20:13 NZST Y          11 02-10-29 08:20:13 NZST
FD CRNT Y           11                                Y           11
      MDAL 1117
-----
RD BKUP Y          1 02-10-24 15:44:20 NZST
CARD/APPL  LOC  C  T  LEVEL            TIME LAST UPDATE  EXCEPTION
-----
SS7ANSI    1102 Y  N  11                02-10-29 08:04:00  -
SS7ANSI    1103 Y  N  11                02-10-29 08:04:00  -
VS CCP     1105 Y  N  11                02-10-29 08:04:00  -
STPLAN     1107 Y  N  11                02-10-29 08:04:00  -
```

```
TDM-CRNT 1114 Y N 11 02-10-29 08:04:00 -
TDM-BKUP 1114 Y - 11 02-10-29 08:04:00 -
TDM-CRNT 1116 Y N 11 02-10-29 08:04:00 -
TDM-BKUP 1116 Y - 11 02-10-29 08:04:00 -
MDAL 1117 Y - 1 02-10-24 15:06:29 DIFF LEVEL
VSCCP 1201 Y N 11 02-10-29 08:04:00 -
VSCCP 1203 Y N 11 02-10-29 08:04:00 -
```

ELAP A ( ACTV )

```
  C BIRTHDATE LEVEL EXCEPTION
  - - - - -
RTDB Y 02-10-29 08:20:04 12345 -
RTDB-EAGLE 02-10-29 08:20:04 12345 -
```

ELAP B ( STDBY )

```
  C BIRTHDATE LEVEL EXCEPTION
  - - - - -
RTDB Y 02-10-29 08:20:04 12345 -
RTDB-EAGLE 02-10-29 08:20:04 12345 -
```

EAGLE RTDB REPORT

```
  CARD/APPL LOC C BIRTHDATE LEVEL EXCEPTION
  - - - - -
VSCCP 1201 Y 02-10-29 08:20:04 12345 -
VSCCP 1203 Y 02-10-29 08:20:04 12345 -
VSCCP 1105 Y 02-10-29 08:20:04 12345 -
```

;

The LNP ELAP Configuration controlled feature is turned on in the system, and ELAP is used.

**rept-stat-db:display=except**

tekelecstp 02-10-29 08:55:54 NZST EAGLE 30.0.0

DATABASE STATUS: >> OK <<

TDM 1114 ( ACTV )

```
  C LEVEL TIME LAST BACKUP
  - - - - -
FD BKUP Y 11 02-10-29 08:20:13 NZST
FD CRNT Y 12
```

MDAL 1117

```
RD BKUP Y 1 02-10-24 15:44:20 NZST
CARD/APPL LOC C T LEVEL TIME LAST UPDATE EXCEPTION
- - - - -
SS7ANSI 1103 Y N 10 02-10-29 08:03:48 DIFF LEVEL
TDM-BKUP 1114 Y - 11 02-10-29 08:04:00 DIFF LEVEL
TDM-BKUP 1116 Y - 11 02-10-29 08:04:00 DIFF LEVEL
MDAL 1117 Y - 1 02-10-24 15:06:29 DIFF LEVEL
```

ELAP A ( ACTV )

```
  C BIRTHDATE LEVEL EXCEPTION
  - - - - -
RTDB Y 02-10-29 08:20:04 12345 -
RTDB-EAGLE Y 02-10-29 08:20:04 12345 -
```

ELAP B ( STDBY )

```
  C BIRTHDATE LEVEL EXCEPTION
  - - - - -
RTDB Y 02-10-29 08:20:04 12345 -
RTDB-EAGLE Y 02-10-29 08:20:04 12345 -
```

EAGLE RTDB REPORT

```
  CARD/APPL LOC C BIRTHDATE LEVEL EXCEPTION
  - - - - -
VSCCP 1203 Y 02-10-29 08:20:04 12340 DIFF LEVEL
```

;

The G-Flex, G-Port, EIR, INP, PPSMS, or V-Flex feature is turned on, or the ATINP feature is enabled, and EPAP is used.

**rept-stat-db**

```
tekelecstp 08-08-29 08:39:24 NZST EAGLE 39.2.0
DATABASE STATUS: >> OK <<
      TDM 1114 ( ACTV )                TDM 1116 ( STDBY )
      C  LEVEL    TIME LAST BACKUP    C  LEVEL    TIME LAST BACKUP
-----
FD BKUP Y        11 08-05-29 08:20:13 NZST Y        11 08-05-29 08:20:13 NZST
FD CRNT Y        11                                Y        11
      MDAL 1117
-----
RD BKUP Y        1 08-05-24 15:44:20 NZST
      EPAP A ( ACTV )
      C  BIRTHDATE                LEVEL            EXCEPTION
-----
PDB                Y 08-05-29 08:20:04                12345            -
RTDB                Y 08-05-29 08:20:04                12345            -
RTDB-EAGLE         Y 08-05-29 08:20:04                12345            -
      EPAP B ( STDBY )
      C  BIRTHDATE                LEVEL            EXCEPTION
-----
PDB                Y 08-05-29 08:20:04                12345            -
RTDB                Y 08-05-29 08:20:04                12345            -
RTDB-EAGLE         Y 08-05-29 08:20:04                12345            -
;

```

The EIR, G-Flex, G-Port, INP, PPSMS, or V-Flex feature is turned on, or the ATINP feature is enabled, and EPAP is used.

**rept-stat-db:display=all**

```
tekelecstp 08-08-29 08:39:24 NZST EAGLE 39.2.0
DATABASE STATUS: >> OK <<
      TDM 1114 ( ACTV )                TDM 1116 ( STDBY )
      C  LEVEL    TIME LAST BACKUP    C  LEVEL    TIME LAST BACKUP
-----
FD BKUP Y        11 08-05-29 08:20:13 NZST Y        11 08-05-29 08:20:13 NZST
FD CRNT Y        11                                Y        11
      MDAL 1117
-----
RD BKUP Y        1 08-05-24 15:44:20 NZST
CARD/APPL LOC C T LEVEL            TIME LAST UPDATE    EXCEPTION
-----
SS7ANSI 1102 Y N 11                08-05-29 08:04:00    -
SS7ANSI 1103 Y N 11                08-05-29 08:04:00    -
STPLAN 1107 Y N 11                08-05-29 08:04:00    -
TDM-CRNT 1114 Y N 11                08-05-29 08:04:00    -
TDM-BKUP 1114 Y - 11                08-05-29 08:04:00    -
TDM-CRNT 1116 Y N 11                08-05-29 08:04:00    -
TDM-BKUP 1116 Y - 11                08-05-29 08:04:00    -
MDAL 1117 Y - 1                    08-05-29 15:06:29    DIFF LEVEL
VSCCP 1201 Y N 11                08-05-29 08:04:00    -
VSCCP 1203 Y N 11                08-05-29 08:04:00    -
      EPAP A ( ACTV )
      C  BIRTHDATE                LEVEL            EXCEPTION
-----
PDB                Y 08-05-29 08:20:04                12345            -
RTDB                Y 08-05-29 08:20:04                12345            -
RTDB-EAGLE         Y 08-05-29 08:20:04                12345            -
      EPAP B ( STDBY )
      C  BIRTHDATE                LEVEL            EXCEPTION
-----
PDB                Y 08-05-29 08:20:04                12345            -
RTDB                Y 08-05-29 08:20:04                12345            -
RTDB-EAGLE         Y 08-05-29 08:20:04                12345            -
EAGLE RTDB REPORT

```

```

CARD/APPL  LOC  C  BIRTHDATE          LEVEL          EXCEPTION
-----
VSCCP      1201 Y  08-05-29 08:20:04    12345          -
VSCCP      1203 Y  08-05-29 08:20:04    12345          -
VSCCP      1105 Y  08-05-29 08:20:04    12345          -

```

;

The EIR, G-Flex, G-Port, INP, PPSMS, or V-Flex feature is turned on, or the ATINP feature is enabled, and EPAP is used.

**rept-stat-db:display=except**

```

tekelecstp 08-08-29 08:55:54 NZST  EAGLE 39.2.0
DATABASE STATUS: >> OK <<
      TDM 1114 ( ACTV )          TDM 1116 ( STDBY)
      C  LEVEL    TIME LAST BACKUP    C  LEVEL    TIME LAST BACKUP
-----
FD BKUP Y        11 08-05-29 08:20:13 NZST Y        11 08-05-29 08:20:13 NZST
FD CRNT Y        12                                Y        12
      MDAL 1117
-----
RD BKUP Y        1 02-10-24 15:44:20 NZST
CARD/APPL  LOC  C  T  LEVEL          TIME LAST UPDATE    EXCEPTION
-----
SS7ANSI    1103 Y  N  10          08-05-29 08:03:48    DIFF LEVEL
TDM-BKUP   1114 Y  -  11          08-05-29 08:04:00    DIFF LEVEL
TDM-BKUP   1116 Y  -  11          08-05-29 08:04:00    DIFF LEVEL
MDAL       1117 Y  -  1          08-05-29 15:06:29    DIFF LEVEL
      EPAP A ( ACTV )
      C  BIRTHDATE          LEVEL          EXCEPTION
-----
PDB        Y  08-05-29 08:20:04    12345          -
RTDB       Y  08-05-29 08:20:04    12345          -
RTDB-EAGLE Y  08-05-29 08:20:04    12345          -
      EPAP B ( STDBY )
      C  BIRTHDATE          LEVEL          EXCEPTION
-----
PDB        Y  08-05-29 08:20:04    12345          -
RTDB       Y  08-05-29 08:20:04    12345          -
RTDB-EAGLE Y  08-05-29 08:20:04    12345          -
      EAGLE RTDB REPORT
CARD/APPL  LOC  C  BIRTHDATE          LEVEL          EXCEPTION
-----
VSCCP      1203 Y  08-05-29 08:20:04    12340          DIFF LEVEL

```

;

The G-Flex, G-Port, EIR, INP, LNP ELAP Configuration, PPSMS, and V-Flex features are not turned on, and the ATINP feature is not enabled.

**rept-stat-db:db=stp**

```

tekelecstp 08-08-29 08:39:24 NZST  EAGLE 39.2.0
DATABASE STATUS: >> OK <<
      TDM 1114 ( ACTV )          TDM 1116 ( STDBY)
      C  LEVEL    TIME LAST BACKUP    C  LEVEL    TIME LAST BACKUP
-----
FD BKUP Y        11 08-05-29 08:20:13 NZST Y        11 08-05-29 08:20:13 NZST
FD CRNT Y        11                                Y        11
      MDAL 1117
-----
RD BKUP Y        1 08-05-29 15:44:20 NZST

```

;

The EIR, G-Flex, G-Port, INP, LNP ELAP Configuration, PPSMS, and V-Flex features are not turned on, and the ATINP feature is not enabled.

**rept-stat-db:display=all:db=stp**

```

tekelecstp 08-08-29 08:39:24 NZST  EAGLE 39.2.0
DATABASE STATUS: >> OK <<

```

```

TDM 1114 ( ACTV )
C  LEVEL      TIME LAST BACKUP
-----
FD BKUP Y      11 07-08-29 08:20:13 NZST
FD CRNT Y      11
MDAL 1117
-----
RD BKUP Y      1 02-10-24 15:44:20 NZST
CARD/APPL  LOC  C  T  LEVEL      TIME LAST UPDATE  EXCEPTION
-----
SS7ANSI    1102 Y  N  11      07-08-29 08:04:00  -
SS7ANSI    1103 Y  N  11      07-08-29 08:04:00  -
VSCCP      1105 Y  N  11      07-08-29 08:04:00  -
STPLAN     1107 Y  N  11      07-08-29 08:04:00  -
TDM-CRNT   1114 Y  N  11      07-08-29 08:04:00  -
TDM-BKUP   1114 Y  -  11      07-08-29 08:04:00  -
TDM-CRNT   1116 Y  N  11      07-08-29 08:04:00  -
TDM-BKUP   1116 Y  -  11      07-08-29 08:04:00  -
MDAL       1117 Y  -  1      07-08-24 15:06:29  DIFF LEVEL
VSCCP      1201 Y  N  11      07-08-29 08:04:00  -
VSCCP      1203 Y  N  11      07-08-29 08:04:00  -

```

The G-Flex, G-Port, EIR, INP, LNP ELAP Configuration, PPSMS, and V-Flex features are not turned on and the ATINP feature is not enabled.

**rept-stat-db:display=except:db=stp**

```

tekelecstp 08-08-29 08:55:54 NZST EAGLE 39.2.0
DATABASE STATUS: >> OK <<
TDM 1114 ( ACTV )
C  LEVEL      TIME LAST BACKUP
-----
FD BKUP Y      11 08-05-29 08:20:13 NZST
FD CRNT Y      12
MDAL 1117
-----
RD BKUP Y      1 08-05-24 15:44:20 NZST
CARD/APPL  LOC  C  T  LEVEL      TIME LAST UPDATE  EXCEPTION
-----
SS7ANSI    1103 Y  N  10      08-05-29 08:03:48  DIFF LEVEL
TDM-BKUP   1114 Y  -  11      08-05-29 08:04:00  DIFF LEVEL
TDM-BKUP   1116 Y  -  11      08-05-29 08:04:00  DIFF LEVEL
MDAL       1117 Y  -  1      08-05-29 15:06:29  DIFF LEVEL

```

The LNP ELAP Configuration controlled feature is turned on, and ELAP is used.

**rept-stat-db:db=mps**

```

tekelecstp 02-10-29 08:55:54 NZST EAGLE 30.0.0
ELAP A ( ACTV )
C  BIRTHDATE      LEVEL      EXCEPTION
-----
RTDB              Y  02-10-29 08:20:04  12345      -
RTDB-EAGLE       02-10-29 08:20:04  12345      -
ELAP B ( STDBY )
C  BIRTHDATE      LEVEL      EXCEPTION
-----
RTDB              Y  02-10-29 08:20:04  12345      -
RTDB-EAGLE       02-10-29 08:20:04  12345      -

```

The LNP ELAP Configuration controlled feature is turned on, and ELAP is used. Card 1203 indicates a value 12 in the exception column. The value indicates the number of times that the Corruption Cross Correction function has corrected the card during the time that the card has been in service.

More specifically, the card has encountered 12 corrupted records and has subsequently repaired them. This value persists until the card is reset.

**rept-stat-db:display=all:db=mps**

```
tekelecstp 02-10-29 08:55:54 NZST EAGLE 31.6.0
      ELAP A ( ACTV )
      C BIRTHDATE          LEVEL          EXCEPTION
      - - - - -
RTDB           Y 02-10-29 08:20:04      12345          -
RTDB-EAGLE    Y 02-10-29 08:20:04      12345          -

      ELAP B ( STDBY )
      C BIRTHDATE          LEVEL          EXCEPTION
      - - - - -
RTDB           Y 02-10-29 08:20:04      12345          -
RTDB-EAGLE    Y 02-10-29 08:20:04      12345          -

      EAGLE RTDB REPORT
      CARD/APPL  LOC  C BIRTHDATE          LEVEL          EXCEPTION  IN-SRVC
      - - - - -
VSCCP          1201 Y 02-10-29 08:20:04      12345          -           10d 23h 21m
VSCCP          1203 Y 02-10-29 08:20:04      12345          12           10d 23h 21m
VSCCP          1105 Y 02-10-29 08:20:04      12345          -            5d  3h  1m

VSCCP          1201 Y 02-10-29 08:20:04      12345          -
VSCCP          1203 Y 02-10-29 08:20:04      12345          -
VSCCP          1105 Y 02-10-29 08:20:04      12345          -

;

;
```

The LNP ELAP Configuration controlled feature is turned on, and ELAP is used.

**rept-stat-db:display=except:db=mps**

```
tekelecstp 02-10-29 08:55:54 NZST EAGLE 31.6.0
      ELAP A ( ACTV )
      C BIRTHDATE          LEVEL          EXCEPTION
      - - - - -
RTDB           Y 02-10-29 08:20:04      12345          -
RTDB-EAGLE    Y 02-10-29 08:20:04      12345          -

      ELAP B ( STDBY )
      C BIRTHDATE          LEVEL          EXCEPTION
      - - - - -
RTDB           Y 02-10-29 08:20:04      12345          -
RTDB-EAGLE    Y 02-10-29 08:20:04      12345          -

      EAGLE RTDB REPORT
      CARD/APPL  LOC  C BIRTHDATE          LEVEL          EXCEPTION  IN-SRVC
      - - - - -
VSCCP          1203 Y 02-10-29 08:20:04      12340  DIFF LEVEL  10d 23h 21m

;

;
```

The G-Flex, G-Port, EIR, INP, PPSMS, or V-Flex feature is turned on, or the ATINP feature is enabled, and EPAP is used.

**rept-stat-db:db=mps**

```
tekelecstp 08-08-29 08:55:54 NZST EAGLE 39.2.0
      EPAP A ( ACTV )
      C BIRTHDATE          LEVEL          EXCEPTION
      - - - - -
PDB            Y 08-05-29 08:20:04      12345          -
RTDB           Y 08-05-29 08:20:04      12345          -
RTDB-EAGLE    Y 08-05-29 08:20:04      12345          -

      EPAP B ( STDBY )
      C BIRTHDATE          LEVEL          EXCEPTION
```

```

-----
PDB          Y 08-05-29 08:20:04      12345      -
RTDB         Y 08-05-29 08:20:04      12345      -
RTDB-EAGLE   Y 08-05-29 08:20:04      12345      -

```

;

The EIR, G-Flex, G-Port, EIR, INP, PPSMS, or V-Flex feature is turned on, or the ATINP feature is enabled, and EPAP is used.

**rept-stat-db:display=all:db=mps**

```

tekelecstp 08-05-29 08:55:54 NZST  EAGLE 39.2.0
      EPAP A ( ACTV )
      C  BIRTHDATE          LEVEL          EXCEPTION
      -  -----
PDB          Y 07-08-29 08:20:04      12345      -
RTDB         Y 07-08-29 08:20:04      12345      -
RTDB-EAGLE   Y 07-08-29 08:20:04      12345      -

      EPAP B ( STDBY )
      C  BIRTHDATE          LEVEL          EXCEPTION
      -  -----
PDB          Y 07-08-29 08:20:04      12345      -
RTDB         Y 07-08-29 08:20:04      12345      -
RTDB-EAGLE   Y 07-08-29 08:20:04      12345      -

      EAGLE RTDB REPORT
      CARD/APPL  LOC  C  BIRTHDATE          LEVEL          EXCEPTION          IN-SRVC
      -----
VSCCP          1201 Y 07-08-29 08:20:04      12345      -          10d 23h 21m
VSCCP          1203 Y 07-08-29 08:20:04      12345      -          10d 23h 21m
VSCCP          1105 Y 07-08-29 08:20:04      12345      -           5d  3h  1m

```

;

The EIR, G-Flex, G-Port, INP, PPSMS, or V-Flex feature is turned on, or the ATINP feature is enabled, and EPAP is used.

**rept-stat-db:display=except:db=mps**

```

tekelecstp 08-08-29 08:55:54 NZST  EAGLE 39.2.0
      EPAP A ( ACTV )
      C  BIRTHDATE          LEVEL          EXCEPTION
      -  -----
PDB          Y 07-08-29 08:20:04      12345      -
RTDB         Y 07-08-29 08:20:04      12345      -
RTDB-EAGLE   Y 07-08-29 08:20:04      12345      -

      EPAP B ( STDBY )
      C  BIRTHDATE          LEVEL          EXCEPTION
      -  -----
PDB          Y 07-08-29 08:20:04      12345      -
RTDB         Y 07-08-29 08:20:04      12345      -
RTDB-EAGLE   Y 07-08-29 08:20:04      12345      -

      EAGLE RTDB REPORT
      CARD/APPL  LOC  C  BIRTHDATE          LEVEL          EXCEPTION          IN-SRVC
      -----
VSCCP          1203 Y 07-08-29 08:20:04      12340  DIFF LEVEL  10d 23h 21m

```

;

The following example displays output when E5-MCAP and E5-TDM cards are used.

**rept-stat-db**

```

e5oam 08-12-01 15:25:40 EST  EAGLE 40.1.0
DATABASE STATUS: >> OK <<
      TDM 1114 ( STDBY)          TDM 1116 ( ACTV )
      C  LEVEL          TIME LAST BACKUP  C  LEVEL          TIME LAST BACKUP
      -  -----
FD BKUP Y          36 08-11-19 09:38:25 EST  Y          36 08-11-19 09:38:25 EST

```



```

FD CRNT Y          39                      Y          39
          MCAP 1113                      MCAP 1115
          - - - - -
RD BKUP Y          36 08-11-19 09:27:17 EST Y          36 08-11-19 09:27:17 EST
USB BKP -          -          -          -          Y          3 08-11-07 01:11:22 EST
    
```

;

**rept-stat-db:display=all**

```

e5oam 08-12-01 15:26:27 EST EAGLE 40.1.0
DATABASE STATUS: >> OK <<
          TDM 1114 ( STDBY)                TDM 1116 ( ACTV )
          C  LEVEL      TIME LAST BACKUP   C  LEVEL      TIME LAST BACKUP
          - - - - -
FD BKUP Y          36 08-11-19 09:38:25 EST Y          36 08-11-19 09:38:25 EST
FD CRNT Y          39                      Y          39
          MCAP 1113                      MCAP 1115
          - - - - -
RD BKUP Y          36 08-11-19 09:27:17 EST Y          36 08-11-19 09:27:17 EST
USB BKP -          -          -          -          -          -          -          -

CARD/APPL  LOC  C  T  LEVEL      TIME LAST UPDATE  EXCEPTION
-----
MCP         1108 -  -  -          -          -          -
IPS         1111 Y  N  39      08-11-22 10:21:54  -
OAM-RMV     1113 Y  -  36      08-11-18 23:36:19  DIFF LEVEL
TDM-CRNT    1114 Y  N  39      08-11-22 10:21:54  -
TDM-BKUP    1114 Y  -  36      08-11-18 23:36:38  DIFF LEVEL
OAM-RMV     1115 Y  -  36      08-11-18 23:36:19  DIFF LEVEL
OAM-USB     1115 Y  -  3        08-11-07 01:11:22  DIFF LEVEL
TDM-CRNT    1116 Y  N  39      08-11-22 10:21:54  -
TDM-BKUP    1116 Y  -  36      08-11-18 23:36:38  DIFF LEVEL
    
```

**Legend**

**DATABASE STATUS**—An indication of any database alarms on the MASPs. This indicator is not used with the **loc** parameter output.

>> **OK**<<—There are no database alarms

>> **NOT OK**<<—Database alarms are present

**(ACTV MASP)**—The specified MASP is the active processor. This is not used with the **loc** parameter output.

**(STDBY MASP)**—The specified MASP is the standby processor. This is not used with the **loc** parameter output.

**(NOACCS)**—The specified processor is not accessible. This is not used with the **loc** parameter output.

**C**—An indicator of whether the database is coherent.

**Y**—the database is coherent

**N**—the database is not coherent

Dash (-)—the database is not accessible.

**LEVEL**—The number of updates made to the database partitions.

**TIME LAST BACKUP**—The date and time the last change was performed on the removable cartridges or drives (if inserted) and the backup partition of the fixed disk. This field is not used with the **loc** parameter output.

**RD BKUP**—Removable cartridge or drive backup partition.

**FD BKUP**—Fixed disk backup partition.

**FD CRNT**—Fixed disk current partition. This field is not used with the **loc** parameter output.

**DIFF CONTENTS**—The specified database's contents are different when compared to the other database in that partition.

**DIFF LEVEL**—The specified database's level does not match the level of the current partition of the active fixed disk (**FD CRNT**).

**DIFF TIME**—The specified database's level matches the level of the current partition of the active fixed disk (**FD CRNT**), but the time that the database was updated, when compared to the current partition of the active fixed disk (**FD CRNT**), is different. This exception indicator appears only if the time and date stamp in an update packet or in memory becomes corrupted.

**CORRUPTED**—The specified database is corrupted.

**INCOHERENT**—The specified database is incoherent.

**EXCEPTION**—The following values can appear:

- The condition of the specified database with which the system has detected a problem. These conditions are: **DIFF CONTENTS**, **DIFF LEVEL**, **DIFF TIME**, **CORRUPTED**, and **INCOHERENT**. A “-” indicates that the database was not accessible. A blank entry indicates that the database has no problems. This field is used with the **display=except**, **display=all**, and **loc** parameter outputs.
- A value that indicates the number of times that the Corruption Cross Correction function has corrected the card during the time that the card has been in service. This value persists until the card is reset.

**IN-SRVC**—The length of time that the card has been in service.

**CARD/APPL**—The card type or the application assigned to the card specified in the **LOC** field. This field is not used with the **display=brief** (default) parameter output.

**TDM-BKUP**—Backup partition on the fixed disk on the TDM.

**TDM-CRNT**—Current partition on the fixed disk on the TDM.

**LOC**—The card location of the database. This field is not used with the **display=brief** (default) parameter output.

**T**—An indicator of whether the specified database is in transition. A database is in transition when the database for the link interface module (LIM), TSM, or E5-TSM is in the process of being loaded with the new screen set information after an update to the database, and the database has not reached the current reported database level. This field is not used with the **display=brief** (default) parameter output.

**Y**—the database is in transition

**N**—the database is not in transition.

**TIME LAST BACKUP**—The date and time the last change was performed on the specified card and its associated database. A dash (–) in this field for the fixed drive (FD) or removable cartridge or drive (RD) indicates that no backup has been created on that drive. This field is not used with the **display=brief** (default) parameter output.

**VERSION**—The version number of each database (including the LNP database if the LNP feature is on).

**xxx-xxx-xxx**—The version number of the database.

**UNKNOWN**—The **rept-stat-db** command can show the version number only for a database that is version 20.0.0 or later. Any database version that is earlier than version 20.0.0 cannot be determined and UNKNOWN is displayed for the database version number.

A dash “-” —The database is not available. This field is used only with the **display=version** parameter output.

**STATUS**—The operational status of the database version. This field is used only with the **display=version** parameter output.

**NORMAL**—The database version is fully operational.

Blank entry—A blank entry indicates that the database is not available or is unknown. A numeric value indicates that the database is invalid. The value displayed is the status value found in the field and is for diagnostic purposes.

**BIRTHDATE**—The date and time of creation for the database.

**EPAP A (ACTV)**—The active EAGLE Provisioning Application Processor. This section of the report appears only if the G-Port, G-Flex, EIR, INP, PPSMS, or V-Flex features are turned on or the ATINP feature is enabled.

**PDB**—The provisioning database status information.

**RTDB**—The provisioning database status information that was used to create the resident Realtime Database. The RTDB information may be different than the PDB information if the PDB has been reloaded, or if the RTDB has not been loaded from the PDB. If the RTDB birthdate is different than the PDB or if the level is too old to be able to resynchronize the databases, then a "Reload Required" alarm is generated.

**RTDB-EAGLE**—The EPAP resident Realtime Database status information. This database is downloaded to Service Module cards. If the birthdate or level do not match the Service Module card, then the Service Module card generates an alarm. The RTDB is reloaded from the PDB, and the birthdate and level are reset and do not match the database status information. This database status mismatch condition indicates an abnormal condition that requires Service Module cards to be reloaded.

**EPAP B (STDBY)**—The standby EAGLE Provisioning Application Processor. This section of the report appears only if the G-Port, G-Flex, EIR, INP, PPSMS, or V-Flex features are turned on, or the ATINP feature is enabled.

**PDB**—The provisioning database status information.

**RTDB**—The provisioning database status information that was used to create the resident Realtime Database. The RTDB information may be different than the PDB information if the PDB has been reloaded, or if the RTDB has not been loaded from the PDB. If the RTDB birthdate is different than the PDB or if the level is too old to be able to resynchronize the databases, then a "Reload Required" alarm is generated.

**RTDB-EAGLE**—The EPAP resident Realtime Database status information. This database is downloaded to Service Module cards. If the birthdate or level do not match the Service Module card, then the Service Module card generates an alarm. The RTDB is reloaded from the PDB, and the birthdate and level are reset and do not match the database status information. This database status mismatch condition indicates an abnormal condition that requires Service Module cards to be reloaded.

**ELAP A (ACTV)**—The active EAGLE LNP Application Processor. This section of the report appears only if the LNP ELAP Configuration controlled feature (see the **enable-ctrl-feat** command) is turned on.

**RTDB-EAGLE**—The ELAP resident Database status information. This database is downloaded to Service Module cards. If the birthdate or level do not match the Service Module card, then the Service Module card generates an alarm.

**TIME LAST UPDATE**—The date and time of the last update of the RTDB from the LSMS.

**ELAP B (STDBY)**—The standby EAGLE LNP Application Processor. This section of the report appears only if the LNP ELAP Configuration controlled feature (see the **enable-ctrl-feat** command) is turned on.

**RTDB-EAGLE**—The ELAP resident Realtime Database status information. This database is downloaded to Service Module cards. If the birthdate or level do not match the Service Module card, then the Service Module card generates an alarm.

**TIME LAST UPDATE**—The date and time of the last update of the RTDB from the LSMS.

## rept-stat-ddb

## Report Dynamic Database Status

Use this command to obtain the most recent dynamic database (DDB) audit report.

**NOTE: The DDB audit report displays the checksums of the Route, Linkset, Link, CM Card, CM Cluster, Mated Application, and MTP globals. The report displays the exact status of active MTP card after audit and cause of that status.**

**Keyword:** rept-stat-ddb

**Related Commands:** aud-data, dbg-ddb

**Command Class:** System Maintenance

### Parameters

**:display=** (optional)

This parameter specifies the type of report to display.

**Range:** brief, all

**Default:** brief

**:filter=** (optional)

This parameter provides a full DDB audit report for cards that meet the specified criteria.

**Range:** resp, nrsp, incn, cons, ncons, ndat, nddl, nddb, duip, duipt, duipc, nquiet

**resp**— Responding cards

**nrsp**— Non-responding cards

**incn**— Inconsistent cards

**cons**— Consistent cards

**ncons**— Not-consistent cards: includes cards marked as inconsistent, DDB update in progress, having idle period less than quiet period, and sending replies marked as NO\_DATA

**ndat**— Cards marked as "No Data" because the checksum of dynamic tables is not available

**nddl**— Cards marked as "No Data " because the checksum of dynamic tables is not available due to the DDL crossload being in incomplete state

**nddb**— Cards marked as "No Data" because the checksum of dynamic tables is not available due to non-initialization of DDB

**duip**— Cards returning replies marked as "DDB update in progress"

**duipt**— Cards returning replies marked as "DDB update in progress" due to incomplete evaluation of TSRC task

**duipc**— Cards returning replies marked as "DDB update in progress" due to incomplete checksum calculation

**nquiet**— Cards returning replies having idle period less than the quiet period

**:list=** (optional)

This parameter displays a list of cards that meet the specified criteria.

**Range:** **resp, nrsp, incn, cons, ncons, ndat, nddl, nddb, duip, duipt, duipc, nquiet**

**resp**— Responding cards

**nrsp**— Non-responding cards

**incn**— Inconsistent cards

**cons**— Consistent cards

**ncons**— Not-consistent cards, including cards marked as inconsistent, DDB update in progress, having idle period less than quiet period, and sending replies marked as NO\_DATA

**ndat**— Cards marked as "No Data " because the checksum of dynamic tables is not available

**nddl**— Cards marked as "No Data " because the checksum of dynamic tables is not available due to the DDL crossload being in incomplete state

**nddb**— Cards marked as "No Data " because the checksum of dynamic tables is not available due to non-initialization of the DDB

**duip**— Cards returning replies marked as "DDB update in progress"

**duipt**— Cards returning replies marked as "DDB update in progress" due to incomplete evaluation of TSRC task

**duipc**— Cards returning replies marked as "DDB update in progress" due to incomplete checksum calculation

**nquiet**— Cards returning replies marked as having the idle period less than the quiet period

### Example

```
rept-stat-ddb
rept-stat-ddb:display=all
rept-stat-ddb:list=resp
rept-stat-ddb:filter=nddb
```

### Dependencies

Audit data is available only if the execution of a periodic or manual DDB audit is complete (see the **aud-data** command).

If the system is in upgrade mode, then this command cannot be entered.

The **display**, **list**, and **filter** parameters cannot be specified together in the command.

### Notes

A question mark (?) indicates that the corresponding card's status is not evaluated (Inconsistent/Consistent) when system status is marked as ABORTED.

Cards having an additional status of IGNORED responded with "DDB update in progress". These cards are not considered for calculating system status.

Output

The MATED APPL field is displayed only for Service Module cards.

rept-stat-ddb:display=all

```

tekelecstp 09-07-21 21:10:17 GMT EAGLE 41.1.0
DDB AUDIT REPORT
SYSTEM STATUS           : INCONSISTENT
ACTIVE MTP CARDS       : 21
NON RESPONDING CARDS   : 7: 1207 1208 1211 1212 2108 2111 2112
RESPONDING CARDS       : 14
CARDS WITH NO DATA    : 2
CARDS WITH DATA       : 12
CARDS FAILING QUIET PRD : 0
CARDS WITH DDB UPD IN PRG : 3
CARDS CONSIDERED FOR CKSM : 9
INCONSISTENT CARDS     : 2: 1203 2103
CONSISTENT CARDS       : 7
AUDIT START TIME       : 21/07/2009 21:07:54
QUIET PERIOD           : 600 ms

RTE      LINK SET  LINK      CM CARD  CM CLSTR  MATED APPL MTP GLOBL
LOC  STATUS  CAUSE      IDLE      DDB UPD  ADDN'L STATUS
H'000003e8 H'000003e8 H'000003e8 H'000003e8 H'000003e8 H'000003e8 H'000003e8
1201  CONSISTENT              700      1000
H'000003e8 H'000003e8 H'000003e8 H'000003e8 H'000003e8 H'000003e8 H'000003e8
1202  CONSISTENT              700      1000
H'000007d0 H'000007d0 H'000007d0 H'000007d0 H'000007d0 H'000007d0 H'000007d0
1203  INCONSISTENT          700      1000
-----
1204  NODATA      (DDB INIT)  -----
H'00000bb8 H'00000bb8 H'00000bb8 H'00000bb8 H'00000bb8 H'00000bb8 H'00000bb8
1205  IN UPDATE 1  (TSRC,DDB)  700      1000      (IGNORED)
H'000003e8 H'000003e8 H'000003e8 H'000003e8 H'000003e8 H'000003e8 H'000003e8
1206  CONSISTENT              700      1000
-----
1207  NORESP
-----
1208  NORESP
-----
1211  NORESP
-----
1212  NORESP
-----
H'000003e8 H'000003e8 H'000003e8 H'000003e8 H'000003e8 H'000003e8 H'000003e8
1213  CONSISTENT              700      1000
H'000003e8 H'000003e8 H'000003e8 H'000003e8 H'000003e8 ----- H'000003e8
2101  CONSISTENT              700      1000
H'000003e8 H'000003e8 H'000003e8 H'000003e8 H'000003e8 ----- H'000003e8
2102  CONSISTENT              700      1000
H'000007d0 H'000007d0 H'000007d0 H'000007d0 H'000007d0 ----- H'000007d0
2103  INCONSISTENT          700      1000      (WWA UPD=2)
-----
2104  NODATA      (DDL XLOAD)  -----
H'00000bb8 H'00000bb8 H'00000bb8 H'00000bb8 H'00000bb8 ----- H'00000bb8
2105  IN UPDATE 2  (DDB)      700      1000      (IGNORED)
H'00000bb8 H'00000bb8 H'00000bb8 H'00000bb8 H'00000bb8 ----- H'00000bb8
2106  IN UPDATE 2  (TSRC,DDB)  700      1000      (IGNORED)
H'000003e8 H'000003e8 H'000003e8 H'000003e8 H'000003e8 ----- H'000003e8
2107  CONSISTENT              700      1000
-----
2108  NORESP
-----
2111  NORESP
-----
2112  NORESP
-----

```

```

Command Completed.
;
rept-stat-ddb
tekelecstp 09-07-21 21:10:32 GMT EAGLE 41.1.0
DDB AUDIT REPORT
SYSTEM STATUS           : OK
ACTIVE MTP CARDS       : 10
NON RESPONDING CARDS   : 0
RESPONDING CARDS      : 10
CARDS WITH NO DATA    : 0
CARDS WITH DATA      : 10
CARDS FAILING QUIET PRD : 0
CARDS WITH DDB UPD IN PRG : 0
CARDS CONSIDERED FOR CKSM : 10
INCONSISTENT CARDS    : 0
CONSISTENT CARDS      : 0
AUDIT START TIME      : 21/07/2009 21:07:54
QUIET PERIOD          : 20 ms
    
```

```

Command Completed.
;
rept-stat-ddb:filter=incn
tekelecstp 09-07-21 21:09:32 GMT EAGLE 41.1.0
DDB AUDIT REPORT
SYSTEM STATUS           : INCONSISTENT
ACTIVE MTP CARDS       : 21
NON RESPONDING CARDS   : 7: 1207 1208 1211 1212 2108 2111 2112
RESPONDING CARDS      : 14
CARDS WITH NO DATA    : 2
CARDS WITH DATA      : 12
CARDS FAILING QUIET PRD : 0
CARDS WITH DDB UPD IN PRG : 3
CARDS CONSIDERED FOR CKSM : 9
INCONSISTENT CARDS    : 2: 1203 2103
CONSISTENT CARDS      : 7
AUDIT START TIME      : 21/07/2009 21:07:54
QUIET PERIOD          : 600 ms
    
```

| RTE        | LINK SET     | LINK       | CM CARD    | CM CLSTR   | MATED APPL | MTP GLOBL   |
|------------|--------------|------------|------------|------------|------------|-------------|
| LOC        | STATUS       | CAUSE      | IDLE       | DDB UPD    | ADDN'L     | STATUS      |
| H'000007d0 | H'000007d0   | H'000007d0 | H'000007d0 | H'000007d0 | H'000007d0 | H'000007d0  |
| 1203       | INCONSISTENT |            | 700        | 1000       |            |             |
| H'000007d0 | H'000007d0   | H'000007d0 | H'000007d0 | H'000007d0 | -----      | H'000007d0  |
| 2103       | INCONSISTENT |            | 700        | 1000       |            | (WWA UPD=2) |

```

Command Completed.
;
rept-stat-ddb:list=nrsp
tekelecstp 09-07-21 21:07:54 GMT EAGLE 41.1.0
DDB AUDIT REPORT CARD LIST [ NON RESPONDING CARDS ] (6)

1207, 1208, 1211, 1212, 2108, 2111
    
```

Command Completed.

MTP Cards sending replies marked as "DDB update in progress" are distributed in two rows depending upon the number of times the MTP card consecutively reported "DDB updates in progress".

```

rept-stat-ddb:list=duip
tekelecstp 09-07-21 21:07:54 GMT EAGLE 41.1.0
DDB AUDIT REPORT CARD LIST [ DDB UPDATE IN PROGRESS ] (2)
    
```

DDB UPDATES IN PROGRESS (>= 6 TIMES) (0)

DDB UPDATES IN PROGRESS (< 6 TIMES) (2)  
1205, 2105

Command Completed.

;

**rept-stat-ddb:list=nquiet**

tekelecstp 09-07-21 21:07:54 GMT EAGLE 41.1.0  
DDB AUDIT REPORT CARD LIST [CARDS WITH NQUIET] (0)

Command Completed.

;

**Legend**

- **SYSTEM STATUS:**
  - **OK**—DDB is consistent on all active MTP cards or no active MTP card is present in system
  - **INCONSISTENT**—DDB is inconsistent
  - **UNKNOWN**—"All active MTP cards in the system responded without the checksum of DDB table" or "No active MTP card in the system responded to audit request"
  - **ABORTED**—"Checksums collected failed to meet the quiet period requirement" or "Number of cards responded with "DDB update in progress" greater than 25% number of cards responded with data"
- **ACTIVE MTP CARDS**—Number of active MTP cards
- **NON RESPONDING CARDS**—Number of non-responding cards
- **RESPONDING CARDS**—Number of responding cards
- **CARDS WITH NO DATA**—Cards sending replies without the checksum of dynamic tables, due to incomplete DDL crossload or DDB initialization
- **CARDS WITH DATA**—Cards sending replies with checksums
- **CARDS FAILING QUIET PRD**—Cards failing quiet time requirement
- **CARDS WITH DDB UPD IN PRG**—Cards sending replies marked as "DDB update in progress" due to DDB checksum not evaluated completely or TSRC task is incomplete
- **CARDS CONSIDERED FOR CKSM**—Cards sending correct replies. Replies are not marked with "DDB update in progress" or "Reply with no data".
- **INCONSISTENT CARDS**—Cards that are inconsistent
- **CONSISTENT CARDS**—Cards that are consistent
- **AUDIT START TIME**—Time that the audit started (*DD/MM/YYYYY hh:ms:ss* format)
- **QUIET PERIOD**—Minimum DDB idle time, in milliseconds, during which no DDB updates are applied
- **RTE**—Checksum of RTE Table
- **LINK SET**—Checksum of Link Set Table
- **LINK**—Checksum of Link Table
- **CM CARD**—Checksum of CM Card
- **CM CLSTR**—Checksum of CM Cluster



- **MATED APPL**—Checksum of Mated Application
- **MTP GLOBL**S—Checksum of MTP Globals Table
- **IDLE (PERIOD)**—Time elapsed, in milliseconds, since the last DDB update was received by this card
- **DDB UPD**—Total DDB updates received on the card
- **ADDN'L STATUS**—Display more information for the card, including WWA updates or whether card is considered for audit calculations
- **CAUSE**—Display the reason for sending replies of type "reply with no data " or "DDB update in progress". This value can be DDL (crossload not completed), DDB (dynamic database is not initialised) , (TSRC, DDB) (TSRC task is not completed) or DDB (checksums still needs to apply on tables).
- **?**—Card status is not evaluated (inconsistent/consistent) if the system status is marked as "ABORTED"
- **IGNORED**—Card responded with "DDB update in progress" and is not considered for calculating system status
- **WWA UPD**—Number of entries that were updated by the WWA

## rept-stat-dlk

## Report Status Data Link

Use this command to show the status of the TCP/IP data links. The secondary state (SST) of the TCP/IP data links shows whether the link is available, unavailable, or manually removed from service.

**Keyword:** `rept-stat-dlk`

**Related Commands:** `act-dlk`, `canc-dlk`, `dlt-dlk`, `ent-dlk`, `rtrv-dlk`, `tst-dlk`

**Command Class:** System Maintenance

### Parameters

**:loc=** (optional)

The card location as stenciled on the shelf of the system.

**Range:** 1101-1108, 1111-1112, 1201-1208, 1211-1218, 1301-1308, 1311-1318, 2101-2108, 2111-2118, 2201-2208, 2211-2218, 2301-2308, 2311-2318, 3101-3108, 3111-3118, 3201-3208, 3211-3218, 3301-3308, 3311-3318, 4101-4108, 4111-4118, 4201-4208, 4211-4218, 4301-4308, 4311-4318, 5101-5108, 5111-5118, 5201-5208, 5211-5218, 5301-5308, 5311-5318, 6101-6108, 6111-6118

**Default:** All data links are shown.

### Example

```
rept-stat-dlk
```

```
rept-stat-dlk:loc=1104
```

### Dependencies

No other **rept-stat-xxx** command can be in progress when this command is entered.

The ACM is the only valid card type for this command.

The shelf and card must be equipped.

The specified card must have a TCP/IP data link assigned to it.

Only one data link port on the ACM is supported. Reports are generated only on port A of the card.

The card location, frame, shelf, or slot must be within the allowed range.

The data link must be equipped in the database.

A card location that is valid and defined in the database must be specified.

### Notes

None

### Output

#### rept-stat-dlk

```
rlghncxa03w 04-02-27 17:00:36 EST EAGLE 31.3.0
DLK          PST          SST          AST
1104         IS-NR        Avail       ----
1206         IS-NR        Avail       ALMINH
Command Completed.
```

;

#### rept-stat-dlk:loc=1104

```
rlghncxa03w 04-02-27 17:00:36 EST EAGLE 31.3.0
DLK          PST          SST          AST
1104         IS-NR        Avail       ----
ALARM STATUS = No Alarms.
Command Completed.
```

;

### Legend

**DLK**—The card location of the TCP/IP data link

**PST**—The primary state of the TCP/IP data link. The possible values are described in "Possible Values for PST/SST/AST".

**SST**—The secondary state of the TCP/IP data link. The possible values are described in "Possible Values for PST/SST/AST".

**AST**—The associated state of the TCP/IP data link. The possible values are described in .

## rept-stat-dstn

## Report Status Destination

Use this command to generate a report of the MTP point code status for provisioned point codes. Any provisioned destination can be specified, including a cluster destination (*ni-nc-\**) or a network destination (*ni-\*-\**).

**Keyword:** `rept-stat-dstn`

**Related Commands:** `chg-dstn`, `dlt-dstn`, `dlt-rte`, `ent-dstn`, `ent-rte`, `rept-stat-rte`, `rtrv-dstn`, `rtrv-rte`

**Command Class:** System Maintenance

### Parameters

**NOTE:** See "Point Code Formats and Conversion" for a detailed description of point code formats, rules for specification, and examples.

**:dpc=** (optional)

ANSI point code with subfields *network indicator-network cluster-network cluster member* (*ni-nc-ncm*). The *prefix* subfield indicates a private point code (*prefix-ni-nc-ncm*).

**Synonym:** `dpca`

**Range:** `p-, 000-255, *, **, ***`

Specify a valid value for each subfield of the point code, and separate the subfields with a dash (-).

*prefix*—**p-**

The asterisk values \*, \*\*, and \*\*\* are not valid for the *ni* subfield.

If \*\* or \*\*\* is specified for the *nc* subfield, either \*, \*\*, or \*\*\* must be specified for the *ncm* subfield.

When **chg-sid:pctype=ansi** is specified, *ni* = **000** is not valid.

When **chg-sid:pctype=ansi** is specified, *nc* = **000** is not valid if *ni* = **001-005**.

When **chg-sid:pctype=ansi** is specified, *nc* = **000** is valid if *ni* = **006-255**.

When **chg-sid:pctype=ansi** is specified, *ni*-\*-\* is valid if *ni* = **006-255**.

The point code **000-000-000** is not a valid point code.

**:dpc/dpca/dpci/dpcn/dpcn24=** (optional)

Destination point code.

**:dpci=** (optional)

ITU international point code with subfields *zone-area-id*. The *prefix* subfield indicates a spare point code, private point code, or private and spare point code (*prefix-zone-area-id*).

**Range:** **s-, p-, ps-, 0-255**

Specify a valid value for each subfield of the point code, and separate the subfields with a dash (-).

*prefix*—**s-, p-, ps-**

*zone*—**0-7**

*area*—**000-255**

*id*—**0-7**

The point code **0-000-0** is not a valid point code.

**:dpcn=** (optional)

ITU national point code in the format of a 5-digit number (*nnnnn*); or 2, 3, or 4 numbers (members) separated by dashes (*m1-m2-m3-m4*) as defined by the **chg-stpopts:npcfmti** flexible point code option. A group code must be specified when the ITUDUPPC feature is turned on (*nnnnn-gc*, *m1-m2-m3-m4-gc*). The *prefix* subfield indicates a spare point code, private point code, or private and spare point code (*prefix-nnnnn*, *prefix-nnnnn-gc*, *prefix-m1-m2-m3-m4*, *prefix-m1-m2-m3-m4-gc*).

**Range:** **s-, p-, ps-, 0-16383, aa-zz**

Specify a valid value for each subfield of the point code, and separate the subfields with a dash (-).

*prefix*—**s-, p-, ps-**

*nnnnn*—**0-16383**

*gc*—**aa-zz**

*m1-m2-m3-m4*—**0-14** for each member; values must sum to 14

**:dpcn24=** (optional)

24-bit ITU national destination point code with subfields *main signaling area-sub signaling area-signaling point* (*msa-ssa-sp*). The *prefix* subfield indicates a private point code (*prefix-msa-ssa-sp*).

**Range:** **p-, 000-255**

Specify a valid value for each subfield of the point code, and separate the subfields with a dash (-).

*prefix*—**p-**

*msa*—**000-255**

*ssa*—**000-255**

*sp*—**000-255**

**:mode=** (optional)

The type of display to produce. This parameter displays the point code's subsystem status along with the normal output.

**Range:** **full, rtx**

**full**— Comprehensive display of point code status, including **rtx**. If entered with a point code, status for that point code is displayed. If specified without a point code, the status of all routesets is displayed.

**rtx**— Displays exception route status, other than circular routing, if the Origin-based MTP Routing feature is on.

**Default:** A summary report is displayed.

**:stat=** (optional)

The primary state filter. This parameter lets you choose the state of the destination for which you want a report. In other words, if you want a report for all destinations whose state is DSBLD, specify **:stat=dsbld**.

**Range:** **all, alminh, anr, dsbld, mt, nr**

**all**— All of the primary states

**alminh**— Alarms inhibited

**anr**— In service abnormal (IS-ANR)

**dsbld**— Out of service maintenance disabled (OOS-MT-DSBLD)

**mt**— Out of service maintenance (OOS-MT)

**nr**— In service normal (IS-NR)

**Default:** **all**

**Example**

```
rept-stat-dstn
rept-stat-dstn:dpci=2-004-1:mode=full
rept-stat-dstn:dpc=9-3-6:mode=full
rept-stat-dstn:dpc=9-3-*:mode=full
rept-stat-dstn:dpc=9-3-*
rept-stat-dstn:dpc=9-3-**
rept-stat-dstn:dpc=9-3-***
rept-stat-dstn:dpc=9-3-***:stat=mt
rept-stat-dstn:dpc:9-4-***:stat=alminh
rept-stat-dstn:dpc=9-3-*:mode=rtx
rept-stat-dstn:mode=full
rept-stat-dstn:mode=rtx
rept-stat-dstn:dpc=1-1-1
```

**Dependencies**

No other **rept-stat-xxx** command can be in progress when this command is entered.

If a **dpc** parameter is specified, it must be the true destination point code (not an alias) and it must be defined in the database.

The **stat** parameter can be specified with the **dpc** parameter only if the **dpc** parameter specifies one of the *ni-nc-\** formats.

An x-list DPC cannot be specified in the **dpc** parameter.

The **mode=rtx** parameter cannot be specified unless the Origin-Based MTP Routing feature is enabled and on.

The **mode** parameter cannot be specified with the **dpc** parameter if the **dpc** parameter specifies one of the **ni-nc-\*** formats.

When the **mode=full** parameter is specified then the **dpc/dpca/dpcn/dpci/dpcn24** parameter must be specified.

The **pst** and **mode** parameters cannot be specified together in the command.

The destination address must be a full point code, a network destination, or a cluster point code.

**Notes**

This command can be canceled using the **F9** function key or the **canc-cmd** command. See **canc-cmd** for more information.

This command does not report the x-list point codes. Use the **rept-stat-cluster** command for a report of x-list point codes.

If the **mode=rtx** parameter is specified with a specific DPC, additional linkset, route and exception route information associated with the specified DPC is displayed.

In this command, only ITU-international and ITU national point codes support the spare point code subtype prefix (**s-**) and the private and spare point code subtype prefix (**ps-**). All of the point code types support the private (internal) point code subtype prefix (**p-**).

Table 5-78 provides a summary description of the reports that are produced by the various DPC parameter syntaxes.

**Table 5-76.** Summary of DPC Parameter Syntaxes

| DPC format                           | Meaning                                                                                                                                                                                                                              |
|--------------------------------------|--------------------------------------------------------------------------------------------------------------------------------------------------------------------------------------------------------------------------------------|
| <b>rept-stat-dstn:dpc=ni-nc-ncm</b>  | Requests a report for fully provisioned destination <i>ni-nc-ncm</i> .                                                                                                                                                               |
| <b>rept-stat-dstn:dpc= ni-**-*</b>   | Requests a report for provisioned network destination with the specified network indicator. Note that if * is specified in the <i>nc</i> field, * must be specified in the <i>ncm</i> field.                                         |
| <b>rept-stat-dstn:dpc= ni-***-*</b>  | Requests a report for the full network cluster for the specified <i>ni</i> .                                                                                                                                                         |
| <b>rept-stat-dstn:dpc= ni-***-*</b>  | Requests a report for the full network cluster and the network cluster address (if any) for the specified <i>ni</i> .                                                                                                                |
| <b>rept-stat-dstn:dpc= ni-nc-*</b>   | Requests a report for provisioned cluster destination <i>ni-nc-*</i> .                                                                                                                                                               |
| <b>rept-stat-dstn:dpc= ni-nc-**</b>  | Requests a report showing all destinations whose network ( <i>ni</i> ) and cluster ( <i>nc</i> ) components match those specified. Note, however, that the network cluster address on <i>ni-nc-*</i> (if it exists) is not reported. |
| <b>rept-stat-dstn:dpc= ni-nc-***</b> | Requests a report showing all destinations whose network ( <i>ni</i> ) and cluster ( <i>nc</i> ) components match those                                                                                                              |

Table 5-76. Summary of DPC Parameter Syntaxes

| DPC format                              | Meaning                                                                                                                    |
|-----------------------------------------|----------------------------------------------------------------------------------------------------------------------------|
|                                         | specified. The network cluster address <i>ni-nc-*</i> (if it exists) is also reported.                                     |
| <b>rept-stat-dstn:dpcn24=msa-ssa-sp</b> | Requests a report for fully provisioned 24-bit destination <i>main signaling area-sub signaling area-signaling point</i> . |

If the **mode=rtx** parameter is specified without a specific DPC, then status is provided for all exception route sets.

If the **mode=full** parameter is specified with a specific destination point code, then additional linkset, route, and exception route information associated with the specified destination is displayed, along with information that can be used to correct circular routing. If the **mode=full** parameter is specified without a specific destination point code, then status is provided for all regular and exception route sets.

**Output**

If the **dpc** parameter is not specified:

- If the **mode** parameter is not specified, then the command output lists the status of all provisioned destination point codes (DPCs) (routesets) in the system.
- If the **mode=rtx** parameter is specified, then the output lists the status of only those DPCs against which exception routes have been provisioned, and the status of the provisioned exception route sets associated with each DPCs.
- If the **mode=full** parameter is specified, then the command lists the status of all provisioned DPCs in the system, and the status of the provisioned exception route sets, if any, associated with each DPC.

If the **dpc** parameter is specified:

- If the **mode** parameter is not specified, then the output lists the status of all provisioned routes in the route set specified by that DPC.
- If the **mode=rtx** parameter is specified, then the output lists the status of all provisioned routes in the routeset specified by that DPC, and the status of all provisioned exception routesets associated with that DPC.
- If the **mode=full** parameter is specified, then the output lists the status of all provisioned routes in the routeset specified by that DPC, the status of all provisioned exception route sets associated with that DPC, any aliases associated with that DPC, and circular routing alarm information if any for that DPC.

The following example shows how, when no parameters are specified, summary information for all provisioned cluster and noncluster DPCs is reported.

**rept-stat-dstn**

```
tekelecstp 09-05-15 10:31:06 EST EAGLE 41.0.0
  DPCA          PST          SST          AST
  009-000-000   IS-ANR         Allowed      ACCESS
  009-003-*     IS-ANR         Allowed      ACCESS
  009-003-006   OOS-MT         Prohibit     INACCESS
  009-003-001   IS-NR          Allowed      ACCESS
  009-003-002   IS-NR          Allowed      ACCESS
  009-003-003   OOS-MT         Prohibit     INACCESS
  009-004-006   IS-NR          Allowed      ALMINH
  004-002-002   IS-NR          Allowed      ACCESS
  006-000-000   IS-ANR         Allowed      ACCESS
  101-033-*     IS-NR          Allowed      ACCESS

  DPCN          PST          SST          AST
  02097         IS-ANR         Allowed      ACCESS
  02098         OOS-MT         Prohibit     INACCESS
  02099         OOS-MT         Prohibit     INACCESS

  DPCN24        PST          SST          AST

  DPCI          PST          SST          AST
  2-004-1       IS-NR          Allowed      ACCESS
  2-004-3       IS-ANR         Allowed      ACCESS
  2-004-2       IS-ANR         Allowed      ACCESS
  2-004-4       IS-NR          Allowed      ACCESS
```

Command Completed.

;

The following example shows that specifying a cluster destination on the **dpc** parameter shows the cluster status and routeset information. Information on cluster members is not shown. Use **rept-stat-cluster** to obtain this information.

**rept-stat-dstn:dpc=9-3-\***

```
tekelecstp 09-03-21 10:31:06 EST EAGLE 41.0.0
  DPCA          PST          SST          AST
  009-003-*    IS-NR        Allowed   ACCESS
ALARM STATUS   = No Alarms.
RTE COST  LSN      APCA          LS STAT   NON-ADJ   ROUTE STAT
1*  10  lsnstpa    042-036-123 Allowed   Allowed   Allowed
2   20  lsnstpb    092-240-103 Allowed   Allowed   Allowed
3   30  lsnstpc    128-101-022 Allowed   Allowed   Allowed
4   --  -----   ***-***-*** -----   -----   -----
5   --  -----   ***-***-*** -----   -----   -----
6   --  -----   ***-***-*** -----   -----   -----
```

Command Completed.

;

The following example shows how specifying either an FPC or cluster destination for which circular routing has been detected, along with the **mode=full** parameter, displays the name of the linkset on which the circular routing test message was transmitted. It also displays the linkset on which the circularly routed message was received.

**rept-stat-dstn:dpc=9-3-6:mode=full**

```
tekelecstp 08-03-21 10:31:06 EST EAGLE 41.0.0
  DPCA          PST          SST          AST
  009-003-006   OOS-MT        Prohibit  INACCESS
ALARM STATUS   = *C  xxxx Circular routing detected
RTE COST  LSN      APCA          LS STAT   NON-ADJ   ROUTE STAT
1*  10  lsnstpa    042-036-123 Allowed   Allowed   Allowed
2   20  lsnstpb    092-240-103 Allowed   Allowed   Allowed
3   30  lsnstpc    128-101-022 Allowed   Allowed   Allowed
4   --  -----   ***-***-*** -----   -----   -----
5   --  -----   ***-***-*** -----   -----   -----
6   --  -----   ***-***-*** -----   -----   -----
```

SSN SUBSYSTEM STATUS

```
ALIASA          ALIASN          ALIASI
-----          -----          -----
```

CIRCULAR ROUTING INFO:

```
XMIT LSN= lsnstpb  RC=--
RCV LSN= lsn01a
MEMBER= ***-***-***
```

Exception Routes:

Command Completed.

;

The following example shows a typical report when a cluster destination and the **mode=full** parameter is specified. The interpretation of the circular routing status for cluster destinations is slightly different from an FPC's.

**rept-stat-dstn:dpc=9-3-\*:mode=full**

```
tekelecstp 09-03-15 10:31:06 EST EAGLE 41.0.0
  DPCA          PST          SST          AST
  009-003-*    IS-NR        Allowed   ACCESS
ALARM STATUS   = *C  xxxx Circular routing detected
RTE COST  LSN      APCA          LS STAT   NON-ADJ   ROUTE STAT
```



```

1* 10 lsnstpa 042-036-123 Allowed Allowed Allowed
2 20 lsnstpb 092-240-103 Allowed Allowed Allowed
3 30 lsnstpc 128-101-022 Allowed Allowed Allowed
4 -- ----- ***-***-*** -----
5 -- ----- ***-***-*** -----
6 -- ----- ***-***-*** -----

```

SSN SUBSYSTEM STATUS

```

ALIASA ALIASN ALIASI
-----

```

CIRCULAR ROUTING INFO:  
XMIT LSN=lsnstpb RC=20  
RCV LSN=lsn01a  
MEMBER= 009-003-006

Exception Routes:

Command Completed.

;

The following example shows the circular routing alarm for a cluster destination. A circular routing alarm for a cluster destination indicates that circular routing was detected for a member of the cluster, but no x-list entry could be created for that cluster. Circular routing detected on a cluster destination does not automatically force the output to display the status of the cluster as “OOS-MT Prohibit INACCESS” as it does for an FPC destination.

**rept-stat-dstn:dpc=9-3-\***

```

stdcfg1a 09-03-16 14:09:24 EST EAGLE 41.0.0
DPCA PST SST AST
009-003-* IS-NR Allowed ACCESS
ALARM STATUS = *C xxxx Circular routing detected
RTE COST LSN APCA LS STAT NON-ADJ ROUTE STAT
1* 10 lsnstpa 042-036-123 Allowed Allowed Allowed
2 20 lsnstpb 092-240-103 Allowed Allowed Allowed
3 30 lsnstpc 128-101-022 Allowed Allowed Allowed
4 -- ----- ***-***-*** -----
5 -- ----- ***-***-*** -----
6 -- ----- ***-***-*** -----

```

Command Completed.

;

The following example shows how **rept-stat-dstn** displays a subsystem information header but no subsystem information, just as it would if an FPC is specified for which no subsystems are defined. In addition, because aliases cannot be defined for cluster destinations, this report shows only an empty header, just as it does when an FPC is specified for which no aliases are defined. Note that the circular routing information portion of the **mode=full** report displays “-----” for the linkset names when no circular routing condition exists for the DPC.

**rept-stat-dstn:dpc=9-3-\*:mode=full**

```

stdcfg1a 08-02-16 14:09:24 EST EAGLE 38.0.0
Command entered at terminal #4.
DPCA PST SST AST
009-003-* IS-NR Allowed ACCESS
ALARM STATUS = No Alarms.
RTE COST LSN APCA LS STAT NON-ADJ ROUTE STAT
1* 10 lsnstpa 042-036-123 Allowed Allowed Allowed
2 20 lsnstpb 092-240-103 Allowed Allowed Allowed
3 30 lsnstpc 128-101-022 Allowed Allowed Allowed
4 -- ----- ***-***-*** -----

```

```

5  --  -----  ---***---***  -----  -----  -----
6  --  -----  ---***---***  -----  -----  -----

```

SSN SUBSYSTEM STATUS

```

ALIASA          ALIASN          ALIASI
-----          -----          -----

```

```

CIRCULAR ROUTING INFO:
XMIT LSN= ----- RC=--
RCV LSN= -----
MEMBER= ***---***

```

Exception Routes:

Command Completed.

;

The following example shows how specifying the **stat** parameter along with the **ni-nc-\*** or **ni-nc-\*\*\*** DPC formats causes the output summary report to include only those destinations whose status matches the state specified.

**rept-stat-dstn:dpc=9-4-\*\*\*:stat=alminh**

```

stdcfgla 09-05-16 14:09:24 EST EAGLE 41.0.0
DPCA          PST          SST          AST
009-004-006   IS-NR          Allowed   ALMINH

```

Command Completed.

;

The following example shows a retrieval specifying an ITU national point code where the **chg-stpopts:npcfmti** parameter has been set to **1-1-1-11**:

**rept-stat-dstn:dpcn=1-1-1-1000**

```

stdcfgla 09-03-16 14:09:24 EST EAGLE 41.0.0
CAUTION : Node isolated...route status out of date!
DPCN          PST          SST          AST
1-1-1-1000    OOS-MT          Prohibit  INACCESS
ALARM STATUS   = *C 0313 DPC is prohibited
RTE COST  LSN          APCA          LS STAT  NON-ADJ  ROUTE STAT
1  10  lsitu          1-1-1-1000    Prohibit  Allowed   Prohibit
2  --  -----  ---***---***  -----  -----  -----
3  --  -----  ---***---***  -----  -----  -----
4  --  -----  ---***---***  -----  -----  -----
5  --  -----  ---***---***  -----  -----  -----
6  --  -----  ---***---***  -----  -----  -----

```

Command Completed.

;

The asterisks in the space after the route numbers in the following examples indicate which route (or combined route) is carrying traffic.

**rept-stat-dstn:dpc=1-1-1**

```

tekelecstp 09-03-24 09:19:04 EST EAGLE 41.0.0
DPCA          PST          SST          AST
001-001-001   IS-NR          Allowed   ACCESS
ALARM STATUS   = No Alarms.
RTE COST  LSN          APCA          LS STAT  NON-ADJ  ROUTE STAT
1* 05  lse1e1          001-001-001   Allowed   Allowed   Allowed
2* 05  lse1e2          001-002-001   Allowed   Allowed   Allowed
3  10  lse1e3          001-003-001   Allowed   Allowed   Allowed
4  --  -----  ---***---***  -----  -----  -----
5  --  -----  ---***---***  -----  -----  -----
6  --  -----  ---***---***  -----  -----  -----

```

Command Completed.

No asterisk appears after the route number in the following example; no routes were carrying traffic at the time.

**rept-stat-dstn:dpc=1-1-1**

```
stdcfgl 09-03-16 14:09:24 EST EAGLE 41.0.0
DPCA          PST          SST          AST
001-001-001   OOS-MT          Prohibit    INACCESS
ALARM STATUS   = *C 0313 DPC is prohibited
RTE COST  LSN          APCA          LS STAT  NON-ADJ  ROUTE STAT
1   05   lse1e1         001-001-001   Prohibit  Allowed  Prohibit
2   05   lse1e2         001-002-001   Prohibit  Allowed  Prohibit
3   10   lse1e3         001-003-001   Prohibit  Allowed  Prohibit
4   --   -----         ***-***-***   -----
5   --   -----         ***-***-***   -----
6   --   -----         ***-***-***   -----
```

Command Completed.

The following example shows a retrieval when the Origin-Based MTP Routing feature is on, a specific DSTN is requested, and the **rtx** mode is used. This combination causes the standard route information along with the provisioned exception routes for the specified DPC to be displayed.

**rept-stat-dstn:dpc=9-3-\*:mode=rtx**

```
tekelecstp 09-05-01 16:21:39 EST EAGLE 41.0.0
DPCA          PST          SST          AST
009-003-*     IS-NR          Allowed     ACCESS
ALARM STATUS   = No Alarms.
RTE COST  LSN          APCA          LS STAT  NON ADJ  ROUTE STAT
1*  10   lsnstpa         042-36-23   Allowed  Allowed  Allowed
2   20   lsnstpb         092-40-03   Allowed  Allowed  Allowed
3   30   lsnstpc         128-01-22   Prohibit  Prohibit  Allowed
4   --   -----         ***-***-***   -----
5   --   -----         ***-***-***   -----
6   --   -----         ***-***-***   -----
```

Exception Routes:

```
OPCA          PST          SST          AST
001-001-001   IS-NR          Allowed     ACCESS

ILSN          PST          SST          AST
lsnstpy       IS-NR          Allowed     ACCESS
```

Command Completed.

The following example shows a retrieval when the Origin-Based MTP Routing feature is turned on, a specific DSTN is requested, and the **full** mode is used. This combination causes all information, including provisioned exception routes, for the specified DPC to be displayed.

**rept-stat-dstn:dpc=9-3-\*:mode=full**

```
stdcfgl 09-05-16 14:09:24 EST EAGLE 41.0.0
DPCA          PST          SST          AST
009-003-006   OOS-MT          Prohibit    INACCESS
ALARM STATUS   = *C 0319 REPT-MTPLP-DET: Circ rte det(cong)
RTE COST  LSN          APCA          LS STAT  NON-ADJ  ROUTE STAT
1*  10   lsnstpa         042-036-123   Allowed  Allowed  Allowed
2   20   lsnstpb         092-240-103   Allowed  Allowed  Allowed
3   30   lsnstpc         128-101-022   Allowed  Allowed  Allowed
4   --   -----         ***-***-***   -----
5   --   -----         ***-***-***   -----
```

```

6  --  -----  ***-***-***  -----  -----
SSN  SUBSYSTEM STATUS

  ALIASA          ALIASN          ALIASI
-----  -----  -----

CIRCULAR ROUTING INFO:
XMIT LSN=lsnstpb  RC=20
RCV  LSN=lsn01a
MEMBER =-----

Exception Routes:

      OPCA          PST          SST          AST
      001-001-001  IS-NR          Allowed  ACCESS

      ILSN          PST          SST          AST
      lsnstpy      IS-NR          Allowed  ACCESS

```

Command Completed.

The following example shows a retrieval when the Origin-Based MTP Routing feature is on, and the **full** mode is specified. This combination causes all routes to be displayed along with their provisioned exception routes.

**rept-stat-dstn:mode=full**

```

tekelecstp 09-05-21 10:26:56 EST  EAGLE 41.0.0
  DPCA          PST          SST          AST
  001-001-000  OOS-MT          Idle          INACCESS
  003-001-000  OOS-MT          Idle          INACCESS
  002-102-001  OOS-MT          Idle          INACCESS
  001-101-001  OOS-MT          Idle          INACCESS

      OPCA          PST          SST          AST
      001-001-001  OOS-MT          Idle          INACCESS
      002-001-000  OOS-MT          Idle          INACCESS

      ILSN          PST          SST          AST
      e2mls1      OOS-MT          Idle          INACCESS

      CIC  ECIC          PST          SST          AST
      0    1000          OOS-MT          Idle          INACCESS

      SI          PST          SST          AST
      3          OOS-MT          Idle          INACCESS

  003-101-001  OOS-MT          Idle          INACCESS
  004-101-001  OOS-MT          Idle          INACCESS
  007-101-001  OOS-MT          Idle          INACCESS
  100-100-*    OOS-MT          Idle          INACCESS
  100-100-001  OOS-MT          Idle          INACCESS

      OPCA          PST          SST          AST
      001-001-001  OOS-MT          Idle          INACCESS
      002-002-002  OOS-MT          Idle          INACCESS
      001-102-001  OOS-MT          Idle          INACCESS
      200-200-001  OOS-MT          Idle          INACCESS

  DPCN          PST          SST          AST
  1-010-1      OOS-MT          Idle          INACCESS
  1-020-2      OOS-MT          Idle          INACCESS
  1-020-3      OOS-MT          Idle          INACCESS
  1-020-4      OOS-MT          Idle          INACCESS
  1-050-1      OOS-MT          Idle          INACCESS

```

```

          OPCA                PST          SST          AST
          002-001-000         OOS-MT       Idle         INACCESS
          002-101-001         OOS-MT       Idle         INACCESS

DPCN24          PST          SST          AST

DPCI           PST          SST          AST
1-030-1        OOS-MT       Idle         INACCESS
1-030-2        OOS-MT       Idle         INACCESS
1-040-4        OOS-MT       Idle         INACCESS
1-070-1        OOS-MT       Idle         INACCESS

          OPCN                PST          SST          AST
          1-050-1             OOS-MT       Idle         INACCESS

          ILSN                PST          SST          AST
          npc1                OOS-MT       Idle         INACCESS
    
```

Command Completed.

;

The following example displays a retrieval when the Origin-Based MTP Routing feature is turned on and the **rtx** mode is used. This combination causes all destinations with provisioned exception routes to be displayed. Both the standard route and the exception route information will be shown.

**rept-stat-dstn:mode=rtx**

```

stdcfg1a 09-05-16 14:09:24 EST  EAGLE 41.0.0
DPCA           PST          SST          AST
001-101-001    OOS-MT       Idle         INACCESS

          OPCA                PST          SST          AST
          001-001-001         OOS-MT       Idle         INACCESS
          002-001-000         OOS-MT       Idle         INACCESS

          ILSN                PST          SST          AST
          e2m1s1             OOS-MT       Idle         INACCESS

DPCN           PST          SST          AST
1-050-1        OOS-MT       Idle         INACCESS

          OPCA                PST          SST          AST
          002-001-000         OOS-MT       Idle         INACCESS
          002-101-001         OOS-MT       Idle         INACCESS

DPCN24         PST          SST          AST

DPCI           PST          SST          AST
1-070-1        OOS-MT       Idle         INACCESS

          OPCN                PST          SST          AST
          1-050-1             OOS-MT       Idle         INACCESS

          ILSN                PST          SST          AST
          npc1                OOS-MT       Idle         INACCESS
    
```

Command Completed.

;

The following example displays output when the mode=full parameter is specified, and the Origin-Based MTP routing feature is not turned on.

**rept-stat-dstn:mode=full**

```

tekelecstp 09-05-21 10:26:56 EST  EAGLE 41.0.0
Command entered at terminal #4.
    
```

|             |        |      |          |
|-------------|--------|------|----------|
| DPCA        | PST    | SST  | AST      |
| 001-001-001 | OOS-MT | Idle | INACCESS |
| 002-002-002 | OOS-MT | Idle | INACCESS |
| 003-003-003 | OOS-MT | Idle | INACCESS |
| 004-004-004 | OOS-MT | Idle | INACCESS |
| 005-005-005 | OOS-MT | Idle | INACCESS |
| SI          | PST    | SST  | AST      |
| 3           | OOS-MT | Idle | INACCESS |
| 006-006-006 | OOS-MT | Idle | INACCESS |
| 007-007-007 | OOS-MT | Idle | INACCESS |
| 009-009-*   | OOS-MT | Idle | INACCESS |
| 008-008-*   | OOS-MT | Idle | INACCESS |
| DPCN        | PST    | SST  | AST      |
| 00101       | OOS-MT | Idle | INACCESS |
| 00102       | OOS-MT | Idle | INACCESS |
| 00103       | OOS-MT | Idle | INACCESS |
| 00104       | OOS-MT | Idle | INACCESS |
| 00105       | OOS-MT | Idle | INACCESS |
| 00106       | OOS-MT | Idle | INACCESS |
| 00107       | OOS-MT | Idle | INACCESS |
| DPCN24      | PST    | SST  | AST      |
| DPCI        | PST    | SST  | AST      |
| 2-100-1     | OOS-MT | Idle | INACCESS |
| 2-100-2     | OOS-MT | Idle | INACCESS |
| 2-100-3     | OOS-MT | Idle | INACCESS |
| 2-100-4     | OOS-MT | Idle | INACCESS |
| 2-100-5     | OOS-MT | Idle | INACCESS |
| 2-100-6     | OOS-MT | Idle | INACCESS |
| 2-100-7     | OOS-MT | Idle | INACCESS |
| 1-001-1     | OOS-MT | Idle | INACCESS |
| 1-001-2     | OOS-MT | Idle | INACCESS |

Command Completed.

;

The following example displays output when the **mode=rtx** parameter is specified, and the Origin-Based MTP Routing feature is not turned on.

**rept-stat-dstn:mode=rtx**

stdcfgla 09-05-16 14:09:24 EST EAGLE 41.0.0

|             |        |      |          |
|-------------|--------|------|----------|
| DPCA        | PST    | SST  | AST      |
| 005-005-005 | OOS-MT | Idle | INACCESS |
| SI          | PST    | SST  | AST      |
| 3           | OOS-MT | Idle | INACCESS |

Command Completed.

;

**Legend**

**DPC/DPCA**—The ANSI destination point code of the route

**DPCN**—The ITU-TSS national destination point code of the route

**DPCN24**—The 24-bit ITU national destination point code of the route

**DPCI**—The ITU-TSS international destination point code of the route

**OPC/OPCA**—The ANSI origination point code as exception routing criterion of the exception route

**OPCN**—The ITU-TSS national origination point code as exception routing criterion of the exception route

**OPCN24**—The 24-bit ITU national origination point code as exception routing criterion of the exception route

**OPCI**—The ITU-TSS international origination point code as exception routing criterion of the exception route

**ILSN**—The originating linkset as exception routing criterion of the exception route

**CIC**—Starting Circuit Identification Code used as the exception routing criterion for this exception route

**ECIC**—Ending Circuit Identification Code together with CIC defines the CIC range that is used as exception routing criterion for this exception route.

**PST**—The primary state of the subsystem. The possible values are described in "Possible Values for PST/SST/AST".

**SST**—The secondary state of the subsystem. The possible values are described in "Possible Values for PST/SST/AST".

**AST**—The associated state of the subsystem. The possible values are described in .

## rept-stat-e1

## Report Status E1

Use this command to display the E1 port status and signaling link status for cards with provisioned E1 ports.

**Keyword:** `rept-stat-e1`

**Related Commands:**

**Command Class:** System Maintenance

### Parameters

**:e1port=** (optional)

The E1 port number. When this parameter is specified, only the information for the spspecified E1 port on the card in the specified card location is displayed.

**Range:** 1-8

Ports 3 through 8 can be specified only for HC-MIM cards.

**:loc=** (optional)

Card location. The unique identifier of a specific **lime1** card located in the STP.

**Range:** 1101-1108, 1111-1112, 1201-1208, 1211-1218, 1301-1308, 1311-1318, 2101-2108, 2111-2118, 2201-2208, 2211-2218, 2301-2308, 2311-2318, 3101-3108, 3111-3118, 3201-3208, 3211-3218, 3301-3308, 3311-3318, 4101-4108, 4111-4118, 4201-4208, 4211-4218, 4301-4308, 4311-4318, 5101-5108, 5111-5118, 5201-5208, 5211-5218, 5301-5308, 5311-5318, 6101-6108, 6111-6118

**Default:** Information for all **lime1** cards is reported.

### Example

```
rept-stat-e1
```

### Dependencies

No other **rept-stat-xxx** command can be in progress when this command is entered.

The **loc** parameter must be specified when the **e1port** parameter is specified.

The active TDM location cannot be specified in the **loc** parameter.

Card locations 1117 and 1118 and the HMUX or HIPR card locations (xy09 and xy10 where *x* is the frame and *y* is the shelf) cannot be specified in the **loc** parameter.

### Notes

Specifying the command without any parameters displays E1 port status for all cards with provisioned E1 ports.

If the **loc** parameter is specified, status is displayed for all E1 ports provisioned on the card in the specified location.

If the **loc** and **e1port** parameters are specified, the E1 port status summary is displayed for all E1 ports provisioned on the card in the specified location, followed by the status of all signaling links assigned to the specified E1 port on the card.



**Output**

When no parameters are specified in the command, E1 port status is displayed for all cards with provisioned E1 ports. Ports 3 through 8 are on HC-MIM cards only.

**rept-stat-e1**

```
rlghncxa03w 05-01-04 07:01:08 EST EAGLE5 33.0.0
LOC  E1PORT  PST      SST      AST
1203 1      IS-NR    Avail    PARENT
1203 2      IS-NR    Avail    PAIRED
1203 3      IS-NR    Avail    -----
1203 7      OOS-MT   Unavail  -----
1207 1      IS-NR    Avail    -----
1207 2      IS-NR    Avail    -----
Command Completed.
```

;

When the **loc** parameter is specified, status is displayed for all E1 ports provisioned on the card in the specified location.

**rept-stat-e1:loc=1203**

```
rlghncxa03w 05-01-04 07:01:08 EST EAGLE5 33.0.0
LOC  E1PORT  PST      SST      AST
1203 1      IS-NR    Avail    PARENT
1203 2      IS-NR    Avail    PAIRED
1203 3      IS-NR    Avail    -----
1203 7      OOS-MT   Unavail  -----
Command Completed.
```

;

When the **loc** and **e1port** parameters are specified, the E1 port status summary is displayed for all E1 ports provisioned on the card in the specified location, followed by the status of all signaling links assigned to the specified E1 port on the card.

**rept-stat-e1:loc=1203:e1port=1**

```
rlghncxa03w 05-01-04 07:01:08 EST EAGLE5 33.0.0
LOC  E1PORT  PST      SST      AST
1203 1      IS-NR    Avail    PARENT
ALARM STATUS      = No Alarms.
UNAVAIL REASON    = --
SLK  TS  PST      SST      AST
A    1  IS-NR    Avail    ---
A1   2  IS-NR    Avail    ---
Command Completed.
```

;

**rept-stat-e1:loc=1203:e1port=2**

```
rlghncxa03w 05-01-04 07:01:08 EST EAGLE5 33.0.0
LOC  E1PORT  PST      SST      AST
1203 2      IS-NR    Avail    PAIRED
ALARM STATUS      = No Alarms.
UNAVAIL REASON    = --
Command Completed.
```

;

**Legend**

**LOC**—Card location

**E1PORT**—Number of the E1 port provisioned on the card in the specified location.

**PST**—The primary state of the card. The possible values are described in “Possible Values for PST/SST/AST”.

**SST**—The secondary state of the card. The possible values are described in “Possible Values for PST/SST/AST”.

**AST**—The associated state of the card. The possible values are described in “Possible Values for PST/SST/AST”. The values **PARENT** and **PAIRED** refer to odd and even adjacent ports on the card that are provisioned in channel bridging mode.

**ALARM STATUS**—Either "No Alarms" or current alarm number and text

**UNAVAIL REASON**—Reason for the E1 port being unavailable

**SLK**—Signaling link assigned to the E1 port

**TS**—Timeslot assigned to the signaling link

**PST**—The primary state of the signaling link. The possible values are described in "Possible Values for PST/SST/AST".

**SST**—The secondary state of the signaling link. The possible values are described in "Possible Values for PST/SST/AST".

**AST**—The associated state of the signaling link. The possible values are described in .

## rept-stat-enet

## Report Status Ethernet

Use this command to display a summary report of Ethernet status for all configured Ethernet interfaces on IP<sup>7</sup> cards in the system.

**Keyword:** **rept-stat-enet**

**Related Commands:**

**Command Class:** System Maintenance

### Parameters

**:loc=** (optional)

Location. This parameter specifies the card location as stenciled on the shelf of the system.

**Range:** 1101-1108, 1111-1112, 1201-1208, 1211-1218, 1301-1308, 1311-1318, 2101-2108, 2111-2118, 2201-2208, 2211-2218, 2301-2308, 2311-2318, 3101-3108, 3111-3118, 3201-3208, 3211-3218, 3301-3308, 3311-3318, 4101-4108, 4111-4118, 4201-4208, 4211-4218, 4301-4308, 4311-4318, 5101-5108, 5111-5118, 5201-5208, 5211-5218, 5301-5308, 5311-5318, 6101-6108, 6111-6118

**Default:** All ENET data for the card location is displayed.

**:port=** (optional)

Ethernet interface port ID.

**Range:** a, b

**Default:** All port data for ENET is displayed.

### Example

```
rept-stat-enet
```

```
rept-stat-enet:loc=1101:port=b
```

### Dependencies

Another command is already in progress.

If the **loc** parameter is specified, then the **port** parameter must be specified. If the **port** parameter is specified, then the **loc** parameter must be specified.

The shelf and card must be equipped, and the card table entry **appl** must be IPLIM, IPLIMI, SS7IPGW or IPGWI.

**Notes**

None.

**Output**

The following example displays a report on the status of all configured Ethernet interfaces on IP<sup>7</sup> cards in the system.

**rept-stat-enet**

```
eagle101110 07-02-10 14:50:23 EST EAGLE 35.6.0
```

| LOC  | PORT | IPADDR          | PST    | SST    | AST    |
|------|------|-----------------|--------|--------|--------|
| 1101 | A    | 1.1.1.1         | OOS-MT | Fault  | ALMINH |
| 1101 | B    | 123.234.222.111 | IS-ANR | Active | -----  |
| 1201 | A    | 111.1.24.200    | IS-NR  | Active | -----  |
| 1201 | B    | 2.31.234.1      | OOS-MT | Fault  | -----  |

Command Completed.

;

The following example displays the summary for a specific card location and port.

**rept-stat-enet:loc=1101:port=b**

```
eagle101110 07-02-10 14:54:23 EST EAGLE 35.6.0
```

| LOC  | PORT | IPADDR          | PST    | SST    | AST   |
|------|------|-----------------|--------|--------|-------|
| 1101 | B    | 123.234.222.111 | IS-ANR | Active | ----- |

```
ALARM STATUS = ** 0537 Ethernet error threshold exceeded
```

Command Completed.

;

**Legend**

- **CARD**—The location of the card.
- **VERSION**—The version number of the application loaded on the card. Dashes (- - - -) in the version column indicate one of the following conditions about the card:
  - The card is configured but is not physically present in the system.
  - The card does not run a GPL, such as TDM or MDAL cards.
  - The card is IS-ANR or is in the process of being loaded.
- **TYPE**—The card type entered in the database. (The DCM and SSEDCCM cards show card type DCM.)
- **APPL**—The application loaded on this card.
- **PST**—The primary state of the card. The possible values are described in "Possible Values for PST/SST/AST".
- **SST**—The secondary state of the card. The possible values are described in "Possible Values for PST/SST/AST".
- **AST**—The associated state of the card. The possible values are described in .

**rept-stat-eroute**

**Report Status EROUTE**

Use this command to display the status of STC cards and E5-STC cards (running the **eroute** application) for the EAGLE 5 Integrated Monitoring Support (E5IS) feature.

**NOTE: As of Release 40.1.0, this command is obsolete. Use the rept-stat-mon command to display the status of the EROUTE subsystem.**

**Keyword:** rept-stat-eroute

**Related Commands:**

**Command Class:** System Maintenance

### Parameters

**:loc=** (optional)

Location. This parameter specifies the unique identifier of a specific STC card (STC card or E5-STC card) located in the STP.

**Range:** 1101-1108, 1111-1112, 1201-1208, 1211-1218, 1301-1308, 1311-1318, 2101-2108, 2111-2118, 2201-2208, 2211-2218, 2301-2308, 2311-2318, 3101-3108, 3111-3118, 3201-3208, 3211-3218, 3301-3308, 3311-3318, 4101-4108, 4111-4118, 4201-4208, 4211-4218, 4301-4308, 4311-4318, 5101-5108, 5111-5118, 5201-5208, 5211-5218, 5301-5308, 5311-5318, 6101-6108, 6111-6118

**Default:** All STC cards are reported.

**:mode=** (optional)

Mode of reporting for the command. When **mode=perf** is specified, only subsystem performance information is displayed.

**Range:** perf

**Default:** None.

### Example

```
rept-stat-eroute
rept-stat-eroute:mode=perf
rept-stat-eroute:loc=1213
```

### Dependencies

The **mode** and **loc** parameters cannot be specified in the same command.

No other **rept-stat-xxx** command can be in progress when this command is entered.

At least one STC card (STC card or E5-STC card running the **eroute** application) must be configured before this command can be entered.

As of Release 40.1.0, this command is obsolete. To obtain the EROUTE subsystem status, use the **rept-stat-mon** command.

### Notes

When the **loc** parameter is specified, only the card information for the specified card is displayed.

When the **mode=perf** parameter is specified, only subsystem performance information is displayed.

**Output**

If an **eroute** subsystem alarm is raised while the **rept-stat-eroute** command is processing, then the command output may not display the alarm. The alarm is displayed if the command is issued a second time.

When no parameters are specified in the command, the report shows card, subsystem, and alarm information.

**rept-stat-eroute**

```
rlghncxa03w 07-03-11 16:35:57 IST EAGLE 37.0.0
EROUTE SUBSYSTEM REPORT IS-NR Active -----
STC Cards Configured= 5 Cards IS-NR= 2
EISCOPY BIT = ON
System Threshold = 80% Total Capacity
System Peak EROUTE Load: 12991 Buffers/Sec
System Total EROUTE Capacity: 21000 Buffers/Sec
```

SYSTEM ALARM STATUS = No Alarms.

| CARD | VERSION     | PST          | SST      | AST   | TVG<br>USAGE | CPU<br>USAGE |
|------|-------------|--------------|----------|-------|--------------|--------------|
| 1211 | -----       | OOS-MT-DSBLD | Manual   | ----- | 0%           | 0%           |
| 1104 | 052-008-000 | IS-NR        | Active   | ----- | 63%          | 28%          |
| 1112 | 052-008-001 | IS-NR        | Active   | ----- | 55%          | 28%          |
| 1303 | 255-255-255 | OOS-MT       | Isolated | ----- | 0%           | 0%           |
| 1311 | 255-255-255 | OOS-MT       | Isolated | ----- | 0%           | 0%           |

EROUTE Service Average TVG Capacity = 59% Average CPU Capacity = 28%

Command Completed.

;

**rept-stat-eroute**

```
rlghncxa03w 07-03-11 07:01:08 IST EAGLE 37.0.0
EROUTE SUBSYSTEM REPORT IS-ANR Busy -----
STC Cards Configured= 2 Cards IS-NR= 2
EISCOPY BIT = ON
System Threshold = 80% Total Capacity
System Peak EROUTE Load: 4800 Buffers/Sec
System Total EROUTE Capacity: 4800 Buffers/Sec
```

SYSTEM ALARM STATUS = \* 0472 EROUTE System Threshold Exceeded

| CARD | VERSION     | PST   | SST    | AST   | TVG<br>USAGE | CPU<br>USAGE |
|------|-------------|-------|--------|-------|--------------|--------------|
| 1213 | 111-024-000 | IS-NR | Active | ----- | 80%          | 53%          |
| 1105 | 111-024-000 | IS-NR | Active | ----- | 80%          | 53%          |

EROUTE Service Average TVG Capacity = 80% Average CPU Capacity = 53%

Command Completed.

;

When **mode=perf** is specified in the command, only subsystem performance information is displayed. The CARDS DENIED EROUTE SERVICE line appears only if there is at least one card that is denied service when the command is entered.

**rept-stat-eroute:mode=perf**

```
rlghncxa03w 07-03-11 16:36:17 IST EAGLE 37.0.0
EROUTE SUBSYSTEM REPORT IS-ANR Ovrflw=1 -----
STC Cards Configured= 3 Cards IS-NR= 2
EISCOPY BIT = ON
System Threshold = 80% Total Capacity
```

```

System Peak EROUTE Load:          12991 Buffers/Sec
System Total EROUTE Capacity:     21000 Buffers/Sec

SYSTEM ALARM STATUS = * 0482 Card(s) have been denied EROUTE service

STATISTICS
=====
CARD      CPU USAGE   TVG RATE
-----
1211     ---         ----
1104     27%         9405
1112     28%         3376
-----
AVERAGE TVG Capacity = 59%
AVERAGE CPU USAGE = 27%
TOTAL TVG RATE      = 12781

CARDS DENIED EROUTE SERVICE:  1302, 1305

Command Completed.

```

When **mode=perf** is specified in the command, only subsystem performance information is displayed.

#### rept-stat-eroute:mode=perf

```

rlghncxa03w 07-03-11 07:01:08 IST EAGLE 37.0.0
EROUTE SUBSYSTEM REPORT IS-NR          Active      -----
STC Cards Configured= 2  Cards IS-NR= 2
EISCOPY BIT = ON
System Threshold = 80% Total Capacity
System Peak EROUTE Load:          12991 Buffers/Sec
System Total EROUTE Capacity:     21000 Buffers/Sec

SYSTEM ALARM STATUS = No Alarms.

STATISTICS
=====
CARD      CPU USAGE   TVG RATE
-----
1104     27%         9405
1112     28%         3376
-----
AVERAGE TVG Capacity = 59%
AVERAGE CPU USAGE = 27%
TOTAL TVG RATE      = 12781

Command Completed.

```

When the **loc** parameter is specified in the command, information only for the specified card is displayed.

#### rept-stat-eroute:loc=1213

```

rlghncxa03w 07-03-11 16:37:21 IST EAGLE 37.0.0
CARD  VERSION   TYPE   PST   SST   AST
1104  052-008-000 STC   IS-NR          Active  -----
CARD ALARM STATUS = No Alarms.
TOTAL CPU USAGE = 28%
NTP broadcast = VALID
STC IP PORT A:           IS-NR          Active  -----
ALARM STATUS = No Alarms.
STC IP PORT B:           OOS-MT          Unavail -----
ALARM STATUS = ** 0084 IP Connection Unavailable
ERROR STATUS = DHCP Lease. Physical Link.

```

Command Completed.

;

**Legend**

When no parameters are specified in the command, the following information appears in the report:

**EROUTE SUBSYSTEM REPORT**—State of the subsystem

**STC CARDS CONFIGURED**—Total number of STC cards and E5-STC cards configured in the system

**CARDS IS-NR**—Total number of STC cards and E5-STC cards in IS-NR state

**EISCOPY BIT**—Indicates whether EIS copy function is turned On or Off

**SYSTEM THRESHOLD**—% of system total capacity being used

**SYSTEM PEAK EROUTE LOAD**—Current load in Buffers/Sec

**SYSTEM TOTAL EROUTE CAPACITY**—Total capacity in Buffers/Sec

**SYSTEM ALARM STATUS**—Either "No Alarms" or current alarm number and text

**CARD**—Card location

**VERSION**—The version number of the GPL loaded on the card. Dashes (- - - -) in the version column indicate one of the following conditions about the card:

- The card does not run a GPL, such as TDM or MDAL cards.
- The card is configured but is not physically present in the system.
- The card is IS-ANR or is in the process of being loaded.

**TYPE**—The card type entered in the database.

**PST**—The primary state of the card. The possible values are described in "Possible Values for PST/SST/AST".

**SST**—The secondary state of the card. The possible values are described in "Possible Values for PST/SST/AST".

**AST**—The associated state of the card. The possible values are described in .

**EROUTE SERVICE AVERAGE TVG CAPACITY**—%

**AVERAGE CPU CAPACITY**—%

**TVG Usage** —% of system current TVG rate based on the Max TVG capacity of the E5-ENET card

**CPU usage**—% of system current CPU usage

When **mode=perf** is specified, the following performance statistics are displayed:

**STATISTICS**

**CARD**—Card location

**CPU USAGE**—%

**TVG RATE**

**AVERAGE TVG USAGE**—%

**AVERAGE CPU CAPACITY**—%

**TOTAL TVG RATE**

When the **loc** parameter is specified in the command, only card information for the specified card is displayed: CARD, VERSION, TYPE, PST, SST, and AST as shown above, and the following information:

**CARD ALARM STATUS**—Either “No alarms” or current alarm number and text

**TOTAL CPU USAGE**—%

## rept-stat-gpl

## Report Status Generic Program Load

Use this command to display the version of GPLs currently running for an application, plus the approved and trial versions of the GPL that will run if the card is restarted.

**Keyword:** **rept-stat-gpl**

**Related Commands:** **act-gpl, alw-card, chg-gpl, copy-gpl, init-card, init-sys, rtrv-gpl**

**Command Class:** Program Update

### Parameters

**:display=** (optional)

Display mode. Specifies whether the report displays only application GPL data for all cards, or both IMT and application GPL data.

**Range:** **all**

**:gpl=** (optional)

Generic program load. This parameter specifies the type of GPL to report on.

**Range:** *xyyyyyyy*

1 alphabetic character followed by up to 7 alphanumeric characters. Valid GPLs are:

**atmansi**—Used by the LIM cards to support the high-speed ATM signaling link feature

**atmhc**—Supports functionality for the E5-ATM card. The E5-ATM card runs either the ATMANSI or ATMITU application. The GPL allows the card to support up to 2 signaling links.

**atmitu**—Used by E1 ATM cards to support the high-speed E1 ATM signaling link feature

**blbepm**—Flash GPL containing the BIOS ROM image on E5-E1T1 and E5-ENET cards

**blbios**—Flash GPL containing the BIOS ROM image on HC-MIM cards that are used for E1 or T1 signaling links

**blbsmg**—Flash GPL containing the BIOS ROM image on E5-SM4G cards

**blcpld**—Flash GPL containing the bit files for the CPLD on HC-MIM, E5-E1T1, and E5-ENET cards that are used for E1 or T1 signaling links.

**bldiag6**—Flash GPL containing the diagnostic code on E5-E1T1 cards, HC-MIM cards, and E5-ENET cards

**blmcap**—Flash GPL containing a tar image with all code required on E5-MCAP cards

**blvxw6**—Flash GPL containing the VxWorks operating system on E5-E1T1 cards, HC-MIM cards, and E5-ENET cards

**blrom1**—Flash GPL containing the bootloader code for VxWorks operating system on HC-MIM cards

**bpdcn**—Used to support the flash memory Board PROM for DCM, DSM, and GPSM boards, original design

**bpdcn2**—Used to support the flash memory Board PROM for DCM and GPSM boards, revised design



**bphcap**—Used to support Board PROM for HCAP flash memory

**bphcapt**—Supports Board PROM for HCAP-T flash memory

**bphmux**—Supports Board PROM for HMUX flash memory

**bpmpl**—Supports Board PROM for MPL flash memory

**bpmlt**—Supports Board PROM for E1/T1 flash memory

**cd**—Used in the card manufacturing process.

**eoam**—Used by the GPSM-II card for enhanced OAM functions

**eroute**—Used by the STC card for EAGLE 5 Integrated Monitoring Support functions

**erthe**—Used by the E5-ENET card when the card acts as an STC card (E5-STC card) for EAGLE 5 Integrated Monitoring Support functions

**gls**—Used by TSM cards to download gateway screening to LIM cards

**glshe**—Used by E5-TSM cards to download gateway screening to LIM and SCCP cards

**hipr**—Communication software used on the High Speed IMT Packet Router (HIPR) card

**hipr2**—Communication software used on the High Speed IMT Packet Router (HIPR2) card

**imt**—Communication processor on the logical processing element (LPE)

**imtpci**—Communication software that operates the IMT bus on HC-MIM, E5-E1T1, and E5-ENET cards

**ipghe**—Used by E5-ENET cards to support TCP/IP point-to-multipoint connectivity for both ANSI and ITU point codes

**ipgwi**—Used by SSEDCEM cards for TCP/IP point-to-point connectivity for ITU point codes

**iplhe**—Used by E5-ENET cards for TCP/IP point-to-point connectivity for both ANSI and ITU point codes

**iplim**—Used by SSEDCEM cards for TCP/IP point-to-point connectivity for ANSI point codes

**iplimi**—Used by SSEDCEM cards for TCP/IP point-to-point connectivity for ITU point codes

**ips**—Used by IPSM cards for the IP User Interface feature

**ipsg**—Used by E5-ENET cards to support the combined functionality of IPLIMx M2PA and IPGWx M3UA

**ipshe**—Used by E5-IPSM cards to support the IPS application

**mcp**—Used by MCPM cards for the Measurements Platform feature

**oamhe**—Used by E5-MCAP cards for enhanced OAM functions

**pldpmc1**—Flash GPL used on HC-MIM and E5-E1T1 cards for E1 and T1 signaling links

**sccphe**—Used by E5-SM4G cards to support the EPAP-based features and the LNP ELAP Configuration feature. If no EPAP-based or LNP ELAP Configuration feature is turned on, and if an E5-SM4G card when the card acts as an STC card (E5-STC card) for EAGLE 5 Integrated Monitoring Support functions.

**ss7he**—Supports the functionality for HC-MIM or E5-E1T1 cards. The HC-MIM and E5-E1T1 cards run the SS7ANSI or CCS7ITU application; the GPL allows the card to support up to 64 signaling links for E1 and T1 functions.

**ss7ipgw**—Used by SSEDCEM cards to support TCP/IP point-to-multipoint connectivity

**ss7ml**—Support functionality for MPL and the E1/T1 MIM cards. MPL cards run the SS7ANSI application on a LIMDS0 card (as in the command **ent-card:type=limds0:appl=ss7ansi**); the GPL allows the card to support 8 signaling links rather than the usual 2 links for LIM cards. MPL cards support only the DS0 interface. E1/T1 MIM card runs either the SS7ANSI or CCS7ITU application; the GPL allows the card to support 8 signaling links for E1 and T1 functions.

**utility**—Used by the factory for testing, and when directed by the Customer Care Center

**vcd**—Used in the card manufacturing process

**vsc**—Used by Service Module cards to support the EPAP-based and the LNP ELAP Configuration features. If no EPAP-based or LNP ELAP Configuration feature is turned on, and if a Service Module card is present, then the GPL processes normal GTT traffic.

**vxwslan**—Used by SSEDCCM cards to support the STP LAN application

**Default:** All GPL types

**:loc=** (optional)

Location. This parameter specifies the target card address and displays the versions of all GPLs running at the specified card location. For HC-MIM, E5-ENET, or STC cards, this information includes all non-activated flash GPLs. For cards that are not HC-MIM, STC, or E5-ENET or non E5-IPSM cards, there is no additional data: this parameter limits the report to the target card address.

**Range:** 1101-1108, 1111-1113, 1115, 1201-1208, 1211-1212, 1301-1308, 1311-1318, 2101-2108, 2111-2118, 2201-2208, 2211-2218, 2301-2308, 2311-2318, 3101-3108, 3111-3118, 3201-3208, 3211-3218, 3301-3308, 3311-3318, 4101-4108, 4111-4118, 4201-4208, 4211-4218, 4301-4308, 4311-4318, 5101-5108, 5111-5118, 5201-5208, 5211-5218, 5301-5308, 5311-5318, 6101-6108, 6111-6118

### Example

```
rept-stat-gpl
rept-stat-gpl:display=all
rept-stat-gpl:loc=1201
rept-stat-gpl:gpl=hipr2
rept-stat-gpl:gpl=ipsg
```

### Dependencies

No other **rept-stat-xxxx** command can be in progress when this command is entered.

None of the following parameters can be specified together in the same command: **display=all** parameter, **loc** parameter, **gpl** parameter.

The value specified for the **gpl** parameter must be supported. See the **gpl** definition for a list of supported GPLs.

### Notes

To check the version of the EPAP or ELAP application, use the **rept-stat-mps** command.

When this command is entered, information is displayed only for the cards that are IS-NR or IS-ANR.

Use the **chg-gpl** command to turn auditing on and off.

Use the **rtrv-gpl** command to display the audit state.

The approved GPL is the GPL that resides on the active fixed disk and was made the approved version by specifying the GPL version number while executing the **act-gpl** command.

The trial GPL is the version of the GPL that was downloaded from the removable cartridge or drive, but not activated by the **act-gpl** command.

When the **act-gpl** command is executed, the version specified becomes the approved GPL and the previously approved GPL becomes the trial GPL.

If any card is not running the active MASP system release version of a GPL, “ALM” is displayed to indicate that the card is in GPL alarm condition.

If GPL auditing is on, a minor alarm is shown, and “ALM” is displayed for each APPROVED GPL (**rtrv-gpl**) and for each RUNNING GPL (**rept-stat-gpl**) that does not match the GPL in the RELEASE column of the **rtrv-gpl** command output. If GPL auditing is off, the minor alarm is not activated, but “ALM” is displayed for each GPL that does not match the GPL in the RELEASE column.

If no **gpl** parameter is specified, the approved and trial versions for all GPLs are displayed.

If a GPL is not found, a version of “-----” is displayed. This should happen only for utility and OAM GPLs when the cartridge is not inserted. A utility trial version is never displayed because it can never be run.

If the removable cartridge or drive is inserted, an “\*” (asterisk) is displayed next to the OAM trial version. The asterisk serves as a reminder that the trial version of a GPL is loaded when the card that is running the OAM is restarted. All other cards load their approved versions of GPLs when they are restarted.

If a card is inhibited, “-----” is displayed for the running version.

When the **gpl** parameter is not specified, the default is to display all application GPLs that are running on provisioned cards. The flashable GPLs (those loaded on the card by using the **init-flash** command) are not displayed.

When the **gpl=imt** parameter is specified, only the IMT GPLs for each configured card connected to the IMT are displayed.

A plus (+) symbol in the output indicates that the flash GPL currently being run has not yet been activated on the card. See the **act-flash** or **init-flash** command for a list of flash GPLs.

When a GPL is specified in the **gpl** parameter, the specified GPL for each card connected to the IMT is displayed.

## Output

The output of the **rept-stat-gpl** command is site-specific and configuration-specific. The following output examples show typical output for the commands that are entered; the output that is shown can differ from output that appears for a particular system.

This output appears when no parameters are defined. All GPLs for the card are listed.

### rept-stat-gpl

```
rlghncxa03w 09-04-04 07:01:08 EST EAGLE 41.0.0
GPL      CARD      RUNNING      APPROVED      TRIAL
ATMHC    1103    128-002-000    128-002-000    128-002-000
ATMHC    1107    128-002-000    128-002-000    128-002-000
GLSHC    1106    130-001-000    130-001-000    130-001-000
EOAM     1113    025-002-000    025-002-000    -----
EOAM     1115    025-002-000    025-002-000    -----
VSCCP    1103    026-001-000    026-001-000    026-001-000
ATMANSI  1205    025-001-000    025-001-000    025-001-000
ATMANSI  1211    025-001-000    025-001-000    025-001-000
IPLIM    1213    025-001-000    025-001-000    025-001-000
SS7IPGW  1215    025-001-000    025-001-000    025-001-000
SS7ML    1105    027-001-000    027-001-000    027-001-000
OAP      A        025-001-000    025-001-000    -----
OAP      B        025-001-001 ALM    025-001-000    -----
IPSG     1305    040-000-000    040-000-000    040-000-000
Command Completed.
```

;

The following example appears for the UTILITY GPL, whether the cartridge or drive is inserted or not inserted.

### rept-stat-gpl:gpl=utility

```
rlghncxa03w 09-01-07 10:23:93 EST EAGLE 40.1.0
GPL      CARD      RUNNING      APPROVED      TRIAL
UTILITY  1101    101-016-000    101-016-000    -----
Command Completed.
```

;

In the following example, card 3108 is running the older, approved GPL. Cards 2108 and 2208 are each running a new nonapproved version. Card 2108 has had this version activated, and card 2208 is still running this version in a trial mode (a + appears following the ALM indicator).

### rept-stat-gpl:gpl=bphcap

```
rlghncxa03w 05-01-07 10:23:93 EST EAGLE 33.0.0
GPL      CARD      RUNNING      APPROVED      TRIAL
BPHCAP   2108    101-005-001 ALM    101-016-000    101-005-001
BPHCAP   2208    101-005-001 ALM+  101-016-000    101-005-001
BPHCAP   3108    101-016-000    101-016-000    101-005-001
Command Completed.
```

;

Output for the BPHMUX, HIPR, or HIPR2 GPLs shows the GPL that is running on each card in slots 09 and 10 on each provisioned shelf. The following example shows the output for the HIPR GPL.

### rept-stat-gpl:gpl=hipr

```
rlghncxa03w 09-08-04 07:01:08 EST EAGLE5 41.1.0
GPL      CARD      RUNNING      APPROVED      TRIAL
HIPR     1109    118-020-000    118-020-000    118-020-000
HIPR     1110    118-020-000    118-020-000    118-020-000
HIPR     1209    118-020-000    118-020-000    118-020-000
HIPR     1210    118-020-000    118-020-000    118-020-000
Command Completed.
```

;

The following example specifies the **display=all** parameter to display both IMT and application GPL information.

The example also contains asterisks with the following meanings:

- \* The SS7ML entry in the GPL column at location 1105 indicates that a multi-port LIM is running on the system. The card is provisioned in the database with the **ss7ansi** application.
- \*\* The OAP entries appear only if an OAP is provisioned and running. Systems that use two OAPs show two entries for the OAP: OAP A and OAP B.

**rept-stat-gpl:display=all**

rlghncxa03w 09-06-07 10:23:93 EST EAGLE 41.1.0

| GPL     | CARD   | RUNNING     | APPROVED         | TRIAL       |
|---------|--------|-------------|------------------|-------------|
| EOAM    | 1113   | 027-002-000 | 027-002-000      | -----       |
|         | BPDCM2 | 027-001-000 | 027-001-000      | 210-001-003 |
| EOAM    | 1115   | 027-002-000 | 027-002-000      | -----       |
|         | BPDCM2 | 027-001-000 | 027-001-000      | 210-001-003 |
| VSCCP   | 1212   | 027-001-000 | 027-001-000      | 027-001-000 |
|         | BPDCM  | 027-001-000 | 027-001-000      | 210-001-003 |
| ATMANSI | 1203   | 027-001-000 | 027-001-000      | 027-001-000 |
|         | BPHCAP | 027-001-000 | 027-001-000      | 210-001-003 |
| SS7ML*  | 1105   | 027-001-000 | 027-001-000      | 027-001-000 |
|         | BPMPPL | 230-001-001 | 230-001-001      | 230-001-001 |
| IPLIM   | 1213   | 027-001-000 | 027-001-000      | 027-001-000 |
|         | BPDCM  | 027-001-000 | 027-001-000      | 210-001-003 |
| SS7IPGW | 1215   | 027-001-000 | 027-001-000      | 027-001-000 |
|         | BPDCM  | 210-001-003 | ALM+ 027-001-000 | 210-001-003 |
| BPHMUX  | 1109   | 027-005-000 | 027-005-000      | 027-005-000 |
| BPHMUX  | 1110   | 027-005-000 | 027-005-000      | 027-005-000 |
| BPHMUX  | 1209   | 027-005-000 | 027-005-000      | 027-005-000 |
| BPHMUX  | 1210   | 027-005-000 | 027-005-000      | 027-005-000 |
| HIPR2   | 1309   | 027-005-000 | 027-005-000      | 027-005-000 |
| HIPR2   | 1310   | 027-005-000 | 027-005-000      | 027-005-000 |
| OAP**   | A      | 027-001-000 | 027-001-000      | -----       |
| OAP**   | B      | 027-001-001 | ALM 027-001-000  | -----       |

Command Completed.

The following example shows output when the **loc** parameter is specified for an HC-MIM card.

The following notes explain the last 5 lines of this example:

1. IMTPCI has been downloaded with the **init-flash** command, the card has reset, and IMTPCI was activated normally with the **act-flash** command.
2. BLBIOS has been downloaded with the **init-flash** command, but the card has not been initialized. The inactive version will load when the card is next initialized.
3. BLVXW6 has been downloaded with the **init-flash** command, the card has been reset. BLVXW6 was activated with the **act-flash** command, but it is not the approved version on the TDM.
4. BLDIAG6 has been downloaded with the **init-flash** command, and the card has been reset; the inactive version is running. The ALM indicates that it is not the approved version and the '+' indicates that it has not been activated yet. The '\*' next to the active version indicates that if the card resets again, the active version will run.

5. PLDPMC1 has been downloaded with the **init-flash** command and the card has been reset, but the GPL has not been activated yet. This is the same condition as Note 4, except that there is no alarm condition.

**rept-stat-gpl:loc=1203**

```
rlghncxa03w 08-05-01 10:23:93 EST EAGLE 39.0.0
GPL Auditing ON

GPL      CARD      RUNNING      APPROVED      TRIAL
SS7HC    1203      128-020-081  128-020-081  128-020-081
          IMTPCI    128-020-081  128-020-081  128-020-081
          BLBIOS    128-020-081  128-020-081  128-020-081
          BLCPLD    128-020-081  128-020-081  128-020-081
          BLVXW6    128-020-081  128-020-081  128-020-081
          BLDIAG6   128-020-081  128-020-081  128-020-081
          PLDPMC1   128-020-081  128-020-081  128-020-081

          ACTIVE      INACTIVE
          IMTPCI    125-001-000  125-002-000 * ----- Note 1
          BLBIOS    125-001-000  125-001-000  125-003-000 * Note 2
          BLCPLD    125-001-000  125-001-000 * -----
          BLVXW6    125-002-000ALM  125-002-000 * ----- Note 3
          BLDIAG6   125-003-000ALM+  125-002-000 * 125-003-000 Note 4

          PLDE1T1    125-001-000  +  125-002-000 * 125-001-000 Note 5
Command Completed.
```

;

The following example shows output when the **loc** parameter is specified for a card that is not an HC-MIM or E5-ENET card.

**rept-stat-gpl:loc=1217**

```
rlghncxa03w 07-02-01 10:23:93 EST EAGLE 37.5.0
GPL Auditing ON

GPL      CARD      RUNNING      APPROVED      TRIAL
ATMANSI  1217      125-001-000  125-001-000  125-001-000
          BPHCAP    125-001-000  125-001-000  125-001-000
Command Completed.
```

;

The following example shows output for the **ipshc** GPL running on card locations 1103 and 1107.

**rept-stat-gpl:gpl=ipshc**

```
tekelecstp 07-02-01 13:24:56 EST EAGLE 37.5.0
GPL Auditing ON

GPL      CARD      RUNNING      APPROVED      TRIAL
IPSHC    1103      128-001-000  128-001-000  128-001-000
IPSHC    1107      128-001-000  128-001-000  128-001-000
Command Completed.
```

;

Output for the BPHMUX, HIPR, or HIPR2 GPLs shows the GPL that is running on each card in slots 09 and 10 on each provisioned shelf. The following example shows the output for the HIPR2 GPL.

**rept-stat-gpl:gpl=hipr2**

```
rlghncxa03w 09-06-24 07:01:08 EST EAGLE5 41.1.0
GPL      CARD      RUNNING      APPROVED      TRIAL
HIPR2    1109      128-023-000  128-023-000  128-023-000
HIPR2    1110      128-023-000  128-023-000  128-023-000
HIPR2    1209      128-023-000  128-023-000  128-023-000
HIPR2    1210      128-023-000  128-023-000  128-023-000
Command Completed.
```

;

The following example includes IPSG cards.

**rept-stat-gpl:display=all**

eagle10110 09-04-15 18:53:54 EST EAGLE 41.0.0  
 GPL Auditing ON

| GPL     | CARD    | RUNNING         | APPROVED    | TRIAL       |   |
|---------|---------|-----------------|-------------|-------------|---|
| EOAM    | 1113    | 078-023-002     | 078-023-002 | 078-023-002 | * |
|         | BPDCM   | 130-014-000 ALM | 130-023-000 | 130-023-000 |   |
| EOAM    | 1115    | 078-023-002     | 078-023-002 | 078-023-002 | * |
|         | BPDCM   | 130-014-000 ALM | 130-023-000 | 130-023-000 |   |
| IPLIM   | 1311    | 078-023-000     | 078-023-000 | 130-023-000 |   |
|         | BPDCM   | 130-014-000 ALM | 130-023-000 | 130-023-000 |   |
| IPLIMI  | 1313    | 078-023-000     | 078-023-000 | 130-023-000 |   |
|         | BPDCM   | 130-014-000 ALM | 130-023-000 | 130-023-000 |   |
| SS7IPGW | 1107    | 078-023-000     | 078-023-000 | 130-023-000 |   |
|         | BPDCM   | 130-023-000     | 130-023-000 | 130-023-000 |   |
| SS7IPGW | 1307    | 078-023-000     | 078-023-000 | 130-023-000 |   |
|         | BPDCM   | 130-014-000 ALM | 130-023-000 | 130-023-000 |   |
| SS7IPGW | 1308    | 078-023-000     | 078-023-000 | 130-023-000 |   |
|         | BPDCM   | 130-016-000 ALM | 130-023-000 | 130-023-000 |   |
| SS7IPGW | 1315    | 078-023-000     | 078-023-000 | 130-023-000 |   |
|         | BPDCM   | 130-014-000 ALM | 130-023-000 | 130-023-000 |   |
| SS7ML   | 1202    | 078-023-000     | 078-023-000 | 130-023-000 |   |
|         | BPMPPL  | 130-014-000 ALM | 130-023-000 | 130-023-000 |   |
| SS7ML   | 1203    | 078-023-000     | 078-023-000 | 130-023-000 |   |
|         | BPMPPL  | 130-016-000 ALM | 130-023-000 | 130-023-000 |   |
| BPHMUX  | 1110    | 128-025-000     | 128-025-000 | 128-025-000 |   |
| BPHMUX  | 1210    | 128-025-000     | 128-025-000 | 128-025-000 |   |
| IPGWI   | 1317    | 078-023-000     | 078-023-000 | 130-023-000 |   |
|         | BPDCM   | 130-014-000 ALM | 130-023-000 | 130-023-000 |   |
| IPS     | 1105    | 130-023-000     | 130-023-000 | 130-023-000 |   |
|         | BPDCM   | 130-014-000 ALM | 130-023-000 | 130-023-000 |   |
| HIPR    | 1310    | 130-004-000 ALM | 130-023-000 | 130-023-000 |   |
| IPSG    | 1301    | 078-023-004     | 078-023-004 | 049-023-000 |   |
|         | IMTPCI  | 130-020-000 ALM | 130-023-000 | 130-023-000 |   |
|         | BLVXW6  | 028-020-001 ALM | 130-022-000 | 130-022-000 |   |
|         | BLDIAG6 | 130-018-000 ALM | 130-008-000 | 130-008-000 |   |
|         | BLBEPM  | 130-018-000 ALM | 128-021-000 | 128-021-000 |   |
|         | BLCPLD  | 130-018-000 ALM | 128-021-000 | 128-021-000 |   |
| IPSG    | 1303    | 078-023-004     | 078-023-004 | 049-023-000 |   |
|         | IMTPCI  | 130-023-000     | 130-023-000 | 130-023-000 |   |
|         | BLVXW6  | 130-022-000     | 130-022-000 | 130-022-000 |   |
|         | BLDIAG6 | 130-008-000     | 130-008-000 | 130-008-000 |   |
|         | BLBEPM  | 128-021-000     | 128-021-000 | 128-021-000 |   |
|         | BLCPLD  | 128-021-000     | 128-021-000 | 128-021-000 |   |
| IPSG    | 1304    | 049-023-000 ALM | 078-023-004 | 049-023-000 |   |
|         | IMTPCI  | 130-023-000     | 130-023-000 | 130-023-000 |   |
|         | BLVXW6  | 130-022-000     | 130-022-000 | 130-022-000 |   |
|         | BLDIAG6 | 130-008-000     | 130-008-000 | 130-008-000 |   |
|         | BLBEPM  | 128-021-000     | 128-021-000 | 128-021-000 |   |
|         | BLCPLD  | 128-021-000     | 128-021-000 | 128-021-000 |   |
| IPSG    | 1305    | 078-023-004     | 078-023-004 | 049-023-000 |   |
|         | IMTPCI  | 130-023-000     | 130-023-000 | 130-023-000 |   |
|         | BLVXW6  | 130-022-000     | 130-022-000 | 130-022-000 |   |
|         | BLDIAG6 | 130-008-000     | 130-008-000 | 130-008-000 |   |
|         | BLBEPM  | 128-021-000     | 128-021-000 | 128-021-000 |   |
|         | BLCPLD  | 128-021-000     | 128-021-000 | 128-021-000 |   |
| IPSG    | 1314    | 078-023-004     | 078-023-004 | 049-023-000 |   |
|         | IMTPCI  | 130-023-000     | 130-023-000 | 130-023-000 |   |
|         | BLVXW6  | 130-022-000     | 130-022-000 | 130-022-000 |   |
|         | BLDIAG6 | 130-008-000     | 130-008-000 | 130-008-000 |   |
|         | BLBEPM  | 128-021-000     | 128-021-000 | 128-021-000 |   |
|         | BLCPLD  | 128-021-000     | 128-021-000 | 128-021-000 |   |

Command Completed.

;

The following example displays the output when E5-MCAP cards are used.

**rept-stat-gpl**

```
rlghncxa03w 09-03-04 07:01:08 EST EAGLE 41.0.0
GPL      CARD      RUNNING      APPROVED      TRIAL
ATMHC    1103      128-002-000  128-002-000  128-002-000
ATMHC    1107      128-002-000  128-002-000  128-002-000
GLSHC    1106      130-001-000  130-001-000  130-001-000
OAMHC    1113      030-013-000  030-013-000  030-013-000 *
OAMHC    1115      030-013-000  030-013-000  030-013-000 *
VSCCP    1103      026-001-000  026-001-000  026-001-000
ATMANSI  1205      025-001-000  025-001-000  025-001-000
ATMANSI  1211      025-001-000  025-001-000  025-001-000
IPLIM    1213      025-001-000  025-001-000  025-001-000
SS7IPGW  1215      025-001-000  025-001-000  025-001-000
SS7ML    1105      027-001-000  027-001-000  027-001-000
OAP      A          025-001-000  025-001-000  -----
OAP      B          025-001-001 ALM  025-001-000  -----
IPSG     1305      040-000-000  040-000-000  040-000-000
Command Completed.
```

;

**Legend**

**GPL**—The type of GPL associated with the cards in the display.

**CARD**—The card location.

**RUNNING**—The GPL version the card is running. If the card is not running the active MASP system release GPL, ALM appears after the GPL version number in this column.

**APPROVED**—The GPL version that is the approved GPL.

**TRIAL**—The GPL version that is the trial GPL.

**ACTIVE**—The GPL version that has been downloaded using the **init-flash** command and activated using the **act-flash** command..

**INACTIVE**—The GPL version that has been downloaded using the **init-flash** command but has not been activated using the **act-flash** command..

----- (dashes)—GPL is not present at the specified location.

\*—The trial version will run if the card boots. (Shown to the right of the TRIAL column)

**ALM**—An alarm indicator showing that the system has an approved GPL that is not the GPL required for this software release according to the active MASP system release table.

+—The currently running flash GPL has not been activated. (Shown between the RUNNING and APPROVED columns)

**rept-stat-imt****Report IMT Status**

The interprocessor message transport bus (IMT bus) is the main communications artery between all subsystems in the system. Use this command to display the primary, secondary, and associated maintenance states of the IMT bus. The primary state indicates whether the bus is normal, abnormal, or OOS for maintenance activity. The secondary state indicates the active/inhibited status of a card for a particular IMT bus.

**Keyword:** **rept-stat-imt**

**Related Commands:** **clr-imt-stats**, **conn-imt**, **disc-imt**, **rept-imt-lvl1**, **rept-imt-lvl2**, **rmv-imt**, **rst-imt**

**Command Class:** System Maintenance



### Parameters

**:mode=** (optional)

Use this parameter to provide additional output listing the cards that currently have IMT alarm conditions outstanding. The additional output is repeated for each IMT bus following the bus status information. If no alarms are active on a given bus, no additional output is generated.

**Range:** full

**Default:** Do not display additional information.

### Example

```
rept-stat-imt
```

```
rept-stat-imt:mode=full
```

### Dependencies

No other **rept-stat-xxx** command can be in progress when this command is entered.

### Notes

The card locations are stored only by the active MASP. The information is lost if the system switches from the active to the standby MASP.

The trouble locations are displayed sorted by card location.

**Output****rept-stat-imt**

```

rlghncxa03w 04-02-27 16:50:24 EST EAGLE 31.3.0
IMT  PST          SST          AST
A    IS-NR        Active       -----
ALARM STATUS      = No alarms

IMT  PST          SST          AST
B    IS-ANR       Fault        -----
ALARM STATUS      = ** 0108 Major IMT Failure Detected

```

Command Completed.

;

**rept-stat-imt:mode=full**

```

rlghncxa03w 04-02-23 13:10:30 EST EAGLE 31.3.0
IMT  PST          SST          AST
A    IS-NR        Active       -----
ALARM STATUS      = No Alarms.

IMT  PST          SST          AST
B    OOS-MT-DSBLD Fault        -----
ALARM STATUS      = ** 0108 Major IMT failure detected.

```

CARDS WITH ACTIVE IMT B ALARMS:

```

CARD  DATE      TIME
1102  04-02-23  11:59:23
1103  04-02-23  12:01:23
1204  04-02-23  23:14:07
1205  04-02-23  23:14:07
1206  04-02-23  23:14:07

```

Command Completed.

;

**Legend**

**IMT**—IMT bus A or IMT bus B.

**PST**—The primary state of the subsystem. The possible values are described in "Possible Values for PST/SST/AST".

**SST**—The secondary state of the subsystem. The possible values are described in "Possible Values for PST/SST/AST".

**AST**—The associated state of the subsystem. The possible values are described in "Possible Values for PST/SST/AST".

**ALARM STATUS**—A listing of any trouble text alarm messages that have been generated for the specified IMT bus.

\*—Minor Alarm

\*\*—Major Alarm

\*C—Critical Alarm

The states of the IMT bus are combined from the PST and the SST as shown in Table 5-77.

Table 5-77. IMT Bus States

| PST          | SST      | AST  | Definition                                                          |
|--------------|----------|------|---------------------------------------------------------------------|
| IS-NR        | Active   | ---- | The IMT bus is operating normally.                                  |
| IS-ANR       | Fault    | ---- | The IMT bus has had a failure on at least one but not all cards.    |
| IS-ANR       | Restrict | ---- | The IMT bus is not able to run to its full capacity.                |
| IS-ANR       | Manual   | ---- | The IMT bus is inhibited, but some cards have been connected to it. |
| OOS-MT       | Fault    | ---- | The IMT bus has a failure on all cards.                             |
| OOS-MT-DSBLD | Manual   | ---- | The IMT bus is inhibited and no cards are connected to it.          |

**rept-stat-iptps**

**Report Status IPGWx TPS Utilization**

Use this command to display current and peak IPTPS usage for each IPSG / IPGWx linkset in the system or for each link in the IPSG / IPGWx linkset.

**Keyword:** `rept-stat-iptps`

**Related Commands:** `chg-ctrl-feat`, `chg-ls`, `chg-sg-opts`, `enable-ctrl-feat`, `ent-ls`, `rtrv-ctrl-feat`, `rtrv-ls`, `rtrv-sg-opts`

**Command Class:** System Maintenance

**Parameters**

**:lsn=** (optional)

Linkset name. The name of the linkset for which the report information is to be displayed.

**Range:** `ayyyyyyyy`  
1 alphabetic character followed by up to 9 alphanumeric characters

**Default:** All linksets are displayed

**:peakreset=** (optional)

Reset peak values to the current TPS values.

**Range:** `yes`, `no`

**Default:** `no`

**Example**

```
rept-stat-iptps
rept-stat-iptps:lsn=lsqw1101
rept-stat-iptps:peakreset=yes
```

**Dependencies**

If the linksets are not IPGWx or IPSG, then this command cannot be entered.

The specified linkset name must exist in the database.

**Notes**

Traffic peak data are stored only in OAM memory and are not preserved when the card that is running the OAM boots, or in the case of an active/standby switchover.

IPSG linksets have SLKTPS linksets configured rather than IPTPS linksets. The **rept-stat-iptps** command uses (Number of IS-NR links \* SLKTPS) in place of the IPTPS setting for all calculations and alarms.

If the linksets are a mixture of IPLIMx M2PA and IPSG-M2PA, then the **rept-stat-iptps** command does not report any data or raise alarms.

**Output**

The **rept-stat-iptps** command reports on IPSPG and IPGWx linkset IP TPS. The report includes the following information for the system and for each IPSPG or IPGWx linkset:

- Configured IP TPS alarm threshold
- Configured IP TPS
- Current IP TPS transmit and receive usage for 15 seconds
- Peak IP TPS transmit and receive usage and timestamp for all 15 second periods since last reset

If the linkset is specified, then the command reports the same information for the individual links in the linkset.

If the **peakreset=yes** parameter is specified, then the command resets all the stored peak values to the current actual usage for each link, and recalculates linkset and system peaks before reporting usage.

If the linkset is specified with the **peakreset=yes** parameter, then the command recalculates peaks for the specified linkset and resets all the stored peak values to the current actual usage for each link contained in the linkset before reporting usage.

**NOTE: The peaks for transmit and receive, and for link, and linkset IP TPS may all occur at different times.**

**NOTE: The IP TPS value shown in the command may contain one extra MSU if the linkset is specified. Because the alarm calculations are implemented using integer math, rounding may occur at each entity (link, linkset) if the IP TPS value for the entity is not evenly divisible by 15. This could occur when performing an IPTPS report for a linkset that has more than one link configured.**

**NOTE: For mixed IPLIMx-M2PA and IPSPG-M2PA linksets, the command does not report any data or raise alarms.**

**rept-stat-iptps**

rlghncxa03w 08-01-23 16:20:46 EST EAGLE 38.0.0

IP TPS USAGE REPORT

|          | THRESH | CONFIG |      | TPS  | PEAK | PEAKTIMESTAMP     |
|----------|--------|--------|------|------|------|-------------------|
| -----    |        |        |      |      |      |                   |
| LSN      |        |        |      |      |      |                   |
| LSGW1101 | 80%    | 4000   | TX:  | 3700 | 4000 | 03-05-05 09:49:19 |
|          |        |        | RCV: | 3650 | 4000 | 03-05-05 09:49:19 |
| LSGW1103 | 80%    | 500    | TX:  | 427  | 550  | 03-05-05 09:49:19 |
|          |        |        | RCV: | 312  | 450  | 03-05-05 09:49:19 |
| -----    |        |        |      |      |      |                   |

Command Completed.

;

**rept-stat-iptps:lsn=lsgw1101**

rlghncxa03w 08-03-06 09:49:20 EST EAGLE 38.0.0

IP TPS USAGE REPORT

|       | THRESH | CONFIG |  | TPS | PEAK | PEAKTIMESTAMP |
|-------|--------|--------|--|-----|------|---------------|
| ----- |        |        |  |     |      |               |
| LSN   |        |        |  |     |      |               |

```

LSGW1101      100%    4000 TX:    800      800 03-05-06 09:49:19
              RCV:    800      800 03-05-06 09:49:19
-----
LOC  LINK
1101  A    80%    2000 TX:    400      400 03-05-06 09:49:19
              RCV:    400      400 03-05-06 09:49:19
1103  A    80%    2000 TX:    400      400 03-05-06 09:49:19
              RCV:    400      400 03-05-06 09:49:19
-----

```

Command Completed.

;

**rept-stat-iptps:peakreset=yes**

```

rlghncxa03w 08-03-06 09:49:20 EST  EAGLE 38.0.0
IP TPS USAGE REPORT

```

```

              THRESH  CONFIG          TPS      PEAK      PEAKTIMESTAMP
-----
LSN
LSN1234567   80%    4000 TX:   4000     4000 03-05-05 09:49:19
              RCV:   4000     4000 03-05-05 09:49:19
LSGW1103     80%    500  TX:   427     427 03-05-05 09:49:19
              RCV:   312     312 03-05-05 09:49:19
-----

```

Command Completed.

;

**Legend**

**LSN**—THE LINKSET NAME.

**THRESH**—THE THRESHOLD AT WHICH AN ALARM WILL BE GENERATED TO INDICATE THAT THE ACTUAL LINKSET **TPS** IS APPROACHING THE CONFIGURED LINKSET IPTPS VALUE (LSUSEALM VALUE AS SHOWN IN RTRV-LS OUTPUT).

**CONFIG**—THE IPTPS VALUE AS SHOWN IN RTRV-LS OUTPUT.

**TPS**—THE CURRENT TRANSMIT (**TX**) AND RECEIVE (**RCV**) **TPS** FOR 15 SECONDS.

**PEAK**—THE PEAK TRANSMIT (**TX**) AND RECEIVE (**RCV**) **TPS** USAGE FOR ALL 15 SECOND PERIODS SINCE THE LAST PEAK RESET.

**PEAKTIMESTAMP**—THE DATE AND TIME THAT THE DISPLAYED TRANSMIT AND RECEIVE **TPS** PEAKS OCCURRED.

**LOC**—LOCATION OF THE CARD THAT CONTAINS A DISPLAYED LINK IN THE LINKSET.

**PORT**—A SIGNALING LINK IN THE LINKSET.

**THRESH**—THE SLKUSETHRESH VALUE AS SHOWN IN RTRV-LS OUTPUT

**CONFIG**—DASHES (-----). THERE IS NO CONFIGURABLE **TPS** FOR LINKS.

**TPS**—THE CURRENT TRANSMIT (**TX**) AND RECEIVE (**RCV**) **TPS** FOR 15 SECONDS.

**PEAK**—THE PEAK TRANSMIT (**TX**) AND RECEIVE (**RCV**) **TPS** USAGE FOR ALL 15 SECOND PERIODS SINCE THE LAST PEAK RESET.

**PEAKTIMESTAMP**—THE DATE AND TIME THAT THE DISPLAYED TRANSMIT AND RECEIVE **TPS** PEAKS OCCURRED.

**rept-stat-lfs****Report LFS Test Status**

Use this command to generate a report of all the SS7 links that are under LFS test. Along with the link identification information, the command output lists the current LBP, the test pattern, the maximum bit-errors threshold, the bit-errors since the beginning of this test, the maximum test time, and the time elapsed since the beginning of the test.

**Keyword:** `rept-stat-lfs`

**Related Commands:** `rept-stat-slk`

**Command Class:** Link Maintenance

**Parameters**

**:link=** (optional)

The signaling link port on the card specified in the **loc** parameter.

**Synonym:** `port`

**Range:** `a, b, a1-a31, b1-b31`

Not all card types support all **link** parameter values.

See Table A-1 for valid **link** parameter range values for each type of card that can have assigned signaling link ports.

**:loc=** (optional)

This parameter is mandatory when the **port** parameter is specified.

**Range:** `1101-1108, 1111-1112, 1201-1208, 1211-1212, 1301-1308, 1311-1318, 2101-2108, 2111-2118, 2201-2208, 2211-2218, 2301-2308, 2311-2318, 3101-3108, 3111-3118, 3201-3208, 3211-3218, 3301-3308, 3311-3318, 4101-4108, 4111-4118, 4201-4208, 4211-4218, 4301-4308, 4311-4318, 5101-5108, 5111-5118, 5201-5208, 5211-5218, 5301-5308, 5311-5318, 6101-6108, 6111-6118`

**Example**

```
rept-stat-lfs
rept-stat-lfs:loc=1201
rept-stat-lfs:loc=1201:link=a1
```

**Dependencies**

The LFS feature must be turned on before this command can be entered.

The card location specified in the **loc** parameter must be equipped.

The signaling link that is specified in the **link** parameter must be assigned to the card in the **loc** parameter location.

Card locations 1113, 1114, 1115, 1116, 1117, 1118, and all *xy09* and *xy10* locations (x is the frame and y is the shelf) cannot be specified in the **loc** parameter.

The card location (**loc** parameter) must be a **limds0**, **limt1**, or **limch** (associated with a **limt1**) card configured with either an **ss7ansi** or **ccs7itu** application.

If the **link** parameter is specified, the **loc** parameter must be specified.

This command cannot be entered during upgrade.

**Notes**

This command can be canceled using the **F9** function key or the **canc-cmd** command. See **canc-cmd** for more information.

**Output**

If no parameters are specified, all links that are in LFS test are displayed.

**rept-stat-lfs**

```
rlghncxa03w 04-02-27 16:50:24 EST EAGLE 31.3.0
SLK      LBP  PATTERN      MAX-ERRORS  BIT_ERRORS  MAX-TIME  TEST-TIME
1201,A   5   B0247         56           30   01:00:00  00:00:50
1202,A   3   B511          56           27   01:00:00  00:01:05
1203,A   1   OCTET         56           12   01:00:00  00:02:07
1204,A   6   ALTERNATE     56           28   01:00:00  00:04:08
1205,A   2   B0247         56           36   01:00:00  00:03:05
1206,A   1   B0247         56           15   01:00:00  00:06:06
1207,A   3   B0247         56           19   01:00:00  00:02:04
1208,A   5   B0247         56           23   01:00:00  00:04:01
;
```

If only the **loc** parameter is specified, all links in LFS test on the specified card are displayed.

**rept-stat-lfs:loc=1208**

```
rlghncxa03w 04-02-27 16:50:24 EST EAGLE 31.3.0
SLK      LBP  PATTERN      MAX-ERRORS  BIT_ERRORS  MAX-TIME  TEST-TIME
1208,A   5   B0247         56           23   01:00:00  00:04:01
1208,B1  4   B0247         56           23   01:00:00  00:08:01
;
```

If the **loc** and **link** parameters are specified, only the specified link on the specified card is displayed.

**rept-stat-lfs:loc=1208:link=a**

```
rlghncxa03w 04-02-27 16:50:24 EST EAGLE 31.3.0
SLK      LBP  PATTERN      MAX-ERRORS  BIT_ERRORS  MAX-TIME  TEST-TIME
1208,A   5   B0247         56           23   01:00:00  00:04:01
;
```

**Legend**

**SLK**—The signaling link identifier; same as **loc** and **link** parameters of **act-lbp** command.

**LBP**—The loopback point of this test; same as **lbp** parameter of **act-lbp** command.

**PATTERN**—The test pattern; same as **pattern** parameter of **act-lbp** command.

**MAX-**

**ERRORS**—The bit-error threshold allowed for this LFS test; same as **maxerr** parameter of **act-lbp** command.

**BIT\_ERRORS**—Number of bit-errors since the beginning of this test.

**MAX-TIME**—The time window for testing each loop-back point; same as **time** parameter of **act-lbp** command.

**TEST-TIME**—Amount of time the test has run.

**rept-stat-lnp****LNP Status Report**

Use this command to generate a report of the local number portability (LNP) status information.

When the **rept-stat-lnp** command is entered with no parameters, a summary of the LNP status of all equipped SCCP cards is provided. This summary includes Global Title Translation (GTT) and LNP function status for every SCCP card, as well as LNPQS system information.

When the **loc** parameter is specified, a detailed status of LNP information for the specified SCCP card is provided. These detailed reports include information for each of the following functions: Global Title Translation (GTT), LNP Message Relay (LNPMR), LNP Query Service (LNPQS),



Personal Communication Service LNP Query Service (PLNPQS) (if the PLNP feature is turned on), Wireless LNP Query Service (WNPQS) (if the WNP feature is turned on), Triggerless LNP (TLNP) (if the TLNP feature is turned on), LRNQT (if the ITU TCAP LRN Query feature is turned on), and Automatic Call Gap (ACG).

When the **card=sccp all** parameter is specified, a detailed status of LNP information for all SCCP cards is provided.

**Keyword:** **rept-stat-lnp**

**Related Commands:** **chg-th-alm, rept-stat-sccp, rtrv-th-alm**

**Command Class:** System Maintenance

## Parameters

**:card=** (optional)

Specify **card=sccp-all** to display a report of the LNP status of all equipped SCCP cards. The **card** parameter is not valid with the **loc** parameter.

**Range:** **sccp-all**

**:loc=** (optional)

The card location as stenciled on the shelf of the EAGLE 5 ISS. The **loc** parameter is not valid with the **card** parameter.

**Range:** **1101-1108, 1111-1112, 1201-1208, 1211-1218, 1301-1308, 1311-1318, 2101-2108, 2111-2118, 2201-2208, 2211-2218, 2301-2308, 2311-2318, 3101-3108, 3111-3118, 3201-3208, 3211-3218, 3301-3308, 3311-3318, 4101-4108, 4111-4118, 4201-4208, 4211-4218, 4301-4308, 4311-4318, 5101-5108, 5111-5118, 5201-5208, 5211-5218, 5301-5308, 5311-5318, 6101-6108, 6111-6118**

**Default:** A summary for all cards is displayed.

## Example

```
rept-stat-lnp
rept-stat-lnp:card=sccp-all
rept-stat-lnp:loc=1106
```

## Dependencies

The LNP feature must be turned on (see the **enable-ctrl-feat** command) before this command can be entered.

Only one optional parameter can be specified in the command. The **card** and **loc** parameters cannot be specified together in the same command.

The only valid value for the **card** parameter is **sccp-all**.

No other **rept-stat-xxx** command can be in progress when this command is issued.

At least one SCCP card must be configured in the system.

The card location (**loc** parameter) must identify a configured TSM or Service Module card running the **vsccp** or **sccphc** application.

## Notes

The error information on this report is based on 30-second intervals. The values for number of errors and total messages are for the last 30-second period. The usage information is also updated once every 30 seconds.

When the **rept-stat-lnp** command is entered with no parameters, a summary of the LNP subsystem status is reported, followed by a summary of the LNP status of all equipped SCCP cards. This summary includes global title translation (GTT) and LNP function status for every SCCP card, as well as LNPNQS system information. The GTT status is either ACT (active) or SWDL (software

loading). The LNP status is either ACT, OFFLINE, or SWDL. LNPQS system information is then provided in the following fields:

- The ALARM STATUS displays the current alarm on the LNP Subsystem.
- The SSN STATUS and MATE SSN STATUS fields show the state of the LNP subsystems: Prohibited, Restricted, or Allowed.
- The ACG OVERLOAD LEVEL field shows the ACG node overload control level used by the system.
- The system average MIC usage is expressed as a percentage of the number of MICs sent by all cards, divided by the number of responses sent by all cards.

The **rept-stat-lnp** command also provides a summary of the following system-wide LNP statistics.

- The average GTT usage is expressed as the average percentage of GTT usage per card.
- The average LNPMPR usage is expressed as the average percentage of LNPMPR usage per card.
- The average LNPQS usage is expressed as the average percentage of LNPQS usage per card.
- The average WNPQS usage is expressed as the average percentage of WNPQS usage per card. WNPQS information is displayed only if the WNP feature is turned on.
- The average PLNPQS usage is expressed as the average percentage of PLNPQS usage per card. PLNPQS information is displayed only if the PCS 1900 Number Portability feature (PLNP) is turned on.
- The average LRNQT usage is expressed as the average percentage of LRNQT usage per card. LRNQT information is displayed only if the LRNQT feature is turned on.
- The average CPU usage is expressed as the average percentage of CPU usage per card.
- The total number of GTT, LNPMPR, LNPQS, WNPQS (if turned on), TLNP (if turned on), PLNPQS (if turned on), and LRNQT (if turned on) errors for corresponding messages received across all cards.

When the **rept-stat-lnp** command is entered for a specific card (for example, **rept-stat-lnp:loc=xxxx**), status information for the card at the specified location is provided, followed by the alarm status and detailed LNP status information and statistics for each LNP function.

- GTT STATUS, either ACT (active) or SWDL (software loading).
- GTT USAGE, expressed as a percentage of the amount of CPU used to process GTT messages during the last 30 seconds by the specified card.
- GTT ERRORS, the number of GTT errors detected for the total number of GTT messages received by the specified card.
- LNPMPR STATUS, either ACT (active), OFFLINE, or SWDL (software loading).
- LNPMPR USAGE, expressed as a percentage of the amount of CPU used to process LNP message relay messages during the last 30 seconds by the specified card.
- LNPMPR ERRORS, the number of LNP message relay errors detected for the total number of LNP message relay messages received by the specified card.
- LNPQS STATUS, either ACT (active), OFFLINE, and SWDL (software loading).
- LNPQS USAGE, expressed as a percentage of the amount of CPU used to process LNP query messages during the last 30 seconds by the specified card.

- LNPQS ERRORS, the number of LNP query errors detected for the total number of LNP query messages received by the specified card.
- WNPQS STATUS, either ACT (active), OFFLINE, and SWDL (software loading).
- WNPQS USAGE, expressed as a percentage of the amount of CPU used to process WNP query messages during the last 30 seconds by the specified card.
- WNPQS ERRORS, the number of WNP query errors detected for the total number of WNP query messages received by the specified card.

**NOTE:** IS-41 LNP Queries with a TT associated with the LNPQS service are pegged as IS-41 LNP Queries with a TT associated with the WNP service under the WNPQS counter. The WNPQS STATUS, WNPQS USAGE, and WNPQS ERRORS fields are displayed only if the Wireless Number Portability feature is ON.

- PLNPQS STATUS, either ACT (active), OFFLINE, and SWDL (software loading).
- PLNPQS USAGE, expressed as the amount of CPU used to process PCS 1900 LNP Query messages over the last 30-second period by the specific card.
- PLNPQS ERRORS, the number of PCS query errors detected for the total number of PCS query messages received by the specified card.

**NOTE:** PCS 1900 LNP Queries with a TT associated with the LNPQS service are processed and pegged as IN LNP Queries under the LNPQS counter. The PLNPQS STATUS, PLNPQS USAGE, and PLNPQS ERRORS fields are displayed only if the PCS 1900 Number Portability (PLNP) feature is ON.

- TLNP STATUS, either ACT (active), OFFLINE, and SWDL (software loading).
- TLNP USAGE, expressed as a percentage of the amount of CPU used to process Triggerless LNP Encapsulated IAM messages over the last 30-second period by the specific card.
- TLNP ERRORS, the number of TLNP query errors detected for the total number of TLNP query messages received by the specified card.

**NOTE:** The TLNP STATUS, TLNP USAGE, and TLNP ERRORS fields are displayed only if the Triggerless LNP (TLNP) feature is ON.

- LRNQT STATUS, either ACT (active), OFFLINE, and SWDL (software loading).
- LRNQT USAGE, expressed as a percentage of the amount of CPU used to process LRNQT queries over the last 30-second period by the specific card.
- LRNQT ERRORS, the number of LRNQT query errors detected for the total number of LRNQT messages received by the specified card.

**NOTE:** The LRNQT STATUS, LRNQT USAGE, and LRNQT ERRORS fields are displayed only if the LRNQT feature is ON.

- ACG OVERLOAD LEVEL, the ACG node overload control level being used by the system.
- MIC USAGE, expressed as a percentage of the number of MICs sent by the specific card divided by the number of responses sent by the specified card during the last 30 seconds.
- CPU USAGE, expressed as a percentage of the amount of CPU used to process messages by the specified card during the last 30 seconds.

When the **:card=sccp-all** parameter is specified, detailed information is provided about the status of all SCCP cards. The information displayed in the output is the same as that displayed for the **:loc=xxxx** parameter.

Output

In the following example, the WNP, PLNP, TLNP, and LRNQT features are off.

**rept-stat-lnp**

```

rlghncxa03w 08-11-14 10:37:22 EST EAGLE 40.0.0
LNP SUBSYSTEM REPORT OOS-MT-DSBLD Active -----
ALARM STATUS = *C 0435 LNP Subsystem is disabled

LNP Cards Configured= 3
CARD PST SST GTT STATUS LNP STATUS CPU USAGE
1106 IS-NR Active ACT OFFLINE 10%
1201 IS-NR Active ACT OFFLINE 12%
1310 OOS-MT-DSBLD Manual ----- 0%

LNPQS:
SSN STATUS = Prohibited MATE SSN STATUS = Allowed
ACG: OVERLOAD LEVEL = 0 MIC UASGE = 0%

AVERAGE USAGE:
GTT = 13% LNPMR = 0% LNPQS = 0%
AVERAGE CPU USAGE = 11%
TOTAL ERRORS:
GTT: 0 out of 2000
LNPMR: 0 out of 0
LNPQS: 0 out of 0

PROVISIONED TABLE QTY:
TN: 10 of 24000000 ( 0%)
NPA: 1 of 150000 ( 0%)
LRN: 3 of 100000 ( 0%)
    
```

Command Completed

;

LNP status command using the **card=** parameter

**rept-stat-lnp:card=sccp-all**

```

tklc1190601 06-04-05 13:45:02 EST EAGLE5 35.0.0
CARD VERSION PST SST AST
1205 038-003-013 IS-NR Active DB_DIFF
ALARM STATUS = ** 0451 RTDB reload is required
GTT: STATUS = ACT USAGE = 0% ERRORS: 0 of 0
LNPMR: STATUS = ACT USAGE = 0% ERRORS: 0 of 0
LNPQS: STATUS = ACT USAGE = 0% ERRORS: 0 of 0
WNPQS: STATUS = ACT USAGE = 0% ERRORS: 0 of 0
TLNP: STATUS = ACT USAGE = 0% ERRORS: 0 of 0
PLNPQS:STATUS = ACT USAGE = 0% ERRORS: 0 of 0
ACG: OVERLOAD LEVEL = 0 MIC USAGE = 0%
CPU USAGE = 5%

CARD VERSION PST SST AST
1317 038-003-013 IS-NR Active DB_DIFF
ALARM STATUS = ** 0451 RTDB reload is required
GTT: STATUS = ACT USAGE = 0% ERRORS: 0 of 0
LNPMR: STATUS = ACT USAGE = 0% ERRORS: 0 of 0
LNPQS: STATUS = ACT USAGE = 0% ERRORS: 0 of 0
WNPQS: STATUS = ACT USAGE = 0% ERRORS: 0 of 0
TLNP: STATUS = ACT USAGE = 0% ERRORS: 0 of 0
PLNPQS:STATUS = ACT USAGE = 0% ERRORS: 0 of 0
ACG: OVERLOAD LEVEL = 0 MIC USAGE = 0%
CPU USAGE = 5%

CARD VERSION PST SST AST
2213 038-003-013 IS-NR Active DB_DIFF
    
```

```

ALARM STATUS          = ** 0451 RTDB reload is required
GTT:  STATUS = ACT      USAGE = 0%  ERRORS: 0 of 0
LNPMPR: STATUS = ACT    USAGE = 0%  ERRORS: 0 of 0
LNPQS:  STATUS = ACT    USAGE = 0%  ERRORS: 0 of 0
WNPQS:  STATUS = ACT    USAGE = 0%  ERRORS: 0 of 0
TLNP:   STATUS = ACT    USAGE = 0%  ERRORS: 0 of 0
PLNPQS:STATUS = ACT    USAGE = 0%  ERRORS: 0 of 0
ACG:   OVERLOAD LEVEL = 0  MIC USAGE = 0%
CPU USAGE = 5%

CARD  VERSION          PST          SST          AST
2215  -----          OOS-MT-DSBLD  Manual      -----
ALARM STATUS          = No Alarms.
GTT:  STATUS = -----  USAGE = 0%  ERRORS: 0 of 0
LNPMPR: STATUS = -----  USAGE = 0%  ERRORS: 0 of 0
LNPQS:  STATUS = -----  USAGE = 0%  ERRORS: 0 of 0
WNPQS:  STATUS = -----  USAGE = 0%  ERRORS: 0 of 0
TLNP:   STATUS = -----  USAGE = 0%  ERRORS: 0 of 0
PLNPQS:STATUS = -----  USAGE = 0%  ERRORS: 0 of 0
ACG:   OVERLOAD LEVEL = 0  MIC USAGE = 0%
CPU USAGE = 0%

CARD  VERSION          PST          SST          AST
2217  038-003-013     IS-NR          Active       DB_DIFF
ALARM STATUS          = ** 0451 RTDB reload is required
GTT:  STATUS = ACT      USAGE = 0%  ERRORS: 0 of 0
LNPMPR: STATUS = ACT    USAGE = 0%  ERRORS: 0 of 0
LNPQS:  STATUS = ACT    USAGE = 0%  ERRORS: 0 of 0
WNPQS:  STATUS = ACT    USAGE = 0%  ERRORS: 0 of 0
TLNP:   STATUS = ACT    USAGE = 0%  ERRORS: 0 of 0
PLNPQS:STATUS = ACT    USAGE = 0%  ERRORS: 0 of 0
ACG:   OVERLOAD LEVEL = 0  MIC USAGE = 0%
CPU USAGE = 5%

CARD  VERSION          PST          SST          AST
2317  -----          OOS-MT          Isolated    -----
ALARM STATUS          = ** 0013 Card is isolated from the system
GTT:  STATUS = -----  USAGE = 0%  ERRORS: 0 of 0
LNPMPR: STATUS = -----  USAGE = 0%  ERRORS: 0 of 0
LNPQS:  STATUS = -----  USAGE = 0%  ERRORS: 0 of 0
WNPQS:  STATUS = -----  USAGE = 0%  ERRORS: 0 of 0
TLNP:   STATUS = -----  USAGE = 0%  ERRORS: 0 of 0
PLNPQS:STATUS = -----  USAGE = 0%  ERRORS: 0 of 0
ACG:   OVERLOAD LEVEL = 0  MIC USAGE = 0%
CPU USAGE = 0%

CARD  VERSION          PST          SST          AST
1105  038-003-013     IS-NR          Active       DB_DIFF
ALARM STATUS          = ** 0451 RTDB reload is required
GTT:  STATUS = ACT      USAGE = 0%  ERRORS: 0 of 0
LNPMPR: STATUS = ACT    USAGE = 0%  ERRORS: 0 of 0
LNPQS:  STATUS = ACT    USAGE = 1%  ERRORS: 0 of 1003
WNPQS:  STATUS = ACT    USAGE = 0%  ERRORS: 0 of 0
TLNP:   STATUS = ACT    USAGE = 0%  ERRORS: 0 of 0
PLNPQS:STATUS = ACT    USAGE = 0%  ERRORS: 0 of 0
ACG:   OVERLOAD LEVEL = 0  MIC USAGE = 0%
CPU USAGE = 7%

```

Command Completed.

;

In the following example, an LNP feature (LNP ported TNs) quantity greater than 120 million numbers is enabled, the WNP, PLNP and TLNP features are on, and the LRNQT feature is off.

**rept-stat-lnp**

```

Integrat40 08-11-14 10:37:22 EST EAGLE5 40.0.0
LNP SUBSYSTEM REPORT IS-ANR Active -----
ASSUMING MATE'S LOAD
ALARM STATUS = No Alarms.

LNP Cards Configured= 5
CARD PST SST GTT STATUS LNP STATUS CPU USAGE
1106 IS-NR Active ACT ACT 23%
1201 IS-ANR Standby SWDL SWDL 0%
1205 OOS-MT-DSBLD Manual ----- 0%
1302 OOS-MT FLT ----- 0%
1310 IS-ANR Standby ACT SWDL 0%

LNPQS:
SSN STATUS = Allowed MATE SSN STATUS = Prohibited
ACG: OVERLOAD LEVEL = 0 MIC USAGE = 100%

AVERAGE USAGE:
GTT = 13% LNPMT = 0% LNPQS = 0%
WNPQS = 0% TLNP = 10% PLNPQS = 0%
AVERAGE CPU USAGE = 23%

TOTAL ERRORS:
GTT: 1 out of 2000
LNPMT: 0 out of 0
LNPQS: 0 out of 0
WNPQS: 0 out of 0
PLNPQS: 0 out of 0
TLNP: 1 out of 500

PROVISIONED TABLE QTY:
TN: 76800000 of 96000000 ( 80%)
NPA: 135000 of 150000 ( 90%)
LRN: 90000 of 100000 ( 90%)
    
```

Command Completed.

;

In the following example, the WNP, PLNP, TLNP, and LRNQT features are on.

**rept-stat-lnp**

```

rlghncxa03w 08-10-01 08:50:14 EST EAGLE 40.0.0
LNP SUBSYSTEM REPORT IS-ANR Active -----
ASSUMING MATE'S LOAD
LNP Cards Configured= 5
CARD PST SST GTT STATUS LNP STATUS CPU USAGE
1106 IS-NR Active ACT ACT 28%
1201 IS-ANR Standby SWDL SWDL 0%
1205 OOS-MT-DSBLD Manual ----- 0%
1302 OOS-MT Fault ----- 0%
1310 IS-ANR Standby ACT SWDL 0%

LNPQS:
SSN STATUS = Allowed MATE SSN STATUS = Prohibited
ACG: OVERLOAD LEVEL = 0 MIC USAGE = 100%

AVERAGE USAGE:
GTT = 13% LNPMT = 0% LNPQS = 0%
WNPQS = 0% TLNP = 10% PLNPQS = 0%
LRNQT = 5%

AVERAGE CPU USAGE = 28%
TOTAL ERRORS:
    
```

```

GTT:          1 out of    2000
LNPMR:        0 out of      0
LNPQS:        1 out of    500
WNPQS:        0 out of      0
PLNPQS:       0 out of      0
TLNP:         1 out of    500
LRNQT:        0 out of    700
Command Completed.

```

;

In the following example, the WNP, PLNP, TLNP, and LRNQT features are on.

#### rept-stat-lnp:loc=1106

```

rlghncxa03w 08-10-01 10:37:22 EST EAGLE 40.0.0
CARD VERSION TYPE PST SST AST
1106 021-101-000 TSM IS-NR Active -----
ALARM STATUS = No Alarms.
GTT: STATUS = ACT USAGE = 10% ERRORS: 1 out of 1000
LNPMR: STATUS = ACT USAGE = 13% ERRORS: 0 out of 1300
LNPQS: STATUS = ACT USAGE = 20% ERRORS: 1 out of 2000
WNPQS: STATUS = ACT USAGE = 0% ERRORS: 0 out of 0
PLNPQS: STATUS = ACT USAGE = 0% ERRORS: 0 out of 0
TLNP: STATUS = ACT USAGE = 0% ERRORS: 0 out of 0
LRNQT: STATUS = ACT USAGE = 0% ERRORS: 0 out of 0
ACG: OVERLOAD LEVEL = 0 MIC USAGE = 100%
CPU USAGE = 43%
Command Completed.

```

;

#### Legend

**CARD**—The locations of the SCCP cards.

**VERSION**—The version number of the GPL the cards are running.

**TYPE**—The type of SCCP card.

**PST**—The primary state of the card. The possible values are described in "Possible Values for PST/SST/AST" in Appendix A.

**SST**—The secondary state of the card. The possible values are described in "Possible Values for PST/SST/AST" in Appendix A.

**AST**—The associated state of the card. The possible values are described in in Appendix A.

## rept-stat-ls

### Report Status Linkset

Use this command to generate a report of the status of the MTP linksets. When a specific linkset is requested, the output displays a list of the links in the linkset and their secondary status. Output is generated for each of the 16 signaling link codes (SLC).

**NOTE: If the Multiple Linksets to Single Adjacent Point Code (MLS) feature is turned on, and an adjacent destination point code is requested, then the output displays a summary status, including the secondary point codes, of the linksets that use that adjacent point code.**

**Keyword:** rept-stat-ls

**Related Commands:** chg-ls, dlt-ls, ent-ls, rtrv-ls

**Command Class:** System Maintenance

#### Parameters

**:apc=** (optional)

ANSI point code with subfields *network indicator-network cluster-network cluster member (ni-nc-ncm)*. The prefix subfield indicates a private point code (*prefix-ni-nc-ncm*).



**Range: p-, 000-255**

Specify a valid value for each subfield of the point code, and separate the subfields with a dash (-).

*prefix*—**p-**

When **chg-sid:pctype=ansi** is specified, *ni* = **000** is not valid.

When **chg-sid:pctype=ansi** is specified, *nc* = **000** is not valid if *ni* = **001-005**.

When **chg-sid:pctype=ansi** is specified, *nc* = **000** is valid if *ni* = **006-255**.

The point code **000-000-000** is not a valid point code.

**:apc/apca/apci/apcn/apcn24=** (optional)

Adjacent point code.

**:apci=** (optional)

ITU international point code with subfields *zone-area-id*. The prefix subfield indicates a spare point code, private point code, or private and spare point code (*prefix-zone-area-id*).

**Range: s-, p-, ps-, 0-255**

Specify a valid value for each subfield of the point code, and separate the subfields with a dash (-).

*prefix*—**s-, p-, ps-**

*zone*—**0-7**

*area*—**000-255**

*id*—**0-7**

The point code **0-000-0** is not a valid point code.

**:apcn=** (optional)

ITU national point code in the format of a 5-digit number (*nnnnn*); or 2, 3, or 4 numbers (*members*) separated by dashes (*m1-m2-m3-m4*) as defined by the **chg-stpopts:npcfmti** flexible point code option. A group code must be specified when the ITUDUPPC feature is turned on (*nnnnn-gc*, *m1-m2-m3-m4-gc*). The prefix subfield indicates a spare point code, private point code, or private and spare point code (*prefix-nnnnn*, *prefix-nnnnn-gc*, *prefix-m1-m2-m3-m4*, *prefix-m1-m2-m3-m4-gc*).

**Range: s-, p-, ps-, 0-16383, aa-zz**

Specify a valid value for each subfield of the point code, and separate the subfields with a dash (-).

*prefix*—**s-, p-, ps-**

*nnnnn*—**0-16383**

*gc*—**aa-zz**

*m1-m2-m3-m4*—**0-14** for each member; values must sum to 14

**:apcn24=** (optional)

24-bit ITU national point code with subfields *main signaling area-sub signaling area-signaling point* (*msa-ssa-sp*). The prefix indicates a private point code (*prefix-msa-ssa-sp*).

**Range: p-, 000-255**

Specify a valid value for each subfield of the point code, and separate the subfields with a dash (-).

*prefix*—**p-**

*msa*—**000-255**

*ssa*—**000-255**

*sp*—**000-255**

**:lsn=** (optional)

Linkset name. The name of the linkset for which the report information is to be displayed.

**Range:** *ayyyyyyyy*

1 alphabetic character followed by up to 9 alphanumeric characters

**Default:** All linksets are displayed

**:stat=** (optional)

The primary state filter. This parameter indicates the state of the linksets for which a report will be displayed. For example, to display a report for all linksets whose state is DSBLD, specify the **stat=dsbld** parameter.

**Range:** **all**, **alminh**, **anr**, **dsbld**, **mt**, **nr**

**all** — All of the primary states

**alminh** — Alarms inhibited

**anr** — In-Service-Abnormal (IS-ANR)

**dsbld** — Out-of-Service-Maintenance-Disabled (OOS-MT-DSBLD)

**mt** — Out-of-Service-Maintenance (OOS-MT)

**nr** — In-Service-Normal (IS-NR)

**Default:** **all**

**Example**

```
rept-stat-ls
```

```
rept-stat-ls:lsn=lsnstpa
```

**Dependencies**

No other **rept-stat-xxx** command can be in progress when this command is entered.

The linkset specified by the **lsn** parameter must be equipped in the database.

If the **stat** parameter is specified, then the **lsn** parameter cannot be specified and vice versa.

The Multiple Linksets to a Single Adjacent Point Code (MLS) feature must be turned on before the **apc** parameter can be specified.

The **lsn**, **stat**, and **apc** parameters cannot be specified together in the command.

At least one linkset must be associated with the value of the **apc** parameter.

**Notes**

This command can be canceled using the **F9** function key or the **canc-cmd** command. See **canc-cmd** for more information.

If no link is equipped for the SLC, the output is “\_\_,\_ UEQ.”

In this command, only ITU-international and ITU national point codes support the spare point code subtype prefix (**s-**) and the private and spare point code subtype prefix (**ps-**). All of the point code types support the private (internal) point code subtype prefix (**p-**).

"ASP-STATE" is shown for only IPSP-M3UA linksets.

**Output**

If the Proxy Point Code feature is enabled, then proxy point code information is displayed.

**rept-stat-ls**

```
eagle10207 08-02-23 10:09:59 EST EAGLE 38.0.0
LSN          APCA          PST          SST          AST
ls11234567   001-001-002     OOS-MT      Prohibit     GWS
ls11345678   001-001-003     OOS-MT      Prohibit     -----
ls11345679   001-001-004     OOS-MT      Idle         -----
ls1134567     001-001-005     OOS-MT      Prohibit     -----
ls113456      001-001-006     OOS-MT      Prohibit     -----
ls11345       001-001-007     OOS-MT      Prohibit     GWS
ls113467     001-001-008     OOS-MT      Prohibit     -----
ls1134       001-001-009     OOS-MT      Prohibit     -----
ls987        009-008-007     OOS-MT      Idle         -----
z            009-008-009     OOS-MT      Idle         -----
cap8         008-008-008     OOS-MT      Idle         -----

LSN          APCN          PST          SST          AST
lsnational   16383-aa        OOS-MT      Idle         -----

LSN          APCN24        PST          SST          AST

LSN          APCI          PST          SST          AST
Command Completed.
```

;

The following example includes output for a specific linkset when either the MLS feature is not turned on or when the linkset is not created with a secondary point code.

**rept-stat-ls:lsn=lsnstopa**

```
eagle10207 08-02-23 10:09:59 EST EAGLE 38.0.0

LSN          APCA          PST          SST          AST
lsnstopa     110-15-08     IS-NR      Allowed     -----
  SPCA = -----
  ALARM STATUS = No Alarms.
  SCRSET = ----
  GWSA = ----
  GWSM = ----
  GWSD = ----
  SLC SLK    SST          SLC SLK    SST
  0  1207,A Avail      8  ----,-  UEQ
  1  1203,A Avail      9  ----,-  UEQ
  2  1103,B LPBK       10 ----,-  UEQ
  3  ----,-  UEQ       11 ----,-  UEQ
  4  ----,-  UEQ       12 ----,-  UEQ
  5  ----,-  UEQ       13 ----,-  UEQ
  6  ----,-  UEQ       14 ----,-  UEQ
  7  ----,-  UEQ       15 ----,-  UEQ
Command Completed.
```

;

The following example includes output for linksets that contain spare and private adjacent point codes.

**rept-stat-ls**

```
tekelecstp 02-03-20 21:22:04 EST EAGLE 31.12.0
LSN          APCA          PST          SST          AST
ls11234567   001-001-002     OOS-MT      Prohibit     GWS
ls11345678   001-001-003     OOS-MT      Prohibit     -----
ls11345679   001-001-004     OOS-MT      Idle         -----
ls1134567     001-001-005     OOS-MT      Prohibit     -----
ls113456      001-001-006     OOS-MT      Prohibit     -----
ls11345       p-001-001-007   OOS-MT      Prohibit     GWS
```

```

ls113467      001-001-008      OOS-MT      Prohibit  -----
ls1134       p-001-001-009      OOS-MT      Prohibit  -----
ls987        009-008-007      OOS-MT      Idle      -----
z           009-008-009      OOS-MT      Idle      -----
cap8        008-008-008      OOS-MT      Idle      -----

LSN          APCN          PST          SST          AST
lsnational  s-09-14-05-3-ab  OOS-MT      Idle      -----

LSN          APCN24         PST          SST          AST

LSN          APCI          PST          SST          AST
Command Completed.

```

;

The following example includes output for a specific linkset when the Multiple Linksets to a Single Adjacent Point Code (MLS) feature is turned on, and the linkset is created with a secondary point code.

**rept-stat-ls:lsn=lsnstpa**

```

eagle10207 08-02-23 10:09:59 EST EAGLE 38.0.0
LSN        APCA          PST          SST          AST
lsnstpa    110-15-08      IS-NR          Allowed  -----
SPCA =     120-10-01
ALARM STATUS = No Alarms.
SCRSET = ----
GWSA = ----
GWSM = ----
GWSD = ----
SLC SLK    SST          SLC SLK    SST
0  1207,A Avail      8  -----,- UEQ
1  1203,A Avail      9  -----,- UEQ
2  1103,B LPBK       10 -----,- UEQ
3  -----,- UEQ      11 -----,- UEQ
4  -----,- UEQ      12 -----,- UEQ
5  -----,- UEQ      13 -----,- UEQ
6  -----,- UEQ      14 -----,- UEQ
7  -----,- UEQ      15 -----,- UEQ
Command Completed.

```

;

The following example includes output when the MLS feature turned on, and information is requested for a specific adjacent destination point code.

**rept-stat-ls:apc=1-1-2**

```

eagle10207 07-07-23 10:09:59 EST EAGLE 37.5.0

APCA =     001-001-002
LSN        SPCA          PST          SST          AST
ls11234567 001-005-003      OOS-MT      Prohibit  GWS
ls11345678 004-008-002      OOS-MT      Prohibit  -----
ls113456   014-012-094  OOS-MT      Prohibit  -----
Command Completed.

```

;

The following example includes output that demonstrates the possible duplication of adjacent point code values when the MLS feature is turned on.

**rept-stat-ls**

```

eagle10207 07-07-23 10:09:59 EST EAGLE 37.5.0

LSN        APCA          PST          SST          AST
ls11234567 001-001-002      OOS-MT      Prohibit  GWS
ls11345678 001-001-002      OOS-MT      Prohibit  -----
ls11345679 001-001-004      OOS-MT      Idle      -----
ls1134567  001-001-005      OOS-MT      Prohibit  -----
ls113456   001-001-002      OOS-MT      Prohibit  -----
ls11345   p-001-001-007  OOS-MT      Prohibit  GWS

```

```

ls113467      001-001-008  OOS-MT      Prohibit  -----
ls1134       p-001-001-009  OOS-MT      Prohibit  -----
ls987        009-008-007   OOS-MT      Idle      -----
z            009-008-009   OOS-MT      Idle      -----
cap8         008-008-008   OOS-MT      Idle      -----
LSN          APCN          PST         SST        AST
lsnational  s-09-14-05-3-ab OOS-MT      Idle      -----
LSN          APCN24        PST         SST        AST
LSN          APCI          PST         SST        AST
    
```

The following example displays information of a specified linkset when the Proxy Point Code feature is enabled.

**rept-stat-ls:lsn=lsnstpa**

```

tekelecstp 08-02-29 11:05:47 EST  EAGLE 38.0.0

LSN          APCA          PST          SST          AST
lsnstpa      110-15-08      IS-NR        Allowed      -----
  PPCA      =      100-12-04
  ALARM STATUS      = No Alarms.
  SCRSET      = ----
  GWSA        = ----
  GWSM        = ----
  GWSD        = ----
  SLC SLK      SST          SLC SLK      SST
  0  1207,A  Avail          8  ----,-  UEQ
  1  1203,A  Avail          9  ----,-  UEQ
  2  1103,B  LPBK          10 ----,-  UEQ
  3  ----,-  UEQ          11 ----,-  UEQ
  4  ----,-  UEQ          12 ----,-  UEQ
  5  ----,-  UEQ          13 ----,-  UEQ
  6  ----,-  UEQ          14 ----,-  UEQ
  7  ----,-  UEQ          15 ----,-  UEQ
    
```

;

The following example displays proxy linksets using a specified adjacent point code. The MLS feature must be turned on in order to retrieve information for an adjacent point code.

**rept-stat-ls:apc=1-1-2**

```

tekelecstp 07-03-29 11:05:47 EST  EAGLE 37.5.0

APCA      =      001-001-002
LSN          PPCA          PST          SST          AST
ls11234567  001-005-003  OOS-MT      Prohibit  GWS
ls11345678  004-008-002  OOS-MT      Prohibit  -----
ls113456    014-012-094  OOS-MT      Prohibit  -----
    
```

;

The following command shows the ASP state for IPSPG-M3UA linksets state when the linkset is specified.

**rept-stat-ls:lsn=ls1305a**

```

tekelecstp 08-01-29 18:15:20 EST  EAGLE 38.0.0
LSN          APCA          PST          SST          AST
ls1305a      005-213-000  IS-NR        Allowed      -----
  SPCA      = -----
  ALARM STATUS      = No Alarms.
  SCRSET      = ----
  GWSA        = ----
  GWSM        = ----
  GWSD        = ----
  SLC SLK      SST          ASP STATE  SLC SLK      SST          ASP STATE
  0  1305,A  Avail          ACTIVE      8  ----,-  UEQ          -----
  1  1305,A1 Unavail      DOWN        9  ----,-  UEQ          -----
  2  ----,-  UEQ          -----    10 ----,-  UEQ          -----
  3  ----,-  UEQ          -----    11 ----,-  UEQ          -----
    
```

```

4  ----,--- UEQ      -----  12  ----,--- UEQ      -----
5  ----,--- UEQ      -----  13  ----,--- UEQ      -----
6  ----,--- UEQ      -----  14  ----,--- UEQ      -----
7  ----,--- UEQ      -----  15  ----,--- UEQ      -----

```

Command Completed.

;

### Legend

**LSN**—The name of the linkset

**APCA/APCI/APCN/APCN24**—The adjacent point code of the linkset (ANSI, ITU-I, ITU-N, ITU-N 24-bit)

**SPCA/SPCI/SPCN/SPCN24**—The secondary point code of the linkset (ANSI, ITU-I, ITU-N, ITU-N 24-bit)

**PST**—The primary state of the linkset. The possible values are described in "Possible Values for PST/SST/AST".

**SST**—The secondary state of the linkset. The possible values are described in "Possible Values for PST/SST/AST".

**AST**—The associated state of the linkset. The possible values are described in "Possible Values for PST/SST/AST".

**ALARM STATUS**—A listing of any trouble text alarm messages that have been generated for the specified card.

**SCRN**—The name of the gateway screening screen set associated with the linkset.

**GWSA**—Shows whether gateway screening is used for the specified linkset.

**GWSM**—Shows whether gateway screening messaging is turned on for the specified linkset.

**GWSD**—Shows whether the discarding of MSUs that bypass the gateway screening function due to load-shedding is turned on.

**SLC**—The signaling link codes associated with the links that are contained in the specified linkset.

**SLK**—The signaling links that are contained in the linkset, shown by the card location containing the signaling link and the port on the card containing the signaling link.

**PPCA/PPCI/PPCN/PPCN24**—The proxy point code of the linkset (ANSI, ITU-I, ITU-N, ITU-N 24-bit)

**ASP STATE**—The state of AS associated with each signaling link of the IPSG-M3UA linkset. The states displayed are: ACTIVE, INACTIVE, or DOWN.

## rept-stat-meas

## Report Measurement Status

Use this command to report the status of the Measurements Subsystem (Measurements Platform), including card location and state, alarm level, and subsystem state.

**Keyword:** `rept-stat-meas`

**Related Commands:** `rept-stat-card`

**Command Class:** System Maintenance

### Parameters

This command has no parameters.

### Example

```
rept-stat-meas
```

**Dependencies**

The Measurements Platform feature must be turned on prior to issuing this command.

At least one MCPM card must be configured in the system.

No other **rept-stat-xxx** commands can be in progress when this command is issued.

**Notes**

The MCPM card status is independent of the IP Network Link status (Port A). The card can be IS-NR even if the network link has failed.

The version of the GPL is shown in the command output if the MCPM card is in the IS-NR or IS-ANR state. (The **rept-stat-card** command will not show the GPL version if the card is ISANR.)

**Output**

Output example with one MCP card isolated:

**rept-stat-meas**

```

MEAS SS          PST          SST          AST
IS-ANR          Active      -----
ALARM STATUS =  * 0516 Degraded Mode - 1 card failed

CARD  VERSION    TYPE    PST          SST          AST
1107 P 101-009-000  EDSM    IS-NR        Active      -----
   IP Link A          IS-NR        Active      -----
1109 -----      EDSM    OOS-MT       Isolated    -----
   IP Link A          OOS-MT       Unavail     -----

CARD 1107 ALARM STATUS = No Alarms
CARD 1109 ALARM STATUS = Card is isolated from the system
Command Completed.

```

;

Output example with both MCP cards IS-NR:

**rept-stat-meas**

```

MEAS SS          PST          SST          AST
IS-NR          Active      -----
ALARM STATUS =  No Alarms

CARD  VERSION    TYPE    PST          SST          AST
1107 P 046-010-004  EDSM    IS-NR        Active      -----
   IP Link A          IS-NR        Active      -----
1109 046-010-004  EDSM    IS-NR        Active      -----
   IP Link A          OOS-MT       Unavail     -----

CARD 1105 ALARM STATUS = No Alarms
CARD 1106 ALARM STATUS = No Alarms

Command Completed.

```

;

**Legend**

**VERSION**—The version number of the GPL that the specified MCPM card is running. The version is shown if the card is in the IS-NR or IS-ANR state.

**TYPE**—EDSM; the MCPM card that is running the Measurements Subsystem application.

**PST**—The primary state of the Measurements Subsystem or card. The possible values are described in "Possible Values for PST/SST/AST".

**SST**—The secondary state of the Measurements Subsystem or card. The possible values are described in "Possible Values for PST/SST/AST".

**AST**—The associated state of the Measurements Subsystem or card. The possible values are described in .

**MEAS SS**—The Measurements Subsystem application running on the MCPM card.

**ALARM STATUS**—A listing of any trouble text alarm messages that have been generated for the MCPM card and the applications running on the card.

**CARD**—The location of the MCPM card. The card with the letter "P" to the right of its card location is the primary card. The primary card transfers scheduled measurements report files to the primary FTP server. When the primary state (PST) of the card is IS-NR, the secondary state (SST) indicates whether the card is active or standby.



**CARD XXXX ALARM STATUS**—A listing of any trouble text alarm messages that have been generated for the card.

## rept-stat-mon

## Report Status Monitoring System

Use this command to display the status of the Fast Copy subsystem on FC-capable cards and the EROUTE subsystem on STC cards and E5-STC cards for the EAGLE 5 Integrated Monitoring Support (E5IS) feature.

**Keyword:** `rept-stat-mon`

**Related Commands:**

**Command Class:** System Maintenance

### Parameters

**:loc=** (optional)

Card location. This parameter specifies the card location that is stenciled on the shelf for an STC or E5-STC card or an FC-capable card in the system.

**Range:** 1101-1108, 1111-1112, 1201-1208, 1211-1218, 1301-1308, 1311-1318, 2101-2108, 2111-2118, 2201-2208, 2211-2218, 2301-2308, 2311-2318, 3101-3108, 3111-3118, 3201-3208, 3211-3218, 3301-3308, 3311-3318, 4101-4108, 4111-4118, 4201-4208, 4211-4218, 4301-4308, 4311-4318, 5101-5108, 5111-5118, 5201-5208, 5211-5218, 5301-5308, 5311-5318, 6101-6108, 6111-6118

**Default:** Status for all STC and FC-capable cards is reported.

**:mode=** (optional)

This parameter specifies the mode of reporting for the command.

If the **mode=perf** parameter is specified, then only subsystem performance information is displayed.

**Range:** `perf`

**:type=** (optional)

Monitoring subsystem type. This parameter specifies the type of the subsystem for which the monitoring statistics are displayed.

**Range:** `fcs`, `eroute`

`fcs` — Display the statistics for the Fast Copy subsystem

`eroute` — Display the statistics for the EROUTE subsystem

**Default:** Display the statistics for both the EROUTE and FC subsystems

### Example

```
rept-stat-mon
rept-stat-mon:type=eroute
rept-stat-mon:type=fcs
rept-stat-mon:type=eroute:loc=1101
rept-stat-mon:type=fcs:loc=1104
rept-stat-mon:type=eroute:mode=perf
```

### Dependencies

No other **rept-stat-xxx** command can be in progress when this command is entered.

At least one STC card must be configured before this command can be entered.

At least one FC-capable card must be provisioned in the system before the **type=fcs** parameter can be specified.

The **loc** and **mode** parameters cannot be specified together in the command.

The **type=eroute** parameter must be specified before the **mode** parameter can be specified.

If the **loc** or **mode** parameters are specified, then the **type** parameter must be specified.

Either an STC card or an FC-capable card must be provisioned in the system.

An FC-capable card must be provisioned in the system before the **type=fcs** parameter can be specified. An STC card must be provisioned in the system before the **type=eroute** parameter can be specified.

## Notes

### *Fast Copy Cards*

A card that can run the Fast Copy interface is referred to as an *FC-capable* card. Currently, E5-ENET cards running the **ipsg** application are the only supported FC-capable cards. After the **fcmode=fcopy** parameter is specified (see the **chg-eisopts** command) for an FC-capable card, the card is referred to as an *FC-enabled* card.

**Output**

The following example displays card- and system-level information for the Fast Copy and EROUTE subsystems.

**rept-stat-mon**

```

rlghncxa03w 09-09-11 16:35:57 IST EAGLE 41.1.0
EROUTE SUBSYSTEM REPORT IS-NR Active -----
STC Cards Configured= 4 Cards IS-NR= 2
EISCOPY BIT = ON
System Threshold = 80% Total Capacity
System Peak EROUTE Load: 7080 Buffers/Sec
System Total EROUTE Capacity: 12000 Buffers/Sec

SYSTEM ALARM STATUS = No Alarms.

CARD VERSION PST SST AST TVG CPU
USAGE USAGE
-----
1101 052-008-000 IS-NR Active ----- 63% 28%
1103 052-008-001 IS-NR Active ----- 55% 28%
1105 255-255-255 OOS-MT Isolated ----- 0% 0%
1205 255-255-255 OOS-MT Isolated ----- 0% 0%
-----
EROUTE Service Average TVG Capacity = 59% Average CPU Capacity = 28%

CARDS DENIED EROUTE SERVICE:

=====

FAST COPY SUBSYSTEM REPORT IS-NR Active -----
FC Cards Configured= 3 Cards IS-NR= 3
FC MODE = FCOPY
SYSTEM ALARM STATUS = No Alarms.

CARD PST SST CPU CARD FCS
-----
1201 IS-NR Active 34% ALLOWED
1202 IS-NR Active 55% ALLOWED
1203 IS-NR Active 10% ALLOWED
-----

Command Completed.
;

```

The following example displays card- and system-level information for the EROUTE subsystem.

**rept-stat-mon:type=eroute**

```

rlghncxa03w 08-12-11 16:35:57 IST EAGLE 40.1.0
EROUTE SUBSYSTEM REPORT IS-NR Active -----
STC Cards Configured= 4 Cards IS-NR= 2
EISCOPY BIT = ON
System Threshold = 80% Total Capacity
System Peak EROUTE Load: 7080 Buffers/Sec
System Total EROUTE Capacity: 12000 Buffers/Sec

SYSTEM ALARM STATUS = No Alarms.

CARD VERSION PST SST AST TVG CPU
USAGE USAGE
-----
1101 052-008-000 IS-NR Active ----- 63% 28%
1103 052-008-001 IS-NR Active ----- 55% 28%
1203 255-255-255 OOS-MT Isolated ----- 0% 0%
1205 255-255-255 OOS-MT Isolated ----- 0% 0%
-----

```

EROUTE Service Average TVG Capacity = 59% Average CPU Capacity = 28%

CARDS DENIED EROUTE SERVICE:

Command Completed.

;

The following example displays card- and system-level information for the Fast Copy subsystem.

**rept-stat-mon:type=fcs**

```
rlghncxa03w 09-09-11 16:35:57 IST EAGLE 41.1.0
FAST COPY SUBSYSTEM REPORT IS-NR Active -----
FC Cards Configured= 3 Cards IS-NR= 3
FC MODE = FCOPY
SYSTEM ALARM STATUS = No Alarms.
```

| CARD | PST   | SST    | CPU | CARD FCS |
|------|-------|--------|-----|----------|
| 1201 | IS-NR | Active | 34% | ALLOWED  |
| 1202 | IS-NR | Active | 55% | ALLOWED  |
| 1203 | IS-NR | Active | 10% | ALLOWED  |

Command Completed.

;

The following example displays EROUTE subsystem information for the specified card.

**rept-stat-mon:type=eroute:loc=1101**

```
rlghncxa03w 08-12-11 16:35:57 IST EAGLE 40.1.0
CARD VERSION TYPE PST SST AST
1101 052-008-000 STC IS-NR Active -----
CARD ALARM STATUS = No Alarms.
TOTAL CPU USAGE = 28%
NTP broadcast = VALID
STC IP PORT A: IS-NR Active -----
ALARM STATUS = No Alarms.
STC IP PORT B: OOS-MT Unavail -----
ALARM STATUS = ** 0084 IP Connection Unavailable
ERROR STATUS = DHCP Lease. Physical Link.
```

Command Completed.

;

The following example displays Fast Copy subsystem information for the specified card.

(A) or (B) in the IMF CONNECTION STATUS TABLE indicates the Fast Copy A or Fast Copy B network, respectively.

**rept-stat-mon:type=fcs:loc=1104**

```
rlghncxa03w 09-09-11 16:35:57 IST EAGLE 41.1.0
CARD PST SST CPU CARD FCS
1203 IS-NR Active 10% ALLOWED
ALARM STATUS = No Alarms.

FCS IP PORT A1: IS-NR Active -----
ALARM STATUS = No Alarms.
FCS IP PORT B1: IS-NR Active -----
ALARM STATUS = No Alarms.
```

IMF CONNECTION STATUS TABLE

| IPADDRESS     | ALM ID  | ASSOC NAME | PKT CNT | SERVICE MODE |
|---------------|---------|------------|---------|--------------|
| 172.021.48.15 | (A) 582 | sg1203a21  | 100     | Copy Rx MSUs |
| 172.022.48.15 | (B) 582 | sg1203a22  | 200     | Copy Tx MSUs |

PORT ALARM STATUS

```
-----
PORT ID ALARM ID REASON
-----
A      583      Mismatched Fast Copy Network Addresses
```

Command Completed.

;

The following example displays EROUTE subsystem performance statistics.

**rept-stat-mon:type=eroute:mode=perf**

```
rlghncxa03w 08-12-11 16:35:57 IST EAGLE 40.1.0
EROUTE SUBSYSTEM REPORT IS-ANR Ovrflw=1 -----
STC Cards Configured= 2 Cards IS-NR= 2
EISCOPY BIT = ON
System Threshold = 80% Total Capacity
System Peak EROUTE Load: 12200 Buffers/Sec
System Total EROUTE Capacity: 12000 Buffers/Sec

SYSTEM ALARM STATUS = * 0482 Card(s) have been denied EROUTE service
```

STATISTICS

```
=====
CARD CPU USAGE TVG RATE
-----
1104 55% 6200
1112 50% 6000
-----
```

```
AVERAGE TVG Capacity = 80%
AVERAGE CPU USAGE = 27%
TOTAL TVG RATE = 12200
```

CARDS DENIED EROUTE SERVICE: 1302, 1305

Command Completed.

;

The following example displays output when FC-capable cards are configured, and the Fast Copy mode is turned off.

**rept-stat-mon:type=fcs**

```
rlghncxa03w 09-09-11 16:35:57 IST EAGLE 41.1.0
FAST COPY SUBSYSTEM REPORT OOS-MA Ueq -----
FC Cards Configured= 2 Cards IS-NR= 2
FC MODE = OFF
SYSTEM ALARM STATUS = No Alarms.
```

```
CARD PST SST CPU CARD FCS
-----
1105 IS-NR Active 10% OFFLINE
1106 IS-NR Active 15% OFFLINE
-----
```

Command Completed.

;

The following example displays card- and system-level information when the Fast Copy subsystem is in the OOS-MT/Uavail state.

**rept-stat-mon:type=fcs**

```
rlghncxa03w 09-09-11 16:35:57 IST EAGLE 41.1.0
FAST COPY SUBSYSTEM REPORT OOS-MT Unavail -----
FC Cards Configured= 2 Cards IS-NR= 2
FC MODE = FCOPY
SYSTEM ALARM STATUS = * 0597 FC System is Deactivated
```

```
CARD PST SST CPU CARD FCS
-----
```

```

1105 IS-NR      Active      12%   DEACTIVATED
1106 IS-NR      Active      10%   DEACTIVATED
-----

```

Command Completed.

The following example displays Fast Copy subsystem information for the specified card when the card is in a DEACTIVATED state.

**rept-stat-mon:type=fcs:loc=1105**

```

rlghncxa03w 09-09-11 16:35:57 IST  EAGLE 41.1.0
CARD PST      SST          CPU   CARD FCS      REASON
1105 IS-NR      Active      12%   DEACTIVATED  CPU Thrshld Exceeded
ALARM STATUS = ** 0590 Fast Copy Application De-activated

FCS IP PORT A1:      IS-ANR      Restrict  -----
ALARM STATUS = ** 0588 FC Port De-activated
FCS IP PORT B1:      IS-ANR      Restrict  -----
ALARM STATUS = ** 0588 FC Port De-activated

```

IMF CONNECTION STATUS TABLE

```

-----
IPADDRESS          ALM ID  ASSOC NAME      PKT CNT      SERVICE MODE
-----
172.021.48.15    (A) 582    sg1203a21      100          Copy Rx MSUs
172.022.48.15    (B) 582    sg1203a22      200          Copy Tx MSUs

```

PORT ALARM STATUS

```

-----
PORT ID ALARM ID  REASON
-----

```

Command Completed.

**Legend**

Information displayed in the EROUTE subsystem report:

- **STC CARDS CONFIGURED**—Total number of STC cards and E5-STC cards configured in the system
- **CARDS IS-NR**—Total number of STC cards and E5-STC cards in IS-NR state
- **EISCOPY BIT**—Indicates whether EIS copy function is turned On or Off
- **SYSTEM THRESHOLD**—% of system total capacity being used
- **SYSTEM PEAK EROUTE LOAD**—Current load in Buffers/Sec
- **SYSTEM TOTAL EROUTE CAPACITY**—Total capacity in Buffers/Sec
- **SYSTEM ALARM STATUS**—Either "No Alarms" or current alarm number and text
- **CARD**—Card location
- **VERSION**—The version number of the GPL loaded on the card. Dashes ( - - - - ) in the version column indicate one of the following conditions about the card:
  - The card does not run a GPL, such as TDM or MDAL cards.
  - The card is configured but is not physically present in the system.
  - The card is IS-ANR or is in the process of being loaded.
- **TYPE**—The card type entered in the database.

- **PST**—The primary state of the card. The possible values are described in "Possible Values for PST/SST/AST"
- **SST**—The secondary state of the card. The possible values are described in "Possible Values for PST/SST/AST".
- **AST**—The associated state of the card. The possible values are described in "Possible Values for PST/SST/AST".
- **EROUTE SERVICE AVERAGE TVG CAPACITY**—Average TVG Capacity in percent.
- **AVERAGE CPU CAPACITY**—Average CPU capacity in percent.
- **TVG USAGE**—% of system current TVG rate based on the Max TVG capacity of the E5-ENET card
- **CPU USAGE**—% of system current CPU usage
- **STC IP PORT**—The status of the STC IP ports A and B

Information displayed in the Fast Copy subsystem report:

- **FC CARDS CONFIGURED**—The total number of FC-capable cards configured in the system.
- **CARDS IS-NR**—Total number of FC-capable cards in IS-NR state
- **FCMODE**—Indicates the monitoring mode
- **SYSTEM ALARM STATUS**—Either "No Alarms" or current alarm number and text
- **CARD**—Card location
- **PST**—The primary state of the card. The possible values are described in "Possible Values for PST/SST/AST".
- **SST**—The secondary state of the card. The possible values are described in "Possible Values for PST/SST/AST".
- **CPU**—% of system current CPU usage
- **CARD FCS**—The status of FCS FC-capable card
- **REASON**—The Deactivation alarm reason on Card FCS. The possible values are "CPU Thrshld Exceeded" or "Auto-Neg Fails"
- **FCS IP PORT**—The status of the FCS IP ports A1 and B1
- **IPADDRESS**—The IP addresses of the IMF
- **ASSOC NAME**—Association name
- **PKT CNT**—Snapshot of packets received/sent per association
- **SERVICE MODE**—Indicate the type of service granted by the DAS to FC-enabled card

## rept-stat-mps

## Report the MPS Status

Use this command to display the overall status of the application running on the MPS (multi-purpose server).

- If the LNP ELAP Configuration feature is enabled and turned on, then the ELAP (EAGLE LNP Application Processor) subsystem status is displayed.

- If the INP/AINPQ feature is enabled and turned on, then the EPAP (EAGLE Provisioning Application Processor) subsystem status is displayed.
- If the G-Port (GSM mobile number portability), G-Flex (GSM flexible numbering), or PPSMS (Prepaid SMS Intercept Ph1) feature is enabled and turned on, then the GSM (Global System for Mobile Telecommunications) and EPAP status is displayed.
- If the EIR (Equipment Identity Register) feature is enabled and turned on, then the status of the EIR component on the card is displayed.
- If the V-Flex (Voice Mail Router) feature is enabled and turned on, then the status of the V-Flex component on the card is displayed.
- If the ATINP (ATI Number Portability Query) feature is enabled, then the status of the ATINPQ component on the card is displayed.

**Keyword:** `rept-stat-mps`

**Related Commands:** `rept-stat-card`, `rept-stat-sccp`

**Command Class:** System Maintenance

### Parameters

**:loc=** (optional)

The card location of the VSCCP card to be reported on, as stenciled on the shelf of the EAGLE 5 ISS.

**Range:** 1101-1108, 1111-1117, 1201-1208, 1211-1218, 1301-1308, 1311-1318, 2101-2108, 2111-2118, 2201-2208, 2211-2218, 2301-2308, 2311-2318, 3101-3108, 3111-3118, 3201-3208, 3211-3218, 3301-3308, 3311-3318, 4101-4108, 4111-4118, 4201-4208, 4211-4218, 4301-4308, 4311-4318, 5101-5108, 5111-5118, 5201-5208, 5211-5218, 5301-5308, 5311-5318, 6101-6108, 6111-6118

### Example

```
rept-stat-mps:loc=1106
```

### Dependencies

The card location specified in the **loc** parameter must contain a Service Module card.

One of the following features must be turned on, or the ATINP feature must be enabled before this command can be entered:

- A-Port
- AINPQ
- G-Flex
- G-Port
- INP
- EIR
- LNP ELAP Configuration
- Prepaid SMS Intercept Ph1
- V-Flex

At least one Service Module card must be configured in the system before this command can be entered.

To specify the **rept-stat-mps** command, no other **rept-stat-xxxx** command can be in progress.



**Notes**

When the MPS does not have an alarm on it, the **rept-stat-mps** report indicates in the SST field of the report which MPS is the active and which is the standby. When the MPS has an alarm on it, the SST field shows "Fault," and the Active/Standby information is displayed in the AST field as long as there is an alarm. After the alarm clears, the Active/Standby information appears in the SST field as before.

## Output

**NOTE: The status for a particular feature is shown only if that feature is enabled or turned on.**

The following example shows the possible system response if the LNP ELAP Configuration feature is turned on:

**rept-stat-mps**

```

rlghncxa03w 09-01-07 10:23:93 EST EAGLE 40.0.0
          VERSION      PST      SST      AST
ELAP A      027-015-000  OOS-MT      Fault      Standby
CRITICAL PLATFORM  ALARM DATA = No Alarms
MAJOR   PLATFORM  ALARM DATA = h'0123456789ABCDEF
MINOR   PLATFORM  ALARM DATA = h'0123456789ABCDEF
CRITICAL APPLICATION ALARM DATA = No Alarms
MAJOR   APPLICATION ALARM DATA = h'0123456789ABCDEF
MINOR   APPLICATION ALARM DATA = No Alarms
          ALARM STATUS = ** 0371 Major Platform Failure(s)

          VERSION      PST      SST      AST
ELAP B      027-015-000  OOS-MT      Fault      Active
CRITICAL PLATFORM  ALARM DATA = No Alarms
MAJOR   PLATFORM  ALARM DATA = No Alarms
MINOR   PLATFORM  ALARM DATA = No Alarms
CRITICAL APPLICATION ALARM DATA = h'0123456789ABCDEF
MAJOR   APPLICATION ALARM DATA = h'0123456789ABCDEF
MINOR   APPLICATION ALARM DATA = No Alarms
          ALARM STATUS = *C 0373 Critical Application Failure(s)

CARD  PST      SST      LNP STAT
1106 P IS-NR      Active    ACT
1201  IS-ANR      Active    SWDL
1205  OOS-MT-DSBLD Manual    -----
1302  OOS-MT      Isolated -----
1310  IS-ANR      Standby  SWDL

CARD 1106 ALARM STATUS = No Alarms
      DSM PORT A:  ALARM STATUS      = No Alarms
      DSM PORT B:  ALARM STATUS      = No Alarms
CARD 1201 ALARM STATUS = No Alarms
      DSM PORT A:  ALARM STATUS      = ** 0084 IP Connection Unavailable
      DSM PORT B:  ALARM STATUS      = ** 0084 IP Connection Unavailable
CARD 1205 ALARM STATUS = No Alarms
      DSM PORT A:  ALARM STATUS      = ** 0084 IP Connection Unavailable
      DSM PORT B:  ALARM STATUS      = ** 0084 IP Connection Unavailable
CARD 1302 ALARM STATUS = ** 0013 Card is isolated from the system
      DSM PORT A:  ALARM STATUS      = ** 0084 IP Connection Unavailable
      DSM PORT B:  ALARM STATUS      = ** 0084 IP Connection Unavailable
CARD 1310 ALARM STATUS = No Alarms
      DSM PORT A:  ALARM STATUS      = ** 0084 IP Connection Unavailable
      DSM PORT B:  ALARM STATUS      = ** 0084 IP Connection Unavailable
Command Completed.
;

```

The following example shows the possible system response when a specific card is queried, and the INP or AINP feature is turned on:

**rept-stat-mps:loc=1205**

```

rlghncxa03w 04-01-07 10:23:93 EST EAGLE 31.3.0
CARD  VERSION      TYPE      PST      SST      AST
1205  ----- DSM      OOS-MT-DSBLD Manual    -----
      DSM PORT A      OOS-MT      Unavail    -----
          ALARM STATUS      = ** 0084 IP Connection Unavailable
      DSM PORT B      OOS-MT      Unavail    -----

```

```

                ALARM STATUS      = ** 0084 IP Connection Unavailable
INP STAT      = -----
CARD ALARM STATUS = No Alarms.
DSM MEMORY USAGE = 0%
Command Completed.
;

```

The following example shows the possible system response when a specific card is queried, and the EIR feature and the G-Flex, G-Port, or PPSMS feature are turned on. This example also shows that DSM Port A has an IP Connection Unavailable alarm due to failed channels Dnld, TCP, and UDP. DSM Port B has an IP Connection Unavailable alarm due to failed channels Dnld and TCP.

**rept-stat-mps:loc=1205**

```

Integrat40 05-05-24 10:37:22 EST EAGLE5 34.0.0
CARD VERSION      TYPE      PST      SST      AST
1205 -----      DSM      OOS-MT-DSBLD  Manual  -----
DSM PORT A      OOS-MT      Unavail  -----
ALARM STATUS    = ** 0084 IP Connection Unavailable
DSM PORT B      OOS-MT      Unavail  -----
ALARM STATUS    = ** 0084 IP Connection Unavailable
GSM STAT        = -----
EIR STAT        = -----
CARD ALARM STATUS = No Alarms.
DSM MEMORY USAGE = 0%
Command Completed.
;

```

The following example shows the possible system response if a specific card is queried, and the G-Flex or G-Port feature and the V-Flex feature are turned on:

**rept-stat-mps:loc=1205**

```

Integrat40 08-05-07 11:37:24 EST EAGLE5 39.0.0
CARD VERSION      TYPE      PST      SST      AST
1205 -----      DSM      OOS-MT-DSBLD  Manual  -----
DSM PORT A      OOS-MT      Unavail  -----
ALARM STATUS    = ** 0084 IP Connection Unavailable
DSM PORT B      OOS-MT      Unavail  -----
ALARM STATUS    = ** 0084 IP Connection Unavailable
GSM STAT        = -----
VFLEX STAT      = -----
CARD ALARM STATUS = No Alarms.
DSM MEMORY USAGE = 0%
Command Completed.
;

```

The following example shows the possible system response if the EIR, INP or AINPQ, V-Flex, and the G-Port, G-Flex, or PPSMS features are turned on, and the ATINP feature is enabled.

**rept-stat-mps**

```

rlghncxa03w 09-01-07 10:23:93 EST EAGLE 40.0.0
                VERSION      PST      SST      AST
EPAP A          027-015-000  IS-NR    Active  -----
CRITICAL PLATFORM ALARM DATA = No Alarms
MAJOR PLATFORM ALARM DATA = No Alarms
MINOR PLATFORM ALARM DATA = No Alarms
CRITICAL APPLICATION ALARM DATA = No Alarms
MAJOR APPLICATION ALARM DATA = No Alarms
MINOR APPLICATION ALARM DATA = No Alarms
ALARM STATUS = No Alarms

                VERSION      PST      SST      AST
EPAP B          027-015-000  OOS-MT    Fault   Standby
CRITICAL PLATFORM ALARM DATA = No Alarms
MAJOR PLATFORM ALARM DATA = No Alarms
MINOR PLATFORM ALARM DATA = No Alarms
CRITICAL APPLICATION ALARM DATA = No Alarms
MAJOR APPLICATION ALARM DATA = No Alarms
MINOR APPLICATION ALARM DATA = No Alarms

```

ALARM STATUS = No Alarms

| CARD | PST          | SST      | GSM STAT |
|------|--------------|----------|----------|
| 1106 | P IS-NR      | Active   | ACT      |
| 1201 | IS-ANR       | Active   | SWDL     |
| 1205 | OOS-MT-DSBLD | Manual   | -----    |
| 1302 | OOS-MT       | Isolated | -----    |
| 1310 | IS-ANR       | Standby  | SWDL     |

| CARD | PST          | SST      | INP STAT |
|------|--------------|----------|----------|
| 1106 | P IS-NR      | Active   | ACT      |
| 1201 | IS-ANR       | Active   | SWDL     |
| 1205 | OOS-MT-DSBLD | Manual   | -----    |
| 1302 | OOS-MT       | Isolated | -----    |
| 1310 | IS-ANR       | Standby  | SWDL     |

| CARD | PST          | SST      | EIR STAT |
|------|--------------|----------|----------|
| 1106 | P IS-NR      | Active   | ACT      |
| 1201 | IS-ANR       | Active   | SWDL     |
| 1205 | OOS-MT-DSBLD | Manual   | -----    |
| 1302 | OOS-MT       | Isolated | -----    |
| 1310 | IS-ANR       | Standby  | SWDL     |

| CARD | PST          | SST      | V-FLEX STAT |
|------|--------------|----------|-------------|
| 1106 | P IS-NR      | Active   | ACT         |
| 1201 | IS-ANR       | Active   | SWDL        |
| 1205 | OOS-MT-DSBLD | Manual   | -----       |
| 1302 | OOS-MT       | Isolated | -----       |
| 1310 | IS-ANR       | Standby  | SWDL        |

| CARD | PST          | SST      | ATINPQ STAT |
|------|--------------|----------|-------------|
| 1106 | P IS-NR      | Active   | ACT         |
| 1201 | IS-ANR       | Active   | SWDL        |
| 1205 | OOS-MT-DSBLD | Manual   | -----       |
| 1302 | OOS-MT       | Isolated | -----       |
| 1310 | IS-ANR       | Standby  | SWDL        |

```

CARD 1106 ALARM STATUS = No Alarms
  DSM PORT A:    ALARM STATUS      = No Alarms
  DSM PORT B:    ALARM STATUS      = No Alarms
CARD 1201 ALARM STATUS = No Alarms
  DSM PORT A:    ALARM STATUS      = No Alarms
  DSM PORT B:    ALARM STATUS      = No Alarms
CARD 1205 ALARM STATUS = No Alarms
  DSM PORT A:    ALARM STATUS      = No Alarms
  DSM PORT B:    ALARM STATUS      = No Alarms
CARD 1302 ALARM STATUS = No Alarms
  DSM PORT A:    ALARM STATUS      = No Alarms
  DSM PORT B:    ALARM STATUS      = No Alarms
CARD 1310 ALARM STATUS = No Alarms
  DSM PORT A:    ALARM STATUS      = No Alarms
  DSM PORT B:    ALARM STATUS      = No Alarms
Command Completed.

```

;

**Legend**

**CARD**—The location of the Service Module card. The Service Module card with the designator “P” to the right of its card location is the primary Service Module card as selected by the active ELAP/EPAP. The primary Service Module card provides the ELAP/EPAP status to the OAM. When the primary state (PST) of the ELAP/EPAP is IS-NR, the secondary state (SST) indicates whether the ELAP/EPAP is active or standby.

**VERSION**—The version number of the GPL that the specified ELAP/EPAP or card is running.

**PST**—The primary state of the ELAP/EPAP or card. The possible values are described in "Possible Values for PST/SST/AST".

**SST**—The secondary state of the ELAP/EPAP or card. The possible values are described in "Possible Values for PST/SST/AST".

**AST**—The associated state of the ELAP/EPAP or card. The possible values are described in "Possible Values for PST/SST/AST".

**EPAP/ELAP A/B**—The application running on the MPS (multi-purpose server) platform. If the LNP ELAP Configuration feature is turned on, the output shows ELAP A/B. If INP, G-Flex, G-Port, or V-Flex is turned on, the output shows EPAP A/B.

**ALARM STATUS**—A listing of any trouble text alarm messages that have been generated for the MPS and the applications running on the MPS. Each alarm is listed as a 16-character hexadecimal string where each bit represents a unique platform or application alarm. To decode the string, use the procedure in the EPAP Administration Manual or the *ELAP Administration Manual*. There are 6 categories of MPS alarms:

- Critical platform alarm data
- Major platform alarm data
- Minor platform alarm data
- Critical application alarm data
- Major application alarm data
- Minor application alarm data

**GSM STAT**—The possible states are either ACT (active) or SWDL (indicates that the GSM component on that card is currently inactive until the software download completes). The GSM STAT information is not displayed if the G-Port, G-Flex and Prepaid SMS Intercept Ph1 features are turned off.

**INP STAT**—The possible states of INP status include ACT (active), OFFL (offline) and SWDL (indicates that the INP component on that card is currently inactive until the software download completes). The INP STAT information is not displayed if the INP feature is turned off.

**LNP STAT**—The possible states of LNP status include ACT (active), OFFL (offline) and SWDL (indicates that the LNP component on that card is currently inactive until the software download completes). The LNP STAT information is not displayed if the LNP ELAP Configuration feature is turned off.

**EIR STAT**—The possible states of EIR Status include ACT (active), OFFL (offline), and SWDL (Indicates the EIR component on that card is currently inactive until software download completes). The EIR STAT information is not displayed if the EIR feature is not enabled.

**VFLEX STAT**—The possible states of V-Flex Status include ACT (active), OFFL (offline), and SWDL (Indicates the V-Flex component on that card is currently inactive until software download completes). The V-Flex Status information is not displayed if the V-Flex feature is not on.

**ATINPQ STAT**—The possible states of ATINPQ Status include ACT (active), OFFL (offline), and SWDL (Indicates the ATINPQ component on that card is currently inactive until software download completes). The ATINPQ STAT information is not displayed if the ATINP feature is not enabled.

**DSM MEMORY USAGE**—The percentage of DSM memory used to store the ELAP/EPAP database.

For EPAP, the percentage of the card memory is displayed. For example, 50% of the memory on a 2G DSM card means that 1G is used.

For ELAP/LNP, the percentage that is displayed depends on the enabled or default feature access key (FAK) quantity for LNP ported TNs, LNP ported LRNs, and LNP ported NPANXXs in the system (see the **rtrv-ctrl-feat** command output). The percentage is the greatest of: 1) TNs provisioned divided by LNP ported TNs FAK quantity, 2) LRNs provisioned divided by LNP ported LRNs FAK quantity, or 3) NPANXXs provisioned divided by LNP ported NPANXXs FAK quantity.

**CARD XXXX ALARM STATUS**—A listing of any trouble text alarm messages that have been generated for the card.

**DSM PORT A/B**—A listing of any trouble text alarm messages that have been generated for the port on the card.

**IP CONNECTION UNAVAILABLE**—Indicates the failed channels on those ports with IP Connection Unavailable alarms. The possible channels reported are:

- Prov—RTDB Provisioning Channel
- Dnld—RTDB Download Channel
- TCP—Transmission Control Protocol Channel
- UDP—User Datagram Protocol Channel

## rept-stat-mux

## Report the MPS Status

Use this command to list all the HMUX, HIPR, and HIPR2 cards and the location and status of the cards.

**Keyword:** `rept-stat-mux`

**Related Commands:** `rept-stat-card`

**Command Class:** System Maintenance

### Parameters

This command has no parameters.

### Example

```
rept-stat-mux
```

### Dependencies

None

### Notes

None

**Output**

**rept-stat-mux**

Command entered at terminal #4.

| CARD | TYPE  | PST   | SST    | AST    | BITRATE<br>(OPER) | BITRATE<br>(ACT) |
|------|-------|-------|--------|--------|-------------------|------------------|
| 1109 | HMUX  | IS-NR | Active | ALMINH | LOW               | LOW              |
| 1110 | HMUX  | IS-NR | Active | -----  | LOW               | LOW              |
| 1209 | HIPR  | IS-NR | Active | ALMINH | LOW               | LOW              |
| 1210 | HIPR  | IS-NR | Active | -----  | LOW               | LOW              |
| 1309 | HIPR2 | IS-NR | Active | ALMINH | LOW               | LOW              |
| 1310 | HIPR2 | IS-NR | Active | -----  | LOW               | LOW              |

Command Completed.

;

**Legend**

**CARD**—The HMUX, HIPR, or HIPR2 card location.

**TYPE**—The type of card (HMUX, HIPR, or HIPR2).

**PST**—The primary state of the card. The possible values are described in "Possible Values for PST/SST/AST" in Appendix A.

**SST**—The secondary state of the card. The possible values are described in "Possible Values for PST/SST/AST" in Appendix A.

**AST**—The associated state of the card. The possible values are described in in Appendix A.

**BITRATE(OPER)**—The maximum operational bit rate that the Fibre-Channel ring is capable of. If the operational bit rate is HIGH, the Fibre-Channel ring can be switched between the HIGH rate and the LOW rate.

**BITRATE(ACT)**—The bit rate currently used by the Fibre-Channel ring. This rate is determined by various parameters such as the operational bit rate of the other bus, the availability of a High Rate Feature Access Key, etc.

**rept-stat-rtd**

**Report Status RTD**

Use this command to report Run Time Diagnostics (RTD) for EAGLE 5 ISS cards, including the status of internal integrity checks and the RTD subsystem alarm. This display can help determine the cause when an RTD subsystem alarm occurs, or when associated issues are reported.

This command is also used to reset MSU validation statistics and clear the RTD subsystem alarm.

**Keyword:** **rept-stat-rtd**

**Related Commands:**

**Command Class:** System Maintenance

**Parameters**

**:force=** (optional)

The **force** parameter is used with the **reset=yes** parameter to clear statistics for a card when the RTD subsystem alarm is present.

**Range:** **yes**

**:loc=** (optional)

Location. This parameter specifies the card location as stenciled on the shelf of the system.

The **loc** parameter can be used to either retrieve or reset statistics for a card location. To reset the statistics, the **loc** parameter and the **reset** parameter must be specified together in the command.

**Range:** 1101-1108, 1111-1112, 1201-1208, 1211-1218, 1301-1308, 1311-1318, 2101-2108, 2111-2118, 2201-2208, 2211-2218, 2301-2308, 2311-2318, 3101-3108, 3111-3118, 3201-3208, 3211-3218, 3301-3308, 3311-3318, 4101-4108, 4111-4118, 4201-4208, 4211-4218, 4301-4308, 4311-4318, 5101-5108, 5111-5118, 5201-5208, 5211-5218, 5301-5308, 5311-5318, 6101-6108, 6111-6118

**:reset=** (optional)

This parameter clears the statistics by setting them to zero and resets the checksum card indicator error and RTD subsystem alarm.

**Range:** **yes**

**yes** — Clears the statistics.

If the **reset=yes** parameter is specified with the **loc** parameter, then statistics are cleared for the specified card. If the **reset=yes** parameter is specified, and the **loc** parameter is not specified, then statistics are cleared for all cards in the system.

### Example

```
rept-stat-rtd
rept-stat-rtd:loc=1107
rept-stat-rtd:reset=yes:force=yes
rept-stat-rtd:loc=1107:reset=yes
```

### Dependencies

If the **reset=yes** parameter is specified, then the **force=yes** parameter must be specified to clear the statistics and checksum failure indicators.

The card specified by the **loc** parameter must be an IPLIMx, IPGWx, IPSG, SCCP, Service Module, E1/T1 MIM, HC-MIM, E5-E1T1, LIMATM, E5-ATM, or E1-ATM card.

The card in the specified card location (**loc** parameter) must be in service.

The **reset=yes** parameter must be specified to clear the statistics.

The **force=yes** parameter must be specified.

The **loc** parameter cannot have a non-numeric value.

The following card locations are not valid for this command: 1114, 1116, 1117, 1118 (TDM, MDAL cards), and all xy09 and xy10 locations where x is the frame and y is the shelf (HMUX or HIPR cards).

The card slot must be equipped and in service.

### Notes

The statistics from internal integrity checks are displayed for all in-service LIM and SCCP cards. The reported statistics are dynamic and are not maintained when a card is re-initialized.

The displayed reports contain message validation totals since the last time the diagnostic information for the cards was reset.

The individual statistics that are reported re-start at zero after the maximum values are reached and are cleared when reset by the **rept-stat-rtd** command.

The report displayed shows the summary statistics or overall totals for MSU validation statistics for all LIM and SCCP cards in the system. It also includes the status for the RTD subsystem and the RTD subsystem alarm.

When the **loc** parameter is specified in the **rept-stat-rtd** command, the report displayed shows the detailed MSU validation statistics report for the specified card. The report shows statistics from integrity checks performed by the specified card on MSUs transferred to and from LIM/SCCP cards



and includes the timestamp when the card last detected an error during integrity checks. The statistics are only displayed for cards with non-zero totals.

The integrity checks are performed on a subset of the MSUs transferred between cards. When card (s) report errors during the integrity checks, the RTD subsystem alarm is activated. The error statistics reported should be used along with the UIMs or alarms to help identify the source of the problem.

The RTD subsystem alarm is triggered when a card reports that a checksum error was detected during internal card integrity checks.

The RTD subsystem alarm remains active in the system until the statistics are reset using the **rept-stat-rtd** command, and no further indications of checksum errors are reported during internal card integrity checks.

## Output

If the **rept-stat-rtd** command is entered with no parameters, then a summary status for the RTD subsystem and alarm and summary statistics for all of the LIM/SCCP cards in the system are displayed.

If the **loc** parameter is specified in the **rept-stat-rtd** command, then detailed statistics are displayed for the specified card location. Only cards with non-zero totals are reported in the location specific report.

The following example displays a summary report on the status of the RTD subsystem and RTD subsystem alarm with MSU validation statistics for all LIM/SCCP cards in the system.

### rept-stat-rtd

```
eagle10110 07-02-22 20:32:58 EST EAGLE 35.6.0
Retrieving data from cards...
```

```
RTD SUBSYSTEM REPORT IS-NR          Active      -----
RTD ALARM STATUS = No Alarms
```

```

      MSU Validation Statistics
      =====
      Total Rx   Total Rx   Total
CARD   Error    Validated  Tx
1101         0         275    710
1102         0         200    200
1103         0         200   1000
1105         0        1360    275
1107         0         200    100
1108         0         100    100
-----
```

```
END OF REPORT
```

```
;
```

The following example displays a detailed report for card 1101. This report indicates that the card received MSUs from several cards in the system.

### rept-stat-rtd:loc=1101

```
eagle10110 07-02-22 20:32:58 EST EAGLE 35.6.0
Retrieving data from card ...
```

```
CARD SUMMARY: 1101      Last Alarm Timestamp: -----
```

```

      MSU Validation Statistics
      =====
      Total Rx   Total Rx   Total Tx
SRC/DEST   Error    Validated
CARD
1102         0         100    100
1103         0          0     0
1105         0         75    360
1107         0         100    200
1108         0          50     50
-----
```

```
;END OF REPORT
```

```
;
```

The following example displays a summary report for cards 1101 - 1108. This report indicates that the cards received checksum errors in MSUs from other cards.

### rept-stat-rtd

```
eagle10110 07-02-22 20:32:58 EST EAGLE 35.6.0
Retrieving data from card...
```

```
RTD SUBSYSTEM REPORT IS-ANR Active -----
RTD ALARM STATUS = 541 MSU cksum error threshold exceeded
```

```
MSU Validation Statistics
=====
Total Rx      Total Rx      Total
CARD      Error      Validated      Tx
1101          100          275          500
1102           25          200          300
1103           0           200          500
1105           0           600          125
1107           50          250          100
1108           0           100          100
-----
;END OF REPORT
```

The following example displays a detailed report for card 1101. This report indicates that the card received MSUs with checksums from cards 1102, 1103, and 1105 and MSUs with checksum errors from card 1103.

**rept-stat-rtd:loc=1101**

```
eagle10110 07-02-22 20:32:58 EST EAGLE 35.6.0
Retrieving data from card ...
```

```
CARD SUMMARY: 1101      Last Alarm Timestamp: mm-dd-yy hh:mm:ss
```

```
MSU Validation Statistics
=====
Total Rx      Total Rx      Total Tx
SRC/DEST      Error      Validated
CARD
1102           0           75          100
1103          100          100          100
1105           0           100          100
1107           0           0           100
1108           0           0           100
```

The following example displays the option for resetting MSU validation statistics of all cards in the system.

**rept-stat-rtd:reset=yes**

```
eagle10110 07-02-22 20:32:58 EST EAGLE 35.6.0
Clear RTD Statistics command(s) issued...
Command Completed.
```

The following example displays the option for resetting MSU validation statistics and checksum failure indicators for all cards in the system and clearing the RTD subsystem alarm.

**rept-stat-card:reset=yes:force=yes**

```
eagle10110 07-02-22 20:34:06 EST EAGLE 35.6
Clear RTD Statistics command(s) issued...
Command Completed.
```

```
eagle10110 07-02-22 20:32:58 EST EAGLE 35.6.0
5501.0542 RTD SYSTEM MSU cksum error threshold cleared
```

**Legend**

This section defines the fields of the **rept-stat-rtd** reports.

**PST**—The possible values are described in "Possible Values for PST/SST/AST". For this command, IS-NR specifically means no checksum errors were found during the last reporting period; IS-ANR specifically means that a card or cards reported checksum errors during MSU integrity checks when the RTD status was previously IS-NR, and the RTD System Alarm(s) was raised.

**TOTAL RX ERROR** (for a Summary Report)—Total MSUs received with checksum errors, including MSUs with checksum errors received from all cards in the system.

**TOTAL RX ERROR** (for a Location-Specified Report)—Total MSUs with checksum errors received at the card specified by the **loc** parameter from SRC/DEST CARD.

**TOTAL RX VALIDATED** (for a Summary Report)—Total MSUs with checksum received and validated from all cards in the system.

**TOTAL RX VALIDATED** (for a Location-Specified Report)—Total MSUs with checksum received and validated at the card specified by the **loc** parameter from SRC/DEST CARD.

**TOTAL TX** (for a Summary Report)—Total MSUs with checksum applied and transmitted to all cards in the system.

**TOTAL TX** (for a Location-Specified Report)—Total MSUs with checksums transmitted from the card specified in the **loc** parameter to SRC/DEST CARD.

**LAST ALARM TIMESTAMP**—Timestamp for last reported checksum error for the card specified in the **loc** parameter.

**SRC/DEST CARD**—Source card transmitting MSUs with checksums received by the card specified in the **loc** parameter. Destination card receiving MSUs with checksums transmitted from card specified in LOC parameter.

**RTD SUBSYSTEM**—Indicates RTD Device Status (IS-NR, etc).

**RTD ALARM STATUS**—Indicates whether an alarm is present for the RTD Device. The possible values are described in .

## rept-stat-rte

## Report Status Route

Use this command to display the signaling route status for a particular destination.

**Keyword:** **rept-stat-rte**

**Related Commands:** **chg-dstn,, dlt-dstn, dlt-rte, ent-dstn, ent-rte, rept-stat-dstn, rtrv-dstn, rtrv-rte**

**Command Class:** System Maintenance

### Parameters

**:dpc=** (optional)

**Range:** **p-, 000-255, \*, \*\*, \*\*\***

Specify a valid value for each subfield of the point code, and separate the subfields with a dash (-).

*prefix*—**p-**

The asterisk values **\***, **\*\***, and **\*\*\*** are not valid for the *ni* subfield.

If **\*\*** or **\*\*\*** is specified for the *nc* subfield, either **\***, **\*\***, or **\*\*\*** must be specified for the *ncm* subfield.

When **chg-sid:pctype=ansi** is specified, *ni* = **000** is not valid.

When **chg-sid:pctype=ansi** is specified, *nc* = **000** is not valid if *ni* = **001-005**.

When **chg-sid:pctype=ansi** is specified, *nc* = **000** is valid if *ni* = **006-255**.

When **chg-sid:pctype=ansi** is specified, *ni*-\*-\* is valid if *ni* = **006-255**.

The point code **000-000-000** is not a valid point code.

**:dpc/dpca/dpci/dpcn/dpcn24=** (optional)

Destination point code.

**:dpci=** (optional)

**Range:** **s-, p-, ps-, 0-255**

Specify a valid value for each subfield of the point code, and separate the subfields with a dash (-).

*prefix*—**s-, p-, ps-**

*zone*—**0-7**

*area*—**000-255**

*id*—**0-7**

The point code **0-000-0** is not a valid point code.

**:dpcn=** (optional)

**Range:** **s-, p-, ps-, 0-16383, aa-zz**

Specify a valid value for each subfield of the point code, and separate the subfields with a dash (-).

*prefix*—**s-, p-, ps-**

*nnnnn*—**0-16383**

*gc*—**aa-zz**

*m1-m2-m3-m4*—**0-14** for each member; values must sum to 14

**:dpcn24=** (optional)

**Range:** **p-, 000-255**

Specify a valid value for each subfield of the point code, and separate the subfields with a dash (-).

*prefix*—**p-**

*msa*—**000-255**

*ssa*—**000-255**

*sp*—**000-255**

**:mode=** (optional)

This parameter specifies the type of display to produce.

**Range:** **full, rtx**

**full**— Comprehensive display of point code status, including **rtx**. If specified with a point code, then the status for that point code is displayed. If specified without a point code, then the status of all routes is displayed.

**rtx**— Displays exception route status, other than circular routing, if the Origin-based MTP Routing feature is on.

**Default:** A summary report is displayed.

**:stat=** (optional)

This parameter specifies the primary state filter.

**Range:** **all, alminh, anr, dsbld, mt, nr**

**all**— All of the primary states

**alminh**— Alarms inhibited

**anr**— In service abnormal (IS-ANR)

**dsbld**— Out of service maintenance disabled (OOS-MT-DSBLD)

**mt**— Out of service maintenance (OOS-MT)

**nr**— In service normal (IS-NR)

**Default:** **all**

**Example**

```

rept-stat-rte
rept-stat-rte:dpc=5-25-0
rept-stat-rte:dpci=5-5-0:mode=full
rept-stat-rte:dpci=5-5-0:mode=rtx
rept-stat-rte:mode=rtx
rept-stat-rte:mode=full
rept-stat-rte:dpc=5-25-**

```

**Dependencies**

An x-list DPC cannot be specified in the **dpc** parameter.

If the **mode=full** parameter is specified, then the **dpc/dpca/dpcn/dpci/dpcn24** parameter must be specified.

If the **dpc** parameter specifies an *ni-nc-\** format, then the **mode** parameter cannot be specified.

The **dpc** parameter must specify an *ni-nc-\** format before the **stat** parameter can be specified with the **dpc** parameter.

No other **rept-stat-xxx** command can be in progress when this command is entered.

If a **dpc** parameter is specified, then the value must be the true destination point code (not an alias) and the value must be defined in the database.

The Origin-Based MTP Routing feature must be turned on before the **mode=rtx** parameter can be specified.

The destination address must be a full point code, a network destination, or a cluster point code.

The **pst** and **mode** parameters cannot be specified together in the command.

**Notes**

This command can be canceled using the **F9** function key or the **canc-cmd** command. See **canc-cmd** for more information.

This command does not report the x-list point codes. Use the **rept-stat-cluster** command for a report of x-list point codes.

If the **mode=rtx** parameter is specified with a specific DPC, additional linkset, route and exception route information associated with the specified DPC is displayed.

In this command, only ITU-international and ITU national point codes support the spare point code subtype prefix (**s-**) and the private and spare point code subtype prefix (**ps-**). All of the point code types support the private (internal) point code subtype prefix (**p-**).

Table 5-78 provides a summary description of the reports that are produced by the various DPC parameter syntaxes.

**Table 5-78.** Summary of DPC Parameter Syntaxes

| DPC format                         | Meaning                                                                                                       |
|------------------------------------|---------------------------------------------------------------------------------------------------------------|
| <b>rept-stat-rte:dpc=ni-nc-ncm</b> | Requests a report for fully provisioned destination <i>ni-nc-ncm</i> .                                        |
| <b>rept-stat-rte:dpc= ni-*-*</b>   | Requests a report for provisioned network destination with the specified network indicator. Note that if * is |

Table 5-78. Summary of DPC Parameter Syntaxes

| DPC format                             | Meaning                                                                                                                                                                                                                              |
|----------------------------------------|--------------------------------------------------------------------------------------------------------------------------------------------------------------------------------------------------------------------------------------|
|                                        | specified in the <i>nc</i> field, * must be specified in the <i>ncm</i> field.                                                                                                                                                       |
| <b>rept-stat-rte:dpc= ni-**-*</b>      | Requests a report for the full network cluster for the specified <i>ni</i> .                                                                                                                                                         |
| <b>rept-stat-rte:dpc= ni-***.*</b>     | Requests a report for the full network cluster and the network cluster address (if any) for the specified <i>ni</i> .                                                                                                                |
| <b>rept-stat-rte:dpc= ni-nc-*</b>      | Requests a report for provisioned cluster destination <i>ni-nc-*</i> .                                                                                                                                                               |
| <b>rept-stat-rte:dpc= ni-nc-**</b>     | Requests a report showing all destinations whose network ( <i>ni</i> ) and cluster ( <i>nc</i> ) components match those specified. Note, however, that the network cluster address on <i>ni-nc-*</i> (if it exists) is not reported. |
| <b>rept-stat-rte:dpc= ni-nc-***</b>    | Requests a report showing all destinations whose network ( <i>ni</i> ) and cluster ( <i>nc</i> ) components match those specified. The network cluster address <i>ni-nc-*</i> (if it exists) is also reported.                       |
| <b>rept-stat-rte:dpcn24=msa-ssa-sp</b> | Requests a report for fully provisioned 24-bit destination <i>main signaling area-sub signaling area-signaling point</i> .                                                                                                           |

If the **mode=rtx** parameter is specified without a specific DPC, then status is provided for all exception route sets.

If the **mode=full** parameter is specified with a specific destination point code, then additional linkset, route, and exception route information associated with the specified destination is displayed, along with information that can be used to correct circular routing. If the **mode=full** parameter is specified without a specific destination point code, then status is provided for all regular and exception route sets.

## Output

If the **dpc** parameter is not specified:

- If the **mode** parameter is not specified, then the command output lists the status of all provisioned destination point codes (DPCs) (routesets) in the system.
- If the **mode=rtx** parameter is specified, then the output lists the status of only those DPCs against which exception routes have been provisioned, and the status of the provisioned exception route sets associated with each DPCs.
- If the **mode=full** parameter is specified, then the command lists the status of all provisioned DPCs in the system, and the status of the provisioned exception route sets, if any, associated with each DPC.

If the **dpc** parameter is specified:

- If the **mode** parameter is not specified, then the output lists the status of all provisioned routes in the route set specified by that DPC.
- If the **mode=rtx** parameter is specified, then the output lists the status of all provisioned routes in the routeset specified by that DPC, and the status of all provisioned exception routesets associated with that DPC.
- If the **mode=full** parameter is specified, then the output lists the status of all provisioned routes in the routeset specified by that DPC, the status of all provisioned exception route sets associated with that DPC, any aliases associated with that DPC, and circular routing alarm information if any for that DPC.

The following example shows how summary information for all provisioned cluster and noncluster DPCs is reported.

### rept-stat-rte

```
rlghncxa03w 04-01-07 14:59:11 EST EAGLE 31.3.0
  DPCA          PST          SST          AST
  009-000-000   IS-ANR          Allowed      ACCESS
  009-003-*     IS-ANR          Allowed      ACCESS
  009-003-006   OOS-MT          Prohibit     INACCESS
  009-003-001   IS-NR           Allowed      ACCESS
  009-003-002   IS-NR           Allowed      ACCESS
  009-003-003   OOS-MT          Prohibit     INACCESS
  009-004-006   IS-NR           Allowed      ALMINH
  004-002-002   IS-NR           Allowed      ACCESS
  006-000-000   IS-ANR          Allowed      ACCESS
  007-001-001   IS-NR           Allowed      ACCESS
  101-033-*     IS-NR           Allowed      ACCESS

  DPCI          PST          SST          AST
  2-004-1       IS-NR          Allowed      ACCESS
  2-004-3       IS-ANR          Allowed      ACCESS
  2-004-2       IS-ANR          Allowed      ACCESS
  2-004-4       IS-NR          Allowed      ACCESS

  DPCN          PST          SST          AST
  02096         IS-NR          Allowed      ACCESS
  02097         IS-ANR          Allowed      ACCESS
  02098         OOS-MT          Prohibit     INACCESS
  02099         OOS-MT          Prohibit     INACCESS
```

Command Completed.

;



The following example shows how specifying a cluster destination on the **dpc** parameter shows the cluster status and routeset information. Information on cluster members (both provisioned and x-list) is not shown. Use the **rept-stat-cluster** command to obtain this information.

**rept-stat-rte:dpc=9-3-\***

```
rlghncxa03w 04-07-07 14:59:11 EST EAGLE 31.9.0
  DPCA          PST          SST          AST
  009-003-*     IS-NR       Allowed   ACCESS
ALARM STATUS    = No Alarms.
RTE COST  LSN      APCA          LS STAT  NON-ADJ  ROUTE STAT
 1*  10  lsnstpa  042-036-123  Allowed  Allowed  Allowed
 2   20  lsnstpb  092-240-103  Allowed  Allowed  Allowed
 3   30  lsnstpc  128-101-022  Allowed  Allowed  Allowed
 4   --  -----  ***-***-***  -----  -----  -----
 5   --  -----  ***-***-***  -----  -----  -----
 6   --  -----  ***-***-***  -----  -----  -----
```

;

The following example shows how specifying either an FPC or cluster destination for which circular routing has been detected, along with the **mode=full** parameter, displays the name of the linkset on which the circular routing test message was transmitted. It also displays the linkset on which the circularly routed message was received.

**rept-stat-rte:dpc=9-3-6:mode=full**

```
rlghncxa03w 04-01-07 14:59:11 EST EAGLE 31.3.0
  DPCA          PST          SST          AST
  009-003-006   OOS-MT       Prohibit  INACCESS
ALARM STATUS    = = *C xxxx Circular routing detected
RTE COST  LSN      APCA          LS STAT  NON-ADJ  ROUTE STAT
 1   10  lsnstpa  042-036-123  Allowed  Allowed  Allowed
 2   20  lsnstpb  092-240-103  Allowed  Allowed  Allowed
 3   30  lsnstpc  128-101-022  Allowed  Allowed  Allowed
 4   --  -----  ***-***-***  -----  -----  -----
 5   --  -----  ***-***-***  -----  -----  -----
 6   --  -----  ***-***-***  -----  -----  -----
SSN  SUBSYSTEM STATUS

ALIASA          ALIASN          ALIASI
-----          -----          -----

CIRCULAR ROUTING
  XMIT LSN= lsnstpb
  RCV  LSN= lsn01a
MEMBER= ***-***-***
Command Completed.
```

;

The following example shows a typical report when a cluster destination and **mode=full** was specified. The interpretation of the circular routing status for cluster destinations is slightly different from the status for full point code destinations.

**rept-stat-rte:dpc=9-3-\*:mode=full**

```
rlghncxa03w 04-01-07 14:59:11 EST EAGLE 31.3.0
  DPCA          PST          SST          AST
  009-003-*     IS-NR       Allowed   ACCESS
ALARM STATUS    = *C xxxx Circular routing detected
RTE COST  LSN      APCA          LS STAT  NON-ADJ  ROUTE STAT
 1   10  lsnstpa  042-036-123  Allowed  Allowed  Allowed
 2   20  lsnstpb  092-240-103  Allowed  Allowed  Allowed
 3   30  lsnstpc  128-101-022  Allowed  Allowed  Allowed
 4   --  -----  ***-***-***  -----  -----  -----
 5   --  -----  ***-***-***  -----  -----  -----
 6   --  -----  ***-***-***  -----  -----  -----
SSN  SUBSYSTEM STATUS

ALIASA          ALIASN          ALIASI
-----          -----          -----

CIRCULAR ROUTING INFO:
```

```

XMIT LSN=lsnstpb RC=20
RCV LSN=lsn01a
MEMBER= 009-003-006
Command Completed.

```

The following example shows how the circular routing alarm for a cluster destination is displayed. A circular routing alarm for a cluster destination indicates that circular routing was detected for a member of the cluster, but no x-list entry could be created for that cluster. Circular routing detected on a cluster destination does not automatically force the output to display the status of the cluster as "OOS-MT Prohibit INACCESS" as it does for a full point code destination.

**rept-stat-rte:dpc=9-3-\***

```

rlghncxa03w 04-01-07 14:59:11 EST EAGLE 31.3.0
DPCA          PST          SST          AST
009-003-*     IS-NR          Allowed    ACCESS
ALARM STATUS  = *C xxxx Circular routing detected
RTE COST  LSN      APCA          LS STAT    NON-ADJ    ROUTE STAT
1   10  lsnstpa  042-036-123 Allowed    Allowed    Allowed
2   20  lsnstpb  092-240-103 Allowed    Allowed    Allowed
3   30  lsnstpc  128-101-022 Allowed    Allowed    Allowed
4   --  -----  ***-***-*** -----    -----    -----
5   --  -----  ***-***-*** -----    -----    -----
6   --  -----  ***-***-*** -----    -----    -----
Command Completed.

```

The following example shows how a subsystem information header is displayed without subsystem information, as when an FPC is specified without defining any subsystems. Because aliases cannot be defined for cluster destinations, this report shows only an empty header, as when an FPC is specified without defining aliases. The circular routing information portion of the report displays "-----" for the linkset names when no circular routing condition exists for the DPC.

**rept-stat-rte:dpc=9-3-\*:mode=full**

```

rlghncxa03w 04-07-07 14:59:11 EST EAGLE 31.9.0
DPCA          PST          SST          AST
009-003-*     IS-NR          Allowed    ACCESS
ALARM STATUS  = No Alarms.
RTE COST  LSN      APCA          LS STAT    NON-ADJ    ROUTE STAT
1*  10  lsnstpa  042-036-123 Allowed    Allowed    Allowed
2   20  lsnstpb  092-240-103 Allowed    Allowed    Allowed
3   30  lsnstpc  128-101-022 Allowed    Allowed    Allowed
4   --  -----  ***-***-*** -----    -----    -----
5   --  -----  ***-***-*** -----    -----    -----
6   --  -----  ***-***-*** -----    -----    -----
SSN  SUBSYSTEM STATUS
ALIASA      ALIASN      ALIASI
-----
CIRCULAR ROUTING
XMIT LSN= -----
RCV LSN= -----
MEMBER= ***-***-***
Command Completed.

```

The following example shows how specifying the **stat** parameter along with the *ni-nc-\** or *ni-nc-\*\*\** DPC formats causes the output summary report to include only those destinations whose status matches the state specified.

**rept-stat-rte:dpc=9-4-\*\*\*:stat=alminh**

```

rlghncxa03w 04-02-31 13:30:00 EST EAGLE 31.3.0
DPCA          PST          SST          AST
009-004-006   IS-NR          Allowed    ALMINH
Command Completed.

```

The following example shows a retrieval specifying an ITU national point code where the **chg-  
stpopts:npcfmti** parameter has been set to **1-1-1-11**:

```
rept-stat-rte:dpcn=1-1-1-1000
rlghncxa03w 04-02-31 13:30:00 EST EAGLE 31.3.0
CAUTION : Node isolated...route status out of date!
DPCN          PST          SST          AST
  1-1-1-1000      OOS-MT          Prohibit  INACCESS
ALARM STATUS   = *C 0313 DPC is prohibited
RTE COST  LSN      APCN          LS STAT  NON-ADJ  ROUTE STAT
1   10  lsitu      1-1-1-1000  Prohibit  Allowed  Prohibit
2   --  -----      ***_***_***  -----  -----  -----
3   --  -----      ***_***_***  -----  -----  -----
4   --  -----      ***_***_***  -----  -----  -----
5   --  -----      ***_***_***  -----  -----  -----
6   --  -----      ***_***_***  -----  -----  -----
Command Completed.
;
```

The following example shows a private adjacent point code:

```
rept-stat-rte:mode=full:dpc=1-1-2
rlghncxa03w 05-01-07 13:30:00 EST EAGLE 31.12.0
DPCA          PST          SST          AST
  001-001-002      OOS-MT          Idle       INACCESS
ALARM STATUS   = No Alarms.
RTE COST  LSN      APCA          LS STAT  NON-ADJ  ROUTE STAT
1   01  ls11234567  001-001-002  Prohibit  Allowed  Prohibit
2   02  ls12345678  p-001-001-002  Prohibit  Allowed  Prohibit
3   --  -----      ---***_***_***  -----  -----  -----
4   --  -----      ---***_***_***  -----  -----  -----
5   --  -----      ---***_***_***  -----  -----  -----
6   --  -----      ---***_***_***  -----  -----  -----
SSN  SUBSYSTEM STATUS

ALIASA      ALIASN      ALIASI
  000-000-001  -----      -----
CIRCULAR ROUTING INFO:
XMIT LSN=----- RC=---
RCV LSN=-----
MEMBER =-----
Command Completed.
;
```

The following example shows how the asterisks in the space after the route numbers in the following examples indicate which route (or combined route) is carrying traffic.

```
rept-stat-rte:dpc=1-1-1
tekelecstp 04-09-24 09:19:04 EST EAGLE 31.9.0
DPCA          PST          SST          AST
  001-001-001      IS-NR          Allowed  ACCESS
ALARM STATUS   = No Alarms.
RTE COST  LSN      APCA          LS STAT  NON-ADJ  ROUTE STAT
1*  05  lse1e1      001-001-001  Allowed  Allowed  Allowed
2*  05  lse1e2      001-002-001  Allowed  Allowed  Allowed
3   10  lse1e3      001-003-001  Allowed  Allowed  Allowed
4   --  -----      ---***_***_***  -----  -----  -----
5   --  -----      ---***_***_***  -----  -----  -----
6   --  -----      ---***_***_***  -----  -----  -----
Command Completed.
;
```

The following example shows how no asterisk appears after the route number when no routes were carrying traffic.

**rept-stat-rte:dpc=1-1-1**

```
tekelecstp 06-05-24 09:19:04 EST EAGLE 35.0.0
  DPCA          PST          SST          AST
  001-001-001   OOS-MT       Prohibit  INACCESS
ALARM STATUS    = *C 0313 DPC is prohibited
RTE COST  LSN      APCA          LS STAT  NON-ADJ  ROUTE STAT
  1   05  lse1e1    001-001-001  Prohibit  Allowed  Prohibit
  2   05  lse1e2    001-002-001  Prohibit  Allowed  Prohibit
  3   10  lse1e3    001-003-001  Prohibit  Allowed  Prohibit
  4   --  -----  ***-***-***  -----  -----  -----
  5   --  -----  ***-***-***  -----  -----  -----
  6   --  -----  ***-***-***  -----  -----  -----
```

Command Completed.

;

The following example shows the output when the primary route is not carrying traffic.

**rept-stat-rte:dpc=1-1-1**

```
tekelecstp 06-05-24 09:19:04 EST EAGLE 35.0.0
  DPCA          PST          SST          AST
  001-001-001   IS-ANR       Restrict  ACCESS
ALARM STATUS    = *C 0334 DPC Subsystem is Abnormal
RTE COST  LSN      APCA          LS STAT  NON-ADJ  ROUTE STAT
  1   05  lse1e1    001-001-001  Prohibit  Allowed  Prohibit
  2   05  lse1e2    001-002-001  Prohibit  Allowed  Prohibit
  3*  10  lse1e3    001-003-001  Allowed   Allowed  Allowed
  4   --  -----  ***-***-***  -----  -----  -----
  5   --  -----  ***-***-***  -----  -----  -----
  6   --  -----  ***-***-***  -----  -----  -----
```

Command Completed.

;

The following example shows how the **rtx** mode displays all exception route sets provisioned against the specified DPC when the Origin-Based MTP Routing feature is enabled and on:

**rept-stat-rte:dpc=9-3-\*:mode=rtx**

```
tekelecstp 09-05-01 16:21:39 EST EAGLE 41.0.0
  DPCA          PST          SST          AST
  009-003-*     IS-NR          Allowed   ACCESS
ALARM STATUS    = No Alarms.
RTE COST  LSN      APCA          LS STAT  NON ADJ  ROUTE STAT
  1   10  lsnstpa    042-36-23   Allowed   Allowed   Allowed
  2   20  lsnstpb    092-40-03   Allowed   Allowed   Allowed
  3   30  lsnstpc    128-01-22   Prohibit  Prohibit  Allowed
  4   --  -----  ***-***-***  -----  -----  -----
  5   --  -----  ***-***-***  -----  -----  -----
  6   --  -----  ***-***-***  -----  -----  -----
```

Exception Routes:

```
OPCA          PST          SST          AST
001-001-001   IS-NR          Allowed   ACCESS
```

```
ILSN          PST          SST          AST
lsnstpy       IS-NR          Allowed   ACCESS
```

Command Completed.

The following example displays how all provisioned exception route sets are displayed in addition to the regular route sets when the Origin-Based MTP Routing feature is enabled and on and the **full** mode is specified.

**rept-stat-rte:dpc=9-3-\*:mode=full**

```
tekelecstp 09-05-01 16:21:39 EST EAGLE 41.0.0
  DPCA          PST          SST          AST
  009-003-006   OOS-MT       Prohibit    INACCESS
ALARM STATUS    = = *C 0319 REPT-MTPLP-DET: Circ rte det(cong)
RTE COST  LSN      APCA          LS STAT    NON ADJ    ROUTE STAT
  1   10  lsnstpa   042-036-123 Allowed    Allowed    Allowed
  2   20  lsnstpb   092-240-103 Allowed    Allowed    Allowed
  3   30  lsnstpc   128-101-022 Allowed    Allowed    Allowed
  4   --  -----   ***-***-*** -----    -----    -----
  5   --  -----   ***-***-*** -----    -----    -----
  6   --  -----   ***-***-*** -----    -----    -----
SSN  SUBSYSTEM STATUS
```

```
  ALIASA          ALIASN          ALIASI
  -----          -----          -----
```

```
CIRCULAR ROUTING INFO:
  XMIT LSN=lsnstpb  RC=20
  RCV  LSN=lsn01a
  MEMBER =-----
```

Exception Routes:

```
  OPCA          PST          SST          AST
  001-001-001   IS-NR       Allowed     ACCESS

  ILSN          PST          SST          AST
  lsnstpy       IS-NR       Allowed     ACCESS
```

Command Completed.

;

The following example shows how all provisioned exception route sets are displayed in addition to the regular route sets if the Origin-Based MTP Routing feature is enabled and on and the **full** mode is specified.

**rept-stat-rte:mode=full**

```
tekelecstp 09-05-01 14:06:10 EST EAGLE 41.0.0
  DPCA          PST          SST          AST
  004-004-004   OOS-MT       Idle        INACCESS

  OPCA          PST          SST          AST
  001-001-001   IS-NR       Allowed     ACCESS

  ILSN          PST          SST          AST
  lsnstpy       IS-NR       Allowed     ACCESS

  DPCN          PST          SST          AST
  00001         IS-NR       Allowed     ACCESS

  SI            PST          SST          AST
  10           IS-NR       Allowed     ACCESS

  00002         IS-NR       Allowed     ACCESS
  00005         OOS-MT       Prohibit    INACCESS
  00004         OOS-MT       Prohibit    INACCESS

  DPCN24        PST          SST          AST

  DPCI          PST          SST          AST
```

Command Completed.

;

The following example shows how all provisioned exception routes are displayed if the Origin-Based MTP Routing feature is enabled and on and the **rtx** mode is specified.

**rept-stat-rte:mode=rtx**

```
tekelecstp 09-05-01 14:06:10 EST EAGLE 41.0.0
      DPCA          PST          SST          AST
      004-004-004      OOS-MT          Idle          INACCESS
      OPCA          PST          SST          AST
      001-001-001      IS-NR          Allowed        ACCESS
      ILSN          PST          SST          AST
      lsnstpy          IS-NR          Allowed        ACCESS
      DPCN          PST          SST          AST
      00001          IS-NR          Allowed        ACCESS
      SI          PST          SST          AST
      10          IS-NR          Allowed        ACCESS
```

Command Completed.

;

**Legend**

**DPC/DPCA**—The ANSI destination point code of the route

**DPCN**—The ITU-TSS national destination point code of the route

**DPCN24**—The 24-bit ITU national destination point code of the route

**DPCI**—The ITU-TSS international destination point code of the route

**OPC/OPCA**—The ANSI origination point code as exception routing criterion of the exception route

**OPCN**—The ITU-TSS national origination point code as exception routing criterion of the exception route

**OPCN24**—The 24-bit ITU national origination point code as exception routing criterion of the exception route

**OPCI**—The ITU-TSS international origination point code as exception routing criterion of the exception route

**ILSN**—The originating linkset as exception routing criterion of the exception route

**CIC**—Starting Circuit Identification Code used as the exception routing criterion for this exception route

**ECIC**—Ending Circuit Identification Code together with CIC defines the CIC range that is used as exception routing criterion for this exception route.

**PST**—The primary state of the subsystem. The possible values are described in "Possible Values for PST/SST/AST".

**SST**—The secondary state of the subsystem. The possible values are described in "Possible Values for PST/SST/AST".

**AST**—The associated state of the subsystem. The possible values are described in .

**rept-stat-rtkey**

**Report the Status of Routing Keys**

Use this command to generate a summary report of the status of the system routing keys.

**Keyword:** rept-stat-rtkey

**Related Commands:** chg-appl-rtkey, dlt-appl-rtkey, ent-appl-rtkey, rtrv-appl-rtkey

**Command Class:** System Maintenance

### Parameters

This command has no parameters.

### Example

```
rept-stat-rtkey
```

### Dependencies

None

### Notes

The report generated by the **rept-stat-rtkey** command contains the following information:

- The maximum of static entries (SRKQ) in the routing key table
- The current number of static routing key entries in the routing key table
- The percentage of the static routing key table entries that is provisioned

### Output

```
rept-stat-rtkey
rlghncxa03w 04-02-17 14:59:11 EST EAGLE 31.3.0
SRKQ = 250

Static Route Key table is (50 of 250) 20% full
1105 Route Key table is (25 of 250) 10% full
1107 Route Key table is (25 of 250) 10% full

Static Route Key Socket Association table is (80 of 4000) 2% full
1105 Route Key Socket Association table is (40 of 4000) 1% full
1107 Route Key Socket Association table is (40 of 4000) 1% full

Command Completed.
;
```

## rept-stat-rtx

## Report Status Exception Route

Use this command to display the signaling route status for one or more exception routes to a particular destination.

**Keyword:** rept-stat-rtx

**Related Commands:** chg-rtx, dlt-rtx, ent-rtx, rtrv-rtx

**Command Class:** System Maintenance

### Parameters

**NOTE:** See "Point Code Formats and Conversion" for a detailed description of point code formats, rules for specification, and examples.

**:cic=** (optional)

Starting Circuit Identification Code. This parameter is used alone or together with the **ecic** parameter as exception routing criteria for the specified exception route.

**Range:** 0-16383

**:dpc=** (optional)

ANSI point code with subfields *network indicator-network cluster-network cluster member (ni-nc-ncm)*. The *prefix* subfield indicates a private point code (*prefix-ni-nc-ncm*).

**Synonym: dpca**

**Range:** **p-, 000-255, \*, \*\*, \*\*\***

Specify a valid value for each subfield of the point code, and separate the subfields with a dash (-).

*prefix*—**p-**

The asterisk values \*, \*\*, and \*\*\* are not valid for the *ni* subfield.

If \*\* or \*\*\* is specified for the *nc* subfield, either \*, \*\*, or \*\*\* must be specified for the *ncm* subfield.

When **chg-sid:pctype=ansi** is specified, *ni* = **000** is not valid.

When **chg-sid:pctype=ansi** is specified, *nc* = **000** is not valid if *ni* = **001-005**.

When **chg-sid:pctype=ansi** is specified, *nc* = **000** is valid if *ni* = **006-255**.

When **chg-sid:pctype=ansi** is specified, *ni*-\*-\* is valid if *ni* = **006-255**.

The point code **000-000-000** is not a valid point code.

**:dpc/dpca/dpci/dpcn/dpcn24=** (optional)

Destination point code.

**:dpci=** (optional)

ITU international destination point code with subfields *zone-area-id*. The *prefix* subfield indicates a spare point code, private point code, or private and spare point code (*prefix-zone-area-id*).

**Range:** **s-, p-, ps-, 0-255**

Specify a valid value for each subfield of the point code, and separate the subfields with a dash (-).

*prefix*—**s-, p-, ps-**

*zone*—**0-7**

*area*—**000-255**

*id*—**0-7**

The point code **0-000-0** is not a valid point code.

**:dpcn=** (optional)

ITU national destination point code in the format of a 5-digit number (*nnnnn*); or 2, 3, or 4 numbers (members) separated by dashes (*m1-m2-m3-m4*) as defined by the **chg-stpopts:npcfmti** flexible point code option. A group code must be specified when the ITUDUPPC feature is turned on (*nnnnn-gc, m1-m2-m3-m4-gc*). The *prefix* subfield indicates a spare point code, private point code, or private and spare point code (*prefix-nnnnn, prefix-nnnnn-gc, prefix-m1-m2-m3-m4, prefix-m1-m2-m3-m4-gc*).

**Range:** **s-, p-, ps-, 0-16383, aa-zz**

Specify a valid value for each subfield of the point code, and separate the subfields with a dash (-).

*prefix*—**s-, p-, ps-**

*nnnnn*—**0-16383**

*gc*—**aa-zz**

*m1-m2-m3-m4*—**0-14** for each member; values must sum to 14



**:dpcn24=** (optional)

24-bit ITU national destination point code with subfields *main signaling area-sub signaling area-signaling point (msa-ssa-sp)*. The *prefix* subfield indicates a private point code (*prefix-msa-ssa-sp*).

**Range:** **p-, 000-255**

Specify a valid value for each subfield of the point code, and separate the subfields with a dash (-).

*prefix*—**p-**

*msa*—**000-255**

*ssa*—**000-255**

*sp*—**000-255**

**:ecic=** (optional)

Ending Circuit Identification Code. This parameter, together with the **cic** parameter, defines the CIC range that is used as exception routing criteria for the specified exception route.

**Range:** **0-16383**

**:ilsn=** (optional)

Incoming Link Set Name. This parameter contains the name of the originating linkset. The parameter value is used as part of the exception routing criteria for the specified exception route.

**Range:** *ayyyyyyyyy*

1 alphabetic character followed by up to 9 alphanumeric characters.

**:mode=** (optional)

This parameter specifies the type of display to produce.

**Range:** **full**

**full** — Displays routes from the associated routeset and exception route table for the specified destination point code per criteria.

**:opc=** (optional)

Origination point code. ANSI point code with subfields *network indicator-network cluster-network cluster member (ni-nc-ncm)*. The *prefix* subfield indicates a private point code (*prefix-ni-nc-ncm*).

**Synonym:** **opca**

**Range:** **000-255**

Specify a valid value for each subfield of the point code, and separate the subfields with a dash (-).

When **chg-sid:pctype=ansi** is specified, *ni* = **000** is not valid.

When **chg-sid:pctype=ansi** is specified, *nc* = **000** is not valid if *ni* = **001-005**.

When **chg-sid:pctype=ansi** is specified, *nc* = **000** is valid if *ni* = **006-255**.

The point code **000-000-000** is not a valid point code.

**:opc/opca/opci/opcn/open24=** (optional)

Origination point code.

**:opci=** (optional)

Origination Point Code. ITU international origination point code with subfields *zone-area-id*. The *prefix* subfield indicates a spare point code, private point code, or private and spare point code (*prefix-zone-area-id*).

**Range:** **s-, p-, ps-, 0-255**

Specify a valid value for each subfield of the point code, and separate the subfields with a dash (-).

*prefix*—**s-, p-, ps-**

*zone*—0-7

*area*—000-255

*id*—0-7

The point code **0-000-0** is not a valid point code.

**:open=** (optional)

Origination Point Code. ITU national point code in the format of a 5-digit number (*nnnnn*); or 2, 3, or 4 numbers (members) separated by dashes (*m1-m2-m3-m4*) as defined by the **chg-stpopts:npcfnti** flexible point code option. A group code must be specified when the ITUDUPPC feature is turned on (*nnnnn-gc*, *m1-m2-m3-m4-gc*). The *prefix* subfield indicates a spare point code, private point code, or private and spare point code (*prefix-nnnnn*, *prefix-nnnnn-gc*, *prefix-m1-m2-m3-m4*, *prefix-m1-m2-m3-m4-gc*).

**Range:** **s-, p-, ps-, 0-16383, aa-zz**

Specify a valid value for each subfield of the point code, and separate the subfields with a dash (-).

*prefix*—s-, p-, ps-

*nnnnn*—0-16383

*gc*—aa-zz

*m1-m2-m3-m4*—0-14 for each member; values must sum to 14

**:open24=** (optional)

Origination Point Code. 24-bit ITU national point code with subfields *main signaling area-sub signaling area-signaling point* (*msa-ssa-sp*). The *prefix* indicates a private point code (*prefix-msa-ssa-sp*).

**Range:** **p-, 000-255**

Specify a valid value for each subfield of the point code, and separate the subfields with a dash (-).

*prefix*—p-

*msa*—000-255

*ssa*—000-255

*sp*—000-255

**:si=** (optional)

Service Indicator. This parameter is used as part of the exception routing criteria for the specified exception route.

**Range:** **0-15**

### Example

```
rept-stat-rtx
```

```
rept-stat-rtx:dpc=1-101-1
```

```
rept-stat-rtx:dpc=1-101-1:opc=1-2-1
```

```
rept-stat-rtx:dpc=100-100-1:opc=1-1-1:mode=full
```

### Dependencies

If the **dpcn** parameter is specified, its format must match the format that was assigned with the **chg-stpopts:npcfnti** parameter.

The **dpc** parameter and the class criteria parameters (**opc/ilsn/cic/si**) must be specified before the **mode** parameter can be specified.

The **dpc** parameter must be specified before the class criteria parameters (**opc/ilsn/cic/si**) can be specified.

**Notes**

Each exception route set can have up to 6 associated routes.

In this command, only ITU-international and ITU national point codes support the spare point code subtype prefix (**s-**) and the private and spare point code subtype prefix (**ps-**). All of the point code types support the private (internal) point code subtype prefix (**p-**).

The following table provides a summary description of the reports that are produced by specifying various **rept-stat-rtx** parameters.

| <b>Format</b>                            | <b>Meaning</b>                                                                                                                                                                                        |
|------------------------------------------|-------------------------------------------------------------------------------------------------------------------------------------------------------------------------------------------------------|
| <b>rept-stat-rtx:dpc=ni-nc-ncm :si=n</b> | Requests a status report of the exception route set for fully provisioned destination <i>ni-nc-ncm</i> , which uses the specified value <i>n</i> of the exception route class <b>si</b> as criterion. |
| <b>rept-stat-rtx:dpc= ni-nc-ncm</b>      | Requests a status report of all exception route sets for fully provisioned destination <i>ni-nc-ncm</i> , regardless of the exception route class(es) used as criterion.                              |
| <b>rept-stat-rtx:dpc= ni-nc-*</b>        | Requests a status report of all exception route sets for provisioned cluster destination <i>ni-nc-*</i> , regardless of the exception route class(es) used as criterion.                              |
| <b>rept-stat-rtx</b>                     | Requests a status report of all exception route sets for provisioned destinations, regardless of the exception route class(es) used as criterion                                                      |

This command can be cancelled using the **F9** function key or the **canc-cmd** command. See **canc-cmd** for more information.

**Output**

The following command provides the status of all exception route sets provisioned in the system, sorted by DPC.

**rept-stat-rtx**

```
stdcfg2b 09-05-24 01:54:32 EST EAGLE 41.0.0
```

| DPCA        | PST    | SST      | AST      |
|-------------|--------|----------|----------|
| 001-101-001 | IS-NR  | Allowed  | ACCESS   |
| OPCA        | PST    | SST      | AST      |
| 001-002-001 | IS-ANR | Restrict | ACCESS   |
| SI          | PST    | SST      | AST      |
| 10          | OOS-MT | Prohibit | ACCESS   |
| 12          | OOS-MT | Prohibit | ACCESS   |
| DPCA        | PST    | SST      | AST      |
| 004-101-001 | IS-NR  | Allowed  | ACCESS   |
| SI          | PST    | SST      | AST      |
| 10          | IS-NR  | Allowed  | ACCESS   |
| DPCA        | PST    | SST      | AST      |
| 007-101-001 | OOS-MT | Prohibit | INACCESS |
| OPCA        | PST    | SST      | AST      |
| 003-001-020 | OOS-MT | Prohibit | INACCESS |

Command Completed.

The following command displays the status of exception route sets provisioned against a particular DPC.

**rept-stat-rtx:dpc=1-101-1**

```
stdcfg2b 09-03-24 01:54:32 EST EAGLE 41.0.0
```

| DPCA        | PST    | SST      | AST    |
|-------------|--------|----------|--------|
| 001-101-001 | IS-NR  | Allowed  | ACCESS |
| OPCA        | PST    | SST      | AST    |
| 001-002-001 | IS-ANR | Restrict | ACCESS |
| SI          | PST    | SST      | AST    |
| 10          | OOS-MT | Prohibit | ACCESS |
| 12          | OOS-MT | Prohibit | ACCESS |

Command Completed.

The following command displays detailed status and alarm information for a specific exception route set provisioned against a DPC.

**rept-stat-rtx:dpc=1-101-1:opc=1-2-1**

```
stdcfg2b 06-03-24 02:11:31 EST EAGLE 35.0.0
```

| DPCA                                    | OPCA        | PST    | SST         | AST      |         |            |
|-----------------------------------------|-------------|--------|-------------|----------|---------|------------|
| 001-101-001                             | 001-002-001 | IS-ANR | Restrict    | ACCESS   |         |            |
| ALARM STATUS = * 0533 RTX is restricted |             |        |             |          |         |            |
| RTE                                     | COST        | LSN    | APCA        | LS STAT  | NON-ADJ | ROUTE STAT |
| 1                                       | 09          | e2e7   | 007-001-000 | Prohibit | Allowed | Prohibit   |
| 2*                                      | 10          | e2e4   | 004-001-000 | Allowed  | Allowed | Allowed    |
| 3                                       | --          | -----  | ***-***-*** | -----    | -----   | -----      |
| 4                                       | --          | -----  | ***-***-*** | -----    | -----   | -----      |
| 5                                       | --          | -----  | ***-***-*** | -----    | -----   | -----      |
| 6                                       | --          | -----  | ***-***-*** | -----    | -----   | -----      |

Command Completed.

;

### **Legend**

**DPC/DPCA**—The ANSI destination point code of the exception route

**DPCN**—The ITU-TSS national destination point code of the exception route

**DPCN24**—The 24-bit ITU national destination point code of the exception route

**DPCI**—The ITU-TSS international destination point code of the exception route

**OPC/OPCA**—The ANSI origination point code as exception routing criterion of the exception route

**OPCN**—The ITU-TSS national origination point code as exception routing criterion of the exception route

**OPCN24**—The 24-bit ITU national origination point code as exception routing criterion of the exception route

**OPCI**—The ITU-TSS international origination point code as exception routing criterion of the exception route

**ILSN**—The originating linkset as exception routing criterion of the exception route

**CIC**—Starting Circuit Identification Code used as the exception routing criterion for this exception route

**ECIC**—Ending Circuit Identification Code together with CIC defines the CIC range that is used as exception routing criterion for this exception route.

**SI**—Service Indicator used as the exception routing criterion for this exception route

**PST**—The primary state of the subsystem. The possible values are described in "Possible Values for PST/SST/AST".

**SST**—The secondary state of the subsystem. The possible values are described in "Possible Values for PST/SST/AST".

**AST**—The associated state of the subsystem. The possible values are described in "Possible Values for PST/SST/AST".

## **rept-stat-sccp**

## **Report Status SCCP**

Use this command to display the following types of reports:

- **rept-stat-sccp** (with no parameters)—displays the status of the DSM and E5-SM4G cards and the services executing on those cards:
  - A-Port (IS41 Mobile Number Portability)
  - ATINPQ (ATI Number Portability Query)
  - EIR (Equipment Identity Register)
  - G-Flex (GSM Flexible Numbering)
  - G-Port (GSM Mobile Number Portability)
  - GTT (Global Title Translation)
  - IAR (Info Analyzed Relay)
  - IDP Relay (Prepaid IDP Query Relay)
  - IGM (IS41 GSM Migration)

- INP (INAP-based Number Portability)
- LNP (Local Number Portability)
- LRNQT (ITU TCAP LRN Query)
- MNPSMS (Portability Check for Mobile Originated SMS)
- MO SMS B-Party Routing
- MO SMS IS41-to-GSM Migration
- MO-based GSM SMS NP
- MO-based IS41 SMS NP
- PPSMS (Prepaid SMS Intercept Ph1)
- V-Flex (Voice Mail Router)

The command also displays any cards that are denied SCCP service.

- **rept-stat-sccp:mode=perf**—targets the general SCCP traffic performance for Service Module cards. The report supplies message rates for group ticket voucher (TVG) performance.
- **rept-stat-sccp:loc=nnnn**—provides a detailed view of the status of SCCP services provided by a specific Service Module card. Fields are omitted if an associated feature is not turned on.

**NOTE: The rept-stat-sccp and rept-stat-sccp:mode=perf reports include the status of DSM and E5-SM4G cards but do not differentiate between these card types.**

**NOTE: To retrieve traffic statistics for the LNP feature, the rept-stat-lnp command can also be used.**

**NOTE: When turned on, the A-Port, IGM, and PPSMS features share statistic status with the G-Port feature. The display title for the statistic status varies depending on the features that are turned on:**

- **SMSMR**—The MNPSMS, MO SMS B-Party Routing, MO SMS IS41-to-GSM Migration, MO-based GSM SMS NP, MO-based IS41 SMS NP, or PPSMS feature is turned on.
- **GPORT**—The G-Port feature is turned on, with or without the PPSMS feature.
- **MNP**—The A-Port or IGM feature is turned on, with or without the G-Port and PPSMS features.

**NOTE: If traffic is being generated while DSM cards are loading, then superfluous counts may be displayed in Daily and Overall Peak SCCP Loads. To correct this occurrence, reset the Peak SCCP Loads using the rept-stat-sccp:peakreset=yes command.**

**Keyword:** rept-stat-sccp

**Related Commands:** chg-th-alm, rtrv-th-alm

**Command Class:** System Maintenance

## Parameters

**:loc=** (optional)

Card Address. Use this parameter to specify the location of the Service Module card to be reported on.

**Range:** 1101-1108, 1111-1117, 1201-1208, 1211-1218, 1301-1308, 1311-1318, 2101-2108, 2111-2118, 2201-2208, 2211-2218, 2301-2308, 2311-2318, 3101-3108, 3111-3118, 3201-3208, 3211-3218, 3301-3308, 3311-3318, 4101-4108, 4111-4118, 4201-4208, 4211-4218, 4301-4308, 4311-4318, 5101-5108, 5111-5118, 5201-5208, 5211-5218, 5301-5308, 5311-5318, 6101-6108, 6111-6118

**Default:** Report a summary of all cards.

**:mode=** (optional)

Use this parameter to provide extended performance information, including output about group ticket voucher (TVG) performance and message rates for direct assignments.

**Range:** perf

**Default:** No extended performance information is displayed.

**:peakreset=** (optional)

Reset all Peak values to zero.

**Range:** yes

## Example

```
rept-stat-sccp
rept-stat-sccp:mode=perf
rept-stat-sccp:loc=1106
```

## Dependencies

No other **rept-stat-xxx** command can be in progress when this command is entered.

A Service Module card running the **vsccp** application must be configured in the system before this command can be entered.

Only one optional parameter at a time can be specified in the command.

The card location (**loc** parameter) must identify a configured Service Module card running the **vsccp** application.

## Notes

None

## Output

If the Equipment Identity Register (EIR), G-Port, INP, 1100 TPS/DSM for ITU NP, ANSI-41 INP Query (AINPQ), A-Port, IS41 GSM Migration (IGM), E5-SM4G Throughput Capacity, Info Analyzed Relay (IAR), or V-Flex features are enabled, then the **ansigflex** system option is disabled.

The following example displays the output when the A-Port, G-Flex, G-Port, INP, and Prepaid SMS Intercept Ph1 features are turned on and the ATINP, EIR, LNP, LRNQT, PLNP, TLNP, V-Flex, IAR, and WNP features are turned off:

**rept-stat-sccp**

```
tklc1091301 09-07-08 23:44:59 EST EAGLE5 41.1.0
SCCP SUBSYSTEM REPORT IS-NR Active
SCCP ALARM STATUS = No Alarms
INPQ SUBSYSTEM REPORT IS-ANR Restricted -----
ASSUMING MATE'S LOAD
INPQ: SSN STATUS = Allowed MATE SSN STATUS = Prohibited
INPQ ALARM STATUS = No Alarms
GFLEX SERVICE REPORT IS-ANR Active
GFLEX ALARM STATUS = No Alarms
MNP SERVICE REPORT IS-ANR Active
MNP ALARM STATUS = No Alarms

SCCP Cards Configured=4 Cards IS-NR=2
System TPS Alarm Threshold = 100% Total Capacity
System Peak SCCP Load = 3000 TPS
System Total SCCP Capacity = 5000 TPS

CARD VERSION PST SST AST MSU USAGE CPU USAGE
-----
1212 101-001-000 IS-NR Active ALMINH 45% 30%
1301 P 101-001-000 IS-NR Active ----- 35% 40%
1305 ----- OOS-MT Isolated ----- 0% 0%
2112 ----- OOS-MT-DSBLD Manual ----- 0% 0%
-----
SCCP Service Average MSU Capacity = 40% Average CPU Capacity = 35%

AVERAGE CPU USAGE PER SERVICE:
GTT = 15% GFLEX = 5% MNP = 10%
INPMR = 2% INPQ = 3%

TOTAL SERVICE STATISTICS:
SERVICE SUCCESS ERRORS FAIL REROUTE\ FORWARD TOTAL
RATIO WARNINGS TO GTT
GTT: 1995 5 0% - - 2000
GFLEX: 500 1 0% 4 10 515
MNP: 800 0 0% 2 3 805
INPMR: 50 5 0% 0 15 70
INPQ: 499 1 0% - - 500
```

Command Completed.

;

The following example provides status on services for a specified card. The A-Port, G-Flex, G-Port, INP, and Prepaid SMS Intercept Ph1 features are turned on, the EIR, LNP, LRNQT, PLNP, TLNP, V-Flex, IAR, and WNP features are turned off, and the ATINP feature is not enabled.

**rept-stat-sccp:loc=1106**

```
tklc1091301 09-07-08 23:44:59 EST EAGLE5 41.1.0
CARD VERSION TYPE PST SST AST
1106 101-010-000 DSM IS-NR Active -----
CARD ALARM STATUS = No Alarms.
GTT: STAT = ACT CPU USAGE = 10%
GFLEX: STAT = ACT CPU USAGE = 10%
```



```

MNP:   STAT = ACT      CPU USAGE = 10%
INPMR: STAT = ACT      CPU USAGE = 13%
INPQ:  STAT = ACT      CPU USAGE = 20%
-----
TOTAL   = 63%
    
```

CARD SERVICE STATISTICS:

| SERVICE | SUCCESS | ERRORS | WARNINGS | FORWARD TO GTT | TOTAL |
|---------|---------|--------|----------|----------------|-------|
| GTT:    | 1995    | 5      | -        | -              | 2000  |
| GFLEX:  | 500     | 1      | 4        | 10             | 515   |
| MNP:    | 500     | 1      | 4        | 10             | 515   |
| INPMR:  | 50      | 2      | 3        | 15             | 70    |
| INPQ:   | 499     | 1      | -        | -              | 500   |

Command Completed.

The following example displays output when the GTT feature is turned on, the EIR, G-Flex, G-Port, INP, LNP, LRNQT, PLNP, Prepaid SMS Intercept Ph1, TLNP, V-Flex, IAR, and WNP features are turned off, and the ATINP feature is not enabled. Card 1111 is a TSM card with a capacity of 850 TPS.

**rept-stat-sccp:loc=1111**

```

tklcl091301 09-07-08 11:33:18 EST EAGLE5 41.1.0
CARD  VERSION      TYPE      PST          SST          AST
1111  127-008-000    TSM       IS-NR        Active        -----
CARD ALARM STATUS      = No Alarms.
  GTT:   STAT = ACT      CPU USAGE = 1%
-----
TOTAL   = 1%
    
```

CARD SERVICE STATISTICS

| SERVICE | SUCCESS | ERRORS | WARNINGS | FORWARD TO GTT | TOTAL |
|---------|---------|--------|----------|----------------|-------|
| GTT:    | 113     | 0      | -        | -              | 113   |

Command Completed.

The following example displays output when the G-Port, G-Flex, and 1100 TPS/DSM for ITU NP features are turned on.

**rept-stat-sccp**

```

e1030701 06-09-18 02:44:41 EST EAGLE 36.0.0
SCCP SUBSYSTEM REPORT IS-NR      Active      -----
  SCCP ALARM STATUS = No Alarms
GFLEX SERVICE REPORT OOS-MT-DSBLD Manual      -----
  GFLEX ALARM STATUS = *C 0529 Service is disabled
GPORT SERVICE REPORT OOS-MT-DSBLD Manual      -----
  GPORT ALARM STATUS = *C 0529 Service is disabled

SCCP Cards Configured= 1      Cards IS-NR= 1
System Daily Peak SCCP Load    0      TPS 00-00-15 00:41:06
System Overall Peak SCCP Load  0      TPS 00-00-00 00:00:00
System Total SCCP Capacity      1100   TPS (1100 max SCCP Capacity)
System SCCP Capacity Calc. Method (N)
System TPS Alarm Threshold      880    TPS ( 80% System N SCCP Capacity)

CARD  VERSION      PST          SST          AST          MSU  CPU
                                     USAGE  USAGE
-----
1105 P 039-007-001  IS-NR        Active        -----        0%   6%
-----
SCCP Service Average MSU Capacity = 0% Average CPU Capacity = 6%

AVERAGE CPU USAGE PER SERVICE:
  GTT = 0% GFLEX = 0% GPORT = 0%
    
```

## TOTAL SERVICE STATISTICS:

| SERVICE | SUCCESS | ERRORS | FAIL<br>RATIO | REROUTE\<br>WARNINGS | FORWARD<br>TO GTT | TOTAL |
|---------|---------|--------|---------------|----------------------|-------------------|-------|
| GTT:    | 0       | 0      | 0%            | -                    | -                 | 0     |
| GFLEX:  | 0       | 0      | 0%            | 0                    | 0                 | 0     |
| GPORT:  | 0       | 0      | 0%            | 0                    | 0                 | 0     |

Command Completed.

;

The following example displays output when **mode=perf**, the G-Flex and G-Port features are turned on, the EIR, LNP, LRNQT, PLNP, TLNP, V-Flex, IAR, and WNP features are turned off, and the ATINP feature is not enabled. The **ansigflex** system option is enabled.

**rept-stat-sccp:mode=perf**

tklcl1091301 09-07-08 23:44:44 EST EAGLE5 41.1.0

```

SCCP SUBSYSTEM REPORT IS-NR           Active   -----
  SCCP ALARM STATUS = No Alarms
GFLEX SERVICE REPORT IS-NR           Active   -----
  GFLEX ALARM STATUS = No Alarms
MNP SERVICE REPORT IS-NR             Active   -----
  MNP ALARM STATUS  = No Alarms

```

```

SCCP Cards Configured= 4      Cards IS-NR= 4
System Daily Peak SCCP Load   0      TPS 08-01-08 22:45:38
System Overall Peak SCCP Load  0      TPS 00-00-00 00:00:00
System Total SCCP Capacity    6800   TPS (6800 max SCCP Capacity)
System SCCP Capacity Calc. Method (N)
System TPS Alarm Threshold    5440   TPS ( 80% System N SCCP Capacity)

```

## TPS STATISTICS

```

=====
CARD  CPU      TOTAL      CLASS 0  CLASS 1
      USAGE    MSU RATE  TVG RATE TVG RATE
-----
2113  5%         0         0         0
2213  5%         0         0         0
2217  5%         0         0         0
2317  5%         0         0         0
-----

```

```

AVERAGE MSU USAGE = 0%
AVERAGE CPU USAGE = 5%
TOTAL MSU RATE     = 0

```

## STATISTICS FOR PAST 30 SECONDS

```

=====
TOTAL MSUS:           0
TOTAL ERRORS:         0

```

## HIGHEST 01 OVERALL DAILY PEAKS

```

=====
0      TPS 00-00-00 00:00:00      0      TPS 08-01-08 22:45:38

```

Command Completed.

;

The following example displays output when the LNP, PLNP, TLNP, and WNP features are turned on, the EIR, G-Flex, G-Port, INP, LRNQT, IAR, and V-Flex features are turned off, and the ATINP feature is not enabled.

**rept-stat-sccp**

tklcl1190601 09-07-08 16:31:14 EST EAGLE5 41.1.0

```

SCCP SUBSYSTEM REPORT IS-NR           Active   -----
  SCCP ALARM STATUS = No Alarms
LNP SUBSYSTEM REPORT IS-NR           Active   -----

```

ASSUMING MATE'S LOAD  
 LNP: SSN STATUS = Allowed MATE SSN STATUS = Prohibited  
 LNP ALARM STATUS = No Alarms

SCCP Cards Configured= 7 Cards IS-NR= 7  
 System Daily Peak SCCP Load 0 TPS 08-05-18 00:00:17  
 System Overall Peak SCCP Load 2908 TPS 08-05-07 13:28:36  
 System Total SCCP Capacity 11900 TPS (11900 max SCCP Capacity)  
 System SCCP Capacity Calc. Method (N)  
 System TPS Alarm Threshold 9520 TPS ( 80% System N SCCP Capacity)

| CARD | VERSION       | PST   | SST    | AST   | MSU<br>USAGE | CPU<br>USAGE |
|------|---------------|-------|--------|-------|--------------|--------------|
| 1205 | P 126-027-000 | IS-NR | Active | ----- | 0%           | 5%           |
| 1317 | 126-027-000   | IS-NR | Active | ----- | 0%           | 5%           |
| 2213 | 126-027-000   | IS-NR | Active | ----- | 0%           | 5%           |
| 2215 | 126-027-000   | IS-NR | Active | ----- | 0%           | 6%           |
| 2217 | 126-027-000   | IS-NR | Active | ----- | 0%           | 5%           |
| 2317 | 126-027-000   | IS-NR | Active | ----- | 0%           | 5%           |
| 1105 | 126-027-000   | IS-NR | Active | ----- | 0%           | 6%           |

SCCP Service Average MSU Capacity = 0% Average CPU Capacity = 5%

AVERAGE CPU USAGE PER SERVICE:

GTT = 0%  
 LNPQR = 0% LNPQS = 0%  
 WNPQS = 0%  
 TLNP = 0%  
 PLNPQS = 0%

TOTAL SERVICE STATISTICS:

| SERVICE | SUCCESS | ERRORS | FAIL<br>RATIO | REROUTE\<br>WARNINGS | FORWARD<br>TO GTT | TOTAL |
|---------|---------|--------|---------------|----------------------|-------------------|-------|
| GTT:    | 0       | 0      | 0%            | -                    | -                 | 0     |
| LNPQR:  | 0       | 0      | 0%            | -                    | -                 | 0     |
| LNPQS:  | 0       | 0      | 0%            | -                    | -                 | 0     |
| WNPQS:  | 0       | 0      | 0%            | -                    | -                 | 0     |
| TLNP:   | 0       | 0      | 0%            | -                    | -                 | 0     |
| PLNPQS: | 0       | 0      | 0%            | -                    | -                 | 0     |

Command Completed.

The following example displays output when the GTT feature is turned on, the EIR, G-Flex, G-Port, INP, LNP, LRNQT, PLNP, TLNP, V-Flex, IAR, and WNP features are turned off, and the ATINP feature is not enabled. Card 1107 is a DSM card with a capacity of 1700 TPS when only the GTT feature is turned on, and card 1111 is a TSM card with a capacity of 850 TPS.

rept-stat-sccp

tekelecstp 09-07-08 11:32:54 EST EAGLE5 41.1.0

SCCP SUBSYSTEM REPORT IS-NR Active -----  
 SCCP ALARM STATUS = No Alarms

SCCP Cards Configured= 2 Cards IS-NR= 2  
 System Daily Peak SCCP Load 8 TPS 06-09-18 00:00:00  
 System Overall Peak SCCP Load 8 TPS 06-09-15 15:28:36  
 System Total SCCP Capacity 2550 TPS (2550 max SCCP Capacity)  
 System SCCP Capacity Calc. Method (N)  
 System TPS Alarm Threshold 2040 TPS ( 80% System N SCCP Capacity)

| CARD  | VERSION | PST   | SST   | AST   | MSU<br>USAGE | CPU<br>USAGE |
|-------|---------|-------|-------|-------|--------------|--------------|
| ----- | -----   | ----- | ----- | ----- | -----        | -----        |

```

1107 127-008-000 IS-NR Active ----- 1% 3%
1111 127-008-000 IS-NR Active ----- 1% 3%
-----
SCCP Service Average MSU Capacity = 1% Average CPU Capacity = 3%

AVERAGE CPU USAGE PER SERVICE:
GTT = 1%
    
```

```

TOTAL SERVICE STATISTICS:

SERVICE SUCCESS ERRORS FAIL REROUTE\ FORWARD TOTAL
GTT:      226      0      0%      -      TO GTT      -      226
    
```

Command Completed.

The following example displays output when **mode=perf**, the LNP, LRNQT, PLNP, TLNP, and WNP features are turned on, the EIR, G-Flex, G-Port, INP, IAR, and V-Flex features are turned off, and the ATINP feature is not enabled.

**rept-stat-sccp:mode=perf**

```

tklcl1190601 09-07-08 16:31:26 EST EAGLE5 41.1.0
SCCP SUBSYSTEM REPORT IS-NR Active -----
SCCP ALARM STATUS = No Alarms
LNP SUBSYSTEM REPORT IS-NR Active -----
ASSUMING MATE'S LOAD
LNP: SSN STATUS = Allowed MATE SSN STATUS = Prohibited
LNP ALARM STATUS = No Alarms

SCCP Cards Configured= 7 Cards IS-NR= 7
System Daily Peak SCCP Load 0 TPS 08-05-18 00:00:17
System Overall Peak SCCP Load 2908 TPS 08-05-07 13:28:36
System Total SCCP Capacity 11900 TPS (11900 max SCCP Capacity)
System SCCP Capacity Calc. Method (N)
System TPS Alarm Threshold 9520 TPS ( 80% System N SCCP Capacity)
    
```

TPS STATISTICS

```

=====
CARD CPU TOTAL CLASS 0 CLASS 1
      USAGE MSU RATE TVG RATE TVG RATE
-----
1205 5% 0 0 0
1317 5% 0 0 0
2213 5% 0 0 0
2215 6% 0 0 0
2217 5% 0 0 0
2317 5% 0 0 0
1105 6% 0 0 0
-----
    
```

```

AVERAGE MSU USAGE = 0%
AVERAGE CPU USAGE = 5%
TOTAL MSU RATE = 0
    
```

STATISTICS FOR PAST 30 SECONDS

```

=====
TOTAL MSUS: 0
TOTAL ERRORS: 0
    
```

```

HIGHEST 01 OVERALL DAILY PEAKS LAST 01 DAILY PEAK SCCP LOADS
=====
2908 TPS 08-05-07 13:28:36 0 TPS 08-05-18 00:00:17
    
```

Command Completed.

The following example shows the output when **mode=perf**, the GTT feature is turned on, the EIR, G-Flex, G-Port, INP, LNP, LRNQT, PLNP, TLNP, V-Flex, IAR, and WNP features are turned off,

and the ATINP feature is not enabled. Card 1107 is a DSM card with a capacity of 1700 TPS with only GTT on, and 1111 is a DSM card with a capacity of 850 TPS.

**rept-stat-sccp:mode=perf**

```
tklc1091301 09-07-08 11:33:09 EST EAGLE5 41.1.0
SCCP SUBSYSTEM REPORT IS-NR Active -----
SCCP ALARM STATUS = No Alarms

SCCP Cards Configured= 2 Cards IS-NR= 2
System Daily Peak SCCC Load 8 TPS 08-05-18 00:00:00
System Overall Peak SCCC Load 8 TPS 08-05-15 15:28:36
System Total SCCC Capacity 2550 TPS (2550 max SCCC Capacity)
System SCCC Capacity Calc. Method (N)
System TPS Alarm Threshold 2040 TPS ( 80% System N SCCC Capacity)
```

TPS STATISTICS

```
=====
CARD CPU TOTAL CLASS 0 CLASS 1
      USAGE MSU RATE TVG RATE TVG RATE
-----
1107 3% 4 4 0
1111 4% 4 4 0
-----
AVERAGE MSU USAGE = 1%
AVERAGE CPU USAGE = 3%
TOTAL MSU RATE = 8
```

STATISTICS FOR PAST 30 SECONDS

```
=====
TOTAL MSUS: 226
TOTAL ERRORS: 0
```

HIGHEST 04 OVERALL DAILY PEAKS LAST 04 DAILY PEAK SCCC LOADS

```
=====
8 TPS 08-05-15 15:28:36 8 TPS 08-05-18 00:00:00
8 TPS 08-05-15 15:28:37 8 TPS 08-05-17 00:00:01
8 TPS 08-05-17 00:00:01 8 TPS 08-05-16 00:00:00
8 TPS 08-05-18 00:00:00 8 TPS 08-05-15 15:28:37
```

Command Completed.

;

The following example displays output for a specified card when the EIR, G-Flex, and G-Port features are turned on, the INP, LNP, LRNQT, PLNP, TLNP, V-Flex, IAR, and WNP features are turned off, and the ATINP feature is not enabled. The **ansigflex** system option is disabled.

**rept-stat-sccp:loc=1105**

```
tklc1170501 09-07-08 10:16:51 EST EAGLE5 41.1.0
CARD VERSION TYPE PST SST AST
1105 126-030-000 DSM IS-NR Active -----
CARD ALARM STATUS = No Alarms.
GTT: STAT = ACT CPU USAGE = 1%
GFLEX: STAT = ACT CPU USAGE = 3%
GPORT: STAT = ACT CPU USAGE = 9%
EIR: STAT = ACT CPU USAGE = 2%
-----
TOTAL = 15%
```

CARD SERVICE STATISTICS

| SERVICE | SUCCESS | ERRORS | WARNINGS | FORWARD TO GTT | TOTAL |
|---------|---------|--------|----------|----------------|-------|
| GTT:    | 153     | 2      | -        | -              | 155   |
| GFLEX:  | 2582    | 0      | 0        | 0              | 2582  |
| GPORT:  | 8171    | 0      | 1        | 102            | 8274  |
| EIR:    | 3089    | 0      | -        | -              | 3089  |

Command Completed.

;

The following example displays the output when the G-Flex, G-Port, IAR, and Prepaid IDP Query Relay features are turned on. The EIR feature is not enabled, and the **ansigflex** system option is disabled.

**rept-stat-sccp**

```
tekelecstp 09-07-08 13:34:22 EST EAGLE5 41.1.0
SCCP SUBSYSTEM REPORT IS-NR Active -----
SCCP ALARM STATUS = No Alarms
GFLEX SERVICE REPORT IS-NR Active -----
GFLEX ALARM STATUS = No Alarms
GPORT SERVICE REPORT IS-NR Active -----
GPORT ALARM STATUS = No Alarms

SCCP Cards Configured=25 Cards IS-NR=25
System Daily Peak SCCP Load 15639 TPS 06-09-18 06:14:24
System Overall Peak SCCP Load 21062 TPS 06-09-15 14:24:38
System Total SCCP Capacity 21250 TPS (21250 max SCCP Capacity)
System SCCP Capacity Calc. Method (N)
System TPS Alarm Threshold 17000 TPS ( 80% System N SCCP Capacity)
```

| CARD   | VERSION     | PST   | SST    | AST   | MSU<br>USAGE | CPU<br>USAGE |
|--------|-------------|-------|--------|-------|--------------|--------------|
| 1217   | 126-030-000 | IS-NR | Active | ----- | 100%         | 45%          |
| 1317   | 126-030-000 | IS-NR | Active | ----- | 100%         | 51%          |
| 2217   | 126-030-000 | IS-NR | Active | ----- | 100%         | 42%          |
| 3201   | 126-030-000 | IS-NR | Active | ----- | 54%          | 25%          |
| 3203   | 126-030-000 | IS-NR | Active | ----- | 55%          | 25%          |
| 3205   | 126-030-000 | IS-NR | Active | ----- | 57%          | 27%          |
| 3207   | 126-030-000 | IS-NR | Active | ----- | 69%          | 29%          |
| 3211   | 126-030-000 | IS-NR | Active | ----- | 85%          | 35%          |
| 3213   | 126-030-000 | IS-NR | Active | ----- | 94%          | 37%          |
| 3215   | 126-030-000 | IS-NR | Active | ----- | 86%          | 35%          |
| 3217   | 126-030-000 | IS-NR | Active | ----- | 74%          | 31%          |
| 4217   | 126-030-000 | IS-NR | Active | ----- | 64%          | 28%          |
| 4317   | 126-030-000 | IS-NR | Active | ----- | 100%         | 41%          |
| 5117   | 126-030-000 | IS-NR | Active | ----- | 100%         | 40%          |
| 5317   | 126-030-000 | IS-NR | Active | ----- | 56%          | 25%          |
| 6101 P | 126-030-000 | IS-NR | Active | ----- | 57%          | 32%          |
| 6103   | 126-030-000 | IS-NR | Active | ----- | 63%          | 27%          |
| 6105   | 126-030-000 | IS-NR | Active | ----- | 69%          | 37%          |
| 6107   | 126-030-000 | IS-NR | Active | ----- | 66%          | 29%          |
| 6111   | 126-030-000 | IS-NR | Active | ----- | 59%          | 27%          |
| 6113   | 126-030-000 | IS-NR | Active | ----- | 55%          | 34%          |
| 6115   | 126-030-000 | IS-NR | Active | ----- | 55%          | 26%          |
| 6117   | 126-030-000 | IS-NR | Active | ----- | 54%          | 26%          |
| 1105   | 126-030-000 | IS-NR | Active | ----- | 55%          | 26%          |
| 1107   | 126-030-000 | IS-NR | Active | ----- | 55%          | 26%          |

-----  
 SCCP Service Average MSU Capacity = 71% Average CPU Capacity = 32%

AVERAGE CPU USAGE PER SERVICE:

```
GTT = 1% GFLEX = 4% GPORT = 0%
IDPR = 2%
IAR = 2%
```

TOTAL SERVICE STATISTICS:

| SERVICE | SUCCESS | ERRORS | FAIL<br>RATIO | REROUTE\<br>WARNINGS | FORWARD<br>TO GTT | TOTAL  |
|---------|---------|--------|---------------|----------------------|-------------------|--------|
| GTT:    | 3510    | 15     | 0%            | -                    | -                 | 3525   |
| GFLEX:  | 100043  | 0      | 0%            | 0                    | 0                 | 100043 |
| GPORT:  | 312203  | 0      | 0%            | 15                   | 1879              | 314097 |
| IDPR:   | 23157   | 0      | 0%            | 1                    | 23157             | 23157  |

```
IAR:          7680          0          0%          1          7680          7680
```

Command Completed.

;

The following example displays output for the specified card when the G-Flex, G-Port and Prepaid IDP Query Relay features are turned on; the EIR, LNP, LRNQT, PLNP, TLNP, V-Flex, IAR, and WNP features are turned off, and the ATINP feature is not enabled.

**rept-stat-sccp:loc=1105**

```
tekelecstp 09-07-11 13:34:22 EST EAGLE 41.1.0
CARD VERSION TYPE PST SST AST
1105 128-020-063 DSM IS-NR Active -----
CARD ALARM STATUS = ** 0446 RTDB database capacity is 80% full
GTT: STAT = ACT CPU USAGE = 10%
GFLEX: STAT = ACT CPU USAGE = 3%
GPORT: STAT = ACT CPU USAGE = 9%
IDPR: STAT = ACT CPU USAGE = 8%
-----
TOTAL = 30%
```

CARD SERVICE STATISTICS

| SERVICE | SUCCESS | ERRORS | WARNINGS | FORWARD TO GTT | TOTAL |
|---------|---------|--------|----------|----------------|-------|
| GTT:    | 0       | 0      | -        | -              | 0     |
| GFLEX:  | 2582    | 0      | 0        | 0              | 2582  |
| GPORT:  | 8171    | 0      | 1        | 102            | 8274  |
| IDPR:   | 10      | 0      | 0        | 10             | 10    |

Command Completed.

;

The following example displays output for a specified card when the G-Flex and G-Port features are turned on, the ATINP feature is enabled, and the EIR, INP, LNP, LRNQT, PLNP, TLNP, V-Flex, IAR, and WNP features are turned off. The **ansigflex** system option is disabled.

**rept-stat-sccp:loc=1105**

```
tklcl1170501 09-07-11 10:16:51 EST EAGLE 41.1.0
CARD VERSION TYPE PST SST AST
1105 126-030-000 DSM IS-NR Active -----
CARD ALARM STATUS = No Alarms.
GTT: STAT = ACT CPU USAGE = 1%
GFLEX: STAT = ACT CPU USAGE = 3%
GPORT: STAT = ACT CPU USAGE = 9%
ATINPQ: STAT = ACT CPU USAGE = 2%
-----
TOTAL = 15%
```

CARD SERVICE STATISTICS

| SERVICE | SUCCESS | ERRORS | WARNINGS | FORWARD TO GTT | TOTAL |
|---------|---------|--------|----------|----------------|-------|
| GTT:    | 153     | 2      | -        | -              | 155   |
| GFLEX:  | 2582    | 0      | 0        | 0              | 2582  |
| GPORT:  | 8171    | 0      | 1        | 102            | 8274  |
| ATINPQ: | 3089    | 0      | -        | -              | 3089  |

Command Completed.

;

The following example displays output when the GTT, LNP, and LRNQT features are turned on, the A-Port, EIR, G-Flex, G-Port, INP, PLNP, TLNP, V-Flex, IAR, and WNP features are turned off, and the ATINP feature is not enabled.

**rept-stat-sccp:loc=1106**

```
tekelecstp 09-07-11 02:20:49 EST EAGLE5 41.1.0
CARD VERSION TYPE PST SST AST
1106 ----- DSM IS-NR Active -----
CARD ALARM STATUS = No Alarms.
GTT: STAT = SWDL CPU USAGE = 0%
```

```

LNPMPR: STAT = ----- CPU USAGE = 0%
LNPQS:  STAT = ----- CPU USAGE = 0%
LRNQT:  STAT = ----- CPU USAGE = 0%
-----
TOTAL           = 0%

```

## CARD SERVICE STATISTICS

| SERVICE | SUCCESS | ERRORS | WARNINGS | FORWARD TO GTT | TOTAL |
|---------|---------|--------|----------|----------------|-------|
| GTT:    | 0       | 0      | -        | -              | 0     |
| LNPMPR: | 0       | 0      | -        | -              | 0     |
| LNPQS:  | 0       | 0      | -        | -              | 0     |
| LRNQT:  | 0       | 0      | -        | -              | 0     |

Command Completed.

;

The following example displays the output when the INP and INP CRP features are turned on.

**rept-stat-sccp**

```

tekelecstp 09-06-20 03:20:22 EST EAGLE5 41.1.0
SCCP SUBSYSTEM REPORT IS-NR Active -----
SCCP ALARM STATUS = No Alarms
INPQ SUBSYSTEM REPORT IS-NR Active -----
INPQ:  SSN STATUS = Allowed MATE SSN STATUS = -----
INP ALARM STATUS = No Alarms

SCCP Cards Configured= 1 Cards IS-NR= 1
System Daily Peak SCCP Load 2 TPS 02-01-26 00:09:39
System Overall Peak SCCP Load 18 TPS 02-01-25 22:12:20
System Total SCCP Capacity 850 TPS (850 max SCCP Capacity)
System SCCP Capacity Calc. Method (N)
System TPS Alarm Threshold 680 TPS ( 80% System N SCCP Capacity)

CARD VERSION PST SST AST MSU CPU
USAGE USAGE
-----
1101 P 075-024-000 IS-NR Active ----- 1% 2%
-----
SCCP Service Average MSU Capacity = 1% Average CPU Capacity = 2%

AVERAGE CPU USAGE PER SERVICE:
GTT = 1%
INPMR = 1% INPQ = 1%

TOTAL SERVICE STATISTICS:

SERVICE SUCCESS ERRORS FAIL REROUTE\ FORWARD
RATIO WARNINGS TO GTT TOTAL
GTT: 0 2 100% - - 2
INPMR: 0 0 0% 2 2 2
INPQ: 7 0 0% 7 - 7

```

Command Completed.

;

The following example displays the output when the INP and INP CRP features are turned on.

**rept-stat-sccp:loc=1101**

```

tekelecstp 09-06-20 03:21:14 EST EAGLE5 41.1.0
CARD VERSION TYPE PST SST AST
1101 075-024-000 DSM IS-NR Active -----
CARD ALARM STATUS = * 0022 Clock B for card failed, Clock A normal
GTT: STAT = ACT CPU USAGE = 1%
INPMR: STAT = ACT CPU USAGE = 1%
INPQ: STAT = ACT CPU USAGE = 1%
-----
TOTAL = 3%

```



| CARD SERVICE STATISTICS |         |        |          |            |     |       |
|-------------------------|---------|--------|----------|------------|-----|-------|
| SERVICE                 | SUCCESS | ERRORS | WARNINGS | FORWARD TO | GTT | TOTAL |
| GTT:                    | 0       | 6      | -        | -          | -   | 6     |
| INPMR:                  | 0       | 0      | 6        | 6          | 6   | 6     |
| INPQ:                   | 10      | 0      | 10       | -          | -   | 10    |

Command Completed.

;

### Legend

This section defines the fields of the three **rept-stat-sccp** reports:

- **rept-stat-sccp** with no parameters
- **rept-stat-sccp:mode=perf**
- **rept-stat-sccp:loc= nnnn**

A dash (-) in an output field indicates that the statistic does not apply.

**NOTE: The ERRORS and TOTAL ERRORS fields indicate that errors have occurred for Service Module (SCCP) cards in the system. Refer to UIMs generated by the system for the specific errors, and refer to the *Maintenance Manual* for error explanations and recovery procedures.**

*Report Type: rept-stat-sccp with no parameters*

**SCCP SUBSYSTEM REPORT, INPQ/EIR/VFLEX/LNP SUBSYSTEM REPORT**—The summaries of the ATINPQ, EIR, INPQ (INP Query), V-Flex, LNP, and SCCP subsystem status. Information about the status of ATINP, EIR, GSM, INPMR (INP Message Relay), V-Flex, AND LNP services is provided in the SCCP subsystem status summary report. The INPQ subsystem status is displayed only if the INP feature is turned on. The EIR subsystem status is displayed only if the EIR feature is enabled and turned on. The V-Flex subsystem status is displayed only if the V-Flex feature is enabled and turned on. The ATINPQ subsystem status is displayed only if the ATINP feature is enabled. The LNP subsystem status is displayed only if the LNP feature is enabled. The ALARM STATUS for the SCCP and INPQ/EIR/V-Flex/ATINPQ/LNP subsystems is displayed in this section of the report.

**SCCP CARDS CONFIGURED**—The number of provisioned Service Module cards running the **vsccp** application.

**CARD IS-NR**—The number of Service Module cards that can be used by the system (status is In-Service Normal, IS-NR).

**SYSTEM TPS ALARM THRESHOLD**—The percentage of traffic that when reached triggers an alarm to warn that the EAGLE 5 ISS is approaching the total system SCCP transactions-per-second (TPS) capacity. This value is set by the **chg-th-alm** command.

**SYSTEM PEAK SCCP LOAD**—The highest SCCP transactions-per-second (TPS) processed by the EAGLE 5 ISS.

**SYSTEM TOTAL SCCP CAPACITY**—The current total system SCCP transactions-per-second (TPS) capacity. This value is the sum of the maximum capacity of all active SCCP cards. When the **ansigflex** system option is enabled in an ANSI system, the maximum capacity of each DSM card is 1700 TPS. When the EAGLE 5 SCCP Capacity Increase feature is turned on, the maximum capacity of each E5-SM4G card is 6800 TPS regardless of the status of other features.

**CARD**—The card location of the cards running the VSCCP application.

**P**—When G-Flex, G-Port, INP, A-Port, EIR, V-Flex, IAR, or IGM is turned on, a P indicates the primary Service Module card. The primary Service Module card provides the MPS status to the EAGLE 5 ISS. This indicator is displayed between the card location and the GPL version.

**VERSION**—The version number of the GPL running on the Service Module card.

**PST**—The primary state of the card. The possible values are described in "Possible Values for PST/SST/AST".

**SST**—The secondary state of the card. The possible values are described in "Possible Values for PST/SST/AST".

**AST**—The associated state of the card. The possible values are described in "Possible Values for PST/SST/AST".

**MSU USAGE**—The percentage of the maximum number of MSUs (850 MSUs per second for DSM cards and up to 5000 MSUs per second for E5-SM4G cards) received by each card during the last 30 seconds.

**CPU USAGE**—The percentage of the amount of CPU used by each card during the last 30 seconds to process messages and to handle other foreground and background tasks.

**SCCP SERVICE AVERAGE MSU CAPACITY**—The average MSU capacity used over the last 30-second interval. This field includes all services provided by the Service Module cards.

**AVERAGE CPU CAPACITY**—The average CPU capacity used over the last 30-second interval. This field includes all services provided by the Service Module cards.

**AVERAGE CPU USAGE PER SERVICE**—A system-wide view of the service traffic composition. This report is available only if the A-Port, EIR, G-Flex, G-Port, IGM, INP, IAR, or V-Flex feature is turned on, or the ATINP feature is enabled. Fields are omitted if the associated feature is not turned on. The services include ATINPQ, EIR, G-Flex, G-Port, GTT, INPMR, INPQ, MNP, IAR, and V-Flex.

**TOTAL SERVICE STATISTICS**—A system-wide view of per-service statistics. This report is available only if the A-Port, EIR, G-Flex, G-Port, IGM, INP, IAR, or V-Flex feature is turned on, or the ATINP feature is enabled. Fields are omitted if the associated feature is not turned on.

An "A" in the field indicates that the statistic does not apply.

The report tracks the following information:

**SERVICE**—The services are GTT, EIR, G-Flex, INPQ, G-Port, INPMR, V-Flex, IAR, and MNP.

**SUCCESS**—The total number of successful messages processed by the specified card for each service. Applies to all services.

**ERRORS**—The total number of messages with errors for each service. Applies to all services.

**WARNINGS**—The total number of messages that output UIM warnings and were forwarded to GTT by the specified card for G-Flex, G-Port, INPMR, A-Port, IAR, and IGM.

**FORWARD TO GTT**—The total number of messages that could not find a match in the MPS (Multi-Purpose Server) database (did not produce any errors or warnings) and were successfully forwarded to GTT by the specified card for G-Flex, G-Port, INPMR, A-Port, IAR, and IGM.

*Report Type:* **rept-stat-sccp:mode=perf**

The report displays general SCCP traffic performance for Service Module cards and supplies message rates for TVG.

**NOTE: This report includes the status of DSM cards and E5-SM4G cards, but does not differentiate between these card types.**

**SCCP SUBSYSTEM REPORT**—The summary status of the SCCP subsystem, and the SCCP Alarm Status.

**SCCP CARDS CONFIGURED**—The number of Service Module cards provisioned.

**CARD IS-NR**—The number of Service Module cards that can be used by the system (status is in-service normal, IS-NR).

**SYSTEM TPS ALARM THRESHOLD**—The percentage of traffic that when reached triggers an alarm to warn that the EAGLE 5 ISS is approaching the total system SCCP transactions-per-second (TPS) capacity. This value is set by the **chg-th-alm** command.

**SYSTEM PEAK SCCP LOAD**—The highest SCCP transactions-per-second (TPS) processed by the EAGLE 5 ISS.

**SYSTEM TOTAL SCCP CAPACITY**—The current total system SCCP transactions-per-second (TPS) capacity. This value is the sum of the maximum capacity of all active Service Module cards.

**TPS STATISTICS**—The section of the report that provides TPS statistics on each Service Module card.

**CARD**—The card location of the cards running the VSCCP application.

**CPU USAGE**—The percentage of the amount of CPU used to process messages by each card during the last 30 seconds.

**TOTAL MSU RATE**—The total number of messages processed per second. This and the other message rates are obtained from statistics maintained by the Service Module card for the last 30-second period.

**CLASS 0 AND CLASS 1 TVG RATE**—The number of messages per second received.

The next section of the **rept-stat-sccp:mode=perf** report provides system-wide SCCP traffic statistics.

**AVERAGE MSU USAGE**—The total of the MSU usage fields from each Service Module card divided by the number of active Service Module cards.

**AVERAGE CPU USAGE**—The total of the CPU usage fields from each Service Module card divided by the number of active Service Module cards.

**TOTAL MSU RATE**—The sum of all GTT, EIR, G-Flex, G-Port, INP, A-Port, V-Flex, LNP, IAR, and IGM MSUs processed by all active Service Module cards.

**STATISTICS FOR PAST 30 SECONDS**—statistics that represent the last 30-second period.

**TOTAL MSUS**—The sum of all transactions on all active Service Module cards.

**TOTAL ERRORS**—The sum of all errors on all active Service Module cards.

*Report Type:* **rept-stat-sccp:loc=nnnn**

**CARD**—The card location of the card running the VSCCP application.

**VERSION**—The version number of the GPL the card is running.

**TYPE**—The type of the card.

**PST**—The primary state of the card. The possible values are described in "Possible Values for PST/SST/AST".

**SST**—The secondary state of the card. The possible values are described in "Possible Values for PST/SST/AST".

**AST**—The associated state of the card. The possible values are described in "Possible Values for PST/SST/AST".

**CARD ALARM STATUS**—If there are no card alarms present, this field displays No Alarms.

The next section of the **rept-stat-sccp:loc=nnnn** report supplies the status of the individual services provided by the card and the associated CPU usage for the service. Fields are omitted if the associated feature is not turned on.

**GTT: STAT**—Possible values are ACTIVE and SWDL (software loading).

**GFLEX: STAT**—Possible values are ACTIVE and SWDL (software loading).

**GPORT OR MNP: STAT**—Possible values are ACTIVE and SWDL (software loading).

**INPMR: STAT**—Possible values are ACTIVE, OFFLINE, and SWDL (software loading).

**INPQ: STAT**—Possible values are ACTIVE, OFFLINE, and SWDL (software loading).

**EIR: STAT**—Possible values are ACTIVE, OFFLINE and SWDL (software loading).

**VFLEX: STAT**—Possible values are ACTIVE, OFFLINE and SWDL (software loading).

**LNPMPR: STAT**—Possible values are ACTIVE, OFFLINE and SWDL (software loading).

**LNPQS: STAT**—Possible values are ACTIVE, OFFLINE and SWDL (software loading).

**WNPQS: STAT**—Possible values are ACTIVE, OFFLINE and SWDL (software loading).

**TLNP: STAT**—Possible values are ACTIVE, OFFLINE and SWDL (software loading).

**PLNPQS: STAT**—Possible values are ACTIVE, OFFLINE and SWDL (software loading).

**LRNQT: STAT**—Possible values are ACTIVE, OFFLINE and SWDL (software loading).

**TOTAL**—The sum of the CPU usage for the services running over the previous 30-second period.

**CARD SERVICE STATISTICS**—The card service statistics for the specified card. This report is available for the GTT, G-Flex, G-Port, INP, A-Port, EIR, V-Flex, IGM, ATINP, IAR, LNP, LNPMR, LNPQS, WNPQS, TLNP, PLNPQS and LRNQT features. Fields are omitted if their associated feature is not turned on (or not enabled for ATINP). The report tracks the following:

**SERVICE**—The services are ATINPQ, EIR, G-Flex, G-Port, GTT, INPMR, INPQ, MNP, V-Flex, IAR, LNPMR, LNPQS, WNPQS, TLNP, PLNPQS and LRNQT.

**SUCCESS**—The total number of successful messages processed by the specified card for each service. Applies to all services.

**ERRORS**—The total number of messages with errors for each service. Applies to all services.

**WARNINGS**—The total number of messages that output UIM warnings and were forwarded to GTT by the specified card for EIR, G-Flex, G-Port, INPMR, A-Port, IAR, and IGM.

**FORWARD TO GTT**—The total number of messages that could not find a match in the MPS database (did not produce any errors or warnings) and were successfully forwarded to GTT by the specified card for EIR, G-Flex, G-Port, INPMR, A-Port, IAR, and IGM.

## rept-stat-seas

## Report Status SEAS Command

Use this command to generate a summary report of the status of the SEAS subsystem on the EAGLE 5 ISS. This command reports single OSS/Application Processor (OAP) or dual OAP configuration status, depending on the OAP hardware configuration used. See the *Maintenance Manual* for information about the SEAS alarms.

**NOTE: If the SEAS Over IP feature is turned on, then the status of the CCS MR connections is displayed. If the SEAS Over IP feature is turned off, then the X.25 connection status is displayed.**

**Keyword:** rept-stat-seas

**Related Commands:** alw-trm, chg-trm, inh-trm, rept-stat-sys, rept-stat-trbl, rept-stat-trm

**Command Class:** System Maintenance

**Parameters**

This command has no parameters.

**Example**

**rept-stat-seas**

**Dependencies**

At least one OAP terminal or one SEAS terminal must be defined using the **chg-trm** command.

No other **rept-stat-xxx** command can be in progress when this command is entered.

**Notes**

None

**Output**

The following example shows the output of command when the SEAS feature is turned on and the SEAS Over IP feature is turned off.

**rept-stat-seas**

```
rlghncxa03w 07-02-04 15:59:06 EST EAGLE 37.5.0
SEAS Subsystem Report      IS-NR      Active  -----
SEAS Interfaces Configured = 2  Interfaces IS-NR = 2
                                GPL          PST          SST          AST
-----
SEAS SYSTEM                IS-NR      Active  -----
TDM Port                    4          IS-NR      Active  -----
TDM Port                    10         IS-NR      Active  -----
OAP                         A          250-001-000 IS-NR      Active  -----
OAP                         B          250-001-000 IS-NR      Active  -----
X.25 Link                   A1         IS-NR      Active  -----
X.25 Link                   B1         IS-NR      Active  -----

SEAS SYSTEM ALARM STATUS = No Alarms.
OAP A       ALARM STATUS = No Alarms.
OAP B       ALARM STATUS = No Alarms.
X25 Link A1 ALARM STATUS = No Alarms.
X25 Link A2 ALARM STATUS = No Alarms.
X25 Link B1 ALARM STATUS = No Alarms.
X25 Link B2 ALARM STATUS = No Alarms.

X25 A1 PVCs IS-NR      = 1,2,3
X25 A1 PVCs OOS-MT    = ---
X25 B1 PVCs IS-NR      = 1,2,3
X25 B1 PVCs OOS-MT    = ---

X25 A2 PVCs IS-NR      = 1,2,3
X25 A2 PVCs OOS-MT    = ---
X25 B2 PVCs IS-NR      = 1,2,3
X25 B2 PVCs OOS-MT    = ---
Command Completed.
```

;

The following example shows the output of the command when the SEAS Over IP feature is turned on.

**rept-stat-seas**

```
tekelecstp 07-01-11 16:47:51 EST EAGLE 37.5.0

SEAS SYSTEM                PST          SST          AST
-----
ALARM STATUS = No Alarms
                                IS-NR      Avail      -----

TERM          IPADDR          PORT  PST          SST          AST
-----
18            120.30.10.11    15    IS-NR      Active      -----
ALARM STATUS = No Alarms

40            128.30.15.12    16    IS-NR      Active      -----
ALARM STATUS = No Alarms
```

**Legend**

**PST**—The primary state of the subsystem. The possible values are described in "Possible Values for PST/SST/AST".

**SST**—The secondary state of the subsystem. The possible values are described in "Possible Values for PST/SST/AST".

**AST**—The associated state of the subsystem. The possible values are described in .

**SEAS SYSTEM**—The overall SEAS component.

## rept-stat-seculog

### Display Security Log Status Information

Use this command to display the following information about the security log on the active and standby OAMs:

- The active or standby status of each log
- The number of new (that is, not uploaded) entries in each log
- The percentage of log space used by those new entries
- Whether overflow has occurred since the last upload
- Whether a recording failure has occurred since the last upload
- The date and time of the oldest and newest records in the log
- The date and time when the last successful upload of the log occurred

**Keyword:** `rept-stat-seculog`

**Related Commands:** `chg-attr-seculog`, `rtrv-attr-seculog`

**Command Class:** Security Administration

### Parameters

This command has no parameters.

### Example

```
rept-stat-seculog
```

### Dependencies

No other security log command can be in progress when this command is entered.

### Notes

The %FULL field displays the amount of space in the log taken up by new (not uploaded) entries. That number is obtained by dividing the number displayed in the ENTRIES field by the overall storage capacity of the log (10,000 entries). Because the log stays full of entries at all times, new entries overwrite existing entries.

The percentage full computed is rounded up to the next integer with one exception: the value of 100 is not displayed until the log is truly 100% full.

The log capacity is 10,000 records. To determine how many more commands can be logged before an overflow condition occurs, subtract the value displayed in the ENTRIES field from 10,000.

The status of the active OAM's log is always reported first in the output report, followed by the status of the standby log; in other words, they are not *necessarily* displayed numerically by the location number.

The report displays dates in the format *yy-mm-dd*, where *yy* is the year, *mm* is the month, and *dd* is the date. The report displays times in the format of *hh:mm:ss*, where *hh* is hours, *mm* is minutes, and *ss* is seconds.

**Output**

The following example shows the normal security log state. All of the un-uploaded records appear in the log on the active OAM.

**rept-stat-seculog**

```
rlghncxa03w 05-07-29 16:40:40 EST EAGLE 28.1.0
-- SINCE LAST UPLOAD -- OLDEST NEWEST LAST
LOC ROLE ENTRIES %FULL OFLO FAIL RECORD RECORD UPLOAD
1114 Active 8312 84 No No 96-08-12 05-07-04 05-07-16
11:23:56 15:59:06 14:02:22

1116 Standby 0 0 No No 96-09-12 05-07-30 05-07-30
11:24:12 14:00:06 14:02:13
```

;

The following example shows an abnormal situation. The active security log is full and has overflowed.

**rept-stat-seculog**

```
rlghncxa03w 05-07-29 16:40:40 EST EAGLE 28.1.0
-- SINCE LAST UPLOAD -- OLDEST NEWEST LAST
LOC ROLE ENTRIES %FULL OFLO FAIL RECORD RECORD UPLOAD
1114 Active 10000 100 Yes No 96-08-12 05-07-04 05-07-16
11:23:56 15:59:06 14:02:22

1116 Standby 0 0 No No 96-09-12 05-07-30 05-07-30
11:24:12 14:00:06 14:02:13
```

;

The following example shows what happens when both logs contain un-uploaded entries. The standby log on 1116 should be uploaded.

**rept-stat-seculog**

```
rlghncxa03w 05-07-29 16:40:40 EST EAGLE 28.1.0
-- SINCE LAST UPLOAD -- OLDEST NEWEST LAST
LOC ROLE ENTRIES %FULL OFLO FAIL RECORD RECORD UPLOAD
1114 Active 8312 84 No No 96-08-12 05-07-04 05-07-16
11:23:56 15:59:06 14:02:22

1116 Standby 693 7 No No 96-09-12 05-07-30 05-07-30
11:24:12 14:00:06 14:02:13
```

;

The following example shows how, if data cannot be retrieved from the standby OAM (for example, in simplex mode), blanks (-----) are displayed.

**rept-stat-seculog**

```
rlghncxa03w 05-07-29 16:40:40 EST EAGLE 28.1.0
-- SINCE LAST UPLOAD -- OLDEST NEWEST LAST
LOC ROLE ENTRIES %FULL OFLO FAIL RECORD RECORD UPLOAD
1114 Active 8312 83 No No 96-08-12 05-07-04 05-07-16
11:23:56 15:59:06 14:02:22

1116 Standby ----- --- --- --- -----
-----
```

;

**Legend**

**LOC**—The address of the TDM card (with the hard disk on it) that contains the log. It is always the card at location 1114 or 1116.

**ROLE**—The current role of the security log at that location. This value is always the same as the role of the OAM associated with the TDM card: **active** or **standby**.



-- **SINCE LAST UPLOAD**—This heading applies to the four columns directly below it on the output. It indicates that the fields below display information obtained since the last upload.

**ENTRIES**—Shows how many un-uploaded commands are currently recorded in the log. This value resets to 0 (zero) when the log is uploaded using **copy-seculog**.

**%FULL**—Shows, as a percentage, how much space in the log the ENTRIES field value occupies.

**OFLO**—The overflow indicator. Overflow is what happens if the log is not uploaded periodically: new entries start overwriting un-uploaded entries. This field displays **No** if no overflow has occurred and **Yes** if overflow has occurred.

**FAIL**—The failed indicator. This field displays **No** if no logging failure has occurred. It displays **Yes** to indicate that a logging failure has occurred that has prevented one or more entries from being recorded in the log successfully.

**NOTE:** Whether the system is able to set the logging failure flag in the security log header depends on the nature of the failure. If a **copy-disk** command is processing, the system sets the flag when the **copy-disk** command finishes processing. However, if the active fixed disk fails for some reason, or the security log happens to be in a bad sector that develops, the system is unable to set the logging failure flag.

**OLDEST RECORD/NEWEST RECORD**—The date and time recorded in the oldest and newest record in the log. Allows the administrator to know the time period that the log covers. The log records all commands that were issued between 6/3/96 at 13:45:03 up to 8/5/96 at 06:58:55. The **NEWEST RECORD** for the active log is the current date, because the log will have recorded the **rept-stat-seculog** command that was just entered to produce the report.

**LAST UPLOAD**—The date and time when the log was last uploaded successfully. That is, the **copy-seculog** command successfully copied the log to the FTA.

## rept-stat-slan

## Report Status of the STPLAN

Use this command to generate a summary report of the status of the DCM and E5-ENET cards that make up the STPLAN subsystem.

**Keyword:** **rept-stat-slan**

**Related Commands:** **rept-stat-alm, rept-stat-card, rept-stat-dlk, rept-stat-imt, rept-stat-sys, rept-stat-trbl**

**Command Class:** System Maintenance

### Parameters

**:mode=** (optional)

Use this parameter to provide extended performance information, including group ticket voucher (TVG) message rates.

**Range:** **perf**

**Default:** No extended performance information is displayed

### Example

```
rept-stat-slan
```

```
rept-stat-slan:mode=perf
```

### Dependencies

No other **rept-stat-xxx** commands can be in progress when this command is entered.

At least one DCM or E5-ENET card that makes up the STPLAN must be configured.

**Notes**

The HOST CAP. field value is obtained by averaging the usage percentages for the data links from each DCM, and E5-ENET card to the host.

The EAGLE CAP. field value is obtained by averaging the usage percentages for the DCM and E5-ENET traffic received from LIMs.

The system level usage for host capacity (the AVERAGE USAGE PER HOST CAPACITY field in the **rept-stat-slan** output) is obtained by averaging the usage percentages for the data links to the host from each DCM and E5-ENET card.

The EAGLE 5 ISS level usage for DCM and E5-ENET cards capacity (the AVERAGE USAGE PER EAGLE CAPACITY field in the **rept-stat-slan** output) is obtained by averaging the usage percentages for the DCM and E5-ENET traffic received from LIMs.

**Output**

The following example shows output with at least one ACM in an IS-NR state:

**rept-stat-slan**

```
rlghncxa03w 04-02-27 16:53:22 EST EAGLE 31.3.0
SLAN Subsystem Report IS-NR Active -----
SLAN Cards Configured= 2 Cards IS-NR= 2
CARD VERSION PST SST AST HOST Cap. EAGLE Cap.
-----
1206 021-010-000 IS-NR Active ---- 42% 16%
1104 021-010-000 IS-NR Active ALMINH 36% 12%
-----
AVERAGE USAGE per HOST CAPACITY = 39%
AVERAGE USAGE per EAGLE CAPACITY = 14%
CARDS DENIED SLAN SERVICE:
1101, 1204
Command Completed.
```

;

**rept-stat-slan:mode=perf**

```
rlghncxa03w 04-02-04 13:36:07 EST EAGLE 31.3.0
SLAN Subsystem Report IS-NR Active -----
SLAN Cards Configured= 3 Cards IS-NR= 3
CARD HOST EAGLE TVG
CAP CAP RATE
-----
1101 50% 30% 140
1102 55% 33% 435
1103 47% 28% 435
-----
AVERAGE USAGE per HOST CAPACITY = 51%
AVERAGE USAGE per EAGLE CAPACITY = 30%
Command Completed.
```

;

**Legend**

**SLAN SUBSYSTEM REPORT**—The status of the STPLAN subsystem.

**STPLAN CARDS CONFIGURED**—The number of DCM and E5-ENET cards used by the STPLAN contained in the system.

**CARDS IS\_NR**—The number of DCM and E5-ENET cards contained in the system whose status is in service normal (IS-NR).

**CARD**—The locations of the DCM and E5-ENET cards.

**VERSION**—The version number of the GPL running on the STPLAN card.

**PST**—The primary state of the DCM and E5-ENET cards. The possible values are described in "Possible Values for PST/SST/AST".

**SST**—The secondary state of the DCM and E5-ENET cards. The possible values are described in "Possible Values for PST/SST/AST".

**AST**—The associated state of the DCM and E5-ENET cards. The possible values are described in .

**HOST CAP**—The amount of traffic being sent to the host from each DCM and E5-ENET card, expressed as a percentage of the total amount of traffic that can be sent to the host.

**EAGLE CAP**—The amount of traffic being sent to each DCM and E5-ENET card, that is received from the LIMs, expressed as a percentage of the total amount of traffic that can be sent to the DCM and E5-ENET card.

**AVERAGE USAGE PER HOST CAPACITY** The amount of traffic being sent to all hosts from all DCM and E5-ENET cards, expressed as a percentage of the total amount of traffic that can be sent to all hosts from all DCM, and E5-ENET cards.

**AVERAGE USAGE PER EAGLE CAPACITY**—The amount of traffic being sent to all DCM and E5-ENET cards that is received from the LIMs, expressed as a percentage of the total amount of traffic that can be sent to all DCM and E5-ENET cards.

**CARDS DENIED SLAN SERVICE**—The card locations that cannot use the STPLAN application.

**CARDS DISABLED COPY SERVICE**—The card locations that cannot use the stop and copy action of the gateway screening feature.

Instead of displaying the VERSION , PST , SST , AST , HOST CAP , EAGLE CAP, and CARDS DENIED SLAN SERVICE fields, the report displayed with the **rept-stat-slan:mode=perf** command shows these fields:

**HOST CAP**—The average of the usage percentages for the TCP/IP data links to the host from each DCM and E5-ENET card.

**EAGLE CAP**—The average of the usage percentages for the DCM and E5-ENET traffic that is received from the LIMs.

**TVG RATE**—The number of messages per second received from all SS7 links, and any other group ticket voucher paced message source. It is obtained from statistics maintained by the DCM and E5-ENET cards for the last 30-second period.

**AVERAGE USAGE PER HOST CAPACITY**—The amount of traffic being sent to all hosts from all DCM and E5-ENET cards, expressed as a percentage of the total amount of traffic that can be sent to all hosts from all DCM and E5-ENET cards.

**AVERAGE USAGE PER EAGLE CAPACITY**—The amount of traffic being sent to all DCM and E5-ENET cards that is received from the LIMs, expressed as a percentage of the total amount of traffic that can be sent to all DCM and E5-ENET cards.

## rept-stat-slk

### Report Status Signaling Link

Use this command to generate a report of the MTP signaling links status. The secondary state (SST) indicates whether the link is available, unavailable, or manually removed from service.

Use this command to generate a separate report of status of the E1 associated with a signaling link. The status includes the **e1loc** parameter (card location of the E1 card) and the UAM text. If the E1 association is not provisioned, “E1 association unknown” is displayed. If the card is not type **lime1** or **limch**, no E1 output is generated.

Use this command to generate a separate report of status of the T1 associated with a signaling link. The status includes the **t1loc** parameter (card location of the T1 card) and the UAM text. If the card is not type **limt1** or **limch**, no T1 output is generated.

**Keyword:** **rept-stat-slk**

**Related Commands:** **act-slk, blk-slk, dact-slk, dlt-slk, ent-slk, inh-slk, rtrv-slk, tst-slk, ublk-slk, unhb-slk**

**Command Class:** System Maintenance

### Parameters

**:l2stats=** (optional)

Report L2 status

**Range:** **align, both, brief, no, service**

**align** — Display alignment data only

**both** — Display alignment and service data  
**brief** — Display up to 10 alignment events only  
**no** — Do not display level 2 status information  
**service** — Display service data only

**Default:** **no**

**:link=** (optional)

The signaling link on the card specified in the **loc** parameter. The linkss can be specified in any sequence or pattern.

**Synonym:** **port**

**Range:** **a, b, a1-a31, b1-b31**

Not all card types support all **link** parameter values.

See Table A-1 for valid **link** parameter range values for each type of card that can have assigned signaling link ports.

**Default:** Display all

**:loc=** (optional)

The card location as stenciled on the shelf of the system.

**Range:** **1101-1108, 1111-1112, 1201-1208, 1211-1218, 1301-1308, 1311-1318, 2101-2108, 2111-2118, 2201-2208, 2211-2218, 2301-2308, 2311-2318, 3101-3108, 3111-3118, 3201-3208, 3211-3218, 3301-3308, 3311-3318, 4101-4108, 4111-4118, 4201-4208, 4211-4218, 4301-4308, 4311-4318, 5101-5108, 5111-5118, 5201-5208, 5211-5218, 5301-5308, 5311-5318, 6101-6108, 6111-6118**

**Default:** All cards containing signaling links are displayed.

**:stat=** (optional)

A report on cards whose status is the same as the state indicated by the parameter

**Range:** **all, alminh, anr, dsbld, mt, nr**

**all** — All of the primary states

**alminh** — Alarms inhibited

**anr** — In-Service-Abnormal (IS-ANR)

**dsbld** — Out-of-Service-Maintenance-Disabled (OOS-MT-DSBLD)

**mt** — Out-of-Service-Maintenance (OOS-MT)

**nr** — In-Service-Normal (IS-NR)

**Default:** Display all

## Example

```
rept-stat-slk
```

```
rept-stat-slk:loc=1201:link=a
```

```
rept-stat-slk:stat=alminh
```

```
rept-stat-slk:loc=1203:link=b:l2stats=both
```

```
rept-stat-slk:loc=1203:link=b:l2stats=brief
```

## Dependencies

No other **rept-stat-xxx** command can be in progress when this command is entered.

If the **loc** parameter or the **link** parameter is specified, then the **stat** parameter cannot be specified.

When the **loc** parameter is specified, the **link** parameter must be specified.

The card must be equipped and must be one of the following cards:

- An E1 ATM card running the **atmitu** application
- An E1/T1 MIM, E5-E1T1, or HC MIM card running the **ss7ansi** or **ccs7itu** application

- An E5 ATM card running the **atmansi** or **atmitu** application
- An E5-ENET card running the **ipsg** application
- An E5-ENET card or SSEDCCM card running the **iplim** or **iplimi** application with links having **ipliml2=m2pa**
- A LIM card running the **ss7ansi**, **ss7gx25**, or **ccs7itu** application
- A LIM ATM card running the **atmansi** application

The location specified by the **loc** parameter cannot be one of those reserved for non-LIM or non-DCM cards.

The signaling link must be an SS7 signaling link to display level 2 statistics (**l2stats**).

On TCP/IP point-to-multipoint links (SSEDCCM or E5-ENET cards equipped as SS7IPGW or IPGWI links), **l2stats** output is not available.

The following **link** parameter values can be specified for the following cards that support more than 2 links per card:

- **a1-a3, b1-b3**—Multi-port LIM (MPL), SSEDCCM card running the **iplim** or **iplimi** application with links having **ipliml2=m2pa**, E1/T1 MIM card
- **a1-a31, b1-b31**—HC-MIM card
- **a1-a15, b1-b15**—E5-E1T1 card
- **a1-a7, b1-b7**—E5-ENET card running the **iplim** or **iplimi** application that supports 16 links.
- **a1-a15, b1-b15**—E5-ENET card running the **ipsg** application

The specified signaling link must be provisioned in the database.

A card location that is valid and defined in the database must be specified.

The card in the specified card location (**loc** parameter) must be in service.

The **link=b** parameter cannot be specified for ss7ipgw TCP/IP links.

Neither the **stat** or **loc** and **port** parameters can be specified with this command.

## Notes

Not every card location represents a signaling link. Be sure to address a signaling link in this command.

This command can be canceled using the **F9** function key or the **canc-cmd** command. See **canc-cmd** for more information.

The *Installation Manual – EAGLE 5 ISS* provides an illustration of card locations.

Output

**rept-stat-slk**

```
rlghncxa03w 04-02-27 17:00:36 EST EAGLE 31.3.0
SLK      LSN      CLLI      PST      SST      AST
1201,A   lsnssp2  -----  IS-NR    Avail    ----
1201,B   lsnstpi  -----  IS-NR    Avail    ----
1202,A   lsnstpn  -----  IS-NR    Avail    ----
1202,B   lsnstpi  -----  IS-NR    Avail    ----
1203,A   lsnstpa  -----  IS-NR    Avail    ----
1203,B   lsnscpa  -----  IS-NR    Avail    ----
1205,A   lsnscpi  -----  IS-NR    Avail    ----
1205,B   lsnsspi1 -----  IS-NR    Avail    ----
1207,A   lsnstpa  -----  IS-NR    Avail    ----
1207,B   lsnsspa1 -----  IS-NR    Avail    ----
1211,A   lsnstpn  -----  IS-NR    Avail    ----
1211,B   lsnssp1  -----  IS-NR    Avail    ----
Command Completed.
```

;

**rept-stat-slk:loc=1201:link=a**

```
rlghncxa03w 04-02-04 13:06:25 EST EAGLE 31.3.0
SLK      LSN      CLLI      PST      SST      AST
1201,A   lsnssp2  -----  OOS-MT   Unavail  ----
ALARM STATUS      = * 0213 REPT-LKF: received SIOS
UNAVAIL REASON    = PE NA
Command Completed.
```

;

**rept-stat-slk:stat=alminh**

```
rlghncxa03w 04-02-23 12:57:50 EST EAGLE 31.3.0
SLK      LSN      CLLI      PST      SST      AST
1205,A   lsnscpi  -----  IS-NR    Avail    ALMINH
1211,A   lsnstpn  -----  IS-NR    Avail    ALMINH
Command Completed.
```

;

The following example shows output that includes a multi-port LIM:

**rept-stat-slk**

```
rlghncxa03w 04-02-23 12:57:50 EST EAGLE 31.3.0
SLK      LSN      CLLI      PST      SST      AST
1201,A   lsnssp2  -----  IS-NR    Avail    ----
1201,B   lsnstpi  -----  IS-NR    Avail    ----
1202,A   lsnstpn  -----  IS-NR    Avail    ----
1202,B   lsnstpi  -----  IS-NR    Avail    ----
1203,A   lsnstpa  -----  IS-NR    Avail    ----
1203,B   lsnscpa  -----  IS-NR    Avail    ----
1203,A1  lsnstpi  -----  IS-NR    Avail    ----
1203,B1  lsnscpi  -----  IS-NR    Avail    ----
1203,A2  lsnstpb  -----  IS-NR    Avail    ----
1203,B2  lsnscpb  -----  IS-NR    Avail    ----
1203,A3  lsnstpc  -----  IS-NR    Avail    ----
1203,B3  lsnscpc  -----  IS-NR    Avail    ----
1205,A   lsnscpi  -----  IS-NR    Avail    ALMINH
1205,B   lsnsspi1 -----  IS-NR    Avail    ----
1207,A   lsnstpa  -----  IS-NR    Avail    ----
1207,B   lsnsspa1 -----  IS-NR    Avail    ----
1211,A   lsnstpn  -----  OOS-MT   Unavail  ALMINH
1211,B   lsnssp1  -----  OOS-MT   Unavail  ----
Command Completed.
```

;

**rept-stat-slk:loc=1203:link=a:l2stats=both**

```
rlghncxa03w 04-02-04 13:06:25 EST EAGLE 31.3.0
SLK      LSN      CLLI      PST      SST      AST
```

```

1203,A lsnsspn2 ----- OOS-MT-DSBLD Unavail ----
  ALARM STATUS   = ** 0236 REPT-LKS:not aligned
  UNAVAIL REASON = NA
Event Type      Event                               Timestamp
SSCOP State     Idle                               04-02-04 10:04:23.000
SSCOP State     Outgoing Conn. Pending                04-02-04 10:04:23.000
SSCOP State     Incoming Conn. Pending              04-02-04 10:05:31.100
SSCOP State     Outgoing Disc. Pending                  04-02-04 10:05:31.100
SSCOP State     Outgoing Resync Pending                  04-02-04 10:05:31.105
SSCOP State     Incoming Resync Pending                 04-02-04 10:05:31.105
SSCOP State     Outgoing Recovery Pending               04-02-04 10:05:46.425
SSCOP State     Recovery Response Pending               04-02-04 10:05:46.430
SSCOP State     Incoming Recovery Pending              04-02-04 10:05:46.430
SSCOP State     Data Transfer Ready                    04-02-04 10:06:02.110
SSCF State      OOS Idle                               04-02-04 10:06:02.120
SSCF State      OOS ODP                               04-02-04 10:06:02.885
SSCF State      Alignment Idle                          04-02-04 10:06:53.625
SSCF State      Alignment OCP                           04-02-04 10:07:14.000
SSCF State      Alignment ODP                           04-02-04 10:07:14.000
SSCF State      In Service/Data Transfer Ready         04-02-04 10:08:01.760
SSCF State      Proving Data Transfer Ready            04-02-04 10:08:01.760
SSCF State      Aligned/Ready Data Transfer Ready     04-02-04 10:04:23.000
MAAL State      OOS                                       04-02-04 10:04:23.000
MAAL State      Alignment                               04-02-04 10:05:31.100
MAAL State      Proving                                  04-02-04 10:05:31.100
MAAL State      Aligned/Ready                           04-02-04 10:05:31.105
MAAL State      In Service                               04-02-04 10:05:31.105
SSCOP Receive   BGN                                       04-02-04 10:05:46.425
SSCOP Receive   BGAK                                      04-02-04 10:05:46.430
SSCOP Receive   END                                       04-02-04 10:05:46.430
SSCOP Receive   ENDAK                                    04-02-04 10:06:02.110
SSCOP Receive   RS                                       04-02-04 10:06:02.120
SSCOP Receive   RSAK                                      04-02-04 10:06:02.885
SSCOP Receive   BGREJ                                    04-02-04 10:06:53.625
SSCOP Receive   SD                                       04-02-04 10:07:14.000
SSCOP Transmit ER                                       04-02-04 10:07:14.000
SSCOP Transmit POLL                                    04-02-04 10:08:01.760
SSCOP Transmit STAT                                   04-02-04 10:08:01.760
SSCOP Transmit USTAT                                  04-02-04 10:04:23.000
SSCOP Transmit UD                                       04-02-04 10:04:23.000
SSCOP Transmit MD                                       04-02-04 10:05:31.100
SSCOP Transmit ERAK                                   04-02-04 10:05:31.100
SSCF Receive   Out of Service                          04-02-04 10:05:31.105
SSCF Receive   Processor Outage                       04-02-04 10:05:31.105
SSCF Receive   In Service                            04-02-04 10:05:46.425
SSCF Receive   Normal                               04-02-04 10:05:46.430
SSCF Receive   Emergency                             04-02-04 10:05:46.430
SSCF Transmit Alignment Not Successful              04-02-04 10:06:02.110
SSCF Transmit Mgmt Initiated                       04-02-04 10:06:02.120
SSCF Transmit Protocol Error                       04-02-04 10:06:02.885
SSCF Transmit Proving Not Successful               04-02-04 10:06:53.625
Special Event   LCD                                       04-02-04 10:05:46.425
Special Event   LCD Cleared                          04-02-04 10:05:46.430
Special Event   LOF                                       04-02-04 10:05:46.430
Special Event   LOF Cleared                          04-02-04 10:06:02.110
Special Event   LOS                                       04-02-04 10:06:02.120
Special Event   LOS Cleared                          04-02-04 10:06:02.885
Special Event   Too Many Interrupts                 04-02-04 10:06:53.625

Service Event                                     Timestamp
Timer_No_Credit expired                          04-02-04 05:40:10.160
ERM link failure                                  04-02-04 10:02:02.125
Timer_No_Response expired                        04-02-04 10:15:02.125
COO received                                     04-02-04 10:22:02.125
Stop Commanded                                  04-02-04 10:32:02.125

```



```

LPO 04-02-04 10:42:02.125
RPO 04-02-04 10:43:02.125
Remote OOS 04-02-04 10:44:02.125
Remote PE 04-02-04 10:45:02.125
Remote Mgmt Initiated 04-02-04 10:46:02.125
Failed SLT 04-02-04 10:47:02.125
LCD 04-02-04 10:48:02.125
LOS 04-02-04 10:49:02.125
LOF 04-02-04 10:52:02.125
Too many interrupts 04-02-04 10:53:02.125
In Service 04-02-04 10:54:01.760
Command Completed.

```

;

**rept-stat-slk:loc=1203:link=b:l2stats=brief**

```

rlghncxa03w 04-02-23 13:06:25 EST EAGLE 31.3.0
SLK LSN CLLI PST SST AST
1203,B lsnssp2 ----- IS-NR Avail ----
ALARM STATUS = No Alarms
UNAVAIL REASON = --

```

```

Event Type Event Timestamp
Transmit SIOS 97-10-31 10:04:23.000
State Out of Service 97-10-31 10:04:23.000
State Initial Align 97-10-31 10:05:31.100
State Idle 97-10-31 10:05:31.100
Transmit SIO 97-10-31 10:05:31.105
State Not Aligned 97-10-31 10:05:31.105
State T2 Expired 97-10-31 10:05:46.425
Command Completed.

```

;

The following example shows output for an E1 interface associated with a link:

**rept-stat-slk:loc=1201:link=a**

```

rlghncxa03w 04-02-23 13:06:25 EST EAGLE 31.3.0
SLK LSN CLLI PST SST AST
1201,A e5m6s4 ----- OOS-MT Unavail ----
ALARM STATUS = No Alarms
UNAVAIL REASON = --
E1 STATUS = 1201, REPT-E1F:FAC-E1 Port 1 LOS failure
Command Completed.

```

;

The following example shows output for when the E1 interface is not associated with a link:

**rept-stat-slk:loc=1201:link=a**

```

rlghncxa03w 04-02-23 13:06:25 EST EAGLE 31.3.0
SLK LSN CLLI PST SST AST
1201,A e5m6s4 ----- OOS-MT Unavail ----
ALARM STATUS = No Alarms
UNAVAIL REASON = --
E1 status = E1 association unknown
Command Completed.

```

;

The following example shows output for a T1 interface associated with a link:

**rept-stat-slk:loc=1201:link=a**

```

rlghncxa03w 04-02-23 13:06:25 EST EAGLE 31.3.0
SLK LSN CLLI PST SST AST
1201,A e5m6s4 ----- OOS-MT Unavail ----
ALARM STATUS = No Alarms
UNAVAIL REASON = --
T1 STATUS = 1201, REPT-E1F:FAC-T1 Port 1 LOS failure

```

Command Completed.

;

The following example shows output for an 8-point IPLIM card:

**rept-stat-slk:loc=1301**

```
rlghncxa03w 04-02-23 13:06:25 EST EAGLE 31.3.0
SLK      LSN      CLLI      PST      SST      AST
1301,A   lsnip      -----  OOS-MT-DSBLD Unavail ----
1301,B   lsnip      -----  OOS-MT-DSBLD Unavail ----
1301,A1  lsnip      -----  OOS-MT-DSBLD Unavail ----
1301,B1  lsnip      -----  OOS-MT-DSBLD Unavail ----
1301,A2  lsnip      -----  OOS-MT-DSBLD Unavail ----
1301,B2  lsnip      -----  OOS-MT-DSBLD Unavail ----
1301,A3  lsnip      -----  OOS-MT-DSBLD Unavail ----
1301,B3  lsnip      -----  OOS-MT-DSBLD Unavail ----

      ALARM STATUS   = ** 0224 REPT-LKS: not aligned
      UNAVAIL REASON = NA
Command Completed.
```

;

**Legend**

**SLK**—The card location and the signaling link.

**LSN**—The name of the linkset that contains the signaling link.

**CLLI**—The CLLI code of the destination STP of the signaling link.

**PST**—The primary state of the signaling link. The possible values are described in "Possible Values for PST/SST/AST".

**SST**—The secondary state of the signaling link. The possible values are described in "Possible Values for PST/SST/AST".

**AST**—The associated state of the signaling link. The possible values are described in .

**ALARM STATUS**—The trouble text alarm message that was generated for the specified signaling link.

**UNAVAIL REASON**—The reason that the signaling link is unavailable. More than one unavailable reason may be listed:

**BSNR**—The signaling link received 2 of 3 invalid BSNs.

**CNGT**—The signaling link has a remote congestion time-out.

**COO**—A changeover order was received.

**FC**—The signaling link is unavailable because of false congestion restart.

**FE**—The signaling link is in far end loopback mode.

**FIBR**—The signaling link received 2 of 3 invalid FIBs.

**INTR**—Too many link interrupts were received.

**LB**—The signaling link has been blocked locally.

**LD**—The signaling link received incomplete data.

**LI**—The signaling link has been inhibited locally.

**NA**—The signaling link is not aligned.

**PF**—The signaling link failed the proving period.

**RB**—The signaling link has been blocked remotely.

**RD(xx.xxx)**—The signaling link is unavailable because of a restart delay to prevent signaling link oscillation. The number in parentheses indicates the amount of time, in seconds, remaining in the restart delay period. The link is restarted automatically after this amount of time has elapsed.

**RL**—The signaling link is in remote near end loopback mode.

**RMI**—The signaling link has been inhibited remotely.

**SIE**—An unexpected SIE was received.

**SIN**—An unexpected SIN was received.

**SIO**—An unexpected SIO was received.

**SIOS**—An unexpected SIOS was received.

**SLTF**—Link test failed.

**T1NR**—The level-2 T1 (not ready) timer expired.

**T1R**—The level-2 T1 (ready) timer expired.

**T2**—The level-2 T2 timer expired.

**T3**—The level-2 T3 timer expired.

**X25FL**—An X25 link failed.

**XDA**—The signaling link did not receive an acknowledgment in time.

**XER**—The SUERM threshold was exceeded.—

**--**—The card is ISOLATED or the links are available.

The following are reasons that the ATM high-speed signaling link is unavailable:

**TNC**—Timer No Credit expired - The remote node has held the node in a no-credit state for too long. The far end office should be contacted to determine the cause of the link congestion.

**TNR**—Timer No Response expired - The far end is taking too long to acknowledge the messages sent to it by the near end. The far end office should be contacted to determine the cause for the excessive delay in acknowledging PDUs.

**LPO**—Local Processor Outage - Indicates a spontaneous or management-initiated processor outage. The user needs to determine whether the outage was spontaneous or management-initiated on the near end.

**RPO**—Remote Processor Outage - The far end has sent PDUs causing processor outage. The far end office should be contacted to determine the reason for the processor outage.

**ROOS**—Remote Out of Service - The far end has sent PDUs causing a link to become out of service. The far end office should be contacted to determine the reason for taking the link out of service.

**RPE**—Remote Protocol Error - The far end has sent PDUs declaring a protocol error. The far end office should be contacted to determine the details about the protocol error.

**RMIR**—Remote Management Initiated Release - The far end has sent PDUs releasing the link. The far end office should be contacted to determine the reason for releasing the link.

**LCD**—Level 1 facility outage: Loss of Cell Delineation

**LOF**—Level 1 facility outage: Loss of Frame

**LOS**—Level 1 facility outage: Loss of Signal

**EVENT TYPE**—The type of event being logged:

**RECEIVE**—When a signal unit is received.

**TRANSMIT**—When a signal unit is transmitted.

**STATE**—When an internal SS7 Level 2 state changes or a special event occurs that would either end alignment or cause the link to fail.

**EVENT**—The specific event being logged: (1) if a signal unit is being received or transmitted, the specific signal unit is displayed; (2) if the event being logged is a state change, the new state is displayed; (3) If neither (1) nor (2) is displayed, the link or alignment failure reason is displayed.

**SERVICE EVENT**—The service activity of the link; for example, In Service. Anything other than In Service is a description of a link failure.

**TIMESTAMP**—The time event processed by the system as follows:

**YY-MM-DD HH:MM:SS.TTT**, where

**YY**—The last 2 digits of the year (range 00–99)

**MM**—The month (range 01–12)

**DD**—The day of month (range 00–31)

**HH**—The hour of day (range 00–59)

**MM**—The minute of the hour (range 00–59)

**ss**—The seconds of the minute (range 00–59)

**TTT**—Milliseconds of the second (range 000–995 in increments of 5)

**E1 STATUS**—The status of the E1 interface associated with the link; the status includes the card location (**e1loc**) and the UAM text. If the E1 association is not provisioned, “E1 association unknown” is displayed. If the card is not type **lime1** or **limch**, no E1 output is displayed.

**T1 STATUS**—The status of the T1 interface associated with the link; the status includes the card location (**e1loc**) and the UAM text. If the card is not type **limt1** or **limch**, no T1 output is displayed.

## rept-stat-sys

## Report Status System

Use this command to display a summary report of the status of the main system entities. Use this display to determine where the troubles are in the system. The display shows the number of these items that are in service (IS-NR) and how many are in another state (IS-ANR, OOS-MT, OOS-MT-DSBLD).

**Keyword:** **rept-stat-sys**

**Related Commands:** **rept-stat-alm, rept-stat-card, rept-stat-clk, rept-stat-cluster, rept-stat-dstn, rept-stat-imt, rept-stat-ls, rept-stat-meas, rept-stat-mps, rept-stat-seas, rept-stat-slk, rept-stat-trbl, rept-stat-xlist**

**Command Class:** System Maintenance

### Parameters

This command has no parameters.

### Example

```
rept-stat-sys
```

### Dependencies

No other **rept-stat-xxx** command can be in progress when this command is entered.

### Notes

None

**Output**

The following example shows the output when no features are turned on in the system and only the cards in locations 1109-1110 and 1113-1118 are installed.

**rept-stat-sys**

```
tekelecstp 09-08-11 10:31:06 EST EAGLE 41.1.0
MAINTENANCE STATUS REPORT
Maintenance Baseline established.
Routing Baseline established.
SCCP Baseline established.
ALARMS:      CRIT=    2    MAJR=    2    MINR=    0    INH=    0
OAM 1113     IS-NR           Active           INH=    0
OAM 1115     IS-NR           Standby          INH=    0
LIM        CARD IS-NR=    0    Other=          0    INH=    0
SCCP       CARD IS-NR=    0    Other=          0    INH=    0
GLS        CARD IS-NR=    0    Other=          0    INH=    0
SLAN       CARD IS-NR=    0    Other=          0    INH=    0
VXWLAN     CARD IS-NR=    0    Other=          0    INH=    0
SS7IPGW    CARD IS-NR=    0    Other=          0    INH=    0
IPGWI      CARD IS-NR=    0    Other=          0    INH=    0
IPLIM      CARD IS-NR=    0    Other=          0    INH=    0
IPLIMI     CARD IS-NR=    0    Other=          0    INH=    0
IPSG       CARD IS-NR=    0    Other=          0    INH=    0
MUX        CARD IS-NR=    2    Other=          0    INH=    0
MCPM       CARD IS-NR=    0    Other=          0    INH=    0
EROUTE     CARD IS-NR=    0    Other=          0    INH=    0
CLOCK      IS-NR=    2    Other=          0    INH=    0
IMT        IS-NR=    2    Other=          0
SLK        IS-NR=    0    Other=          0    INH=    0
DLK        IS-NR=    0    Other=          0    INH=    0
LINK SET   IS-NR=    0    Other=          0    INH=    0
DSM IP LK  IS-NR=    0    Other=          0    INH=    0
MCPM IP LK IS-NR=    0    Other=          0    INH=    0
APPLSOCK   IS-NR=    0    Other=          0    INH=    0
SCTP ASSOC IS-NR=    0    Other=          0    INH=    0
APPL SERVER IS-NR=    0    Other=          0    INH=    0
SS7 DPC    IS-NR=    0    Other=          0    INH=    0
CLUST DPC  IS-NR=    0    Other=          0    INH=    0
RTX        IS-NR=    0    Other=          0    INH=    0
XLIST DPC  IS-NR=    0    Other=          0
DPC SS     Actv =    0    Other=          0
SEAS SS    IS-NR=    0    Other=          2
SEAS X25   IS-NR=    0    Other=          2    INH=    0
TERMINAL   IS-NR=   16    Other=          0    INH=    0
MPS        IS-NR=    0    Other=          0
RTD SS     IS-NR=    1    Other=          0
```

;

The following example shows the output when various features are turned on in the system. (Your output will not show all of these entries; some features are mutually exclusive in the system.)

Some entries appear as follows:

- When the Measurements Platform feature is not turned on and no MCPM cards are in the IS-NR state in the system, the MCPM and MCPM IP LK values are zero and the MEAS SS entry does not appear.
- When one or more MCPM cards have been installed and allowed, the MCPM CARD entry shows the number of MCPM cards that are in each state.
- When the Measurements Platform feature is turned on and the Measurements Platform collection option is enabled, the MEAS SS entry appears.

- When the Measurements Platform collection function has been enabled (chg-measopts=platformenable=on), the MCPM IP LK entry shows the number of links that are functioning for the MCPM cards, and the MEAS SS entry appears.
- When the Origin-Based MTP Routing (MOBR) feature is not turned on, and/or no exception routes have been provisioned, the RTX value is zero.
- When the OA&M IP Security Enhancement feature is turned on, the SECURITY SS entry appears.
- When the Equipment Identity Register (EIR) feature is turned on, the EIR SS entry appears.
- When the INAP Number Portability (INP) feature is turned on, the INP SS entry appears.

**rept-stat-sys**

rlghncxa03w 09-08-07 16:53:22 EST EAGLE5 41.1.0  
 MAINTENANCE STATUS REPORT

Maintenance Baseline established.

Routing Baseline established.

SCCP Baseline established.

|             |             |    |         |    |       |   |      |   |
|-------------|-------------|----|---------|----|-------|---|------|---|
| ALARMS:     | CRIT=       | 9  | MAJR=   | 10 | MINR= | 3 | INH= | 2 |
| OAM 1113    | IS-NR       |    | Active  |    |       |   | INH= | 0 |
| OAM 1115    | IS-NR       |    | Standby |    |       |   | INH= | 0 |
| LIM         | CARD IS-NR= | 3  | Other=  |    | 0     |   | INH= | 0 |
| SCCP        | CARD IS-NR= | 3  | Other=  |    | 0     |   | INH= | 0 |
| GLS         | CARD IS-NR= | 0  | Other=  |    | 0     |   | INH= | 0 |
| SLAN        | CARD IS-NR= | 0  | Other=  |    | 0     |   | INH= | 0 |
| VXWSLAN     | CARD IS-NR= | 0  | Other=  |    | 0     |   | INH= | 0 |
| IPSG        | CARD IS-NR= | 2  | Other=  |    | 0     |   | INH= | 0 |
| MUX         | CARD IS-NR= | 2  | Other=  |    | 3     |   | INH= | 0 |
| MCPM        | CARD IS-NR= | 0  | Other=  |    | 0     |   | INH= | 0 |
| EROUTE      | CARD IS-NR= | 0  | Other=  |    | 0     |   | INH= | 0 |
| CLOCK       | IS-NR=      | 1  | Other=  |    | 0     |   | INH= | 0 |
| HS CLOCK    | IS-NR=      | 1  | Other=  |    | 0     |   | INH= | 0 |
| IMT         | IS-NR=      | 1  | Other=  |    | 1     |   |      |   |
| SLK         | IS-NR=      | 21 | Other=  |    | 27    |   | INH= | 0 |
| SS7IPGW     | CARD IS-NR= | 0  | Other=  |    | 0     |   | INH= | 0 |
| IPGWI       | CARD IS-NR= | 0  | Other=  |    | 0     |   | INH= | 0 |
| IPLIM       | CARD IS-NR= | 0  | Other=  |    | 0     |   | INH= | 0 |
| IPLIMI      | CARD IS-NR= | 0  | Other=  |    | 0     |   | INH= | 0 |
| IMT         | IS-NR=      | 2  | Other=  |    | 0     |   |      |   |
| SLK         | IS-NR=      | 0  | Other=  |    | 6     |   | INH= | 0 |
| DLK         | IS-NR=      | 0  | Other=  |    | 0     |   | INH= | 0 |
| LINK SET    | IS-NR=      | 0  | Other=  |    | 4     |   | INH= | 0 |
| DSM IP LK   | IS-NR=      | 0  | Other=  |    | 0     |   | INH= | 0 |
| MCPM        | CARD IS-NR= | 0  | Other=  |    | 0     |   | INH= | 0 |
| EROUTE      | CARD IS-NR= | 0  | Other=  |    | 0     |   | INH= | 0 |
| CLOCK       | IS-NR=      | 2  | Other=  |    | 0     |   | INH= | 0 |
| HS CLOCK    | IS-NR=      | 2  | Other=  |    | 0     |   | INH= | 0 |
| MCPM IP LK  | IS-NR=      | 2  | Other=  |    | 0     |   | INH= | 0 |
| APPLSOCK    | IS-NR=      | 0  | Other=  |    | 0     |   | INH= | 0 |
| SCTP ASSOC  | IS-NR=      | 0  | Other=  |    | 0     |   | INH= | 0 |
| APPL SERVER | IS-NR=      | 0  | Other=  |    | 0     |   | INH= | 0 |
| SS7 DPC     | IS-NR=      | 0  | Other=  |    | 6     |   | INH= | 0 |
| CLUST DPC   | IS-NR=      | 0  | Other=  |    | 1     |   | INH= | 0 |
| RTX         | IS-NR=      | 2  | Other=  |    | 1     |   | INH= | 0 |
| XLIST DPC   | IS-NR=      | 0  | Other=  |    | 0     |   |      |   |
| DPC SS      | Actv =      | 0  | Other=  |    | 0     |   |      |   |
| SEAS SS     | IS-NR=      | 1  | Other=  |    | 0     |   |      |   |
| TERMINAL    | IS-NR=      | 2  | Other=  |    | 14    |   | INH= | 0 |
| MPS         | IS-NR=      | 2  | Other=  |    | 0     |   |      |   |
| SECURITY SS | IS-NR=      | 1  | Other=  |    | 0     |   |      |   |
| EIR SS      | IS-NR=      | 1  | Other=  |    | 0     |   |      |   |
| RTD SS      | IS-NR=      | 0  | Other=  |    | 1     |   |      |   |

```

      INP SS      IS-NR= 1   Other= 0
      VFLEX SS    IS-NR= 1   Other= 0
      ATINPQ SS   IS-NR= 1   Other= 0
      LNP SS      IS-NR= 1   Other= 0
      FCS         IS-NR= 1   Other= 0
;

```

**Legend**

**INH**—The number of devices within each device type that have their alarms inhibited.

**ALARMS**—The number of critical (**CRIT**), major (**MAJR**), and minor (**MINR**) alarms on the system when this command was executed and the count of alarm inhibited (**INH**) devices for cards, links, linksets, and terminals.

**OAM**—The status of each of the cards that are running the OAM (1113 and 1115).

**LIM CARD**—The status of the LIM cards.

**SCCP CARD**—The status of the SCCP subsystem cards.

**GLS CARD**—The status of the GLS subsystem cards.

**SLAN CARD**—The status of the STPLAN subsystem cards.

**VXWSLAN CARD**—The status of the VXW STPLAN subsystem cards.

**SS7IPGW CARD**—The status of the SS7IPGW cards.

**IPGWI CARD**—The status of the IPGWI cards.

**IPLIM CARD**—The status of the IPLIM cards.

**IPLIMI CARD**—The status of the IPLIMI cards.

**MUX CARD**—The combined status of all the MUX (HMUX, HIPR and HIPR2) cards.

**MCPM CARD**—The status of the MCPM cards.

**ERROUTE CARD**—The status of the EROUTE cards.

**CLOCK**—The status of the system clocks.

**HS CLOCK**—The status of the high-speed clocks.

**IMT**—The status of the IMT system.

**SLK**—The status of the SS7 and IPGWI signaling links in the system.

**DLK**—The status of the TCP/IP data links in the system.

**LINK SET**—The status of the linksets in the system.

**DSM IP LK**—The status of the DSM IP linksets.

**MCPM IP LK**—The status of the MCPM IP links.

**APPLSOCK**—The status of the application sockets.

**SCTP ASSOC**—The status of the SCTP associations.

**APPL SERVER**—The status of the Application Servers.

**SS7 DPC**—Summary information only for provisioned DPCs that are not in clusters.

**CLUST DPC**—Summary information for provisioned cluster DPCs only.

**RTX**—Summary information for provisioned exception routes only.

**XLIST DPC**—Summary information for X-LIST DPC entries only.

**DPC SS**—Summary information for the DPC subsystem.

**SCCP SS**—The status of the SCCP subsystem.

**SEAS SS**—The status of the SEAS subsystem.

**MEAS SS**—The status of the Measurements subsystem (for Measurements Platform).

**NDC SS**—The status of the NDC subsystem.

**NDC Q3**—Summary information on Q.3 association status.

**MPS**—Summary information on the MPS.

**TERMINAL**—The status of the terminals.

**SECURITY SS**—EAGLE OA&M IP Security subsystem status.

**EIR SS**—Equipment Identity Register subsystem status.

**RTD**—Run Time Diagnostic subsystem status.

**VFLEX SS**—V-Flex subsystem status.

**ATINPQ SS**—ATI Number Portability Query subsystem status.

**INP SS**—INAP Number Portability subsystem status.

**LNP SS**—Local Number Portability subsystem status.

**FCS**—The status of the Fast Copy subsystem.

## rept-stat-t1

## Report Status T1

Use this command to display the T1 port status and signaling link status for cards with provisioned T1 ports.

**Keyword:** `rept-stat-t1`

**Related Commands:**

**Command Class:** System Maintenance

### Parameters

**:loc=** (optional)

Card address. The unique identifier of a specific **limt1** card located in the STP.

**Range:** 1101-1108, 1111-1112, 1201-1208, 1211-1218, 1301-1308, 1311-1318, 2101-2108, 2111-2118, 2201-2208, 2211-2218, 2301-2308, 2311-2318, 3101-3108, 3111-3118, 3201-3208, 3211-3218, 3301-3308, 3311-3318, 4101-4108, 4111-4118, 4201-4208, 4211-4218, 4301-4308, 4311-4318, 5101-5108, 5111-5118, 5201-5208, 5211-5218, 5301-5308, 5311-5318, 6101-6108, 6111-6118

**Default:** Information for all **limt1** cards is reported.

**:t1port=** (optional)

The T1 port number. When this parameter is specified, information is displayed only for the specified T1 port on the card in the specified card location.

**Range:** 1-8

Ports 3 through 8 can be specified only for HC-MIM cards.

### Example

```
rept-stat-t1
```

```
rept-stat-t1:loc=1203
```

```
rept-stat-t1:loc=1203:t1port=1
```

### Dependencies

No other **rept-stat-xxx** command can be in progress when this command is entered.

The **loc** parameter must be specified when the **t1port** parameter is specified.

The active TDM location cannot be specified in the **loc** parameter.



Card locations 1117 and 1118 and the HMUX or HIPR card locations (xy09 and xy10 where *x* is the frame and *y* is the shelf) cannot be specified in the **loc** parameter.

### Notes

Specifying the command without any parameters displays T1 port status for all cards with provisioned T1 ports.

If the **loc** parameter is specified, status is displayed for all T1 ports provisioned on the card in the specified location.

If the **loc** and **t1port** parameters are specified, the T1 port status summary is displayed for all T1 ports provisioned on the card in the specified location, followed by the status of all signaling links assigned to the specified T1 port on the card.

**Output**

When no parameters are specified in the command, T1 port status is displayed for all cards with provisioned T1 ports. Ports 3 through 8 are on HC-MIM cards only.

**rept-stat-t1**

```
rlghncxa03w 05-01-04 07:01:08 EST EAGLE5 33.0.0
LOC  T1PORT  PST      SST      AST
1203  1        IS-NR    Avail    BRGD MSTR
1203  2        IS-NR    Avail    BRGD SLAV
1203  3        IS-NR    Avail    -----
1203  7        OOS-MT   Unavail  -----
1207  1        IS-NR    Avail    -----
1207  2        IS-NR    Avail    -----
Command Completed.
```

;

When the **loc** parameter is specified, status is displayed for all T1 ports provisioned on the card in the specified location.

**rept-stat-t1:loc=1203**

```
rlghncxa03w 05-01-04 07:01:08 EST EAGLE5 33.0.0
LOC  T1PORT  PST      SST      AST
1203  1        IS-NR    Avail    BRGD MSTR
1203  2        IS-NR    Avail    BRGD SLAV
1203  3        IS-NR    Avail    -----
1203  7        OOS-MT   Unavail  -----
Command Completed.
```

;

When the **loc** and **t1port** parameters are specified, the T1 port status summary is displayed for all T1 ports provisioned on the card in the specified location, followed by the status of all signaling links assigned to the specified T1 port on the card.

**rept-stat-t1:loc=1203:t1port=1**

```
rlghncxa03w 05-01-04 07:01:08 EST EAGLE5 33.0.0
LOC  T1PORT  PST      SST      AST
1203  1        IS-NR    Avail    BRGD MSTR
ALARM STATUS      = No Alarms.
UNAVAIL REASON    = --
SLK  TS  PST      SST      AST
A    1  IS-NR    Avail    ---
A1   2  IS-NR    Avail    ---
Command Completed.
```

;

**rept-stat-t1:loc=1203:t1port=2**

```
rlghncxa03w 05-01-04 07:01:08 EST EAGLE5 33.0.0
LOC  T1PORT  PST      SST      AST
1203  2        IS-NR    Avail    BRGD SLAV
ALARM STATUS      = No Alarms.
UNAVAIL REASON    = --
Command Completed.
```

;

**Legend**

**LOC**—Card location

**T1PORT**—Number of the T1 port provisioned on the card in the specified location.

**PST**—The primary state of the card. The possible values are described in "Possible Values for PST/SST/AST".

**SST**—The secondary state of the card. The possible values are described in "Possible Values for PST/SST/AST".

**AST**—The associated state of the card. The possible values are described in "Possible Values for PST/SST/AST". The values **PARENT** and **PAIRED** refer to odd and even adjacent ports on the card that are provisioned in channel bridging mode.

**ALARM STATUS**—Either "No Alarms" or current alarm number and text

**UNAVAIL REASON**—Reason for the T1 port being unavailable

**SLK**—Signaling link assigned to the T1 port

**TS**—Timeslot assigned to the signaling link

**PST**—The primary state of the signaling link. The possible values are described in "Possible Values for PST/SST/AST".

**SST**—The secondary state of the signaling link. The possible values are described in "Possible Values for PST/SST/AST".

**AST**—The associated state of the signaling link. The possible values are described in .

## rept-stat-trbl

## Report Status Trouble

Use this command to display a summary report of all the device trouble notifications that are logged currently in the OAM's RAM storage area.

**Keyword:** `rept-stat-trbl`

**Related Commands:** `act-alm-trns`, `dact-alm-trns`, `rept-stat-alm`, `rept-stat-clk`, `rls-alm`, `rtrv-obit`, `rtrv-trbl`

**Command Class:** System Maintenance

### Parameters

**:display=** (optional)

Display type of alarms to be reported.

**Range:** `act`, `all`, `inhb`, `timestamp`

`act`— Display only active alarms

`all`— Display all alarms with no timestamps

`inhb`— Display only inhibited alarms

`timestamp`— Display all alarms with the date and time when the alarm was logged.

Timestamps appear in the output only when the `display=timestamp` parameter is specified.

**Default:** `all`

**:level=** (optional)

The alarm level of the alarms to be displayed

**Range:** `crit`, `majr`, `minor`

**Default:** All alarms are displayed

### Example

```
rept-stat-trbl
```

```
rept-stat-trbl:level=majr
```

```
rept-stat-trbl:display=inhb
```

### Dependencies

No other `rept-stat-xxx` command can be in progress when this command is entered.

**Notes**

None

Output

The following example lists all devices that could appear. This example is to be used as a sample only: all devices and alarms cannot coexist in the system.

rept-stat-trbl

```

tekelecstp 09-05-01 10:31:06 EST EAGLE 41.0.0
SEQN UAM AL DEVICE ELEMENT TROUBLE TEXT
0002.0143 * CARD 1113 OAM System release GPL(s) not approved
0003.0313 *C DPC s-010-010-003 DPC is prohibited
0004.0313 *C DPC 010-010-004 DPC is prohibited
0005.0313 *C DPC ps-010-010-005 DPC is prohibited
0006.0313 *C DPC s-252-010-003 DPC is prohibited
0008.0313 *C DPC 252-010-004 DPC is prohibited
0009.0313 *C DPC 252-011-* DPC is prohibited
0011.0176 * SECULOG 1116 Stdby security log - upload required
0019.0236 *C T1PORT 1301,1 REPT-T1F:FAC-T1 LOS failure
0021.0318 ** LSN lsn1 REPT-LKSTO: link set prohibited
0022.0318 ** LSN lsn2 REPT-LKSTO: link set prohibited
0023.0318 ** LSN lsn3 REPT-LKSTO: link set prohibited
0024.0236 ** SLK 1315,A ls11234567 REPT-LKF: not aligned
0025.0236 ** SLK 1316,A ls11345678 REPT-LKF: not aligned
0028.0313 *C DPC 252-010-001 DPC is prohibited
0029.0308 *C SYSTEM Node isolated due to SLK failures
0036.0455 *C EIR SYSTEM EIR Subsystem is not available
3102.0435 *C LNP SYSTEM LNP Subsystem is disabled
3536.0084 ** EMAP B 7100 IP Connection Unavailable
3537.0084 ** DLK 1215, A MCP IP Connection Unavailable
3538.0179 * EMAP NDC Q.3 association is Unavailable
0002.0143 * CARD 1113 OAM System release GPL(s) not approved
0003.0313 *C DPC s-010-010-003 DPC is prohibited
0004.0313 *C DPC 010-010-004 DPC is prohibited
0005.0313 *C DPC ps-010-010-005 DPC is prohibited
0006.0313 *C DPC s-252-010-003 DPC is prohibited
0008.0313 *C DPC 252-010-004 DPC is prohibited
0009.0313 *C DPC 252-011-* DPC is prohibited
0010.0318 ** LSN lsn4 REPT-LKSTO: link set prohibited
0011.0176 * SECULOG 1116 Stdby security log - upload required
0019.0236 *C T1PORT 1301,1 REPT-T1F:FAC-T1 LOS failure
0021.0318 ** LSN lsn1 REPT-LKSTO: link set prohibited
0022.0318 ** LSN lsn2 REPT-LKSTO: link set prohibited
0023.0318 ** LSN lsn3 REPT-LKSTO: link set prohibited
0024.0236 ** SLK 1315,A ls11234567 REPT-LKF: not aligned
0025.0236 ** SLK 1316,A ls11345678 REPT-LKF: not aligned
0028.0313 *C DPC 252-010-001 DPC is prohibited
0029.0308 *C SYSTEM Node isolated due to SLK failures
0036.0455 *C EIR SYSTEM EIR Subsystem is not available
3102.0435 *C LNP SYSTEM LNP Subsystem is disabled
3536.0084 ** EMAP B 7100 IP Connection Unavailable
3537.0084 ** DLK 1215, A MCP IP Connection Unavailable
3538.0179 * EMAP NDC Q.3 association is Unavailable
3539.0181 *C NDC SYSTEM NDC Subsystem is not available
3540.0203 ** SLK 1201,A lsn1 REPT-LKF: lost data
3541.0203 ** SLK 1201,B lsn4 REPT-LKF: lost data
3542.0203 ** SLK 1202,A lsn2 REPT-LKF: lost data
3543.0203 ** SLK 1202,B lsn4 REPT-LKF: lost data
3544.0202 ** SLK 1203,A lsn3 REPT-LKF: HWP - too many link
interrupts
3545.0202 ** SLK 1203,B lsn4 REPT-LKF: HWP - too many link
interrupts
2353.0022 * CARD 1107 MCP Clock B for card failed, Clock A normal
3587.0048 * TERMINAL 1 Terminal failed
0007.0110 * IMT SYSTEM Failure detected on one IMT bus
2343.0002 * GPL SYSTEM BPCDM Card is not running approved GPL
4321.0321 * XLIST X-LIST occupancy threshold exceeded
    
```

```

0046.0344 * SEAS X25 Link A1      SEAS PVC unavailable
0045.0348 * SEAS SYSTEM           SEAS is at min service limit
0011.0176 * SECULOG 1116         Stdby security log -- upload required
3538.0179 * EMAP                NDC Q.3 association is Unavailable
4121.0398 * INP SYSTEM          Local Subsystem normal,card(s) abnormal
2354.0516 * MEAS SYSTEM         Degraded Mode - 1 card failed
3589.0013 ** CARD 1103 SS7ANSI   Card is isolated from the system
2358.0013 ** CARD 1111 MCP       Card is isolated from the system
3590.0013 ** CARD 1115 OAM       Card is isolated from the system
3590.0514 ** CARD 1115 EOAM      Standby MASP is inhibited
0006.0108 ** IMT BUS A          Major IMT failure detected
          Card 1105, 1113, 1115
0012.0390 ** CARD 1109 HMUX      Illegal Address Error
0046.0155 * DLK 1104,A1         STPLAN connection unavailable
3591.0208 ** SLK 1101,A  ls1     REPT-LKF: APF - lvl-2 T2 expired
3592.0208 ** SLK 1101,B  ls2     REPT-LKF: APF - lvl-2 T2 expired
3593.0202 ** SLK 1102,B2 lsname489+ REPT-LKF: HWP -too many link interrupts
3594.0236 ** SLK 1103,A  ls3     REPT-LKF: not aligned
3595.0236 ** SLK 1103,B  ls4     REPT-LKF: not aligned
3596.0084 ** DLK 1111,A  MCP     IP Connection Unavailable
0024.0236 ** SLK 1315,A  ls11234567 REPT-LKF: not aligned
0025.0236 ** SLK 1316,A  ls11345678 REPT-LKF: not aligned
0943.0318 ** LSN ls1           REPT-LKSTO: link set prohibited
0945.0318 ** LSN ls2           REPT-LKSTO: link set prohibited
0948.0318 ** LSN ls4           REPT-LKSTO: link set prohibited
1234.0082 ** FUSE PANEL 1lxx    Alarm in Fuse Panel
0012.0341 ** OAP                A OAP unavailable
0134.0084 ** IP7 LONGSOCKETNAME1 IP Connection Unavailable
3537.0084 ** DLK 1215,A  MCP     IP Connection Unavailable
3537.0084 ** DSM 1315,A         IP Connection Unavailable
3536.0084 ** EMAP B  7100       IP Connection Unavailable
0133.0277 ** IP7 as1           AS Unavailable
0003.0313 *C DPC s-010-010-003  DPC is prohibited
0004.0313 *C DPC 010-010-004    DPC is prohibited
0005.0313 *C DPC ps-010-010-005 DPC is prohibited
0028.0313 *C DPC 252-010-001    DPC is prohibited
0006.0313 *C DPC s-252-010-003  DPC is prohibited
0008.0313 *C DPC 252-010-004    DPC is prohibited
0009.0313 *C DPC 252-011-*      DPC is prohibited
2120.0058 *C CDT 1              Critical customer trouble detected
0029.0308 *C SYSTEM            Node isolated due to SLK failures
0040.0128 *C CLOCK SYSTEM       All clocks have failed
0050.1114 * HS CLOCK SYSTEM     Clock selection mismatch
2109.0331 *C SCCP SYSTEM        SCCP is not available
2110.0292 *C GLS SYSTEM         GLS is not available
1234.0153 *C SLAN SYSTEM        STPLAN not available
0009.0041 *C LSMS Connection A1  LNP DB Maintenance Required
0056.0356 *C LSMS SYSTEM        LSMS unavailable
0041.0197 *C CLOCK SYSTEM       All High Speed Clocks have failed
0056.0356 *C LSMS SYSTEM        LSMS unavailable
0041.0197 *C CLOCK SYSTEM       All High Speed Clocks have failed
3102.0435 *C LNP SYSTEM         LNP Subsystem is disabled
3539.0181 *C NDC SYSTEM         NDC Subsystem is not available
0036.0455 *C EIR SYSTEM         EIR Subsystem is not available
0019.0236 *C T1PORT 1301,1     REPT-T1F:FAC-T1 LOS failure
4521.0370 *C MPS A              Critical Platform Failure(s)
0045.0469 *C EROUTE SYSTEM      All STC cards Unavailable
5648.0382 ** E1PORT 1201,2     REPT-E1F:FAC-E1 LOF failure
0047.0392 ** SECURITY SYSTEM 1211 OA&M IP Security feature status is OFF
0036.0455 *C EIR SYSTEM         EIR Subsystem is not available
1235.0114 ** IP TPS SYSTEM      System IP TPS threshold exceeded
3684.0013 ** CARD 1305 SS7IPGW  Card is isolated from the system
3688.0236 ** SLK 1203,A  lslg2  REPT-LKF: not aligned
3692.0318 ** LSN e5e6          REPT-LKSTO: link set prohibited
1088.0539 * DLK 1106,A1        Ethernet Interface Down

```

```

1089.0579 * CARD 1106 FC Network Unavailable
1090.0576 ** FCS ALL FC Network Unavailable
3697.0539 ** ENET 1305,A Ethernet Interface Down
3698.0539 ** ENET 1305,B Ethernet Interface Down
3699.0539 ** ENET 1307,B Ethernet Interface Down
3700.0536 * IP7 assoc1234567890 IP Connection Excess Retransmits
0915.0541 *C RTD SYSTEM MSU cksum error threshold exceeded
0002.0520 *C Frame power usage reached LVL3
0056.0528 *C GFLEX SERVICE Service is not available
0056.0528 *C GPORT SERVICE Service is not available
5676.0084 ** MCPM 1101,A IP Connection Unavailable
0056.0528 *C MNP SERVICE Service is not available
0044.0534 *C RTX 001-101-001 RTX is prohibited
0916.0565 *C ATINPQ SYSTEM ATINPQ Subsystem is not available
Command Completed.

```

;

**rept-stat-trbl:display=act:level=majr**

```

rlghncxa03w 02-03-07 09:50:17 EST EAGLE 30.0.0
Searching devices for alarms...

```

;

```

rlghncxa03w 02-03-07 09:50:17 EST EAGLE 30.0.0
SEQN UAM AL DEVICE ELEMENT TROUBLE TEXT
3540.0203 ** SLK 1201,A lsn1 REPT-LKF: lost data
3541.0203 ** SLK 1201,B lsn4 REPT-LKF: lost data
3542.0203 ** SLK 1202,A lsn2 REPT-LKF: lost data
3543.0203 ** SLK 1202,B lsn4 REPT-LKF: lost data
3544.0202 ** SLK 1203,A lsn3 REPT-LKF: HWP -too many link interrupts
3545.0202 ** SLK 1203,A1 lsn4 REPT-LKF: HWP -too many link interrupts
3545.0202 ** SLK 1203,B2 lsn4 REPT-LKF: HWP -too many link interrupts
0022.0318 ** LSN lsn2 REPT-LKSTO: link set prohibited
0023.0318 ** LSN lsn3 REPT-LKSTO: link set prohibited
0010.0318 ** LSN lsn4 REPT-LKSTO: link set prohibited
Command Completed.

```

;

**rept-stat-trbl:display=inhb:level=majr**

```

rlghncxa03w 02-03-07 09:50:17 EST EAGLE 30.0.0
Searching devices for alarms...

```

;

```

rlghncxa03w 02-03-07 09:50:17 EST EAGLE 30.0.0
SEQN UAM AL DEVICE ELEMENT TROUBLE TEXT
0021.0318I** LSN lsn1 REPT-LKSTO: link set prohibited
Command Completed.

```

;

The following example shows output when the **display=timestamp** parameter is specified.

**rept-stat-trbl:display=timestamp**

```

rlghncxa03w 04-04-07 09:50:17 EST EAGLE 31.6.0
Searching devices for alarms...

```

;

```

tekelecstp 04-04-07 09:50:17 EST EAGLE 31.6.0
SEQN UAM AL DEVICE ELEMENT TROUBLE TEXT
0003.0048 * TERMINAL 1 Terminal failed
04-1-27 15:19:25
0004.0048 * TERMINAL 2 Terminal failed
04-1-27 15:19:25
0005.0048 * TERMINAL 4 Terminal failed
04-1-27 15:19:25
0006.0002 * GPL SYSTEM EOAM Card is not running approved GPL
04-1-27 15:19:25
0007.0176 * SECULOG 1116 Stdby security log -- upload required
04-1-27 15:19:25

```

```

0008.0013 ** CARD 1103 VSCCP          Card is isolated from the system
              04-15-27 15:19:25
0009.0438 *C SYSTEM                   Degraded Mode, Invalid OAM HW config
              04-1-27 15:19:27
0010.0331 *C SCCP SYSTEM              SCCP is not available
              04-1-27 15:19:25
Command Completed.
;

```

**Legend****In the AL column:**

\*—Minor Alarm  
\*\*—Major Alarm  
\*C—Critical Alarm  
I—Inhibited Alarm

**rept-stat-trm****Report Status Terminal**

Use this command to display the status of the terminal ports. The device primary, secondary, and associated state information is displayed along with the terminal identification number.

**Keyword:** `rept-stat-trm`

**Related Commands:** `act-echo`, `alw-trm`, `chg-trm`, `dact-echo`, `inh-trm`, `rmv-trm`, `rst-trm`, `rtrv-trm`

**Command Class:** System Maintenance

**Parameters**

**:trm=** (optional)

The terminal ID. The ID of the terminal port that is to be reported.

**Range:** 1-40

**Default:** Display status of all terminal ports

**Example**

```

rept-stat-trm
rept-stat-trm:trm=5
rept-stat-trm:trm=17

```

**Dependencies**

No other `rept-stat-xxx` command can be in progress when this command is entered.

**Notes**

None



**Output**

The following example shows output when the IP User Interface is not turned on:

```
rept-stat-trm
tekelecstp 03-03-31 13:02:16 EST EAGLE 30.0.0
TRM  PST          SST          AST
1    IS-NR        Active      -----
2    IS-NR        Active      -----
3    IS-NR        Active      -----
4    IS-NR        Active      -----
5    IS-NR        Active      -----
6    IS-NR        Active      -----
7    IS-NR        Active      -----
8    IS-NR        Active      -----
9    IS-NR        Active      -----
10   IS-NR        Active      -----
11   IS-NR        Active      -----
12   IS-NR        Active      -----
13   IS-NR        Active      -----
14   IS-NR        Active      -----
15   IS-NR        Active      -----
16   IS-NR        Active      -----
Command Completed.
```

;

The following example shows output when the IP User Interface is turned on and 3 IPSM cards are in the system:

```
rept-stat-trm
rlghncxa03w 04-01-07 09:50:17 EST EAGLE 31.3.0
TRM  PST          SST          AST
1    IS-NR        Active      -----
2    IS-NR        Active      -----
3    IS-NR        Active      ALMINH
4    IS-NR        Active      -----
5    OOS-MT-DSBLD Manual      -----
6    IS-NR        Active      -----
7    IS-NR        Active      -----
8    IS-NR        Active      -----
9    IS-NR        Active      -----
10   IS-NR        Active      -----
11   IS-NR        Active      ALMINH
12   IS-NR        Active      -----
13   IS-NR        Active      -----
14   OOS-MT        Fault      -----
15   IS-NR        Active      -----
16   IS-NR        Active      -----
17   IS-NR        Active      -----
18   IS-NR        Active      -----
19   IS-NR        Active      -----
20   OOS-MT-DSBLD Manual      -----
21   IS-NR        Idle       -----
22   IS-NR        Idle       -----
23   IS-NR        Idle       -----
24   IS-NR        Idle       -----
25   IS-NR        Active      -----
26   IS-NR        Active      -----
27   IS-NR        Active      -----
28   IS-NR        Active      -----
29   IS-NR        Active      -----
30   IS-NR        Active      -----
31   IS-NR        Active      -----
32   IS-NR        Active      -----
```

```

33  IS-NR      Active      -----
34  IS-NR      Active      -----
35  IS-NR      Active      -----
36  IS-NR      Active      -----
37  IS-NR      Active      -----
38  IS-NR      Active      -----
39  IS-NR      Active      -----
40  IS-NR      Active      -----
Command Completed.
;

rept-stat-trm:trm=5
rlghncxa03w 04-01-07 09:50:17 EST  EAGLE 31.3.0
TRM  PST      SST      AST
5    IS-NR      Active      -----
Command Completed.
;

```

**Legend**

**TRM**—The ID of the terminal port.

**PST**—The primary state of the terminal ports. The possible values are described in "Possible Values for PST/SST/AST".

**SST**—The secondary state of the terminal ports. The possible values are described in "Possible Values for PST/SST/AST".

**AST**—The associated state of the terminal ports. The possible values are described in .

**rept-stat-tstslk****Report Signaling Link Test Status**

Use this command to generate a report of the status of the MTP signaling links currently under test.

**Keyword:** **rept-stat-tstslk**

**Related Commands:** **tst-slk**

**Command Class:** Link Maintenance

**Parameters**

**:link=** (optional)

SS7 signaling links. The SS7 signaling link that is being tested.

**Synonym:** **port**

**Range:** **a, b, a1-a31, b1-b31**

Not all card types support all **link** parameter values.

See Table A-1 for valid **link** parameter range values for each type of card that can have assigned signaling links.

**:loc=** (optional)

The card location as stenciled on the shelf of the system.

**Range:** **1101-1108, 1111-1112, 1201-1208, 1211-1218, 1301-1308, 1311-1318, 2101-2108, 2111-2118, 2201-2208, 2211-2218, 2301-2308, 2311-2318, 3101-3108, 3111-3118, 3201-3208, 3211-3218, 3301-3308, 3311-3318, 4101-4108, 4111-4118, 4201-4208, 4211-4218, 4301-4308, 4311-4318, 5101-5108, 5111-5118, 5201-5208, 5211-5218, 5301-5308, 5311-5318, 6101-6108, 6111-6118**

**:loopback=** (optional)

Loopback test type.

**Range:** **sltc, lxvr, oam, line, payload**

**Example**

```
rept-stat-tstslk
rept-stat-tstslk:loc=1201
rept-stat-tstslk:loc=1203:link=a
rept-stat-tstslk:loopback=lxvr
```

**Dependencies**

The card location specified in the **loc** parameter must be equipped.

The signaling link specified in the **link** parameter must be equipped.

If the **link** parameter is specified, the **loc** parameter must be specified.

The signaling link specified in the **link** parameter must be an SS7 signaling link.

This command cannot be entered for SSEDCM or E5-ENET cards that are running the **ss7ipgw**, **ipgwi**, or **ipsg** application, or that have SS7IPGW, IPGWI, or IPSG-M3UA links.

This command cannot be entered for cards with **ipgwi** signaling links.

The card location specified in the **loc** parameter cannot be reserved by the system.

This command cannot be entered during upgrade.

**Notes**

None

**Output**

If no parameters are specified, all links in test are displayed.

If only the **loc** parameter is specified, all links in test on the specified card are displayed.

If the **loc** and **link** parameters are specified, the specified link on the specified card is displayed.

If the **loopback** parameter is specified, all links in the specified type of loopback test are displayed.

**rept-stat-tstslk**

```
tekelecstp 04-01-07 10:05:28 EST EAGLE 31.3.0
SLK      LOOPBACK  MAX-TIME  TEST-TIME
1102,A1  SLTC      01:00:00  00:04:01
1201,A   OAM       02:00:00  01:04:11
1203,A   LXVR     00:50:00  00:22:21
1203,B   LXVR     24:00:00  20:04:01
1208,A   PAYLOAD  01:10:00  01:05:22
1211,A   LINE     21:30:00  00:14:01
```

;

**Legend**

**SLK**—Card and signaling link that are being tested.

**LOOPBACK**—Type of loopback test being run.

**MAX-TIME**—Maximum length of time for the test to run, as specified in the **tst-slk** command **time** parameter.

**TEST-TIME**—The length of time that the test has been running when this command was entered.

**rept-stat-user****Report Status User**

Use this command to show which users are logged into the system. The command shows user names, terminal identification numbers, the time that the last valid command was issued, and the current state of the last command entered.

**Keyword:** `rept-stat-user`

**Related Commands:** `act-user`, `chg-pid`, `chg-user`, `dact-user`, `dlt-user`, `ent-user`, `login`, `logout`, `rtrv-secu-user`, `rtrv-user`

**Command Class:** Basic

**Parameters**

This command has no parameters.

**Example**

```
rept-stat-user
```

**Dependencies**

None

**Notes**

None

**Output**

```
rept-stat-user
e5oam 09-04-03 17:25:57 MST EAGLE 41.0.0
REPT STAT USER COMPLD
USER ID          TERM #  IDLE SINCE          COMMAND                STATE
eagle            3      02-01-03 17:19:04  rept-stat-applsock    IDLE
eagle            6      02-01-03 17:25:57  rept-stat-user        PROCESSING
REPORT COMPLETED
```

**Legend**

**USER ID**—The user ID of the users logged onto the system.

**TERM #**—The terminal port to which the user's terminal is connected.

**IDLE SINCE**—The date and time of day that the user last entered a command.

**COMMAND**—The last command the user entered.

**STATE**—The state of the command the user last entered.

**rept-stat-xlist****Report Status X-List Storage Area Statistics**

Use this command to report statistics related to the storage of x-list entries. X-list entries reside in the routing table and are dynamically created for individual members of clusters whenever one or more routes to that cluster member become more restrictive than the corresponding routes to the cluster.

The following information is reported:

- The number of routing table positions reserved for x-list entries
- The current number of x-list entries
- The percentage of space in the x-list reserved area currently in use

- The percentage of x-list space that must be in use before an alarm is issued

**Keyword:** `rept-stat-xlist`

**Related Commands:** `chg-stpopts`, `rept-stat-cluster`, `rtrv-stpopts`

**Command Class:** System Maintenance

### Parameters

This command has no parameters.

### Example

```
rept-stat-xlist
```

### Dependencies

The Cluster Routing and Management Diversity (CRMD) feature must be turned on before using this command.

### Notes

The statistics reported by this command are those gathered during periodic polling by the maintenance subsystem. They might differ slightly from the instantaneous values at the time the command was issued.

The following rules are used to compute the *Current X-LIST occupancy* percentage value that is displayed in the output report:

- The percentage value that is displayed is computed as follows:  
[(current x-list entries) / (allocated x-list space)] \* 100
- Non-integer percentages will be rounded up to the next highest integer (for example, 23.5% becomes 24%), with the exception of the situation described in the next rule.
- 100% is not displayed until the current *X-LIST* entries value exactly equals the allocated *X-LIST* space (for example, 99.1% is not rounded up to 100%).

### Output

```
rept-stat-xlist
rlghncxa03w 04-02-18 03:32:42 EST  EAGLE 31.3.0
Allocated X-LIST space      = 500
Current X-LIST entries      = 156
Current X-LIST occupancy    = 31 % (see "Notes")
X-LIST occupancy threshold = 80 %
;
```

## rept-x25-meas

## Report X.25 Measurements

Use this command to display the X.25 signaling link measurements. The X.25 signaling link is used in cellular networks to transport TCAP signaling messages from one mobile switching center (MSC) to another.

**Keyword:** `rept-x25-meas`

**Related Commands:** `rept-stat-alm`, `rept-stat-dstn`, `rept-stat-imt`, `rept-stat-ls`, `rept-stat-slk`, `rept-stat-sys`, `rept-stat-trbl`

**Command Class:** Link Maintenance

## Parameters

**:loc=** (mandatory)

The card location as stenciled on the shelf of the system.

**Range:** 1101-1108, 1111-1112, 1201-1208, 1211-1218, 1301-1308, 1311-1318, 2101-2108, 2111-2118, 2201-2208, 2211-2218, 2301-2308, 2311-2318, 3101-3108, 3111-3118, 3201-3208, 3211-3218, 3301-3308, 3311-3318, 4101-4108, 4111-4118, 4201-4208, 4211-4218, 4301-4308, 4311-4318, 5101-5108, 5111-5118, 5201-5208, 5211-5218, 5301-5308, 5311-5318, 6101-6108, 6111-6118

(Refer to the *Installation Manual – EAGLE 5 ISS* for card location information.)

**:action=** (optional)

This parameter is used to reset the measurements counters for an X25 link.

**Range:** reset, none

**Default:** none

**:port=** (optional)

The port on the card specified in the **loc** parameter

**Range:** a

## Example

```
rept-x25-meas:loc=1211:port=a
```

```
rept-x25-meas:loc=1211:port=a:action=reset
```

## Dependencies

No other action command can be in progress when this command is entered.

The specified signaling link must be equipped and assigned to a LIM configured with the ss7gx25 GPL.

The card location cannot be out of range - **loc**.

Location invalid for hardware configuration.

The card type must be valid.

The specified location of the card is not valid.

The card must be in service.

## Notes

None

**Output****rept-x25-meas:loc=1211:port=a**

```
rlghncxa03w 04-02-18 03:32:42 EST EAGLE 31.3.0
X.25 MEASUREMENTS REPORT: CARD LOC: 1211; PORT:A
Time counters were last reset: 04-02-18; 02:32:78
```

## Link counts:

```
Hardware errors = 0      CRC Errors= 150   Inits= 3
```

## Level 2 counts:

```
Total recvd = 168321   FRMR recvd = 1   DISC recvd = 0
Total xmit = 171002    Re-xmit = 15000
```

## Level 3 counts:

```
Total recvd = 101218   RESTART recvd = 5   DIAG/INT/REG recvd = 0
Total xmit = 122381    Re-xmit = 50   Discarded = 0
```

## Logical Channel Status &amp; Counts:

```
#SVC defined = 80      #SVC in use = 72   SVCs all in use =10
#PVC defined = 40      #PVC in use = 40
```

## Number of times SVC Control Timers have expired:

```
T1 = 0   T2 = 0   T4 = 2   T5 = 0   T6 = 0   T7 = 0   T8 = 100
Command Completed.
```

;

**Legend**

## Link Counts

**HARDWARE ERRORS**—The number of signaling link hardware errors.

**CRC ERRORS**—The number of signaling link CRC errors.

**INITS**—The number of signaling link initializations.

## Level 2 Counts

**TOTAL RECVD**—The total number of frames received.

**FRMR RECVD**—The number of frame reject frames received.

**DISC RECVD**—The number of disconnect frames received.

**TOTAL XMIT**—The total number of frames transmitted.

**RE-XMIT**—The number of frames re-transmitted.

## Level 3 Counts

**TOTAL RECVD**—The total number of packets received.

**RESTART RECVD**—The number of restarts received.

**DIAG/INT/REJ RECVD**—The number of diagnostic, interrupt, or reject packets received.

**TOTAL XMIT**—The total number of packets transmitted.

**RE-XMIT**—The number of packets retransmitted.

**DISCARDED**—The number of messages discarded because the transmit queue is full.

## Logical Channel Status and Counts

**#SVC DEFINED**—The total number of switched virtual circuits (SVCs).

**#SVC IN USE**—The number of SVCs being used.

**SVCs ALL IN USE**—The number of times that all SVCs have been in use.

**#PVC DEFINED**—The total number of permanent virtual circuits (PVCs).

**#PVC IN USE**—The number of PVCs being used.

Number of times SVC control timers have expired

**T1**—SVC control timer T1

**T2**—SVC control timer T2

**T4**—SVC control timer T4

**T5**—SVC control timer T5

**T6**—SVC control timer T6

**T7**—SVC control timer T7

**T8**—SVC control timer T8

## rls-alm

## Release Alarm

Use this command to silence audible alarms. Entering this command also causes the alarm status on terminals to stop blinking (though they continue showing an alarm condition).

**Keyword:** `rls-alm`

**Related Commands:** `act-alm-trns`, `dact-alm-trns`, `rept-stat-alm`, `rept-stat-clk`, `rept-stat-trbl`, `rtrv-obit`, `rtrv-trbl`

**Command Class:** System Maintenance

### Parameters

**:lvl=** (optional)

The alarm level

**Range:** `crit`, `majr`, `minor`

**Default:** All alarms are cleared

### Example

```
rls-alm
```

```
rls-alm : lvl = crit
```

### Dependencies

No other action command can be in progress when this command is entered.

### Notes

This command has no effect on visual alarm indicators on the fuse and alarm panel (FAP) or on the cabinet side panel.

Any alarms that occur after the execution of this command activate audible alarms again.

### Output

```
rls-alm
```

```
rlghncxa03w 04-01-07 09:27:24 EST EAGLE 31.3.0
```

```
rls-alm
```

```
Command entered at terminal #8.
```

```
;
```



**rmv-card****Remove Card**

Use this command to change the state of the card to Out of Service - Maintenance Disabled (OOS-MT-DSBLD), enabling a technician to test a LIM, TSM, or ACM, or physically remove it from the shelf.

**Keyword:** **rmv-card**

**Related Commands:** **dlt-card, ent-card, init-card, rept-stat-card, rst-card, rtrv-card**

**Command Class:** System Maintenance

**Parameters**

**:loc=** (mandatory)

The card location as stenciled on the shelf of the system.

**Range:** 1101-1108, 1111-1112, 1201-1208, 1211-1218, 1301-1308, 1311-1318, 2101-2108, 2111-2118, 2201-2208, 2211-2218, 2301-2308, 2311-2318, 3101-3108, 3111-3118, 3201-3208, 3211-3218, 3301-3308, 3311-3318, 4101-4108, 4111-4118, 4201-4208, 4211-4218, 4301-4308, 4311-4318, 5101-5108, 5111-5118, 5201-5208, 5211-5218, 5301-5308, 5311-5318, 6101-6108, 6111-6118

Refer to the *Installation Manual – EAGLE 5 ISS* for card location information.

**:force=** (optional)

This parameter is required if the card is the last GLS or SCCP card.

**Range:** yes, no

**Default:** no

**Example**

```
rmv-card:loc=1101
```

```
rmv-card:loc=1201:force=yes
```

**Dependencies**

The following card locations are not valid for this command: 1113, 1114, 1115, 1116, 1117, 1118, and all *xy09* and *xy10* locations (where *x* is the frame and *y* is the shelf).

The shelf and card must be equipped.

If the card is a LIM, all signaling links assigned to the card must be placed out of service before the command can be entered.

The **force** parameter is required to force the last GLS or SCCP out of service.

If the card has active TCP/IP links, all TCP/IP data links assigned to it must be placed out of service.

**Notes**

The function of this command is the same as the **inh-card** command.

When this command is executed, the card boots and enters the OOS-MT-DSBLD state. It has no affect if the card is already OOS-MT-DSBLD.

The command is rejected if you attempt to inhibit a LIM that has active signaling links. The links must be cancelled, using the **dact-slk** command, before the command is accepted.

Inhibiting a card running the VSCCP application affects GTT service. SCCP messages requiring global title translation are not routed, and an error message is returned to the originator.

Inhibiting a TSM running the GLS application has no immediate affect on the system. These cards are used only when loading gateway screening to the LIMs.

The command is rejected if you attempt to inhibit a card that has active TCP/IP data links. The TCP/IP data links must be cancelled, using the **canc-dlk** command, before the command is accepted.

### Output

```
rmv-card:loc=1101
  rlghncxa03w 04-01-07 11:11:28 EST EAGLE 31.3.0
  Card has been inhibited.
;
```

## rmv-imt

### Remove IMT

The interprocessor message transport bus (IMT bus) is the main communications artery between all subsystems in the system. Use this command to remove the IMT bus from service.



### CAUTION

**CAUTION:** Use this command only when directed by Tekelec Technical Services at (888) FOR-TKLC.

**Keyword:** **rmv-imt**

**Related Commands:** **clr-imt-stats**, **conn-imt**, **disc-imt**, **rept-imt-lvl1**, **rept-imt-lvl2**, **rept-stat-imt**, **rst-imt**

**Command Class:** System Maintenance

### Parameters

**:bus=** (mandatory)  
The IMT bus to be inhibited.  
**Range:** a, b

### Example

```
rmv-imt:bus=a
```

### Dependencies

The alternate IMT bus must be in-service normal (IS-NR) in order for the specified bus to be inhibited. This command cannot be entered during an IMT Fault Isolation Test.

### Notes

Cards that are not connected to the other IMT bus will reinitialize.

All traffic is rerouted to the other IMT bus.

The function of this command is the same as the **inh-imt** command.

**Output**

```

rmv-imt:bus=a
rlghncxa03w 04-01-07 09:22:31 EST EAGLE 31.3.0
* 0014.0203 * SLK 1205,A nc00027 slk not aligned

rlghncxa03w 04-01-07 09:22:31 EST EAGLE 31.3.0
Inhibit IMT Bus A command issued

rlghncxa03w 04-01-07 09:22:31 EST EAGLE 31.3.0
* 00120.1203 * SLK 1205,B nc00027 slk not aligned

rlghncxa21w 04-01-07 09:22:31 EST EAGLE 31.3.0
0016.0096 CARD 1205 SS7ANSI card has been reloaded

rlghncxa21w 04-01-07 09:22:31 EST EAGLE 31.3.0
0017.0236 SLK 1205,A nc00027 slk is attempting to align

rlghncxa21w 04-01-07 09:22:31 EST EAGLE 31.3.0
0018.0236 SLK 1205,B nc00027 slk is attempting to align

rlghncxa21w 04-01-07 09:22:32 est EAGLE 31.3.0
0019.0098 imt bus a imt inhibited

rlghncxa21w 04-01-07 09:22:32 est EAGLE 31.3.0
* 0020.0107 * imt bus a minor imt failure detected

rlghncxa21w 04-01-07 09:22:32 EST EAGLE 31.3.0
** 0021.0108 ** IMT BUS A major imt failure detected

rlghncxa21w 04-01-07 09:22:33 EST EAGLE 31.3.0
0022.0026 CARD 1205 SS7ANSI clocks a and b for card normal
;

```

**rmv-trm****Remove Terminal**

Use this command to set the primary state of a serial port to OOS-MT-DSBLD (OUT-OF-SERVICE-MAINTENANCE-DISABLED), and to set the secondary state to MANUAL. The serial port is not available to perform service functions. There is no outgoing traffic from the serial port; all incoming traffic is ignored.

**Keyword:** **rmv-trm**

**Related Commands:** **act-echo, alw-trm, canc-echo, chg-trm, dact-echo, inh-trm, rept-stat-trm, rst-trm, rtrv-trm**

**Command Class:** System Maintenance

**Parameters**

**:trm=** (mandatory)

The ID of the serial port to be inhibited.

**Range:** 1-40

**:force=** (optional)

This parameter forces the removal of the terminal, even if it is the last in-service OAP terminal or last in-service SEAS terminal available.

**Range:** yes, no

**Default:** no

**Example**

```
rmv-trm:port=5
```

```
rmv-trm:trm=1:force=yes
```

### Dependencies

No other action command can be in progress when this command is entered.

The IP User Interface feature must be enabled before terminal ports 17 through 40 can be specified in the **trm** parameter.

The terminal specified by the **trm** parameter must be equipped.

To inhibit the last in-service OAP terminal, the **force=yes** parameter must be specified.

You cannot inhibit the terminal from which this command was entered.

The **force=yes** parameter must be specified to inhibit the last in-service SEAS terminal.

### Notes

When removing a terminal that has already been removed, a warning message is echoed to the scroll area but no action is taken.

### Output

```
rmv-trm
  rlghncxa03w 04-01-07 11:11:28 EST  EAGLE 31.3.0
  Inhibit message sent to terminal
;

rmv-trm:trm=17:force=yes
  tekelecstp 07-01-11 13:42:16 EST  EAGLE 37.5.0
  Inhibit message sent to terminal
;
```

## rst-card

## Reset Card

Use this command to change the card from OOS-MT-DSBLD (Out-of-Service-Maintenance-Disabled) to IS-NR (In-Service-Normal) if the loading is successful. If the loading fails, the card status is OOS-MT (Out-of-Service-Maintenance).

**Keyword:** **rst-card**

**Related Commands:** **dlt-card, ent-card, init-card, rept-stat-card, rmv-card, rtrv-card**

**Command Class:** System Maintenance

### Parameters

**:loc=** (mandatory)

The card location as stenciled on the shelf of the system.

**Range:** **1101-1108, 1111-1112, 1201-1208, 1211-1218, 1301-1308, 1311-1318, 2101-2108, 2111-2118, 2201-2208, 2211-2218, 2301-2308, 2311-2318, 3101-3108, 3111-3118, 3201-3208, 3211-3218, 3301-3308, 3311-3318, 4101-4108, 4111-4118, 4201-4208, 4211-4218, 4301-4308, 4311-4318, 5101-5108, 5111-5118, 5201-5208, 5211-5218, 5301-5308, 5311-5318, 6101-6108, 6111-6118**

**:code=** (optional)

The GPL type to be loaded.

**Range:** **appr, trial, utility**  
**appr** — Approved GPL  
**trial** — Trial GPL  
**utility** — Utility GPL, used primarily by the factory for loading special GPLs for testing purposes

**Default:** No GPL type is given.

**Example**

```
rst-card:loc=2301:code=trial
rst-card:loc=1101:data=persist
```

**Dependencies**

The following card locations are not valid for this command: 1113, 1114, 1115, 1116, 1117, 1118, and all *xy09* and *xy10* locations (where *x* is the frame and *y* is the shelf).

The shelf and card must be equipped.

If the card is a LIM, it must have a signaling link assigned to it before it can be allowed.

No other action command can be in progress when this command is entered.

The LNP feature must be turned on (see the **enable-ctrl-feat** command) before the **data** parameter can be specified.

**Notes**

The function of this command is the same as the **alw-card** command.

The *Installation Manual – EAGLE 5 ISS* provides an illustration of card locations.

The system previously supported the **data** parameter for reloading GTT data. The system does not support persistent GTT data loading, and the **data** parameter is now used in support of the warm restart feature.

When the OA&M IP Security feature is turned on, and an IPSM card is inserted and initialized for the first time or is removed, inserted, and initialized again, the "SSH Host Keys Regenerated" UIM is displayed. The UIM shows the generated SSH Host Key fingerprint that must be provided at the secure client in order for secure information transfer to occur. The SSH Host Key fingerprint is changed whenever power is lost and restored to an IPSM card.

```
rlghncxa03 03-07-11 07:05:00 EST EAGLE 30.2.0 0021.1493 CARD 1111 INFO
SSH Host Keys Regenerated DSA Server Host Key FTRA-formatted Fingerprint=
84 7c 92 8b c 7c ds 19 1c 6 4b de 5c 8f c5 4d Report Date:03-07-11 Time:
22:27:36
```

When the OA&M IP Security feature is turned on, and an IPSM card is restarted with this command, the "SSH Host Keys Loaded" UIM is displayed. The UIM shows the current SSH Host Key fingerprint. The SSH Host Key fingerprint is not changed if the IPSM card does not lose power.

```
rlghncxa03w 04-01-07 11:11:28 EST EAGLE 31.3.0
SSH Host Keys Loaded DSA Server Host Key FTRA-formatted Fingerprint= 84
7c 92 8b c 7c ds 19 1c 6 4b de 5c 8f c5 4d Report Date:03-07-11 Time:
22:27:36
```

**Output**

```
rst-card:loc=2301:code=trial
rlghncxa03w 04-01-07 11:11:28 EST EAGLE 31.3.0
Card has been allowed.
;
```

**rst-dstn****Reset Destination Circular Routing Status**

Use this command to request that the circular routing status for the specified destination be reset (turned OFF). The destination that is specified can be a full point code (FPC), a cluster point code (for example, *ni-nc-\**), or an x-list point code. The system clears the circular routing status for the specified destination and then clears any outstanding circular routing alarm for the destination.

**Keyword:** rst-dstn

**Related Commands:** chg-stpopts, rept-stat-cluster, rept-stat-dstn, rtrv-stpopts

**Command Class:** System Maintenance

## Parameters

**NOTE:** See "Point Code Formats and Conversion" for a detailed description of point code formats, rules for specification, and examples.

**:dpc=** (mandatory)

ANSI destination point code with subfields *network indicator-network cluster-network cluster member (ni-nc-ncm)*. The *prefix* subfield indicates a private point code (*prefix-ni-nc-ncm*).

**Synonym:** dpca

**Range:** p-, 000-255, \*

Specify a valid value for each subfield of the point code, and separate the subfields with a dash (-).

*prefix*—p-

The asterisk value (\*) is not valid for the *ni* subfield.

When **chg-sid:pctype=ansi** is specified, *ni* = 000 is not valid.

When **chg-sid:pctype=ansi** is specified, *nc* = 000 is not valid if *ni* = 001–005.

When **chg-sid:pctype=ansi** is specified, *nc* = 000 is valid if *ni* = 006–255.

The point code 000-000-000 is not a valid point code.

**:dpc/dpca/dpci/dpcn/dpcn24=** (mandatory)

**:dpci=** (mandatory)

ITU international destination point code with subfields *zone-area-id*. The *prefix* subfield indicates a spare point code, private point code, or private and spare point code (*prefix-zone-area-id*).

**Range:** s-, p-, ps-, 0-255

Specify a valid value for each subfield of the point code, and separate the subfields with a dash (-).

*prefix*—s-, p-, ps-

*zone*—0-7

*area*—000-255

*id*—0-7

The point code 0-000-0 is not a valid point code.

**:dpcn=** (mandatory)

ITU national destination point code in the format of a 5-digit number (*nnnnn*); or 2, 3, or 4 numbers (*members*) separated by dashes (*m1-m2-m3-m4*) as defined by the **chg-stpopts:npcfnti** flexible point code option. A group code must be specified when the ITUDUPPC feature is turned on (*nnnnn-gc*, *m1-m2-m3-m4-gc*). The *prefix* subfield indicates a spare point code, private point code, or private and spare point code (*prefix-nnnnn*, *prefix-nnnnn-gc*, *prefix-m1-m2-m3-m4*, *prefix-m1-m2-m3-m4-gc*).

**Range:** s-, p-, ps-, 0-16383, aa-zz

Specify a valid value for each subfield of the point code, and separate the subfields with a dash (-).

*prefix*—s-, p-, ps-

*nnnnn*—0-16383

*gc*—aa-zz

*m1-m2-m3-m4*—0-14 for each member; values must sum to 14

**:dpcn24=** (mandatory)

24-bit ITU national point code with subfields main *signaling area-sub signaling area-signaling point (msa-ssa-sp)*. The *prefix* subfield indicates a private point code (*prefix-msa-ssa-sp*).

**Range:** **p-, 000-255**

Specify a valid value for each subfield of the point code, and separate the subfields with a dash (-).

*prefix*—**p-**

*msa*—**000-255**

*ssa*—**000-255**

*sp*—**000-255**

**:force=** (optional)

This parameter specifies whether to reset all dynamic data for the specified route in the Route table to the initial values.

**Range:** **yes, no**

**yes** — reset the data

**no** — do not reset the data

**Default:** **no**

### Example

```
rst-dstn:dpc=1-2-*
```

```
rst-dstn:dpc=20-2-5
```

```
rst-dstn:dpc=p-20-2-5
```

```
rst-dstn:dpc=20-2-5:force=yes
```

### Dependencies

The specified DPC must be either provisioned or an x-list entry.

The destination address must be a full point code or a cluster point code specified as *ni-nc-\**. A DPC as *ni-nc-\*\** or *ni-nc-\*\*\** cannot be specified for the **rst-dstn** command.

### Notes

None.

### Output

```
rst-dstn:dpc=20-2-5:force=yes
```

```
rlghncxa03w 09-03-29 16:40:40 EST EAGLE 41.0.0
Destination reset command sent to SNM (scroll area)
```

```
rlghncxa03w 09-03-29 16:40:40 EST EAGLE 41.0.0
Command Completed.
```

```
;
```

## rst-imt

### Reset IMT

The interprocessor message transport bus (IMT bus) is the main communications artery between all subsystems in the system. Use this command to change the state of the specified IMT bus from OOS-MT-DSBLD (out of service maintenance disabled) to IS-NR (in service normal), if the command is successful. If the command fails, the status is IS-ANR (in service abnormal).

**Keyword:** **rst-imt**

**Related Commands:** **clr-imt-stats, conn-imt, disc-imt, rept-imt-lvl1, rept-imt-lvl2, rept-stat-imt, rmv-imt**

**Command Class:** System Maintenance

**Parameters**

**:bus=** (mandatory)  
 The IMT bus to be returned to service.  
**Range:** a, b

**Example**

```
rst-imt:bus=a
```

**Dependencies**

None

**Notes**

The function of this command is the same as the **alw-imt** command.

This command returns an inhibited IMT bus to service.

**Output**

```
rst-imt:bus=a
rlghncxa03w 04-01-07 11:02:30 EST EAGLE 31.3.0
Allow IMT Bus A command issued.

rlghncxa03w 04-01-07 11:02:30 EST EAGLE 31.3.0
0100.0097 IMT BUS A IMT allowed
;
```

**rst-trm****Reset Terminal**

Use this command to return the specified serial port to the state IS-NR (in-service-normal) from the state OOS-MT-DSBLD (Out-of-Service-Maintenance-Disabled) if the command is successful. If the command is not successful, the terminal's state is OOS-MT (Out-of-Service-Maintenance).

**Keyword:** rst-trm

**Related Commands:** act-echo, alw-trm, canc-echo, chg-trm, dact-echo, inh-trm, rept-stat-trm, rmv-trm, rtrv-trm

**Command Class:** System Maintenance

**Parameters**

**:trm=** (mandatory)  
 ID of the serial port to be put into service.  
**Range:** 1-40

**Example**

```
rst-trm:trm=5
```

**Dependencies**

No other action command can be in progress when this command is entered.

The IP User Interface feature must be enabled before terminal ports 17 through 40 can be specified in the **trm** parameter.

The terminal specified by the **trm** parameter must be equipped.

Anyone logged in to the terminal specified by this command is logged off when this command is executed. For the user to continue working on the specified terminal, the user must log on to that terminal again.



An E5-IPSM card must be provisioned for the specified SEAS terminal before this command can be entered.

The SEAS Over IP feature must be turned on before this command can be entered for a SEAS terminal.

If the SEAS terminal is auto-inhibited, then this command cannot be entered.

### Notes

The function of this command is the same as the **alw-trm** command.

When you attempt to return to service a terminal already in service, a warning message is echoed to the scroll area but no action is taken.

### Output

```
rst-trm:trm=12
rlghncxa03w 04-01-07 11:11:28 EST EAGLE 31.3.0
Allow message sent to terminal

rlghncxa03w 04-01-07 11:11:28 EST EAGLE 31.3.0
1062.0046      TERMINAL      12      Terminal Enabled
;
```

## rtrv-acg-mic

### Display ACG Manually Initiated Control

Use this command to display the values of ACG controls assigned to certain queries. The control can apply to all queries or to specific query services and called party digits. A set of controls is selected to be displayed by specifying the type of controls (**type** parameter), the service (**serv** parameter), and the digits (**dgts** parameter).

**Keyword:** rtrv-acg-mic

**Related Commands:** chg-acg-mic, dlt-acg-mic, ent-acg-mic, rept-stat-lnp

**Command Class:** Database Administration

### Parameters

**:dgts=** (optional)

Digits

**Range:** 3 digits, 6-10 digits

Valid values are **000-999, 000000-9999999999**

**:serv=** (optional)

Query service

**Range:** **ain, in**

**:type=** (optional)

Type of control

**Range:** **all, sd**

### Example

Display all MICs:

```
rtrv-acg-mic
```

Display the MIC(s) that apply to particular services and digits:

```
rtrv-acg-mic:type=sd
```

Display the MIC(s) that apply to AIN queries:

```
rtrv-acg-mic:serv=ain
```

Display the MIC(s) that apply to IN queries for 919-460-xxxx:

```
rtrv-acg-mic:serv=in:dgts=919460
```

### Dependencies

If the **type=all** parameter is specified, optional parameters **serv** and **dgts** cannot be specified.

The **dgts** parameter value must be specified as 3 digits or 6-10 digits.

The LNP feature must be turned on (see the **enable-ctrl-feat** command) before the **rtrv-acg-mic** command can be entered.

### Notes

None

### Output

```
rtrv-acg-mic:type=sd
rlghncxa03w 04-01-28 08:50:12 EST EAGLE 31.3.0
TYPE=ALL
ND  INTVL  AINTVL  DRTN
6   4      7        8
TYPE=SD
DGTS          SERV  INTVL  AINTVL  DRTN
704461       AIN  -      8        7
919460       IN   6      -        7
9194602132   AIN  -      7        8
9194602132   IN   4      -        8
919461       IN   6      -        7

ACG MIC table is (11 of 256) 4% full of type SD
RTRV-ACG-MIC: MASP A - COMPLTD
;
```

The following example shows how the memory space accounting command completion response is used for **type=all**:

```
rtrv-acg-mic:type=all
rlghncxa03w 04-01-28 08:50:12 EST EAGLE 31.3.0
TYPE=ALL
ND  INTVL  AINTVL  DRTN
6   4      7        8
TYPE=SD
DGTS          SERV  INTVL  AINTVL  DRTN
919460       IN   6      -        7
9194602132   IN   4      -        8

ACG MIC table is (5 of 256) 2% full of type SD
RTRV-ACG-MIC: MASP A - COMPLTD
;
```

### Legend

**AINTVL**—New AIN interval index

**DGTS**—Digits

**DRTN**—New duration index

**INTVL**—New IN interval index

**ND**—New number of digits

**SERV**—Query service

**rtrv-acg-noc****Display ACG Node Overload Control**

Use this command to display the definitions of node overload levels. The definition is comprised of the threshold LNP query rates for node overload levels and the values for the Automatic Call Gappings (ACG) to be sent when at the overload level.

**Keyword:** rtrv-acg-noc

**Related Commands:** chg-acg-noc, dlt-acg-noc, ent-acg-noc, rept-stat-lnp

**Command Class:** Database Administration

**Parameters**

**:lvl=** (optional)

Overload level

**Range:** 1-10

**Example**

```
rtrv-acg-noc
```

```
rtrv-acg-noc:lvl=3
```

**Dependencies**

The LNP feature must be turned on (see the **enable-ctrl-feat** command) before this command can be entered.

**Notes**

None

**Output**

The following example displays all defined overload levels:

**rtrv-acg-noc**

```
rlghncxa03w 04-01-28 08:50:12 EST EAGLE 31.3.0
LVL QR          AND  IND  INTVL  DRTN
3   600000      10   6    3      6
4   750000      6    6    5      7
10  2147483647 10   10   15     13
RTRV-ACG-NOC: MASP A - COMPLTD
;
```

The following example displays overload level 3:

**rtrv-acg-noc:lvl=3**

```
rlghncxa03w 04-01-28 08:50:12 EST EAGLE 31.3.0
LVL QR          AND  IND  INTVL  DRTN
3   600000      10   10   3      6
RTRV-ACG-NOC: MASP A - COMPLTD
;
```

**Legend**

**LVL**—Overload level

**QR**—Query rate

**AND**—AIN number of digits

**IND**—IN number of digits

**INTVL**—Interval index

**DRTN**—Duration index

**rtrv-ainpopts****Retrieve AINP Options**

Use this command to retrieve AINP-specific options.

**Keyword:** **rtrv-ainpopts**

**Related Commands:** **chg-ainpopts**

**Command Class:** Database Administration

**Parameters**

This command has no parameters.

**Example**

```
rtrv-ainpopts
```

**Dependencies**

None.

**Output**

If the RNAI or RNAIV option is not provisioned, then the RNAI mnemonic default value is displayed. If the RNAI or RNAIV option is provisioned, then the RNAI mnemonic string for the option is displayed.

If the RNP or RNPV option is not provisioned, then the RNP mnemonic default value is displayed. If the RNP or RNPV option is provisioned, and the RNPV option can be set using RNP, then the RNP mnemonic string for the option is displayed. If the RNPV option cannot be provisioned using RNP, then the RNPV numerical value is displayed.

Each DIALPFX and DIALNAI option is displayed with its associated DLTPFX and SNAI option, respectively.

If the NEC option is not provisioned, then the default is displayed. The following example shows output with default AINP options.

```
rtrv-ainopts
rlghncxa03w 9-06-17 15:35:05 EST EAGLE 41.1.0
AINP OPTIONS
-----
NEC          = NONE
RNAI         = FRMSG
RNP          = E164
RFMT         = RNDN
SPRESTYPE    = RRWDGTS
SPORTTYPE    = NONE
DEFRN        = NONE

DIALPFX          DLTPFX
-----          ---

DIALNAI          SNAI
-----          ----

;

```

The following example shows output with some AINP options provisioned.

```
rtrv-ainopts
rlghncxa03w 09-06-17 15:35:05 EST EAGLE 41.1.0
AINP OPTIONS
-----
NEC          = ABC1D
RNAI         = NATL
RNP          = E212
RFMT         = CCRNDN
SPRESTYPE    = RRWDGTS
SPORTTYPE    = IS41
DEFRN        = ABC1

DIALPFX          DLTPFX
-----          ---

DIALNAI          SNAI
-----          ----

1                INTL

;

```

**Legend**

- **DEFRN**—Default Routing Number
- **DIALNAI**—Dialed Party Number Nature of Address Indicator
- **DIALPFX**—Dialed Party Number Prefix

- **DLTPFX**—Delete Prefix
- **NEC**—National Escape Code
- **RFMT**—Routing Address Format
- **RNAI**—Nature of Address Indicator for the Destination Routing Address
- **RNAIV**—Nature of Address Indicator Numeric Value for the Destination Routing Address
- **RNP**—Numbering Plan for the Destination Routing Address
- **RNPV**—Numbering Plan Numeric Value for the Destination Routing Address
- **SNAI**—Service Nature of Address Indicator
- **SPORTTYPE**—Service Portability Type
- **SPRESTYPE**—AINP option to send a "Return Results with digits" message or a "Return Results without digits" message when NPREQ messages are received for AINP services, the DN digits match, and the HLR ID is present

## rtrv-appl-rtkey

## Retrieve Application Route Key Table

Use this command to retrieve information from the Routing Key table. A routing key entry associates a routing key with up to 16 socket names with a limit of 2500 routing keys per system (if there are SSEDcMs).

- DPC, SI, SSN routing keys, which are used to route SCCP messages
- DPC, SI routing keys, which are used to route non-SCCP and non-ISUP messages
- DPC, SI, CIC routing keys, which are used to route ISUP messages

**Keyword:** rtrv-appl-rtkey

**Related Commands:** chg-appl-rtkey, dlt-appl-rtkey, ent-appl-rtkey

**Command Class:** Database Administration

### Parameters

**NOTE:** See "Point Code Formats and Conversion" for a detailed description of point code formats, rules for specification, and examples.

**NOTE:** The following parameters are no longer available: loc, mode, norm, pstncat, pstnid, sname

**:asname=** (optional)

Application Server (AS) name assigned to this routing key.

**Range:** ayyyyyyyyyyyyyy

Up to 15 alphanumeric characters; the first character must be a letter

**:cice=** (optional)

The end range of circuit identification codes assigned to the routing key.

**Range:** 0-4294967295

See Table A-4 for valid CIC values for specified SI and MSU types.

**:cics=** (optional)

The start range of circuit identification codes assigned to the routing key.

**Range:** 0-4294967295

See Table A-4 for valid CIC values for specified SI and MSU types.

**:display=** (optional)

This parameter specifies the type of output to display.

The output includes the type of card, the data collection being audited, and a message indicating the overall status. This parameter applies only to STP databases.

**Range:** **all, brief**

**all**— The KEY and the ATTRIBUTE sections of the routing key are displayed

**brief**— Only the KEY section of the routing key is displayed

**Default:** **brief**

**:dpc=** (optional)

ANSI destination point code with subfields *network indicator-network cluster-network cluster member (ni-nc-ncm)*.

**Synonym:** **dpca**

**Range:** **000-255**

Specify a valid value for each subfield of the point code, and separate the subfields with a dash (-).

When **chg-sid:pctype=ansi** is specified, *ni = 000* is not valid.

When **chg-sid:pctype=ansi** is specified, *nc = 000* is not valid if *ni = 001-005*.

When **chg-sid:pctype=ansi** is specified, *nc = 000* is valid if *ni = 006-255*.

The point code **000-000-000** is not a valid point code.

**:dpc/dpca/dpci/dpcn/dpcn24=** (optional)

Destination point code.

**:dpci=** (optional)

ITU international destination point code with subfields *zone-area-id*. The *prefix* subfield indicates a spare point code (*prefix-zone-area-id*)

**Range:** **s-, 0-255**

Specify a valid value for each subfield of the point code, and separate the subfields with a dash (-).

*prefix*—**s-**

*zone*—**0-7**

*area*—**000-255**

*id*—**0-7**

The point code **0-000-0** is not a valid point code.

**:dpcn=** (optional)

ITU national destination point code in the format of a 5-digit number (*nnnnn*); or 2, 3, or 4 numbers (members) separated by dashes (*m1-m2-m3-m4*) as defined by the **chg-stpopts:npcfmti** flexible point code option. A group code must be specified when the ITUDUPPC feature is turned on (*nnnnn-gc*, *m1-m2-m3-m4-gc*). The *prefix* subfield indicates a spare point code (*prefix-nnnnn*, *prefix-nnnnn-gc*, *prefix-m1-m2-m3-m4*, *prefix-m1-m2-m3-m4-gc*).

**Range:** **s-, 0-16383, aa-zz**

Specify a valid value for each subfield of the point code, and separate the subfields with a dash (-).

*prefix*—**s-**

*nnnnn*—**0-16383**

*gc*—**aa-zz**

*m1-m2-m3-m4*—**0-14** for each member; values must sum to 14

**:dpcn24=** (optional)

24-bit ITU national destination point code with subfields *main signaling area-sub signaling area-signaling point* (*msa-ssa-sp*).

**Range:** **000-255**

Specify a valid value for each subfield of the point code, and separate the subfields with a dash (-).

*msa*—**000-255**

*ssa*—**000-255**

*sp*—**000-255**

**:num=** (optional)

The number of entries to display.

**Range:** **1-10000**

**Default:** **50**

**:opc=** (optional)

ANSI originating point code with subfields *network indicator-network cluster-network cluster member* (*ni-nc-ncm*).

**Synonym:** **opca**

**Range:** **000-255**

Specify a valid value for each subfield of the point code, and separate the subfields with a dash (-).

When **chg-sid:pctype=ansi** is specified, *ni* = **000** is not valid.

When **chg-sid:pctype=ansi** is specified, *nc* = **000** is not valid if *ni* = **001-005**.

When **chg-sid:pctype=ansi** is specified, *nc* = **000** is valid if *ni* = **006-255**.

The point code **000-000-000** is not a valid point code.

**:opc/opca/opci/opcn/opcn24=** (optional)

Originating point code.

**:opci=** (optional)

ITU international originating point code with subfields *zone-area-id*. The *prefix* subfield indicates a spare point code (*prefix-zone-area-id*).

**Range:** **s-, 0-255**

Specify a valid value for each subfield of the point code, and separate the subfields with a dash (-).

*prefix*—**s-**

*zone*—**0-7**

*area*—**000-255**

*id*—**0-7**

The point code **0-000-0** is not a valid point code.

**:opcn=** (optional)

ITU national originating point code in the format of a 5-digit number (*nnnnn*); or 2, 3, or 4 numbers (members) separated by dashes (*m1-m2-m3-m4*) as defined by the **chg-stpopts:npcfnti** flexible point code option. A group code must be specified when the ITUDUPPC feature is turned on (*nnnnn-gc*, *m1-m2-m3-m4-gc*). The *prefix* subfield indicates a spare point code (*prefix-nnnnn*, *prefix-nnnnn-gc*, *prefix-m1-m2-m3-m4*, *prefix-m1-m2-m3-m4-gc*).

**Range:** **s-, 0-16383, aa-zz**



Specify a valid value for each subfield of the point code, and separate the subfields with a dash (-).

*prefix*—*s*-

*n**n**n**n*—**0-16383**

*gc*—**aa-zz**

*m1-m2-m3-m4*—**0-14** for each member; values must sum to 14

**:opc<sub>n</sub>24=** (optional)

24-bit ITU national originating point code with subfields *main signaling area-sub signaling area-signaling point (msa-ssa-sp)*.

**Range:** **000-255**

Specify a valid value for each subfield of the point code, and separate the subfields with a dash (-).

*msa*—**000-255**

*ssa*—**000-255**

*sp*—**000-255**

**:rcontext=** (optional)

Routing Context. The **rcontext** parameter is used to display the routing key with the specified routing context.

**Range:** **0-4294967295**

**:si=** (optional)

Service indicator.

**Range:** **0-15**

The following equivalent text values can be specified:

**Number = Text—Description**

**0 = snm**—Signaling network management messages

**1 = regtest**—Signaling network testing and maintenance regular

**2 = spltest**—Signaling network testing and maintenance special

**3 = sccp**—SCCP

**4 = tup**—Telephone user part

**5 = isup**—ISDN user part

**13 = qbicc**

**:ssn=** (optional)

Subsystem number.

**Range:** **0-255**

**:type=** (optional)

The type of routing key.

**Range:** **all, full, partial, default**

**Default:** **all**

### Example

```
rtrv-appl-rtkey
```

```
rtrv-appl-rtkey:dpc=123-234-255:si=3
```

```
rtrv-appl-rtkey:dpc=123-234-255
```

```

rtrv-appl-rtkey:cics=1:cice=1000:num=3
rtrv-appl-rtkey:cice=19
rtrv-appl-rtkey:opc=122-124-125
rtrv-appl-rtkey:type=partial
rtrv-appl-rtkey:display=all
rtrv-appl-rtkey:rcontext=7

```

### Dependencies

The **ssn** parameter is valid only when the **si=3** (or **sccp**) parameter is specified. If the **si=3** (or **sccp**) parameter is not specified, the **ssn** parameter cannot be specified.

The value specified for the starting circuit identification code (**cics**) must be less than or equal to the value entered for the ending circuit identification code (**cice**).

A circuit identification code range (**cics** to **cice**) that overlaps an existing routing key cannot be specified.

The **ssn** parameter cannot be specified when **opc**, **cics**, and **cice** are specified. See Table 5-5 for valid parameter combinations.

When the DPC is ANSI and the **si=4** parameter is specified, a DPC/SI routing key must be specified (TUP is used only in an ITU network).

The **opc**, **cics**, and **cice** parameters are allowed with the **si** parameter only when **si** equals **4**, **5**, or **13** (or **tup**, **isup**, or **qbicc**). Table A-4 shows valid CIC values for SI types 4, 5, and 13.

Table A-4 shows valid CIC values for SI types 4, 5, and 13.

The following types of partial routing keys are supported:

- The following types of partial routing keys are supported:
- DPC/SI/OPC (ignore CIC) can be used as a partial match key for CIC- based traffic.
- DPC/SI (ignore all other fields) can be used as a partial match key for CIC- based traffic or SCCP traffic.
- DPC only (ignore all other fields) can be used as a partial match for any type of traffic.
- SI only (ignore all other fields) can be used as a partial match for any type of traffic.

### Notes

This command can be canceled using the **F9** function key or the **canc-cmd** command. See **canc-cmd** for more information.

Static routing keys are stored on disk and a copy of the table is loaded to each SS7IPGW card.

Group codes are required for ITU-N point codes (DPCN/OPCN) when the Duplicate Point Code feature is turned on.

The **display=all** parameter must be specified to display the assigned routing context value for the routing key.

In this command, the point codes support only the spare point code subtype prefix (**s-**).

Output

**rtrv-appl-rtkey**

rlghncxa03w 08-04-11 13:17:09 EST EAGLE 38.0.0

| RCONTEXT | DPC         | SI | ADPTR | ASNAME | TYPE    |
|----------|-------------|----|-------|--------|---------|
| -----    | 008-008-008 | *  | M3UA  | as5    | PARTIAL |
| -----    | 002-002-002 | 10 | M3UA  | as2    | FULL    |
| -----    | 001-001-001 | *  | M3UA  | as11   | PARTIAL |
| -----    | 001-001-001 | 10 | M3UA  | as11   | FULL    |
| -----    | 001-001-001 | 3  | M3UA  | as12   | FULL    |
| -----    | 002-002-002 | 9  | M3UA  | as14   | FULL    |
| 10       | 002-002-002 | *  | M3UA  | as8    | PARTIAL |

| RCONTEXT | DPCI    | SI | ADPTR | ASNAME | TYPE    |
|----------|---------|----|-------|--------|---------|
| -----    | 7-007-7 | *  | M3UA  | as14   | PARTIAL |
| -----    | 7-007-7 | 4  | M3UA  | as15   | FULL    |

| RCONTEXT | DPC   | SI | ADPTR | ASNAME | TYPE    |
|----------|-------|----|-------|--------|---------|
| -----    | ***** | ** | M3UA  | as1    | DEFAULT |
| -----    | ***** | 10 | M3UA  | as12   | PARTIAL |

Route Key table is (11 of 1000) 1% full  
 Route Key Socket Association table is (11 of 16000) 1% full

END OF LOG REPORT

;

**rtrv-appl-rtkey:asname=as11**

rlghncxa03w 08-04-11 14:05:46 EST EAGLE 38.0.0

| RCONTEXT | DPC         | SI | ADPTR | ASNAME | TYPE    |
|----------|-------------|----|-------|--------|---------|
| -----    | 001-001-001 | *  | M3UA  | as11   | PARTIAL |
| -----    | 001-001-001 | 10 | M3UA  | as11   | FULL    |

Route Key table is (10 of 1000) 1% full  
 Route Key Socket Association table is (10 of 16000) 1% full

END OF LOG REPORT

;

The following example shows a routing key with routing context that is assigned to an SUA Application Server and a routing key with routing context that is assigned to an M3UA Application Server.

**rtrv-appl-rtkey:display=all**

rlghncxa03w 08-04-11 14:13:46 EST EAGLE 38.0.0

| RCONTEXT | DPC         | SI | SSN | OPC   | CICS  | CICE  |
|----------|-------------|----|-----|-------|-------|-------|
| -----    | 008-008-008 | ** | *** | ***** | ***** | ***** |

| ADPTR | TYPE    | ASNAME |
|-------|---------|--------|
| M3UA  | PARTIAL | as5    |

ANAMES  
 assoc5

| RCONTEXT | DPC         | SI | SSN | OPC   | CICS  | CICE  |
|----------|-------------|----|-----|-------|-------|-------|
| 20       | 002-002-002 | 3  | *** | ----- | ----- | ----- |

| ADPTR | TYPE    | ASNAME |
|-------|---------|--------|
| SUA   | PARTIAL | as8    |

ANAMES

```

assoc8

Route Key table is (2 of 1000) 1% full
Route Key Socket Association table is (2 of 16000) 1% full

END OF LOG REPORT
;

The following example shows output when the 2500 Routing Keys feature is enabled. The maximum
number of routing keys allowed in the system is 2500. The mazimum number of entries in the Static
Route Key Socket Association table is 40,000.

rtrv-appl-rtkey
rlghncxa03w 08-04-11 14:03:05 EST EAGLE 38.0.0

RCONTEXT      DPC      SI  ADPTR  ASNAME      TYPE
-----
008-008-008  *  M3UA  as5        PARTIAL
002-002-002  10 M3UA  as2        FULL
001-001-001  *  M3UA  as11       PARTIAL
001-001-001  10 M3UA  as11       FULL
001-001-001  3  M3UA  as12       FULL
002-002-002  9  M3UA  as14       FULL

RCONTEXT      DPCI     SI  ADPTR  ASNAME      TYPE
-----
7-007-7      *  M3UA  as14      PARTIAL
7-007-7      4  M3UA  as15      FULL

RCONTEXT      DPC      SI  ADPTR  ASNAME      TYPE
-----
***** **  M3UA  as1        DEFAULT
***** 10  M3UA  as12       PARTIAL

Route Key table is (10 of 2500) 1% full
Route Key Socket Association table is (10 of 40000) 1% full

END OF LOG REPORT
;

```

**rtrv-as**

**Retrieve Application Server**

Use this command to retrieve the characteristics of one or all Application Servers from the AS table.

**Keyword:** rtrv-as

**Related Commands:** chg-as, dlt-as, ent-as, rept-stat-as

**Command Class:** Database Administration

**Parameters**

**:aname=** (optional)

Name of the association.

**Range:** ayyyyyyyyyyyyyy

Up to 15 alphanumeric characters; the first character must be a letter.

**Default:** Retrieve all

**:asname=** (optional)

Name of the Application Server.

**Range:** ayyyyyyyyyyyyyy

Up to 15 alphanumeric characters; the first character must be a letter.

**Example**

```

rtrv-as
rtrv-as:aname=as1

```



**Default:** Retrieve all

**:link=** (optional)

The signaling link for this association.

**Range:** **a, b, a1-a31, b1-b31**

Not all card types support all **link** parameter values.

See Table A-1 for valid **link** parameter range values for each type of card that can have assigned signaling links.

**:loc=** (optional)

Card location that is stenciled on the shelf of the EAGLE 5 ISS..

**Range:** **1101-1108, 1111-1112, 1201-1208, 1211-1218, 1301-1308, 1311-1318, 2101-2108, 2111-2118, 2201-2208, 2211-2218, 2301-2308, 2311-2318, 3101-3108, 3111-3118, 3201-3208, 3211-3218, 3301-3308, 3311-3318, 4101-4108, 4111-4118, 4201-4208, 4211-4218, 4301-4308, 4311-4318, 5101-5108, 5111-5118, 5201-5208, 5211-5218, 5301-5308, 5311-5318, 6101-6108, 6111-6118**

**:rhost=** (optional)

Name of Remote Host as defined in the IP Host table.

**Range:** *////////////////////////////////////*

**a-z, A-Z, 0-9, -, .** (any string of characters beginning with a letter and comprising up to 60 characters in length)

**Default:** Retrieve all

**:rhosttype=** (optional)

Remote host type. This parameter retrieves associations with a configured primary remote host or with configured primary and alternate remote hosts.

**Range:** **primary, alternate**

**primary** — retrieve associations with only a primary remote host

**alternate** — retrieve associations with primary and alternate remote hosts

**Default:** retrieve all associations

**:rhostval=** (optional)

Remote host validation mode. This parameter retrieves associations with the specified validation mode.

**Range:** **relaxed, match**

**Default:** retrieve all associations

## Example

```
rtrv-assoc
rtrv-assoc:aname=swbel132
rtrv-assoc:lhost=gw105.nc.tekelec.com:adapter=sua
rtrv-assoc:rhosttype=alternate:display=all
```

## Dependencies

The value specified for the **host** parameter must begin with an alphabetic character and can contain **a.z, A..Z, 0..9, -** (hyphen), or **.** (period). If the host name contains a hyphen, then the host name must be enclosed within quotation marks.

## Notes

This command can be canceled using the **F9** function key or the **canc-cmd** command. See **canc-cmd** for more information.

The IPAPSOCK table is used to associate the Local Host/Local Port to a Remote Host/Remote Port.

When the command is entered with the **aname**, **lhost**, or **alhost** parameters, the output displays SCTP buffer usage information (used and total buffer space on the card).

## Output

AS names are displayed for IPGWx-M3UA and SUA linksets.

LS names are displayed for IPSG linksets.

The following example with the **aname** parameter shows buffer usage (used and total buffer space) and card location information.

### rtrv-assoc:aname=m3ua03

```
eagle10110 09-03-10 17:21:29 EST EAGLE 41.0.0

ANAME m3ua03
  LOC      1307          IPLNK PORT A          LINK      A
  ADAPTER  M3UA          VER          M3UA RFC
  LHOST    e1011001.1307a
  ALHOST    ---
  RHOST    e1011501.1307a
  ARHOST    ---
  LPORT    1309          RPORT      1309
  ISTRMS   2             OSTRMS     2             BUFSIZE   80
  RMODE    LIN           RMIN       140           RMAX      800
  RTIMES   10           CWMIN      9000          UAPS      10
  OPEN     YES          ALW        YES           RTXTHR    65535
  HBTIMER  30000
  RHOSTVAL RELAXED

ASNAMES
as01
```

```
IP Appl Sock/Assoc table is (7 of 4000) 1% full
Assoc Buffer Space Used (320 KB of 3200 KB) on LOC = 1307
```

;

The following example with the **lhost** parameter shows buffer usage (used and total buffer space) and card location information.

### rtrv-assoc:lhost=e1011501.1311a

```
eagle10110 09-03-10 17:21:29 EST EAGLE 41.0.0

ANAME ip11311a
  LINK      A
  ADAPTER  M2PA          VER          M2PA RFC
  LHOST    e1011501.1311a
  ALHOST    ---
  RHOST    e1011001.1303a
  ARHOST    ---
  LPORT    1311          RPORT      1303
  ISTRMS   2             OSTRMS     2             BUFSIZE   200
  RMODE    LIN           RMIN       120           RMAX      800
  RTIMES   10           CWMIN      3000          M2PATSET  1
  OPEN     YES          ALW        YES
  HBTIMER  30000
  RHOSTVAL RELAXED

ANAME ip11311b
  LINK      B
  ADAPTER  M2PA          VER          M2PA RFC
  LHOST    e1011501.1311a
  ALHOST    ---
  RHOST    e1011001.1303a
  ARHOST    ---
  LPORT    1312          RPORT      1312
  ISTRMS   2             OSTRMS     2             BUFSIZE   200
```



```

RMODE      LIN          RMIN      120          RMAX      800
RTIMES     10          CWMIN    3000        M2PATSET  1
OPEN       YES          ALW      YES
HBTIMER    30000
RHOSTVAL   RELAXED
    
```

IP Appl Sock/Assoc table is (10 of 4000) 1% full  
 Assoc Buffer Space Used (400 KB of 1600 KB) on LOC = 1311

;

**rtrv-assoc:display-brief or rtrv-assoc**

| ANAME           | LOC  | CARD | IPLNK | LINK | ADAPTER | LPORT | RPORT | OPEN | ALW |
|-----------------|------|------|-------|------|---------|-------|-------|------|-----|
| a23456789012345 | 1305 | A    | A     | M3UA | 20000   | 30000 | YES   | YES  |     |
| b23456789012345 | 1305 | B    | A     | M3UA | 20001   | 30001 | NO    | NO   |     |
| c23456789012345 | 1307 | A    | A     | SUA  | 20002   | 30002 | YES   | YES  |     |
| d23456789012345 | 1307 | B    | A     | M3UA | 20003   | 30003 | NO    | NO   |     |
| e23456789012345 | 1315 | A    | A     | SUA  | 20004   | 30004 | YES   | YES  |     |
| f23456789012345 | 1315 | A,B  | A     | M3UA | 20005   | 30005 | YES   | YES  |     |
| g23456789012345 | 1317 | B,A  | A     | SUA  | 20006   | 30006 | YES   | YES  |     |
| m2pa1105b3      | 1105 | A    | B3    | M2PA | 31105   | 31105 | YES   | YES  |     |
| m2pa1107a0      | 1107 | A    | --    | M2PA | 1107    | 1107  | NO    | NO   |     |
| m2pa1107a1      | 1107 | A    | --    | M2PA | 11107   | 11107 | NO    | NO   |     |
| m3ua1211a0      | 1211 | A    | A     | M3UA | 1211    | 1213  | YES   | YES  |     |
| m3ua1211a1      | 1211 | A    | **    | M3UA | 11211   | 11213 | YES   | YES  |     |
| m3ua1211a2      | 1211 | A    | B1    | M3UA | 21211   | 21213 | YES   | YES  |     |
| m3ua1211a3      | 1211 | A    | A3    | M3UA | 31211   | 31213 | YES   | YES  |     |
| m3ua1213a0      | 1213 | A    | A     | M3UA | 1213    | 1211  | YES   | YES  |     |
| m3ua1213a1      | 1213 | A    | A1    | M3UA | 11213   | 11211 | YES   | YES  |     |
| m3ua1213a2      | 1213 | A    | A2    | M3UA | 21213   | 21211 | YES   | YES  |     |
| m3ua1213a3      | 1213 | A    | A3    | M3UA | 31213   | 31211 | YES   | YES  |     |
| ipgl215a01      | 1215 | A    | **    | M3UA | 11215   | 1111  | YES   | YES  |     |
| ipgl215a02      | 1215 | A    | **    | M3UA | 11215   | 1112  | YES   | YES  |     |
| ipgl215a03      | 1215 | A    | --    | M3UA | 11215   | 1113  | NO    | NO   |     |
| ipgl215a04      | 1215 | A    | --    | M3UA | 11215   | 1114  | NO    | NO   |     |
| ipgl215a05      | 1215 | A    | --    | M3UA | 11215   | 1115  | NO    | NO   |     |
| ipgl215a06      | 1215 | A    | --    | M3UA | 11215   | 1116  | NO    | NO   |     |

IP Appl Sock/Assoc table is (24 of 4000) 1% full

;

**rtrv-assoc:adapter=m2pa**

eagle10110 09-03-10 17:21:29 EST EAGLE 41.0.0

```

ANAME ip11301a
LINK      A
ADAPTER   M2PA          VER          M2PA DRAFT 6
LHOST     e1021201.1301a
ALHOST    ---
RHOST     e1021301.1301a
ARHOST    ---
LPORT     1301          RPORT     1301
ISTRMS    2            OSTRMS    2
RMODE     LIN          RMIN      120          RMAX      800
RTIMES    10          CWMIN    3000        M2PATSET  1
OPEN      NO          ALW      NO
HBTIMER   30000
RHOSTVAL  RELAXED
    
```

```

ANAME ip11301b
LINK      B
ADAPTER   M2PA          VER          M2PA RFC
LHOST     e1021201.1301a
ALHOST    ---
    
```

```

RHOST      e1021301.1301a
ARHOST     ---
LPORT      1302           RPORT      1302
ISTRMS     2             OSTRMS    2
RMODE      LIN           RMIN       120           RMAX       800
RTIMES     10           CWMIN      3000           M2PATSET  1
OPEN       YES           ALW        YES
HBTIMER    30000
RHOSTVAL   RELAXED

```

IP Appl Sock/Assoc table is (4 of 4000) 1% full

;

The following example displays command association data for an IPSG card using an M3UA adapter.

**rtrv-assoc:aname=a1**

e1001501 09-03-10 16:20:50 EST EAGLE 41.0.0

```

ANAME a1
LOC        1305           IPLNK PORT A           LINK      **
ADAPTER    M3UA           VER                   M3UA RFC
LHOST      e1021201.1305a
ALHOST     ---
RHOST      labsun10215p0
ARHOST     ---
LPORT      2001           RPORT      2001
ISTRMS     2             OSTRMS    2             BUFSIZE   200
RMODE      LIN           RMIN       120           RMAX       800
RTIMES     10           CWMIN      3000           UAPS      10
OPEN       YES           ALW        YES             RTXTHR    0
HBTIMER    30000
RHOSTVAL   RELAXED

```

LSN;

ls1305a                    ls1305i                    ls1305a2                    lsitunbb

lsitunaa

IP Appl Sock/Assoc table is (13 of 4000) 1% full  
Assoc Buffer Space Used (600 KB of 3200 KB) on LOC = 1305

;

The following example displays command output for all associations configured on the EAGLE 5 ISS.

**rtrv-assoc:display=all**

eagle10212 09-03-10 17:00:42 EST EAGLE 41.0.0

```

ANAME ip11301a
LOC        1301           IPLNK PORT A           LINK      A
ADAPTER    M2PA           VER                   M2PA RFC
LHOST      e1021201.1301a
ALHOST     ---
RHOST      e1021301.1301a
ARHOST     ---
LPORT      1301           RPORT      1301
ISTRMS     2             OSTRMS    2             BUFSIZE   200
RMODE      LIN           RMIN       120           RMAX       800
RTIMES     10           CWMIN      3000           M2PATSET  1
OPEN       YES           ALW        YES             RTXTHR    0
HBTIMER    30000
RHOSTVAL   RELAXED

```

ANAME ip11301b

```

LOC          1301          IPLNK PORT A          LINK      B
ADAPTER     M2PA          VER          M2PA RFC
LHOST       e1021201.1301a
ALHOST      ---
RHOST       e1021301.1301a
ARHOST      ---
LPORT       1302          RPORT      1302
ISTRMS      2            OSTRMS     2            BUFSIZE    200
RMODE       LIN          RMIN       120           RMAX       800
RTIMES      10          CWMIN      3000         M2PATSET   1
OPEN        YES         ALW        YES           RTXTHR     0
HBTIMER     30000
RHOSTVAL    RELAXED

ANAME sg1303a
LOC          1303          IPLNK PORT A          LINK      A
ADAPTER     M3UA          VER          M3UA RFC
LHOST       e1021201.1303a
ALHOST      ---
RHOST       e1021301.1303a
ARHOST      ---
LPORT       2003          RPORT      2003
ISTRMS      2            OSTRMS     2            BUFSIZE    200
RMODE       LIN          RMIN       120           RMAX       800
RTIMES      10          CWMIN      3000         UAPS       10
OPEN        YES         ALW        YES           RTXTHR     0
HBTIMER     30000
RHOSTVAL    RELAXED

ANAME sg1305a
LOC          1305          IPLNK PORT A          LINK      A
ADAPTER     M3UA          VER          M3UA RFC
LHOST       e1021201.1305a
ALHOST      ---
RHOST       e1021301.1305a
ARHOST      ---
LPORT       2005          RPORT      2005
ISTRMS      2            OSTRMS     2            BUFSIZE    200
RMODE       LIN          RMIN       120           RMAX       800
RTIMES      10          CWMIN      3000         UAPS       10
OPEN        YES         ALW        YES           RTXTHR     0
HBTIMER     30000
RHOSTVAL    RELAXED

ANAME sg1305i
LOC          1305          IPLNK PORT A          LINK      B
ADAPTER     M3UA          VER          M3UA RFC
LHOST       e1021201.1305a
ALHOST      ---
RHOST       e1021301.1305a
ARHOST      ---
LPORT       2006          RPORT      2006
ISTRMS      2            OSTRMS     2            BUFSIZE    200
RMODE       LIN          RMIN       120           RMAX       800
RTIMES      10          CWMIN      3000         UAPS       10
OPEN        NO          ALW        YES           RTXTHR     0
HBTIMER     30000
RHOSTVAL    RELAXED

ANAME ipg1307a1
LOC          1307          IPLNK PORT A          LINK      A
ADAPTER     M3UA          VER          M3UA RFC
LHOST       e1021201.1307a
ALHOST      ---
RHOST       e1021301.1307a

```

```

ARHOST ---
LPORT 4001          RPORT 4001
ISTRMS 2           OSTRMS 2           BUFSIZE 16
RMODE  LIN         RMIN 120           RMAX 800
RTIMES 10          CWMIN 3000        UAPS 10
OPEN   YES         ALW   YES           RTXTHR 0
HBTIMER 30000
RHOSTVAL RELAXED

ANAME ip11311a
LOC 1311          IPLNK PORT A          LINK A
ADAPTER M2PA      VER M2PA RFC
LHOST e1021201.1311a
ALHOST ---
RHOST e1021301.1311a
ARHOST ---
LPORT 1311          RPORT 1311
ISTRMS 2           OSTRMS 2           BUFSIZE 200
RMODE  LIN         RMIN 120           RMAX 800
RTIMES 10          CWMIN 3000        M2PATSET 1
OPEN   NO          ALW   YES           RTXTHR 0
HBTIMER 30000
RHOSTVAL RELAXED

ANAME ip11313a
LOC 1313          IPLNK PORT A          LINK A
ADAPTER M2PA      VER M2PA RFC
LHOST e1021201.1313a
ALHOST ---
RHOST e1021301.1313a
ARHOST ---
LPORT 1313          RPORT 1313
ISTRMS 2           OSTRMS 2           BUFSIZE 200
RMODE  LIN         RMIN 120           RMAX 800
RTIMES 10          CWMIN 3000        M2PATSET 1
OPEN   NO          ALW   YES           RTXTHR 0
HBTIMER 30000
RHOSTVAL RELAXED

ANAME ipg1315a1
LOC 1315          IPLNK PORT A          LINK A
ADAPTER M3UA      VER M3UA RFC
LHOST e1021201.1315a
ALHOST ---
RHOST e1021301.1315a
ARHOST ---
LPORT 1315          RPORT 1315
ISTRMS 2           OSTRMS 2           BUFSIZE 16
RMODE  LIN         RMIN 120           RMAX 800
RTIMES 10          CWMIN 3000        UAPS 10
OPEN   NO          ALW   NO           RTXTHR 0
HBTIMER 30000
RHOSTVAL RELAXED

ANAME ipg1317a1
LOC 1317          IPLNK PORT A          LINK A
ADAPTER M3UA      VER M3UA RFC
LHOST e1021201.1317a
ALHOST ---
RHOST e1021301.1317a
ARHOST ---
LPORT 1317          RPORT 1317
ISTRMS 2           OSTRMS 2           BUFSIZE 200
RMODE  LIN         RMIN 120           RMAX 800
RTIMES 10          CWMIN 3000        UAPS 10

```

```

OPEN      YES          ALW      YES      RTXTHR  0
HBTIMER  30000
RHOSTVAL  RELAXED

ANAME a1
LOC       1305          IPLNK PORT A      LINK    **
ADAPTER  M3UA          VER        M3UA RFC
LHOST    e1021201.1305a
ALHOST   ---
RHOST    labsun10215p0
ARHOST   ---
LPORT    2001          RPORT     2001
ISTRMS   2            OSTRMS    2          BUFSIZE 200
RMODE    LIN          RMIN      120        RMAX    800
RTIMES   10          CWMIN     3000    UAPS    10
OPEN     YES          ALW      YES      RTXTHR  0
HBTIMER  30000
RHOSTVAL  RELAXED
    
```

```

ANAME a2
LOC       1303          IPLNK PORT A      LINK    A2
ADAPTER  M3UA          VER        M3UA RFC
LHOST    e1021201.1303a
ALHOST   ---
RHOST    labsun10215p0
ARHOST   ---
LPORT    2002          RPORT     2002
ISTRMS   2            OSTRMS    2          BUFSIZE 200
RMODE    LIN          RMIN      120        RMAX    800
RTIMES   10          CWMIN     3000    UAPS    10
OPEN     YES          ALW      YES      RTXTHR  0
HBTIMER  30000
RHOSTVAL  RELAXED
    
```

```

ANAME sg1305m
LOC       1303          IPLNK PORT A      LINK    A1
ADAPTER  M2PA          VER        M2PA RFC
LHOST    e1021201.1303a
ALHOST   ---
RHOST    e1021301.1303a
ARHOST   ---
LPORT    1305          RPORT     1305
ISTRMS   2            OSTRMS    2          BUFSIZE 200
RMODE    LIN          RMIN      120        RMAX    800
RTIMES   10          CWMIN     3000    M2PATSET 1
OPEN     YES          ALW      YES      RTXTHR  0
HBTIMER  30000
RHOSTVAL  RELAXED
    
```

IP Appl Sock/Assoc table is (13 of 4000) 1% full

;

**rtrv-assoc:aname=sg1305a**

eagle10212 09-03-10 17:00:42 EST EAGLE 41.0.0

```

ANAME sg1305a
LOC       1305          IPLNK PORT A      LINK    A
ADAPTER  M3UA          VER        M3UA RFC
LHOST    e1021201.1305a
ALHOST   ---
RHOST    e1021301.1305a
ARHOST   ---
LPORT    2005          RPORT     2005
ISTRMS   2            OSTRMS    2          BUFSIZE 200
RMODE    LIN          RMIN      120        RMAX    800
    
```

```

RTIMES 10          CWMIN 3000      UAPS 10
OPEN   YES         ALW   YES        RTXTHR 0
HBTIMER 30000
RHOSTVAL RELAXED
    
```

LSN;

ls1305a

IP Appl Sock/Assoc table is (13 of 4000) 1% full  
 Assoc Buffer Space Used (600 KB of 3200 KB) on LOC = 1305

;

The following example shows all associations with both primary and alternate remote host values configured.

**rtrv-assoc: rhosttype=alternate: display=all**

ipsig 09-03-10 17:58:37 GMT EAGLE 41.0.0

```

ANAME assoc12
LOC 1111          IPLNK PORT A,B      LINK  A
ADAPTER M2PA      VER        M2PA RFC
LHOST aricent11.com
ALHOST aricent12.com
RHOST tekelec11.com
ARHOST tekelec12.com
LPORT 10003      RPORT 10001
ISTRMS 2          OSTRMS 2          BUFSIZE 200
RMODE LIN        RMIN 120         RMAX 800
RTIMES 10        CWMIN 3000      M2PATSET 1
OPEN NO          ALW YES        RTXTHR 65535
HBTIMER 3000
RHOSTVAL RELAXED
    
```

```

ANAME assoc22
LOC 1201          IPLNK PORT A,B      LINK  A
ADAPTER M2PA      VER        M2PA RFC
LHOST aricent21.com
ALHOST aricent22.com
RHOST tekelec21.com
ARHOST tekelec22.com
LPORT 10003      RPORT 10001
ISTRMS 2          OSTRMS 2          BUFSIZE 200
RMODE LIN        RMIN 120         RMAX 800
RTIMES 10        CWMIN 3000      M2PATSET 1
OPEN NO          ALW YES        RTXTHR 65535
HBTIMER 3000
RHOSTVAL RELAXED
    
```

IP Appl Sock/Assoc table is (4 of 4000) 1% full

;

The following example shows the associations when a primary remote host is provisioned and an alternate remote host is not provisioned.

**rtrv-assoc: rhosttype=primary**

ipsig 09-03-19 17:37:49 GMT EAGLE 41.0.0

```

CARD IPLNK
ANAME LOC PORT LINK ADAPTER LPORT RPORT OPEN ALW
assoc5 1101 A A M2PA 10002 10001 NO YES
assoc6 1102 A A M3UA 30002 30002 NO NO
assoc7 1102 B A SUA 20001 29011 NO NO
    
```

IP Appl Sock/Assoc table is (4 of 4000) 1% full

;  
 The following example displays command association data for an IPSG card, using an M2PA adapter.

**rtrv-assoc:aname=sg1305m**

```
e1001501 09-03-23 16:20:47 EST EAGLE 41.0.0

ANAME sg1305m
LOC 1303 IPLNK PORT A LINK A1
ADAPTER M2PA VER M2PA RFC
LHOST e1021201.1303a
ALHOST ---
RHOST e1021301.1303a
ARHOST ---
LPORT 1305 RPORT 1305
ISTRMS 2 OSTRMS 2 BUFSIZE 200
RMODE LIN RMIN 120 RMAX 800
RTIMES 10 CWMIN 3000 M2PATSET 1
OPEN YES ALW YES RTXTHR 0
HBTIMER 30000
RHOSTVAL RELAXED

LSN;

lsm2pa

IP Appl Sock/Assoc table is (13 of 4000) 1% full
Assoc Buffer Space Used (600 KB of 3200 KB) on LOC = 1303
```

;

**rtrv-atinpopts**

**rtrv-atinpopts**

Use this command to retrieve the data that is used for ATI number conditioning.

**Keyword:** rtrv-atinpopts

**Command Class:** Database Administration

**Parameters**

This command has no parameters.

**Example**

**rtrv-atinpopts**

**Dependencies**

The ATINP feature must be enabled before this command can be entered.

**Output**

The following example shows output with default ATINPQ options.

**rtrv-atinpqopts**

```
tekelecstp 09-06-04 07:53:46 EST EAGLE 41.1.0
```

## ATINPQ OPTIONS

```
-----
ATIACKIMSI      = NONE
ATIACKMSISDN    = MSISDN
ATIACKRN        = RN
ATIDFLTRN       = NONE
ATIDLM          = NONE
ATINPTYPE       = ANY
ENTITYLEN       = NONE
SNAI            = NAI
SPORTTYPE       = NONE
```

```
;
```

**Legend**

- **ATIACKIMSI**—IMSI parameter for ACK response message.
- **ATIACKMSISDN**—MSISDN parameter for ACK response message.
- **ATIACKRN**—Routing Number format.
- **SNAI**—The NAI of the incoming MSISDN digits.
- **ATIDLM**—Outbound message delimiter.
- **ATIDFLTRN**—Default Routing Number.
- **ATINPTYPE**—Number Portability Type.
- **SPORTTYPE**—Service Portability Type.
- **ENTITYLEN**—Entity Length.
- **GRN**—Generic Routing Number.

**rtrv-atm-lps****Retrieve ATM Link Parameter Set**

Use this command to display the parameter values for the ATM link parameter sets in the database configured with the **chg-atm-lps** command, along with the non-configurable ATM parameters.

**Keyword:** **rtrv-atm-lps**

**Related Commands:** **chg-atm-lps**

**Command Class:** Database Administration

**Parameters**

**:lpset=** (optional)

The ATM link parameter set to be displayed.

**Range:** **1-30**

**Default:** All ATM link parameter sets are displayed

**Example**

```
rtrv-atm-lps:lpset=5
```

```
rtrv-atm-lps
```



**Dependencies**

None

**Notes**

None

Output

**NOTE: Dashes (--) in the FC NR and FC BC fields indicate that this implementation is not supported on ATM high-speed signaling links.**

**rtrv-atm-lps:lpset=5**

rlghncxa03w 04-01-04 08:40:18 EST EAGLE 31.3.0  
 ATM LINK PARAMETER SET TIMERS AND PARAMETERS (TIMERS IN SECONDS)

| SSCOP PARAMETERS |       |       |         |     |        |       |       |       |  |
|------------------|-------|-------|---------|-----|--------|-------|-------|-------|--|
| LPSET            | MAXCC | MAXPD | MAXSTAT | TMR | TMR    | TMR   | TMR   | TMR   |  |
|                  |       |       |         | CC  | KALIVE | NORSP | POLL  | IDLE  |  |
| 5                | 4     | 500   | 67      | 0.2 | 0.125  | 1.5   | 0.150 | 0.125 |  |

| SSCF-NNI PARAMETERS |       |          |       |  |
|---------------------|-------|----------|-------|--|
| TMRT1               | TMRT2 | TMRT3    | N1    |  |
| 05.0                | 120.0 | 0.000925 | 64552 |  |

| SAAL PARAMETERS |      |       |       |     |        |  |
|-----------------|------|-------|-------|-----|--------|--|
| MAX             | TMR  | TNRNO | TMR   | N   | TMR    |  |
| NRP             | SREC | CRED  | ERM   | BLK | PROV   |  |
| 1               | 3600 | 1.5   | 0.125 | 3   | 0600.0 |  |

| NONCONFIGURABLE PARAMETERS |      |    |    |    |      |       |       |       |  |
|----------------------------|------|----|----|----|------|-------|-------|-------|--|
| SDU                        | UU   | FC |    | FC |      |       |       |       |  |
| SIZE                       | SIZE | N  | NR | BC | TSUP | TLOSS | ERMSM | THRES |  |
| 272                        | 4    | 9  | -- | -- | 120  | 1.3   | 0.1   | 0.244 |  |

;

**rtrv-atm-lps**

rlghncxa03w 04-01-04 08:40:18 EST EAGLE 31.3.0

| SSCOP PARAMETERS |       |       |         |     |        |       |       |       |  |
|------------------|-------|-------|---------|-----|--------|-------|-------|-------|--|
| LPSET            | MAXCC | MAXPD | MAXSTAT | TMR | TMR    | TMR   | TMR   | TMR   |  |
|                  |       |       |         | CC  | KALIVE | NORSP | POLL  | IDLE  |  |
| 1                | 4     | 500   | 67      | 0.2 | 0.125  | 1.5   | 0.150 | 0.125 |  |
| 2                | 4     | 500   | 67      | 0.2 | 0.125  | 1.5   | 0.150 | 0.125 |  |
| 3                | 4     | 500   | 67      | 0.2 | 0.125  | 1.5   | 0.150 | 0.125 |  |
| 4                | 4     | 500   | 67      | 0.2 | 0.125  | 1.5   | 0.150 | 0.125 |  |
| 5                | 4     | 500   | 67      | 0.2 | 0.125  | 1.5   | 0.150 | 0.125 |  |
| 6                | 4     | 500   | 67      | 0.2 | 0.125  | 1.5   | 0.150 | 0.125 |  |
| 7                | 4     | 500   | 67      | 0.2 | 0.125  | 1.5   | 0.150 | 0.125 |  |
| 8                | 4     | 500   | 67      | 0.2 | 0.125  | 1.5   | 0.150 | 0.125 |  |
| 9                | 4     | 500   | 67      | 0.2 | 0.125  | 1.5   | 0.150 | 0.125 |  |
| 10               | 4     | 500   | 67      | 0.2 | 0.125  | 1.5   | 0.150 | 0.125 |  |
| 11               | 4     | 500   | 67      | 0.2 | 0.125  | 1.5   | 0.150 | 0.125 |  |
| 12               | 4     | 500   | 67      | 0.2 | 0.125  | 1.5   | 0.150 | 0.125 |  |
| 13               | 4     | 500   | 67      | 0.2 | 0.125  | 1.5   | 0.150 | 0.125 |  |
| 14               | 4     | 500   | 67      | 0.2 | 0.125  | 1.5   | 0.150 | 0.125 |  |
| 15               | 4     | 500   | 67      | 0.2 | 0.125  | 1.5   | 0.150 | 0.125 |  |
| 16               | 4     | 500   | 67      | 0.2 | 0.125  | 1.5   | 0.150 | 0.125 |  |
| 17               | 4     | 500   | 67      | 0.2 | 0.125  | 1.5   | 0.150 | 0.125 |  |
| 18               | 4     | 500   | 67      | 0.2 | 0.125  | 1.5   | 0.150 | 0.125 |  |
| 19               | 4     | 500   | 67      | 0.2 | 0.125  | 1.5   | 0.150 | 0.125 |  |
| 20               | 4     | 500   | 67      | 0.2 | 0.1    | 1.5   | 0.1   | 0.1   |  |

| SSCF-NNI PARAMETERS |       |       |          |       |
|---------------------|-------|-------|----------|-------|
| LPSET               | TMRT1 | TMRT2 | TMRT3    | N1    |
| 1                   | 05.0  | 015.0 | 0.000925 | 64552 |
| 2                   | 05.0  | 120.0 | 0.000925 | 64552 |
| 3                   | 05.0  | 120.0 | 0.000925 | 64552 |
| 4                   | 15.0  | 010.0 | 0.000925 | 64552 |
| 5                   | 05.0  | 120.0 | 0.000925 | 500   |
| 6                   | 05.0  | 015.0 | 0.000925 | 64552 |
| 7                   | 05.0  | 120.0 | 0.000925 | 64552 |

```

8      05.0  120.0  0.000925  64552
9      15.0  010.0  0.000925  64552
10     05.0  015.0  0.000925  64552
11     05.0  120.0  0.000925  64552
12     05.0  120.0  0.000925  64552
13     15.0  010.0  0.000925  64552
14     05.0  015.0  0.000925  64552
15     05.0  120.0  0.000925  64552
16     05.0  120.0  0.000925  64552
17     15.0  010.0  0.000925  64552
18     05.0  015.0  0.000925  64552
19     05.0  120.0  0.000925  64552
20     05.0  120.0  0.000925  64552
    
```

```

                                SAAL PARAMETERS
LPSET  MAX  TMR  TNRNO  TMR  N  TMR
       NRP  SREC  CRED  ERM  BLK  PROV
1      1   3600  1.5   0.125  3  1200.0
2      1   3600  1.5   0.125  3  1000.0
3      1    60   1.5   0.125  3  0600.0
4      1   3600  1.5   0.125  3  0600.0
5      1   3600  1.5   0.125  3  0600.0
6      1   3600  1.5   0.125  3  1200.0
7      1   3600  1.5   0.125  3  1000.0
8      1    60   1.5   0.125  3  0600.0
9      1   3600  1.5   0.125  3  0600.0
10     1   3600  1.5   0.125  3  0600.0
11     1   3600  1.5   0.125  3  1200.0
12     1   3600  1.5   0.125  3  1000.0
13     1    60   1.5   0.125  3  0600.0
14     1   3600  1.5   0.125  3  0600.0
15     1   3600  1.5   0.125  3  0600.0
16     1   3600  1.5   0.125  3  1200.0
17     1   3600  1.5   0.125  3  1000.0
18     1    60   1.5   0.125  3  0600.0
19     1   3600  1.5   0.125  3  0600.0
20     1   3600  1.5   0.125  3  0600.0
    
```

```

                                NONCONFIGURABLE PARAMETERS
                                SDU  UU      FC  FC
                                SIZE SIZE  N  NR  BC  TSUP  TLOSS  ERMSM  THRES
272  4      9  --  --  120  1.3  0.1  0.244
    
```

;

**rtrv-atm-lps**

```

tekelecstp 04-01-05 08:40:18 EST EAGLE 31.3.0
ATM LINK PARAMETER SET TIMERS AND PARAMETERS (TIMERS IN SECONDS)
    
```

```

                                SSCOP PARAMETERS
LPSET  MAXCC  MAXPD  MAXSTAT  TMR  TMR  TMR  TMR  TMR
       CC  KALIVE  NORSP  POLL  IDLE
1      4    500   67      0.2  0.125  1.5  0.150  0.125
.
.
20     4    500   67      0.2  0.1   1.5  0.1   0.1
21     4    500   67      0.2  0.1   1.5  0.1   0.1
.
.
30     4    500   67      0.2  0.1   1.5  0.1   0.1
    
```

```

                                SSCF-NNI PARAMETERS
LPSET  TMRT1  TMRT2  TMRT3  N1
       05.0  015.0  0.000925  64552
.
.
20     5      30   0.000925  64552
    
```

```

21      5      120      0.000925      1000
.
.
30      5      120      0.000925      64552

```

```

                                SAAL PARAMETERS
LPSET  MAX  TMR  TNRNO  TMR  N  TMR
      NRP  SREC  CRED  ERM  BLK  PROV
  1      1  3600  1.5   0.125  3  1200.0
.
.
20      1  3600  1.5   0.125  3   0600.0
21      0  3600  1.5   0.125  3  1200.0
.
.
30      0  3600  1.5   0.125  3   0600.0

```

```

                                NONCONFIGURABLE PARAMETERS
      SDU  UU      FC  FC
      SIZE SIZE  N  NR  BC  TSUP  TLOSS  ERMSM  THRES
272    4    9  --  --  120   1.3    0.1    0.244

```

```
;
```

### Legend

**LPSET**—The link parameter set being changed, **1** to **30**. The system default value for this parameter is **1** for ANSI and **21** for ITU.

**ACTION**—Copy a set of ATM signaling link parameters from one parameter set to another. The value of this parameter is **copy**. If this parameter is not specified, then the copy action cannot take place.

**SCRLPSET**—The ATM signaling link parameter set used as a source for the **action=copy** parameter. This parameter can only be specified with the **action=copy** parameter.

**MAXCC**—The maximum number of transmissions of a BGN, END, ER, or RS PDU. The value of this parameter is from 1 to 10 PDUs. The system default value is 4 PDUs.

**MAXPD**—The maximum number of SD PDUs that can be sent before a POLL is sent. The value of this parameter is from 5 to 2120 PDUs. The system default value is 500 PDUs.

**MAXSTAT**—The maximum number of list elements in a STAT PDU. The value of this parameter is from 3 to 67 PDUs. The system default value is 67 PDUs.

**TMRCC**—The timer, in seconds, used during the connection phase to guard against unacknowledged BGN, END, ER or RS PDUs. The value of this parameter is from .1 to 2 seconds. The system default value is .2 seconds.

**TMRKALIVE**—The timer, in seconds, used during the transient phase when no SD PDUs are being sent to keep connection up. The value of this parameter is from .025 to .5 seconds. The system default value is .1 seconds.

**TMRNOSP**—The timer, in seconds, used to check that STAT PDUs are arriving often enough. The value of this parameter is from .5 to 2 seconds. The system default value is 1.5 seconds.

**TMRPOLL**—The timer, in seconds, used to guarantee that POLL PDUs are sent often enough. The value of this parameter is from .025 to .5 seconds. The system default value is .1 seconds.

**TMRIDLE**—The timer, in seconds, used during the idle phase when no SD PDUs are being sent to limit time in the idle phase. The value of this parameter is from .025 to 1 seconds. The system default value is .1 seconds.

**TMRT1**—The time, in seconds, between a link release action and the next link reestablish action during alignment. The value of this parameter is from 1 to 15 seconds. The system default value is 5 seconds.

**TMRT2**—The total time, in seconds, that SSCF will attempt alignment. The value of this parameter is from 15 to 180 seconds. The system default value is 120 seconds for ANSI and 30 seconds for ITU.

**TMRT3**—The time, in seconds, between proving PDUs. The value of this parameter is from .00045 to .023 seconds. The system default value is .000925 seconds.

**N1**—The number of PDUs sent during proving. The value of this parameter is from 500 to 64552 PDUs. The system default value is 64552 PDUs for ANSI and 1000 PDUs for ITU.

**MAXNRP**—The maximum number of retransmitted PDUs during proving. The value of this parameter is from 1 to 10 PDUs. The system default value is 1 PDU for ANSI and 0 PDUs for ITU.

**TMRSREC**—The timer, in seconds, used to prohibit closely spaced SSCOP recoveries from occurring. The value of this parameter from is 60 to 10800 seconds. The system default value is 3600 seconds.

**TMRNOCRED**—The timer, in seconds, used when the no credit exists and PDUs are available to be sent. The value of this parameter is from 1 to 6 seconds. The system default value is 1.5 seconds.

**TMRERM**—The error rate monitor interval, in seconds. The value of this parameter is from .025 to .5 seconds. The system default value is .1 seconds.

**NBLK**—The number of monitoring intervals per block. The value of this parameter is from 1 to 10. The system default value is 3.

**TMRPROV**—The timer, in seconds, used to monitor the status of a link after it is placed into service. The value of this parameter from 60 to 1200 seconds. The system default value is 600 seconds.

**SDU SIZE**—The SSCOP SDU size (set to 272 octets).

**UU SIZE**—The SCOP UU size (set to 4 octets).

**N**—The monitoring intervals spanning a .4 second error event (set to 9).

**FC NR**—The fixed credit increment value.

**FC BC**—The fixed credit allocation frequency.

**TSUP**—The superblock timer for layer management, in seconds.

**TLOSS**—The loss timer for layer management, in seconds.

**ERMSM**—The error rate monitor smoothing factor.

**THRES**—The error rate monitor threshold.

## rtrv-atm-prm

## Retrieve ATM Parameters

Use this command to display system-wide non-configurable ATM layer parameters for each ATM high-speed signaling link. The data displayed includes the ATM interface parameters and the ATM traffic descriptor values.

**Keyword:** rtrv-atm-prm

**Related Commands:** rtrv-atm-lps

**Command Class:** Database Administration

### Parameters

This command has no parameters.

### Example

```
rtrv-atm-prm
```

### Dependencies

None

**Notes**

None

**Output**

```

rtrv-atm-prm
      tekelecstp 04-02-05 08:40:18 EST  EAGLE 31.3.0
      DS1  DS1  E1   E1           MAX  MAX  VCI  VPI
      PCR  SCR  PCR  SCR   BT   CDVT QOS  VPCs VCCs BITS BITS
      3622 3622 4528 4528 210  100  3   0   1   16  12
;

```

**Legend**

The ATM traffic descriptors are displayed in the following fields:

**BT**—Burst tolerance. The number of consecutive cells on the VCL permitted on the ATM interface by the enforcement process, given the PCR and the line speed.

**CDVT**—The amount of cell delay variation for the VCL in the network ingress direction.

**PCR**—The maximum or peak cell rate for the VCL (virtual channel link) T1 is for ANSI and E1 is for ITU.

**QOS**—Quality of service. The performance objectives that must be met by the ATM VCL when it must discard cells during enforcement of the traffic parameters.

**SCR**—The average or sustainable cell rate supported on the VCL. T1 is for ANSI and E1 is for ITU.

The ATM interface parameters are displayed in the following fields:

**MAX VCCs**—The maximum number of simultaneously active Virtual Circuit Connections (VCCs) supported.

**MAX VPCs**—The maximum number of simultaneously active Virtual Path Connections (VPCs) supported (by the ATM interface).

**VCI BITS**—The number of allocated VCI bits to be used in the VPIs in the ATM cells for the VCLs supported on the ATM interface.

**VPI BITS**—The number of bits to be used in the VPIs in the ATM cells for the VPLs terminated on the ATM interface.

**rtrv-attr-seculog****Display Security Log Characteristic**

Use this command to display security log attributes that were configured using the **chg-attr-seculog** command.

**Keyword:** **rtrv-attr-seculog**

**Related Commands:** **chg-attr-seculog**

**Command Class:** Security Administration

**Parameters**

This command has no parameters.

**Example**

```
rtrv-attr-seculog
```

**Dependencies**

None

**Notes**

None

**Output**

```

rtrv-attr-seculog
rlghncxa03w 04-01-07 08:16:17 EST EAGLE 31.3.0
Security log attributes
-----
UPLDALM      yes
UPSLG        80
;

```

**rtrv-bip****Retrieve Board Identification PROMs**

Use this command to show the board identification PROM (BIP) data for a specified card (main assembly or applique) and location.

The following information is displayed for both main assemblies and appliques: board part number, board revision, serial number (7, 8, 11, 12, or 14 digits), manufacturing date, and the software match ID.

For main assemblies, the port A ethernet address (if ENT01 record exists) and port B ethernet address (if ENT02 record exists) are also displayed.

For appliques, the applique type and ethernet address (if the applique type is ENET and ENT01 record exists) are also displayed.



**CAUTION: To have the rtrv-bip command display MAC addresses, the daughterboard must have a type of ENET.**

**Keyword:** rtrv-bip

**Related Commands:** chg-bip-fld, chg-bip-rec, disp-bip, tst-bip

**Command Class:** System Maintenance

**Parameters**

**:loc=** (mandatory)

The card location as stenciled on the shelf of the system.

**Range:** 1101-1112, 1201-1218, 1301-1318, 2101-2118, 2201-2218, 2301-2318, 3101-3118, 3201-3218, 3301-3318, 4101-4118, 4201-4218, 4301-4318, 5101-5118, 5201-5218, 5301-5318, 6101-6118

**NOTE:** xy09 and xy10 locations are valid only if they are equipped with HIPR2 card.

**:type=** (mandatory)

The type of board at the specified location whose BIP information is to be displayed.

**Range:** mbd, dbd  
**mbd** — main assembly  
**dbd** — applique

**:dbdloc=** (optional)

Applique location. This parameter specifies the location of the applique.

This parameter can be specified only for cards that support multiple appliques.

**Range:** 1-2

**Example**

The following example displays the BIP data for the main assembly.

```
rtrv-bip:loc=1201:type=mbd
```

The following example displays the BIP data for all appliques that are supported by the card.

```
rtrv-bip:loc=1201:type=dbd
```

The following example displays the BIP data for the first applique.

```
rtrv-bip:loc=1103:type=dbd:dbdloc=1
```

**Dependencies**

The card location frame, shelf, and slot must be within the allowed range.

The card location must be valid for the command.

The **type=dbd** parameter cannot be specified for card type GPSM-II, HCAP, ATM or DCM. HMUX and HIPR cards do not contain BIP information.

The **dbdloc** parameter can be specified only for the cards that support multiple appliques.

If the **type=mbd** parameter is specified, then the **dbdloc** parameter cannot be specified.

**Notes**

The **tst-bip** command verifies that the PROM is good by writing to and reading from the PROM. The **rtrv-bip** command shows the level of the BIP, as well as the board part number, the revision number, and the serial number. If the **rtrv-bip** command fails, this indicates that communication to the card has failed, and you might need to replace the card. Contact Tekelec Technical Service at (888) FOR-TKLC to find out if the card can be reprogrammed.



**Output**

The Max Power Rating is displayed only if the **type=mbd** parameter is specified. If the Card Power value is not present in BIP data, then the Max Power Rating is displayed as **Undef**.

The location of the applique is displayed only if the card supports multiple appliques.

The following example displays the 7-digit serial number of a main assembly card manufactured on the eleventh week of 1993).

```

rtrv-bip:type=mbd:loc=1201
tekelecstp 07-03-14 23:32:51 IST EAGLE 37.0.0
-----
Location: 1201 MBD

Part Number: 850-0187-03
Revision: G2 Week/Year: 11/1993
Serial Number: 3110195

Software Match ID: EG - 001 Max Power Rating : Undef
-----
END OF REPORT
;

```

The following example displays the 7-digit serial number of a DS0 applique manufactured on the tenth week of 1993.

```

rtrv-bip:loc=1201:type=dbd
rlghncxa03w 07-03-04 08:16:20 EST EAGLE 37.0.0
-----
Location: 1201 - DBD

Part Number: 850-0196-01
Revision: B1 Week/Year: 10/1993
Serial Number: 3100138

Software Match ID: EG - 001
Daughterboard Type: DS0
-----
END OF REPORT
;

```

The following example displays the 14-digit serial number with ethernet port A and B records, manufactured on the eleventh week of 2001.

```

rtrv-bip:loc=1201:type=mbd
tekelecstp 07-03-14 23:32:51 IST EAGLE 37.0.0
-----
Location: 1201 - MBD

Part Number: 850-0187-03
Revision: G2 Week/Year: 11/2001
Serial Number: 102200111a0195

Software Match ID: EG - 001 Max Power Rating : Undef

Ethernet Port A Address: 00001704000C
Ethernet Port B Address: 000017040
-----
END OF REPORT
;

```

The following example displays the BIP data for the main assembly when the Max Power Consumption value for the card is present.

**rtrv-bip:loc=1103:type=mbd**

tekelecstp 07-03-14 23:32:51 IST EAGLE 37.0.0

-----  
Location: 1103 - MBD

Part Number: 870-2212-02

Revision: A

Week/Year: 26/2006

Serial Number: 10206265084

Software Match ID: EG - 001

Max Power Rating : 646 mA

-----  
;END OF REPORT

;

The following example displays the BIP data for the first applique.

**rtrv-bip:loc=1103:type=dbd:dbdloc=1**

tekelecstp 07-03-04 17:40:13 IST EAGLE 37.0.0

-----  
Location: 1103 - DBD

DBD Location: 1

Part Number: 850-0666-02

Revision: E

Week/Year: 26/2006

Serial Number: 10206265084

Software Match ID: EG - 001

DBD Type: Ethernet

Ethernet ENT01 Address: 0000170cd17e

Ethernet ENT02 Address: 0000170cd17f

-----  
END OF REPORT

;

The following example displays the BIP data for all appliques that are supported by the card.

**rtrv-bip:loc=1103:type=dbd**

tekelecstp 07-03-04 23:32:55 IST EAGLE 37.0.0

-----  
Location: 1103 - DBD

DBD Location: 1

Part Number: 850-0666-02

Revision: C

Week/Year: 26/2006

Serial Number: 10206265084

Software Match ID: EG - 001

DBD Type: Ethernet

Ethernet ENT01 Address: 0000170cd17e

Ethernet ENT02 Address: 0000170cd17f

-----  
Location: 1103 - DBD

DBD Location: 2

Part Number: 850-0666-02

Revision: C

Week/Year: 26/2006

Serial Number: 10206265084

Software Match ID: EG - 001

DBD Type: Ethernet

Ethernet ENT01 Address: 0000170cd17c

Ethernet ENT02 Address: 0000170cd17d

-----  
END OF REPORT

;

The following example displays the BIP data for SS7 ATM daughterboard.

```
rtrv-bip:loc=1215:type=dbd
tekelecstp 07-03-04 23:32:55 IST EAGLE 37.0.0
-----
Location: 1215 - DBD

Part Number: 850-0646-02
Revision: A Week/Year: 25/2006
Serial Number: 10206255430

Software Match ID: EG - 001
DBD Type: ATM
-----
;END OF REPORT
;
```

The following example displays the BIP data for all appliques that are supported by the card, if card BIP data is from an earlier EAGLE 5 ISS release that did not support the **dbdloc** parameter.

**NOTE: This case is for backward compatibility. Although the card contains two daughterboards, the card BIP data is from a release (prior to EAGLE 5 ISS Release 37.0) that does not support BIP records for multiple DBDs. The Ethernet Addresses for both DBDs are shown as part of the BIP data for the first DBD.**

```
rtrv-bip:loc=1106:type=dbd
tekelecstp 07-03-04 23:32:55 EST EAGLE 37.0.0
-----
Location: 1106 - DBD DBD Location : 1

Part Number: 870-2212-02
Revision: A Week/Year: 25/2006
Serial Number: 10206255461

Software Match ID: EG - 001
DBD Type: Ethernet
Ethernet ENT01 Address: 0000170cd340
Ethernet ENT02 Address: 0000170cd341
Ethernet ENT03 Address: 0000170cd342
Ethernet ENT04 Address: 0000170cd343
-----
Board ID Prom notification : Card DBD BIP contains no valid loc: 2 data
-----
;END OF REPORT
;
```

The following example displays the BIP data for HIPR2 main assembly card.

```
rtrv-bip:loc=1109:type=mbd
tekelecstp 09-06-07 23:32:51 IST EAGLE 41.1.0
-----

Location: 1109 MBD

Part Number: 870-2872-01
Revision: A Week/Year: 11/2003
Serial Number: 10105365048

Software Match ID: EG - 001 Max Power Rating : 646 mA
-----
END OF REPORT
;
```

**Legend**

**LOCATION**—The card location and board type for the BIP information.

**DBD LOCATION**—The location of the applique.

**PART NUMBER**—The part number of the card in the specified card location.

**REVISION**—The hardware version of the card.

**SERIAL NUMBER**—The serial number (7, 8, 11, 12, or 14 digits) of the card. Table 5-79 shows the serial number formats.

**Table 5-79.** Serial Number Formats

| Serial Numbers                                                                                                                                                                                                        | Formats       |
|-----------------------------------------------------------------------------------------------------------------------------------------------------------------------------------------------------------------------|---------------|
| 7-digit serial number                                                                                                                                                                                                 | ywwxxxx       |
| 8-digit serial number                                                                                                                                                                                                 | yywwxxxx      |
| 11-digit serial number                                                                                                                                                                                                | nnnywwxxxx    |
| 12-digit serial number                                                                                                                                                                                                | nnnyww*xxxx   |
| 14-digit serial number                                                                                                                                                                                                | nnnyyyww*xxxx |
| <b>Legend</b><br>y = year digit (0–9)<br>w = week digit (0–9)<br>n = product identifier digit (0–9)<br>x = serial number digit (0–F hexadecimal)<br>* = special character (0–9, a–z, or A–Z, alphanumeric characters) |               |

**SOFTWARE MATCH ID**—This field is used to check hardware and software compatibility.

**DBD TYPE**—Type of daughterboard applique.

**MAX POWER RATING**—The maximum power rating of the card.

**WEEK/YEAR**—The week (1–52) and the year (4 digits) that the card was manufactured.

## rtrv-card

## Retrieve Card

Use this command to display the information about a card. The command displays the card type, the application the card is running, the linkset name, the signaling links, and the signaling link codes. If no parameter is specified, the command displays information for all cards defined by the **ent-card** command. If the **loc** parameter is specified, the command displays information for the specified card only.

**Keyword:** rtrv-card

**Related Commands:** dlt-card, ent-card, init-card, rept-stat-card, rmv-card, rst-card

**Command Class:** Database Administration

### Parameters

**:links=** (optional)

Links Provision Status. For the card in the location specified by the **loc** parameter, all links, only equipped links, or only unequipped links are displayed. If the parameter is not specified, only the equipped links are displayed.

**Range:** **all, equip, unequip, ipsg**  
**all**— Display all possible links for the card.  
**equip**— Display links that are equipped on the card.  
**unequip**— Display links that are allowed but not equipped on the card.  
**ipsg**— Display the SLKTPS and total card TPS used for a particular card or for all cards configured with the **ipsg** GPL.

**Default:** **equip**

**:loc=** (optional)

The card location as stenciled on the shelf of the system.

**Range:** **1101-1108, 1111-1117, 1201-1208, 1211-1218, 1301-1308, 1311-1318, 2101-2108, 2111-2118, 2201-2208, 2211-2218, 2301-2308, 2311-2318, 3101-3108, 3111-3118, 3201-3208, 3211-3218, 3301-3308, 3311-3318, 4101-4108, 4111-4118, 4201-4208, 4211-4218, 4301-4308, 4311-4318, 5101-5108, 5111-5118, 5201-5208, 5211-5218, 5301-5308, 5311-5318, 6101-6108, 6111-6118**

**Default:** Retrieve all

### Example

```
rtrv-card
rtrv-card:loc=1205
rtrv-card:links=ipsg
rtrv-card:loc=1111:links=ipsg
```

### Dependencies

The card location slot must be between **1** and **18** and not **9** or **10**.

The card location cannot be **1114**, **1116**, **1117**, or **1118**.

The shelf location must be **11xx**, **12xx**, **13xx**, **21xx**, **22xx**, **23xx**, **31xx**, **32xx**, **33xx**, **41xx**, **42xx**, **43xx**, **51xx**, **52xx**, **53xx**, or **61xx**.

The specified card location must be equipped in the database.

### Notes

None

Output

**rtrv-card**

```

rlghncxa03w 09-04-15 16:34:56 EST EAGLE 41.0.0
CARD  TYPE      APPL      LSET NAME      LINK SLC LSET NAME      LINK SLC
1101  DSM         VSCCP      -----      A   --  -----      B   --
1102  TSM         GLS        -----      A   --  -----      B   --
1103  DCM         STPLAN     -----      A   --  -----      B   --
1113  GPSM        OAM
1114  TDM-A
1115  GPSM        OAM
1116  TDM-B
1117  MDAL
1205  LIME1       CCS7ITU    ellim1        A   0   -----      B   --
-----      A1  --  -----      B1  --
-----      A2  --  -----      B2  --
-----      A3  --  -----      B3  --
1206  LIMCH       CCS7ITU    ellim1        A   1   -----      B   --
-----      A1  --  -----      B1  --
-----      A2  --  -----      B2  --
-----      A3  --  -----      B3  --
1207  LIME1       SS7ANSI    ellsn1        A   0   eljwk4        B   1
-----      A1  2   eljwk3        B1  2
-----      A2  4   eljwk2        B2  15
-----      A3  --  eljwk1        B3  16
1208  LIMCH       SS7ANSI    eljwk5        A   8   ellsn1        B   1
-----      A1  9   ellsn7        B1  13
-----      A2  10  ellsn6        B2  14
-----      A3  10  ellsn5        B3  15
1211  LIMT1       SS7ANSI    tllsn1        A   0   tllsn1        B   1
-----      A1  --  tllsn1        B1  2
-----      A2  0   tllsn6        B2  6
-----      A3  13  -----      B3  --
1212  LIMCH       SS7ANSI    tllsn1        A   3   tllsn13       B   10
-----      A1  16  tllsn14       B1  10
-----      A2  1   tllsn15       B2  4
-----      A3  8   -----      B3  --
;

```

The following example shows a retrieval by the specified card location:

**rtrv-card:loc=1205**

```

rlghncxa03w 04-01-15 16:34:56 EST EAGLE 31.3.0
CARD  TYPE      APPL      LSET NAME      LINK SLC LSET NAME      LINK SLC
1205  LIMDS0       SS7ANSI    LS1           A   0   LS1           B   1
-----      A1  2   LS1           B1  3
-----      A2  4   LS1           B2  5
-----      A3  6   LS1           B3  7
;

```

The following example shows the output when MPL (multi-port LIM) cards are provisioned on the system:

**rtrv-card**

```

rlghncxa03w 09-04-15 16:34:56 EST EAGLE 41.0.0
CARD  TYPE      APPL      LSET NAME      LINK SLC LSET NAME      LINK SLC
1201  LIMDS0       SS7ANSI    LS1           A   0   LS1           B   1
-----      A1  2   LS1           B1  3
-----      A2  4   LS1           B2  5
-----      A3  6   LS1           B3  7
1202  LIMDS0       SS7ANSI    LS2           A   0   LS3           B   0
-----      A1  --  LS3           B1  1
-----      A2  1   LS2           B2  2
-----      A3  --  -----      B3  --
1204  LIMATM       ATMANSI    LS5           A   0   -----      B   --

```

```

1205 DCM IPLIM ----- A -- LS6 B 0
1102 DSM VSCCP ----- A -- ----- B --
1113 GPSM OAM
1114 TDM-A
1115 GPSM OAM
1116 TDM-B
1117 MDAL
1303 DCM IPGWI ipgwitun A 00 ----- B --
;

```

The following example includes an SSED CM cards used as an IPLIM to 8 Points card:

**rtrv-card**

```

rlghncxa03w 09-04-15 16:34:56 EST EAGLE 41.0.0
CARD TYPE APPL LSET NAME LINK SLC LSET NAME LINK SLC
1201 LIMDS0 SS7ANSI LS1 A 0 LS1 B 1
LS1 A1 2 LS1 B1 3
LS1 A2 4 LS1 B2 5
LS1 A3 6 LS1 B3 7
1202 LIMDS0 SS7ANSI LS2 A 0 LS3 B 0
----- A1 -- LS3 B1 1
LS2 A2 1 LS2 B2 2
----- A3 -- ----- B3 --
1204 LIMATM ATMANSI LS5 A 0 ----- B --
1205 DCM IPLIM LS6 A 0 LS6 B 1
LS6 A1 1 LS6 B1 2
LS6 A2 4 LS6 B2 5
LS6 A3 6 LS6 B3 7
1102 DSM VSCCP ----- A -- ----- B --
1113 GPSM OAM
1114 TDM-A
1115 GPSM OAM
1116 TDM-B
1117 MDAL
;

```

The following example shows output for an E5-SM4G or VSCCP card.

**rtrv-card:loc=6111**

```

tklc1110501 07-04-12 17:33:25 EST EAGLE5 37.0.0
CARD TYPE APPL LSET NAME LINK SLC LSET NAME LINK SLC
6111 DSM VSCCP
;

```

The following example lists unequipped links on the provisioned cards.

**rtrv-card:links=unequip**

```

stdcfgl1a 07-05-24 14:04:54 EST 37.0.0
CARD TYPE APPL UNEQUIPPED LINKS
1101 LIMDS0 SS7ANSI A1 B1 B3
1102 LIMDS0 SS7ANSI A1 B1 A2 B2 A3 B3
1103 LIMDS0 SS7ANSI A1 A2 A3
1113 GPSM OAM
1114 TDM-A
1115 GPSM OAM
1116 TDM-B
1117 MDAL
;

```

**rtrv-card:links=ipsg**

```

e1001501 08-02-23 16:20:42 EST EAGLE 38.0.0
CARD TYPE APPL LSET NAME LINK SLC SLKTPS
1105 ENET IPSG e1e2sg1 A 0 410
e1e2sg1 B 4 410
e1e2sg1 A1 1 410
;

```

```

                ele2sg1    B1    5    410
                ele2sg1    A2    2    410
                ele2sg1    B2    6    410
                ele2sg1    A3    3    410
                ele2sg1    B3    7    410
                Total SLKTPS is (3280 of 5000) 66%
1211  ENET  IPSP      ls1211a    A     0    500
                ls1211b    A1    0    600
                ls1211b    B1    1    600
                ls1211c    A2    0    700
                lsm3ua1    A3    0    1600
                Total SLKTPS is (4000 of 5000) 80%
1213  ENET  IPSP      ls1213a    A     0    800
                ls1213b    A1    0    900
                ls1213c    A2    0    1000
                lsm3ua1    A3    1    1600
                Total SLKTPS is (4300 of 5000) 86%
1215  ENET  IPSP      m3ua01    A     0    10
                m3ua02    B     0    10
                m3ua03    A1    0    10
                m3ua04    B1    0    10
                m3ua05    A2    0    10
                m3ua06    B2    0    10
                m3ua07    A3    0    10
                m3ua08    B3    0    10
                m3ua09    A4    0    10
                m3ua10    B4    0    10
                m3ua11    A5    0    10
                m3ua12    B5    0    10
                m3ua13    A6    0    10
                m3ua14    B6    0    10
                m3ua15    A7    0    10
                m3ua16    B7    0    10
                Total SLKTPS is (160 of 5000) 3%

```

;

**rtrv-card:links=ipsg:loc=1105**

```

e1001501 08-02-23 16:20:42 EST EAGLE 38.0.0
CARD  TYPE  APPL  LSET NAME  LINK SLC  SLKTPS
1105  ENET  IPSP      ele2sg1    A     0    410
                ele2sg1    B     4    410
                ele2sg1    A1    1    410
                ele2sg1    B1    5    410
                ele2sg1    A2    2    410
                ele2sg1    B2    6    410
                ele2sg1    A3    3    410
                ele2sg1    B3    7    410
                Total SLKTPS is (3280 of 5000) 66%

```

;

The following example includes IPSP cards.

**rtrv-card**

```

eagle10110 08-03-15 18:53:18 EST EAGLE 38.0.0

CARD  TYPE  APPL  LSET NAME  LINK SLC  LSET NAME  LINK SLC
1105  IPSP    IPS
1107  DCM     SS7IPGW  lgipgw    A     1
1113  GPSM    OAM
1114  TDM-A
1115  GPSM    OAM
1116  TDM-B
1117  MDAL
1201  LIMDS0  SS7ANSI  e5m5s1    A     0    e5m5s2    B     0
1202  LIMDS0  SS7ANSI  e5m5s1    A     1    e5m5s2    B     1

```



|      |        |         |          |     |    |          |     |    |
|------|--------|---------|----------|-----|----|----------|-----|----|
| 1203 | LIMDS0 | SS7ANSI | e5m5s1   | A   | 2  | e5m5s2   | B   | 2  |
| 1204 | LIMDS0 | SS7ANSI | e5m5s1   | A   | 3  | e5m5s2   | B   | 3  |
| 1205 | LIMDS0 | SS7ANSI | e5m5s1   | A   | 4  | e5m5s2   | B   | 4  |
| 1206 | LIMDS0 | SS7ANSI | e5m5s1   | A   | 5  | e5m5s2   | B   | 5  |
| 1207 | LIMDS0 | SS7ANSI | e5m5s1   | A   | 6  | e5m5s2   | B   | 6  |
| 1208 | LIMATM | ATMANSI | e5m5s1   | A   | 14 |          |     |    |
| 1211 | LIMDS0 | CCS7ITU | e5m6s1   | A   | 0  | e5m6s2   | B   | 0  |
| 1212 | LIMDS0 | CCS7ITU | e5m6s1   | A   | 1  | e5m6s2   | B   | 1  |
| 1213 | LIMDS0 | CCS7ITU | e5m6s1   | A   | 2  | e5m6s2   | B   | 2  |
| 1214 | LIMDS0 | CCS7ITU | e5m6s1   | A   | 3  | e5m6s2   | B   | 3  |
| 1215 | LIMDS0 | CCS7ITU | e5m6s1   | A   | 4  | e5m6s2   | B   | 4  |
| 1216 | LIMDS0 | CCS7ITU | e5m6s1   | A   | 5  | e5m6s2   | B   | 5  |
| 1217 | LIMDS0 | CCS7ITU | e5m6s1   | A   | 6  | e5m6s2   | B   | 6  |
| 1218 | LIMATM | ATMANSI | e5m5s1   | A   | 15 |          |     |    |
| 1301 | ENET   | IPSG    | ls1301a  | A   | 0  | ls1301a  | B   | 1  |
|      |        |         | e5e6b    | A4  | 0  | e5e6b    | B4  | 1  |
|      |        |         | e5e6b    | A5  | 2  | e5e6b    | B5  | 3  |
|      |        |         | e5e6b    | A6  | 4  | e5e6b    | B6  | 5  |
|      |        |         | e5e6b    | A7  | 6  | e5e6b    | B7  | 7  |
|      |        |         | e5e6b    | A8  | 8  | e5e6b    | B8  | 9  |
|      |        |         | e5e6b    | A9  | 10 | e5e6b    | B9  | 11 |
|      |        |         | e5e6b    | A10 | 12 | e5e6b    | B10 | 13 |
|      |        |         | e5e6b    | A11 | 14 | e5e6b    | B11 | 15 |
| 1303 | ENET   | IPSG    | ls1303a  | A   | 0  | ls1303a  | B   | 1  |
|      |        |         | ls1303a  | A1  | 2  | ls1303a  | B1  | 3  |
|      |        |         | ls1303a  | A2  | 4  | ls1303a  | B2  | 5  |
|      |        |         | ls1303a  | A3  | 6  | ls1303a  | B3  | 7  |
|      |        |         | ls1303c  | A4  | 1  | ls1303c  | B4  | 2  |
|      |        |         | ls1303c  | A5  | 3  | ls1303c  | B5  | 4  |
|      |        |         | ls1303c  | A6  | 5  | ls1303c  | B6  | 6  |
|      |        |         | ls1303c  | A7  | 7  | ls1303c  | B7  | 8  |
| 1304 | ENET   | IPSG    | e5e6m2pa | A   | 0  | e5e6m2pa | B   | 1  |
|      |        |         | e5e6iii  | A1  | 0  | m3ua     | B1  | 0  |
|      |        |         | m3ua     | B2  | 1  | m3ua     | B3  | 2  |
|      |        |         | m3ua     | B4  | 3  |          |     |    |
| 1305 | ENET   | IPSG    | ls1303b  | A   | 0  | ls1305a  | B   | 0  |
|      |        |         | ls1305a  | B1  | 1  | ls1305b  | B2  | 0  |
| 1306 | LIME1  | CCS7ITU | ls130601 | A   | 0  | ls130602 | B   | 0  |
| 1307 | DCM    | SS7IPGW | ls1307a  | A   | 0  |          |     |    |
| 1308 | DCM    | SS7IPGW | lgipgw   | A   | 0  |          |     |    |
| 1311 | DCM    | IPLIM   | e5e6a    | A   | 0  | e5e6a    | B   | 2  |
|      |        |         | e5e6a    | A1  | 4  | e5e6a    | B1  | 6  |
|      |        |         | e5e6a    | A2  | 8  | e5e6a    | B2  | 10 |
|      |        |         | e5e6a    | A3  | 12 | e5e6a    | B3  | 14 |
| 1313 | DCM    | IPLIMI  | e5e6i    | A   | 1  | e5e6i    | B   | 3  |
| 1314 | ENET   | IPSG    | a        | A   | 0  |          |     |    |
| 1315 | DCM    | SS7IPGW | ls1315a  | A   | 0  |          |     |    |
| 1316 | DCM    | IPGWI   | lsipgw   | A   | 0  |          |     |    |
| 1317 | DCM    | IPGWI   | ls1317i  | A   | 0  |          |     |    |

;

**Legend**

**CARD**—The card location as stenciled on the shelf of the system.

**TYPE**—The type of card. (The DCM and SSED CM cards are card type DCM).

**APPL**—The application associated with each card in the display.

**LSET NAME**—The linkset name associated with the cards in the display.

**LINK**

—The signaling link associated with the linkset. If the card is an MPL or MPL-T (TYPE is **limds0**

, APPL is **ss7ansi**) or an E1/T1 MIM (**TYPE** can be **lime1**, **limt1**, or **limch**; **APPL** can be **ss7ansi** or **ccs7itu**), the card can support 8 ports (**a**, **a1**, **a2**, **a3**, **b**, **b1**, **b2**, and **b3**).

**SLC**—The signaling link code.

**UNEQUIPPED LINKS**—Signaling links that are unequipped on the provisioned card.

**SLKTPS**—Transactions Per Second configured for signaling links provisioned on the card.

## rtrv-clkopts

## Retrieve Clock Options

Use this command to retrieve the values of the clock parameters which are maintained in the STP's option table. All values are assigned initially to system defaults during STP installation, and can be updated using this command.

**Keyword:** **rtrv-clkopts**

**Related Commands:** **chg-clkopts**

**Command Class:** Database Administration

### Parameters

### Dependencies

No parameters can be specified with this command.

### Notes

None

### Output

```

rtrv-clkopts
e5oam 09-01-02 17:20:05 MST  EAGLE 40.1.0
CLK OPTIONS
-----

PRIMARY
-----
HSCLKSRC          rs422
HSCLKLL           longhaul

SECONDARY
-----
HSCLKSRC          rs422
HSCLKLL           longhaul

;

rtrv-clkopts
e5oam 09-01-02 17:26:51 MST  EAGLE 40.1.0
CLK OPTIONS
-----

PRIMARY
-----
HSCLKSRC          rs422
HSCLKLL           longhaul

SECONDARY
-----
HSCLKSRC          rs422
HSCLKLL           shorthaul

;

```

**rtrv-cmd****Retrieve Command Attributes**

Use this command to retrieve the list of command classes to which a command is assigned. You can retrieve output for one command, commands in one command class, or all commands.

**Keyword:** rtrv-cmd

**Related Commands:** chg-cmd

**Command Class:** Basic

**Parameters**

**:class=** (optional)

The command class whose attributes are to be retrieved.

**Range:** ayyyyy

One alphabetic character followed by up to 5 additional alphanumeric characters.

**:cmd=** (optional)

The command whose attributes are to be retrieved.

**Range:** ??????????????????

One alphabetic character followed by up to 19 additional alphanumeric characters, enclosed in double quotes.

**Example**

```
rtrv-cmd:cmd="ent-rte"
```

```
rtrv-cmd:class=dab
```

```
rtrv-cmd
```

**Dependencies**

The Command Class Management feature must be enabled before a configurable command class name can be specified in the **class** parameter.

The LNP feature must be turned on (see the **enable-ctrl-feat** command) before a command from the LNPBAS class can be specified in the **cmd** parameter or before the **class=lnpbas** parameter can be specified.

The value of the **cmd** parameter must be a valid system command.

The value of the **class** parameter must be a valid configurable or non-configurable command class name.

The Command Class Management feature must be enabled before CHG-CMD or CHG-CMDCLASS command can be entered.

**Notes**

This command can be canceled using the **F9** function key or the **cancel-cmd** command. See **cancel-cmd** for more information.

**Output**

The following example shows the command classes to which the **rept-stat-slk** command is assigned (non-configurable class **sys** and user-configured classes **u01**, **u02**, **krb**, and **u11**):

```
rtrv-cmd:cmd="rept-stat-slk"
  eagle10404 04-01-22 16:30:56 EST  EAGLE 31.3.0
  cmd          CLASS
  rept-stat-slk      sys, u01, u02, krb, u11
```

```
;
```

The following example shows the commands assigned to user-configured command class **krb**:

```
rtrv-cmd:class=krb
  eagle10404 04-01-22 16:30:56 EST  EAGLE 31.3.0
  CMD          CLASS
  rept-stat-slk      sys, u01, u02, krb, u11
  act-slk          link, u09, krb
  ent-user         sa, krb, abc, u23
  alw-card         sys, u09 dab, krb
```

```
;
```

```
rtrv-cmd:class=link
  eagle10404 04-01-22 16:30:56 EST  EAGLE 31.3.0
  CMD          CLASS
  alw-slk        link, u11
  unhb-slk       link
  inh-slk        link, abc
  rtrv-meas-sched link, abc, def
  act-lbp        link
  act-dlk        link
  act-slk        link
  act-lpo        link
  blk-slk        link, abc, u23, u31
  dact-lbp       link
  canc-dlk       link
  cancel-lpo     link, u01, u02, u03, u04, u05, u06, u07, u08, u09, u10,
  u11, u12, u13
  cancel-slk     link
  ublk-slk       link, u01, u02, u03, u04, u05, u06, u07, u08, u09, u10,
  u11, u12, u13, u14, u15, u16, u17, u18, u19, u20, u21,
  u22, u23, u24, u25, u26, u27, u28, u29, u30, u31, u32
  rept-x25-meas  link
  rept-meas      link
  chg-meas       link
  tst-dlk        link, krb
  tst-slk        link
```

```
;
```

```
rtrv-cmd
  eagle10404 04-01-22 16:30:56 EST  EAGLE 31.3.0
  CMD          CLASS
  alw-slk        link, u11
  ent-user       sa
  unhb-slk       link
  rtrv-attr-secu log sa, u31
  inh-slk        link, abc
  rtrv-meas-sched link, abc, def
  act-lbp        link
  act-dlk        link
  act-slk        link
  rtrv-secu log sa, abc, def, ghi
  act-lpo        link
```

```

blk-slk          link, abc, u23, u31
dact-lbp        link
canc-dlk        link
inh-card        sys
canc-lpo        link, u01, u02, u03, u04, u05, u06, u07, u08, u09, u10,
                u11, u12, u13
canc-slk        link
ublk-slk        link, u01, u02, u03, u04, u05, u06, u07, u08, u09, u10,
                u11, u12, u13, u14, u15, u16, u17, u18, u19, u20, u21,
                u22, u23, u24, u25, u26, u27, u28, u29, u30, u31, u32
rept-x25-meas   link
inh-trm         sys, krb
rept-meas       link
.
.
.
.
chg-meas        link
tst-dlk         link, krb
tst-slk         link
;

```

**rtrv-cmdclass**

**Retrieve Command Class**

Use this command to retrieve the name and description of one command class or all command classes.

- Keyword:** rtrv-cmdclass
- Related Commands:** chg-cmdclass
- Command Class:** Basic

**Parameters**

**:class=** (optional)  
 The command class whose name and description are to be retrieved.  
**Range:** *ayyyyy*  
 1 alphabetic character followed by up to 5 alphanumeric characters

**Example**

```

rtrv-cmdclass: class=krb
rtrv-cmdclass

```

**Dependencies**

- The Command Class Management feature must be enabled and turned on before a configurable command class name can be specified in the **class** parameter.
- The LNP feature must be turned on (see the **enable-ctrl-feat** command) before the **class=lnpbas** parameter can be specified.
- The value of the **class** parameter must be a valid configurable or non-configurable command class name.

**Notes**

- The LNP feature must be turned on (see the **enable-ctrl-feat** command) before class LNPBAS will appear in the command output.
- The Command Class Management feature must be enabled and turned on before configurable command classes will appear in the command output.

## Output

In the following examples, the classes u01, u03, u05, and u32 are default configurable command class names. The classes krb and dab are user-assigned configurable command class names; the user changed default configurable command class name u02 to krb and changed default configurable command class name u04 to dab. The descriptions of classes krb and dab were entered with the **descr** parameter when the class names were changed with the **chg-cmdclass** command.

```

rtrv-cmdclass: class=krb
  eagle10404 04-01-22 16:30:56 EST  EAGLE 31.3.0
  class          descr
  krb            my command class description
;

rtrv-cmdclass
  eagle10404 04-01-22 16:30:56 EST  EAGLE 31.3.0
  class          descr
  link          link maintenance commands
  sa            security administration commands
  sys          system maintenance commands
  .
  .
  .
  u01          configurable command class 1
  krb          my command class description
  u03          configurable command class 3
  dab          your command class description
  u05          configurable command class 5
  .
  .
  .
  u32          configurable command class 32
;

```

## rtrv-csl

### Retrieve Common Screening List

Use this command to retrieve all Common Screening List (CSL) entries for a specified feature, a list of screening entries for the specified feature and screening list name, or a specific DS or PC value for a particular feature and screening list name. The Common Screening List commands are used to tailor certain types of general screening information to specific features.

**Keyword:** rtrv-csl

**Related Commands:** dlt-csl, ent-csl, rtrv-csl, rtrv-ctrl-feat

**Command Class:** Database Administration

### Parameters

**NOTE:** See "Point Code Formats and Conversion" for a detailed description of point code formats, rules for specification, and examples.

**:ds=** (optional)

Digit string. This parameter specifies a unique string of digits that is used by the specified screening feature.

**NOTE:** Either the ds parameter or the pc parameter must be specified. Both parameters cannot be specified in the same command.

**Range:** 1-15 digits  
Valid digits are **0-9, a-f, A-F**.



- **trig**—Info Analyzed Relay Base

The **delpfx** list is not supported at this time. This list should only be used by Tekelec personnel.

**:pc=** (optional)

ANSI point code with subfields *network indicator-network cluster-network cluster member (ni-nc-ncm)*.

**Synonym:** **pca**

**Range:** **000-255**

Specify a valid value for each subfield of the point code, and separate the subfields with a dash (-).

When **chg-sid:pctype=ansi** is specified, **ni = 000** is not valid.

When **chg-sid:pctype=ansi** is specified, **nc = 000** is not valid if **ni = 001-005**.

When **chg-sid:pctype=ansi** is specified, **nc = 000** is valid if **ni = 006-255**.

The point code **000-000-000** is not a valid point code.

**:pc/pca/pci/pcn/pcn24=** (optional)

Point code. Either the **ds** or a point code parameter must be specified.

**:pci=** (optional)

ITU international point code with subfields *zone-area-id*.

**Range:** **0-255**

Specify a valid value for each subfield of the point code, and separate the subfields with a dash (-).

The point code **0-000-0** is not a valid point code.

*zone*—**0-7**

*area*—**000-255**

*id*—**0-7**

**:pcn=** (optional)

ITU national destination point code in the format of a 5-digit number (*nnnnn*); or 2, 3, or 4 numbers (members) separated by dashes (*m1-m2-m3-m4*) as defined by the **chg-stpopts:npfnti** flexible point code option. A group code must be specified when the ITUDUPPC feature is turned on (*nnnnn-gc, m1-m2-m3-m4-gc*).

**Range:** **s-, 0-16383, aa-zz**

Specify a valid value for each subfield of the point code, and separate the subfields with a dash (-).

*prefix*—**s-**

*nnnnn*—**0-16383**

*gc*—**aa-zz**

*m1-m2-m3-m4*—**0-14** for each member; values must sum to 14

**:pcn24=** (optional)

24-bit ITU national point code with subfields *main signaling area-sub signaling area-signaling point (msa-ssa-sp)*.

**Range:** **000-255**

Specify a valid value for each subfield of the point code, and separate the subfields with a dash (-).

*msa*—**000-255**



*ssa*—000–255

*sp*—000–255

**:pn=** (optional)

Part Number. The 9-digit "893xxxxxx" part number of the feature for which the command is entered. The **rtrv-ctrl-feat** command description shows the part number in the command output example.

Either the **pn** parameter or the **feature** parameter must be specified to identify the feature.

**Range:** 893000000-893999999

The first 3 digits are **893**. Do not separate the digits with dashes or spaces. The following part numbers are valid for this command:

- **893015501**—IDP Screening for Prepaid
- **893034201**—Info Analyzed Relay Base
- **893016001**—Prepaid IDP Query Relay
- **893016701**—VFLEX

### Example

```
rtrv-csl
```

```
rtrv-csl:feature="Prepaid IDP Query Relay":list=ccnc:ds=456789
```

```
rtrv-csl:feature="Prepaid IDP Query Relay":list=ccnc
```

```
rtrv-csl:feature="IDP Screening for  
Prepaid":list=insl:ds=123456789abcdEF
```

### Dependencies

The value specified for the **feature** parameter must be a valid feature name for a feature that uses a Common Screening List. The feature must be specified as it appears in the **rtrv-ctrl-feat** command output. Enough of the name must be specified to make the name unique when two features begin with the same word or acronym. The specified feature name must be valid for a feature that uses a Common Screening List.

The value specified for the **list** parameter value must be valid for the specified screening feature.

- **skts, insl**—IDP Screening for Prepaid
- **ccndc, gt**—Prepaid IDP Query Relay or Info Analyzed Relay Base
- **skbcsm**—Prepaid IDP Query Relay
- **vmpfx**—VFLEX
- **trig**—Info Analyzed Relay Base

The following parameters are allowed with the indicated common screening list type:

- **list=gt—ds** parameter
- **list=ccndc—ds** parameter
- **list=skbcsm—ds** parameter
- **list=skts—ds** parameter
- **list=insl—ds** parameter
- **list=vmpfx —ds** parameter

- **list=trig** —**ds** parameter

The **pc** and **ds** parameters cannot be specified together in the command.

**Notes**

None

**Output**

Retrieve the specified screening entry for the specified feature and screening list.

**rtrv-csl:feature="Prepaid IDP Query Relay":list=ccnc:ds=456789**

tekelecstp 05-07-12 08:45:21 EST EAGLE 34.1.0

Prepaid IDP Query Relay

CC+NC List

DS

-----

456789

CC+NC List table is (1 of 20) 5% full

;

Retrieve all screening entries for the specified feature and screening list.

**rtrv-csl:feature="Prepaid IDP Query Relay":list=ccnc**

tekelecstp 05-07-12 08:44:50 EST EAGLE 35.0.0

Prepaid IDP Query Relay

CC+NC List

DS

-----

123

456789

754532

CC+NC List table is (3 of 20) 15% full

;

**rtrv-csl:pn=893016701:list=vmpfx**

tekelecstp 07-08-23 17:30:17 EST EAGLE 37.6.0

VFLEX

VM Prefix List

DS

-----

12

123

12345

123456789abcdef

VM Prefix List table is (4 of 100) 4% full

;

**rtrv-csl:feature="Prepaid IDP Query Relay"**

tekelecstp 08-05-12 08:44:50 EST EAGLE 39.0.0

Prepaid IDP Query Relay

CC+NC List

DS

-----

123

456789

754532

CC+NC List table is (3 of 20) 15% full

Prepaid IDP Query Relay

GT List

DS

-----

4567890123abcde

GT List table is (1 of 50) 2% full

```

Prepaid IDP Query Relay
SK+BCSM List
DS
-----
9876543210
1234598765

SK+BCSM List table is (2 of 25) 8% full

```

;

**rtrv-csl**

```

tekelecstp 09-02-21 15:18:41 EST EAGLE 40.1.0
Prepaid IDP Query Relay
SK+BCSM List
DS
-----
3104
3212
4323
5434
6545
7566

SK+BCSM List table is (6 of 25) 24% full

```

```

Prepaid IDP Query Relay
GT List
DS
-----
234
354
678
765
789
987

GT List table is (6 of 50) 12% full

```

```

Prepaid IDP Query Relay
CC+NC List
DS
-----
7848
24574
67547
224723
656354
546535

CC+NC List table is (6 of 20) 30% full

```

```

IDP Screening for Prepaid
SK+TS List
DS
-----
1233
1234

SK+TS List table is (2 of 25) 8% full

```

```

IDP Screening for Prepaid
INSL List
DS

```

```

-----
1233
1235

INSL List table is (3 of 50) 6% full

rtrv-csl:pn=893016001:list=skbcm
tekelecstp 09-06-09 13:29:31 EST EAGLE 41.1.0

Prepaid IDP Query Relay
SK+BCSM List
DS                PT
-----
1234567890        prepaid1
1234567891        prepaid2
1234567892        prepaid3
1234567893        prepaid4
1234567894        prepaid5
1234567895        prepaid6
1234567896        prepaid7

SK+BCSM List ( 7 of 150) 5%

;

Trm(#4) GPSM Enter UI command or 'exit':

```

**rtrv-cspc**

**Retrieve Concerned Signaling Point Code**

Use this command to show one or more lists of concerned signaling point codes that are to be notified when subsystem-prohibited or subsystem-allowed messages are received for an associated mate application.

**Keyword:** rtrv-cspc  
**Related Commands:** dlt-cspc, ent-cspc  
**Command Class:** Database Administration

**Parameters**

**:grp=** (optional)  
 Group name  
**Range:** ayyyyyy  
 1 alphabetic character followed by up to 7 alphanumeric characters  
**Default:** Retrieve all.

**Example**

```

rtrv-cspc
rtrv-cspc:grp=grp01

```

**Dependencies**

If specified, the group name must exist in the database.

**Notes**

If no group parameter is specified, a summary list of group names is displayed with an indication of network type and a percent full indication for each group.

**Output**

When the ANSI-ITU-China SCCP Conversion feature is on, point codes from mixed domains are allowed in a group.

**rtrv-cspc**

```
rlghncxa03w 04-01-07 11:43:02 EST EAGLE 31.3.0
CSPC GRP NETWORK PERCENT FULL
Grp01 ANSI 2%
Grp02 ANSI, ITU, ITU-N24 3%
Grp03 ITU 2%
```

;

When the Spare Point Code Support feature is on, groups can include spare point codes with the **s-** prefix. The ANSI-ITU-China SCCP Conversion feature is on in this example.

**rtrv-cspc:grp=grp02**

```
rlghncxa03w 05-01-07 11:43:02 EST EAGLE 31.12.0
CSPC GRP PC Type
GRP02 001-012-123 A
      001-012-124 A
      7-089-0 I
      s-2-021-4 I
      s-00789 N
```

;

When the ANSI-ITU-China SCCP Conversion feature is not on, point codes from only one domain are allowed in a group.

**rtrv-cspc**

```
rlghncxa03w 04-01-07 11:43:02 EST EAGLE 31.3.0
CSPC GRP NETWORK PERCENT FULL
Grp01 ANSI 2%
Grp03 ITU 2%
```

;

When the Spare Point Code Support feature is on, groups can include spare point codes with the **s-** prefix. The ANSI-ITU-China SCCP Conversion feature is not on in this example.

**rtrv-cspc:grp=groupi**

```
rlghncxa03w 05-01-07 11:43:02 EST EAGLE 31.12.0
CSPC GRP PCI
groupi 7-089-0
      s-2-021-4
```

;

**Legend**

**CSPC PC TABLE IS 15% FULL**—The relative size of the CSPC point code tables.

**CSPC GRP**—The name of the CSPC broadcast group.

**NETWORK**—The network type or types associated with the point code or codes in the group. (When no parameters are specified in the command, only the groups are listed. The **grp** parameter must be specified to list the point codes in the specified group.)

**PERCENT FULL**—The relative size of the CSPC broadcast group.

**PC**—The point codes that make up the CSPC broadcast group.

**TYPE**—The network type of the point code in the group. (The **grp** parameter is specified in the command to list the point codes in the specified group.)

**rtrv-ctrl-feat****Retrieve Controlled Feature**

Use this command to retrieve the status of feature access key controlled features that are purchased and enabled in the system.

**Keyword:** **rtrv-ctrl-feat**

**Related Commands:** **chg-ctrl-feat, enable-ctrl-feat**

**Command Class:** Database Administration

**Parameters**

**:enable=** (optional)

Retrieve controlled features that are enabled with either temporary feature access keys or permanent feature access keys.

**Range:** **temp, perm**

**Default:** Retrieve controlled features for both temporary and permanent feature access keys

**:expired=** (optional)

Retrieve controlled features with expired temporary feature access keys.

**Range:** **yes, no**

**Default:** **no**

**:partnum=** (optional)

The Part Number to retrieve or the command.

**Range:** **893000000 - 893999999**

Do not include dashes in the 9-digit number.

**Default:** Retrieve all controlled features

**:status=** (optional)

Retrieve features with the specified status (On or Off).

**Range:** **on, off**

**Default:** Retrieve features with On and Off status

**Example**

```
rtrv-ctrl-feat
rtrv-ctrl-feat:enable=perm
rtrv-ctrl-feat:partnum= 893005911
```

**Dependencies**

None

**Notes**

When the **enable=perm** parameter is specified, the **expired** parameter value is understood to be **no**.

The product right-to-use features (EAGLE5, EAGLE, and IP<sup>7</sup>) are not mutually exclusive. The hierarchy for product right-to-use features is EAGLE5, then EAGLE, then IP<sup>7</sup>. This means that if the EAGLE5 feature is on, the product is EAGLE5 regardless of the setting of the other product right-to-use features. Some EAGLE 5 ISS features require that a specific product right-to-use feature is enabled and turned on.

For systems being upgraded, the product right-to-use feature for the specific product is turned on. For example, upgrading from an EAGLE 5 ISS release in a system that uses no EAGLE 5 features to a release that uses at least one EAGLE 5 feature causes the EAGLE 5 product right-to-use feature to be enabled and turned on during the conversion.

For new installation, no product right-to-use features are on. The appropriate product right-to-use feature for the highest required product in the hierarchy must be enabled and turned on.



**Output**

The following output examples will differ from the output shown at your terminal and might include features that are not supported in your system. A feature must be purchased before you can enable the feature and turn the feature on. If you are not sure whether you have purchased a feature, contact your Tekelec Sales Representative or Account Representative.

If a Part Number (**partnum** parameter) is entered that belongs to a feature associated with quantity, the output will show which quantity is currently enabled on the system, even if the specified Part Number is for a different quantity. The output will also include the temporary enabled information, if applicable.

**rtrv-ctrl-feat**

```
rlghncxa03w 09-07-09 16:40:40 EST EAGLE 41.1.0
```

The following features have been permanently enabled:

| Feature Name              | Partnum   | Status | Quantity  |
|---------------------------|-----------|--------|-----------|
| HC-MIM SLK Capacity       | 893012707 | on     | 64        |
| Command Class Management  | 893005801 | on     | ----      |
| LNP Short Message Service | 893006601 | on     | ----      |
| Prepaid SMS Intercept Ph1 | 893006701 | on     | ----      |
| Intermed GTT Load Sharing | 893006901 | on     | ----      |
| MNP Circ Route Prevent    | 893007001 | on     | ----      |
| XGTT Table Expansion      | 893006101 | on     | 400000    |
| XMAP Table Expansion      | 893007710 | on     | 3000      |
| Large System # Links      | 893005911 | on     | 2800      |
| Routesets                 | 893006403 | on     | 8000      |
| EAGLE5 Product            | 893007101 | on     | ----      |
| EAGLE Product             | 893007201 | off    | ----      |
| IP7 Product               | 893007301 | off    | ----      |
| Network Security Enhance  | 893009101 | off    | ----      |
| Telnet                    | 893005701 | on     | ----      |
| Port Chk for MO SMS       | 893009301 | on     | ----      |
| SCCP Loop Detection       | 893016501 | off    | ----      |
| LNP ELAP Configuration    | 893010901 | on     | ----      |
| LNP ported TNs            | 893011036 | on     | 384000000 |
| LNP ported LRNs           | 893010501 | on     | 200000    |
| LNP ported NPANXXs        | 893009402 | on     | 350000    |
| 15 Minute Measurements    | 893012101 | off    | ----      |
| EIR                       | 893012301 | on     | ----      |
| EAGLE OA&M IP Security    | 893400001 | off    | ----      |
| SCCP Conversion           | 893012001 | on     | ----      |
| SE-HSL SLK Capacity       | 893013005 | on     | 32        |
| GSM Map Screening (GMS)   | 893013201 | on     | ----      |
| Enhanced GMS (EGMS)       | 893012401 | on     | ----      |
| MTP MAP Screening         | 893013501 | on     | ----      |
| Spare Point Code Support  | 893013601 | on     | ----      |
| GSM MAP SRI Redirect      | 893014001 | on     | ----      |
| ISUP NP with EPAP         | 893013801 | on     | ----      |
| Origin-Based MTP Routing  | 893014201 | on     | ----      |
| ITUN-ANSI SMS Conversion  | 893015301 | on     | ----      |
| Flexible GTT Load-Sharing | 893015401 | on     | ----      |
| 1100 TPS/DSM for ITU NP   | 893018001 | off    | ----      |
| IDP Screening for Prepaid | 893015501 | on     | ----      |
| Prepaid IDP Query Relay   | 893016001 | on     | ----      |
| Origin Based SCCP Routing | 893014301 | on     | ----      |
| GPort SRI Query for PP    | 893017701 | off    | ----      |
| Lrg BICC MSU for IP Sig   | 893018401 | off    | ----      |
| Transaction Based GTT LS  | 893017101 | on     | ----      |
| Weighted GTT Loadsharing  | 893017001 | off    | ----      |
| Hex Digit Support for GTT | 893018501 | on     | ----      |
| SEAS over IP              | 893018801 | on     | ----      |
| E5-SM4G Throughput Cap    | 893019102 | on     | 6800      |

```

HIPR2 High Rate Mode      893020101  on      ----
Circ Route Auto-Recovery  893017601  on      ----
Enhanced Far-End Loopback 893018101  on      ----
Multiple Linkset to APC   893019701  on      ----
Proxy Point Code         893018710  on      100
GPORT                     893017201  on      ----
APORT                     893016601  on      ----
IS41 GSM Migration       893017301  off     ----
MTP Msgs for SCC Apps    893017401  off     ----
INP                       893017901  on      ----
ANSI-41 INP Query       893017801  on      ----
MO-based GSM SMS NP      893019401  on      ----
MO-based IS41 SMS NP     893019501  on      ----
MO SMS B-Party Routing   893024601  on      ----
AMGTT                    893021801  on      ----
MT-Based GSM SMS NP      893020001  on      ----
MT-Based GSM MMS NP     893024101  on      ----
MT-Based IS41 SMS NP    893019901  on      ----
G-Flex MAP Layer Routing 893021701  on      ----
G-Flex                   893021901  on      ----
VFLEX                    893016701  on      ----
ST-HSL-A SLK Capacity    893027304  on      24
IDPR ASD                 893025701  on      ----
IDPR GRN                 893025601  on      ----
TIF ASD                  893024501  on      ----
TIF GRN                  893025501  on      ----
TIF Number Portability   893018901  on      ----
TIF SCS Forwarding      893022201  on      ----
TIF Simple Number Subst. 893024001  on      ----
TCAP Opcode Based Routing 893027801  on      ----
Flex Lset Optnl Based Rtg 893027701  on      ----
MO SMS IS41-to-GSM Migr  893026201  on      ----
ISLSBR                   893026501  on      ----
ITU TCAP LRN QUERY(LRNQT) 893026301  on      ----
ATINP                   893022101  off     ----
IDP A-Party Blacklist    893033201  on      ----
IDP A-Party Routing      893033301  on      ----
IDP Service Key Routing  893033601  on      ----
TIF Number Substitution  893022501  on      ----
MO SMS ASD               893026701  on      ----
MO SMS GRN               893026601  on      ----
GTT LS ARI               893027401  off     ----
INP Circ Route Prevention 893028501  off     ----
TOBR Opcode Quantity     893027901  on      3
VGTT with 16 GTT lengths 893024801  on      ----
6-Way LS on Routesets    893019801  on      ----
Info Analyzed Relay Base 893034201  off     ----
Info Analyzed Relay NP   893026101  off     ----
Info Analyzed Relay ASD  893035001  off     ----
Info Analyzed Relay GRN  893035101  off     ----
MTPRTD GWS Stop Action   893035601  on      ----

```

;

The following features have been temporarily enabled:

| Feature Name           | Partnum   | Status | Quantity | Trial Period Left     |
|------------------------|-----------|--------|----------|-----------------------|
| MNP Circ Route Prevent | 893007001 | On     | ----     | 20 days 8 hrs 57 mins |

The following features have expired temporary keys:

| Feature Name | Part Num | OnOffFeatV |
|--------------|----------|------------|
|--------------|----------|------------|

;

**rtrv-ctrl-feat:enable=perm**

rlghncxa03w 09-07-09 16:40:40 EST EAGLE 41.1.0

The following features have been permanently enabled:

| Feature Name              | Partnum   | Status | Quantity |
|---------------------------|-----------|--------|----------|
| 15 Minute Measurements    | 893012101 | off    | ----     |
| Command Class Management  | 893005801 | on     | ----     |
| EAGLE OA&M IP Security    | 893400001 | off    | ----     |
| EAGLE Product             | 893007201 | on     | ----     |
| EAGLE5 Product            | 893007101 | off    | ----     |
| Enhanced GMS (EGMS)       | 893012401 | on     | ----     |
| MNP Circ Route Prevent    | 893007001 | on     | ----     |
| GSM Map Screening (GMS)   | 893013201 | on     | ----     |
| Intermed GTT Load Sharing | 893006901 | on     | ----     |
| IP7 Product               | 893007301 | on     | ----     |
| Large System # Links      | 893005911 | on     | 2800     |
| LNP ELAP Configuration    | 893010901 | on     | ----     |
| MTP MAP Screening         | 893013501 | on     | ----     |
| Network Security Enhance  | 893009101 | on     | ----     |
| Port Chk for MO SMS       | 893009301 | on     | ----     |
| Prepaid SMS Intercept Phl | 893006701 | on     | ----     |
| Routesets                 | 893006401 | on     | 6000     |
| SCCP Conversion           | 893012001 | on     | ----     |
| SE-HSL SLK Capacity       | 893013005 | on     | 32       |
| Spare Point Code Support  | 893013601 | on     | ----     |
| ITUN-ANSI SMS Conversion  | 893015301 | on     | ----     |
| Flexible GTT Load-Sharing | 893015401 | on     | ----     |
| Telnet                    | 893005701 | on     | ----     |
| XGTT Table Expansion      | 893006101 | on     | 400000   |
| XMAP Table Expansion      | 893007710 | on     | 3000     |
| Origin-Based MTP Routing  | 893014201 | on     | ----     |
| IDP Screening for Prepaid | 893015501 | on     | ----     |
| Origin Based SCCP Routing | 893014301 | on     | ----     |
| Transaction Based GTT LS  | 893017101 | on     | ----     |
| GPort SRI Query for PP    | 893017701 | off    | ----     |
| Lrg BICC MSU for IP Sig   | 893018401 | off    | ----     |
| Hex Digit Support for GTT | 893018501 | on     | ----     |
| E5-SM4G Throughput Cap    | 893019101 | on     | 5000     |
| HIPR2 High Rate Mode      | 893020101 | on     | ----     |
| AMGTT CgPA Upgrade        | 893021803 | on     | ----     |
| MT-Based GSM SMS NP       | 893020001 | on     | ----     |
| MT-Based GSM MMS NP       | 893024101 | on     | ----     |
| MT-Based IS41 SMS NP      | 893019901 | on     | ----     |
| G-Flex MAP Layer Routing  | 893021701 | on     | ----     |
| G-Flex                    | 893021901 | on     | ----     |
| VFLEX                     | 893016701 | on     | ----     |
| ST-HSL-A SLK Capacity     | 893027304 | on     | 24       |
| VFLEX                     | 893016701 | on     | ----     |
| IDPR ASD                  | 893025701 | on     | ----     |
| IDPR GRN                  | 893025601 | on     | ----     |
| TIF ASD                   | 893024501 | on     | ----     |
| TIF GRN                   | 893025501 | on     | ----     |
| MO SMS B-Party Routing    | 893024601 | on     | ----     |
| MO SMS IS41-to-GSM Migr   | 893026201 | on     | ----     |
| ISLSBR                    | 893026501 | on     | ----     |
| TCAP Opcode Based Routing | 893027801 | on     | ----     |
| Flex Lset Optnl Based Rtg | 893027701 | on     | ----     |
| ITU TCAP LRN QUERY(LRNQT) | 893026301 | on     | ----     |
| TIF Number Portability    | 893018901 | on     | ----     |
| TIF SCS Forwarding        | 893022201 | on     | ----     |
| TIF Simple Number Subst.  | 893024001 | on     | ----     |
| IDP A-Party Blacklist     | 893033201 | on     | ----     |
| IDP A-Party Routing       | 893033301 | on     | ----     |
| IDP Service Key Routing   | 893033601 | on     | ----     |
| TIF Number Substitution   | 893022501 | off    | ----     |

```

MO SMS ASD                893026701  on      ----
MO SMS GRN                893026601  on      ----
GTT LS ARI               893027401  off     ----
INP Circ Route Prevention 893028501  on      ----
TOBR Opcode Quantity     893027901  on      3
VGTT with 16 GTT lengths 893024801  on      ----
6-Way LS on Routesets    893019801  on      ----
Info Analyzed Relay Base  893034201  off     ----
Info Analyzed Relay NP    893026101  off     ----
Info Analyzed Relay ASD   893035001  off     ----
Info Analyzed Relay GRN   893035101  off     ----
MTPRTD GWS Stop Action   893035601  on      ----

;

rtrv-ctrl-feat:enable=temp
rlghncxa03w 04-07-29 16:40:40 EST EAGLE 31.6.0
The following features have been temporarily enabled:
Feature Name          Partnum  Status  Quantity  Trial Period Left
MNP Circ Route Prevent 893007001 On      ----    20 days 8 hrs 57 mins

The following features have expired temporary keys:
Feature Name          Part Num
OnOffFeatV           893492401

;

rtrv-ctrl-feat:expired=yes
rlghncxa03w 04-02-29 16:40:40 EST EAGLE 31.3.0
The following features have expired temporary keys:
Feature Name          Part Num
OnOffFeatV           893492401

;

rtrv-ctrl-feat:partnum=893013201
rlghncxa03w 04-07-29 16:40:40 EST EAGLE 31.6.0
The following features have been permanently enabled:
Feature Name          Partnum  Status  Quantity
GSM Map Screening (GSM) 893013201 on      ----

The following features have been temporarily enabled:
Feature Name          Partnum  Status  Quantity  Trial Period Left
Zero entries found.

The following features have expired temporary keys:
Feature Name          Part Num
Zero entries found.

;

```

**rtrv-data-rtddb****Retrieve Data RTDB**

This command retrieves data from the RTDB on an active Service Module card. If the **loc** parameter is specified and the target card is an active Service Module card, the RTDB data is retrieved from that card. If the **loc** parameter is not specified, the data is retrieved on the active Service Module card that has the lowest IMT address. The RTDB status on the active Service Module card can be coherent or incoherent.

For LNP database items (TN) all Service Module cards are queried for the existence of the specified item. Either the Service Module card specified by the **loc** parameter or the Service Module card with the lowest IMT address returns full item information. Any remaining Service Module cards return either COHERENT or INCOHERENT if the item is found in the RTDB on the card.

**Keyword:** rtrv-data-rtddb

**Related Commands:**

**Command Class:** Database Administration

**Parameters****:dn=** (optional)

Dialed Number.

**Range:** 5-15 digits**:entity=** (optional)

Network Entity.

**Range:** 5-15 digits**:entitytype=** (optional)

Entity Type.

**Range:** **sp, rn, vmsid, grn****sp**— Service Provider: Any 10-digit TN**rn**— Routing Number: Any 10-digit TN**vmsid**— Voice Mail Server ID: Any 1-15 digit hexadecimal number**grn**— Generic Routing Number: Any 1-15 digit hexadecimal number**:imei=** (optional)

International Mobile Equipment Identity.

**Range:** 14 digits**:imsi=** (optional)

International Mobile Subscriber Identity.

**Range:** 5-15 digits**:loc=** (optional)

The card location as stenciled on the shelf of the system.

**Range:** **1101-1108, 1111-1117, 1201-1208, 1211-1218, 1301-1308, 1311-1318, 2101-2108, 2111-2118, 2201-2208, 2211-2218, 2301-2308, 2311-2318, 3101-3108, 3111-3118, 3201-3208, 3211-3218, 3301-3308, 3311-3318, 4101-4108, 4111-4118, 4201-4208, 4211-4218, 4301-4308, 4311-4318, 5101-5108, 5111-5118, 5201-5208, 5211-5218, 5301-5308, 5311-5318, 6101-6108, 6111-6118****:lrn=** (optional)

Location Routing Number.

**Range:** 10 digits**:npanxx=** (optional)

Numbering Plan Area.

**Range:** 6 digits**:tn=** (optional)

Telephone Number.

**Range:** 10 digits**Example****rtrv-data-rtdb:tn=9194663133****rtrv-data-rtdb:npanxx=919466****rtrv-data-lrn=9194460000****rtrv-data-rtdb:imsi=12345****rtrv-data-rtdb:dn=12345****rtrv-data-rtdb:entity=abcdefghijklm**

Retrieve DN information from a specific Service Module card.

```
rtrv-data-rtdb:dn=19195554444:loc=1107
```

Retrieve entity data from a specific Service Module card.

```
rtrv-data-rtdb:entity=12345:loc=1107
```

### Dependencies

The specified card location must be equipped in the database.

At least one of the following parameters must be specified: **imsi**, **dn**, **entity**, **imei**, **entitytype**, **npanxx**, **lrn**, **tn**.

Only one of the **tn**, **lrn**, or **npanxx** parameters can be specified in the command.

If the **npanxx**, **lrn**, or **tn** parameter is specified, the LNP ELAP Configuration feature must be on.

If the AINPQ, EIR, G-Flex, G-Port, INP, Prepaid IDP Relay Query, Prepaid SMS Intercept Ph1 (PPSMS), or V-Flex feature is turned on, or the ATINP feature is enabled, then the **imsi**, **dn**, **entity**, **imei**, or **entitytype** parameter must be specified.

If the **imsi** parameter is specified, then the G-Flex feature or the EIR feature must be turned on.

The G-Flex, G-Port, or V-Flex feature must be turned on, or the ATINP feature must be enabled before the **entity** parameter can be specified.

If the **entitytype** parameter is specified, the **entity** parameter must be specified.

If the **imei** parameter is specified, the EIR feature must be turned on.

The destination specified by the **loc** parameter must correspond to a Service Module card running the **vsccp** application.

The destination specified by the **loc** parameter must correspond to a Service Module card that is IS-NR.

A primary Service Module card must be provisioned.

The G-Flex, G-Port, INP, Prepaid SMS Intercept Ph1, or V-Flex feature must be turned on, or the ATINP feature must be enabled before the **dn** parameter can be specified.

The card location slot must be between **1** and **16** and not **9** or **10**. The frame location must be **1xxx**, **2xxx**, **3xxx**, **4xxx**, **5xxx**, **6xxx**. The shelf location must be **11xx**, **12xx**, **13xx**, **21xx**, **22xx**, **23xx**, **31xx**, **32xx**, **33xx**, **41xx**, **42xx**, **43xx**, **51xx**, **52xx**, **53xx**, or **61xx**.

### Notes

For DN and DN Block entries, whichever entity is provisioned in the order of SP/RN, VMSID, GRN, will become EntIdx1.

Output

**NOTE: A value of "---" in the TT column indicates that the service does not have a translation type defined in the EAGLE 5 ISS and that call processing will ignore the override data displayed.**

Retrieve LRN Data.

**rtrv-data-rtdb:lrn=1111111111**

tekelecstp 09-08-30 15:23:45 EST EAGLE 41.1.0

Card Loc : 1103 Status:Coherent  
 Card Loc: 1103  
 LRN SP  
 1111111111 tklc

| SERV  | TT | XLAT   | RI  | PCA         | SSN | NGT | RGTA |
|-------|----|--------|-----|-------------|-----|-----|------|
| CLASS | 10 | DPCSSN | GT  | 002-002-002 | 2   | --- | yes  |
| WSMSC | 11 | DPCSSN | SSN | 010-010-010 | 10  | --- | no   |

;

Retrieve NPANXX Data.

**rtrv-data-rtdb:npanxx=919225**

tekelecstp 09-08-30 15:37:36 EST EAGLE 41.1.0

Card Loc : 1103 Status:Coherent  
 Card Loc: 1103

| SERV  | TT  | XLAT   | RI  | PCA         | SSN | NGT | RGTA |
|-------|-----|--------|-----|-------------|-----|-----|------|
| AIN   | --- | DPC    | GT  | -----       | --- | --- | no   |
| IN    | --- | DPC    | GT  | -----       | --- | --- | no   |
| CLASS | 10  | DPCSSN | SSN | 007-007-007 | 7   | --- | no   |

;

Retrieve TN Data.

**rtrv-data-rtdb:tn=9192252645**

tekelecstp 09-08-30 15:38:56 EST EAGLE 41.1.0

Card Loc : 1103 Status:Coherent  
 Card Loc: 1103

| SERV | TT  | XLAT   | RI  | PCA         | SSN | NGT | RGTA |
|------|-----|--------|-----|-------------|-----|-----|------|
| LIDB | --- | DPCSSN | SSN | 003-003-003 | 3   | --- | no   |
| ISVM | --- | DPCSSN | SSN | 004-004-004 | 4   | --- | no   |

;

Retrieve IMSI Data

**rtrv-data-rtdb:imsi=12345**

tekelecstp 08-05-11 07:55:28 EST EAGLE5 39.0.0

Card Loc : 1105 Status : Coherent

| IMSI  | EntIdx     | IMEI Index |
|-------|------------|------------|
| 12345 | H'00000002 | H'00000006 |

| Entity Address  | Type | PC(NATL-gg) | RI | SSN | TT  | NP  | NAI | DA         |
|-----------------|------|-------------|----|-----|-----|-----|-----|------------|
| abcdef123456abc | SP   | 02000       |    | SSN | 122 | 000 | 00  | 000 prefix |

| SRFIMSI         | NSSN | CCGT | NTT | NNP | NNAI |
|-----------------|------|------|-----|-----|------|
| 1234567890abcde | yes  | no   | no  | no  | no   |

```

IMEI          VERSION  BLACK  GRAY  WHITE
12345678901234      0    yes   yes   yes
;

Retrieve Entity Data

rtrv-data-rtdb:entity=abcdef123456abc
tekelecstp 09-08-30 07:53:00 EST  EAGLE5 41.1.0

INFO: Default value of Entity Type is : SP
;

tekelecstp 06-03-30 07:53:00 EST  EAGLE5 35.0.0

Card Loc      : 1105    Status : Coherent

Entity Address  Type PC(NATL-gg) RI  SSN TT  NP NAI DA      SRFIMSI
abcdef123456abc SP   02000          SSN 122 000 00 000 prefix 1234567890abcde

NSSN  CCGT  NTT  NNP  NNAI
yes   no   no   no   no
;

Retrieve IMEI Data

rtrv-data-rtdb:imei=12345678abcdef
tekelecstp 06-03-30 07:54:55 EST  EAGLE5 35.0.0

Card Loc      : 1105    Status : Coherent

IMEI          VERSION  BLACK  GRAY  WHITE
12345678abcdef      0    yes   no   yes
;

Retrieve data for a DN associated with two NEs.

rtrv-data-rtdb:dn=1111111111111111
tekelecstp 08-08-11 07:56:48 EST  EAGLE5 39.1.0

Card Loc      : 1103    Status:Coherent
DN            Portability Type (255)
1111111111111111  No portability type

EntIdx1      EntIdx2
H'00000007   H'00000005

Entity Address  Type          PC(INTL  ) RI  SSN TT  NP NAI DA
bcda4321       RN            5-005-5  GT  000 000 00 000 none

SRFIMSI        NSSN  CCGT  NTT  NNP  NNAI
no             no   no   no   no   no

Entity Address  Type          PC(ANSI  ) RI  SSN TT  NP NAI DA
abcd1234       VMSID  ----- GT  000 000 00 000 none

SRFIMSI        NSSN  CCGT  NTT  NNP  NNAI
no             no   no   no   no   no

ASD Address: 1234567890
;

```



Retrieve DN data from a specific Service Module card.

**rtrv-data-rtdb:dn=19195554444:loc=1107**

tekelecstp 08-08-26 14:03:15 EST EAGLE5 39.1.0

Card Loc : 1107 Status:Coherent  
 DN Portability Type ( 1) Entity Index  
 19195554444 Own Number ported out H'0000513d

Entity Address Type PC(ANSI ) RI SSN TT NP NAI DA  
 1234 RN ----- GT 000 000 00 000 none

SRFIMSI NSSN CCGT NTT NNP NNAI  
 no no no no no

ASD Address: 1234567890

;

Retrieve DN data associated with one NE.

**rtrv-data-rtdb:dn=12345**

tekelecstp 08-08-18 07:56:48 EST EAGLE5 39.1.0

Card Loc : 1101 Status:Coherent  
 DN Portability Type (255)  
 12345 No portability type

EntIdx1 EntIdx2  
 -----

ASD Address: 1234567890

;

Retrieve DN data when the data is non-portcd.

**rtrv-data-rtdb:dn=d1000**

tklcl090203 08-10-20 10:57:33 EST EAGLE 40.0.0

Card Loc : 1215 Status:Coherent  
 DN Portability Type ( 36)  
 d1000 Not Identified to be portcd

EntIdx1 EntIdx2  
 -----

ASD Address: abcd0

;

Retrieve data for a DN associated with one NE, one ASD and one NS.

**rtrv-data-rtdb:dn=2324567893**

tekelecstp 09-04-11 07:56:48 EST EAGLE5 41.0.0

Card Loc : 1103 Status:Coherent  
 DN Portability Type (255) Category  
 2324567893 No portability type Private

EntIdx  
 H'00000007

Entity Address Type PC(INTL ) RI SSN TT NP NAI DA  
 bcda4321 RN 5-005-5 GT 000 000 00 000 none

SRFIMSI NSSN CCGT NTT NNP NNAI

no no no no no

ASD Address: 1234567890

NS Address 2312457895 NS Category Public

Retrieve data for a non-ported DN associated with one ASD and one NS

rtrv-data-rtdb:dn=1347823456

tekelecstp 09-04-11 07:56:48 EST EAGLE5 41.0.0

Card Loc : 1105 Status:Coherent
DN Portability Type ( 36) Category
1347823456 Not Identified to be ported Public

EntIdx
-----

ASD Address: 1234545367

NS Address 1345692324 NS Category Private

Retrieve data for a DN that is located in a non-ranged entry and is listed as an A-Party Blacklisted private number.

rtrv-data-rtdb:dn=123456

tekelecstp 09-06-18 07:56:48 EST EAGLE5 41.1.0

Card Loc : 1101 Status:Coherent
DN Portability Type (255) Category
123456 No portability type Private
A-Pty Blk

Retrieve data for a DN that is located in a ranged entry and is listed as an A-Party Blacklisted public number.

rtrv-data-rtdb:dn=123456

tekelecstp 09-06-18 07:56:48 EST EAGLE5 41.1.0

Card Loc : 1101 Status:Coherent
BEG DNBLK END DNBLK Portability Type (255) Category
112233 4455667 No portability type Public
A-Pty Blk

Retrieve NPANXX split data.

rtrv-data-rtdb:npanxx=919111

tekelecstp 09-08-30 15:37:36 EST EAGLE 41.1.0

Card Loc : 1103 Status:Coherent
Card Loc: 1103
NPANXX MR LRN
OLD 919111 yes no LA LI
NEW 918111 yes yes LA LI

Default Data
SERV TT XLAT RI PCA SSN NGT RGTA
LIDB --- DPC GT 001-001-001 --- --- no

**Legend**

**CARD LOC**—Location of the card that contains the retrieved information.

**STATUS**—RTDB database status; Coherent or Incoherent.

**IMSI**—International Mobile Subscriber Identity.

**ENTIDX, ENTIDX1, ENTIDX2**—The hexadecimal index at which the Network Entity data is stored in the Entity Bucket on the Service Module card.

**IMEI INDEX**—The hexadecimal index at which the IMEI data is stored in the IMEI Bucket on the Service Module card.

**ENTITY ADDRESS**—Hexadecimal Network Entity address.

**Type**—Network Entity type; Service Provider (SP), Routing Number (RN), Voice Mail Server ID (VMSID) or Generic Routing Number (GRN).

**PC** (*type of PC*)—Point code and type of point code (ANSI; NATL - ITU National with or without group code (-gg)).

**RI**—Routing Indicator

**SSN**—Subsystem Number.

**TT**—Translation Type.

**NP**—Numbering Plan

**DA**—Digits action (Prefix, Suffix, or none)

**SRFIMSI**—Signaling Relay Function IMSI

**IMSI**—International Mobile Subscriber Identity.

**NSSN**—New Subsystem Number (yes or no)

**CCGT**—Cancel GT (yes or no)

**NTT**—New Translation Type

**NNP**—New Numbering Plan

**NNAI**—New Nature of Address Indicator.

**IMEI**—International Mobile Equipment Identity.

**VERSION**—IMEI data version.

**BLACK, WHITE, GRAY**—Equipment Identity Register search lists.

**DN**—Dialed Number.

**ASD ADDRESS**—Additional Subscriber Data address

**PORTABILITY TYPE** (*number*)—

- 0—Not known to be ported
- 1—Own number ported out
- 2—Foreign number ported to Foreign network
- 3—Prepaid Short Message Service (PPSMS) subscriber on server #1
- 4—Prepaid Short Message Service (PPSMS) subscriber on server #2
- 5—IS41 to GSM migrated subscriber with only GSM handset active
- 6—Prepaid Short Message Service (PPSMS) subscriber on server #3
- 7—Prepaid Short Message Service (PPSMS) subscriber on server #4

- 8—Prepaid Short Message Service (PPSMS) subscriber on server #5
- 9—Prepaid Short Message Service (PPSMS) subscriber on server #6
- 10—Prepaid Short Message Service (PPSMS) subscriber on server #7
- 11—Prepaid Short Message Service (PPSMS) subscriber on server #8
- 12—Prepaid Short Message Service (PPSMS) subscriber on server #9
- 13—Prepaid Short Message Service (PPSMS) subscriber on server #10
- 14—Prepaid Short Message Service (PPSMS) subscriber on server #11
- 15—Prepaid Short Message Service (PPSMS) subscriber on server #12
- 16—Prepaid Short Message Service (PPSMS) subscriber on server #13
- 17—Prepaid Short Message Service (PPSMS) subscriber on server #14
- 18—Prepaid Short Message Service (PPSMS) subscriber on server #15
- 19—Prepaid Short Message Service (PPSMS) subscriber on server #16
- 20—Prepaid Short Message Service (PPSMS) subscriber on server #17
- 21—Prepaid Short Message Service (PPSMS) subscriber on server #18
- 22—Prepaid Short Message Service (PPSMS) subscriber on server #19
- 23—Prepaid Short Message Service (PPSMS) subscriber on server #20
- 24—Prepaid Short Message Service (PPSMS) subscriber on server #21
- 25—Prepaid Short Message Service (PPSMS) subscriber on server #22
- 26—Prepaid Short Message Service (PPSMS) subscriber on server #23
- 27—Prepaid Short Message Service (PPSMS) subscriber on server #24
- 28—Prepaid Short Message Service (PPSMS) subscriber on server #25
- 29—Prepaid Short Message Service (PPSMS) subscriber on server #26
- 30—Prepaid Short Message Service (PPSMS) subscriber on server #27
- 31—Prepaid Short Message Service (PPSMS) subscriber on server #28
- 32—Prepaid Short Message Service (PPSMS) subscriber on server #29
- 33—Prepaid Short Message Service (PPSMS) subscriber on server #30
- 34—Prepaid Short Message Service (PPSMS) subscriber on server #31
- 35—Prepaid Short Message Service (PPSMS) subscriber on server #32
- 36—Not Identified to be ported
- 255—No portability type

**NS ADDRESS**—Address of the associated DN, used for Number Substitution

**NS CATEGORY**—Category of the associated DN, used for Number Substitution

**NPA**—Number Planning Area (Area Code)

**NXX**—Exchange Code

## rtrv-dlk

## Retrieve Data Link

Use this command to show the parameters of a TCP/IP data link.

**Keyword:** rtrv-dlk

**Related Commands:** act-dlk, canc-dlk, dlt-dlk, ent-dlk, rept-stat-dlk, tst-dlk

**Command Class:** Database Administration

### Parameters

**:ipaddr=** (optional)

The TCP/IP data link's IP address. This is a TCP/IP address expressed in standard dot notation. IP addresses consist of the system's network number and the machine's unique host number. An example IP address is **192.126.100.5**, where **192.126.100** is the network number and **5** is the machine's host number.

**Range:** 1-223, 0-255

4 numbers separated by dots

1-223—first number

0-255—the other three numbers

**Default:** Display all.

**:loc=** (optional)

The card location as stenciled on the shelf of the system.

**Range:** 1101-1108, 1111-1112, 1201-1208, 1211-1218, 1301-1308, 1311-1318, 2101-2108, 2111-2118, 2201-2208, 2211-2218, 2301-2308, 2311-2318, 3101-3108, 3111-3118, 3201-3208, 3211-3218, 3301-3308, 3311-3318, 4101-4108, 4111-4118, 4201-4208, 4211-4218, 4301-4308, 4311-4318, 5101-5108, 5111-5118, 5201-5208, 5211-5218, 5301-5308, 5311-5318, 6101-6108, 6111-6118

**Default:** All TCP/IP data links are shown.

### Example

```
rtrv-dlk
```

```
rtrv-dlk:loc=1201
```

```
rtrv-dlk:ipaddr=193.4.201.34
```

### Dependencies

This command can be entered with no parameters or with one of the optional parameters **loc** or **ipaddr**; however, both **loc** and **ipaddr** cannot be specified in the same command.

The shelf and card must be equipped.

The specified card must have a TCP/IP data link assigned to it.

If the **ipaddr** parameter is specified, the IP address must be assigned to a TCP/IP data link.

### Notes

None

**Output**

In the following example, cards at location 1201 and 1203 are ENET cards running the **stplan** application. For these cards, the value of the auto parameter is defaulted to no, and the value of the duplex parameter is defaulted to half.

The cards at location 1101, 1103 and 1107 are DCM or E5-ENET cards running the **stplan** application. For these cards, if the **auto=yes** parameter is specified, then the values of **speed** and **duplex** parameters are not shown.

**rtrv-dlk**

```
tekelecstp 07-02-06 11:12:47 EST EAGLE 37.0.0
LOC  IPADDR          LINK SPEED  DUPLEX  AUTO
1101 192.168.63.34   100Mbit FULL    NO
1103 192.168.63.11   10Mbit  HALF    NO
1107 192.168.63.12   ----- ----    YES
1201 192.168.63.13   10Mbit  HALF    NO
1203 192.168.63.14   10Mbit  HALF    NO
```

;

**rtrv-dlk:loc=1101**

```
tekelecstp 07-02-01 14:09:13 EST EAGLE 37.0.0
LOC  IPADDR          LINK SPEED  DUPLEX  AUTO
1101 192.168.63.34   100Mbit FULL    NO
```

;

**rtrv-dlk:ipaddr=192.168.63.11**

```
tekelecstp 07-02-01 14:19:14 EST EAGLE 37.0.0
LOC  IPADDR          LINK SPEED  DUPLEX  AUTO
1103 192.168.63.11   10Mbit  HALF    NO
```

;

In the following example, the specified IP address is not assigned to a TCP/IP data link.

**rtrv-dlk:ipaddr=193.4.201.28**

```
tekelecstp 07-02-01 14:19:14 EST EAGLE 37.0.0
LOC  IPADDR          LINK SPEED  DUPLEX  AUTO
IPADDR not assigned to a TCP/IP Link.
```

;

In the following example, there are no TCP/IP data links in the database.

**rtrv-dlk**

```
tekelecstp 07-02-02 14:19:14 EST EAGLE 37.0.0
LOC  IPADDR          LINK SPEED  DUPLEX  AUTO
No TCP/IP Links are defined in the database.
```

;

In the following example, the specified IP address is assigned to a TCP/IP node instead of a TCP/IP data link.

**rtrv-dlk:ipaddr=193.4.201.63**

```
tekelecstp 07-02-01 12:12:10 EST EAGLE 37.0.0
LOC  IPADDR          LINK SPEED  DUPLEX  AUTO
IPADDR assigned to a TCP/IP Node.
```

;

**Legend**

**IPADDR**—The IP address associated with the interface on the data link.

**LOC**—The card location containing the data link.

**LINK SPEED**—The bandwidth for the interface in megabits per second, **10** or **100**.

**AUTO**—Whether or not to automatically determine duplex and speed. If the value is **yes**, then duplex and speed are automatically determined. If the value is **no**, then duplex and speed are not automatically determined.

**DUPLEX**—The mode of operation of the interface. Possible values are **half** and **full**.

## rtrv-dstn

## Retrieve Destination

Use this command to show the destination point code entries in the Destination point code table.

**Keyword:** rtrv-dstn

**Related Commands:** chg-dstn,, dlt-dstn, dlt-rte, ent-dstn, ent-rte, rept-stat-dstn, rept-stat-rte, rtrv-rte

**Command Class:** Database Administration

### Parameters

**NOTE:** See "Point Code Formats and Conversion" for a detailed description of point code formats, rules for specification, and examples.

**:aliasa=** (optional)

ANSI alias point code with subfields *network indicator-network cluster-network cluster member (ni-nc-ncm)*.

**Range:** 000-255, \*

Specify a valid value for each subfield of the point code, and separate the subfields with a dash (-).

The asterisk (\*) value is not valid for the *ni* subfield.

When **chg-sid:pctype=ansi** is specified, *ni* = 000 is not valid.

When **chg-sid:pctype=ansi** is specified, *nc* = 000 is not valid if *ni* = 001–005.

When **chg-sid:pctype=ansi** is specified, *nc* = 000 is valid if *ni* = 006–255.

When **chg-sid:pctype=ansi** is specified, *ni*-\*-\* is valid if *ni* = 006–255.

The point code 000-000-000 is not a valid point code.

**:aliasa/aliasi/aliasn/aliasn24=** (optional)

Alias point code.

**:aliasi=** (optional)

ITU international alias point code with subfields *zone-area-id*. The *prefix* subfield indicates a spare point code (*prefix-zone-area-id*). If this parameter is specified with an ITU international destination (**dpci**) point code, the prefix subfields cannot be the same, i.e. both spare or both non-spare.

If an ITU international destination (**dpci**) point code is entered, then the **dpci** and **aliasi** *prefix* subfields cannot be the same, (both spare or both non-spare). Up to 2 comma-delimited entries can be entered in the point code list.

**Range:** s-, 0-255

Specify a valid value for each subfield of the point code, and separate the subfields with a dash (-).

*prefix*—s-

*zone*—0-7

*area*—000-255

*id*—0-7

The point code 0-000-0 is not a valid point code.

**:aliasn=** (optional)

ITU national alias point code in the format of a 5-digit number (*nnnnn*); or 2, 3, or 4 numbers (members) separated by dashes (*m1-m2-m3-m4*) as defined by the **chg-stpopts:npcfmti** flexible point code option. A group code must be specified when the ITUDUPPC feature is turned on (*nnnnn-gc*, *m1-m2-m3-m4-gc*). The *prefix* subfield indicates a spare point code (*prefix-nnnnn*, *prefix-nnnnn-gc*, *prefix-m1-m2-m3-m4*, *prefix-m1-m2-m3-m4-gc*). If this parameter is specified with an ITU national destination (**dpcn**) point code, the prefix subfields cannot be the same, i.e. both spare or both non-spare.

If an ITU national destination (**dpcn**) point code is entered, then the **dpcn** and **aliasn** *prefix* subfields cannot be the same, (both spare or both non-spare). Up to 2 comma-delimited entries can be entered in the point code list.

**Range:** **s-, 0-16383, aa-zz**

Specify a valid value for each subfield of the point code, and separate the subfields with a dash (-).

*prefix*—**s-**

*nnnnn*—**0-16383**

*gc*—**aa-zz**

*m1-m2-m3-m4*—**0-14** for each member; values must sum to 14

**:aliasn24=** (optional)

24-bit ITU national destination point code with subfields *main signaling area-sub signaling area-signaling point* (*msa-ssa-sp*).

**Range:** **000-255**

Specify a valid value for each subfield of the point code, and separate the subfields with a dash (-).

*msa*—**000-255**

*ssa*—**000-255**

*sp*—**000-255**

**:cli=** (optional)

Common Language Location Identifier. This parameter specifies the Common Language Location Identifier assigned to the link.

**Range:** *ayyyyyyyyyy*

1 alphabetic character followed by 10 alphanumeric characters

**Default:** **none**

**:dpc=** (optional)

ANSI destination point code with subfields *network indicator-network cluster-network cluster member* (*ni-nc-ncm*). The *prefix* subfield indicates a private point code (*prefix-ni-nc-ncm*).

**Synonym:** **dpca**

**Range:** **p-, 000-255, \*, \*\*, \*\*\***

Specify a valid value for each subfield of the point code, and separate the subfields with a dash (-).

*prefix*—**p-**

The asterisk values **\***, **\*\***, and **\*\*\*** are not valid for the *ni* subfield.

If **\*\*** or **\*\*\*** is specified for the *nc* subfield, either **\***, **\*\***, or **\*\*\*** must be specified for the *ncm* subfield.

When **chg-sid:pctype=ansi** is specified, *ni* = **000** is not valid.

When **chg-sid:pctype=ansi** is specified, *nc* = **000** is not valid if *ni* = **001-005**.

When **chg-sid:pctype=ansi** is specified, *nc* = **000** is valid if *ni* = **006-255**.



When **chg-sid:pctype=ansi** is specified, *ni*-\*-\* is valid if *ni* = **006-255**.

The point code **000-000-000** is not a valid point code.

**:dpc/dpca/dpci/dpcn/dpcn24=** (optional)

Destination point code.

**:dpci=** (optional)

ITU international destination point code with subfields *zone-area-id*. The *prefix* subfield indicates a spare point code, private point code, or private and spare point code (*prefix-zone-area-id*).

**Range:** **s-, p-, ps-, 0-255**

Specify a valid value for each subfield of the point code, and separate the subfields with a dash (-).

*prefix*—**s-, p-, ps-**

*zone*—**0-7**

*area*—**000-255**

*id*—**0-7**

The point code **0-000-0** is not a valid point code.

**:dpcn=** (optional)

ITU national destination point code in the format of a 5-digit number (*nnnnn*); or 2, 3, or 4 numbers (members) separated by dashes (*m1-m2-m3-m4*) as defined by the **chg-stpopts:npcfnti** flexible point code option. A group code must be specified when the ITUDUPPC feature is turned on (*nnnnn-gc*, *m1-m2-m3-m4-gc*). The *prefix* subfield indicates a spare point code, private point code, or private and spare point code (*prefix-nnnnn*, *prefix-nnnnn-gc*, *prefix-m1-m2-m3-m4*, *prefix-m1-m2-m3-m4-gc*).

**Range:** **s-, p-, ps-, 0-16383, aa-zz, \***

Specify a valid value for each subfield of the point code, and separate the subfields with a dash (-).

An asterisk (\*) can be specified for the node (*nnnnn* or every member of a flexible point code) or for the group code (*gc*) only when group codes are present in the point codes.

An asterisk (\*) can be specified either for the node or for the group code, but not both.

*prefix*—**s-, p-, ps-**

*nnnnn*—**0-16383, \***

*gc*—**aa-zz, \***

*m1-m2-m3-m4*—**0-14** for each member; values must sum to 14; or **\*-\*-\*** when the point code includes a group code.

**:dpcn24=** (optional)

24-bit ITU national destination point code with subfields *main signaling area-sub signaling area-signaling point* (*msa-ssa-sp*). The *prefix* subfield indicates a private point code (*prefix-msa-ssa-sp*).

**Range:** **p-, 000-255**

Specify a valid value for each subfield of the point code, and separate the subfields with a dash (-).

*prefix*—**p-**

*msa*—**000-255**

*ssa*—**000-255**

*sp*—**000-255**

**:homescp=** (optional)

This parameter displays all destination point codes (DPCs) that have the internal Home SCP flag set to the specified value.

**Range:** **yes, no**

**yes**— the DPC is considered a Home SCP for messages with no Global Title Address Digits

**no**— the DPC is not considered a Home SCP for messages with no Global Title Address Digits

**:homesmsc=** (optional)

This parameter displays all destination point codes (DPCs) that have the internal Home SMSC flag set to the specified value.

**Range:** **yes, no**

**yes**— the DPC is considered a Home SMSC for messages with no Global Title Address Digits

**no**— the DPC is not considered a Home SMSC for messages with no Global Title Address Digits

**:msar=** (optional)

Memory space accounting report. When the NRT feature or the CRMD feature, or both, is turned on, this parameter specifies whether summary or detail destination table memory space accounting information is displayed. The **summary** report or the **detail** report appears following the destination information that is requested by entering the command with or without other parameters. The **only** parameter value displays a detail destination table memory space accounting report without any other destination information. If neither feature is on, only the summary report information is displayed; the detail report information cannot be displayed.

**Range:** **detail, only, summary**

**Default:** **detail**—if **rtrv-dstn** is entered with no parameters

**summary**—if **rtrv-dstn** is entered with parameters

**:ncai=** (optional)

Nested cluster allowed indicator. This parameter specifies whether the route to the cluster point code can be different for provisioned members of the cluster and whether clusters with nested cluster point codes (**ncai=yes**), or clusters that do not allow nested cluster point codes (**ncai=no**) are displayed.

**Range:** **yes, no**

**yes**— Display clusters with the **ncai** set to **yes**

**no**— Display clusters with the **ncai** set to **no**

**:nprst=** (optional)

NM bits reset. This parameter displays all entries with the specified value of the **nprst** option.

**Range:** **off, on**

**off**— Display all entries with an **nprst** parameter value of **off**.

**on**— Display all entries with an **nprst** parameter value of **on**.

**:pcst=** (optional)

Point code subtype. If selected, this parameter causes the command to display only point codes with no subtype prefix or only point codes of a specified subtype.

**Range:** **none, p, ps, s**

**none**— Display only point codes without subtype prefixes

**p**— Display only private point codes (subtype prefix **p-**)

**ps**— Display only private and spare point codes (subtype prefix **ps-**)

**s**— Display only spare point codes (subtype prefix **s-**)

**:pctype=** (optional)

Point code domain. This parameter causes the command to display only the point codes of the specified domain type.

**Range:** **ansi, itui, itun, itun24**

**ansi**— Display only ANSI point codes

**itui**— Display only ITU International point codes

**itun**— Display only ITU National point codes

**itun24**— Display only 24-bit ITU National point codes

**:ppc=** (optional)

ANSI proxy point code with subfields *network indicator-network cluster-network cluster member (ni-nc-ncm)*.

The proxy point code must be a full point code.

**Range:** **000-255**

Specify a valid value for each subfield of the point code, and separate the subfields with a dash (-).

When **chg-sid:pctype=ansi** is specified, *ni = 000* is not valid.

When **chg-sid:pctype=ansi** is specified, *nc = 000* is not valid if *ni = 001-005*.

When **chg-sid:pctype=ansi** is specified, *nc = 000* is valid if *ni = 006-255*.

The point code **000-000-000** is not a valid point code.

**:ppc/ppca/ppci/ppcn/ppcn24=** (optional)

Proxy Point Code.

The proxy point code must be a full point code.

**:ppci=** (optional)

ITU international proxy point code with subfields *zone-area-id*. The prefix subfield indicates a spare point code (*prefix-zone-area-id*).

**Range:** **s-, 0-255**

Specify a valid value for each subfield of the point code, and separate the subfields with a dash (-).

*prefix*—**s-**

*zone*—**0-7**

*area*—**000-255**

*id*—**0-7**

The point code **0-000-0** is not a valid point code.

**:ppcn=** (optional)

ITU national proxy point code in the format of a 5-digit number (*nnnnn*); or 2, 3, or 4 numbers (*members*) separated by dashes (*m1-m2-m3-m4*) as defined by the **chg-stpopts:npcfmti** flexible point code option. A group code must be specified when the ITUDUPPC feature is turned on (*nnnnn-gc*, *m1-m2-m3-m4-gc*). The prefix subfield indicates a spare point code (*prefix-nnnnn*, *prefix-nnnnn-gc*, *prefix-m1-m2-m3-m4*, *prefix-m1-m2-m3-m4-gc*).

**Range:** **s-, 0-16383, aa-zz**

Specify a valid value for each subfield of the point code, and separate the subfields with a dash (-).

*prefix*—**s-**

*nnnnn*—**0-16383**

*gc*—**aa-zz**

*m1-m2-m3-m4*—**0-14** for each member; values must sum to 14

**:ppcn24=** (optional)

24-bit ITU national point code with subfields *main signaling area-sub signaling area-signaling point (msa-ssa-sp)*.

**Range:** **000-255**

Specify a valid value for each subfield of the point code, and separate the subfields with a dash (-).

*msa*—**000-255**

*ssa*—**000-255**

*sp*—**000-255**

**:prx=** (optional)

Proxy point code indicator.

**Range:** **yes, no**

**yes** — Will be used as a proxy point code

**no** — Will not be used a proxy point code.

**:spc=** (optional)

ANSI secondary point code with subfields *network indicator-network cluster-network cluster member (ni-nc-ncm)*. The *prefix* subfield indicates a private point code (*prefix-ni-nc-ncm*).

**Synonym:** **spca**

**Range:** **p-, 000-255**

Specify a valid value for each subfield of the point code, and separate the subfields with a dash (-).

*prefix*—**p-**

When **chg-sid:pctype=ansi** is specified, *ni* = **000** is not valid.

When **chg-sid:pctype=ansi** is specified, *nc* = **000** is not valid if *ni* = **001-005**.

When **chg-sid:pctype=ansi** is specified, *nc* = **000** is valid if *ni* = **006-255**.

The point code **000-000-000** is not a valid point code.

**:spc/spca/spci/spcn/spcn24=** (optional)

Secondary point code.

**:spci=** (optional)

ITU international secondary point code with subfields *zone-area-id*. The *prefix* subfield indicates a spare point code, private point code, or private and spare point code (*prefix-zone-area-id*).

**Range:** **s-, p-, ps-, 0-255**

Specify a valid value for each subfield of the point code, and separate the subfields with a dash (-).

*prefix*—**s-, p-, ps-**

*zone*—**0-7**

*area*—**000-255**

*id*—**0-7**

The point code **0-000-0** is not a valid point code.

**:spcn=** (optional)

ITU national secondary point code in the format of a 5-digit number (*nnnnn*); or 2, 3, or 4 numbers (members) separated by dashes (*m1-m2-m3-m4*) as defined by the **chg-stpopts:npcfmti** flexible point code option. A group code must be specified when the ITUDUPPC feature is turned on (*nnnnn-gc*, *m1-m2-m3-m4-gc*). The *prefix* subfield indicates a spare point code, private point code, or private

and spare point code (*prefix-nnnnn*, *prefix-nnnnn-gc*, *prefix-m1-m2-m3-m4*, *prefix-m1-m2-m3-m4-gc*).

**Range:** **s-, p-, ps-, 0-16383, aa-zz**

Specify a valid value for each subfield of the point code, and separate the subfields with a dash (-).

*prefix*—**s-, p-, ps-**

*nnnnn*—**0-16383**

*gc*—**aa-zz**

*m1-m2-m3-m4*—**0-14** for each member; values must sum to 14

**:spcn24=** (optional)

24-bit ITU national secondary point code with subfields *main signaling area-sub signaling area-signaling point (msa-ssa-sp)*. The *prefix* subfield indicates a private point code (*prefix-msa-ssa-sp*).

**Range:** **p-, 000-255**

Specify a valid value for each subfield of the point code, and separate the subfields with a dash (-).

*prefix*—**p-**

*msa*—**000-255**

*ssa*—**000-255**

*sp*—**000-255**

**:splitiam=** (optional)

IAM/SAM split. This parameter displays all entries with the specified **splitiam** parameter value.

**Range:** **15-31, none**

## Example

The following example displays all encountered destination point codes that are members of network cluster 20-2 as well as the cluster address:

```
rtrv-dstn:dpca=20-2-***
```

The following example displays the destination with an ANSI alias of 222-200-200:

```
rtrv-dstn:aliasa=222-200-200
```

The following example displays all encountered ANSI alias destination point codes that have a network indicator (ni) of 222 and a network cluster (nc) of 200:

```
rtrv-dstn:aliasa=222-200-***
```

The following example displays the destination with a CLLI of rlgncbb001:

```
rtrv-dstn:clli=rlgncbb001
```

The following example displays the secondary point code 6-6-6:

```
rtrv-dstn:spc=6-6-6
```

The following example displays a single cluster (the NRT feature must be turned on):

```
rtrv-dstn:dpc=010-**-*
```

The following example displays a single ITU national destination (the ITUDUPPC feature must be turned on):

```
rtrv-dstn:dpcn=3-15-15-15-fr:spc=1-15-15-15-fr
```

The following example displays all ITU national group codes by duplicate point code:

```
rtrv-dstn:dpcn=2050-*
```

The following example displays all ITU national point codes within a group code:

**rtrv-dstn:dpcn=\*-fr**

The following example displays 24-bit ITU national point code 15-100-10:

**rtrv-dstn:dpcn24=15-100-10**

The following example displays 24-bit ITU national secondary point code 99-99-99:

**rtrv-dstn:spcn24=99-99-99**

The following example displays 24-bit ITU national alias point code 4-4-4:

**rtrv-dstn:aliasn24=4-4-4**

The following example displays a private point code:

**rtrv-dstn:dpcn=p-12-12-12**

The following examples display a private and spare point code:

**rtrv-dstn:dpcn=ps-123**

**rtrv-dstn:dpci=ps-1-234-1**

The following example displays all ANSI private point codes:

**rtrv-dstn:pctype=ansi:pcst=p**

The following example displays all ITU international spare point codes:

**rtrv-dstn:pctype=itui:pcst=s**

The following example displays all ITU national private and spare point codes:

**rtrv-dstn:pctype=itun:pcst=ps**

The following example displays all 24-bit ITU national private point codes:

**rtrv-dstn:pctype=itun24:pcst=p**

The following example displays all ANSI point codes that do not have point code subtype prefixes:

**rtrv-dstn:pctype=ansi**

The following example displays all ITU international point codes that do not have point code subtype prefixes:

**rtrv-dstn:pctype=itui**

The following example displays all ITU national point codes that do not have point code subtype prefixes:

**rtrv-dstn:pctype=itun**

The following example displays all 24-bit ITU national point codes that do not have point code subtype prefixes:

**rtrv-dstn:pctype=itun24**

The following example displays all point codes that do not have point code subtype prefixes:

**rtrv-dstn:pcst=none**

The following example displays all private point codes:

**rtrv-dstn:pcst=p**

The following example displays all spare point codes:

**rtrv-dstn:pcst=s**

The following example displays all private and spare point codes:

**rtrv-dstn:pcst=ps**

The following example displays all proxy destinations.

**rtrv-dstn:prx=yes**

The following example displays all destinations using a specified proxy point code.

```
rtrv-dstn:ppc=1-1-1
```

The following example displays full DPCs when the homescp=yes parameter is specified.

```
rtrv-dstn:homescp=yes
```

## Dependencies

**NOTE:** A *full point code* contains numerical values for all three segments of the point code.

Only one destination point code parameter, or one alias point code parameter, or one CLI parameter can be specified in the command; these parameters cannot be specified together in the command.

If the **dpcn** parameter or the **aliasn** parameter is specified, the format must match the format that was assigned with the **chg-stpopts:npcfmti** parameter.

If specified (except when **spc=none**), the secondary point code must be a full point code.

Cluster destinations are allowed only if the Cluster Routing Management and Diversity (CRMD) feature is turned on.

Alias point codes must be specified as full point codes.

When the **msar=only** parameter is specified, no other parameters can be specified in the command.

Network routing is valid only if the Network Routing (NRT) feature is turned on.

The **pcst** parameter value **s** or **ps** cannot be specified when the **pctype** value **ansi** or **itun24** is specified.

The **pctype** and **pcst** parameters cannot be specified in the same command with the destination point code, alias point code, secondary point code, **cli**, **msar=only**, and **ncai** parameters.

The **cli** parameter value cannot be **none**.

The Proxy Point Code feature must be enabled before the **prx** parameter can be specified.

The Proxy Point Code feature must be enabled before the **ppc** parameter can be specified.

The **prx** parameter can be specified with only the **pctype**, **pcst**, or **msar** parameter.

The **ppc** parameter can be specified with only the **msar** parameter.

If the **prx** parameter is specified, then either **yes** or **no** value must be assigned.

The point code specified by the **ppc** parameter must be a full point code.

Proxy point codes, as specified by the **ppc** parameter, cannot be private.

PRX point codes cannot be private.

## Notes

This command can be canceled using the **F9** function key or the **canc-cmd** command. See **canc-cmd** for more information.

In this command, only ITU-international and ITU national point codes and aliases support the spare point code subtype prefix (**s-**). Only ITU-international and ITU national point codes support the private and spare point code subtype prefix (**ps-**). All of the point code types support the private (internal) point code subtype prefix (**p-**). Aliases do not support the private (internal) point code prefix.

Table 5-80 provides a summary description of the reports that are produced by the various DPC parameter syntaxes.

Table 5-80. Summary of DPC Parameter Syntaxes

| DPC format                         | Meaning                                                                                                                                                                                                                              |
|------------------------------------|--------------------------------------------------------------------------------------------------------------------------------------------------------------------------------------------------------------------------------------|
| <b>rtrv-dstn:dpc=ni-nc-ncm</b>     | Requests a report for fully provisioned destination <i>ni-nc-ncm</i> .                                                                                                                                                               |
| <b>rtrv-dstn:dpc=ni-*-*</b>        | Requests a report for provisioned network destination with the specified network indicator. Note that if * is specified in the <i>nc</i> field, * must be specified in the <i>ncm</i> field.                                         |
| <b>rtrv-dstn:dpc=ni-***-*</b>      | Requests a report for the full network cluster for the specified <i>ni</i> .                                                                                                                                                         |
| <b>rtrv-dstn:dpc=ni-***-*</b>      | Requests a report for the full network cluster and the network cluster address (if any) for the specified <i>ni</i> .                                                                                                                |
| <b>rtrv-dstn:dpc=ni-nc-*</b>       | Requests a report for provisioned cluster destination <i>ni-nc-*</i> .                                                                                                                                                               |
| <b>rtrv-dstn:dpc=ni-nc-**</b>      | Requests a report showing all destinations whose network ( <i>ni</i> ) and cluster ( <i>nc</i> ) components match those specified. Note, however, that the network cluster address on <i>ni-nc-*</i> (if it exists) is not reported. |
| <b>rtrv-dstn:dpc=ni-nc-***</b>     | Requests a report showing all destinations whose network ( <i>ni</i> ) and cluster ( <i>nc</i> ) components match those specified. The network cluster address <i>ni-nc-*</i> (if it exists) is also reported.                       |
| <b>rtrv-dstn:dpcn24=msa-ssa-sp</b> | Requests a report for fully provisioned 24-bit ITU-N destination <i>main signaling area-sub signaling area-signaling point</i> .                                                                                                     |

#### Asterisks in ANSI Point Codes

Two asterisks in the *ncm* subfield of a cluster point code produces a summary report that shows all point code destinations residing in the given cluster (for example, **20-2-\*\***). This does not include the specified cluster point code (for example, **20-2-\***).

Three asterisks in the *ncm* subfield of a cluster point code (for example, **20-2-\*\*\***) produces a summary report that shows all point code destinations residing in the given network cluster. The specified cluster point code is also displayed if it exists.

If the linkset name is specified (**lsn** parameter) and the **dpc/dpca** parameter *ncm* subfield is specified with asterisks, all route entries are displayed that have the specified linkset and that match the specified **dpc/dpca** parameter subfield values.

#### Asterisks in ITU-N Duplicate Point Codes and Flexible Format Point Codes

When the ITU Duplicate Point Code (ITUDUPPC) feature is on,

- An asterisk (\*) can be specified for the group code of an ITU-N duplicate point code to display all ITU-N point codes that have the specified node value (for example, **10101-\***).
- An asterisk (\*) can be specified for the node of an ITU-N duplicate point code to display all ITU-N point codes that have the specified group code value (for example, **\*-ab**).



When the ITUDUPPC feature is on and the STP flexible point code option (**npfmtti**) is used to change the ITU-N point format to four members (*m1-m2-m3-m4-gc*),

- An asterisk (\*) can be specified for the group code of an ITU-N flexible point code to display all ITU-N point codes that have the specified point code value (for example, **15-15-15-3-\***).
- An asterisk (\*) can be specified for every member of the ITU-N flexible point code to display all ITU-N flexible point codes that have the same group code (for example, **\*-\*-\*-\*-ab** is valid; **\*-15-\*-\*-\*-ab** is not valid).

If the Proxy Point Code feature is enabled, then the values specified for the **ppc** and **dpc** parameters must be full point codes. Cluster point codes and private point codes are not supported.

## Output

### *Destination Table Memory Space Accounting Information*

Each output example for this command shows the display of destination table memory space accounting information. The **msar** parameter value and the NCR, NRT, CRMD, and Origin-based MTP Routing feature settings determine whether a summary report or a detail report is displayed.

#### *Summary Report*

When the NCR, NRT, CRMD, and Origin-based MTP Routing features are off, the summary report is displayed when the command is entered with and without parameters specified and for all of the **msar** parameter values. The detail report cannot be displayed. The summary information appears at the end of the requested destination information, or appears without any other destination information when the **msar=only** parameter is specified.

When one or more of the NCR, NRT, CRMD, and Origin-based MTP Routing features are on, the summary report is displayed:

- When the command is entered with one or more parameters to select the specific destination information to be displayed. The summary information appears at the end of the requested destination information. (The **msar=summary** parameter value is the default in this case.)
- When the command is entered with only the **msar=summary** parameter specified. The summary information appears at the end of the destination information.

The maximum number of destinations that can be provisioned depends on the Routes and Routesets quantity features that are on in the system (see the **rtrv-feat dstn5000** entry and the **rtrv-ctrl-feat Routesets** entry). The **chg-stpopts** command **mtpdpcq** parameter must be set to the value of the Routes or Routesets quantity feature to allow the maximum number of destinations to be provisioned.

The number currently provisioned is the value  $x$ , the allowed maximum is the value  $y$ , and the table percent full is the value  $z$  shown in the following first line of the summary report:

Destination table is ( $x$  of  $y$ )  $z\%$  full

- When no Routes or Routesets quantity features are on in the system, a maximum of 2000 destinations can be provisioned.
- When the DSTN5000 (5000 Routes) feature bit is on, a maximum of 5000 destinations can be provisioned.
- When the 6000, 7000, or 8000 Routesets quantity feature is enabled, a maximum of the corresponding number of destinations can be provisioned.

The maximum number of aliases that can be provisioned depends on the quantity features that are on in the system (see the **rtrv-feat dstn5000** entry and the **rtrv-ctrl-feat Routesets** entry). The number currently provisioned is the  $x$  value, the allowed maximum is the  $y$  value, and the table percent full is the  $z$  value shown in the following second line of the summary report:

Alias table is ( $x$  of  $y$ )  $z\%$  full

- When no Routes or Routesets quantity features are on in the system, a maximum of 12000 aliases can be provisioned.
- When the DSTN5000 feature bit is on, a maximum of 12000 aliases can be provisioned.
- When the 6000 Routesets feature quantity is enabled, a maximum of 12000 aliases can be provisioned.

- When the 7000, or 8000 Routesets quantity feature is enabled, a maximum of 8000 aliases can be provisioned.

#### *Detail Report*

When the NCR, NRT, CRMD, and Origin-based MTP Routing features are off, the detail report cannot be displayed.

When one or more of the NCR, NRT, CRMD, or Origin-based MTP Routing features are on, the detail report is displayed:

- When the command is entered with no parameters. The detail report appears at the end of the destination information. (The **msar=detail** parameter value is the default in this case.)
- When the **msar=detail** parameter is specified with one or more other parameters to select the specific destination information to be displayed. The detail report appears at the end of the requested destination information.
- When the **msar=only** parameter is specified. The detail report appears with no other destination information.

The maximum number of destinations that can be provisioned depends on the Routes and Routesets quantity features that are on in the system (see the **rtrv-feat dstn5000** entry and the **rtrv-ctrl-feat Routesets** entry). The **chg-stpopts mtpdpcq** parameter must be set to the value of the quantity feature to allow the maximum number of destinations to be provisioned. The possible maximum numbers of destinations are described in the *Summary Report* section.

In the example of the detail report, the allowed maximum number of destinations is the DESTINATION ENTRIES ALLOCATED value. The list of values under the allocated value includes the TOTAL DPCs currently provisioned and the Destination table CAPACITY (% FULL).

The allowed maximum number of aliases is the ALIASES ALLOCATED value. The list of values under the allocated value include the current number of ALIASES USED and the Aliases table CAPACITY (% FULL). The possible maximum numbers of aliases are described in the *Summary Report* section.

The output for the **rtrv-dstn** command does not change when the Proxy Point Code feature is on.

Abbreviated output is indicated by 3 vertical dots as shown:

.  
.  
.

The following example shows destination table memory space accounting information contained in a summary report. In the example, the **msar=only** parameter is specified and the NCR, NRT, CRMD, and Origin-based MTP Routing features are all off. The Summary Report information appears without any other destination information.

```
rtrv-dstn:msar=only
  rlgncxa03w 06-06-01 16:02:05 EST EAGLE 35.0.0
  Destination table is (0 of 2000) 0% full
  Alias table is (0 of 12000) 0% full
  RTRV-DSTN: MASP A - COMPLTD
;
```

The following example shows the destination table memory space accounting information contained in a detail report. In the following example, the **msar=only** parameter is specified and one or more

of the NCR, NRT, CRMD or Origin-based MTP Routing features are on. The Detail Report information appears without any other destination information.

**rtrv-dstn:msar=only**

```
eagle10115 08-12-09 10:00:37 EST EAGLE 40.1.0
DESTINATION ENTRIES ALLOCATED: 2000
  FULL DPC(s): 178
  EXCEPTION DPC(s): 17
  NETWORK DPC(s): 0
  CLUSTER DPC(s): 4
  TOTAL DPC(s): 199
  CAPACITY (% FULL): 10%
ALIASES ALLOCATED: 12000
  ALIASES USED: 206
  CAPACITY (% FULL): 2%
X-LIST ENTRIES ALLOCATED: 500
```

;

The following example shows the display of an empty DSTN table when the NCR, NRT, and CRMD features are off, and no Routes or Routesets quantity features are on.

**rtrv-dstn**

```
tekelecstp 08-01-21 10:31:06 EST EAGLE 38.0.0

No destinations meeting the requested criteria were found

Destination table is (0 of 2000) 0% full
Alias table is (0 of 12000) 0% full
```

;

The following example shows the display of an empty Destination table when one or more of the NCR, NRT, or CRMD features are turned on and no Routes or Routesets features are on.

**rtrv-dstn**

```
tekelecstp 08-01-21 10:31:06 EST EAGLE 38.0.0

No destinations meeting the requested criteria were found

DESTINATION ENTRIES ALLOCATED: 2000
  FULL DPC(s): 0
  NETWORK DPC(s): 0
  CLUSTER DPC(s): 0
  TOTAL DPC(s): 0
  CAPACITY (% FULL): 0%
ALIASES ALLOCATED: 12000
  ALIASES USED: 0
  CAPACITY (% FULL): 0%
X-LIST ENTRIES ALLOCATED: 500
```

;

The following example shows a display of all provisioned destinations. This example displays abbreviated output.

**rtrv-dstn**

```
eagle10115 08-12-09 10:00:37 EST EAGLE 40.1.0

DPCA      CLLI      BEI  ELEI  ALIASI      ALIASN/N24  DMN
001-001-000  stp1      no  ---  -----  -----  SS7
003-001-000  mstp      no  ---  -----  -----  SS7
004-001-000  stp4      no  ---  -----  -----  SS7
.
.
.
200-200-*    cluster2  yes no  -----  -----  SS7
005-006-001  -----  no  ---  -----  005-006-001  SS7
```

Commands

rtrv-dstn

|               |             |     |      |             |            |     |
|---------------|-------------|-----|------|-------------|------------|-----|
| 001-001-001   | dstn01      | no  | ---  | -----       | -----      | SS7 |
| p-001-001-001 | dstn01p     | no  | ---  | -----       | -----      | SS7 |
| 001-001-002   | dstn02      | no  | ---  | 1-001-2     | -----      | SS7 |
| p-001-001-002 | dstn02p     | no  | ---  | 1-011-2     | -----      | SS7 |
| 001-001-003   | dstn03      | no  | ---  | s-1-001-3   | -----      | SS7 |
| p-001-001-003 | dstn03p     | no  | ---  | s-1-011-3   | -----      | SS7 |
| 001-001-004   | dstn04      | no  | ---  | -----       | 02060      | SS7 |
| p-001-001-004 | dstn04p     | no  | ---  | -----       | 01060      | SS7 |
| 001-070-001   | tgtansi001  | no  | ---  | -----       | -----      | SS7 |
| 001-001-005   | dstn05      | no  | ---  | -----       | s-02061    | SS7 |
| p-001-001-005 | dstn05p     | no  | ---  | -----       | s-01061    | SS7 |
| .             |             |     |      |             |            |     |
| .             |             |     |      |             |            |     |
| DPCI          | CLLI        | BEI | ELEI | ALIASA      | ALIASN/N24 | DMN |
| s-4-002-0     | -----       | no  | ---  | 010-001-001 | s-08228    | SS7 |
| 2-010-0       | dstn13      | no  | ---  | -----       | -----      | SS7 |
| p-2-010-0     | dstn13p     | no  | ---  | -----       | -----      | SS7 |
| 2-010-1       | dstn14      | no  | ---  | 002-010-001 | -----      | SS7 |
| p-2-010-1     | dstn14p     | no  | ---  | 002-100-001 | -----      | SS7 |
| 2-010-2       | dstn15      | no  | ---  | -----       | 04178      | SS7 |
| p-2-010-2     | dstn15p     | no  | ---  | -----       | 08178      | SS7 |
| 2-010-3       | dstn16      | no  | ---  | -----       | s-04179    | SS7 |
| p-2-010-3     | dstn16p     | no  | ---  | -----       | s-08179    | SS7 |
| .             |             |     |      |             |            |     |
| .             |             |     |      |             |            |     |
| s-2-020-0     | dstn21      | no  | ---  | -----       | -----      | SS7 |
| ps-2-020-0    | dstn21p     | no  | ---  | -----       | -----      | SS7 |
| s-2-020-1     | dstn22      | no  | ---  | 002-020-001 | -----      | SS7 |
| ps-2-020-1    | dstn22p     | no  | ---  | 002-200-001 | -----      | SS7 |
| s-2-020-2     | dstn23      | no  | ---  | -----       | 04258      | SS7 |
| ps-2-020-2    | dstn23p     | no  | ---  | -----       | 08258      | SS7 |
| s-2-020-3     | dstn24      | no  | ---  | -----       | s-04259    | SS7 |
| ps-2-020-3    | dstn24p     | no  | ---  | -----       | s-08259    | SS7 |
| s-2-070-3     | tgtitui003  | no  | ---  | -----       | -----      | SS7 |
| .             |             |     |      |             |            |     |
| .             |             |     |      |             |            |     |
| s-2-029-6     | rtxroute002 | no  | ---  | 002-029-006 | s-04269    | SS7 |
| DPCI          | CLLI        | BEI | ELEI | ALIASI      | ALIASN/N24 | DMN |
| 3-030-0       | dstn29      | no  | ---  | s-3-030-0   | -----      | SS7 |
| p-3-030-0     | dstn29p     | no  | ---  | s-3-031-0   | -----      | SS7 |
| 3-030-1       | dstn30      | no  | ---  | s-3-030-1   | 06385      | SS7 |
| p-3-030-1     | dstn30p     | no  | ---  | s-3-031-1   | 07385      | SS7 |
| .             |             |     |      |             |            |     |
| .             |             |     |      |             |            |     |
| DPCI          | CLLI        | BEI | ELEI | ALIASN      | ALIASN     | DMN |
| 3-030-4       | dstn33      | no  | ---  | s-06388     | 06388      | SS7 |
| p-3-030-4     | dstn33p     | no  | ---  | s-07388     | 07388      | SS7 |
| 3-030-5       | dstn34      | no  | ---  | 06389       | s-06389    | SS7 |
| p-3-030-5     | dstn34p     | no  | ---  | 07389       | s-07389    | SS7 |
| s-3-040-6     | dstn39      | no  | ---  | s-06471     | 06471      | SS7 |
| ps-3-040-6    | dstn39p     | no  | ---  | s-07471     | 07471      | SS7 |
| s-3-040-7     | dstn40      | no  | ---  | 06472       | s-06472    | SS7 |
| ps-3-040-7    | dstn40p     | no  | ---  | 07472       | s-07472    | SS7 |
| DPCN          | CLLI        | BEI | ELEI | ALIASA      | ALIASI     | DMN |
| 06157         | -----       | no  | ---  | 020-005-002 | -----      | SS7 |
| 08192         | dstn41      | no  | ---  | -----       | -----      | SS7 |
| p-08192       | dstn41p     | no  | ---  | -----       | -----      | SS7 |

|         |            |    |     |             |           |     |
|---------|------------|----|-----|-------------|-----------|-----|
| 08193   | dstn42     | no | --- | 004-000-001 | -----     | SS7 |
| p-08193 | dstn42p    | no | --- | 004-200-001 | -----     | SS7 |
| 08194   | dstn43     | no | --- | -----       | 4-000-2   | SS7 |
| p-08194 | dstn43p    | no | --- | -----       | 4-040-2   | SS7 |
| 08195   | dstn44     | no | --- | -----       | s-4-000-3 | SS7 |
| p-08195 | dstn44p    | no | --- | -----       | s-4-040-3 | SS7 |
| 08753   | tgtitun001 | no | --- | -----       | -----     | SS7 |

.  
.  
.

| DPCN     | CLLI        | BEI | ELEI | ALIASI    | ALIASI    | DMN |
|----------|-------------|-----|------|-----------|-----------|-----|
| 08198    | dstn47      | no  | ---  | s-4-000-6 | 4-000-6   | SS7 |
| p-08198  | dstn47p     | no  | ---  | s-4-040-6 | 4-040-6   | SS7 |
| 08199    | dstn48      | no  | ---  | 4-000-7   | s-4-000-7 | SS7 |
| p-08199  | dstn48p     | no  | ---  | 4-040-7   | s-4-040-7 | SS7 |
| s-08278  | dstn55      | no  | ---  | s-4-010-6 | 4-010-6   | SS7 |
| ps-08278 | dstn55p     | no  | ---  | s-4-050-6 | 4-050-6   | SS7 |
| s-08279  | dstn56      | no  | ---  | 4-010-7   | s-4-010-7 | SS7 |
| ps-08279 | dstn56p     | no  | ---  | 4-050-7   | s-4-050-7 | SS7 |
| s-08379  | rtxroute003 | no  | ---  | s-4-058-7 | 4-058-7   | SS7 |

| DPCN     | CLLI    | BEI | ELEI | ALIASN  | ALIASI    | DMN |
|----------|---------|-----|------|---------|-----------|-----|
| 12688    | dstn57  | no  | ---  | s-12688 | -----     | SS7 |
| p-12688  | dstn57p | no  | ---  | s-13688 | -----     | SS7 |
| 12689    | dstn58  | no  | ---  | s-12689 | 6-050-1   | SS7 |
| p-12689  | dstn58p | no  | ---  | s-13689 | 6-060-1   | SS7 |
| 12690    | dstn59  | no  | ---  | s-12690 | s-6-050-2 | SS7 |
| p-12690  | dstn59p | no  | ---  | s-13690 | s-6-060-2 | SS7 |
| s-12691  | dstn60  | no  | ---  | 12691   | -----     | SS7 |
| ps-12691 | dstn60p | no  | ---  | 13691   | -----     | SS7 |
| s-12692  | dstn61  | no  | ---  | 12692   | 6-050-4   | SS7 |
| ps-12692 | dstn61p | no  | ---  | 13692   | 6-060-4   | SS7 |
| s-12693  | dstn62  | no  | ---  | 12693   | s-6-050-5 | SS7 |
| ps-12693 | dstn62p | no  | ---  | 13693   | s-6-060-5 | SS7 |

| DPCN24        | CLLI       | BEI | ELEI | ALIASA      | ALIASI    | DMN |
|---------------|------------|-----|------|-------------|-----------|-----|
| 003-003-004   | -----      | no  | ---  | 003-003-003 | 3-003-4   | SS7 |
| 006-005-001   | dstn63     | no  | ---  | -----       | -----     | SS7 |
| p-006-005-001 | dstn63p    | no  | ---  | -----       | -----     | SS7 |
| 006-005-002   | dstn64     | no  | ---  | 006-005-002 | -----     | SS7 |
| p-006-005-002 | dstn64p    | no  | ---  | 006-005-020 | -----     | SS7 |
| 006-005-003   | dstn65     | no  | ---  | -----       | 6-005-3   | SS7 |
| p-006-005-003 | dstn65p    | no  | ---  | -----       | 6-050-3   | SS7 |
| 006-070-001   | tgtitun24a | no  | ---  | -----       | -----     | SS7 |
| 006-005-004   | dstn66     | no  | ---  | -----       | s-6-005-4 | SS7 |
| p-006-005-004 | dstn66p    | no  | ---  | -----       | s-6-050-4 | SS7 |
| 006-005-005   | dstn67     | no  | ---  | 006-005-005 | 6-005-5   | SS7 |
| p-006-005-005 | dstn67p    | no  | ---  | 006-005-050 | 6-050-5   | SS7 |
| 006-070-002   | tgtitun24b | no  | ---  | -----       | -----     | SS7 |

```

DESTINATION ENTRIES ALLOCATED: 2000
  FULL DPC(s): 178
  EXCEPTION DPC(s): 17
  NETWORK DPC(s): 0
  CLUSTER DPC(s): 4
  TOTAL DPC(s): 199
  CAPACITY (% FULL): 10%
ALIASES ALLOCATED: 12000
  ALIASES USED: 206
  CAPACITY (% FULL): 2%
X-LIST ENTRIES ALLOCATED: 500
    
```

;

The following example displays the 24-bit ITUN Destination Point Code(s) assigned to a specified 24-bit ITUN Secondary Point Code.

**rtrv-dstn:spcn24=6-5-0**

eagle10115 08-12-09 10:00:37 EST EAGLE 40.1.0

SPCN24 = 006-005-000

| DPCN24        | CLLI       | BEI | ELEI | ALIASA      | ALIASI    | DMN |
|---------------|------------|-----|------|-------------|-----------|-----|
| 003-003-004   | -----      | no  | ---  | 003-003-003 | 3-003-4   | SS7 |
| 006-005-001   | dstn63     | no  | ---  | -----       | -----     | SS7 |
| p-006-005-001 | dstn63p    | no  | ---  | -----       | -----     | SS7 |
| 006-005-002   | dstn64     | no  | ---  | 006-005-002 | -----     | SS7 |
| p-006-005-002 | dstn64p    | no  | ---  | 006-005-020 | -----     | SS7 |
| 006-005-003   | dstn65     | no  | ---  | -----       | 6-005-3   | SS7 |
| p-006-005-003 | dstn65p    | no  | ---  | -----       | 6-050-3   | SS7 |
| 006-070-001   | tgtitun24a | no  | ---  | -----       | -----     | SS7 |
| 006-005-004   | dstn66     | no  | ---  | -----       | s-6-005-4 | SS7 |
| p-006-005-004 | dstn66p    | no  | ---  | -----       | s-6-050-4 | SS7 |
| 006-005-005   | dstn67     | no  | ---  | 006-005-005 | 6-005-5   | SS7 |
| p-006-005-005 | dstn67p    | no  | ---  | 006-005-050 | 6-050-5   | SS7 |
| 006-070-002   | tgtitun24b | no  | ---  | -----       | -----     | SS7 |

Destination table is (199 of 2000) 10% full  
 Alias table is (206 of 12000) 2% full

;

The following example displays the retrieval of clusters when the **ncai=yes** parameter is specified.

**rtrv-dstn:ncai=yes**

eagle10115 08-12-09 10:00:37 EST EAGLE 40.1.0

NCAI = yes

| DPCA      | CLLI     | BEI | ELEI | ALIASI | ALIASN/N24 | DMN |
|-----------|----------|-----|------|--------|------------|-----|
| 100-100-* | cluster1 | no  | no   | -----  | -----      | SS7 |
| 200-200-* | cluster2 | yes | no   | -----  | -----      | SS7 |

Destination table is (199 of 2000) 10% full  
 Alias table is (206 of 12000) 2% full

;

The following example displays the retrieval of a single cluster when the **ncai=yes** parameter is specified.

**rtrv-dstn:dpc=200-200-\***

eagle10115 09-08-09 10:00:37 EST EAGLE 41.1.0

| DPCA      | CLLI     | BEI | ELEI | ALIASI | ALIASN/N24 | DMN |
|-----------|----------|-----|------|--------|------------|-----|
| 200-200-* | cluster2 | yes | no   | -----  | -----      | SS7 |

| SPCA  | NCAI | RCAUSE | NPRST | SPLITIAM | HMSMSC | HMSCP |
|-------|------|--------|-------|----------|--------|-------|
| ----- | yes  | none   | off   | none     | no     | no    |

Destination table is (197 of 2000) 10% full  
 Alias table is (206 of 12000) 2% full

;

The following example displays the retrieval of clusters when the **ncai=no** parameter is specified.

**rtrv-dstn:ncai=no**

eagle10115 08-12-09 10:00:37 EST EAGLE 40.1.0

NCAI = no

```

DPCA          CLLI          BEI ELEI  ALIASI          ALIASN/N24  DMN
040-001-*    myncaibeno no no -----
040-010-*    myncaibeno2 no no -----

```

Destination table is (199 of 2000) 10% full  
 Alias table is (206 of 12000) 2% full

;

The following example displays a single cluster with the NRT feature turned on.

**rtrv-dstn:dpc=010--\***

eagle10115 09-08-09 10:00:37 EST EAGLE 41.1.0

```

DPCA          CLLI          BEI ELEI  ALIASI          ALIASN/N24  DMN
010--*       -----

```

```

SPCA          NCAI          RCAUSE      NPRST      SPLITIAM  HMSMSC  HMSCP
-----      ----      none       off       none      no      no

```

Destination table is (200 of 2000) 10% full  
 Alias table is (206 of 12000) 2% full

;

The following example displays a single ITU national destination with the ITUDUPPC (ITU Duplicate Point Code) feature turned on:

**rtrv-dstn:dpcn=08199-tk**

eagle10115 09-08-09 10:00:37 EST EAGLE 41.1.0

```

DPCN          CLLI          BEI ELEI  ALIASA          ALIASI          DMN
08199-tk     dstn48dupTk no --- -----

```

```

SPCN          NCAI          RCAUSE      NPRST      SPLITIAM  HMSMSC  HMSCP
-----      ----      none       off       none      no      no

```

Destination table is (207 of 2000) 10% full  
 Alias table is (215 of 12000) 2% full

;

The following example displays all ITU national group codes by duplicate point code:

**rtrv-dstn:dpcn=8198-\***

eagle10115 08-12-09 10:00:37 EST EAGLE 40.1.0

```

DPCN          CLLI          BEI ELEI  ALIASA          ALIASI          DMN
08198-nz     dstn47dupnz no --- -----

```

```

DPCN          CLLI          BEI ELEI  ALIASI          ALIASI          DMN
08198-aa     dstn47         no --- s-4-000-6     4-000-6     SS7
08198-fr     dstn47dupfr   no --- s-4-005-7     4-005-7     SS7
08198-tk     dstn47dupTk   no --- 4-006-0       s-4-006-0   SS7

```

Destination table is (207 of 2000) 10% full  
 Alias table is (215 of 12000) 2% full

;

The following example displays a single cluster when the the NRT feature and DSTN5000 features are turned on.

**rtrv-dstn:dpc=010--\***

eagle10115 09-08-09 10:00:37 EST EAGLE 41.0.0

```

DPCI          CLLI          BEI ELEI  ALIASA          ALIASN/N24  DMN

```



```

010--*  ----- no  no  -----  -----  SS7

SPCI      NCAI      RCAUSE      NPRST      SPLITIAM  HMSMSC  HMSCP
-----  ----      none        off        none      no      no
    
```

Destination table is (3 of 6000) 1% full  
 Alias table is (4 of 12000) 1% full

;

The following example shows output when the 6000 Routesets and CRMD features are turned on:

**rtrv-dstn**

eagle10115 08-12-09 10:00:37 EST EAGLE 40.1.0

```

DPCA      CLLI      BEI  ELEI  ALIASI      ALIASN/N24  DMN
003-003-003  ----- no  --- -----  -----  SS7
004-004-004  ----- no  --- -----  -----  SS7
005-005-005  ----- no  --- -----  -----  SS7
008-001-*    ----- no  no  -----  -----  SS7
    
```

```

DESTINATION ENTRIES ALLOCATED:  6000
FULL DPC(s):                    3
NETWORK DPC(s):                 0
CLUSTER DPC(s):                 1
TOTAL DPC(s):                   4
CAPACITY (% FULL):              1%
ALIASES ALLOCATED:              12000
ALIASES USED:                   0
CAPACITY (% FULL):              0%
X-LIST ENTRIES ALLOCATED:       500
    
```

;

The following example shows output for a specific DPC when the 6000 Routesets and the CRMD features are on:

**rtrv-dstn:dpc=8-1-\***

eagle10115 09-08-09 10:00:37 EST EAGLE 41.1.0

```

DPCA      CLLI      BEI  ELEI  ALIASI      ALIASN/N24  DMN
008-001-*  ----- no  no  -----  -----  SS7

SPCA      NCAI      RCAUSE      NPRST      SPLITIAM  HMSMSC  HMSCP
-----  ----      none        off        none      no      no
    
```

Destination table is (4 of 6000) 1% full  
 Alias table is (0 of 12000) 0% full

;

The following example displays a 24-bit ITU-N destination point code with an assigned 24-bit ITU-N secondary point code.

**rtrv-dstn:dpcn24=6-5-2**

eagle10115 09-08-09 10:00:37 EST EAGLE 41.1.0

```

DPCN24     CLLI      BEI  ELEI  ALIASA      ALIASI      DMN
006-005-002  dstn64      no  ---  006-005-002  -----  SS7

SPCN24     NCAI      RCAUSE      NPRST      SPLITIAM  HMSMSC  HMSCP
-----  ----      none        off        none      no      no
    
```

Destination table is (208 of 2000) 10% full  
 Alias table is (216 of 12000) 2% full

;

The following example displays a specific 24-bit ITU-N alias point code.

**rtrv-dstn:aliasn24=3-41-5**

```
eagle10115 09-08-09 10:00:37 EST EAGLE 41.1.0

      DPCI          CLLI          BEI ELEI    ALIASI          ALIASN/N24    DMN
ps-3-040-5      dstn38p          no  ---    3-041-5          003-041-005  SS7

      SPCI          NCAI          RCAUSE    NPRST    SPLITIAM    HMSMSC    HMSCP
-----          ----          none      off      none        no        no

Destination table is (208 of 2000) 10% full
Alias table is (216 of 12000) 2% full
```

;

The following example shows output for a linkset that contains a private point code.

**rtrv-dstn:dpci=ps-3-40-3**

```
eagle10115 09-08-09 10:00:37 EST EAGLE 41.1.0

      DPCI          CLLI          BEI ELEI    ALIASI          ALIASN/N24    DMN
ps-3-040-3      dstn36p          no  ---    3-041-3          07467-aa      SS7

      SPCI          NCAI          RCAUSE    NPRST    SPLITIAM    HMSMSC    HMSCP
-----          ----          none      off      none        no        no

Destination table is (208 of 2000) 10% full
Alias table is (216 of 12000) 2% full
```

;

The following example displays only ANSI point codes with the private point code subtype prefix (p-).

**rtrv-dstn:pctype=ansi:pcst=p**

```
eagle10115 08-12-09 10:00:37 EST EAGLE 40.1.0

      DPCA          CLLI          BEI ELEI    ALIASI          ALIASN/N24    DMN
p-001-001-001  dstn01p          no  ---  -----          -----          SS7
p-001-001-002  dstn02p          no  ---    1-011-2          -----          SS7
p-001-001-003  dstn03p          no  ---    s-1-011-3          -----          SS7
p-001-001-004  dstn04p          no  ---  -----          01060-aa          SS7
p-001-001-005  dstn05p          no  ---  -----          s-01061-aa          SS7
p-001-001-006  dstn06p          no  ---  -----          001-011-006          SS7
p-001-001-007  dstn07p          no  ---    1-011-7          01063-aa          SS7
p-001-002-000  dstn08p          no  ---    1-012-0          s-01064-aa          SS7
p-001-002-001  dstn09p          no  ---    s-1-012-1          01065-aa          SS7
p-001-002-002  dstn10p          no  ---    s-1-012-2          s-01066-aa          SS7
p-001-002-003  dstn11p          no  ---    1-012-3          001-012-003          SS7
p-001-002-004  dstn12p          no  ---    s-1-012-4          001-012-004          SS7

Destination table is (208 of 2000) 10% full
Alias table is (216 of 12000) 2% full
```

;

The following example displays only ITU-I point codes with the spare point code subtype prefix (s-).

**rtrv-dstn:pctype=itui:pcst=s**

```
eagle10115 08-12-09 10:00:37 EST EAGLE 40.1.0

      DPCI          CLLI          BEI ELEI    ALIASA          ALIASN/N24    DMN
s-4-002-0      -----          no  ---    010-001-001          s-08228-aa          SS7
s-2-020-0      dstn21          no  ---  -----          -----          SS7
s-2-020-1      dstn22          no  ---    002-020-001          -----          SS7
```

```

s-2-020-2      dstn23      no --- ----- 04258-aa      SS7
s-2-020-3      dstn24      no --- ----- s-04259-aa     SS7
s-2-070-3      tgtitui003  no --- ----- ----- SS7
s-2-020-4      dstn25      no --- ----- 002-020-004   SS7
s-2-020-5      dstn26      no --- 002-020-005 04261-aa      SS7
s-2-020-6      dstn27      no --- 002-020-006 s-04262-aa     SS7
s-2-020-7      dstn28      no --- 002-020-007 002-020-007   SS7
s-2-070-4      tgtitui004  no --- ----- ----- SS7
s-3-070-3      tgtitui007  no --- ----- ----- SS7
s-3-070-4      tgtitui008  no --- ----- ----- SS7
s-2-029-6      rtxroute002 no --- 002-029-006 s-04269-aa     SS7

      DPCI      CLLI      BEI  ELEI  ALIASI      ALIASN/N24  DMN
s-3-040-2      dstn35      no --- 3-040-2      ----- SS7
s-3-040-3      dstn36      no --- 3-040-3      06467-aa     SS7
s-3-040-4      dstn37      no --- 3-040-4      s-06468-aa   SS7
s-3-040-5      dstn38      no --- 3-040-5      003-040-005 SS7

      DPCI      CLLI      BEI  ELEI  ALIASN      ALIASN      DMN
s-3-040-6      dstn39      no --- s-06471-aa   06471-aa     SS7
s-3-040-7      dstn40      no --- 06472-aa     s-06472-aa   SS7

```

Destination table is (208 of 2000) 10% full  
Alias table is (216 of 12000) 2% full

;

The following example displays only ITU-N point codes with the private point code subtype prefix (p-).

**rtrv-dstn:pctype=itun:pcst=p**

eagle10115 08-12-09 10:00:37 EST EAGLE 40.1.0

```

      DPCN      CLLI      BEI  ELEI  ALIASA      ALIASI      DMN
p-08192-aa     dstn41p    no --- ----- ----- SS7
p-08193-aa     dstn42p    no --- 004-200-001 ----- SS7
p-08194-aa     dstn43p    no --- ----- 4-040-2      SS7
p-08195-aa     dstn44p    no --- ----- s-4-040-3    SS7
p-08196-aa     dstn45p    no --- 004-200-004 4-040-4      SS7
p-08197-aa     dstn46p    no --- 004-200-005 s-4-040-5    SS7

      DPCN      CLLI      BEI  ELEI  ALIASI      ALIASI      DMN
p-08198-aa     dstn47p    no --- s-4-040-6    4-040-6      SS7
p-08199-aa     dstn48p    no --- 4-040-7      s-4-040-7    SS7

      DPCN      CLLI      BEI  ELEI  ALIASN      ALIASI      DMN
p-12688-aa     dstn57p    no --- s-13688-aa   ----- SS7
p-12689-aa     dstn58p    no --- s-13689-aa   6-060-1      SS7
p-12690-aa     dstn59p    no --- s-13690-aa   s-6-060-2    SS7

```

Destination table is (208 of 2000) 10% full  
Alias table is (216 of 12000) 2% full

;

The following example displays only ITU-N point codes with the private and spare point code subtype prefix (ps-).

**rtrv-dstn:pctype=itun:pcst=ps**

eagle10115 08-12-09 10:00:37 EST EAGLE 40.1.0

```

      DPCN      CLLI      BEI  ELEI  ALIASA      ALIASI      DMN
ps-08272-aa    dstn49p    no --- ----- ----- SS7
ps-08273-aa    dstn50p    no --- 004-200-010 ----- SS7
ps-08274-aa    dstn51p    no --- ----- 4-050-2      SS7
ps-08275-aa    dstn52p    no --- ----- s-4-050-3    SS7

```

|             |         |      |     |             |           |        |     |
|-------------|---------|------|-----|-------------|-----------|--------|-----|
| ps-08276-aa | dstn53p | no   | --- | 004-200-040 | 4-050-4   | SS7    |     |
| ps-08277-aa | dstn54p | no   | --- | 004-200-050 | s-4-050-5 | SS7    |     |
|             | DPCN    | CLLI | BEI | ELEI        | ALIASI    | ALIASI | DMN |
| ps-08278-aa | dstn55p | no   | --- | s-4-050-6   | 4-050-6   | SS7    |     |
| ps-08279-aa | dstn56p | no   | --- | 4-050-7     | s-4-050-7 | SS7    |     |
|             | DPCN    | CLLI | BEI | ELEI        | ALIASN    | ALIASI | DMN |
| ps-12691-aa | dstn60p | no   | --- | 13691-aa    | -----     | SS7    |     |
| ps-12692-aa | dstn61p | no   | --- | 13692-aa    | 6-060-4   | SS7    |     |
| ps-12693-aa | dstn62p | no   | --- | 13693-aa    | s-6-060-5 | SS7    |     |

Destination table is (208 of 2000) 10% full  
 Alias table is (216 of 12000) 2% full

;

The following example displays only ANSI point codes. This example displays abbreviated output.

**rtrv-dstn:pctype=ansi**

eagle10115 08-12-09 10:00:37 EST EAGLE 40.1.0

| DPCA          | CLLI        | BEI | ELEI | ALIASI    | ALIASN/N24  | DMN |
|---------------|-------------|-----|------|-----------|-------------|-----|
| 001-001-000   | stp1        | no  | ---  | -----     | -----       | SS7 |
| 003-001-000   | mstp        | no  | ---  | -----     | -----       | SS7 |
| .             | .           | .   | .    | .         | .           | .   |
| 100-100-*     | cluster1    | no  | no   | -----     | -----       | SS7 |
| 100-100-001   | -----       | no  | ---  | -----     | -----       | SS7 |
| 200-200-*     | cluster2    | yes | no   | -----     | -----       | SS7 |
| 005-006-001   | -----       | no  | ---  | -----     | 005-006-001 | SS7 |
| 001-001-001   | dstn01      | no  | ---  | -----     | -----       | SS7 |
| p-001-001-001 | dstn01p     | no  | ---  | -----     | -----       | SS7 |
| 001-001-002   | dstn02      | no  | ---  | 1-001-2   | -----       | SS7 |
| p-001-001-002 | dstn02p     | no  | ---  | 1-011-2   | -----       | SS7 |
| 001-001-003   | dstn03      | no  | ---  | s-1-001-3 | -----       | SS7 |
| p-001-001-003 | dstn03p     | no  | ---  | s-1-011-3 | -----       | SS7 |
| 001-001-004   | dstn04      | no  | ---  | -----     | 02060-aa    | SS7 |
| p-001-001-004 | dstn04p     | no  | ---  | -----     | 01060-aa    | SS7 |
| 001-070-001   | tgtansi001  | no  | ---  | -----     | -----       | SS7 |
| 001-001-005   | dstn05      | no  | ---  | -----     | s-02061-aa  | SS7 |
| p-001-001-005 | dstn05p     | no  | ---  | -----     | s-01061-aa  | SS7 |
| 001-001-006   | dstn06      | no  | ---  | -----     | 001-001-006 | SS7 |
| p-001-001-006 | dstn06p     | no  | ---  | -----     | 001-011-006 | SS7 |
| 001-001-007   | dstn07      | no  | ---  | 1-001-7   | 02063-aa    | SS7 |
| p-001-001-007 | dstn07p     | no  | ---  | 1-011-7   | 01063-aa    | SS7 |
| 001-002-000   | dstn08      | no  | ---  | 1-002-0   | s-02064-aa  | SS7 |
| p-001-002-000 | dstn08p     | no  | ---  | 1-012-0   | s-01064-aa  | SS7 |
| 001-070-002   | tgtansi002  | no  | ---  | -----     | -----       | SS7 |
| 001-002-001   | dstn09      | no  | ---  | s-1-002-1 | 02065-aa    | SS7 |
| p-001-002-001 | dstn09p     | no  | ---  | s-1-012-1 | 01065-aa    | SS7 |
| 001-002-002   | dstn10      | no  | ---  | s-1-002-2 | s-02066-aa  | SS7 |
| p-001-002-002 | dstn10p     | no  | ---  | s-1-012-2 | s-01066-aa  | SS7 |
| 001-002-003   | dstn11      | no  | ---  | 1-002-3   | 001-002-003 | SS7 |
| p-001-002-003 | dstn11p     | no  | ---  | 1-012-3   | 001-012-003 | SS7 |
| 001-002-004   | dstn12      | no  | ---  | s-1-002-4 | 001-002-004 | SS7 |
| p-001-002-004 | dstn12p     | no  | ---  | s-1-012-4 | 001-012-004 | SS7 |
| 001-070-003   | tgtansi003  | no  | ---  | -----     | -----       | SS7 |
| 200-002-001   | rtxroute001 | no  | ---  | -----     | -----       | SS7 |
| 040-001-*     | myncaibeno  | no  | no   | -----     | -----       | SS7 |
| 040-010-*     | myncaibeno2 | no  | no   | -----     | -----       | SS7 |
| 010-**-*      | -----       | --- | ---  | -----     | -----       | SS7 |

Destination table is (208 of 2000) 10% full  
 Alias table is (216 of 12000) 2% full

;

The following example displays only ITU-I point codes.

**rtrv-dstn:pctype=itui**

| DPCI       | CLLI        | BEI | ELEI | ALIASA      | ALIASN/N24  | DMN |
|------------|-------------|-----|------|-------------|-------------|-----|
| s-4-002-0  | -----       | no  | ---  | 010-001-001 | s-08228-aa  | SS7 |
| 2-010-0    | dstn13      | no  | ---  | -----       | -----       | SS7 |
| p-2-010-0  | dstn13p     | no  | ---  | -----       | -----       | SS7 |
| 2-010-1    | dstn14      | no  | ---  | 002-010-001 | -----       | SS7 |
| p-2-010-1  | dstn14p     | no  | ---  | 002-100-001 | -----       | SS7 |
| 2-010-2    | dstn15      | no  | ---  | -----       | 04178-aa    | SS7 |
| p-2-010-2  | dstn15p     | no  | ---  | -----       | 08178-aa    | SS7 |
| 2-010-3    | dstn16      | no  | ---  | -----       | s-04179-aa  | SS7 |
| p-2-010-3  | dstn16p     | no  | ---  | -----       | s-08179-aa  | SS7 |
| 2-070-1    | tgtitui001  | no  | ---  | -----       | -----       | SS7 |
| 2-010-4    | dstn17      | no  | ---  | -----       | 002-010-004 | SS7 |
| p-2-010-4  | dstn17p     | no  | ---  | -----       | 002-100-004 | SS7 |
| 2-010-5    | dstn18      | no  | ---  | 002-010-005 | 04181-aa    | SS7 |
| p-2-010-5  | dstn18p     | no  | ---  | 002-100-005 | 08181-aa    | SS7 |
| 2-010-6    | dstn19      | no  | ---  | 002-010-006 | s-04182-aa  | SS7 |
| p-2-010-6  | dstn19p     | no  | ---  | 002-100-006 | s-08182-aa  | SS7 |
| 2-010-7    | dstn20      | no  | ---  | 002-010-007 | 002-010-007 | SS7 |
| p-2-010-7  | dstn20p     | no  | ---  | 002-100-007 | 002-100-007 | SS7 |
| 2-070-2    | tgtitui002  | no  | ---  | -----       | -----       | SS7 |
| s-2-020-0  | dstn21      | no  | ---  | -----       | -----       | SS7 |
| ps-2-020-0 | dstn21p     | no  | ---  | -----       | -----       | SS7 |
| s-2-020-1  | dstn22      | no  | ---  | 002-020-001 | -----       | SS7 |
| ps-2-020-1 | dstn22p     | no  | ---  | 002-200-001 | -----       | SS7 |
| s-2-020-2  | dstn23      | no  | ---  | -----       | 04258-aa    | SS7 |
| ps-2-020-2 | dstn23p     | no  | ---  | -----       | 08258-aa    | SS7 |
| s-2-020-3  | dstn24      | no  | ---  | -----       | s-04259-aa  | SS7 |
| ps-2-020-3 | dstn24p     | no  | ---  | -----       | s-08259-aa  | SS7 |
| s-2-070-3  | tgtitui003  | no  | ---  | -----       | -----       | SS7 |
| s-2-020-4  | dstn25      | no  | ---  | -----       | 002-020-004 | SS7 |
| ps-2-020-4 | dstn25p     | no  | ---  | -----       | 002-200-004 | SS7 |
| s-2-020-5  | dstn26      | no  | ---  | 002-020-005 | 04261-aa    | SS7 |
| ps-2-020-5 | dstn26p     | no  | ---  | -----       | -----       | SS7 |
| s-2-020-6  | dstn27      | no  | ---  | 002-020-006 | s-04262-aa  | SS7 |
| ps-2-020-6 | dstn27p     | no  | ---  | 002-200-005 | 08261-aa    | SS7 |
| s-2-020-7  | dstn28      | no  | ---  | 002-020-007 | 002-020-007 | SS7 |
| ps-2-020-7 | dstn28p     | no  | ---  | 002-200-007 | 002-200-007 | SS7 |
| s-2-070-4  | tgtitui004  | no  | ---  | -----       | -----       | SS7 |
| s-3-070-3  | tgtitui007  | no  | ---  | -----       | -----       | SS7 |
| s-3-070-4  | tgtitui008  | no  | ---  | -----       | -----       | SS7 |
| s-2-029-6  | rtxroute002 | no  | ---  | 002-029-006 | s-04269-aa  | SS7 |
|            |             |     |      |             |             |     |
| DPCI       | CLLI        | BEI | ELEI | ALIASI      | ALIASN/N24  | DMN |
| 3-030-0    | dstn29      | no  | ---  | s-3-030-0   | -----       | SS7 |
| p-3-030-0  | dstn29p     | no  | ---  | s-3-031-0   | -----       | SS7 |
| 3-030-1    | dstn30      | no  | ---  | s-3-030-1   | 06385-aa    | SS7 |
| p-3-030-1  | dstn30p     | no  | ---  | s-3-031-1   | 07385-aa    | SS7 |
| 3-030-2    | dstn31      | no  | ---  | s-3-030-2   | s-06386-aa  | SS7 |
| p-3-030-2  | dstn31p     | no  | ---  | s-3-031-2   | s-07386-aa  | SS7 |
| 3-070-1    | tgtitui005  | no  | ---  | s-3-070-1   | -----       | SS7 |
| 3-030-3    | dstn32      | no  | ---  | s-3-030-3   | 003-030-003 | SS7 |
| p-3-030-3  | dstn32p     | no  | ---  | s-3-031-3   | 003-031-003 | SS7 |
| 3-070-2    | tgtitui006  | no  | ---  | s-3-070-2   | -----       | SS7 |
| s-3-040-2  | dstn35      | no  | ---  | 3-040-2     | -----       | SS7 |
| ps-3-040-2 | dstn35p     | no  | ---  | 3-041-2     | -----       | SS7 |
| s-3-040-3  | dstn36      | no  | ---  | 3-040-3     | 06467-aa    | SS7 |
| ps-3-040-3 | dstn36p     | no  | ---  | 3-041-3     | 07467-aa    | SS7 |
| s-3-040-4  | dstn37      | no  | ---  | 3-040-4     | s-06468-aa  | SS7 |
| ps-3-040-4 | dstn37p     | no  | ---  | 3-041-4     | s-07468-aa  | SS7 |
| s-3-040-5  | dstn38      | no  | ---  | 3-040-5     | 003-040-005 | SS7 |

|            |         |     |      |            |             |     |
|------------|---------|-----|------|------------|-------------|-----|
| ps-3-040-5 | dstn38p | no  | ---  | 3-041-5    | 003-041-005 | SS7 |
| DPCI       | CLLI    | BEI | ELEI | ALIASN     | ALIASN      | DMN |
| 3-030-4    | dstn33  | no  | ---  | s-06388-aa | 06388-aa    | SS7 |
| p-3-030-4  | dstn33p | no  | ---  | s-07388-aa | 07388-aa    | SS7 |
| 3-030-5    | dstn34  | no  | ---  | 06389-aa   | s-06389-aa  | SS7 |
| p-3-030-5  | dstn34p | no  | ---  | 07389-aa   | s-07389-aa  | SS7 |
| s-3-040-6  | dstn39  | no  | ---  | s-06471-aa | 06471-aa    | SS7 |
| ps-3-040-6 | dstn39p | no  | ---  | s-07471-aa | 07471-aa    | SS7 |
| s-3-040-7  | dstn40  | no  | ---  | 06472-aa   | s-06472-aa  | SS7 |
| ps-3-040-7 | dstn40p | no  | ---  | 07472-aa   | s-07472-aa  | SS7 |

Destination table is (208 of 2000) 10% full  
 Alias table is (216 of 12000) 2% full

;

The following example displays only ITU-N point codes.

**rtrv-dstn:pctype=itun**

eagle10115 08-12-09 10:00:37 EST EAGLE 40.1.0

| DPCN        | CLLI        | BEI | ELEI | ALIASA      | ALIASI    | DMN |
|-------------|-------------|-----|------|-------------|-----------|-----|
| 06157-aa    | -----       | no  | ---  | 020-005-002 | -----     | SS7 |
| 08192-aa    | dstn41      | no  | ---  | -----       | -----     | SS7 |
| p-08192-aa  | dstn41p     | no  | ---  | -----       | -----     | SS7 |
| 08193-aa    | dstn42      | no  | ---  | 004-000-001 | -----     | SS7 |
| p-08193-aa  | dstn42p     | no  | ---  | 004-200-001 | -----     | SS7 |
| 08194-aa    | dstn43      | no  | ---  | -----       | 4-000-2   | SS7 |
| p-08194-aa  | dstn43p     | no  | ---  | -----       | 4-040-2   | SS7 |
| 08195-aa    | dstn44      | no  | ---  | -----       | s-4-000-3 | SS7 |
| p-08195-aa  | dstn44p     | no  | ---  | -----       | s-4-040-3 | SS7 |
| 08753-aa    | tgtitun001  | no  | ---  | -----       | -----     | SS7 |
| 08196-aa    | dstn45      | no  | ---  | 004-000-004 | 4-000-4   | SS7 |
| p-08196-aa  | dstn45p     | no  | ---  | 004-200-004 | 4-040-4   | SS7 |
| 08197-aa    | dstn46      | no  | ---  | 004-000-005 | s-4-000-5 | SS7 |
| p-08197-aa  | dstn46p     | no  | ---  | 004-200-005 | s-4-040-5 | SS7 |
| 08754-aa    | tgtitun002  | no  | ---  | -----       | -----     | SS7 |
| s-08272-aa  | dstn49      | no  | ---  | -----       | -----     | SS7 |
| ps-08272-aa | dstn49p     | no  | ---  | -----       | -----     | SS7 |
| s-08273-aa  | dstn50      | no  | ---  | 004-010-001 | -----     | SS7 |
| ps-08273-aa | dstn50p     | no  | ---  | 004-200-010 | -----     | SS7 |
| s-08274-aa  | dstn51      | no  | ---  | -----       | 4-010-2   | SS7 |
| ps-08274-aa | dstn51p     | no  | ---  | -----       | 4-050-2   | SS7 |
| s-08275-aa  | dstn52      | no  | ---  | -----       | s-4-010-3 | SS7 |
| ps-08275-aa | dstn52p     | no  | ---  | -----       | s-4-050-3 | SS7 |
| s-08755-aa  | tgtitun003  | no  | ---  | -----       | -----     | SS7 |
| s-08276-aa  | dstn53      | no  | ---  | 004-010-004 | 4-010-4   | SS7 |
| ps-08276-aa | dstn53p     | no  | ---  | 004-200-040 | 4-050-4   | SS7 |
| s-08277-aa  | dstn54      | no  | ---  | 004-010-005 | s-4-010-5 | SS7 |
| ps-08277-aa | dstn54p     | no  | ---  | 004-200-050 | s-4-050-5 | SS7 |
| s-08756-aa  | tgtitun004  | no  | ---  | -----       | -----     | SS7 |
| 08757-aa    | tgtitun005  | no  | ---  | -----       | -----     | SS7 |
| s-08758-aa  | tgtitun006  | no  | ---  | -----       | -----     | SS7 |
| 08199-fr    | dstn48dupfr | no  | ---  | -----       | s-4-006-1 | SS7 |
| 08199-tk    | dstn48dupTk | no  | ---  | -----       | 4-006-2   | SS7 |
| 08198-nz    | dstn47dupnz | no  | ---  | -----       | -----     | SS7 |
| s-08273-fr  | dstn50dupfr | no  | ---  | -----       | 4-006-3   | SS7 |
| DPCN        | CLLI        | BEI | ELEI | ALIASI      | ALIASI    | DMN |
| 08198-aa    | dstn47      | no  | ---  | s-4-000-6   | 4-000-6   | SS7 |
| p-08198-aa  | dstn47p     | no  | ---  | s-4-040-6   | 4-040-6   | SS7 |
| 08199-aa    | dstn48      | no  | ---  | 4-000-7     | s-4-000-7 | SS7 |
| p-08199-aa  | dstn48p     | no  | ---  | 4-040-7     | s-4-040-7 | SS7 |
| s-08278-aa  | dstn55      | no  | ---  | s-4-010-6   | 4-010-6   | SS7 |
| ps-08278-aa | dstn55p     | no  | ---  | s-4-050-6   | 4-050-6   | SS7 |

Commands

rtrv-dstn

|             |             |     |      |            |           |     |
|-------------|-------------|-----|------|------------|-----------|-----|
| s-08279-aa  | dstn56      | no  | ---  | 4-010-7    | s-4-010-7 | SS7 |
| ps-08279-aa | dstn56p     | no  | ---  | 4-050-7    | s-4-050-7 | SS7 |
| s-08379-aa  | rtxroute003 | no  | ---  | s-4-058-7  | 4-058-7   | SS7 |
| 08198-fr    | dstn47dupfr | no  | ---  | s-4-005-7  | 4-005-7   | SS7 |
| 08198-tk    | dstn47dupTk | no  | ---  | 4-006-0    | s-4-006-0 | SS7 |
| DPCN        | CLLI        | BEI | ELEI | ALIASN     | ALIASI    | DMN |
| 12688-aa    | dstn57      | no  | ---  | s-12688-aa | -----     | SS7 |
| p-12688-aa  | dstn57p     | no  | ---  | s-13688-aa | -----     | SS7 |
| 12689-aa    | dstn58      | no  | ---  | s-12689-aa | 6-050-1   | SS7 |
| p-12689-aa  | dstn58p     | no  | ---  | s-13689-aa | 6-060-1   | SS7 |
| 12690-aa    | dstn59      | no  | ---  | s-12690-aa | s-6-050-2 | SS7 |
| p-12690-aa  | dstn59p     | no  | ---  | s-13690-aa | s-6-060-2 | SS7 |
| s-12691-aa  | dstn60      | no  | ---  | 12691-aa   | -----     | SS7 |
| ps-12691-aa | dstn60p     | no  | ---  | 13691-aa   | -----     | SS7 |
| s-12692-aa  | dstn61      | no  | ---  | 12692-aa   | 6-050-4   | SS7 |
| ps-12692-aa | dstn61p     | no  | ---  | 13692-aa   | 6-060-4   | SS7 |
| s-12693-aa  | dstn62      | no  | ---  | 12693-aa   | s-6-050-5 | SS7 |
| ps-12693-aa | dstn62p     | no  | ---  | 13693-aa   | s-6-060-5 | SS7 |
| s-08272-fr  | dstn49dupfr | no  | ---  | 08300-fr   | -----     | SS7 |
| s-08272-tk  | dstn49dupTk | no  | ---  | 08300-tk   | 4-006-7   | SS7 |

Destination table is (208 of 2000) 10% full  
 Alias table is (216 of 12000) 2% full

;

The following example displays only point codes that have no point code subtype prefix. This example displays abbreviated output.

rtrv-dstn:pcst=none

eagle10115 08-12-09 10:00:37 EST EAGLE 40.1.0

|             |             |     |      |             |             |     |
|-------------|-------------|-----|------|-------------|-------------|-----|
| DPCA        | CLLI        | BEI | ELEI | ALIASI      | ALIASN/N24  | DMN |
| 001-001-000 | stpl        | no  | ---  | -----       | -----       | SS7 |
| 003-001-000 | mstp        | no  | ---  | -----       | -----       | SS7 |
| .           |             |     |      |             |             |     |
| .           |             |     |      |             |             |     |
| 200-200-*   | cluster2    | yes | no   | -----       | -----       | SS7 |
| 005-006-001 | -----       | no  | ---  | -----       | 005-006-001 | SS7 |
| 001-001-001 | dstn01      | no  | ---  | -----       | -----       | SS7 |
| 001-001-002 | dstn02      | no  | ---  | 1-001-2     | -----       | SS7 |
| 001-001-003 | dstn03      | no  | ---  | s-1-001-3   | -----       | SS7 |
| 001-001-004 | dstn04      | no  | ---  | -----       | 02060-aa    | SS7 |
| 001-070-001 | tgtansi001  | no  | ---  | -----       | -----       | SS7 |
| 001-001-005 | dstn05      | no  | ---  | -----       | s-02061-aa  | SS7 |
| 001-001-006 | dstn06      | no  | ---  | -----       | 001-001-006 | SS7 |
| 001-001-007 | dstn07      | no  | ---  | 1-001-7     | 02063-aa    | SS7 |
| 001-002-000 | dstn08      | no  | ---  | 1-002-0     | s-02064-aa  | SS7 |
| 001-070-002 | tgtansi002  | no  | ---  | -----       | -----       | SS7 |
| 001-002-001 | dstn09      | no  | ---  | s-1-002-1   | 02065-aa    | SS7 |
| 001-002-002 | dstn10      | no  | ---  | s-1-002-2   | s-02066-aa  | SS7 |
| 001-002-003 | dstn11      | no  | ---  | 1-002-3     | 001-002-003 | SS7 |
| 001-002-004 | dstn12      | no  | ---  | s-1-002-4   | 001-002-004 | SS7 |
| 001-070-003 | tgtansi003  | no  | ---  | -----       | -----       | SS7 |
| 200-002-001 | rtxroute001 | no  | ---  | -----       | -----       | SS7 |
| 040-001-*   | myncaibeno  | no  | no   | -----       | -----       | SS7 |
| 040-010-*   | myncaibeno2 | no  | no   | -----       | -----       | SS7 |
| 010-*-*     | -----       | --- | ---  | -----       | -----       | SS7 |
| DPCI        | CLLI        | BEI | ELEI | ALIASA      | ALIASN/N24  | DMN |
| 2-010-0     | dstn13      | no  | ---  | -----       | -----       | SS7 |
| 2-010-1     | dstn14      | no  | ---  | 002-010-001 | -----       | SS7 |
| 2-010-2     | dstn15      | no  | ---  | -----       | 04178-aa    | SS7 |
| 2-010-3     | dstn16      | no  | ---  | -----       | s-04179-aa  | SS7 |

|             |             |     |      |             |             |     |
|-------------|-------------|-----|------|-------------|-------------|-----|
| 2-070-1     | tgtitui001  | no  | ---  | -----       | -----       | SS7 |
| 2-010-4     | dstn17      | no  | ---  | -----       | 002-010-004 | SS7 |
| 2-010-5     | dstn18      | no  | ---  | 002-010-005 | 04181-aa    | SS7 |
| 2-010-6     | dstn19      | no  | ---  | 002-010-006 | s-04182-aa  | SS7 |
| 2-010-7     | dstn20      | no  | ---  | 002-010-007 | 002-010-007 | SS7 |
| 2-070-2     | tgtitui002  | no  | ---  | -----       | -----       | SS7 |
|             |             |     |      |             |             |     |
| DPCI        | CLLI        | BEI | ELEI | ALIASI      | ALIASN/N24  | DMN |
| 3-030-0     | dstn29      | no  | ---  | s-3-030-0   | -----       | SS7 |
| 3-030-1     | dstn30      | no  | ---  | s-3-030-1   | 06385-aa    | SS7 |
| 3-030-2     | dstn31      | no  | ---  | s-3-030-2   | s-06386-aa  | SS7 |
| 3-070-1     | tgtitui005  | no  | ---  | s-3-070-1   | -----       | SS7 |
| 3-030-3     | dstn32      | no  | ---  | s-3-030-3   | 003-030-003 | SS7 |
| 3-070-2     | tgtitui006  | no  | ---  | s-3-070-2   | -----       | SS7 |
|             |             |     |      |             |             |     |
| DPCI        | CLLI        | BEI | ELEI | ALIASN      | ALIASN      | DMN |
| 3-030-4     | dstn33      | no  | ---  | s-06388-aa  | 06388-aa    | SS7 |
| 3-030-5     | dstn34      | no  | ---  | 06389-aa    | s-06389-aa  | SS7 |
|             |             |     |      |             |             |     |
| DPCN        | CLLI        | BEI | ELEI | ALIASA      | ALIASI      | DMN |
| 06157-aa    | -----       | no  | ---  | 020-005-002 | -----       | SS7 |
| 08192-aa    | dstn41      | no  | ---  | -----       | -----       | SS7 |
| 08193-aa    | dstn42      | no  | ---  | 004-000-001 | -----       | SS7 |
| 08194-aa    | dstn43      | no  | ---  | -----       | 4-000-2     | SS7 |
| 08195-aa    | dstn44      | no  | ---  | -----       | s-4-000-3   | SS7 |
| 08753-aa    | tgtitun001  | no  | ---  | -----       | -----       | SS7 |
| 08196-aa    | dstn45      | no  | ---  | 004-000-004 | 4-000-4     | SS7 |
| 08197-aa    | dstn46      | no  | ---  | 004-000-005 | s-4-000-5   | SS7 |
| 08754-aa    | tgtitun002  | no  | ---  | -----       | -----       | SS7 |
| 08757-aa    | tgtitun005  | no  | ---  | -----       | -----       | SS7 |
| 08199-fr    | dstn48dupfr | no  | ---  | -----       | s-4-006-1   | SS7 |
| 08199-tk    | dstn48dupTk | no  | ---  | -----       | 4-006-2     | SS7 |
| 08198-nz    | dstn47dupnz | no  | ---  | -----       | -----       | SS7 |
|             |             |     |      |             |             |     |
| DPCN        | CLLI        | BEI | ELEI | ALIASI      | ALIASI      | DMN |
| 08198-aa    | dstn47      | no  | ---  | s-4-000-6   | 4-000-6     | SS7 |
| 08199-aa    | dstn48      | no  | ---  | 4-000-7     | s-4-000-7   | SS7 |
| 08198-fr    | dstn47dupfr | no  | ---  | s-4-005-7   | 4-005-7     | SS7 |
| 08198-tk    | dstn47dupTk | no  | ---  | 4-006-0     | s-4-006-0   | SS7 |
|             |             |     |      |             |             |     |
| DPCN        | CLLI        | BEI | ELEI | ALIASN      | ALIASI      | DMN |
| 12688-aa    | dstn57      | no  | ---  | s-12688-aa  | -----       | SS7 |
| 12689-aa    | dstn58      | no  | ---  | s-12689-aa  | 6-050-1     | SS7 |
| 12690-aa    | dstn59      | no  | ---  | s-12690-aa  | s-6-050-2   | SS7 |
|             |             |     |      |             |             |     |
| DPCN24      | CLLI        | BEI | ELEI | ALIASA      | ALIASI      | DMN |
| 003-003-004 | -----       | no  | ---  | 003-003-003 | 3-003-4     | SS7 |
| 006-005-001 | dstn63      | no  | ---  | -----       | -----       | SS7 |
| 006-005-002 | dstn64      | no  | ---  | 006-005-002 | -----       | SS7 |
| 006-005-003 | dstn65      | no  | ---  | -----       | 6-005-3     | SS7 |
| 006-070-001 | tgtitun24a  | no  | ---  | -----       | -----       | SS7 |
| 006-005-004 | dstn66      | no  | ---  | -----       | s-6-005-4   | SS7 |
| 006-005-005 | dstn67      | no  | ---  | 006-005-005 | 6-005-5     | SS7 |
| 006-070-002 | tgtitun24b  | no  | ---  | -----       | -----       | SS7 |

Destination table is (208 of 2000) 10% full  
 Alias table is (216 of 12000) 2% full

;  
 The following example displays only point codes with the spare point code subtype prefix (s-).

**rtrv-dstn:pcst=s**

eagle10115 08-12-09 10:00:37 EST EAGLE 40.1.0

| DPCI | CLLI | BEI | ELEI | ALIASA | ALIASN/N24 | DMN |
|------|------|-----|------|--------|------------|-----|
|------|------|-----|------|--------|------------|-----|



|            |             |     |      |             |             |     |
|------------|-------------|-----|------|-------------|-------------|-----|
| s-4-002-0  | -----       | no  | ---  | 010-001-001 | s-08228-aa  | SS7 |
| s-2-020-0  | dstn21      | no  | ---  | -----       | -----       | SS7 |
| s-2-020-1  | dstn22      | no  | ---  | 002-020-001 | -----       | SS7 |
| s-2-020-2  | dstn23      | no  | ---  | -----       | 04258-aa    | SS7 |
| s-2-020-3  | dstn24      | no  | ---  | -----       | s-04259-aa  | SS7 |
| s-2-070-3  | tgtitui003  | no  | ---  | -----       | -----       | SS7 |
| s-2-020-4  | dstn25      | no  | ---  | -----       | 002-020-004 | SS7 |
| s-2-020-5  | dstn26      | no  | ---  | 002-020-005 | 04261-aa    | SS7 |
| s-2-020-6  | dstn27      | no  | ---  | 002-020-006 | s-04262-aa  | SS7 |
| s-2-020-7  | dstn28      | no  | ---  | 002-020-007 | 002-020-007 | SS7 |
| s-2-070-4  | tgtitui004  | no  | ---  | -----       | -----       | SS7 |
| s-3-070-3  | tgtitui007  | no  | ---  | -----       | -----       | SS7 |
| s-3-070-4  | tgtitui008  | no  | ---  | -----       | -----       | SS7 |
| s-2-029-6  | rtxroute002 | no  | ---  | 002-029-006 | s-04269-aa  | SS7 |
|            |             |     |      |             |             |     |
| DPCI       | CLLI        | BEI | ELEI | ALIASI      | ALIASN/N24  | DMN |
| s-3-040-2  | dstn35      | no  | ---  | 3-040-2     | -----       | SS7 |
| s-3-040-3  | dstn36      | no  | ---  | 3-040-3     | 06467-aa    | SS7 |
| s-3-040-4  | dstn37      | no  | ---  | 3-040-4     | s-06468-aa  | SS7 |
| s-3-040-5  | dstn38      | no  | ---  | 3-040-5     | 003-040-005 | SS7 |
|            |             |     |      |             |             |     |
| DPCI       | CLLI        | BEI | ELEI | ALIASN      | ALIASN      | DMN |
| s-3-040-6  | dstn39      | no  | ---  | s-06471-aa  | 06471-aa    | SS7 |
| s-3-040-7  | dstn40      | no  | ---  | 06472-aa    | s-06472-aa  | SS7 |
|            |             |     |      |             |             |     |
| DPCN       | CLLI        | BEI | ELEI | ALIASA      | ALIASI      | DMN |
| s-08272-aa | dstn49      | no  | ---  | -----       | -----       | SS7 |
| s-08273-aa | dstn50      | no  | ---  | 004-010-001 | -----       | SS7 |
| s-08274-aa | dstn51      | no  | ---  | -----       | 4-010-2     | SS7 |
| s-08275-aa | dstn52      | no  | ---  | -----       | s-4-010-3   | SS7 |
| s-08755-aa | tgtitun003  | no  | ---  | -----       | -----       | SS7 |
| s-08276-aa | dstn53      | no  | ---  | 004-010-004 | 4-010-4     | SS7 |
| s-08277-aa | dstn54      | no  | ---  | 004-010-005 | s-4-010-5   | SS7 |
| s-08756-aa | tgtitun004  | no  | ---  | -----       | -----       | SS7 |
| s-08758-aa | tgtitun006  | no  | ---  | -----       | -----       | SS7 |
| s-08273-fr | dstn50dupfr | no  | ---  | -----       | 4-006-3     | SS7 |
|            |             |     |      |             |             |     |
| DPCN       | CLLI        | BEI | ELEI | ALIASI      | ALIASI      | DMN |
| s-08278-aa | dstn55      | no  | ---  | s-4-010-6   | 4-010-6     | SS7 |
| s-08279-aa | dstn56      | no  | ---  | 4-010-7     | s-4-010-7   | SS7 |
| s-08379-aa | rtxroute003 | no  | ---  | s-4-058-7   | 4-058-7     | SS7 |
|            |             |     |      |             |             |     |
| DPCN       | CLLI        | BEI | ELEI | ALIASN      | ALIASI      | DMN |
| s-12691-aa | dstn60      | no  | ---  | 12691-aa    | -----       | SS7 |
| s-12692-aa | dstn61      | no  | ---  | 12692-aa    | 6-050-4     | SS7 |
| s-12693-aa | dstn62      | no  | ---  | 12693-aa    | s-6-050-5   | SS7 |
| s-08272-fr | dstn49dupfr | no  | ---  | 08300-fr    | -----       | SS7 |
| s-08272-tk | dstn49dupTk | no  | ---  | 08300-tk    | 4-006-7     | SS7 |

Destination table is (208 of 2000) 10% full  
 Alias table is (216 of 12000) 2% full

;

The following example specifies the **pcst=p** parameter to display only point codes with the private point code subtype prefix (p-).

**rtrv-dstn:pcst=p**

eagle10115 08-12-09 10:00:37 EST EAGLE 40.1.0

|               |         |     |      |           |            |     |
|---------------|---------|-----|------|-----------|------------|-----|
| DPCA          | CLLI    | BEI | ELEI | ALIASI    | ALIASN/N24 | DMN |
| p-001-001-001 | dstn01p | no  | ---  | -----     | -----      | SS7 |
| p-001-001-002 | dstn02p | no  | ---  | 1-011-2   | -----      | SS7 |
| p-001-001-003 | dstn03p | no  | ---  | s-1-011-3 | -----      | SS7 |
| p-001-001-004 | dstn04p | no  | ---  | -----     | 01060-aa   | SS7 |
| p-001-001-005 | dstn05p | no  | ---  | -----     | s-01061-aa | SS7 |

|               |         |     |      |             |             |     |
|---------------|---------|-----|------|-------------|-------------|-----|
| p-001-001-006 | dstn06p | no  | ---  | -----       | 001-011-006 | SS7 |
| p-001-001-007 | dstn07p | no  | ---  | 1-011-7     | 01063-aa    | SS7 |
| p-001-002-000 | dstn08p | no  | ---  | 1-012-0     | s-01064-aa  | SS7 |
| p-001-002-001 | dstn09p | no  | ---  | s-1-012-1   | 01065-aa    | SS7 |
| p-001-002-002 | dstn10p | no  | ---  | s-1-012-2   | s-01066-aa  | SS7 |
| p-001-002-003 | dstn11p | no  | ---  | 1-012-3     | 001-012-003 | SS7 |
| p-001-002-004 | dstn12p | no  | ---  | s-1-012-4   | 001-012-004 | SS7 |
|               |         |     |      |             |             |     |
| DPCI          | CLLI    | BEI | ELEI | ALIASA      | ALIASN/N24  | DMN |
| p-2-010-0     | dstn13p | no  | ---  | -----       | -----       | SS7 |
| p-2-010-1     | dstn14p | no  | ---  | 002-100-001 | -----       | SS7 |
| p-2-010-2     | dstn15p | no  | ---  | -----       | 08178-aa    | SS7 |
| p-2-010-3     | dstn16p | no  | ---  | -----       | s-08179-aa  | SS7 |
| p-2-010-4     | dstn17p | no  | ---  | -----       | 002-100-004 | SS7 |
| p-2-010-5     | dstn18p | no  | ---  | 002-100-005 | 08181-aa    | SS7 |
| p-2-010-6     | dstn19p | no  | ---  | 002-100-006 | s-08182-aa  | SS7 |
| p-2-010-7     | dstn20p | no  | ---  | 002-100-007 | 002-100-007 | SS7 |
|               |         |     |      |             |             |     |
| DPCI          | CLLI    | BEI | ELEI | ALIASI      | ALIASN/N24  | DMN |
| p-3-030-0     | dstn29p | no  | ---  | s-3-031-0   | -----       | SS7 |
| p-3-030-1     | dstn30p | no  | ---  | s-3-031-1   | 07385-aa    | SS7 |
| p-3-030-2     | dstn31p | no  | ---  | s-3-031-2   | s-07386-aa  | SS7 |
| p-3-030-3     | dstn32p | no  | ---  | s-3-031-3   | 003-031-003 | SS7 |
|               |         |     |      |             |             |     |
| DPCI          | CLLI    | BEI | ELEI | ALIASN      | ALIASN      | DMN |
| p-3-030-4     | dstn33p | no  | ---  | s-07388-aa  | 07388-aa    | SS7 |
| p-3-030-5     | dstn34p | no  | ---  | 07389-aa    | s-07389-aa  | SS7 |
|               |         |     |      |             |             |     |
| DPCN          | CLLI    | BEI | ELEI | ALIASA      | ALIASI      | DMN |
| p-08192-aa    | dstn41p | no  | ---  | -----       | -----       | SS7 |
| p-08193-aa    | dstn42p | no  | ---  | 004-200-001 | -----       | SS7 |
| p-08194-aa    | dstn43p | no  | ---  | -----       | 4-040-2     | SS7 |
| p-08195-aa    | dstn44p | no  | ---  | -----       | s-4-040-3   | SS7 |
| p-08196-aa    | dstn45p | no  | ---  | 004-200-004 | 4-040-4     | SS7 |
| p-08197-aa    | dstn46p | no  | ---  | 004-200-005 | s-4-040-5   | SS7 |
|               |         |     |      |             |             |     |
| DPCN          | CLLI    | BEI | ELEI | ALIASI      | ALIASI      | DMN |
| p-08198-aa    | dstn47p | no  | ---  | s-4-040-6   | 4-040-6     | SS7 |
| p-08199-aa    | dstn48p | no  | ---  | 4-040-7     | s-4-040-7   | SS7 |
|               |         |     |      |             |             |     |
| DPCN          | CLLI    | BEI | ELEI | ALIASN      | ALIASI      | DMN |
| p-12688-aa    | dstn57p | no  | ---  | s-13688-aa  | -----       | SS7 |
| p-12689-aa    | dstn58p | no  | ---  | s-13689-aa  | 6-060-1     | SS7 |
| p-12690-aa    | dstn59p | no  | ---  | s-13690-aa  | s-6-060-2   | SS7 |
|               |         |     |      |             |             |     |
| DPCN24        | CLLI    | BEI | ELEI | ALIASA      | ALIASI      | DMN |
| p-006-005-001 | dstn63p | no  | ---  | -----       | -----       | SS7 |
| p-006-005-002 | dstn64p | no  | ---  | 006-005-020 | -----       | SS7 |
| p-006-005-003 | dstn65p | no  | ---  | -----       | 6-050-3     | SS7 |
| p-006-005-004 | dstn66p | no  | ---  | -----       | s-6-050-4   | SS7 |
| p-006-005-005 | dstn67p | no  | ---  | 006-005-050 | 6-050-5     | SS7 |

Destination table is (208 of 2000) 10% full  
 Alias table is (216 of 12000) 2% full

;  
 The following example displays only point codes with the private and spare point code subtype prefix (ps-).

**rtrv-dstn:pcst=ps**

eagle10115 08-12-09 10:00:37 EST EAGLE 40.1.0

|            |         |     |      |             |            |     |
|------------|---------|-----|------|-------------|------------|-----|
| DPCI       | CLLI    | BEI | ELEI | ALIASA      | ALIASN/N24 | DMN |
| ps-2-020-0 | dstn21p | no  | ---  | -----       | -----      | SS7 |
| ps-2-020-1 | dstn22p | no  | ---  | 002-200-001 | -----      | SS7 |

```

ps-2-020-2      dstn23p      no --- ----- 08258-aa      SS7
ps-2-020-3      dstn24p      no --- ----- s-08259-aa      SS7
ps-2-020-4      dstn25p      no --- ----- 002-200-004     SS7
ps-2-020-5      dstn26p      no --- ----- -----          SS7
ps-2-020-6      dstn27p      no --- 002-200-005 08261-aa      SS7
ps-2-020-7      dstn28p      no --- 002-200-007 002-200-007   SS7

      DPCI      CLLI      BEI  ELEI  ALIASI      ALIASN/N24  DMN
ps-3-040-2      dstn35p      no --- 3-041-2      -----          SS7
ps-3-040-3      dstn36p      no --- 3-041-3      07467-aa      SS7
ps-3-040-4      dstn37p      no --- 3-041-4      s-07468-aa     SS7
ps-3-040-5      dstn38p      no --- 3-041-5      003-041-005   SS7

      DPCI      CLLI      BEI  ELEI  ALIASN      ALIASN      DMN
ps-3-040-6      dstn39p      no --- s-07471-aa     07471-aa      SS7
ps-3-040-7      dstn40p      no --- 07472-aa      s-07472-aa     SS7

      DPCN      CLLI      BEI  ELEI  ALIASA      ALIASI      DMN
ps-08272-aa     dstn49p      no --- ----- -----          SS7
ps-08273-aa     dstn50p      no --- 004-200-010   -----          SS7
ps-08274-aa     dstn51p      no --- ----- 4-050-2        SS7
ps-08275-aa     dstn52p      no --- ----- s-4-050-3      SS7
ps-08276-aa     dstn53p      no --- 004-200-040 4-050-4        SS7
ps-08277-aa     dstn54p      no --- 004-200-050 s-4-050-5      SS7

      DPCN      CLLI      BEI  ELEI  ALIASI      ALIASI      DMN
ps-08278-aa     dstn55p      no --- s-4-050-6     4-050-6        SS7
ps-08279-aa     dstn56p      no --- 4-050-7      s-4-050-7      SS7

      DPCN      CLLI      BEI  ELEI  ALIASN      ALIASI      DMN
ps-12691-aa     dstn60p      no --- 13691-aa     -----          SS7
ps-12692-aa     dstn61p      no --- 13692-aa     6-060-4        SS7
ps-12693-aa     dstn62p      no --- 13693-aa     s-6-060-5      SS7

```

Destination table is (208 of 2000) 10% full  
Alias table is (216 of 12000) 2% full

;

The following example appears when an ANSI destination point code with a single SPC assigned to it is requested.

**rtrv-dstn:dpca=1-56-5**

```

eagle10115 09-08-09 10:00:37 EST EAGLE 41.1.0

      DPCA      CLLI      BEI  ELEI  ALIASI      ALIASN/N24  DMN
001-056-005   ----- no --- 1-056-2      16000        SS7

      SPC      NCAI      RCAUSE  NPRST  SPLITIAM  HMSMSC  HMSCP
----- no      none      off      none      no      no

```

Destination table is (12 of 2000) 1% full  
Alias table is (4 of 12000) 1% full

;

The following example displays the 24-bit ITU-N destination point code(s) assigned to the 24-bit ITU-N secondary point code.

**rtrv-dstn:spcn24=6-5-0**

```

eagle10115 08-12-09 10:00:37 EST EAGLE 40.1.0

SPCN24 = 006-005-000

      DPCN24     CLLI      BEI  ELEI  ALIASA      ALIASI      DMN
003-003-004   ----- no --- 003-003-003 3-003-4      SS7
006-005-001   dstn63     no --- ----- -----          SS7

```

|               |            |    |     |             |           |     |
|---------------|------------|----|-----|-------------|-----------|-----|
| p-006-005-001 | dstn63p    | no | --- | -----       | -----     | SS7 |
| 006-005-002   | dstn64     | no | --- | 006-005-002 | -----     | SS7 |
| p-006-005-002 | dstn64p    | no | --- | 006-005-020 | -----     | SS7 |
| 006-005-003   | dstn65     | no | --- | -----       | 6-005-3   | SS7 |
| p-006-005-003 | dstn65p    | no | --- | -----       | 6-050-3   | SS7 |
| 006-070-001   | tgtitun24a | no | --- | -----       | -----     | SS7 |
| 006-005-004   | dstn66     | no | --- | -----       | s-6-005-4 | SS7 |
| p-006-005-004 | dstn66p    | no | --- | -----       | s-6-050-4 | SS7 |
| 006-005-005   | dstn67     | no | --- | 006-005-005 | 6-005-5   | SS7 |
| p-006-005-005 | dstn67p    | no | --- | 006-005-050 | 6-050-5   | SS7 |
| 006-070-002   | tgtitun24b | no | --- | -----       | -----     | SS7 |

Destination table is (208 of 2000) 10% full  
 Alias table is (216 of 12000) 2% full

The following example displays a summary report that shows all point code destinations that are members of the given network 40-\*\*-\*. This does not include the specified network routing point code 40-\*\*-\*.

**rtrv-dstn:dpc=40-\*\*-\***

eagle10115 08-12-09 10:00:37 EST EAGLE 40.1.0

| DPCA        | CLLI        | BEI | ELEI | ALIASI | ALIASN/N24 | DMN |
|-------------|-------------|-----|------|--------|------------|-----|
| 040-001-*   | mycaibeno   | no  | no   | -----  | -----      | SS7 |
| 040-010-*   | mycaibeno2  | no  | no   | -----  | -----      | SS7 |
| 040-001-001 | noncluster1 | no  | ---  | -----  | -----      | SS7 |
| 040-001-002 | noncluster2 | no  | ---  | -----  | -----      | SS7 |

Destination table is (211 of 2000) 11% full  
 Alias table is (216 of 12000) 2% full

The following example shows summary output when proxy point code destinations are present in the table.

**rtrv-dstn**

eagle10115 08-12-09 10:00:37 EST EAGLE 40.1.0

| DPCA        | CLLI  | BEI | ELEI | ALIASI | ALIASN/N24 | DMN |
|-------------|-------|-----|------|--------|------------|-----|
| 002-002-002 | ----- | no  | ---  | -----  | -----      | SS7 |
| 001-001-001 | ----- | no  | ---  | -----  | -----      | SS7 |
| 001-001-002 | ----- | no  | ---  | -----  | -----      | SS7 |
| 001-001-003 | ----- | no  | ---  | -----  | -----      | SS7 |
| 001-001-004 | ----- | no  | ---  | -----  | -----      | SS7 |
| 001-001-005 | ----- | no  | ---  | -----  | -----      | SS7 |
| 001-001-006 | ----- | no  | ---  | -----  | -----      | SS7 |
| 001-001-007 | ----- | no  | ---  | -----  | -----      | SS7 |
| 001-001-008 | ----- | no  | ---  | -----  | -----      | SS7 |
| 001-001-009 | ----- | no  | ---  | -----  | -----      | SS7 |
| 001-001-010 | ----- | no  | ---  | -----  | -----      | SS7 |

Destination table is (11 of 2000) 1% full  
 Alias table is (0 of 12000) 0% full  
 PPC table is (1 of 10) 10% full

The following example displays information for a destination that references a proxy point code.

**rtrv-dstn:dpc=1-1-1**

eagle10115 09-08-09 10:00:37 EST EAGLE 41.1.0

| DPCA        | CLLI  | BEI | ELEI | ALIASI | ALIASN/N24 | DMN |
|-------------|-------|-----|------|--------|------------|-----|
| 001-001-001 | ----- | no  | ---  | -----  | -----      | SS7 |

| PPCA | NCAI | RCAUSE | NPRST | SPLITIAM | HMSMSC | HMSCP |
|------|------|--------|-------|----------|--------|-------|
|------|------|--------|-------|----------|--------|-------|

```
002-002-002 ---- none off none no no
```

```
Destination table is (30 of 2000) 2% full
Alias table is (0 of 12000) 0% full
PPC table is (1 of 100) 10% full
```

;

The following example displays summary information for all destinations using a specified proxy point code.

**rtrv-dstn:ppc=2-2-2**

```
eagle10115 08-12-09 10:00:37 EST EAGLE 40.1.0
```

```
PPCA = 002-002-002
```

| DPCA        | CLLI  | BEI | ELEI | ALIASI | ALIASN/N24 | DMN |
|-------------|-------|-----|------|--------|------------|-----|
| 001-001-001 | ----- | no  | ---  | -----  | -----      | SS7 |
| 001-001-002 | ----- | no  | ---  | -----  | -----      | SS7 |
| 001-001-003 | ----- | no  | ---  | -----  | -----      | SS7 |
| 001-001-004 | ----- | no  | ---  | -----  | -----      | SS7 |
| 001-001-005 | ----- | no  | ---  | -----  | -----      | SS7 |
| 001-001-006 | ----- | no  | ---  | -----  | -----      | SS7 |
| 001-001-007 | ----- | no  | ---  | -----  | -----      | SS7 |
| 001-001-008 | ----- | no  | ---  | -----  | -----      | SS7 |
| 001-001-009 | ----- | no  | ---  | -----  | -----      | SS7 |
| 001-001-010 | ----- | no  | ---  | -----  | -----      | SS7 |

```
Destination table is (11 of 2000) 1% full
Alias table is (0 of 12000) 0% full
PPC table is (1 of 10) 10% full
```

;

The following example displays summary information for all of the proxy destinations.

**rtrv-dstn:prx=yes**

```
eagle10115 08-12-09 10:00:37 EST EAGLE 40.1.0
```

```
PRX = yes
```

| DPCA        | CLLI  | BEI | ELEI | ALIASI | ALIASN/N24 | DMN |
|-------------|-------|-----|------|--------|------------|-----|
| 001-001-001 | ----- | no  | ---  | -----  | -----      | SS7 |
| 001-001-002 | ----- | no  | ---  | -----  | -----      | SS7 |
| 001-001-003 | ----- | no  | ---  | -----  | -----      | SS7 |
| 001-001-004 | ----- | no  | ---  | -----  | -----      | SS7 |

```
Destination table is (17 of 2000) 1% full
Alias table is (0 of 12000) 0% full
PPC table is (4 of 10) 40% full
```

;

The following example shows output for a specific destination point code when the Proxy Point Code feature is turned on and the destination point code refers to a secondary point code. The **homesmsc** and **homescp** flags are provisioned.

**rtrv-dstn:dpc=3-3-3**

```
eagle10115 09-08-09 10:00:37 EST EAGLE 41.1.0
```

| DPCA        | CLLI  | BEI | ELEI | ALIASI | ALIASN/N24 | DMN |
|-------------|-------|-----|------|--------|------------|-----|
| 003-003-003 | ----- | no  | ---  | -----  | -----      | SS7 |

| SPCA        | NCAI | RCAUSE | NPRST | SPLITIAM | HMSMSC | HMSCP |
|-------------|------|--------|-------|----------|--------|-------|
| 009-009-009 | ---- | none   | off   | none     | yes    | yes   |

```
Destination table is (4 of 2000) 1% full
Alias table is (0 of 12000) 0% full
PPC table is (2 of 10) 20% full
```

;

The following example displays the ITUN destination point code(s) within a spare group code, while the ITUDUPPC feature is on and the STP flexible point code option (**npcfnti**) is set to the 4-member ITUN point format to (*m1-m2-m3-m4-gc*).

**rtrv-dstn:dpcn=s-\*\*-\*\*-fr**

```
eagle10115 08-12-09 10:00:37 EST EAGLE 40.1.0

      DPCN          CLLI          BEI ELEI  ALIASA          ALIASI          DMN
s-1034-0-0-1-fr dstn50dupfr no  --- -----          4-006-3          SS7

      DPCN          CLLI          BEI ELEI  ALIASN          ALIASI          DMN
s-1034-0-0-0-fr dstn49dupfr no  ---  1037-1-0-0-fr -----          SS7

Destination table is (208 of 2000) 10% full
Alias table is (216 of 12000) 2% full
```

;

The following example displays output when the **rcause** and **nprst** parameters are provisioned.

**rtrv-dstn:dpci=1-1-1**

```
eagle10115 09-08-09 10:00:37 EST EAGLE 41.1.0

      DPCI          CLLI          BEI ELEI  ALIASA          ALIASN/N24      DMN
1-001-1          ----- no  ---  001-001-001      16000          SS7

      SPCI          NCAI          RCAUSE          NPRST          SPLITIAM      HMSMSC      HMSCP
-----          no           5              on           none          no          no

Destination table is (12 of 2000) 1% full
Alias table is (4 of 12000) 1% full
```

;

The following example displays output for destinations where IAM/SAM splitting is provisioned.

**rtrv-dstn:splitiam=20**

```
tklc1191001 09-04-28 07:25:13 EST EAGLE5 41.0.0

      DPCA          CLLI          BEI ELEI  ALIASI          ALIASN/N24      DMN

      DPCI          CLLI          BEI ELEI  ALIASA          ALIASN/N24      DMN
1-001-1          ----- no  ---  001-001-001      -----          SS7

      DPCN          CLLI          BEI ELEI  ALIASA          ALIASI          DMN

      DPCN24        CLLI          BEI ELEI  ALIASA          ALIASI          DMN

DESTINATION ENTRIES ALLOCATED:  8000
  FULL DPC(s):                   864
  EXCEPTION DPC(s):              5184
  NETWORK DPC(s):                 0
  CLUSTER DPC(s):                 0
  TOTAL DPC(s):                   6048
  CAPACITY (% FULL):              76%
ALIASES ALLOCATED:                8000
  ALIASES USED:                   1511
  CAPACITY (% FULL):              19%
X-LIST ENTRIES ALLOCATED:         500
```

;

**Legend**

**DPC/DPCA/DPCI/DPCN/DPCN24**—Destination point code

**CLLI**—Command Language Location Indicator

**BEI**—Broadcast Exception Indicator  
**ELEI**—Cluster Exception-List Exclusion Indicator  
**NCAI**—Nested Cluster Allowed Indicator  
**ALIASA/ALIASI/ALIASN/ALIASN24**—Alias point code  
**SPC**—Secondary point code  
**DMN**—Destination Entity Domain  
**PPC**—Proxy Point Code  
**PRX**—Proxy Point Code Indicator  
**RCAUSE**—Release Cause  
**NPRST**—NM Bits Reset  
**SPLITIAM**—IAM/SAM Split  
**HOMESMSC**—Home SMSC  
**HOMESCP**—Home SCP

## rtrv-e1

## Retrieve E1 Information

Use this command to retrieve information for a specified E1 interface or for all E1 interfaces that have been defined by the **ent-e1** command for an E1/T1 MIM MIM card, or an HC-MIM or E5-E1T1 card used as an E1 or SE-HSL card.

**NOTE: The following information can be retrieved: card location, E1 port number, CRC4, CAS/CCS, encoding/decoding, channel bridging, timing source, international NFAS data, national NFAS data, and link class with minimum signal unit rate for unchannelized links.**

**Keyword:** rtrv-e1

**Related Commands:** chg-e1, dlt-e1, ent-e1, tst-e1

**Command Class:** Database Administration

### Parameters

**:e1port=** (optional)

E1 port number

The value must be an E1 port that has already been configured with an E1 interface on the specified E1 card (**loc** parameter).

**Range:** 1-8

Ports 3 - 8 can be specified only for HC-MIM and E5-E1T1 cards.

**Default:** If not specified, all E1 ports are listed.

**:loc=** (optional)

The card location as stenciled on the shelf of the system.

**Range:** 1101-1108, 1111-1112, 1201-1208, 1211-1218, 1301-1308, 1311-1318, 2101-2108, 2111-2118, 2201-2208, 2211-2218, 2301-2308, 2311-2318, 3101-3108, 3111-3118, 3201-3208, 3211-3218, 3301-3308, 3311-3318, 4101-4108, 4111-4118, 4201-4208, 4211-4218, 4301-4308, 4311-4318, 5101-5108, 5111-5118, 5201-5208, 5211-5218, 5301-5308, 5311-5318, 6101-6108, 6111-6118

**Default:** If not specified, all E1 card locations are listed.

### Example

```
rtrv-e1
```

```
rtrv-e1:loc=1307:e1port=2
```

```
rtrv-e1:loc=1311:e1port=1
```

### Dependencies

The **loc** and **e1port** parameters must be specified together in the command.

The E1 interface of the E1 card specified by the **loc** parameter must already be defined (see the **ent-e1** command) before this command can be entered.

The card specified by the **loc** parameter must be a **lime1** card type (see the **ent-card** command).

An E1 interface must already be defined on the port specified by the **e1port** parameter before this command can be entered.

### Notes

None.



**Output**

The following example shows HC-MIM cards used as E1 cards. Cards with CHANBRDG=MASTER or CHANBRDG=SLAVE have 2 ports configured in channel bridging mode to allow non-signaling data pass-through.

**rtrv-e1**

```
rlghncxa03w 05-01-20 09:07:58 EST EAGLE5 33.0.0
E1
LOC  PORT  CRC4  CAS  ENCODE  E1TSEL  SI  SN  CHANBRDG  CLASS  RATE
1307  7      ON    OFF  HDB3    LINE    0  0  -----  CHAN  ----
1307  8      ON    OFF  HDB3    LINE    0  0  -----  CHAN  ----
1311  1      OFF   OFF  AMI     EXTERNAL 3  6  MASTER  CHAN  ----
1311  2      OFF   OFF  AMI     EXTERNAL 3  6  SLAVE   CHAN  ----
1311  5      OFF   OFF  AMI     RECOVERED 3  6  MASTER  CHAN  ----
1311  6      OFF   OFF  AMI     RECOVERED 3  6  SLAVE   CHAN  ----
;
```

The following example shows time slot entries (TSx) for the E1 card.

**rtrv-e1:loc=1307:e1port=7**

```
rlghncxa03w 05-01-20 09:07:58 EST EAGLE5 33.0.0
E1
LOC  PORT  CRC4  CAS  ENCODE  E1TSEL  SI  SN  CHANBRDG  CLASS  RATE
1307  7      ON    OFF  HDB3    LINE    0  0  -----  CHAN  ----

TS0  (N/A)  TS8  -----  TS16  -----  TS24  -----
TS1  -----  TS9  -----  TS17  -----  TS25  -----
TS2  -----  TS10 -----  TS18  -----  TS26  -----
TS3  -----  TS11 -----  TS19  -----  TS27  -----
TS4  -----  TS12 1307,A  TS20  -----  TS28  -----
TS5  -----  TS13 -----  TS21  -----  TS29  -----
TS6  -----  TS14 -----  TS22  -----  TS30  -----
TS7  -----  TS15 -----  TS23  -----  TS31  -----
;
```

The following example shows information for port 7 for the E1 card in card location 1311. Port 8 is channel bridged with port 7 on this card for non-signaling data pass through.

**rtrv-e1:loc=1311:e1port=7**

```
rlghncxa03w 05-01-20 09:07:58 EST EAGLE5 33.0.0
E1
LOC  PORT  CRC4  CAS  ENCODE  E1TSEL  SI  SN  CHANBRDG  CLASS  RATE
1311  7      OFF   OFF  AMI     EXTERNAL 3  6  MASTER  CHAN  ----

TS0  (N/A)  TS8  -----  TS16  -----  TS24  -----
TS1  -----  TS9  -----  TS17  1311,B31  TS25  -----
TS2  -----  TS10 -----  TS18  -----  TS26  -----
TS3  -----  TS11 -----  TS19  -----  TS27  -----
TS4  -----  TS12 1311,A  TS20  -----  TS28  -----
TS5  -----  TS13 -----  TS21  1311,A24  TS29  -----
TS6  -----  TS14 -----  TS22  -----  TS30  -----
TS7  -----  TS15 -----  TS23  -----  TS31  -----
;
```

The following example shows information for port 8 for the E1 card in card location 1311. Port 8 is channel bridged with port 7 on this card for non-signaling data pass through.

**rtrv-e1:loc=1311:e1port=8**

```
rlghncxa03w 05-01-20 09:07:58 EST EAGLE5 33.0.0
E1
LOC  PORT  CRC4  CAS  ENCODE  E1TSEL  SI  SN  CHANBRDG  CLASS  RATE
1311  8      OFF   OFF  AMI     EXTERNAL 3  6  SLAVE   CHAN  ----
```

;

The following example shows information for the card in location 1307, which has an SE-HSL link. Time slot entries (TSx) are not shown for cards with SE-HSL links because time slots are not configured for "unchannelized" cards.

**rtrv-e1:loc=1307:e1port=7**

```
rlghncxa03w 05-05-20 09:07:58 EST EAGLE5 34.0.0
      E1
      LOC  PORT  CRC4  CAS  ENCODE  E1TSEL  SI  SN  CHANBRDG  LINK  MINSU
      1307  7    ON   ---  HDB3   LINE    -- --  -----  UNCHAN 1000
```

;

The following example shows HC-MIM cards used as E1 cards. Cards with LINKCLASS=UNCHAN have SE-HSL links.

**rtrv-e1**

```
rlghncxa03w 05-01-20 09:07:58 EST EAGLE5 34.0.0
      E1
      LOC  PORT  CRC4  CAS  ENCODE  E1TSEL  SI  SN  CHANBRDG  LINK  MINSU
      1307  7    ON   ---  HDB3   LINE    -- --  -----  UNCHAN 1000
      1307  8    ON   ---  HDB3   LINE    -- --  -----  UNCHAN 2000
      1311  1    OFF  ON   AMI    LINE    1  1  -----  CHAN   ----
```

;

**Legend**

**LOC**—E1 card location in an EAGLE 5 ISS shelf.

**E1PORT**—E1 port number on an E1 card.

**CRC4**—CRC4 indicator.

**CAS**—CAS/CRC indicator (**on** = CAS is used; **off** = CRC is used).

**ENCODE**—Indicator for use of HDB3 or AMI encoding/decoding.

**E1TSEL**—E1 timing source indicator (**external** = master timing source; **line** = slave timing source; **recovered** = the timing source for the even-numbered port in a channel bridged pair is recovered from the odd-numbered port of the pair.)

**SI**—Value of two Spare International bits of NFAS data.

**SN**—Value of five Spare National bits of NFAS data.

**CHANBRDG**—Indicates whether an odd numbered port is not channel bridged with its adjacent even numbered port for non-signaling data pass through (dashes), or the port is the odd-numbered channel bridged port on the card (MASTER), or the port is the even-numbered channel bridged port on the card (SLAVE) on an HC-MIM or E5-E1T1 card.

**LINKCLASS**—Indicates whether an HC-MIM or E5-E1T1 card is used as a "channelized" E1 Card (CHAN) or an "unchannelized" SE-HSL card (UNCHAN).

**MINSURATE**—Minimum number of signaling units present on a link uniformly distributed. A value appears in this field only when the LINKCLASS field value is UNCHAN.

**TSx**—Timeslot.

**rtrv-eisopts****Retrieve EAGLE Support for Integrated Sentinel Options**

Use this command to retrieve the status of the copy functions for the EAGLE 5 Integrated Monitoring Support (E5IS) feature.

**Keyword:** rtrv-eisopts  
**Related Commands:** chg-eisopts  
**Command Class:** Security Administration

### Parameters

This command has no parameters.

### Example

```
rtrv-eisopts
```

### Dependencies

The EAGLE 5 Integrated Monitoring Support (E5IS) feature must be turned on before this command can be entered.

### Notes

None

### Output

```
rtrv-eisopts
rlghncxa03w 08-12-11 10:07:58 EST EAGLE 40.1.0
rtrv-eisopts
EIS OPTIONS
-----
EISCOPY = ON
FCMODE  = FCOPY
;
```

## rtrv-feat

## Retrieve Feature

Use this command to show the status of optional features in the system that are controlled with the **chg-feat** command.

**Keyword:** rtrv-feat  
**Related Commands:** chg-feat  
**Command Class:** Program Update

### Parameters

This command has no parameters.

### Example

```
rtrv-feat
```

### Dependencies

### Notes

None

**Output**

**CAUTION:** The following output example may differ from the output shown at your terminal and may include unsupported features. A feature must be purchased before you turn the feature on. If you are not sure whether you have purchased a feature, contact your Tekelec Sales Representative or Account Representative. After you turn on a feature with the `chg-feat` command, you cannot turn it off.

**rtrv-feat**

```
tekelecstp 08-06-30 16:50:04 EST EAGLE 38.0.0
EAGLE FEATURE LIST

GTT      = off    GWS      = off    NRT      = off
X25G     = off    LAN      = off    CRMD     = off
SEAS     = off    LFS      = off    MTPRS    = off
FAN      = off    DSTN5000 = off    WNP      = off
CNCF     = off    TLNP     = off    SCCPCNV  = off
TCAPCNV  = off    IPISUP   = off    X252000  = off
PLNP     = off    NCR      = off    ITUMTPRS = off
SLSOCB   = off    EGTT     = off    VGTT     = off
MPC      = off    ITUDUPPC = off    MEASPLAT = off
TSCSYNC  = off    E5IS     = off
```

;

**Legend**

**GTT**—The Global Title Translation feature

**GWS**—The Gateway Screening feature

**NRT**—Network Routing feature

**X25G**—The X.25/SS7 Gateway feature

**LAN**—The STPLAN feature

**CRMD**—The Cluster Routing and Management Diversity feature

**SEAS**—The Signaling Engineering Administration System feature

**LFS**—The Link Fault Sectionalization feature

**MTPRS**—The ANSI MTP Restart feature

**FAN**—The Cooling Fan feature

**DSTN5000**—The DSTN5000 (5000 Routes) feature

**WNP**—The Wireless Number Portability feature

**CNCF**—The Calling Name Conversion Facility with Redirect Capability feature

**TLNP**—The Triggerless Local Number Portability feature

**IPISUP**—The ISUP Routing over IP feature

**DYNRTK**—The Dynamic Routing Key feature

**SCCPCNV**—The SCCP Conversion feature

**TCAPCNV**—The TCAP Conversion feature

**X252000**—The 2000 X.25 Routes and Destinations feature

**PLNP**—The PCS 1900 Number Portability feature

**NCR**—The Nested Cluster Routing feature

**ITUMTPRS**—The ITU MTP Restart feature

**SLSOCB**—The Other CIC Bit Used feature

**EGTT**—The Enhanced Global Title Translation feature  
**VGTT**—The Variable Length GTT feature  
**MPC**—The Multiple Point Code feature  
**ITUDUPPC**—The ITU National Duplicate Point Code feature  
**TSCSYNC**—The Time Slot Counter Synchronization (TSC) feature  
**E5IS**—The EAGLE 5 Integrated Monitoring Support feature  
**MEASPLAT**—The Measurements Platform feature

**rtrv-frm-pwr****Retrieve Frame Power Threshold**

Use this command to retrieve a list of entries for all provisioned frames or the entry for the specified frame from the Frame Power Threshold (FPT) table. The command displays only provisioned entries for provisioned frames.

**Keyword:** rtrv-frm-pwr

**Related Commands:** chg-frm-pwr, dlt-frm-pwr, ent-frm-pwr, rtrv-stp

**Command Class:** Database Administration

**Parameters**

**:frm=** (optional)

Frame ID. The command displays the FPT table entry for the specified provisioned frame.

**Range:** cf00, ef00, ef01, ef02, ef03, ef04

cf00 — Control frame

ef00 — First extension frame

ef01 — Second extension frame

ef02 — Third extension frame

ef03 — Fourth extension frame

ef04 — Fifth extension frame

**Example**

Retrieve all provisioned Frame Power Threshold table entries.

```
rtrv-frm-pwr
```

Retrieve Frame Power Threshold table entries for the control frame (frm=cf00)..

```
rtrv-frm-pwr :frm=cf00
```

**Dependencies**

The **frm** parameter value must specify a provisioned frame.

The **frm** parameter value must specify a frame that has a Frame Power Threshold entry provisioned in the FPT table.

**Notes**

If no parameter is specified in the command, all provisioned FPT table entries are displayed.

If the frm parameter is specified, the FPT entry corresponding to the specified frame is displayed.

**Output**

Retrieve all Frame Power Threshold table entries.

**rtrv-frm-pwr**

```
tekelecstp 06-04-11 12:38:01 EST EAGLE 35.0.0
```

| Frame | Power Threshold (Amps) |
|-------|------------------------|
| ----  | -----                  |
| cf00  | 56                     |
| ef00  | 36                     |
| ef01  | 40                     |

```
FRAME POWER THRESHOLD table is (3 of 10) 30% full;
RTRV-FRM-PWR: MASP A - COMPLTD
```

```
;
```

Retrieve the Frame Power Threshold table entry for the control shelf only.

**rtrv-frm-pwr:frm=cf00**

```
tekelecstp 06-04-11 12:38:01 EST EAGLE 35.0.0
```

| Frame | Power Threshold (Amps) |
|-------|------------------------|
| ----  | -----                  |
| cf00  | 56                     |

```
FRAME POWER THRESHOLD table is (3 of 10) 30% full;
RTRV-FRM-PWR: MASP A - COMPLTD
```

```
;
```

**rtrv-ftp-serv****Retrieve FTP Server Entry**

Use this command to retrieve an entry for an FTP server from the FTP Server table or all entries in the FTP Server table.

**Keyword:** rtrv-ftp-serv

**Related Commands:** chg-ftp-serv, dlt-ftp-serv, ent-ftp-serv

**Command Class:** Database Administration

**Parameters**

**:app=** (optional)

Application. This parameter specifies the FTP Client application that interfaces with the FTP Server.

**Range:** meas, user, db, dist

**meas** — Measurements Platform application

**user** — FTP-based Table Retrieve Application (FTRA)

**db** — Database Backup/Restore application

**dist** — EAGLE 5 ISS Software Release Distribution application

**:ipaddr=** (optional)

IP Address of the FTP Server.

**Range:** 4 numbers separated by dots, with each number in the range of **0-255**.

**:mode=** (optional)

Full or brief report indicator.

**Range:** full, brief

**Default:** brief

**Example**

```
rtrv-ftp-serv
```

```
rtrv-ftp-serv:app=meas:ipaddr=1.255.0.100
```

```
rtrv-ftp-serv:mode=brief  
rtrv-ftp-serv:app-meas  
rtrv-ftp-serv:ipaddr=1.255.0.100  
rtrv-ftp-serv:mode=full
```

### Dependencies

The **app** parameter must specify an application that uses the FTP Support feature.

The **ipaddr** parameter must specify a valid IP address for the FTP server.

The **mode** parameter allows you to display either the full 100 characters of the path string for each entry (**mode=full**), or the first 29 characters of the path string for each entry (**mode=brief**). The default is **brief**.

### Notes

The LOGIN and PATH are displayed in mixed case.

**Output**

The following examples show output when the EAGLE OA&M IP Security feature is not enabled:

**rtrv-ftp-serv:app=meas:ipaddr=1.255.0.100**

rlghncxa03w 04-02-28 11:34:04 EST EAGLE 31.3.0

| APP  | IPADDR      | LOGIN    | PRIO | PATH            |
|------|-------------|----------|------|-----------------|
| meas | 1.255.0.100 | ftpmeas3 | 3    | ~ftpmeas3\files |

FTP SERV table is (1 of 10) 10% full

;

**rtrv-ftp-serv:mode=brief**

rlghncxa03w 04-02-28 11:34:04 EST EAGLE 31.3.0

| APP  | IPADDR      | LOGIN       | PRIO | PATH                  |
|------|-------------|-------------|------|-----------------------|
| meas | 1.255.0.100 | ftpmeas3    | 3    | ~ftpmeas3\files       |
| meas | 1.255.0.101 | ftpmeas2    | 2    | \home\ftpmeas2\public |
| user | 1.255.0.100 | tekiperson1 | 1    | \share                |

FTP SERV table is (3 of 10) 20% full

;

**rtrv-ftp-serv:app=meas**

rlghncxa03w 04-02-28 11:34:04 EST EAGLE 31.3.0.

| APP  | IPADDR      | LOGIN    | PRIO | PATH                  |
|------|-------------|----------|------|-----------------------|
| meas | 1.255.0.100 | ftpmeas3 | 3    | ~ftpmeas3\files       |
| meas | 1.255.0.101 | ftpmeas2 | 2    | \home\ftpmeas2\public |

FTP SERV table is (2 of 10) 20% full

;

**rtrv-ftp-serv:ipaddr=1.255.0.100**

rlghncxa03w 04-02-28 11:34:04 EST EAGLE 31.3.0.

| APP  | IPADDR      | LOGIN       | PRIO | PATH            |
|------|-------------|-------------|------|-----------------|
| meas | 1.255.0.100 | ftpmeas3    | 3    | ~ftpmeas3\files |
| user | 1.255.0.100 | tekiperson1 | 1    | \share          |

FTP SERV table is (2 of 10) 20% full

;

**rtrv-ftp-serv:mode=full**

rlghncxa03w 04-02-28 11:34:04 EST EAGLE 31.3.0.

| APP  | IPADDR      | LOGIN       | PRIO | PATH                                                                                             |
|------|-------------|-------------|------|--------------------------------------------------------------------------------------------------|
| meas | 1.255.0.100 | ftpmeas3    | 3    | ~ftpmeas3\files                                                                                  |
| meas | 1.255.0.101 | ftpmeas2    | 5    | \tmp\measurements\backup\data\path\that\goes\on\and\on\and\on\and\keeps\on scrolling\to\new\line |
| user | 1.255.0.100 | tekiperson1 | 1    | \share                                                                                           |



```
FTP SERV table is (3 of 10) 30% full
;
```

The following example shows output when the EAGLE OA&M IP Security feature is enabled and turned off:

**rtrv-ftp-serv:mode=full**

```
tekelecstp 04-07-15 12:41:58 EST EAGLE 31.6.0
FTP Client Security: OFF

APP          IPADDR          LOGIN          PRIO
-----
meas         1.255.0.100     ftpmeas3      3
  Path:      ~ftpmeas3/files
meas         1.255.0.101     ftpmeas2      5
  Path:      /tmp/measurements/backup/data/path/that/goes/on/and/on/and/on/and/
             keeps/on/scrolling/to/new/line
user         1.255.0.100     tekperson1    1
  Path:      \share

FTP SERV table is (3 of 10) 30% full
```

```
;
```

The following example shows output when the EAGLE OA&M IP Security feature is turned on:

**rtrv-ftp-serv:mode=full**

```
tekelecstp 04-07-15 12:41:58 EST EAGLE 31.6.0
FTP Client Security: ON

APP          IPADDR          LOGIN          PRIO
-----
meas         1.255.0.100     ftpmeas3      3
  Path:      ~ftpmeas3/files
meas         1.255.0.101     ftpmeas2      5
  Path:      /tmp/measurements/backup/data/path/that/goes/on/and/on/and/on/and/
             keeps/on/scrolling/to/new/line
user         1.255.0.100     tekperson1    1
  Path:      \share

FTP SERV table is (3 of 10) 30% full
```

```
;
```

**rtrv-ftp-serv**

```
tklcl1170501 08-09-23 14:36:51 EDT EAGLE5 39.2.0
FTP Client Security: ON

APP          IPADDR          LOGIN          PRIO  PATH
-----
meas         192.168.56.246  pv105          1     /tekelec/meas11705/new
meas         192.168.56.129  pv105          2     /tekelec/meas11705
dist         192.168.53.195  pvftp          1     /remote/labftp1/pvftp/dall
db           192.168.53.195  pvftp          1     /remote/labftp1/pvftp/ahol

FTP SERV table is (4 of 10) 40% full
```

```
;
```

**rtrv-gpl****Retrieve Generic Program Load**

Use this command to show the version numbers of the GPLs stored on each fixed disk or removable cartridge or drive and the system release table stored on each fixed disk

**Keyword:** **rtrv-gpl**

**Related Commands:** **act-gpl, chg-gpl, copy-gpl, rept-stat-gpl**

**Command Class:** Program Update

**Parameters**

**:gpl=** (optional)

Generic program load. This parameter specifies the GPL for which to retrieve information.

**Range:** *xyyyyyyy*

1 alphabetic character followed by up to 7 alphanumeric characters. Valid GPLs are:

**atmansi**—Used by the LIM cards to support the high-speed ATM signaling link feature

**atmhc**—Supports functionality for the E5-ATM card. The E5-ATM card runs either the ATMANSI or ATMITU application. The GPL allows the card to support up to 2 signaling links.

**atmitu**—Used by E1 ATM cards to support the high-speed E1 ATM signaling link feature

**blbepm**—Flash GPL containing the BIOS ROM image on E5-E1T1 and E5-ENET cards

**blbios**—Flash GPL containing the BIOS ROM image on HC-MIM cards that are used for E1 or T1 signaling links

**blbsmg**—Flash GPL containing the BIOS ROM image on E5-SM4G cards

**blcpld**—Flash GPL containing the bit files for the CPLD on HC-MIM, E5-E1T1, and E5-ENET cards that are used for E1 or T1 signaling links.

**bldiag6**—Flash GPL containing the diagnostic code on E5-E1T1 cards, HC-MIM cards, and E5-ENET cards

**blmcap**—Flash GPL containing a tar image with all code required on E5-MCAP cards

**blvxw6**—Flash GPL containing the VxWorks operating system on E5-E1T1 cards, HC-MIM cards, and E5-ENET cards

**blrom1**—Flash GPL containing the bootloader code for VxWorks operating system on HC-MIM cards

**bpdcn**—Used to support the flash memory Board PROM for DCM, DSM, and GPSM boards, original design

**bpdcn2**—Used to support the flash memory Board PROM for DCM and GPSM boards, revised design

**bphcap**—Used to support Board PROM for HCAP flash memory

**bphcapt**—Supports Board PROM for HCAP-T flash memory

**bphmux**—Supports Board PROM for HMUX flash memory

**bpmpl**—Supports Board PROM for MPL flash memory

**bpmlt**—Supports Board PROM for E1/T1 flash memory

**cd**—Used in the card manufacturing process.

**eoam**—Used by the GPSM-II card for enhanced OAM functions

**eroute**—Used by the STC card for EAGLE 5 Integrated Monitoring Support functions

**erthc**—Used by the E5-ENET card when the card acts as an STC card (E5-STC card) for EAGLE 5 Integrated Monitoring Support functions

**gls**—Used by TSM cards to download gateway screening to LIM cards

**glshe**—Used by E5-TSM cards to download gateway screening to LIM and SCCP cards

**hipr**—Communication software used on the High Speed IMT Packet Router (HIPR) card

**hipr2**—Communication software used on the High Speed IMT Packet Router (HIPR2) card

**imt**—Communication processor on the logical processing element (LPE)

**imtpci**—Communication software that operates the IMT bus on HC-MIM, E5-E1T1, and E5-ENET cards

**ipghc**—Used by E5-ENET cards to support TCP/IP point-to-multipoint connectivity for both ANSI and ITU point codes

**ipgwi**—Used by SSEDCCM cards for TCP/IP point-to-point connectivity for ITU point codes

**iplhc**—Used by E5-ENET cards for TCP/IP point-to-point connectivity for both ANSI and ITU point codes

**iplim**—Used by SSEDCCM cards for TCP/IP point-to-point connectivity for ANSI point codes

**iplimi**—Used by SSEDCCM cards for TCP/IP point-to-point connectivity for ITU point codes

**ips**—Used by IPSM cards for the IP User Interface feature

**ipsg**—Used by E5-ENET cards to support the combined functionality of IPLIMx M2PA and IPGWx M3UA

**ipshe**—Used by E5-IPSM cards to support the IPS application

**mcp**—Used by MCPM cards for the Measurements Platform feature

**oamhc**—Used by E5-MCAP cards for enhanced OAM functions

**pldpmc1**—Flash GPL used on HC-MIM and E5-E1T1 cards for E1 and T1 signaling links

**sccphe**—Used by E5-SM4G cards to support the EPAP-based features and the LNP ELAP Configuration feature. If no EPAP-based or LNP ELAP Configuration feature is turned on, and if an E5-SM4G card when the card acts as an STC card (E5-STC card) for EAGLE 5 Integrated Monitoring Support functions.

**ss7hc**—Supports the functionality for HC-MIM or E5-E1T1 cards. The HC-MIM and E5-E1T1 cards run the SS7ANSI or CCS7ITU application; the GPL allows the card to support up to 64 signaling links for E1 and T1 functions.

**ss7ipgw**—Used by SSEDCCM cards to support TCP/IP point-to-multipoint connectivity

**ss7ml**—Support functionality for MPL and the E1/T1 MIM cards. MPL cards run the SS7ANSI application on a LIMDS0 card (as in the command **ent-card:type=limds0:appl=ss7ansi**); the GPL allows the card to support 8 signaling links rather than the usual 2 links for LIM cards. MPL cards support only the DS0 interface. E1/T1 MIM card runs either the SS7ANSI or CCS7ITU application; the GPL allows the card to support 8 signaling links for E1 and T1 functions.

**utility**—Used by the factory for testing, and when directed by the Customer Care Center

**vcdu**—Used in the card manufacturing process

**vsccp**—Used by Service Module cards to support the EPAP-based and the LNP ELAP Configuration features. If no EPAP-based or LNP ELAP Configuration feature is

turned on, and if a Service Module card is present, then the GPL processes normal GTT traffic.

**vxwslan**—Used by SSEDCCM cards to support the STP LAN application

**Default:** Display all

### Example

```
rtrv-gpl
rtrv-gpl:gpl=ipshc
rtrv-gpl:gpl=hipr2
rtrv-gpl:gpl=ipsg
```

### Dependencies

No other activate, change, copy, or retrieve GPL command can be in progress when this command is entered.

The value specified for the **gpl** parameter must be supported. See the **gpl** definition for a list of supported GPLs.

### Notes

To check the version of the EPAP or ELAP application, use the **rept-stat-mps** command.

If no application is specified, the approved and trial versions for all GPLS are shown, as well as the release table and removable GPL.

The approved GPL is the GPL that resides on the fixed disk and was made the approved version by specifying the GPL version number while executing the **act-gpl** command.

The trial GPL is the version of the GPL that was downloaded from the removable cartridge or drive, but not activated by the **act-gpl** command.

When the **act-gpl** command is executed, the version specified in the command becomes the approved GPL and the previously approved GPL becomes the trial GPL.

If a GPL is not found, a version of "-----" is shown. This should happen only for the utility and OAM GPL trial versions on the fixed disk and for all GPLs on the removable when the removable cartridge or drive is not inserted.

If the approved GPL version does not match the GPL version shown in the ACTIVE MASP RELEASE column, an alarm is activated.

A minor alarm is shown, and ALM is displayed for each APPROVED GPL (**rtrv-gpl**) and for each RUNNING GPL (**rept-stat-gpl**) that does not match the GPL in the RELEASE column of the **rtrv-gpl** command output. The minor alarm is not activated, but ALM is displayed for each GPL that does not match the GPL in the RELEASE column.

ALM is always displayed when the approved version does not match the release version. You cannot turn off *fixed disk auditing*. The auditing state shown here is for the **rept-stat-gpl** command. You can turn on and off *running version auditing*.

A GPL audit cannot be in progress when this command is entered.

**Output**

The following example lists all possible GPLs that can be shown in the output when no GPL is specified. All of these GPLs will not appear in the output for your system, because all GPLs are not valid in the same system.

\* The entries marked with an asterisk appear in the output only if an OAP is provisioned and running. Systems that use two OAPs will show two entries for the OAP: OAP A and OAP B.

**rtrv-gpl**

e1080402 09-06-10 15:16:33 EST EAGLE 41.1.0

| GPL     | CARD | RELEASE     | APPROVED    | TRIAL       | REMOVE TRIAL |
|---------|------|-------------|-------------|-------------|--------------|
| EOAM    | 1114 | 128-003-000 | 128-003-000 | 128-003-000 | 128-003-000  |
| EOAM    | 1116 | 128-003-000 | 128-003-000 | -----       | -----        |
| SCCP    | 1114 | 128-002-000 | 128-002-000 | 128-002-000 | 128-002-000  |
| SCCP    | 1116 | 128-002-000 | 128-002-000 | 128-002-000 | -----        |
| GLS     | 1114 | 128-002-000 | 128-002-000 | 128-002-000 | 128-002-000  |
| GLS     | 1116 | 128-002-000 | 128-002-000 | 128-002-000 | -----        |
| CDU     | 1114 | 128-000-000 | 128-000-000 | 128-000-000 | 128-002-000  |
| CDU     | 1116 | 128-000-000 | 128-000-000 | 128-002-000 | -----        |
| STPLAN  | 1114 | 128-001-000 | 128-001-000 | 125-001-000 | 128-001-000  |
| STPLAN  | 1116 | 128-001-000 | 128-001-000 | 125-001-000 | -----        |
| IMT     | 1114 | 128-001-000 | 128-001-000 | 125-001-000 | 128-001-000  |
| IMT     | 1116 | 128-001-000 | 128-001-000 | 125-001-000 | -----        |
| ATMANSI | 1114 | 128-002-000 | 128-002-000 | 125-002-000 | 128-002-000  |
| ATMANSI | 1116 | 128-002-000 | 128-002-000 | 128-002-000 | -----        |
| BPHCAP  | 1114 | 128-001-000 | 128-001-000 | 128-001-000 | 128-001-000  |
| BPHCAP  | 1116 | 128-001-000 | 128-001-000 | 128-001-000 | -----        |
| BPDCM   | 1114 | 128-001-000 | 128-001-000 | 128-001-000 | 128-001-000  |
| BPDCM   | 1116 | 128-001-000 | 128-001-000 | 128-001-000 | -----        |
| VXWSLAN | 1114 | 128-001-000 | 128-001-000 | 128-001-000 | 128-001-000  |
| VXWSLAN | 1116 | 128-001-000 | 128-001-000 | 128-001-000 | -----        |
| IPLIM   | 1114 | 128-002-000 | 128-002-000 | 128-002-000 | 128-002-000  |
| IPLIM   | 1116 | 128-002-000 | 128-002-000 | 128-002-000 | -----        |
| IPLIMI  | 1114 | 128-002-000 | 128-002-000 | 128-002-000 | 128-002-000  |
| IPLIMI  | 1116 | 128-002-000 | 128-002-000 | 128-002-000 | -----        |
| SS7IPGW | 1114 | 128-002-000 | 128-002-000 | 128-002-000 | 128-002-000  |
| SS7IPGW | 1116 | 128-002-000 | 128-002-000 | 128-002-000 | -----        |
| VSCCP   | 1114 | 128-002-000 | 128-002-000 | 128-002-000 | 128-002-000  |
| VSCCP   | 1116 | 128-002-000 | 128-002-000 | 128-002-000 | -----        |
| ATMITU  | 1114 | 128-001-000 | 128-001-000 | 128-001-000 | 128-001-000  |
| ATMITU  | 1116 | 128-001-000 | 128-001-000 | 128-001-000 | -----        |
| VCDU    | 1114 | 128-000-000 | 128-000-000 | 128-000-000 | 128-002-000  |
| VCDU    | 1116 | 128-000-000 | 128-000-000 | 128-002-000 | -----        |
| BP MPL  | 1114 | 128-001-000 | 128-001-000 | 128-001-000 | 128-001-000  |
| BP MPL  | 1116 | 128-001-000 | 128-001-000 | 128-001-000 | -----        |
| SS7ML   | 1114 | 128-001-000 | 128-001-000 | 128-001-000 | 128-001-000  |
| SS7ML   | 1116 | 128-001-000 | 128-001-000 | 128-001-000 | -----        |
| BPHMUX  | 1114 | 128-001-000 | 128-005-000 | 128-005-000 | 128-005-000  |
| BPHMUX  | 1116 | 128-001-000 | 128-005-000 | 128-005-000 | -----        |
| IPGWI   | 1114 | 128-001-000 | 128-001-000 | 128-001-000 | 128-001-000  |
| IPGWI   | 1116 | 128-001-000 | 128-001-000 | 128-001-000 | -----        |
| IPS     | 1114 | 128-001-000 | 128-001-000 | 128-001-000 | 128-001-000  |
| IPS     | 1116 | 128-001-000 | 128-001-000 | 128-001-000 | -----        |
| EROUTE  | 1114 | 128-001-000 | 128-001-000 | 128-001-000 | 128-001-000  |
| EROUTE  | 1116 | 125-001-000 | 128-001-000 | 128-001-000 | -----        |
| BP MPLT | 1114 | 002-103-001 | 002-103-001 | 002-103-001 | 128-001-000  |
| BP MPLT | 1116 | 002-103-001 | 002-103-001 | 002-103-001 | -----        |
| MCP     | 1114 | 128-001-000 | 128-001-000 | 128-001-000 | 128-001-000  |
| MCP     | 1116 | 128-001-000 | 128-001-000 | 128-001-000 | -----        |
| BPHCAPT | 1114 | 128-116-003 | 002-116-003 | 002-116-003 | 128-001-000  |
| BPHCAPT | 1116 | 002-116-003 | 002-116-003 | 002-116-003 | -----        |
| HIPR    | 1114 | 128-001-000 | 128-005-000 | 125-005-000 | 128-005-000  |

|         |      |             |             |             |                         |
|---------|------|-------------|-------------|-------------|-------------------------|
| HIPR    | 1116 | 128-001-000 | 128-005-000 | 125-005-000 | -----                   |
| SS7HC   | 1114 | 128-001-000 | 128-001-000 | 125-001-000 | 128-001-000             |
| SS7HC   | 1116 | 128-001-000 | 128-001-000 | 125-001-000 | -----                   |
| BLBIOS  | 1114 | 128-001-000 | 128-001-000 | 125-001-000 | -----                   |
| BLBIOS  | 1116 | 128-001-000 | 128-001-000 | 125-001-000 | 128-001-000             |
| BLCPLD  | 1114 | 128-001-000 | 128-001-000 | 125-001-000 | 128-001-000             |
| BLCPLD  | 1116 | 128-001-000 | 128-001-000 | 128-001-000 | -----                   |
| IMTPCI  | 1114 | 128-001-000 | 125-001-000 | 128-001-000 | 128-001-000             |
| IMTPCI  | 1116 | 128-001-000 | 125-001-000 | 128-001-000 | -----                   |
| PLDPMC1 | 1114 | 128-001-000 | 125-001-000 | 128-001-000 | 125-001-000             |
| PLDPMC1 | 1116 | 128-001-000 | 125-001-000 | 128-001-000 | -----                   |
| OAP*    | A    | 128-001-000 | 125-001-000 | -----       | 128-002-000             |
| OAP*    | B    | 128-001-000 | 125-002-000 | ALM         | -----                   |
| IPLHC   | 1114 | 097-003-000 | 097-003-000 | 028-003-011 | 097-003-000             |
| IPLHC   | 1116 | 097-003-000 | 097-003-000 | 028-003-011 | -----                   |
| IPGHC   | 1114 | 097-003-000 | 097-003-009 | ALM         | 097-003-001 097-003-009 |
| IPGHC   | 1116 | 097-003-000 | 097-003-009 | ALM         | 097-003-001             |
| BLBEPM  | 1114 | 126-005-000 | 126-005-000 | 126-005-000 | -----                   |
| BLBEPM  | 1116 | 126-005-000 | 126-005-000 | 126-005-000 | 126-005-000             |
| BLVXW6  | 1114 | 126-005-000 | 126-005-000 | 126-005-000 | -----                   |
| BLVXW6  | 1116 | 126-005-000 | 126-005-000 | 126-005-000 | 126-005-000             |
| BLDIAG6 | 1114 | 126-005-000 | 126-005-000 | 126-005-000 | -----                   |
| BLDIAG6 | 1116 | 126-005-000 | 126-005-000 | 126-005-000 | 126-005-000             |
| IPSHC   | 1114 | 128-001-000 | 128-001-000 | 128-001-000 | -----                   |
| IPSHC   | 1116 | 128-001-000 | 128-001-000 | 128-001-000 | 128-001-000             |
| SLANHC  | 1114 | 128-002-000 | 128-002-000 | 128-002-000 | -----                   |
| SLANHC  | 1116 | 128-002-000 | 128-002-000 | 128-002-000 | 128-002-000             |
| ERTHC   | 1114 | 128-002-000 | 128-002-000 | 128-002-000 | -----                   |
| ERTHC   | 1116 | 128-002-000 | 128-002-000 | 128-002-000 | 128-002-000             |
| SCCPHC  | 1114 | 128-019-000 | 128-019-000 | 128-019-000 | -----                   |
| SCCPHC  | 1116 | 128-019-000 | 128-019-000 | 128-019-000 | 128-019-000             |
| BLBSMG  | 1114 | 128-007-000 | 128-007-000 | 128-007-000 | -----                   |
| BLBSMG  | 1116 | 128-007-000 | 128-007-000 | 128-007-000 | 128-007-000             |
| HIPR2   | 1114 | 128-022-000 | 128-022-000 | 128-022-000 | 128-022-000             |
| HIPR2   | 1116 | 128-022-000 | 128-022-000 | 128-022-000 | -----                   |

;  
In the following example, card location 1115 is the active MASP and the cartridge is inserted.

**rtrv-gpl:gpl=utility**

```
rlghncxa03w 04-01-05 11:34:04 EST EAGLE 31.3.0
GPL Auditing ON
```

| GPL     | CARD | RELEASE     | APPROVED    | TRIAL | REMOVE TRIAL |
|---------|------|-------------|-------------|-------|--------------|
| UTILITY | 1114 | 101-016-000 | 101-016-000 | ----- | -----        |
| UTILITY | 1116 | 101-016-000 | 101-016-000 | ----- | 101-016-000  |

;  
When a GPL is specified in this command, the output is in the following format. The specified GPL is shown in the GPL column.

**rtrv-gpl:gpl=hipr**

```
rlghncxa03w 05-01-04 07:01:08 EST EAGLE5 33.0.0
GPL Auditing ON
```

| GPL  | CARD | RELEASE     | APPROVED    | TRIAL       | REMOVE TRIAL |
|------|------|-------------|-------------|-------------|--------------|
| HIPR | 1114 | 118-020-000 | 118-020-000 | 118-020-000 | 118-020-000  |
| HIPR | 1116 | 118-020-000 | 118-020-000 | 118-020-000 | -----        |

;  
The following example shows output for an E5-SM4G card.

**rtrv-gpl:gpl=sccphc**

```
tklc1110501 07-04-12 17:27:27 EST EAGLE5 37.0.0
GPL Auditing ON
```

| GPL    | CARD | RELEASE     | APPROVED    | TRIAL       | REMOVE TRIAL |
|--------|------|-------------|-------------|-------------|--------------|
| SCCPHC | 1114 | 128-015-000 | 128-015-000 | 128-015-000 | -----        |
| SCCPHC | 1116 | 128-015-000 | 128-015-000 | 128-015-000 | 128-015-000  |

;  
The following example shows the output for HIPR2 GPL.

```
rtrv-gpl:gpl=hipr2
rlghncxa03w 07-10-04 07:01:08 EST EAGLE5 38.0.0
GPL Auditing ON
```

| GPL   | CARD | RELEASE     | APPROVED    | TRIAL       | REMOVE TRIAL |
|-------|------|-------------|-------------|-------------|--------------|
| HIPR2 | 1114 | 128-022-000 | 128-022-000 | 128-022-000 | 128-022-000  |
| HIPR2 | 1116 | 128-022-000 | 128-022-000 | 128-022-000 | -----        |

;  
This following example shows output with the E5-based control cards feature. In this example, a removable drive and credit card USB are inserted in the active OAM. A removable drive is not present in the standby OAM removable drive.

```
rtrv-gpl:gpl=oamhc
e5oam 08-12-01 12:25:26 EST EAGLE 40.1.0
GPL Auditing ON
```

| GPL   | CARD | RELEASE     | APPROVED    | TRIAL       | REMOVE TRIAL |
|-------|------|-------------|-------------|-------------|--------------|
| OAMHC | 1114 | 030-010-000 | 030-010-000 | 030-010-008 | -----        |
| OAMHC | 1116 | 030-010-000 | 030-010-000 | 030-010-008 | 030-010-008  |
| OAMHC | 1115 | -----       | -----       | -----       | 030-010-008  |

;  
The following example shows output for E5-based control cards. All three removable drives that display version information are inserted, including the removable drive in the active OAM, the credit card drive in the active OAM, and the removable drive in the standby OAM.

```
rtrv-gpl
e5oam 08-12-01 12:24:57 EST EAGLE 40.1.0
GPL Auditing ON
```

| GPL     | CARD | RELEASE     | APPROVED    | TRIAL       | REMOVE TRIAL |
|---------|------|-------------|-------------|-------------|--------------|
| EOAM    | 1114 | 030-010-000 | 030-010-000 | 030-010-000 | 030-010-000  |
| EOAM    | 1116 | 030-010-000 | 030-010-000 | 030-010-000 | 030-010-000  |
| EOAM    | 1115 | -----       | -----       | -----       | 030-010-000  |
| SS7ANSI | 1114 | 030-010-000 | 030-010-000 | 030-010-000 | 030-010-000  |
| SS7ANSI | 1116 | 030-010-000 | 030-010-000 | 030-010-000 | 030-010-000  |
| SS7ANSI | 1115 | -----       | -----       | -----       | 030-010-000  |
| SCCP    | 1114 | 030-010-000 | 030-010-000 | 030-010-000 | 030-010-000  |
| SCCP    | 1116 | 030-010-000 | 030-010-000 | 030-010-000 | 030-010-000  |
| SCCP    | 1115 | -----       | -----       | -----       | 030-010-000  |
| GLS     | 1114 | 030-010-000 | 030-010-000 | 030-010-000 | 030-010-000  |
| GLS     | 1116 | 030-010-000 | 030-010-000 | 030-010-000 | 030-010-000  |
| GLS     | 1115 | -----       | -----       | -----       | 030-010-000  |
| ...     |      |             |             |             |              |
| IPSG    | 1114 | 030-010-000 | 030-010-000 | 030-010-000 | 030-010-000  |
| IPSG    | 1116 | 030-010-000 | 030-010-000 | 030-010-000 | 030-010-000  |
| IPSG    | 1115 | -----       | -----       | -----       | 030-010-000  |
| BLROM1  | 1114 | 030-010-000 | 030-010-000 | 030-010-000 | 030-010-000  |
| BLROM1  | 1116 | 030-010-000 | 030-010-000 | 030-010-000 | 030-010-000  |
| BLROM1  | 1115 | -----       | -----       | -----       | 030-010-000  |

**Legend**

- GPL**—The type of GPL associated with each card in the display
- APPROVED**—The GPL version that is the approved GPL.
- CARD**—The card location.

**RELEASE**—version number of each GPL that is required to be installed and approved for a specific release of software for the system.

**REMOVE TRIAL**—The GPL version that is on the removable cartridge or drive.

**TRIAL**—The GPL version that is the trial GPL.

-----GPL is not present at the specified location.

**ALM**—An alarm indicator showing that the system has an approved GPL that is not the GPL required for this software release according to the active MASP system release table.

**CORRUPTED**—Data audit has determined that the GPL is corrupted.

## rtrv-gserv-data

## Retrieve G-Port Query for Prepaid Service Data

Use this command to display all values in the GSERV table or to display specific translation type, originating point code, or global title address data. These values are used to determine whether a Send Routing Information (SRI) request should receive G-Port SRI Query for Prepaid service or normal G-Port service.

**Keyword:** rtrv-gserv-data

**Related Commands:** dlt-gserv-data, ent-gserv-data

**Command Class:** Database Administration

### Parameters

**NOTE:** See "Point Code Formats and Conversion" for a detailed description of point code formats, rules for specification, and examples.

**:display=** (optional)

Use this parameter to display a specified category of entries in the GSERV table.

**Range:** all, gta, opc, tt

**all**— Display all entries in the GSERV table.

**gta**— Display all calling party (CgPA) global title addresses in the GSERV table.

**opc**— Display all message transfer part (MTP) originating point codes in the GSERV table.

**tt**— Display all called party (CdPA) translation types in the GSERV table.

**:gta=** (optional)

Global title address. Use this parameter to specify a CgPA global title address.

**Range:** 1-21 digits

**:opc=** (optional)

ANSI originating point code in the form of *network indicator-network cluster-network cluster member (ni-nc-ncm)*. The *prefix* subfield indicates a private point code *prefix-ni-nc-ncm*.

**Synonym:** opca

**Range:** p-, 000-255

Specify a valid value for each subfield of the point code, and separate the subfields with a dash (-).

*prefix*—p-

When **chg-sid:pctype=ansi** is specified, *ni = 000* is not valid.

When **chg-sid:pctype=ansi** is specified, *nc = 000* is not valid if *ni = 001-005*.

When **chg-sid:pctype=ansi** is specified, *nc = 000* is valid if *ni = 006-255*.

The point code **000-000-000** is not a valid point code.

**:opc/opca/opci/open/open24=** (optional)

Originating point code. Use these parameters to specify MTP originating point codes.



**:opci=** (optional)

ITU international originating point code with subfields *zone-area-id*.

**Range:** **s-, p-, ps-, 0-255**

Specify a valid value for each subfield of the point code, and separate the subfields with a dash (-).

*prefix*—**s-, p-, ps-**

*zone*—**0-7**

*area*—**000-255**

*id*—**0-7**

The point code **0-000-0** is not a valid point code.

**:opcn=** (optional)

ITU national originating point code in the format of a 5-digit number (*nnnnn*); or 2, 3, or 4 numbers (members) separated by dashes (*m1-m2-m3-m4*) as defined by the **chg-stpopts:npcfmti** flexible point code option. A group code must be specified when the ITUDUPPC feature is turned on (*nnnnn-gc, m1-m2-m3-m4-gc*).

**Range:** **s-, p-, ps-, 0-16383, aa-zz**

Specify a valid value for each subfield of the point code, and separate the subfields with a dash (-).

*prefix*—**s-, p-, ps-**

*nnnnn*—**0-16383**

*gc*—**aa-zz**

*m1-m2-m3-m4*—**0-14** for each member; values must sum to 14

**:opcn24=** (optional)

24-bit ITU national originating point code with subfields *main signaling area-sub signaling area-signaling point* (*msa-ssa-sp*).

**Range:** **p-, 000-255**

Specify a valid value for each subfield of the point code, and separate the subfields with a dash (-).

*prefix*—**p-**

*msa*—**000-255**

*ssa*—**000-255**

*sp*—**000-255**

**:tt=** (optional)

Translation type. Use this parameter to specify a CdPA translation type.

**Range:** **0-255**

**Example**

```
rtrv-gserv-data:display=all
```

```
rtrv-gserv-data:tt=26
```

```
rtrv-gserv-data:display=opc
```

**Dependencies**

The G-Port SRI Query for Prepaid feature must be enabled before this command can be entered.

The G-Port feature must be on before this command can be entered.

The **gta**, **opc/opca/opci/opcn/opcn24**, **tt**, or **display** parameter must be specified.

The **display**, **tt**, **opc**, and **gta** parameters cannot be specified together in the command.

**Output**

```

rtrv-gserv-data:display=all
mystp 06-07-27 20:32:46 EST  EAGLE 35.2.0
TT      OPC                      GTA
=====
0
25
26

TT      OPC                      GTA
=====
          02057          (ITUN)
          002-002-002    (ANSI)
          5-005-5       (ITUI)
          001-001-001    (ANSI)
          006-000-001    (ANSI)

TT      OPC                      GTA
=====
                                     9194605500

num of tt entries is (3 of 256)
num of opc entries is (5 of 50)
num of gta entries is (1 of 50)

GSERV table is (9 of 356) 3% full

;

rtrv-gserv-data:tt=26
mystp 06-07-27 20:35:57 EST  EAGLE 35.2.0
TT      OPC                      GTA
=====
26

;

rtrv-gserv-data:display=opc
mystp 06-07-27 20:32:46 EST  EAGLE 35.2.0
TT      OPC                      GTA
=====
          02057          (ITUN)
          002-002-002    (ANSI)
          5-005-5       (ITUI)
          001-001-001    (ANSI)
          006-000-001    (ANSI)

GSERV table is (5 of 50) 10% full

;

```

**rtrv-gsm-msg****Retrieve Configured GSM Message**

Use this command to display the configured GSM test message parameter values.

**Keyword:** rtrv-gsm-msg

**Related Commands:** chg-gsm-msg, tst-msg

**Command Class:** Database Administration

**Parameters**

**:msgn=** (mandatory)

Message number. This parameter specifies the test message number that is retrieved.

**Range:** 1-10

### Example

```
rtrv-gsm-msg:msgn=5
```

### Dependencies

### Output

```
rtrv-gsm-msg:msgn=1
tekelecstp 08-12-02 10:46:51 EST EAGLE 40.1.0
MSG = 1                ACTIVE = YES

CGPA_GT = 2
CGPA_GT_NAI = 4        CGPA = 919818000001

CDPA_GT = 2
CDPA_GT_NAI = 4        CDPA = 919818000002

CGPN_NAI = 1
CGPN_NP = 2           CGPN = 919818000007

CDPN_NAI = 1
CDPN_NP = 2           CDPN = 919818000008
```

## rtrv-gsmmap-scrn

## Retrieve GSM MAP Screening Entry

Use this command to retrieve the GSM (Global System for Mobile Telecommunication) MAP (Mobile Application Part) Screening CgPA and CdPA entries and their attributes from the active system database.

**Keyword:** rtrv-gsmmap-scrn

**Related Commands:** chg-gsmmap-scrn, dlt-gsmmap-scrn, ent-gsmmap-scrn

**Command Class:** Database Administration

### Parameters

**:opname=** (mandatory)

The user-defined name for the operation code. The **opname** value references the operation code (**opcode**) defined with the **ent-gsms-opcode** command.

**Range:** ayyyyyy  
Up to 8 alphanumeric characters

**:action=** (optional)

The screening action to take if a message is forbidden as defined by the **forbid** parameter.

**Range:** pass, discard, atierr, route, forward, duplicate, dupdisc

**pass**— Route the message as normal to the destination.

**discard**— The MSU is to be discarded.

**atierr**— An ATI (Any Time Interrogation) reject message is generated. This option is only valid for ATI MAP operation codes.

**route**— Route the message as normal to the original destination node; no UIM will be generated. The original destination is the node to which normal GTT would be sent if no GSM MAP actions are taken.

**forward**— Route the original message to the forward node. The original message will not be sent to the original node. If, however, the forward node is not available for routing, the MSU is routed to the original node.

**duplicate**— Route the message as normal to the original destination and route a copy of the original message to the duplicate node. If the MSU fails to route to the duplicate node, a UIM is generated indicating the duplicate routing failure.

**dupdisc**— Route the original message to the duplicate node. The original message will not be sent to the original node. If, however, the duplicate node is not available for routing, the MSU is routed to the original node.

**Default:** Display all screening actions

**:cdsr=** (optional)

CdPA Screening Reference.

**Range:** *ayyy*

1 alphabetic character followed by up to 3 optional alphanumeric characters

**:cgsr=** (optional)

CgPA Screening Reference.

**Range:** *ayyy*

1 alphabetic character followed by up to 3 optional alphanumeric characters

**:eaddr=** (optional)

The ending origination address, in association with **npv** and **naiv** for the CGPA address to be screened.

**Range:** 1-15 digits

1–15 hexadecimal digits. Valid digits are **0–9, a-f, A-F**

**:forbid=** (optional)

The forbidden parameter value. Indicates a forbidden parameter for the entered address. If a forbidden parameter is detected the message is rejected by the action defined by the **action** parameter.

**Range:** **all, location, none, state**

**all**—All parameters are forbidden. Take the specified screening action defined by the **action** parameter for messages arriving at the system.

**location**—Take the specified screening action defined by the **action** parameter for messages arriving at the system that contain **location** as the forbidden parameter value for the entered address/operation code combination. Note: The **location** value is valid only for GSM ATI messages.

**none**—None of the parameters are forbidden. Route the message to its destination.

**state**—Take the specified screening action defined by the **action** parameter for messages arriving at the system that contain **state** as the forbidden parameter value for the entered address/operation code combination. Note: The **state** value is valid only for GSM ATI messages.

**Default:** Display all forbidden parameter values

**:mapset=** (optional)

The MAP set ID.

**Range:** **1-36000 dflt**

**dflt**—Default MAP set

**:naiv=** (optional)

Nature of Address value for the address or range of CgPA and CdPA addresses. When this parameter is specified, the **npv** parameter must be specified.

**Range:** **0-127, \***

**:npv=** (optional)

Numbering Plan value for the address or range of CgPA and CdPA addresses.

When this parameter is specified, the **naiv** parameter must be specified.

**Range:** **0-15 \***

**:ri=** (optional)

Routing indicator. This parameter specifies whether a subsequent global title translation is required.

**Range:** **gt, ssn**

**:saddr=** (optional)

The starting origination address. in association with **npv** and **naiv** for the single entry or range of entries of the CGPA address to be screened.

**Range:** 1-15 digits, \*

1–15 hexadecimal digits. Valid digits are **0–9, a-f, and A-F**

**Default:** \*

**:tt=** (optional)

Translation type. This parameter specifies the value that the CdPA translation type is set to as the result of Enhanced GSM Map Screening.

**Range:** **0-255 none**

**Default:** Display all translation types

### Example

The following example retrieves all CgPA entries for the specified opname:

```
rtrv-gsmmap-scrn:opname=e
```

The following example retrieves the specified CgPA range entry for the specified opname:

```
rtrv-gsmmap-  
scrn:opname=ati:saddr=919462000000000:eaddr=919463000000000
```

The following example retrieves all CdPA entries for the specified cgsr:

```
rtrv-gsmmap-scrn:opname=xyz:cgsr=fela
```

The following example retrieves the specified cdsr entry for the specified cgsr:

```
rtrv-gsmmap-scrn:opname=xyz:cgsr=fela:cdsr=cal4
```

The following examples retrieves the specified RI for the specified opname:

```
rtrv-gsmmap-scrn:opname=e:ri=ssn
```

```
rtrv-gsmmap-scrn:opname=e:ri=gt
```

```
rtrv-gsmmap-scrn:opname=e:mapset=dflt:ri=gt
```

```
rtrv-gsmmap-scrn:opname=rr:cgsr=au:cdsr=aj
```

```
rtrv-gsmmap-scrn:opname=dd:cgsr=ak
```

```
rtrv-gsmmap-scrn:opname=test4:tt=12
```

### Dependencies

The GSM Map Screening feature (see the **enable-ctrl-feat** command) must be enabled before this command can be entered.

The Enhanced GSM Map Screening (EGMS) feature must be enabled before:

- The **cgsr** parameter can be specified.
- The **cdsr** parameter can be specified.
- The **saddr=\*** parameter can be specified.
- The **saddr** and **eaddr** parameters can contain hexadecimal digits.

The specified **opname** parameter value must exist in the GSM Map Op-Code table.

If the **eaddr** parameter is specified, its value must contain the same number of digits as the **saddr** parameter value.

If the **eaddr** parameter is specified, its value must be greater than the **saddr** parameter value.

If the **eaddr** parameter is specified, the **saddr** parameter must be specified.

If the **saddr=\*** parameter is specified, then the **eaddr** parameter cannot be specified.

If the **saddr** parameter is specified, the **cgsr** and **cdsr** parameters cannot be specified.

The **saddr**, **npv**, and **naiv** parameters must be specified together in the command.

If any of the **saddr/eaddr/npv/naiv** and **cdsr** parameters are specified, then the **forbid** and **action** parameters cannot be specified.

A value of **state** or **location** cannot be specified for the **forbid** parameter unless the operation code referenced by the **opname** parameter is **71**. The **forbid** option is only valid for ATI MAP operation codes, and the **opcode=71** parameter signifies an ATI MAP operation code.

The **action=atierr** parameter cannot be specified unless the operation code referenced by the **opname** parameter is **71**. The **atierr** option is only valid for ATI MAP operation codes, and the **opcode=71** parameter signifies an ATI MAP operation code.

If the **cdsr** parameter is specified, then the **cgsr** parameter must be specified.

The specified **cgsr** parameter value must exist in the database.

The specified **cdsr** parameter value must exist in the database.

The Flexible GTT Load Sharing feature must be enabled before the **mapset** parameter can be specified.

The specified MAP set must exist.

## Notes

None

Output

GSM MAP Screening single entries and range entries shown in separate sections of the output. All single entries are shown first in a summary report; all range entries follow.

**rtrv-gsmmap-scrn:opname=e**

tekelecstp 08-08-22 00:33:10 EST EAGLE 39.2.0

Single CgPA Entries for OPNAME: e

-----

|       |                  |             |             |    |
|-------|------------------|-------------|-------------|----|
| SADDR | NP NAI FORBD ACT | PCA         | SSN CGSR RI | TT |
| 1111  | 2 3 all fwd      | 001-001-002 | 12 ad gt    | 11 |
| SADDR | NP NAI FORBD ACT | PCI         | SSN CGSR RI | TT |
| SADDR | NP NAI FORBD ACT | PCN         | SSN CGSR RI | TT |
| SADDR | NP NAI FORBD ACT | PCN24       | SSN CGSR RI | TT |
| SADDR | NP NAI FORBD ACT | CGSR        |             |    |

Range CgPA Entries for OPNAME: e

-----

|       |       |                  |             |          |
|-------|-------|------------------|-------------|----------|
| SADDR | EADDR | NP NAI FORBD ACT | PCA         | SSN CGSR |
| 1234  | 3452  | * * all fwd      | 001-001-002 | 12 as    |
| RI=gt | TT=11 |                  |             |          |
| SADDR | EADDR | NP NAI FORBD ACT | PCI         | SSN CGSR |
| SADDR | EADDR | NP NAI FORBD ACT | PCN         | SSN CGSR |
| SADDR | EADDR | NP NAI FORBD ACT | PCN24       | SSN CGSR |
| SADDR | EADDR | NP NAI FORBD ACT | CGSR        |          |

GSM MAP Screening Table (8 of 4000) is 1% full

;

The following example shows the output when the Flexible GTT Load Sharing feature is on.

**rtrv-gsmmap-scrn:opname=dd**

tekelecstp 08-08-22 00:45:11 EST EAGLE 39.2.0

Single CgPA Entries for OPNAME: dd

-----

|       |                  |         |          |        |    |
|-------|------------------|---------|----------|--------|----|
| SADDR | NP NAI FORBD ACT | PCA     | SSN CGSR | MAPSET | RI |
| SADDR | NP NAI FORBD ACT | PCI     | SSN CGSR | MAPSET | RI |
| *     | * * all fwd      | 1-221-2 | 13 ab    | DFLT   | gt |
| TT=11 |                  |         |          |        |    |
| SADDR | NP NAI FORBD ACT | PCN     | SSN CGSR | MAPSET | RI |
| SADDR | NP NAI FORBD ACT | PCN24   | SSN CGSR | MAPSET | RI |
| SADDR | NP NAI FORBD ACT | CGSR    |          |        |    |

Range CgPA Entries for OPNAME: dd

-----

|       |       |                  |     |          |
|-------|-------|------------------|-----|----------|
| SADDR | EADDR | NP NAI FORBD ACT | PCA | SSN CGSR |
|-------|-------|------------------|-----|----------|

```
SADDR      EADDR      NP NAI FORBD ACT      PCI      SSN CGSR
1234      3452      * * all fwd      1-221-2      13 ak
MAPSET=DFLT RI=gt TT=11
```

```
SADDR      EADDR      NP NAI FORBD ACT      PCN      SSN CGSR
SADDR      EADDR      NP NAI FORBD ACT      PCN24      SSN CGSR
SADDR      EADDR      NP NAI FORBD ACT      CGSR
```

GSM MAP Screening Table (14 of 4000) is 1% full

;

The following example shows the output for a specific MAP set. The Flexible GTT Load Sharing feature is on.

**rtrv-gsmmap-scrn:opname=rr:mapset=1**

tekelecstp 08-01-22 00:59:18 EST EAGLE 38.0.0

Single CgPA Entries for OPNAME: rr

-----

```
SADDR      NP NAI FORBD ACT      PCA      SSN CGSR      MAPSET      RI
SADDR      NP NAI FORBD ACT      PCI      SSN CGSR      MAPSET      RI
SADDR      NP NAI FORBD ACT      PCN      SSN CGSR      MAPSET      RI
SADDR      NP NAI FORBD ACT      PCN24     SSN CGSR      MAPSET      RI
```

Range CgPA Entries for OPNAME: rr

-----

```
SADDR      EADDR      NP NAI FORBD ACT      PCA      SSN CGSR
1234      3452      * * all fwd      001-001-002  12 au
MAPSET=1 RI=gt TT=11
```

```
SADDR      EADDR      NP NAI FORBD ACT      PCI      SSN CGSR
SADDR      EADDR      NP NAI FORBD ACT      PCN      SSN CGSR
SADDR      EADDR      NP NAI FORBD ACT      PCN24     SSN CGSR
```

GSM MAP Screening Table (26 of 4000) is 1% full

;

The following example shows the output for the subsystem number routing indicator.

**rtrv-gsmmap-scrn:opname=e:ri=ssn**

tekelecstp 08-08-21 15:40:00 EST EAGLE 39.2.0

Single CgPA Entries for OPNAME: e

-----

```
SADDR      NP NAI FORBD ACT      PCA      SSN CGSR      RI      TT
*          * * all fwd      001-001-002  12 ad      ssn      11
SADDR      NP NAI FORBD ACT      PCI      SSN CGSR      RI      TT
SADDR      NP NAI FORBD ACT      PCN      SSN CGSR      RI      TT
SADDR      NP NAI FORBD ACT      PCN24     SSN CGSR      RI      TT
```

Range CgPA Entries for OPNAME: e



```

-----
SADDR          EADDR          NP NAI FORBD ACT      PCA          SSN CGSR
*              *              * *  all  fwd        001-001-002  12  d
RI=ssn TT=11

SADDR          EADDR          NP NAI FORBD ACT      PCI          SSN CGSR

SADDR          EADDR          NP NAI FORBD ACT      PCN          SSN CGSR

SADDR          EADDR          NP NAI FORBD ACT      PCN24        SSN CGSR

SADDR          EADDR          NP NAI FORBD ACT      CGSR

```

GSM MAP Screening Table (4 of 4000) is 1% full

;

The following example shows the output for the global translation routing indicator and a specified mapset:

**rtrv-gsmmap-scrn:opname=e:mapset=dflt:ri=gt**

tekelecstp 08-08-22 00:57:57 EST EAGLE 39.2.0

Single CgPA Entries for OPNAME: e

-----

```

SADDR          NP NAI FORBD ACT      PCA          SSN CGSR  MAPSET  RI
1111          2 3  all  fwd        001-001-002  12  ad    DFLT    gt
TT=11

SADDR          NP NAI FORBD ACT      PCI          SSN CGSR  MAPSET  RI

SADDR          NP NAI FORBD ACT      PCN          SSN CGSR  MAPSET  RI

SADDR          NP NAI FORBD ACT      PCN24        SSN CGSR  MAPSET  RI

```

Range CgPA Entries for OPNAME: e

-----

```

SADDR          EADDR          NP NAI FORBD ACT      PCA          SSN CGSR
1234          3452          * *  all  fwd        001-001-002  12  as
MAPSET=DFLT RI=gt TT=11

SADDR          EADDR          NP NAI FORBD ACT      PCI          SSN CGSR

SADDR          EADDR          NP NAI FORBD ACT      PCN          SSN CGSR

SADDR          EADDR          NP NAI FORBD ACT      PCN24        SSN CGSR

```

GSM MAP Screening Table (26 of 4000) is 1% full

;

The following example shows the output for called and calling party screening references:

**rtrv-gsmmap-scrn:opname=rr:cgsr=au:cdsr=aj**

tekelecstp 08-08-22 00:58:55 EST EAGLE 39.2.0

```

SADDR          EADDR          NP NAI FORBD ACT      PCA          SSN CDSR
1234          3452          * *  all  fwd        001-001-002  12  aj
MAPSET=1 RI=gt TT=11

```

GSM MAP Screening Table (26 of 4000) is 1% full

;

The following example shows the output for a calling party screening reference.

**rtrv-gsmmap-scrn:opname=dd:cgsr=ak**

tekelecstp 08-08-22 00:44:34 EST EAGLE 39.2.0

Single CdPA Entries for OPNAME: dd and CGSR: ak

-----

|       |                  |         |             |    |
|-------|------------------|---------|-------------|----|
| SADDR | NP NAI FORBD ACT | PCA     | SSN CDSR RI | TT |
| SADDR | NP NAI FORBD ACT | PCI     | SSN CDSR RI | TT |
| 3476  | * * all fwd      | 1-221-2 | 13 gu gt    | 11 |
| SADDR | NP NAI FORBD ACT | PCN     | SSN CDSR RI | TT |
| SADDR | NP NAI FORBD ACT | PCN24   | SSN CDSR RI | TT |
| SADDR | NP NAI FORBD ACT | CDSR    |             |    |

Range CdPA Entries for OPNAME: dd and CGSR: ak

-----

|       |       |                  |         |          |
|-------|-------|------------------|---------|----------|
| SADDR | EADDR | NP NAI FORBD ACT | PCA     | SSN CDSR |
| SADDR | EADDR | NP NAI FORBD ACT | PCI     | SSN CDSR |
| 1234  | 3452  | * * all fwd      | 1-221-2 | 13 gh    |
| RI=gt | TT=11 |                  |         |          |
| SADDR | EADDR | NP NAI FORBD ACT | PCN     | SSN CDSR |
| SADDR | EADDR | NP NAI FORBD ACT | PCN24   | SSN CDSR |
| SADDR | EADDR | NP NAI FORBD ACT | CDSR    |          |

GSM MAP Screening Table (14 of 4000) is 1% full

;

The following example shows the output for a specified translation type.

**rtrv-gsmmap-scrn:opname=test4:tt=12**

tekelecstp 08-08-18 17:26:42 EST EAGLE 39.2.0

Single CgPA Entries for OPNAME: test4

-----

|       |                  |             |          |     |    |
|-------|------------------|-------------|----------|-----|----|
| SADDR | NP NAI FORBD ACT | PCA         | SSN CGSR | RI  | TT |
| *     | * * all fwd      | 001-001-002 | 12 ad    | ssn | 12 |
| SADDR | NP NAI FORBD ACT | PCI         | SSN CGSR | RI  | TT |
| SADDR | NP NAI FORBD ACT | PCN         | SSN CGSR | RI  | TT |
| SADDR | NP NAI FORBD ACT | PCN24       | SSN CGSR | RI  | TT |
| SADDR | NP NAI FORBD ACT | CDSR        |          |     |    |

Range CgPA Entries for OPNAME: test4

-----

|        |       |                  |             |          |
|--------|-------|------------------|-------------|----------|
| SADDR  | EADDR | NP NAI FORBD ACT | PCA         | SSN CGSR |
| *      | *     | * * all fwd      | 001-001-002 | - d      |
| RI=ssn | TT=12 |                  |             |          |
| SADDR  | EADDR | NP NAI FORBD ACT | PCI         | SSN CGSR |

```
SADDR          EADDR          NP NAI FORBD ACT      PCN          SSN CGSR
SADDR          EADDR          NP NAI FORBD ACT      PCN24        SSN CGSR
SADDR          EADDR          NP NAI FORBD ACT      CGSR
```

GSM MAP Screening Table (4 of 4000) is 1% full

;

The following example shows the output for a specified translation type and a specified mapset.

**rtrv-gsmmap-scrn:opname=e:mapset=df1t:tt=12**

tekelecstp 08-01-22 00:57:57 EST EAGLE 39.2.0

Single CgPA Entries for OPNAME: e

-----

```
SADDR          NP NAI FORBD ACT      PCA          SSN CGSR      MAPSET      RI
1111          2 3 all fwd          001-001-002  12 ad         DFLT        ssn
TT=12

SADDR          NP NAI FORBD ACT      PCI          SSN CGSR      MAPSET      RI

SADDR          NP NAI FORBD ACT      PCN          SSN CGSR      MAPSET      RI

SADDR          NP NAI FORBD ACT      PCN24        SSN CGSR      MAPSET      RI
```

Range CgPA Entries for OPNAME: e

-----

```
SADDR          EADDR          NP NAI FORBD ACT      PCA          SSN CGSR
1234          3452          * * all fwd          001-001-002  12 as
MAPSET=DFLT RI=ssn TT=12

SADDR          EADDR          NP NAI FORBD ACT      PCI          SSN CGSR

SADDR          EADDR          NP NAI FORBD ACT      PCN          SSN CGSR

SADDR          EADDR          NP NAI FORBD ACT      PCN24        SSN CGSR
```

GSM MAP Screening Table (26 of 4000) is 1% full

;

**Legend**

**SINGLE ENTRIES/RANGE ENTRIES**—GSM MAP screening single entries and range entries are output in separate sections of the retrieval report. All single entries are output first during a summary report and then all range entries follow.

**CgPA**—Calling Party Address entry

**CdPA**—Called Party Address entry

**OPNAME**—User-defined MAP operation code name.

**SADDR**—Start origination address.

**EADDR**—End origination address. This column is displayed for range entries only.

**NPV**—Numbering plan value.

**NAIV**—Nature of address indicator value.

**FORBID** or **FORBD**—Indicates a forbidden parameter for the entered address. If a forbidden parameter is detected the message is rejected by the action defined by the **action** parameter. (Some values are abbreviated; for example, locat means **location**.)

**ACTION** or **ACT**—Screening action, if forbidden. Possible actions are pass, discard (disc), atierr, route, forward, duplicate (dupl), and dupdisc.

**PC** or **PCA**—ANSI Point Code

**PCI**—ITU International Point Code

**PCN**—ITU National Point Code

**PCN24**—24-bit ITU National Point Code

**SSN**—Subsystem Number

**CGSR**—CgPA Screening Reference

**CDSR**—CdPA Screening Reference

**MAPSET**—MAP set

**RI**—Routing Indicator

**TT**—Translation Type

## rtrv-gsmopts

## Retrieve GSM System Options

Use this command to display all GSM (Global System for Mobile Telecommunication) system options from the database.

**Keyword:** rtrv-gsmopts

**Related Commands:** chg-gsmopts, chg-gsmsmsopts, rtrv-gsmsmsopts

**Command Class:** Database Administration

### Parameters

This command has no parameters.

### Example

```
rtrv-gsmopts
```

### Dependencies

None

### Notes

None

Output

**rtrv-gsmopts**

tekelecstp 09-07-06 16:12:11 EST EAGLE 41.1.0  
GSM OPTIONS

```

-----
MULTCC          = 456          MULTCC          = NONE
MULTCC          = NONE        MULTCC          = NONE
MULTCC          = NONE        MULTCC          = NONE
MULTCC          = NONE        MULTCC          = NONE
MULTCC          = NONE        MULTCC          = NONE
DEFMAPVR        = 1

DEFMCC          = 123         DEFMNC          = NONE
CCNC            = 12          MCCMNC         = 3456
CCNC            = 56          MCCMNC         = 9876
CCNC            = NONE        MCCMNC         = NONE
CCNC            = NONE        MCCMNC         = NONE
CCNC            = NONE        MCCMNC         = NONE
CCNC            = NONE        MCCMNC         = NONE
CCNC            = NONE        MCCMNC         = NONE
CCNC            = NONE        MCCMNC         = NONE
CCNC            = NONE        MCCMNC         = NONE
CCNC            = NONE        MCCMNC         = NONE
CCNC            = NONE        MCCMNC         = NONE
CCNC            = NONE        MCCMNC         = NONE
CCNC            = NONE        MCCMNC         = NONE

SRIDN           = SCCP        SRIDNNOTFOUND  = GTT
MSRNDIG         = RN         MSRNNAI         = 0
MSRNNP          = 0          MSISDNTRUNC    = 0
SRFADDR         = NONE       SRFNAI         = 0
SRFNP           = 0

SERVERPFX       = NONE       GSM2IS41       = NONE
MIGRPFX        = SINGLE     IS412GSM       = 67

SPORTTYPE       = NONE       DFLTRN         = NONE

EIRGRSP         = OFF        EIRRSPTYPE     = TYPE1
EIRIMSICHK      = OFF

GFLEXMAPLAYERRTG = OFF
    
```

**rtrv-gsms-opcode**

**Retrieve GSM MAP Screening Operation Code**

Use this command to retrieve the concerned GSM (Global System for Mobile Telecommunication) MAP (Mobile Application Part) screening operation codes and the default screening action for the operation code. This command allows the craftsperson to verify a list of all operation codes or a single operation code that the system uses in performing GSM Map Screening.

**Keyword:** rtrv-gsms-opcode

**Related Commands:** chg-gsms-opcode, dlt-gsms-opcode, ent-gsms-opcode

**Command Class:** Database Administration

**Parameters**

**:mapset=** (optional)

The MAP set ID.

**Range:** 1-36000 dflt

dflt—Default MAP set

**:opcode=** (optional)

MAP operation code.

- Range:** 0-255 \*
- Default:** Display all MAP operation codes
- :opname=** (optional)  
The user-defined name for the operation code. The **opname** value is defined with the **ent-gsms-opcode** command.
- Range:** ayyyyyy  
Up to 8 alphanumeric characters
- Default:** Display all operation code names
- :ri=** (optional)  
Routing indicator. This parameter specifies whether a subsequent global title translation is required.
- Range:** gt, ssn
- :tt=** (optional)  
Translation type. This parameter specifies the value the CdPA TT is set to as the result of Enhanced GSM Map Screening.
- Range:** 0-255 none
- Default:** Display all translation types

**Example**

```
rtrv-gsms-opcode
rtrv-gsms-opcode:opname=ati
rtrv-gsms-opcode:ri=gt
rtrv-gsms-opcode:ri=ssn
rtrv-gsms-opcode:tt=11
```

**Dependencies**

The GSM Map Screening feature (see the **enable-ctrl-feat** command) must be enabled before this command can be entered.

The EGMS feature must be enabled and turned on before:

- The **opcode=\*** can be specified.
- An **opname** parameter can be specified that refers to an **opcode=\*** parameter.

The **opcode** parameter and the **opname** parameter cannot be specified together in the same command.

The specified **opname** parameter must exist in the GSM MAP Op-Code table.

The Flexible GTT Load Sharing feature must be enabled before the **mapset** parameter can be specified.

The specified MAP set must exist.

**Notes**

None

Output

**rtrv-gsms-opcode**

tekelecstp 08-08-22 00:32:17 EST EAGLE 39.2.0

| OPCODE | OPNAME | DFLTACT | PCA         | SSN | RI  | TT  |
|--------|--------|---------|-------------|-----|-----|-----|
| 15     | d      | fwd     | 001-001-002 | 12  | ssn | 11  |
| 16     | e      | fwd     | 001-001-002 | 12  | gt  | 21  |
| 19     | f      | fwd     | 001-001-002 | 12  | gt  | 14  |
| 20     | h      | fwd     | 001-001-002 | -   | gt  | 11  |
|        |        |         |             |     |     |     |
| OPCODE | OPNAME | DFLTACT | PCI         | SSN | RI  | TT  |
| 17     | dd     | fwd     | 1-221-2     | 13  | gt  | 244 |
|        |        |         |             |     |     |     |
| OPCODE | OPNAME | DFLTACT | PCN         | SSN | RI  | TT  |
|        |        |         |             |     |     |     |
| OPCODE | OPNAME | DFLTACT | PCN24       | SSN | RI  | TT  |
|        |        |         |             |     |     |     |
| OPCODE | OPNAME | DFLTACT |             |     |     |     |
| 12     | a      | disc    |             |     |     |     |
| 13     | b      | disc    |             |     |     |     |

GSMMS OPCODE Table (9 of 257) is 4% full

;

**rtrv-gsms-opcode:opname=e**

tekelecstp 08-08-22 00:32:45 EST EAGLE 39.2.0

| OPCODE | OPNAME | DFLTACT | PCA         | SSN | RI | TT |
|--------|--------|---------|-------------|-----|----|----|
| 16     | e      | fwd     | 001-001-002 | 12  | gt | 21 |

GSMMS OPCODE Table (9 of 257) is 4% full

;

The following example includes a spare point code:

**rtrv-gsms-opcode**

tekelecstp 08-08-22 00:54:42 EST EAGLE 39.2.0

| OPCODE | OPNAME | DFLTACT | PCA         | SSN | RI  | TT  |
|--------|--------|---------|-------------|-----|-----|-----|
| 15     | d      | fwd     | 001-001-002 | 12  | ssn | 11  |
| 16     | e      | fwd     | 001-001-002 | 12  | gt  | 21  |
| 19     | f      | fwd     | 001-001-002 | 12  | gt  | 14  |
| 20     | h      | fwd     | 001-001-002 | -   | gt  | 11  |
| 21     | k      | fwd     | 001-001-002 | 12  | gt  | 11  |
| 22     | t      | fwd     | 001-001-002 | -   | gt  | 128 |
| 23     | u      | fwd     | 001-001-002 | 12  | ssn | 11  |
| 39     | rr     | fwd     | 001-001-002 | 12  | ssn | 11  |
|        |        |         |             |     |     |     |
| OPCODE | OPNAME | DFLTACT | PCI         | SSN | RI  | TT  |
| 17     | dd     | fwd     | 1-221-2     | 13  | gt  | 244 |
| 31     | kk     | fwd     | 1-221-2     | 13  | ssn | 11  |
| 44     | rf     | fwd     | 1-221-2     | 13  | gt  | 11  |
|        |        |         |             |     |     |     |
| OPCODE | OPNAME | DFLTACT | PCN         | SSN | RI  | TT  |
|        |        |         |             |     |     |     |
| OPCODE | OPNAME | DFLTACT | PCN24       | SSN | RI  | TT  |
|        |        |         |             |     |     |     |
| OPCODE | OPNAME | DFLTACT |             |     |     |     |
| 12     | a      | disc    |             |     |     |     |
| 13     | b      | disc    |             |     |     |     |

GSMMS OPCODE Table (13 of 257) is 5% full

;

The following example shows the output when the Flexible GTT Load Sharing feature is on.

**rtrv-gsms-opcode**

tekelecstp 08-08-22 00:54:42 EST EAGLE 39.2.0

| OPCODE | OPNAME | DFLTACT | PCA         | SSN | MAPSET | RI  | TT  |
|--------|--------|---------|-------------|-----|--------|-----|-----|
| 15     | d      | fwd     | 001-001-002 | 12  | DFLT   | ssn | 11  |
| 16     | e      | fwd     | 001-001-002 | 12  | DFLT   | gt  | 21  |
| 19     | f      | fwd     | 001-001-002 | 12  | DFLT   | gt  | 14  |
| 20     | h      | fwd     | 001-001-002 | -   | DFLT   | gt  | 11  |
| 21     | k      | fwd     | 001-001-002 | 12  | DFLT   | gt  | 11  |
| 22     | t      | fwd     | 001-001-002 | -   | DFLT   | gt  | 128 |
| 23     | u      | fwd     | 001-001-002 | 12  | DFLT   | ssn | 11  |
| 39     | rr     | fwd     | 001-001-002 | 12  | 1      | ssn | 11  |

| OPCODE | OPNAME | DFLTACT | PCI     | SSN | MAPSET | RI  | TT  |
|--------|--------|---------|---------|-----|--------|-----|-----|
| 17     | dd     | fwd     | 1-221-2 | 13  | DFLT   | gt  | 244 |
| 31     | kk     | fwd     | 1-221-2 | 13  | DFLT   | ssn | 11  |
| 44     | rf     | fwd     | 1-221-2 | 13  | 2      | gt  | 11  |

| OPCODE | OPNAME | DFLTACT | PCN | SSN | MAPSET | RI | TT |
|--------|--------|---------|-----|-----|--------|----|----|
|        |        |         |     |     |        |    |    |

| OPCODE | OPNAME | DFLTACT | PCN24 | SSN | MAPSET | RI | TT |
|--------|--------|---------|-------|-----|--------|----|----|
|        |        |         |       |     |        |    |    |

| OPCODE | OPNAME | DFLTACT |
|--------|--------|---------|
| 12     | a      | disc    |
| 13     | b      | disc    |

GSMMS OPCODE Table (13 of 257) is 5% full

;

The following example shows output for a specific MAP set. The Flexible GTT Load Sharing feature is on.

**rtrv-gsms-opcode:mapset=2**

tekelecstp 08-08-22 00:56:01 EST EAGLE 39.2.0

| OPCODE | OPNAME | DFLTACT | PCA | SSN | MAPSET | RI | TT |
|--------|--------|---------|-----|-----|--------|----|----|
|        |        |         |     |     |        |    |    |

| OPCODE | OPNAME | DFLTACT | PCI     | SSN | MAPSET | RI | TT |
|--------|--------|---------|---------|-----|--------|----|----|
| 44     | rf     | fwd     | 1-221-2 | 13  | 2      | gt | 11 |

| OPCODE | OPNAME | DFLTACT | PCN | SSN | MAPSET | RI | TT |
|--------|--------|---------|-----|-----|--------|----|----|
|        |        |         |     |     |        |    |    |

| OPCODE | OPNAME | DFLTACT | PCN24 | SSN | MAPSET | RI | TT |
|--------|--------|---------|-------|-----|--------|----|----|
|        |        |         |       |     |        |    |    |

GSMMS OPCODE Table (13 of 257) is 5% full

;

The following example shows the output for the global translation routing indicator.

**rtrv-gsms-opcode:ri=gt**

tekelecstp 08-08-22 00:54:53 EST EAGLE 39.2.0

| OPCODE | OPNAME | DFLTACT | PCA         | SSN | RI | TT  |
|--------|--------|---------|-------------|-----|----|-----|
| 16     | e      | fwd     | 001-001-002 | 12  | gt | 21  |
| 19     | f      | fwd     | 001-001-002 | 12  | gt | 14  |
| 20     | h      | fwd     | 001-001-002 | -   | gt | 11  |
| 21     | k      | fwd     | 001-001-002 | 12  | gt | 11  |
| 22     | t      | fwd     | 001-001-002 | -   | gt | 128 |

| OPCODE | OPNAME | DFLTACT | PCI     | SSN | RI | TT  |
|--------|--------|---------|---------|-----|----|-----|
| 17     | dd     | fwd     | 1-221-2 | 13  | gt | 244 |
| 44     | rf     | fwd     | 1-221-2 | 13  | gt | 11  |

| OPCODE | OPNAME | DFLTACT | PCN | SSN | RI | TT |
|--------|--------|---------|-----|-----|----|----|
|        |        |         |     |     |    |    |

| OPCODE | OPNAME | DFLTACT | PCN24 | SSN | RI | TT |
|--------|--------|---------|-------|-----|----|----|
|        |        |         |       |     |    |    |



GSMMS OPCODE Table (13 of 257) is 5% full

;

The following example shows the output for the subsystem number routing indicator. The FGTTLS feature is enabled.

**rtrv-gsms-opcode:ri=ssn**

tekelecstp 08-08-22 00:55:03 EST EAGLE 39.2.0

| OPCODE | OPNAME | DFLTACT | PCA         | SSN | MAPSET | RI  | TT |
|--------|--------|---------|-------------|-----|--------|-----|----|
| 15     | d      | fwd     | 001-001-002 | 12  | DFLT   | ssn | 11 |
| 23     | u      | fwd     | 001-001-002 | 12  | DFLT   | ssn | 11 |
| 39     | rr     | fwd     | 001-001-002 | 12  | 1      | ssn | 11 |

| OPCODE | OPNAME | DFLTACT | PCI     | SSN | MAPSET | RI  | TT |
|--------|--------|---------|---------|-----|--------|-----|----|
| 31     | kk     | fwd     | 1-221-2 | 13  | DFLT   | ssn | 11 |

| OPCODE | OPNAME | DFLTACT | PCN | SSN | MAPSET | RI | TT |
|--------|--------|---------|-----|-----|--------|----|----|
|        |        |         |     |     |        |    |    |

| OPCODE | OPNAME | DFLTACT | PCN24 | SSN | MAPSET | RI | TT |
|--------|--------|---------|-------|-----|--------|----|----|
|        |        |         |       |     |        |    |    |

GSMMS OPCODE Table (13 of 257) is 5% full

;

The following example shows the output for a specified translation type.

**rtrv-gsms-opcode:tt=11**

tekelecstp 08-08-22 00:54:53 EST EAGLE 39.2.0

| OPCODE | OPNAME | DFLTACT | PCA         | SSN | RI  | TT |
|--------|--------|---------|-------------|-----|-----|----|
| 15     | d      | fwd     | 001-001-002 | 12  | ssn | 11 |
| 20     | h      | fwd     | 001-001-002 | -   | gt  | 11 |
| 21     | k      | fwd     | 001-001-002 | 12  | gt  | 11 |
| 22     | t      | fwd     | 001-001-002 | -   | gt  | 11 |
| 23     | u      | fwd     | 001-001-002 | 12  | ssn | 11 |
| 39     | rr     | fwd     | 001-001-002 | 12  | ssn | 11 |

| OPCODE | OPNAME | DFLTACT | PCI     | SSN | RI  | TT |
|--------|--------|---------|---------|-----|-----|----|
| 31     | kk     | fwd     | 1-221-2 | 13  | ssn | 11 |
| 44     | rf     | fwd     | 1-221-2 | 13  | gt  | 11 |

| OPCODE | OPNAME | DFLTACT | PCN | SSN | RI | TT |
|--------|--------|---------|-----|-----|----|----|
|        |        |         |     |     |    |    |

| OPCODE | OPNAME | DFLTACT | PCN24 | SSN | RI | TT |
|--------|--------|---------|-------|-----|----|----|
|        |        |         |       |     |    |    |

GSMMS OPCODE Table (13 of 257) is 5% full

;

**Legend**

**OPCODE**—MAP operation code

**OPNAME**—The user-defined name of operation code

**DFLTACT**—The default screening action

**PCA**—ANSI Point Code

**PCI**—ITU International Point Code

**PCN**—ITU National Point Code

**PCN24**—24-bit ITU National Point Code

**SSN**—Subsystem Number

**MAPSET**—MAP set

**RI**—Routing Indicator

TT—Translation Type

## rtrv-gsmsmsopts

## Retrieve GSM SMS System Options

Use this command to display all GSM SMS options from the database.

**Keyword:** rtrv-gsmsmsopts

**Related Commands:** chg-gsmopts, chg-gsmsmsopts, rtrv-gsmopts

**Command Class:** Database Administration

### Parameters

This command has no parameters.

### Example

```
rtrv-gsmsmsopts
```

### Dependencies

None.

None.

### Notes

None

### Output

```
rtrv-gsmsmsopts
```

```
tekelecstp 09-10-06 10:23:52 EST EAGLE 41.1.0
```

```
GSM SMS OPTIONS
```

```
-----
BPARTYGTTSN = NONE           MOSMSGTTDIG = SCCPCDPA
MOSMSTYPE    = SPRN           MOSMSNAI    = INTL
MOSMSSA      = NO             MOSMSFWD    = NO
MOSMSACLEN   = 0              MOSMSGTA    = NONE
MOSMSTCAPSEG = OFF            MOSMSDIGMAT = EXACT
SPORTTYPE    = NONE           SPFILL      = OFF
DEFRN        = NONE

MTSMSIMSI    = MCCRNDN        MTSMSNNI    = RN
MTSMSTYPE    = RN             MTSMSACKN   = ACK
MTSMSDLTR    = NO             MTSMSDLTRV  = NONE
MTSMSNAKERR  = 1              MTSMSCHKSRC = NO
MTMMSSTYPE   = RN             MTMMSGTA    = NONE
MTMMSACKN    = ACK            MTMMSENTYLEN = NONE
MTMMSLEN     = NONE

IGSMSRELAY   = NO             DEFIS41SMSC = NONE
IS41SMSCGTTSN = NONE
```

```
;
```

## rtrv-gsmssn-scrn

## Retrieve GSM Subsystem Number Screening Entry

Use this command to retrieve all or single subsystem numbers in the GSM SSN screening table.

**Keyword:** rtrv-gsmssn-scrn

**Related Commands:** dlt-gsmssn-scrn, ent-gsmssn-scrn

**Command Class:** Database Administration

**Parameters**

**:ssn=** (optional)  
Subsystem number.  
**Range:** 000-255  
**Default:** Display all

**:type=** (optional)  
Subsystem type.  
**Range:** **orig, dest**  
**orig**—The origination SSN  
**dest**—The destination SSN  
**Default:** Display all

**Example**

```
rtrv-gsmssn-scrn
rtrv-gsmssn-scrn:ssn=0:type=dest
```

**Dependencies**

The GSM Map Screening feature must be enabled (see the **enable-ctrl-feat** command) before this command can be entered.

**Notes**

If specified, the **ssn/type** parameter combination must exist in the GSM SSN screening table. If the value does not exist, the following message is displayed:

```
SSN ORIG DEST
No matching entries with the specified criteria found.
```

**Output**

```
rtrv-gsmssn-scrn:ssn=10:type=orig

rlghncxa03w 04-02-20 09:07:58 EST EAGLE 31.3.0
SSN ORIG DEST
010 Yes Yes
GSMMS SSN table is (256 of 512) 50% full
RTRV-GSMSSN-SCRN: MASP A - COMPLTD
;

rtrv-gsmssn-scrn

rlghncxa03w 04-02-20 09:07:58 EST EAGLE 31.3.0
SSN ORIG DEST
002 Yes No
010 Yes Yes
GSMMS SSN table is (2 of 512) 1% full
RTRV-GSMSSN-SCRN: MASP A - COMPLTD
;
```

**Legend**

**SSN**—Subsystem number.

**ORIG**—Specifies whether the subsystem type is origination (yes) or not (no).

**DEST**—Specifies whether the subsystem type is destination (yes) or not (no).

**rtrv-gta****Retrieve Global Title Address Information**

Use this command to display a list of the GTA (global title address) information applicable to the specified GTT set. This list can be filtered using a number of parameters. The report that is displayed contains two records (the percentage full and number-of-cells-used field) that give the total entries in the GTT table without regard to the selector specified.

This command obtains the routing object (destination address and subsystem number), relative cost, and routing indicator assigned to that object for specified GTAs (global title addresses) or ranges of GTAs with a given GTT set.

**NOTE: When the ANSI-ITU-China SCCP Conversion feature is enabled, entries that are provisioned with the xlat=dpc parameter, and that have specified the ntt parameter, are displayed with a xlat parameter value of dpcngt.**

**Keyword:** rtrv-gta

**Related Commands:** chg-gta, dlt-gta, ent-gta

**Command Class:** Database Administration

**Parameters**

**NOTE: See "Point Code Formats and Conversion" for a detailed description of point code formats, rules for specification, and examples.**

**NOTE: The TCAP Opcode Based Routing (TOBR) feature must be turned on before the cdssn or ecdsn parameter can be specified. A TOBR quantity feature must be turned on before the acn, family, opcode, or pkgtype parameter can be specified.**

**NOTE: The Flexible Link set Optional Based Routing (FLOBR) feature must be turned on before the testmode parameter can be specified.**

**:gttsn=** (mandatory)

GTT set name. A GTT set is an entity to which global title addresses and selectors are assigned.

**Range:** ayyyyyyyy

1 leading alphabetic and up to 8 following alphanumeric characters.

**:acn=** (optional)

Application context name. This parameter specifies the ITU TCAP *acn* field in the incoming MSU.

**Range:** 0-255 \*, none

The *acn* field supports up to 7 subfields separated by a dash (e.g., 1-202-33-104-54-26-007).

\*—any valid value in the ITU TCAP *acn* field in the incoming MSU

none—there is no ITU TCAP *acn* field in the incoming MSU

**:cdssn=** (optional)

Starting CdPA subsystem number.

**Range:** 0-255

**:cggtmod=** (optional)

Calling party global title modification indicator. This parameter displays all translation entries that have the specified value of the calling party GT modification indicator.

**Range:** yes, no

**:cgpc=** (optional)

ANSI CgPA point code with subfields *network indicator-network cluster-network cluster member* (*ni-nc-ncm*).

**Synonym:** **cgpa**

**Range:** **000-255, \***

Specify a valid value for each subfield of the point code, and separate the subfields with a dash (-).

The asterisk (\*) value is not valid for the *ni* subfield.

When **chg-sid:pctype=ansi** is specified, *ni* = **000** is not valid.

When **chg-sid:pctype=ansi** is specified, *nc* = **000** is not valid if *ni* = **001-005**.

When **chg-sid:pctype=ansi** is specified, *nc* = **000** is valid if *ni* = **006-255**.

When **chg-sid:pctype=ansi** is specified, *ni*-\*-\* is valid if *ni* = **006-255**.

The point code **000-000-000** is not a valid point code.

**:cgpci=** (optional)

ITU international CgPA point code with subfields *zone-area-id*. The *prefix* subfield indicates a spare point code (*prefix-zone-area-id*).

**Range:** **s-, 0-255**

Specify a valid value for each subfield of the point code, and separate the subfields with a dash (-).

*prefix*—**s-**

*zone*—**0-7**

*area*—**000-255**

*id*—**0-7**

The point code **0-000-0** is not a valid point code.

**:cgpcn=** (optional)

ITU national CgPA point code in the format of a 5-digit number (*nnnnn*); or 2, 3, or 4 numbers (members) separated by dashes (*m1-m2-m3-m4*) as defined by the **chg-stpopts:npcfmti** flexible point code option. A group code must be specified when the ITUDUPPC feature is turned on (*nnnnn-gc*, *m1-m2-m3-m4-gc*). The *prefix* subfield indicates a spare point code (*prefix-nnnnn*, *prefix-nnnnn-gc*, *prefix-m1-m2-m3-m4*, *prefix-m1-m2-m3-m4-gc*).

**Range:** **s-, 0-16383, aa-zz**

Specify a valid value for each subfield of the point code, and separate the subfields with a dash (-).

*prefix*—**s-**

*nnnnn*—**0-16383**

*gc*—**aa-zz**

*m1-m2-m3-m4*—**0-14** for each member; values must sum to 14

**:cgpcn24=** (optional)

24-bit ITU national CgPA point code with subfields main signaling *area-sub signaling area-signaling point* (*msa-ssa-sp*).

**Range:** **000-255**

Specify a valid value for each subfield of the point code, and separate the subfields with a dash (-).

*msa*—**000-255**

*ssa*—**000-255**

*sp*—**000-255**

- :cgssn=** (optional)  
Starting CgPA subsystem number.  
**Range:**     **0-255**
- :ecdssn=** (optional)  
Ending CdPA subsystem number.  
**Range:**     **0-255**
- :ecgssn=** (optional)  
Ending CgPA subsystem number.  
**Range:**     **0-255**
- :egta=** (optional)  
End global title address. This parameter specifies the end of a range of global title digits.  
**Range:**     1-21 digits  
If the Hex Digit Support for GTT feature is not enabled and on, the range is 1 - 21 decimal digits; valid digits are **0-9**.  
If the Hex Digit Support for GTT feature is enabled and on, the range is 1 - 21 hexadecimal digits; valid digits are **0-9, a-f, A-F**.  
**Default:**    The first **gta** entry for the given GTT selector
- :family=** (optional)  
This parameter specifies the ANSI TCAP *family* field in the incoming MSU.  
**Range:**     **0-255** \*, **none**  
\*—any valid value in the ANSI TCAP *family* field in the incoming MSU  
**none**—there is no value in the ANSI TCAP *family* field in the incoming MSU
- :force=** (optional)  
Display more than 1000 entries.  
**Range:**     **yes, no**  
**Default:**    **no**
- :gta=** (optional)  
Global title address. This parameter specifies the beginning of a range of global title digits.  
**Range:**     1-21 digits  
If the Hex Digit Support for GTT feature is not enabled and on, the range is 1 - 21 decimal digits; valid digits are **0-9**.  
If the Hex Digit Support for GTT feature is enabled and on, the range is 1 - 21 hexadecimal digits; valid digits are **0-9, a-f, A-F**.  
**Default:**    The first **gta** entry for the given GTT selector
- :loopset=** (optional)  
SCCP loopset name. This parameter retrieves translation entries that are associated with the specified loopset.  
**Range:**     *ayyyyyyy*, **none**  
1 alphabetic character followed by up to 7 alphanumeric characters.  
**none**—Translation entries with no association to any loopset.
- :mapset=** (optional)  
MAP set ID. This parameter retrieves GTA information for a specified Mated Application set.  
**Range:**     **1-36,000 dflt**  
**dflt**—Default MAP set  
**Default:**    Retrieves GTA information for the default MAP set.

**:mrnset=** (optional)

MRN set ID. This parameter retrieves GTA information for a specified Mated Relay Node set.

**Range:** 1-3000 none, dflt

**dflt**—Default MRN set

**none**—The GTA translation does not participate in any loadsharing.

**:num=** (optional)

Number of entries to display.

**Range:** 1-1000000

**Default:** 1—if **gta** is specified

20—if **gta** is not specified

**:opc=** (optional)

ANSI originating point code with subfields *network indicator-network cluster-network cluster member (ni-nc-ncm)*.

**Synonym:** opca

**Range:** 000-255, \*

Specify a valid value for each subfield of the point code, and separate the subfields with a dash (-).

The asterisk (\*) value is not valid for the *ni* subfield.

When **chg-sid:pctype=ansi** is specified, *ni* = 000 is not valid.

When **chg-sid:pctype=ansi** is specified, *nc* = 000 is not valid if *ni* = 001-005.

When **chg-sid:pctype=ansi** is specified, *nc* = 000 is valid if *ni* = 006-255.

When **chg-sid:pctype=ansi** is specified, *ni*-\*-\* is valid if *ni* = 006-255.

The point code 000-000-000 is not a valid point code.

**:opci=** (optional)

ITU international originating point code with subfields *zone-area-id*. The *prefix* subfield indicates a spare point code (*prefix-zone-area-id*).

**Range:** s-, 0-255

Specify a valid value for each subfield of the point code, and separate the subfields with a dash (-).

*prefix*—s-

*zone*—0-7

*area*—000-255

*id*—0-7

The point code 0-000-0 is not a valid point code.

**:opcn=** (optional)

ITU national originating point code in the format of a 5-digit number (*nnnnn*); or 2, 3, or 4 numbers (members) separated by dashes (*m1-m2-m3-m4*) as defined by the **chg-stpopts:npcfmti** flexible point code option. A group code must be specified when the ITUDUPPC feature is turned on (*nnnnn-gc*, *m1-m2-m3-m4-gc*). The *prefix* subfield indicates a spare point code (*prefix-nnnnn*, *prefix-nnnnn-gc*, *prefix-m1-m2-m3-m4*, *prefix-m1-m2-m3-m4-gc*).

**Range:** s-, 0-16383, aa-zz

Specify a valid value for each subfield of the point code, and separate the subfields with a dash (-).

*prefix*—s-

*nnnnn*—0-16383

*gc*—aa-zz

*m1-m2-m3-m4*—**0-14** for each member; values must sum to 14

**:opcn24=** (optional)

24-bit ITU originating point code with subfields main signaling *area-sub signaling area-signaling point (msa-ssa-sp)*.

**Range:** **000-255**

Specify a valid value for each subfield of the point code, and separate the subfields with a dash (-).

*msa*—**000-255**

*ssa*—**000-255**

*sp*—**000-255**

**:opcode=** (optional)

This parameter specifies the TCAP *opcode* field in the incoming MSU.

**Range:** **0-255** \*, **none**

\*—any valid value in the TCAP *opcode* field in the incoming MSU

**none**—there is no value in the TCAP *opcode* field in the incoming MSU

**:pc=** (optional)

ANSI point code in the form of *network indicator-network cluster-network cluster member (ni-nc-ncm)* . . The *prefix* subfield indicates a private point code *prefix-ni-nc-ncm*).

**Synonym:** **pca**

**Range:** **p-, 000-255**

Specify a valid value for each subfield of the point code, and separate the subfields with a dash (-).

*prefix*—**p-**

When **chg-sid:pctype=ansi** is specified, *ni* = **000** is not valid.

When **chg-sid:pctype=ansi** is specified, *nc* = **000** is not valid if *ni* = **001-005**.

When **chg-sid:pctype=ansi** is specified, *nc* = **000** is valid if *ni* = **006-255**.

The point code **000-000-000** is not a valid point code.

**:pci=** (optional)

ITU international point code in the form of *zone-area-id*. The *prefix* subfield indicates a spare point code, private point code, or private and spare point code (*prefix-zone-area-id*).

**Range:** **s-, p-, ps-, 0-255**

Specify a valid value for each subfield of the point code, and separate the subfields with a dash (-).

*prefix*—**s-, p-, ps-**

*zone*—**0-7**

*area*—**000-255**

*id*—**0-7**

The point code **0-000-0** is not a valid point code.

**:pcn=** (optional)

ITU national point code in the format of a 5-digit number (*nnnnn*); or 2, 3, or 4 numbers (members) separated by dashes (*m1-m2-m3-m4*) as defined by the **chg-stpopts:npcfnti** flexible point code option. A group code must be specified when the ITUDUPPC feature is turned on (*nnnnn-gc*, *m1-m2-m3-m4-gc*). The *prefix* subfield indicates a spare point code, private point code, or private and spare point code (*prefix-nnnnn*, *prefix-nnnnn-gc*, *prefix-m1-m2-m3-m4*, *prefix-m1-m2-m3-m4-gc*).

**Range:** **s-, p-, ps-, 0-16383, aa-zz**



Specify a valid value for each subfield of the point code, and separate the subfields with a dash (-).

*prefix*—**s-, p-, ps-**

*nmmmm*—**0-16383**

*gc*—**aa-zz**

*m1-m2-m3-m4*—**0-14** for each member; values must sum to 14

**:pcn24=** (optional)

24-bit ITU national point code with subfields *main signaling area-sub signaling area-signaling point (msa-ssa-sp)*. The *prefix* subfield indicates a private point code (*prefix-ni-nc-ncm*).

**Range:** **p-, 000-255**

Specify a valid value for each subfield of the point code, and separate the subfields with a dash (-).

*prefix*—**p-**

*msa*—**000-255**

*ssa*—**000-255**

*sp*—**000-255**

**:pctype=** (optional)

Point code type. This parameter can be specified only when the ANSI-ITU-China SCCP Conversion feature is enabled, to retrieve a single type of point code among mixed types of point code provisioned for a Translation Type.

**Range:** **ansi, itui, itun, itun24, ituis, ituns**

**Default:** Display all point code types

**:pkgtype=** (optional)

Package type. This parameter specifies the ANSI TCAP and ITU TCAP package type.

**Range:** **ansiuni, qwp, qwop, rsp, cwp, cwop, ansiabort, any, bgn, end, cnt, ituabort, ituuni**

**ansiuni**— ANSI unidirectional

**qwp**— Query with Permission

**qwop**— Query with out Permission

**rsp**— Response

**cwp**— Conversation with Permission

**cwop**— Conversation with out Permission

**ansiabort**— ANSI abort

**any**— Wildcard value

**bgn**— Begin

**end**— End

**cnt**— Continue

**ituabort**— ITU abort

**ituuni**— ITU unidirectional

ANSI TCAP PKGTYPE—**ansiuni, qwp, qwop, rsp, cwp, cwop, ansiabort, any**

ITU TCAP PKGTYPE—**bgn, ituabort, ituuni, any, end, cnt**

**:ssn=** (optional)

Subsystem number.

**Range:** **002-255**

**Default:** Display all

**:testmode=** (optional)

Test mode. This parameter displays all translation entries that have a specified value of the **testmode** parameter.

**Range:** on, off  
**Default:** off

### Example

```
rtrv-gta:gttsn=t800:num=65535:force=yes
rtrv-gta:gttsn=t800:pc=8-1-1:ssn=222:gta=9195551212
rtrv-
gta:gttsn=t800:ssn=222:gta=9000000000:egta=9762429999:num=65535:force=yes
rtrv-gta:gttsn=ntoa23:pctype=ansi
rtrv-gta:gttsn=setnat003:pcn=s-129-aa
rtrv-gta:gttsn=setnat003:gta=987658321198765432101:pcn=s-128-aa
rtrv-gta:gttsn=tbla
rtrv-gta:gttsn=tbla:pc=1-1-1
rtrv-gta:gttsn=setssn:mapset=6
rtrv-gta:gttsn=setans006:mrnset=1
rtrv-gta:gttsn=setans004:cggmod=yes
rtrv-gta:gttsn=setcdgta:testmode=on
rtrv-gta:gttsn=setcdssn:cdssn=15:ecdssn=25
```

### Dependencies

The EGTT feature must be turned on before this command can be entered.

The ANSI-ITU-China SCCP Conversion feature must be enabled before the **pctype** parameter can be specified.

The **gttsn** parameter must be specified, cannot have a value of **none**, and must match an existing **gttsn**.

The **pc/pca/pci/pcn/pcn24**, **cgpc/cgpca/cgpci/cgpcn/cgpcn24**, and **opc/opca/opci/opcn/opcn24** parameters must be full point codes and must have valid values within the range for each subfield.

If the ANSI-ITU-China SCCP Conversion feature is not turned on, and the specified GTT set is an ANSI set, then the value specified for the **pc/pca** parameter must be a valid ANSI point code.

If the ANSI-ITU-China SCCP Conversion feature is not turned on, and the specified GTT set is an ITU set, then the value specified for the **pci/pcn/pcn24** parameter must be a valid ITU point code.

If the **egta** parameter is specified, the **gta** parameter must be specified. The **gta** and **egta** parameters must be the same length, and the value for the **egta** parameter must be greater than the value for the **gta** parameter.

If the specified **num** parameter value is greater than **1000**, the **force=yes** parameter must be specified.

The number of digits in the specified **gta** parameter must be at least the number of digits provisioned for the GTT set specified by the **gttsn** parameter. If the VGTT feature is turned on, then up to 10 GTA lengths can exist per GTT set. If the Support for 16 GTT Lengths in VGTT feature is turned on, then up to 16 GTA lengths can exist per GTT set.

If the Flexible GTT Load Sharing feature is not enabled, then the **mapset** parameter cannot be specified.

At least one entry must be provisioned in the specified MAP set in the MAP table.

If the **ecgssn/ecdssn** parameter is specified, the **cgssn/cdssn** parameter must be specified, and the **ecgssn/ecdssn** parameter must be greater than the **cgssn/cdssn** parameter.

The OBSR feature must be enabled before the **cgpc/cgpca/cgpci/cgpcn/cgpcn24**, **opc/opca/opci/opcn/opcn24**, **cgssn**, or **ecgssn** parameter can be specified and before a value of **udts** or **discard** can be specified for the **xlat** parameter.

The **gta** parameter can be specified only if the GTTSN set type has a value of **cdgta** or **cggta**.

The **cgpc/cgpca/cgpci/cgpcn/cgpcn24** parameter may be specified only if the GTTSN set type has a value of **cgpc**.

The **opc/opca/opci/opcn/opcn24** parameter may be specified only if the GTTSN set type has a value of **opc**.

The **cgssn** parameter may be specified only if the GTTSN set type has a value of **cgssn**.

If the specified GTT Set is an ANSI set, the **cgpc/cgpca** and **opc/opca** parameters must be valid ANSI point codes. If the specified GTT Set is an ITU set, the **cgpci/cgpcn/cgpcn24** and **opci/opcn/opcn24** parameters must be valid ITU point codes.

The range specified by the **cgssn/ecgssn** or the **cdssn/ecdssn** parameters must exist for the specified GTT set.

The Hex Digit Support for GTT feature must be enabled and on before hexadecimal digits can be specified for the **gta** and **egta** parameters.

The SCCP Loop Detection feature must be enabled before the **loopset** parameter can be specified.

The value of the **loopset** parameter must already exist in the database.

At least one entry must be provisioned in the MRN table for the MRN set that is specified by the **mrnset** parameter.

The Flexible GTT Load Sharing feature must be enabled before the **mrnset** parameter can be specified.

The AMGTT feature or the AMGTT CgPA Upgrade feature must be turned on before the **cggtmod** parameter can be specified.

The **mapset** parameter and the **mrnset** parameter cannot be specified together in the command.

The FLOBR feature must be turned on before the **testmode** parameter can be specified.

The TOBR feature must be turned on before the **cdssn** or **ecdssn** parameter can be specified.

A TOBR quantity feature must be turned on before the **opcode**, **pkgtype**, **acn**, or **family** parameter can be specified.

The **opcode**, **pkgtype**, and **family** parameters must be specified together for ANSI TCAP translations. The **opcode**, **pkgtype**, and **acn** parameters must be specified together for ITU TCAP translations.

The **acn** and **family** parameters cannot be specified together in the command. If the **cgssn** parameter is specified, then the **cdssn** and **ecdssn** parameters cannot be specified. If the **cdssn** parameter is specified, then the **cgssn** and **ecgssn** parameters cannot be specified. The **cgpc**, **cgssn**, **gta**, **opc**, **cdssn** and **opcode** parameters cannot be specified together in the command. The specified GTT set must have a set type of **opcode** (see the **ent-gttset** command) before the **opcode/acn/pkgtype** or **opcode/family/pkgtype** parameters can be specified. The specified GTT set must have a set type of **cdssn** before the **cdssn** parameter can be specified. The specified GTT set must have a set type of **cgssn** before the **cgssn** parameter can be specified. The specified GTT set must have a set type of **cdgta** or **cggta** before the **gta** parameter can be specified. The specified GTT set must have a set type of **opc** before the **opc** parameter can be specified. The specified GTT set must have a set type of **cgpc** before the **cgpc** parameter can be specified.

If the **family** parameter is specified, then a value of **ansiuni**, **qwp**, **qwop**, **resp**, **cwp**, **cwop**, **ansiaabort**, or **any** must be specified for the **pkgtype** parameter.

If the **acn** parameter is specified, then a value of **bgn**, **ituabort**, **ituuni**, **any**, **end**, or **cnt** must be specified for the **pkgtype** parameter.

If the **pkgtype=ituabort** is specified, then a value of **none** must be specified for the the **acn** and **opcode** parameters can. If the **pkgtype=ansiabort** parameter is specified, then a value of **none** must be specified for the **family** and **opcode** parameters.

The **cgpc**, **cgssn**, **gta**, **opc**, **cdssn**, and **opcode** parameters cannot be specified in the same command.

## Notes

The percentage full and number of cells used report that is provided with a **rtrv-gta** command reflects the total entries in the GTA table without regard to the selector specified.

When the EGTT feature is turned on, the GTT Selector (**ent/chg/dlt/rtrv-gttsel**), GTT Set (**ent/dlt/rtrv-gttset**), and GTA (**ent/chg/dlt/rtrv-gta**) commands replace the Translation Type (**ent/dlt/rtrv-tt**) and Global Title Translation (**ent/chg/dlt/rtrv-gtt**) commands. All data previously provisioned with these commands is maintained.

This command can be canceled using the **F9** function key or the **canc-cmd** command. See **canc-cmd** for more information.

If the **rtrv-gta** command is entered with only the **gta** parameter, a match would be an entry containing the same number of digits, or more digits, for the GTT set. For example, if **gta=8005556666** is specified, the six-digit GTT set **800555** would be a match. If the VGTT feature is turned on and the **egta** parameter is specified, all matching entries regardless of length are displayed.

In this command, only ITU-international and ITU national point codes support the spare point code subtype prefix (**s-**) and the private and spare point code subtype prefix (**ps-**). All of the point code types support the private (internal) point code subtype prefix (**p-**).

The point code domain translation types for EGTT are handled by the EAGLE 5 ISS protocol processing as either ANSI or ITU; therefore, ITU applies to ITU-I, ITU-I Spare, ITU-N, and ITU-N Spare. ITU-I includes ITU-I Spare, and ITU-N includes ITU-N Spare.

Output

**NOTE: The Start GTA (gta) and End GTA (egta) fields are sized according to the ndgt parameter value. Because all GTAs for a GTT Set are the same size, this helps the appearance of the display. If all 21 digits are used, an entry will not fit on a single line. If two lines per entry are used, the size of the report would double, being inefficient for large reports. It is not anticipated that more than 15 digits will be used in the immediate future, but displaying GTAs longer than 19 digits will cause the line to wrap around to the next line.**

Retrieve all GTAs for the specified GTT Set:

```
rtrv-gta:gttsn=t800:num=65535:force=yes
tekelecstp 09-03-10 13:54:32 EST EAGLE 41.0.0

GTTSN      NETDOM  NDGT
t800       ansi     10
```

GTA table is (17 of 269999) 1% full.

| START GTA                | END GTA    | XLAT   | RI  | PCA         |
|--------------------------|------------|--------|-----|-------------|
| 8005550000               | 8005551999 | dpcssn | ssn | 001-254-255 |
| SSN=255 CCGT=no NTT=---  |            |        |     |             |
| 8005552000               | 8005553999 | dpc    | gt  | 001-254-255 |
| SSN=--- CCGT=no NTT=---  |            |        |     |             |
| 8005554000               | 8005555999 | dpcngt | gt  | 001-254-255 |
| SSN=--- CCGT=no NTT=123  |            |        |     |             |
| 8005556000               | 8005557999 | dpcssn | ssn | 001-254-255 |
| SSN=255 CCGT=no NTT=---  |            |        |     |             |
| 8005558000               | 8005559999 | dpcssn | ssn | 001-254-255 |
| SSN=255 CCGT=yes NTT=--- |            |        |     |             |
| 9195551212               |            | dpcssn | ssn | 008-001-001 |
| SSN=222 CCGT=no NTT=---  |            |        |     |             |
| 9762428487               |            | dpcssn | ssn | 001-254-255 |
| SSN=222 CCGT=no NTT=---  |            |        |     |             |
| 9766423277               |            | dpcssn | ssn | 001-254-255 |
| SSN=222 CCGT=no NTT=---  |            |        |     |             |
| 9769388928               |            | dpcssn | ssn | 001-254-255 |
| SSN=222 CCGT=no NTT=---  |            |        |     |             |

Command Retrieved 9 Entries

;

Retrieve the specific GTAs containing the specified **pc/ssn/gta** combination for the specified GTT Set:

```
rtrv-gta:gttsn=t800:pc=8-1-1:ssn=222:gta=9195551212
rlghncxa03w 08-09-10 08:29:15 EST EAGLE 39.2.0

GTTSN      NETDOM  NDGT
t800       ansi     10
```

GTA table is (17 of 269999) 1% full.

| START GTA  | END GTA | XLAT   | RI  | PCA         | SSN | CCGT | NTT |
|------------|---------|--------|-----|-------------|-----|------|-----|
| 9195551212 |         | dpcssn | ssn | 008-001-001 | 222 | no   | --- |

Command Retrieved 1 Entries

;

Retrieve all GTAs containing the specified **ssn** and within the specified **gta** range for the specified GTT Set:

**rtrv-**

**gta:gttsn=t800:ssn=222:gta=900000000:egta=9762429999:num=65535:force=yes**

rlghncxa03w 08-09-18 08:29:15 EST EAGLE 39.2.0

GTTSN NETDOM NDGT  
t800 ansi 10

GTA table is (17 of 269999) 1% full.

| START GTA  | END GTA | XLAT   | RI  | PCA         | SSN | CCGT | NTT |
|------------|---------|--------|-----|-------------|-----|------|-----|
| 9195551212 |         | dpcssn | ssn | 008-001-001 | 222 | no   | --- |
| 9762428487 |         | dpcssn | ssn | 001-254-255 | 222 | no   | --- |

Command Retrieved 2 Entries

;

Retrieve all GTAs for the specified GTT Set when the VGTT feature is turned on:

**rtrv-gta:gttsn=t800:num=65535:force=yes**

tekelecstp 09-03-10 13:54:32 EST EAGLE 41.0.0

GTTSN NETDOM NDGT  
t800 ansi 3,10

GTA table is (17 of 269999) 1% full.

| START GTA  | END GTA    | XLAT    | RI       | PCA         |
|------------|------------|---------|----------|-------------|
| 800        |            | dpcssn  | ssn      | 001-253-001 |
|            |            | SSN=222 | CCGT=no  | NTT=---     |
| 9195551212 |            | dpcssn  | ssn      | 008-001-001 |
|            |            | SSN=222 | CCGT=no  | NTT=---     |
| 9762428487 |            | dpcssn  | ssn      | 001-254-255 |
|            |            | SSN=222 | CCGT=no  | NTT=---     |
| 9766423277 |            | dpcssn  | ssn      | 001-254-255 |
|            |            | SSN=222 | CCGT=no  | NTT=---     |
| 9769388928 |            | dpcssn  | ssn      | 001-254-255 |
|            |            | SSN=222 | CCGT=no  | NTT=---     |
| 8005550000 | 8005551999 | dpcssn  | ssn      | 001-254-255 |
|            |            | SSN=255 | CCGT=no  | NTT=---     |
| 8005552000 | 8005553999 | dpc     | gt       | 001-254-255 |
|            |            | SSN=--- | CCGT=no  | NTT=---     |
| 8005554000 | 8005555999 | dpcngt  | gt       | 001-254-255 |
|            |            | SSN=--- | CCGT=no  | NTT=123     |
| 8005556000 | 8005557999 | dpcssn  | ssn      | 001-254-255 |
|            |            | SSN=255 | CCGT=no  | NTT=---     |
| 8005558000 | 8005559999 | dpcssn  | ssn      | 001-254-255 |
|            |            | SSN=255 | CCGT=yes | NTT=---     |

Command Retrieved 10 Entries

;

The following example shows a retrieve with the GT Modification **nnp**, **nnai**, **npdd**, and **npds** parameter values:

**rtrv-gta:gttsn=ansi**

tekelecstp 09-03-10 13:54:32 EST EAGLE 41.0.0

GTTSN NETDOM NDGT  
ansi ansi 10

GTA table is (17 of 269999) 1% full.

```

START GTA  END GTA  XLAT  RI  PCA
8005550000 8005551999 dpcssn ssn 001-254-255
SSN=255 CCGT=no NTT=--- CGGTMOD=NO
8005552000 8005553999 dpc gt 001-254-255
SSN=--- CCGT=no NTT=--- CGGTMOD=NO
NNP=3 NNAI=120 NPDD=3 NPDS=345
NGTI=
8005554000 8005555999 dpcngt gt 001-254-255
SSN=--- CCGT=no NTT=123 CGGTMOD=NO
8005558000 8005559999 dpcssn ssn 001-254-255
SSN=255 CCGT=yes NTT=--- CGGTMOD=NO
9195551212 dpcssn ssn 008-001-001
SSN=222 CCGT=no NTT=--- CGGTMOD=NO
9762428487 dpcssn ssn 001-254-255
SSN=222 CCGT=no NTT=--- CGGTMOD=NO
NNP=3 NNAI=100 NPDD=3 NPDS=345
NGTI=
9766423277 dpcssn ssn 001-254-255
SSN=222 CCGT=no NTT=--- CGGTMOD=NO
    
```

Command Retrieved 7 Entries

;

The following example shows output when the GTT table can contain up to 1,000,000 entries:

**rtrv-gta:gttsn=ansi**

```

tekelecstp 09-03-10 13:54:32 EST EAGLE 41.0.0
GTTSN NETDOM NDGT
ansi ansi 10
    
```

GTA table is (17 of 1000000) 1% full.

```

START GTA  END GTA  XLAT  RI  PCA
8005550000 8005551999 DPCSSN SSN 001-254-255
SSN=255 CCGT=no NTT=--- CGGTMOD=NO
8005552000 8005553999 DPCNGT GT 001-254-255
SSN=--- CCGT=no NTT=123 CGGTMOD=NO
NNP=3 NNAI=120 NPDD=3 NPDS=345
NGTI=
8005554000 8005555999 DPCNGT GT 001-254-255
SSN=--- CCGT=no NTT=123 CGGTMOD=NO
8005558000 8005559999 DPCSSN SSN 001-254-255
SSN=255 CCGT=yes NTT=--- CGGTMOD=NO
9195551212 DPCSSN SSN 008-001-001
SSN=222 CCGT=no NTT=--- CGGTMOD=NO
9762428487 DPCNGT GT 001-254-255
SSN=--- CCGT=no NTT=123 CGGTMOD=NO
NNP=3 NNAI=100 NPDD=3 NPDS=345
NGTI=
9766423277 DPCSSN SSN 001-254-255
SSN=222 CCGT=no NTT=--- CGGTMOD=NO
    
```

Command Retrieved 7 Entries

;

The following example shows output when the ANSI-ITU-China SCCP Conversion feature is enabled and the **pctype** parameter value is **ansi**.

**rtrv-gta:gttsn=ntoa23:pctype=ansi**

```

rlghncxa03w 08-09-18 08:29:15 EST EAGLE 39.2.0
GTTSN NETDOM NDGT
ntoa23 itu 4
    
```

GTA table is (36 of 269999) 1% full.

```
START GTA  END GTA  XLAT  RI  PC          SSN CCGT NTT
1899      1899      DPCNGT GT  010-002-002 --- no  37
      NNP=   NNAI=   NPDD=0 NPDS=
      NGTI=2
```

Command Retrieved 1 Entries

;

The following example shows output when the ANSI-ITU-China SCCP Conversion feature is enabled and the **pctype** parameter value is **itui**.

**rtrv-gta:gttsn=atoi22:pctype=itui**

rlghncxa03w 08-09-18 08:29:15 EST EAGLE 39.2.0

```
GTTSN      NETDOM  NDGT
atoi22    ansi    9
```

GTA table is (36 of 269999) 1% full.

```
START GTA  END GTA  XLAT  RI  ITUI PC          SSN CCGT NTT
991001200 991001300 DPCNGT GT  7-001-4    --- no  4
      NNP=   NNAI=   NPDD=0 NPDS=
      NGTI=2
```

Command Retrieved 1 Entries

;

The following example shows output when the ANSI-ITU-China SCCP Conversion feature is enabled and the **pctype** parameter value is **itun**.

**rtrv-gta:gttsn=aton21:pctype=itun**

rlghncxa03w 08-09-18 08:29:15 EST EAGLE 39.2.0

```
GTTSN      NETDOM  NDGT
aton21     ansi    2
```

GTA table is (36 of 269999) 1% full.

```
START GTA  END GTA  XLAT  RI  ITUN PC          SSN CCGT NTT
80         89         DPCSSN SSN 15441    45 no  ---
```

Command Retrieved 1 Entries

;

The following example shows output when the ANSI-ITU-China SCCP Conversion feature is enabled and the **pctype** parameter value is **itun24**.

**rtrv-gta:gttsn=ntin24:pctype=itun24**

rlghncxa03w 08-09-18 08:29:15 EST EAGLE 39.2.0

```
GTTSN      NETDOM  NDGT
ntin24     itu     10
```

GTA table is (36 of 269999) 1% full.

```
START GTA  END GTA  XLAT  RI  ITUN24 PC  SSN CCGT NTT
8006550000 8006551999 DPCSSN SSN 100-120-003 255 no  ---
```

Command Retrieved 1 Entries

;

**rtrv-gta:gttsn=setnat003**

tekelecstp 09-03-10 13:54:32 EST EAGLE 41.0.0



```
GTTSN      NETDOM  NDGT
setnat003  itu      6,11,21
```

GTA table is (10 of 269999) 1% full.

```
START GTA          END GTA          XLAT  RI      PC
123456            123456            DPCSSN GT  s-00128-aa
  SSN=10  CCGT=no  NTT=---
  NNP=12  NNAI=125 NPDD=21 NPDS=125498679012426556356
  NGTI=
234567            234567            DPCNGT GT  s-00124-aa
  SSN=---  CCGT=no  NTT=255
234568            234568            DPC    GT  s-00124-aa
  SSN=---  CCGT=no  NTT=---
234569            234569            DPC    GT  s-00124-aa
  SSN=---  CCGT=no  NTT=---
  NNP=13  NNAI=120 NPDD=21 NPDS=125498679012426556356
  NGTI=
12345678901      23456789012      DPCSSN SSN s-00124-aa
  SSN=10  CCGT=no  NTT=---
  NNP=14  NNAI=3   NPDD=0  NPDS=
  NGTI=
334569467213456789012 334569478932012345678 DPC    GT  s-00124-aa
  SSN=---  CCGT=no  NTT=---
  NNP=13  NNAI=120 NPDD=21 NPDS=125498679012426556356
  NGTI=
987656789012345678901 987657321098765432101 DPCNGT GT  s-00124-aa
  SSN=---  CCGT=no  NTT=234
  NNP=12  NNAI=26  NPDD=0  NPDS=
  NGTI=
987658321198765432101 987658321198765432101 DPCNGT GT  s-00128-aa
  SSN=---  CCGT=no  NTT=235
  NNP=1   NNAI=127 NPDD=0  NPDS=987657878901234567891
  NGTI=4
987658321198765432102 990123456789012345678 DPCNGT GT  s-00124-aa
  SSN=---  CCGT=no  NTT=235
  NNP=1   NNAI=127 NPDD=0  NPDS=987657878901234567891
  NGTI=4
```

Command Retrieved 9 Entries

;

**rtrv-gta:gttsn=setnat003:pcn=s-129-aa**

rlghncxa03w 08-09-18 08:29:15 EST EAGLE 39.2.0

```
GTTSN      NETDOM  NDGT
setnat003  itu      6,11,21
```

GTA table is (11 of 269999) 1% full.

```
START GTA          END GTA          XLAT  RI      PC
987658321198765432102 987658321198765432102 DPCNGT GT  s-00129-aa
  SSN=---  CCGT=no  NTT=235
  NNP=1   NNAI=127 NPDD=0  NPDS=987657878901234567891
  NGTI=4
```

Command Retrieved 1 Entries

;

**rtrv-gta:gttsn=setnat003:ssn=10**

rlghncxa03w 08-09-18 08:29:15 EST EAGLE 39.2.0

```
GTTSN      NETDOM  NDGT
setnat003  itu      6,11,21
```

GTA table is (11 of 269999) 1% full.

```

START GTA          END GTA          XLAT  RI      PC
123456            123456            DPCSSN GT  s-00128-aa
  SSN=10  CCGT=no  NTT=---
  NNP=12  NNAI=125 NPDD=21 NPDS=125498679012426556356
  NGTI=
12345678901      23456789012          DPCSSN SSN  s-00124-aa
  SSN=10  CCGT=no  NTT=---
  NNP=14  NNAI=3   NPDD=0  NPDS=
  NGTI=

```

Command Retrieved 2 Entries

;

**rtrv-gta:gttsn=setnat003:gta=987658321198765432101:pcn=s-128-aa**

rlghncxa03w 08-09-18 08:29:15 EST EAGLE 39.2.0

```

GTTSN      NETDOM  NDGT
setnat003  itu     6,11,21

```

GTA table is (11 of 269999) 1% full.

```

START GTA          END GTA          XLAT  RI      PC
987658321198765432101 987658321198765432101 DPCNGT GT  s-00128-aa
  SSN=--- CCGT=no  NTT=235
  NNP=1   NNAI=127 NPDD=0  NPDS=987657878901234567891
  NGTI=4

```

Command Retrieved 1 Entries

;

The following example shows an MRN set. The Flexible GTT Load-Sharing feature and the Intermediate GTT Load Sharing feature are on.

**rtrv-gta:gttsn=setssnn**

tekelecstp 09-03-10 13:54:32 EST EAGLE 41.0.0

```

GTTSN      NETDOM  NDGT
setssnn    ansi    10

```

GTA table is (1 of 269999) 1% full.

```

START GTA  END GTA  XLAT  RI      PCA
1111111111 1111111111 DPC  GT     001-001-003
  MRNSET=1  SSN=--- CCGT=no NTT=---

```

Command Retrieved 1 Entries

;

The following example shows a MAP set. The Flexible GTT Load Sharing feature is enabled.

**rtrv-gta:gttsn=tbla**

tekelecstp 08-09-10 14:51:59 EST EAGLE 39.2.0

```

GTTSN      NETDOM  NDGT
tbla       ansi    6,10

```

GTA table is (3 of 269999) 1% full.

```

START GTA  END GTA  XLAT  RI      PCA
234567    234567    DPCSSN GT  001-001-001
  MRNSET=DFLT SSN=10 CCGT=no NTT=---
9810012345 9850012345 DPCSSN SSN  001-001-001

```

MAPSET=DFLT SSN=10 CCGT=no NTT=---

Command Retrieved 2 Entries

;

The following example retrieves a CdPA GTA entry and an Advanced CdPA GTA entry when the OBSR feature is enabled.

**rtrv-gta:gttsn=setcdpa**

tekelecstp 09-04-10 09:49:42 EST EAGLE 41.0.0

GTTSN NETDOM NDGT  
setcdpa itu 6

GTA table is (15 of 269999) 1% full.

| START GTA                                       | END GTA | XLAT   | RI  | PC      |
|-------------------------------------------------|---------|--------|-----|---------|
| 106399                                          | 106489  | DPCNGT | GT  | 1-200-1 |
| SSN=--- CCGT=no NTT=17                          |         |        |     |         |
| NNP=1 NNAI=45 NPDD=5 NPDS=654321678901234567891 |         |        |     |         |
| NGTI=4                                          |         |        |     |         |
| OPTSN=SETCG1 CGSELID=----- OPCS=-----           |         |        |     |         |
| 306399                                          | 306489  | DPCNGT | GT  | 1-200-1 |
| SSN=--- CCGT=no NTT=17                          |         |        |     |         |
| NNP=1 NNAI=45 NPDD=5 NPDS=654321678901234567891 |         |        |     |         |
| NGTI=4                                          |         |        |     |         |
| OPTSN=CGPCSET01 CGSELID=----- OPCS=OPCSET001    |         |        |     |         |
| 400000                                          | 406489  | UDTS   |     |         |
| 500000                                          | 506489  | DISC   |     |         |
| 600001                                          | 600009  | DPCSSN | SSN | -----   |
| SSN=125 CCGT=no NTT=17                          |         |        |     |         |
| NNP=1 NNAI=45 NPDD=5 NPDS=654321678901234567891 |         |        |     |         |
| NGTI=4                                          |         |        |     |         |
| OPTSN=----- CGSELID=65500 OPCS=OPCSET001        |         |        |     |         |

Command Retrieved 5 Entries

;

The following example retrieves a CgPA GTA entry when the OBSR feature is enabled.

**rtrv-gta:gttsn=setcgpa**

tekelecstp 09-04-10 09:49:42 EST EAGLE 41.0.0

GTTSN NETDOM NDGT  
setcgpa itu 6

GTA table is (15 of 269999) 1% full.

| START GTA                                       | END GTA | XLAT   | RI | PC      |
|-------------------------------------------------|---------|--------|----|---------|
| 406399                                          | 406489  | DPCNGT | GT | 1-200-1 |
| SSN=--- CCGT=no NTT=17                          |         |        |    |         |
| NNP=1 NNAI=45 NSDD=9 NSDS=754321678901234567891 |         |        |    |         |
| NGTI=4                                          |         |        |    |         |
| OPTSN=SETCGSSN1                                 |         |        |    |         |
| 906399                                          | 906489  | DISC   |    |         |

Command Retrieved 2 Entries

;

The following example retrieves a CgPA PC entry when the Origin Based SCCP Routing feature is enabled.

**rtrv-gta:gttsn=setcgpc**

tekelecstp 09-04-10 09:49:42 EST EAGLE 41.0.0

```
GTTSN      NETDOM  NDGT
setcGPC    ansi    -
```

GTA table is (5 of 269999) 1% full.

```
CgPA PC          XLAT  RI    PC
001-012-255      DPCNGT GT    1-200-1
  SSN=--- CCGT=no NTT=17
  NNP=1  NNAI=45 NSDD=9 NSDS=754321678901234567891
  NGTI=4
  OPTSN=SETCGSSN2
255-010-*        UDTS
101-*-*          DPCNGT GT    1-200-1
  SSN=--- CCGT=no NTT=17
  NNP=1  NNAI=45 NSDD=9 NSDS=754321678901234567891
  NGTI=4
  OPTSN=SETCGSSN2
```

Command Retrieved no Entries

;

The following example retrieves an OPC entry when the OBSR feature is enabled.

**rtrv-gta:gttsn=setopc**

tekelecstp 09-04-10 09:49:42 EST EAGLE 41.0.0

```
GTTSN      NETDOM  NDGT
setopc     ansi    -
```

GTA table is (5 of 269999) 1% full.

```
OPC          XLAT  RI    PC
s-001-012-255(A) DPCNGT GT    s-1-200-1
  SSN=--- CCGT=no NTT=17
  NNP=1  NNAI=45 NSDD=9 NSDS=754321678901234567891
  NGTI=4
  OPTSN=SETCGSSN3
224-*-* (N24)    UDTS
```

Command Retrieved no Entries

;

The following example retrieves a CgPA SSN entry when the OBSR feature is enabled.

**rtrv-gta:gttsn=setssn**

tekelecstp 08-09-10 09:49:42 EST EAGLE 39.2.0

```
GTTSN      NETDOM  NDGT
setssn     itu    -
```

GTA table is (5 of 269999) 1% full.

```
START SSN      END SSN          XLAT  RI    PC
100            200            DPCNGT GT    1-200-1
  SSN=--- CCGT=no NTT=17
  NNP=1  NNAI=45 NSDD=9 NSDS=754321678901234567891
  NGTI=4
220            230            DISC
```

Command Retrieved 2 Entries

;

In the following example, the network domain is set to **cross**.

**rtrv-gta:gttsn=ansiset1**

tekelecstp 08-09-01 15:22:08 EST EAGLE 39.2.0

|          |        |      |
|----------|--------|------|
| GTTSN    | NETDOM | NDGT |
| ansiset1 | cross  | 6    |

GTA table is (1 of 269999) 1% full.

|           |         |        |     |             |     |      |     |
|-----------|---------|--------|-----|-------------|-----|------|-----|
| START GTA | END GTA | XLAT   | RI  | PC          | SSN | CCGT | NTT |
| 123456    | 123456  | DPCSSN | SSN | 001-001-002 | 110 | no   | --- |

Command Retrieved 1 Entries

;

The following example shows output when the Flexible GTT Load Sharing feature is enabled.

**rtrv-gta:gttsn=tblb**

tekelecstp 08-09-20 08:27:18 EST EAGLE 39.2.0

|       |        |      |
|-------|--------|------|
| GTTSN | NETDOM | NDGT |
| tblb  | ansi   | 6    |

GTA table is (6 of 269999) 1% full.

|                                     |         |        |     |             |
|-------------------------------------|---------|--------|-----|-------------|
| START GTA                           | END GTA | XLAT   | RI  | PCA         |
| 123456                              | 123456  | DPC    | GT  | 003-003-003 |
| MRNSET=DFLT SSN=--- CCGT=no NTT=--- |         |        |     |             |
| 123457                              | 123457  | DPCSSN | SSN | 003-003-003 |
| MAPSET=DFLT SSN=2 CCGT=no NTT=---   |         |        |     |             |

Command Retrieved 2 Entries

;

The following example shows output when the Hex Digit Support for GTT feature is turned on and hexadecimal digits are provisioned in GTA values.

**rtrv-gta:gttsn=setnat201**

tekelecstp 08-09-11 13:39:28 EST EAGLE 39.2.0

|           |        |      |
|-----------|--------|------|
| GTTSN     | NETDOM | NDGT |
| setnat201 | itu    | 6,21 |

GTA table is (5 of 269999) 1% full.

|                                         |                       |        |     |       |
|-----------------------------------------|-----------------------|--------|-----|-------|
| START GTA                               | END GTA               | XLAT   | RI  | PC    |
| 100000                                  | 10000d                | DPC    | GT  | 00101 |
| SSN=--- CCGT=no NTT=---                 |                       |        |     |       |
| 10000e                                  | 10000f                | DPC    | GT  | 00101 |
| SSN=--- CCGT=no NTT=---                 |                       |        |     |       |
| 100010                                  | 200000                | DPC    | GT  | 00101 |
| SSN=--- CCGT=no NTT=---                 |                       |        |     |       |
| abcdef0123456789abcdef                  | fabcd01234567890afff  | DPCSSN | SSN | 00103 |
| SSN=10 CCGT=no NTT=---                  |                       |        |     |       |
| fbcd0123456789abcdef                    | ffbfde01234567890aaff | DPCSSN | SSN | 00103 |
| SSN=10 CCGT=no NTT=---                  |                       |        |     |       |
| NMP= NNAI= NSDD=4 NSDS=abcdef0123456789 |                       |        |     |       |
| NGTI=                                   |                       |        |     |       |

Command Retrieved 5 Entries

;

The following example shows output when the SCCP Loop Detection feature is enabled and an associated loopset exists.

```
rtrv-gta:gttsn=setssn:mapset=6
tekelecstp 08-09-10 09:50:42 EST EAGLE 39.2.0

GTTSN      NETDOM  NDGT
setssnn    ansi    10

GTA table is (42 of 269999) 1% full.

START GTA  END GTA   XLAT  RI    PCA          LOOPSET
1111111111 1111111122 DPCSSN SSN   001-001-003 RALEIGH1
      MAPSET=6      SSN=2   CCGT=no  NTT=---
```

Command Retrieved 1 Entries

;

The following example shows output for a specified MRN set when the Flexible GTT Load Sharing feature is enabled.

```
rtrv-gta:gttsn=setans006:mrnset=1
tekelecstp 08-09-03 13:03:16 EST EAGLE 39.2.0

GTTSN      NETDOM  NDGT
setans006  ansi    10

GTA table is (8 of 269999) 1% full.

START GTA  END GTA   XLAT  RI    PCA
1818510090 1918511241 DPC   GT    001-001-003
      MRNSET=1      SSN=--- CCGT=no  NTT=---
```

Command Retrieved 1 Entries

;

The following example shows output when calling party GT modification is requested for a GTT set.

```
rtrv-gta:gttsn=setans004:cggmod=yes
tekelecstp 08-09-29 16:57:00 EST EAGLE 39.2.0

GTTSN      NETDOM  NDGT
setans004  ansi    6

GTA table is (1 of 269999) 1% full.

START GTA  END GTA   XLAT  RI    PC
981234     981234   DPCNGT GT    001-001-001
      MRNSET=DFLT  SSN=--- CCGT=no  NTT=10  CCGTMOD=yes
      NNP=14  NNAI=    NPDD=0  NPDS=
      NGTI=
      LOOPSET = none
```

Command Retrieved 1 Entries

;

```
rtrv-gta:gttsn=setans001
e1040501 08-09-02 14:25:15 EST EAGLE 39.2.0

GTTSN      NETDOM  SETTYPE  NDGT
setans001  ansi    CDGTA    3,6

GTA table is (61 of 269999) 1% full.
```

;

e1040501 08-09-02 14:25:15 EST EAGLE 39.2.0

```

START GTA END GTA  XLAT  RI    PCA
100      100      DPCSSN SSN    001-001-002
      MAPSET=DFLT  SSN=10  CCGT=no  NTT=---  CGGTMOD=NO
      CGGTASN=-----  CGPCSN=-----  SELID=-----  OPCSN=-----
101      101      DPCSSN SSN    001-001-003
      MAPSET=DFLT  SSN=10  CCGT=no  NTT=---  CGGTMOD=NO
      CGGTASN=-----  CGPCSN=-----  SELID=-----  OPCSN=-----
104      104      DPCSSN SSN    001-001-003
      MAPSET=DFLT  SSN=10  CCGT=no  NTT=---  CGGTMOD=NO
      CGGTASN=-----  CGPCSN=-----  SELID=-----  OPCSN=-----
105      105      DPCSSN SSN    001-001-003
      MAPSET=1     SSN=14  CCGT=no  NTT=---  CGGTMOD=NO
      CGGTASN=-----  CGPCSN=-----  SELID=-----  OPCSN=-----
115      115      DPCSSN SSN    001-001-002
      MAPSET=2     SSN=15  CCGT=no  NTT=---  CGGTMOD=NO
      CGGTASN=-----  CGPCSN=-----  SELID=-----  OPCSN=-----
111111  111111  DPC    GT    001-001-002
      MRNSET=DFLT  SSN=---  CCGT=no  NTT=---  CGGTMOD=NO
      CGGTASN=-----  CGPCSN=-----  SELID=-----  OPCSN=-----
111112  111112  DPC    GT    001-001-002
      MRNSET=DFLT  SSN=---  CCGT=no  NTT=---  CGGTMOD=NO
      CGGTASN=-----  CGPCSN=-----  SELID=-----  OPCSN=-----
111113  111113  DPC    GT    001-001-002
      MRNSET=DFLT  SSN=---  CCGT=no  NTT=---  CGGTMOD=NO
      CGGTASN=-----  CGPCSN=-----  SELID=-----  OPCSN=-----
111114  111114  DPC    GT    001-001-002
      MRNSET=DFLT  SSN=---  CCGT=no  NTT=---  CGGTMOD=NO
      CGGTASN=-----  CGPCSN=-----  SELID=-----  OPCSN=-----
111115  111115  DPC    GT    001-001-002
      MRNSET=DFLT  SSN=---  CCGT=no  NTT=---  CGGTMOD=NO
      CGGTASN=-----  CGPCSN=-----  SELID=-----  OPCSN=-----
111116  111116  DPC    GT    001-001-002
      MRNSET=DFLT  SSN=---  CCGT=no  NTT=---  CGGTMOD=NO
      CGGTASN=-----  CGPCSN=-----  SELID=-----  OPCSN=-----
111117  111117  DPC    GT    001-001-002
      MRNSET=DFLT  SSN=---  CCGT=no  NTT=---  CGGTMOD=NO
      CGGTASN=-----  CGPCSN=-----  SELID=-----  OPCSN=-----
111118  111118  DPC    GT    001-001-002
      MRNSET=DFLT  SSN=---  CCGT=no  NTT=---  CGGTMOD=NO
      CGGTASN=-----  CGPCSN=-----  SELID=-----  OPCSN=-----
111119  111119  DPC    GT    001-001-002
      MRNSET=DFLT  SSN=---  CCGT=no  NTT=---  CGGTMOD=NO
      CGGTASN=-----  CGPCSN=-----  SELID=-----  OPCSN=-----
111120  111120  DPC    GT    001-001-002
      MRNSET=DFLT  SSN=---  CCGT=no  NTT=---  CGGTMOD=NO
      CGGTASN=-----  CGPCSN=-----  SELID=-----  OPCSN=-----
111121  111121  DPC    GT    001-001-002
      MRNSET=DFLT  SSN=---  CCGT=no  NTT=---  CGGTMOD=NO
      CGGTASN=-----  CGPCSN=-----  SELID=-----  OPCSN=-----
111122  111122  DPC    GT    001-001-002
      MRNSET=DFLT  SSN=---  CCGT=no  NTT=---  CGGTMOD=NO
      CGGTASN=-----  CGPCSN=-----  SELID=-----  OPCSN=-----
111123  111123  DPC    GT    001-001-002
      MRNSET=DFLT  SSN=---  CCGT=no  NTT=---  CGGTMOD=NO
      CGGTASN=-----  CGPCSN=-----  SELID=-----  OPCSN=-----
111124  111124  DPC    GT    001-001-002
      MRNSET=DFLT  SSN=---  CCGT=no  NTT=---  CGGTMOD=NO
      CGGTASN=-----  CGPCSN=-----  SELID=-----  OPCSN=-----
111125  111125  DPC    GT    001-001-002
      MRNSET=DFLT  SSN=---  CCGT=no  NTT=---  CGGTMOD=NO
      CGGTASN=-----  CGPCSN=-----  SELID=-----  OPCSN=-----

```

Command Retrieved 20 Entries

```

;
rtrv-gta:gttsn=setans001:pc=1-1-3
e1040501 08-09-02 14:25:57 EST EAGLE 39.2.0

GTTSN      NETDOM  SETTYPE  NDGT
setans001  ansi    CDGTA   3,6

GTA table is (61 of 269999) 1% full.

```

e1040501 08-09-02 14:25:57 EST EAGLE 39.2.0

```

START GTA END GTA  XLAT  RI    PCA
101      101      DPCSSN SSN    001-001-003
      MAPSET=DFLT  SSN=10  CCGT=no  NTT=---  CGGTMOD=NO
      CGGTASN=-----  CGPCSN=-----  SELID=-----  OPCS=-----
104      104      DPCSSN SSN    001-001-003
      MAPSET=DFLT  SSN=10  CCGT=no  NTT=---  CGGTMOD=NO
      CGGTASN=-----  CGPCSN=-----  SELID=-----  OPCS=-----
105      105      DPCSSN SSN    001-001-003
      MAPSET=1     SSN=14  CCGT=no  NTT=---  CGGTMOD=NO
      CGGTASN=-----  CGPCSN=-----  SELID=-----  OPCS=-----
111260   111260   DPCSSN SSN    001-001-003
      MAPSET=DFLT  SSN=12  CCGT=no  NTT=---  CGGTMOD=NO
      CGGTASN=-----  CGPCSN=-----  SELID=-----  OPCS=-----
111261   111261   DPCSSN SSN    001-001-003
      MAPSET=DFLT  SSN=12  CCGT=no  NTT=---  CGGTMOD=NO
      CGGTASN=-----  CGPCSN=-----  SELID=-----  OPCS=-----
111262   111262   DPCSSN SSN    001-001-003
      MAPSET=DFLT  SSN=12  CCGT=no  NTT=---  CGGTMOD=NO
      CGGTASN=-----  CGPCSN=-----  SELID=-----  OPCS=-----
111263   111263   DPCSSN SSN    001-001-003
      MAPSET=DFLT  SSN=12  CCGT=no  NTT=---  CGGTMOD=NO
      CGGTASN=-----  CGPCSN=-----  SELID=-----  OPCS=-----
111264   111264   DPCSSN SSN    001-001-003
      MAPSET=DFLT  SSN=12  CCGT=no  NTT=---  CGGTMOD=NO
      CGGTASN=-----  CGPCSN=-----  SELID=-----  OPCS=-----
111265   111265   DPCNGT GT     001-001-003
      MRNSET=DFLT  SSN=---  CCGT=no  NTT=12  CGGTMOD=NO
      CGGTASN=-----  CGPCSN=-----  SELID=-----  OPCS=-----
111266   111266   DPCNGT GT     001-001-003
      MRNSET=DFLT  SSN=---  CCGT=no  NTT=12  CGGTMOD=NO
      CGGTASN=-----  CGPCSN=-----  SELID=-----  OPCS=-----
111267   111267   DPCNGT GT     001-001-003
      MRNSET=DFLT  SSN=---  CCGT=no  NTT=12  CGGTMOD=NO
      CGGTASN=-----  CGPCSN=-----  SELID=-----  OPCS=-----

```

Command Retrieved 11 Entries

```

;
rtrv-gta:gttsn=setans002:ssn=10
e1040501 08-09-02 14:25:57 EST EAGLE 39.2.0

GTTSN      NETDOM  SETTYPE  NDGT
setans002  ansi    CDGTA   6

GTA table is (61 of 269999) 1% full.

```



e1040501 08-09-02 14:25:57 EST EAGLE 39.2.0

```

START GTA END GTA XLAT RI PCA
222222 222229 DPCSSN SSN 001-001-002
MAPSET=DFLT SSN=10 CCGT=no NTT=--- CGGTMOD=NO
CGGTASN=----- CGPCSN=----- SELID=----- OPCSN=-----
222232 222239 DPCSSN SSN 001-001-002
MAPSET=DFLT SSN=10 CCGT=no NTT=--- CGGTMOD=NO
CGGTASN=----- CGPCSN=----- SELID=----- OPCSN=-----
222242 222249 DPCSSN SSN 001-001-002
MAPSET=DFLT SSN=10 CCGT=no NTT=--- CGGTMOD=NO
CGGTASN=----- CGPCSN=----- SELID=----- OPCSN=-----
    
```

Command Retrieved 3 Entries

;

**rtrv-gta:gttsn=cgssnset1**

tekelecstp 09-03-10 13:54:32 EST EAGLE 41.0.0

```

GTTSN NETDOM SETTYPE NDGT
cgssnset1 ansi CGSSN -
    
```

GTA table is (50 of 269999) 1% full.

```

START SSN END SSN XLAT RI PCA
1 1 DPC SSN 001-001-002
MAPSET=2 SSN=--- CCGT=no NTT=--- CGGTMOD=NO
34 34 DPC SSN 001-001-002
MAPSET=2 SSN=--- CCGT=no NTT=--- CGGTMOD=NO
100 100 DPC SSN 001-001-002
MAPSET=2 SSN=--- CCGT=no NTT=--- CGGTMOD=NO
101 101 DPC SSN 001-001-002
MAPSET=2 SSN=--- CCGT=no NTT=--- CGGTMOD=NO
102 102 DPC SSN 001-001-002
MAPSET=2 SSN=--- CCGT=no NTT=--- CGGTMOD=NO
103 103 UDTS
104 104 DISC
    
```

Command Retrieved 7 Entries

;

**rtrv-gta:gttsn=cgssnset2**

e1040501 08-09-02 14:11:37 EST EAGLE 39.2.0

```

GTTSN NETDOM SETTYPE NDGT
cgssnset2 ansi CGSSN -
    
```

GTA table is (51 of 269999) 1% full.

;

e1040501 08-09-02 14:11:37 EST EAGLE 39.2.0

```

START SSN END SSN XLAT RI PCA
105 105 DISC
    
```

Command Retrieved 1 Entries

;

**rtrv-gta:gttsn=cgssnset3**

e1040501 08-09-02 14:25:57 EST EAGLE 39.2.0

```

GTTSN NETDOM SETTYPE NDGT
    
```

```
cgssnset3 ansi CGSSN -
GTA table is (51 of 269999) 1% full.
```

;

```
e1040501 08-09-02 14:25:57 EST EAGLE 39.2.0
START SSN          END SSN          XLAT  RI    PCA
Command Retrieved no Entries
```

;

The following example shows output when the OBSR feature is enabled and the FLOBR feature is turned on.

**rtrv-gta:gttsn=setans006**

```
tekelecstp 09-04-19 16:20:44 EST EAGLE 41.0.0
GTTSN      NETDOM  SETTYPE  NDGT
setans006  ansi    CDGTA    6
GTT TABLE IS  1 % FULL (3 of 269999)
START GTA  END GTA  XLAT  RI    PCA
123456    123456  DPC  GT    001-001-002
MRNSET=NONE SSN=--- CCGT=no NTT=--- CGGTMOD=NO
NNP=      NNAI=      NSDD=10 NSDS=9876543210
NGTI=
LOOPSET = none FALLBACK=Yes TESTMODE=on
OPTSN=----- CGSELID=456 CDESELID=----- OPCSN=setopc001
```

;

The following example retrieves a CdPA SSN entry when the TOBR feature is turned on.

**rtrv-gta:gttsn=setcdssn**

```
tekelecstp 09-04-10 09:49:42 EST EAGLE 41.0.0
rtrv-gta:gttsn=setcdssn
Command entered at terminal #4.
GTTSN      NETDOM  NDGT
setcdssn  itu     -
GTT TABLE IS  1 % FULL (5 of 269999)
START SSN          END SSN          XLAT  RI    PC
100              200              DPCNGT GT    1-200-1
SSN=0 CCGT=no NTT=---
FALLBACK=sysdflt TESTMODE=off CGCNVSN=-----
OPTSN=----- CGSELID=----- CDESELID=-----
Command Retrieved 1 Entries
```

;

The following example retrieves an OPCODE entry when the TOBR feature is turned on.

**rtrv-gta:gttsn=opcode2**

```
tekelecstp 09-04-10 23:34:43 EST EAGLE 41.0.0
GTTSN      NETDOM  SETTYPE  NDGT
opcode2    itu     OPCODE   -
GTA table is (3 of 269999) 1% full.
FAMILY      OPCODE      PKGTYPE      XLAT  RI    PC
ACN         OPCODE      PKGTYPE      XLAT  RI    PC
1-2-3      5           cnt          DPC   GT    3-003-3
```

```
SSN=0   CCGT=no   NTT=---
FALLBACK=sysdflt TESTMODE=off
OPTSN=----- CGSELID=----- CDSELID=----- OPCS=-----
```

Command Retrieved 1 Entries

;

The following example retrieves an OPCODE entry when the TOBR feature is turned on.

**rtrv-gta:gttsn=opcode1**

```
tekelecstp 09-04-10 00:08:53 EST EAGLE 41.0.0
```

```
GTTSN      NETDOM  SETTYPE  NDGT
opcode1    ansi    OPCODE    -
```

GTA table is (2 of 269999) 1% full.

```
FAMILY      OPCODE      PKGTYPE      XLAT  RI  PC
7           4           qwp          DPC   GT  002-002-002
SSN=0   CCGT=no   NTT=---
FALLBACK=sysdflt TESTMODE=off
OPTSN=----- CGSELID=----- CDSELID=----- OPCS=-----
```

```
ACN          OPCODE      PKGTYPE      XLAT  RI  PC
```

Command Retrieved 1 Entries

;

**Legend**

**GTTSN**—The GTT set name. A GTT set is an entity to which global title addresses and selectors are assigned.

**NETDOM**—The network domain.

**NDGT**—The number of digits required for GTAs associated with this set.

**START GTA**—The start global title address.

**END GTA**—The end global title address.

**XLAT**—The translate indicator.

**RI**—The routing indicator.

**PC, PCA, ITU PC, ITUI PC, ITUN PC, ITUN24 PC**—Translated point code.

**SSN**—The translated subsystem number.

**CCGT**—The cancel called global title indicator.

**NNP**—New Numbering Plan.

**NNAI**—New Nature of Address Indicator.

**NPDD**—New Prefix Digits to be Deleted.

**NPDS**—New Prefix Digits String.

**NTT**—The new translation type.

**MRN**—Mated Relay Node.

**MRNSET**—MRN set ID.

**MAPSET**—MAP set ID.

**CGGTMOD**—Calling Party Global Title Modification Indicator.

**OPCODE**—TCAP opcode field.

**ACN**—Application context name.ITU TCAP *acn* field.

**PKGTYPE**—TCAP package type.

**FAMILY**—ANSI TCAP *family* field.

**TESTMODE**—Invokes a Test Tool to debug the FLOBR/TOBR rules.

## rtrv-gtcnv

## Retrieve Global Title Conversion

Use this command to display entries in the Default Global Title Conversion table.

**Keyword:** rtrv-gtcnv

**Related Commands:** chg-gtcnv, dlt-gtcnv, ent-gtcnv

**Command Class:** Database Administration

### Parameters

**:dir=** (optional)

Direction of conversion.

**Range:** **atoi, itoa, both**

**atoi**—ANSI to ITU conversion

**itoa**—ITU to ANSI conversion

**both**—Conversion in both directions

**:gtixlat=** (optional)

Global title indicator conversion. This parameter is expressed in the form of the ANSI GTI and the ITU GTI.

**Range:** **22, 24**

**22**—Converts an incoming ANSI GTI 2 to an outgoing ITU GTI 2 or an incoming ITU GTI 2 to an outgoing ANSI GTI 2

**24**—Converts an incoming ANSI GTI 2 to an outgoing ITU GTI 4 or an incoming ITU GTI 4 to an outgoing ANSI GTI 2

**:nai=** (optional)

Nature of address indicator.

**Range:** **0-63 \***

**:np=** (optional)

Numbering plan.

**Range:** **0-15 \***

**:tta=** (optional)

ANSI translation type.

**Range:** **0-255 \***

**:tti=** (optional)

ITU translation type.

**Range:** **0-255 \***

### Example

```
rtrv-gtcnv
```

### Dependencies

The ANSI-ITU-China SCCP Conversion feature must be enabled before the command can be entered.

**Notes**

None

**Output**

The following example displays output containing decimal global title digits.

**rtrv-gtcnv**

```
tekelecstp 06-11-07 13:44:12 EST EAGLE 35.3.0

DIR  GTIXLAT  TTA  TTI  NP  NAI  DEL  POS  ADD
atoi  22    10  5   --- ---  10  pfx  123

GTCNV  table is (1 of 1000) 1% full.
```

;

The following example shows output containing hexadecimal global title digits.

**rtrv-gtcnv**

```
tekelecstp 06-11-07 11:52:58 EST EAGLE 35.3.0

DIR  GTIXLAT  TTA  TTI  NP  NAI  DEL  POS  ADD
atoi  22    1  3   --- ---  ---  pfx  abcdef0123456789abcdef
itoa  24    5  6   2  1   ---  sfx  abcdef0123456789abcef

GTCNV  table is (2 of 1000) 1% full.
```

;

**Legend**

**DIR**—The direction of the translation: ANSI to ITU or ITU to ANSI.

**GTIXLAT**—The GTI translation.

**TTA**—The ANSI translation type

**TTI**—The ITU translation type

**NP**—The numbering plan

**NAI**—The nature of address indicator

**DEL**—The deletion status, listing the number of incoming MSUs that will be deleted prior to translation.

**POS**—The prefix or suffix.

**ADD**—The global title address

**rtrv-gtt****Retrieve Global Title Translation**

Use this command to show one or more entries from the GTT Data and the Translation Type tables. The report that is displayed contains two records (the percentage full and number-of-cells-used field) that give the total entries in the GTT table without regard to the **type** parameter specified.

If the EGTT (Enhanced Global Title Translation) feature is turned on in the system, the system will no longer accept **-gtt** (Global Title Translation) and **-tt** (Translation Type) commands. Refer to the new command sets that replace the **-gtt** and **-tt** commands:

- GTT Selector commands (**ent/chg/dlt/rtrv-gttsel**)
- GTT Set commands (**ent/dlt/rtrv-gttset**)

- GTA commands (**ent/chg/dlt/rtrv-gta**)

**Keyword:** rtrv-gtt

**Related Commands:** chg-gtt, dlt-gtt, ent-gtt

**Command Class:** Database Administration

### Parameters

At least one of these parameters must be specified: **ttn, type/typea/typei/typen/typen24**.

**NOTE:** See "Point Code Formats and Conversion" for a detailed description of point code formats, rules for specification, and examples.

**:cggmod=** (optional)

Calling party global title modification indicator. This parameter displays all translation entries that have the specified value of the calling party GT modification indicator.

**Range:** yes, no

**:egta=** (optional)

End global title address. This parameter specifies the end of a range of global title digits.

**Range:** 1-21 digits

If the Hex Digit Support for GTT feature is not enabled and on, the range is 1 - 21 decimal digits; valid digits are **0-9**.

If the Hex Digit Support for GTT feature is enabled and on, the range is 1 - 21 hexadecimal digits; valid digits are **0-9, a-f, A-F**.

**Default:** If the **gta** parameter is specified, the **egta** parameter default value is the specified **gta** parameter value.

**:force=** (optional)

This parameter allows the user to display more than 1000 entries. This parameter is used to prevent inadvertent displays of extremely large amounts of information, which could take many hours.

**Range:** yes, no

**Default:** no

**:gta=** (optional)

Global title start address. This parameter specifies the beginning of a range of global title digits.

**Range:** 1-21 digits

If the Hex Digit Support for GTT feature is not enabled and on, the range is 1 - 21 decimal digits; valid digits are **0-9**.

If the Hex Digit Support for GTT feature is enabled and on, the range is 1 - 21 hexadecimal digits; valid digits are **0-9, a-f, A-F**.

**Default:** The first GTT entry for the given translation type.

**:loopset=** (optional)

SCCP loopset name. This parameter retrieves translation entries that are associated with the specified loopset.

**Range:** ayyyyyyy, none

1 alphabetic character followed by up to 7 alphanumeric characters.

**none**—Translation entries with no association to any loopset.

**:mapset=** (optional)

MAP set ID.

**Range:** 1-36000 dflt

**dflt**—Default MAP set

**:mrnset=** (optional)

MRN set ID. This parameter retrieves GTT information for a specified Mated Relay Node set.

**Range:** 1-3000 none, dflt  
**dflt**—Default MRN set  
**none**—The GTA translation does not participate in any loadsharing.

**:num=** (optional)

This parameter specifies the number of entries to be shown.

**Range:** 1-1000000  
**1-1000**—If **force=yes** is not specified  
**1-1000000**—If **force=yes** is specified  
**Default:** 1 (if **gta** is specified),  
 20 (if **gta** is not specified).

**:pc=** (optional)

ANSI point code with subfields *network indicator-network cluster-network cluster member (ni-nc-ncm)*. The *prefix* subfield indicates a private point code (*prefix-ni-nc-ncm*).

**Synonym:** **pca**

**Range:** p-, 000-255  
 Specify a valid value for each subfield of the point code, and separate the subfields with a dash (-).  
*prefix*—p-  
 When **chg-sid:pctype=ansi** is specified, **ni = 000** is not valid.  
 When **chg-sid:pctype=ansi** is specified, **nc = 000** is not valid if **ni = 001-005**.  
 When **chg-sid:pctype=ansi** is specified, **nc = 000** is valid if **ni = 006-255**.  
 The point code **000-000-000** is not a valid point code.

**Default:** Display all

**:pc/pca/pci/pcn/pcn24=** (optional)

Point code.

**:pci=** (optional)

ITU international point code with subfields *zone-area-id*. The *prefix* subfield indicates a spare point code, private point code, or private and spare point code (*prefix-zone-area-id*).

**Range:** s-, p-, ps-, 0-255  
 Specify a valid value for each subfield of the point code, and separate the subfields with a dash (-).  
*prefix*—s-, p-, ps-  
*zone*—0-7  
*area*—000-255  
*id*—0-7  
 The point code **0-000-0** is not a valid point code.

**Default:** Display all

**:pcn=** (optional)

ITU national point code in the format of a 5-digit number (*nnnnn*); or 2, 3, or 4 numbers (members) separated by dashes (*m1-m2-m3-m4*) as defined by the **chg-stpopts:npfmti** flexible point code option. A group code must be specified when the ITUDUPPC feature is turned on (*nnnnn-gc*, *m1-m2-m3-m4-gc*). The *prefix* subfield indicates a spare point code, private point code, or private and spare point code (*prefix-nnnnn*, *prefix-nnnnn-gc*, *prefix-m1-m2-m3-m4*, *prefix-m1-m2-m3-m4-gc*).

**Range:** s-, p-, ps-, 0-16383, aa-zz  
 Specify a valid value for each subfield of the point code, and separate the subfields with a dash (-).

*prefix*—**s-**, **p-**, **ps-**

*nnnnn*—**0-16383**

*gc*—**aa-zz**

*m1-m2-m3-m4*—**0-14** for each member; values must sum to 14

**Default:** Display all

**:pcn24=** (optional)

24-bit ITU national point code with subfields *main signaling area-sub signaling area-signaling point (msa-ssa-sp)*. The *prefix* subfield indicates a private point code *prefix-ni-nc-ncm(prefix-ni-nc-ncm)*.

**Range:** **p-, 000-255**

Specify a valid value for each subfield of the point code, and separate the subfields with a dash (-).

*prefix*—**p-**

*msa*—**000-255**

*ssa*—**000-255**

*sp*—**000-255**

**Default:** Display all

**:pctype=** (optional)

Point code type. This parameter can be specified, only when the ANSI-ITU-China SCCP Conversion feature is enabled, to retrieve a single type of point code among mixed types of point code provisioned for a Translation Type.

**Range:** **ansi, itui, itun, itun24, ituis, ituns**

**Default:** Display all

**:ssn=** (optional)

Subsystem number. This parameter specifies the subsystem address that is to receive the message.

**Range:** **002-255**

**Default:** Display all

**:ttn=** (optional)

Translation name.

**Range:** *ayyyyyyy*

1 alphabetic character followed by up to 7 alphanumeric characters

**Default:** None given

**:type/typea/typei/typen/typen24=** (optional)

Translation type identifies the translation type and network type. This parameter is the decimal representation of the 1-byte field used in SS7.

The **type** and **typea** parameters specify an ANSI network.

The **typei** parameter specifies an ITU-international network.

The **typen** parameter specifies an ITU-national network.

The **typen24** parameter specifies a 24-bit ITU-national network.

A translation type numeric value can be entered as ANSI (**type** or **typea**) and also as an ITU type (**typei** or **typen**). However, they are separate entities.

The point code domain translation types for GTT are handled by the EAGLE 5 ISS protocol processing as either ANSI or ITU; therefore, ITU applies to ITU-I, ITU-I Spare, ITU-N, and ITU-N Spare. ITU-I includes ITU-I Spare, and ITU-N includes ITU-N Spare.

**Range:** **0-255**

**Default:** None given



**Example**

```

rtrv-gtt:type=5:ttn=lidb1:gta=919555
rtrv-gtt:type=5:gta=919555
rtrv-gtt:type=5:gta=919555:num=2500:force=yes
rtrv-gtt:typen24=0
rtrv-gtt:typei=7:pctype=ansi
rtrv-gtt:typen=106:pctype=itui
rtrv-gtt:type=55:pctype=itun
rtrv-gtt:type=9:pctype=itun24
rtrv-gtt:typei=4:pci=s-1-24-1
rtrv-gtt:typen=3:pcn=s-124
rtrv-gtt:ttn=tbla
rtrv-gtt:ttn=tbla:mapset=1
rtrv-gtt:type=4:cggmod=yes

```

**Dependencies**

If the EGTT feature is turned on, then the **rtrv-gtt** command cannot be entered.

The ANSI-ITU-China SCCP Conversion feature must be enabled before the **pctype** parameter can be specified.

If the **pcn** parameter is specified, its format must match the format that was assigned with the **chg-stpopts:npcfmti** parameter.

The value of the **tt** parameter must exist in the Translation Type table.

The value of the **tt** parameter must correspond to a value of the **type/typea/typei/typen/typen24** parameter.

If the value of the **num** parameter exceeds **1000**, then the **force=yes** parameter must be specified.

Either the **type** parameter or the **ttn** parameter must be specified.

The value of the **pc/pca/pci/pcn/pcn24** parameter must be a full point code.

If the **egta** parameter is specified, the **gta** parameter must be specified.

If the system is defined as an ANSI system, the **pc/pca** parameter must be specified as a valid ANSI point code.

The **tt** parameter and the **pc/pca/pci/pcn/pcn24** parameter must have matching network types.

The ANSI-ITU-China SCCP Conversion feature must be on before a translated point code and a translation type in different network types can be specified.

The number of digits in the specified **gta** parameter must be at least the number of digits provisioned for the given translation type. If the VGTT (variable length GTT) feature is turned on, there can be up to 10 GTA lengths per translation type. When the **ent-gtt** command is entered to create entries, the software keeps track of the lengths and allows only ten different lengths.

The value of the **tt** parameter must not be defined as an alias.

The Flexible GTT Load Sharing feature must be enabled before the **mapset** parameter can be specified.

The specified MAP set must exist in the database.

The Hex Digit Support for GTT feature must be enabled and on before hexadecimal digits can be specified for the **gta** and **egta** parameters.

The value of the **num** parameter must not exceed the maximum table size.

The length of the **egta** parameter must equal the length of the **gta** parameter.

The value of the **egta** parameter must be greater than the value of the **gta** parameter.

If the **tt** parameter is not specified, then the value of the **ttn** parameter must match the value of a **tt** parameter in the STP database.

The value of the **typen** parameter must exist in the Translation Type table.

The value of the **typei** parameter must exist in the Translation Type table.

The value of the **gta** parameter must exist.

The SCCP Loop Detection feature must be enabled before the **loopset** parameter can be specified.

The value of the **loopset** parameter must already exist in the database.

The Flexible GTT Load Sharing feature must be enabled before the **mrnset** parameter can be specified.

At least one entry must be provisioned in the MRN table for the MRN set that is specified by the **mrnset** parameter.

The AMGTT feature or the AMGTT CgPA Upgrade feature must be turned on before the **eggtmod** parameter can be specified.

The **mapset** parameter and the **mrnset** parameter cannot be specified together in the command.

## Notes

If the **rtrv-gtt** command is entered with only the **gta** parameter, a match would be an entry containing the same number of digits, or more digits, for the translation type. For example, if **gta=8005556666** is specified, the six-digit translation type **800555** would be a match. If the VGTT feature is turned on and the **egta** parameter is specified, all matching entries regardless of length are displayed.

This command can be canceled using the **F9** function key or the **canc-cmd** command. See **canc-cmd** for more information.

If you do not know either the translation type or the translation type name, use the **rtrv-tt** command to obtain type and name.

Due to the size of these tables (up to 270,000 possible entries), a limit (65,535) is placed on the number of entries that can be printed at one time.

In this command, only ITU-international and ITU national point codes support the spare point code subtype prefix (**s-**) and the private and spare point code subtype prefix (**ps-**). All of the point code types support the private (internal) point code subtype prefix (**p-**).

The number of entries to be shown (the **num** parameter) can be specified for any valid combination of parameters.

If the **gta** parameter is not specified, then the first entry in the global title translation table that corresponds to the translation type is the first entry shown.

If the **num** and **gta** parameters are not specified, then up to 20 entries are shown.

If the **gta** parameter is specified, but the **num** parameter is not specified, then only one entry is shown.

If the **num** parameter is specified, then the number of entries shown is the lesser of the number of entries in the table from the defined starting point to the end, or the value of the **num** parameter.

If the **gta** and **egta** parameters are specified, then the entry that matches the **gta** parameter, or is the nearest entry below the **gta** parameter, is the first entry shown for the specified range.

Output

**rtrv-gtt:type=10:num=65535:force=yes**

```
tekelecstp 09-03-10 13:54:32 EST EAGLE 41.0.0
TYPEA      TTN      NDGT
   3      c800      10
```

GTT table is (9 of 269999) 1% full.

| START GTA  | END GTA    | XLAT   | RI  | PCA         |
|------------|------------|--------|-----|-------------|
| 9195551212 |            | DPCSSN | SSN | 008-001-001 |
| SSN=222    | NGT=---    |        |     |             |
| 8005550000 | 8005551999 | DPCSSN | SSN | 001-254-255 |
| SSN=255    | NGT=---    |        |     |             |
| 8005552000 | 8005553999 | DPC    | GT  | 001-254-255 |
| SSN=---    | NGT=---    |        |     |             |
| 8005554000 | 8005555999 | DPCNGT | GT  | 001-254-255 |
| SSN=---    | NGT=123    |        |     |             |
| 8005556000 | 8005557999 | DPCSSN | SSN | 001-254-255 |
| SSN=255    | NGT=---    |        |     |             |
| 8005558000 | 8005559999 | DPCSSN | SSN | 001-254-255 |
| SSN=255    | NGT=---    |        |     |             |
| 9762428487 |            | DPCSSN | SSN | 001-254-255 |
| SSN=222    | NGT=---    |        |     |             |
| 9766423277 |            | DPCSSN | SSN | 001-254-255 |
| SSN=222    | NGT=---    |        |     |             |
| 9769388928 |            | DPCSSN | SSN | 001-254-255 |
| SSN=222    | NGT=---    |        |     |             |

Command Retrieved 9 Entries

;

**rtrv-gtt:type=10:dpc=8-1-1:ssn=222:gta=9195551212**

```
rlghncxa03w 08-09-07 11:43:04 EST EAGLE 39.2.0
TYPEA      TTN      NDGT
   3      c800      10
```

GTT table is (9 of 269999) 1% full.

| START GTA  | END GTA | XLAT   | RI  | PCA         | SSN | NGT |
|------------|---------|--------|-----|-------------|-----|-----|
| 9195551212 |         | DPCSSN | SSN | 008-001-001 | 222 | --- |

Command Retrieved 1 Entries

;

**rtrv-gtt:typen=10**

```
rlghncxa03w 08-09-07 11:43:04 EST EAGLE 39.2.0
TYPEN      TTN      NDGT
   10      -----      6
```

GTT table is (9 of 269999) 1% full.

| START GTA | END GTA | XLAT | RI | ITU PC     | SSN | NGT |
|-----------|---------|------|----|------------|-----|-----|
| 123456    | 123456  | DPC  | GT | 0500-1-0-1 | --- | --- |

Command Retrieved 1 Entries

;

The following example shows a retrieval of all GTTs for a specified translation when the VGTT (variable length GTT) feature is turned on:

**rtrv-gtt:type=10:num=65535:force=yes**

```
tekelecstp 09-03-10 13:54:32 EST EAGLE 41.0.0
TYPEA      TTN      NDGT
10         c800      6, 8, 10
```

GTT table is (17 of 269999) 1% full.

| START GTA  | END GTA         | XLAT   | RI  | PCA         |
|------------|-----------------|--------|-----|-------------|
| 976242     |                 | DPCSSN | SSN | 001-254-255 |
|            | SSN=222 NGT=--- |        |     |             |
| 976642     |                 | DPCSSN | SSN | 001-254-255 |
|            | SSN=222 NGT=--- |        |     |             |
| 976938     |                 | DPCSSN | SSN | 001-254-255 |
|            | SSN=222 NGT=--- |        |     |             |
| 80055500   | 80055519        | DPCSSN | SSN | 001-254-255 |
|            | SSN=255 NGT=--- |        |     |             |
| 80055520   | 80055539        | DPC    | GT  | 001-254-255 |
|            | SSN=--- NGT=--- |        |     |             |
| 80055540   | 80055559        | DPCNGT | GT  | 001-254-255 |
|            | SSN=--- NGT=123 |        |     |             |
| 80055560   | 80055579        | DPCSSN | SSN | 001-254-255 |
|            | SSN=255 NGT=--- |        |     |             |
| 80055580   | 80055599        | DPCSSN | SSN | 001-254-255 |
|            | SSN=255 NGT=--- |        |     |             |
| 9195551212 |                 | DPCSSN | SSN | 008-001-001 |
|            | SSN=222 NGT=--- |        |     |             |
| 8005550000 | 8005551999      | DPCSSN | SSN | 001-254-255 |
|            | SSN=255 NGT=--- |        |     |             |
| 8005552000 | 8005553999      | DPC    | GT  | 001-254-255 |
|            | SSN=--- NGT=--- |        |     |             |
| 8005554000 | 8005555999      | DPCNGT | GT  | 001-254-255 |
|            | SSN=--- NGT=123 |        |     |             |
| 8005556000 | 8005557999      | DPCSSN | SSN | 001-254-255 |
|            | SSN=255 NGT=--- |        |     |             |
| 8005558000 | 8005559999      | DPCSSN | SSN | 001-254-255 |
|            | SSN=255 NGT=--- |        |     |             |
| 9762428487 |                 | DPCSSN | SSN | 001-254-255 |
|            | SSN=222 NGT=--- |        |     |             |
| 9766423277 |                 | DPCSSN | SSN | 001-254-255 |
|            | SSN=222 NGT=--- |        |     |             |
| 9769388928 |                 | DPCSSN | SSN | 001-254-255 |
|            | SSN=222 NGT=--- |        |     |             |

Command Retrieved 17 Entries

;

The following example shows output containing GT Modification **nnp**, **nnai**, **npdd**, and **npds** parameter values:

**rtrv-gtt:type=7**

```
rlghncxa03w 08-09-07 11:43:04 EST EAGLE 39.2.0
TYPEA      TTN      NDGT
7          isvm      3,6,7,10
```

GTT table is (17 of 269999) 1% full.

| START GTA | END GTA | XLAT   | RI  | PCA         | SSN | NGT |
|-----------|---------|--------|-----|-------------|-----|-----|
| 564       | 564     | DPCSSN | SSN | 248-006-015 | 245 | --- |
|           |         |        |     |             |     |     |
| 641       | 641     | DPCSSN | SSN | 248-006-015 | 245 | --- |
|           |         |        |     |             |     |     |
| 589234    | 598744  | DPCSSN | SSN | 248-006-015 | 245 | --- |
|           |         |        |     |             |     |     |

```

648392                659832                NNP=10 NNAI=50 NPDD=3 NPDS=345
DPCSSN SSN 248-006-015 245 ---

Command Retrieved 4 Entries

```

;

The following example shows output when the GTT table can contain up to 1,000,000 entries:

**rtrv-gtt:type=7**

```

tekelecstp 09-03-10 13:54:32 EST EAGLE 41.0.0
TYPEA   TTN      NDGT
7       isvm     3,6,7,10

GTT table is (17 of 1000000) 1% full.

GTT table is (17 of 1000000) 1% full.

START GTA           END GTA           XLAT  RI      PCA
564                564                DPCNGT GT  248-006-015
      SSN=--- NGT=123 CGGTMOD = NO
      NNP=3  NNAI=100 NSDD=3  NSDS=345
      NGTI=
641                641                DPCNGT GT  248-006-015
      SSN=--- NGT=123 CGGTMOD = NO
589234            598744            DPCNGT GT  248-006-015
      SSN=--- NGT=123 CGGTMOD = NO
      NNP=10 NNAI=50 NSDD=3  NSDS=345
      NGTI=
648392            659832            DPCSSN SSN  248-006-015
      SSN=245 NGT=--- CGGTMOD = NO

Command Retrieved 4 Entries

```

;

The following example shows output for a 24-bit ITU-N point code translation type of 4:

**rtrv-gtt:typen24=4**

```

rlghncxa03w 08-09-07 11:43:04 EST EAGLE 39.2.0
TYPEN24  TTN      NDGT
4       - - - - - 6

GTT table is (1 of 269999) 1% full.

START GTA           END GTA           XLAT  RI  ITU PC      SSN NGT
919833            919833            DPCSSN SSN 008-008-008 20 ---

Command Retrieved 1 Entries

```

;

The following example shows output when the ANSI-ITU-China SCCP Conversion feature is enabled, with suffix digits and new GTI code parameter values.

**NOTE: When the ANSI-ITU-China SCCP Conversion feature is enabled, entries that are provisioned with xlat=dpc where ngt has been specified are displayed with an xlat of dpcngt.**

**rtrv-gtt:typei=7**

```

tekelecstp 09-03-10 13:54:32 EST EAGLE 41.0.0
TYPEI   TTN      NDGT
7       isvm     3,6,7,10

GTT table is (17 of 1000000) 1% full.

START GTA           END GTA           XLAT  RI      PC

```

```

564          564          DPCNGT GT      002-136-005
  SSN=--- NGT=123  CGGTMOD = NO
  NNP=3  NNAI=100  NSDD=3  NSDS=345
  NGTI=4
641          641          DPCNGT GT      16383
  SSN=--- NGT=123  CGGTMOD = NO
  NNP=   NNAI=   NSDD=0  NSDS=
  NGTI=2
589234      598744      DPCNGT GT      3-006-1
  SSN=--- NGT=123  CGGTMOD = NO
  NNP=10 NNAI=50  NPDD=3  NPDS=345
  NGTI=4
648392      659832      DPCSSN SSN    007-006-005
  SSN=245 NGT=---  CGGTMOD = NO

```

Command Retrieved 4 Entries

;

The following example shows output when the ANSI-ITU-China SCCP Conversion feature is enabled and the **pctype=ansi** parameter is specified.

**rtrv-gtt:typei=7:pctype=ansi**

```

tekelecstp 09-03-10 13:54:32 EST  EAGLE 41.0.0
TYPEI      TTN      NDGT
7          isvm     3,6,7,10

```

GTT table is (17 of 1000000) 1% full.

```

START GTA          END GTA          XLAT  RI      PCA
564              564              DPCNGT GT      002-136-005
  SSN=--- NGT=123  CGGTMOD = NO
  NNP=   NNAI=   NSDD=3  NSDS=345
  NGTI=2
648392          659832          DPCSSN SSN    007-006-005
  SSN=245 NGT=123  CGGTMOD = NO

```

Command Retrieved 2 Entries

;

The following example shows output when the ANSI-ITU-China SCCP Conversion feature is enabled and the **pctype=itui** parameter is specified.

**rtrv-gtt:typen=106:pctype=itui**

```

rlghncxa03w 08-09-07 11:43:04 EST  EAGLE 39.2.0
TYPEN      TTN      NDGT
106        ntoi43    6

```

GTT table is (17 of 1000000) 1% full.

```

START GTA          END GTA          XLAT  RI  ITUI PC      SSN NGT
300006            300006            DPCNGT GT  6-002-3  --- 33
  NNP=6  NNAI=7  NPDD=0  NPDS=
  NGTI=4

```

Command Retrieved 1 Entries

;

The following example shows output when the ANSI-ITU-China SCCP Conversion feature is enabled and the **pctype=itun** parameter is specified.

**rtrv-gtt:type=55:pctype=itun**

```

rlghncxa03w 08-09-07 11:43:04 EST  EAGLE 39.2.0
TYPEA      TTN      NDGT

```

55 aton44 7

GTT table is (17 of 1000000) 1% full.

|                                     |         |        |    |       |    |     |     |
|-------------------------------------|---------|--------|----|-------|----|-----|-----|
| START GTA                           | END GTA | XLAT   | RI | ITUN  | PC | SSN | NGT |
| 6543210                             | 6543210 | DPCNGT | GT | 12341 |    | --- | 42  |
| NNP=3 NNAI=1 NPDD=0 NPDS=<br>NGTI=4 |         |        |    |       |    |     |     |

Command Retrieved 1 Entries

;

The following example shows output when the ANSI-ITU-China SCCP Conversion feature is enabled and the **pctype=itun24** parameter is specified.

**rtrv-gtt:type=9:pctype=itun24**

tekelecstp 09-03-10 13:54:32 EST EAGLE 41.0.0  
 TYPE TTN NDGT  
 7 isvm 3,6,7,10

GTT table is (17 of 1000000) 1% full.

|                                                                          |         |        |     |             |    |
|--------------------------------------------------------------------------|---------|--------|-----|-------------|----|
| START GTA                                                                | END GTA | XLAT   | RI  | ITUN24      | PC |
| 764                                                                      | 864     | DPCNGT | GT  | 002-136-005 |    |
| SSN=--- NGT=123 CGGTMOD = NO<br>NNP=3 NNAI=100 NSDD=3 NSDS=345<br>NGTI=4 |         |        |     |             |    |
| 668392                                                                   | 689832  | DPCSSN | SSN | 007-006-005 |    |
| SSN=245 NGT=--- CGGTMOD = NO                                             |         |        |     |             |    |

Command Retrieved 2 Entries

;

**rtrv-gtt:typen=3**

rlghncxa03w 08-09-07 11:43:04 EST EAGLE 39.2.0  
 TYPEN TTN NDGT  
 3 ----- 6,21

GTT table is (6 of 269999) 1% full.

|                                                                                |                       |        |    |            |    |
|--------------------------------------------------------------------------------|-----------------------|--------|----|------------|----|
| START GTA                                                                      | END GTA               | XLAT   | RI | ITU        | PC |
| 123456                                                                         | 123456                | DPCSSN | GT | s-00124-aa |    |
| SSN=10 NGT=---<br>NNP=12 NNAI=125 NPDD=21 NPDS=125498679012426556356<br>NGTI=  |                       |        |    |            |    |
| 234567                                                                         | 234567                | DPCNGT | GT | s-00124-aa |    |
| SSN=--- NGT=255                                                                |                       |        |    |            |    |
| 234568                                                                         | 234568                | DPC    | GT | s-00124-aa |    |
| SSN=--- NGT=---                                                                |                       |        |    |            |    |
| 234569                                                                         | 234569                | DPC    | GT | s-00124-aa |    |
| SSN=--- NGT=---<br>NNP=13 NNAI=120 NPDD=21 NPDS=125498679012426556356<br>NGTI= |                       |        |    |            |    |
| 334569467213456789012                                                          | 334569478932012345678 | DPC    | GT | s-00124-aa |    |
| SSN=--- NGT=---<br>NNP=13 NNAI=120 NPDD=21 NPDS=125498679012426556356<br>NGTI= |                       |        |    |            |    |

Command Retrieved 5 Entries

;

**rtrv-gtt:typen=3:pcn=s-124-aa**

```
rlghncxa03w 08-09-07 11:43:04 EST EAGLE 39.2.0
TYPEN      TTN      NDGT
3          - - - - - 6,21
```

GTT table is (6 of 269999) 1% full.

```
START GTA      END GTA      XLAT  RI      ITU PC
123456         123456         DPCSSN GT  s-00124-aa
      SSN=10  NGT=---
      NNP=12  NNAI=125 NPDD=21 NPDS=125498679012426556356
      NGTI=
234567         234567         DPCNGT GT  s-00124-aa
      SSN=---  NGT=255
234568         234568         DPC      GT  s-00124-aa
      SSN=---  NGT=---
234569         234569         DPC      GT  s-00124-aa
      SSN=---  NGT=---
      NNP=13  NNAI=120 NPDD=21 NPDS=125498679012426556356
      NGTI=
334569467213456789012 334569478932012345678 DPC      GT  s-00124-aa
      SSN=---  NGT=---
      NNP=13  NNAI=120 NPDD=21 NPDS=125498679012426556356
      NGTI=
```

Command Retrieved 5 Entries

;

**rtrv-gtt:typen=3:ssn=104**

```
rlghncxa03w 08-09-07 11:43:04 EST EAGLE 39.2.0
TYPEN      TTN      NDGT
3          - - - - - 6
```

GTT table is (5 of 269999) 1% full.

```
START GTA      END GTA      XLAT  RI      ITU PC
123456         123456         DPCSSN GT  s-00124-aa
      SSN=10  NGT=---
      NNP=12  NNAI=125 NPDD=21 NPDS=125498679012426556356
      NGTI=
```

Command Retrieved 1 Entries

;

In the following example, the Flexible GTT Load Sharing feature is not on.

**rtrv-gtt:ttn=tbla**

```
tekelecstp 08-09-10 15:50:49 EST EAGLE 39.2.0
TYPEA      TTN      NDGT
10         tbla      6
```

GTT table is (2 of 269999) 1% full.

```
START GTA      END GTA      XLAT  RI      PCA
123456         123456         DPC      GT  001-001-001
      SSN=---  NGT=---
234567         234567         DPCSSN SSN  001-001-001
      SSN=2    NGT=---
```

Command Retrieved 21 Entries

;



The following example shows an MRN set value of NONE. The Flexible GTT Load-Sharing feature and the Intermediate GTT Load Sharing feature are on.

```
rtrv-gtt:ttn=tbl1
tekelecstp 08-09-10 13:54:32 EST EAGLE 39.2.0
TYPEA      TTN          NDGT
1           tbl1        10

GTT table is (1 of 269999) 1% full.

START GTA          END GTA          XLAT  RI      PCA
1234567890        1234567890      DPC   GT     001-001-002
MRNSET=NONE  SSN=--- NGT=---
```

Command Retrieved 21 Entries

The following example shows output when the Flexible GTT Load Sharing feature and the Origin-based SCCP feature are on.

```
rtrv-gtt:ttn=tbla
tekelecstp 08-09-10 14:51:59 EST EAGLE 39.2.0

GTTSN      NETDOM  NDGT
tbla       ansi    6,10

GTA table is (61 of 269999) 1% full

START GTA  END GTA  XLAT  RI      PCA
234567     234567   DPCSSN GT     001-001-001
MRNSET=DFLT SSN=10  CCGT=no NTT=---
CGGTASN=----- CGPCSN=----- SELID=----- OPCSN=-----
9810012345 9850012345 DPCSSN SSN     001-001-001
MAPSET=DFLT SSN=10  CCGT=no NTT=---
CGGTASN=----- CGPCSN=----- SELID=----- OPCSN=-----

Command Retrieved 2 Entries
```

The following example shows output when the Hex Digit Support for GTT feature is turned on and hexadecimal digits are included in GTA values.

```
rtrv-gtt:typen=201
tekelecstp 08-09-11 13:36:23 EST EAGLE 39.2.0

TYPEN      TTN          NDGT
201        -----    6,21

GTT table is (5 of 269999) 1% full.

START GTA          END GTA          XLAT  RI      PC
100000            10000d          DPC   GT     00101
SSN=--- NGT=---
10000e            10000f          DPC   GT     00101
SSN=--- NGT=---
100010            200000          DPC   GT     00101
SSN=--- NGT=---
abcdef0123456789abcdef fabcde01234567890afff DPCSSN SSN 00103
SSN=10 NGT=---
fbcdef0123456789abcdef ffbfde01234567890aaff DPCSSN SSN 00103
SSN=10 NGT=---
NNP=   NNAI=   NSDD=4 NSDS=abcdef0123456789
NGTI=
```

Command Retrieved 5 Entries

;

The following example shows output when the SCCP Loop Detection feature is enabled and an associated loopset entry exists.

**rtrv-gtt:ttn=setssn:mapset=6**

```
tekelecstp 08-09-10 09:49:42 EST EAGLE 39.2.0
TYPEA      TTN      NDGT
1          setssn   10

GTT table is (45 of 269999) 1% full.

START GTA  END GTA      XLAT  RI      PCA          LOOPSET
1111111111 1111111122 DPCSSN SSN    001-001-003 RALEIGH1
          MAPSET=6      SSN=2   CCGT=no  NTT=----
```

Command Retrieved 1 Entries

;

The following example shows output for a specified MRN set when the Flexible GTT Load Sharing feature is enabled.

**rtrv-gtt:ttn=tbla:mrnset=1**

```
tekelecstp 08-09-03 12:41:25 EST EAGLE 39.2.0
TYPEA      TTN      NDGT
2          tbla    4

GTT table is (4 of 269999) 1% full.

START GTA          END GTA          XLAT  RI      PCA
2133              2133              DPC   GT      001-001-003
          MRNSET=1      SSN=--- NGT=----
```

Command Retrieved 1 Entries

;

The following example retrieves all examples of translation type 4 where calling party global title modification is requested.

**rtrv-gtt:type=4:cggmod=yes**

```
tekelecstp 08-09-29 16:21:15 EST EAGLE 39.2.0

TYPEA      TTN      NDGT
4          -----  6

GTT table is (1 of 269999) 1% full.

START GTA          END GTA          XLAT  RI      PCA
981234              981234              DPC   GT      001-001-001
          MRNSET=DFLT  SSN=--- NGT=--- CCGTMOD=yes
          NNP=14  NNAI=      NPDD=0  NPDS=
          NGTI=
          LOOPSET = none
```

Command Retrieved 1 Entries

;

**rtrv-gtt:type=1:num=22**

```
e1040501 08-09-02 13:14:49 EST EAGLE 39.2

TYPEA      TTN      NDGT
1          -----  6

GTT table is (22 of 269999) 1% full.
```

;

e1040501 08-09-02 13:14:49 EST EAGLE 39.2

| START GTA | END GTA  | XLAT | RI | PCA         |
|-----------|----------|------|----|-------------|
| 111111    | 111111   | DPC  | GT | 001-001-002 |
| SSN=----  | NGT=---- |      |    |             |
| 111112    | 111112   | DPC  | GT | 001-001-002 |
| SSN=----  | NGT=---- |      |    |             |
| 111113    | 111113   | DPC  | GT | 001-001-002 |
| SSN=----  | NGT=---- |      |    |             |
| 111114    | 111114   | DPC  | GT | 001-001-002 |
| SSN=----  | NGT=---- |      |    |             |
| 111115    | 111115   | DPC  | GT | 001-001-002 |
| SSN=----  | NGT=---- |      |    |             |
| 111116    | 111116   | DPC  | GT | 001-001-002 |
| SSN=----  | NGT=---- |      |    |             |
| 111117    | 111117   | DPC  | GT | 001-001-002 |
| SSN=----  | NGT=---- |      |    |             |
| 111118    | 111118   | DPC  | GT | 001-001-002 |
| SSN=----  | NGT=---- |      |    |             |
| 111119    | 111119   | DPC  | GT | 001-001-002 |
| SSN=----  | NGT=---- |      |    |             |
| 111120    | 111120   | DPC  | GT | 001-001-002 |
| SSN=----  | NGT=---- |      |    |             |
| 111121    | 111121   | DPC  | GT | 001-001-002 |
| SSN=----  | NGT=---- |      |    |             |
| 111122    | 111122   | DPC  | GT | 001-001-002 |
| SSN=----  | NGT=---- |      |    |             |
| 111123    | 111123   | DPC  | GT | 001-001-002 |
| SSN=----  | NGT=---- |      |    |             |
| 111124    | 111124   | DPC  | GT | 001-001-002 |
| SSN=----  | NGT=---- |      |    |             |
| 111125    | 111125   | DPC  | GT | 001-001-002 |
| SSN=----  | NGT=---- |      |    |             |
| 111126    | 111126   | DPC  | GT | 001-001-002 |
| SSN=----  | NGT=---- |      |    |             |
| 111127    | 111127   | DPC  | GT | 001-001-002 |
| SSN=----  | NGT=---- |      |    |             |
| 111128    | 111128   | DPC  | GT | 001-001-002 |
| SSN=----  | NGT=---- |      |    |             |
| 111129    | 111129   | DPC  | GT | 001-001-002 |
| SSN=----  | NGT=---- |      |    |             |
| 111130    | 111130   | DPC  | GT | 001-001-002 |
| SSN=----  | NGT=---- |      |    |             |
| 111131    | 111131   | DPC  | GT | 001-001-002 |
| SSN=----  | NGT=---- |      |    |             |

Command Retrieved 21 Entries

;

rtrv-gtt:type=2

e1040501 08-09-02 13:15:11 EST EAGLE 39.2.0

| TYPEA | TTN   | NDGT |
|-------|-------|------|
| 2     | ----- | 6    |

GTT table is (22 of 269999) 1% full.

;

e1040501 08-09-02 13:15:11 EST EAGLE 39.2.0

| START GTA | END GTA  | XLAT   | RI  | PCA         |
|-----------|----------|--------|-----|-------------|
| 222222    | 222229   | DPCSSN | SSN | 001-001-002 |
| SSN=10    | NGT=---- |        |     |             |

Command Retrieved 1 Entries

```
;
rtrv-gtt:type=1:gta=111268:egta=222259
e1040501 08-09-02 13:31:05 EST EAGLE 39.2.0
```

```
TYPEA   TTN       NDGT
1       - - - - - 6
```

GTT table is (37 of 269999) 1% full.

```
;
e1040501 08-09-02 13:31:05 EST EAGLE 39.2.0
```

```
START GTA          END GTA          XLAT  RI    PCA
111268            111268            DPCNGT GT    001-001-002
      SSN=--- NGT=18  CGGTMOD = NO
111269            111269            DPCNGT GT    001-001-002
      SSN=--- NGT=18  CGGTMOD = NO
      NNP=10 NNAI=   NPDD=0 NPDS=
      NGTI=
111270            111270            DPCNGT GT    001-001-002
      SSN=--- NGT=18  CGGTMOD = NO
      NNP=   NNAI=5  NPDD=3 NPDS=
      NGTI=
222252            222259            DPCSSN SSN   001-001-002
      SSN=12 NGT=---  CGGTMOD = NO
```

Command Retrieved 4 Entries

```
;
rtrv-gtt:type=1:mapset=1
e1040501 08-09-02 13:38:25 EST EAGLE 39.2.0
```

```
TYPEA   TTN       NDGT
1       - - - - - 3,6
```

GTT table is (41 of 269999) 1% full.

```
;
e1040501 08-09-02 13:38:25 EST EAGLE 39.2.0
```

```
START GTA          END GTA          XLAT  RI    PCA
105              105              DPCSSN SSN   001-001-003
      MAPSET=1      SSN=14  NGT=---  CGGTMOD = NO
```

Command Retrieved 1 Entries

```
;
rtrv-gtt:type=1:ssn=10
e1040501 08-09-02 13:33:10 EST EAGLE 39.2.0
```

```
TYPEA   TTN       NDGT
1       - - - - - 3,6
```

GTT table is (40 of 269999) 1% full.

```
;
e1040501 08-09-02 13:33:10 EST EAGLE 39.2.0
```

```

START GTA          END GTA          XLAT  RI    PCA
100                100                DPCSSN SSN  001-001-002
      SSN=10  NGT=---- CGGTMOD = NO
101                101                DPCSSN SSN  001-001-003
      SSN=10  NGT=---- CGGTMOD = NO
104                104                DPCSSN SSN  001-001-003
      SSN=10  NGT=---- CGGTMOD = NO

```

Command Retrieved 3 Entries

;

**Legend**

**TYPE/TYPEA/TYPEI/TYPEN /TYPEN24**—The translation type.

**TTN**—The translation name.

**NDGT**—The number of digits.

**GTT TABLE IS 10% FULL**—The relative size of the GTT table.

**x of y**—Number of entries in the table (x) and the maximum number of entries configured for the table (y)

**START GTA**—Global title start address.

**END GTA**—Global title end address.

**XLAT**—Translate indicator.

**RI**—Route indicator.

**PC, PCA, ITU PC, ITUI PC, ITUN PC, ITUN24 PC**—Point code.

**SSN**—Subsystem number.

**NGT**—New global title translation type. This field identifies the type of global title translation that replaces the original type.

**NNP**—New Numbering Plan.

**NNAI**—New Nature of Address Indicator.

**NPDD**—New Prefix Digits to be Deleted.

**NPDS**—New Prefix Digits String.

**NSDD**—New Suffix Digits to be Deleted.

**NSDS**—New Suffix Digits String

**NGTI**—New GTI code. When the ANSI-ITU-China SCCP Conversion and AMGTT features are on and the Translated Point Code is of a different network type, the *NGTI* value indicates whether the new GTI translation format is GTI type 2 or GTI type 4.

**MRN**—Mated Relay Node.

**MRNSET**—MRN set ID.

**MAPSET**—MAP set ID.

**CGGTMOD**—Calling Party GT Modification Indicator.

**rtrv-gttset**

**Retrieve GTT Selectors**

Use this command to display a list of administered global title selector combinations required for a global title entry. The list can be filtered by using various parameter combinations.

**Keyword:** rtrv-gtttsel

**Related Commands:** chg-gtttsel, dlt-gtttsel, ent-gtttsel

**Command Class:** Database Administration

### Parameters

**NOTE: The Origin-based SCCP Routing (OBSR) feature must be enabled before the cdgtasn, cggtsn, cgpcsn, or cgssn parameter can be specified. If the Flexible Linkset Optional Based Routing (FLOBR) feature is turned on, then the cdgtasn, cggtsn, and cgpcsn parameters cannot be specified.**

**NOTE: The FLOBR feature must be turned on before the cdgttsn, cggtsn, eaglegen, or lsn parameter can be specified.**

**NOTE: The OBSR feature must be enabled or the FLOBR feature must be turned on before the selid parameter can be specified.**

**NOTE: If the OBSR feature is enabled, or the FLOBR feature is turned on, then the gttsn parameter cannot be specified.**

**:cdgtasn=** (optional)

CdPA GTA GTT set name.

**Range:** ayyyyyyyy

1 leading alphabetic character and up to 8 following alphanumeric characters.

**:cdgttsn=** (optional)

CdPA GTT set.

**Range:** ayyyyyyyy

1 leading alphabetic and up to 8 following alphanumeric characters.

**:cggtsn=** (optional)

CgPA GTA GTT set name.

**Range:** ayyyyyyyy

1 leading alphabetic character and up to 8 following alphanumeric characters.

**:cggtsn=** (optional)

CgPA GTT set.

**Range:** ayyyyyyyy

1 leading alphabetic and up to 8 following alphanumeric characters.

**:cgpcsn=** (optional)

CgPA PC GTT set name.

**Range:** ayyyyyyyy

1 leading alphabetic character and up to 8 following alphanumeric characters.

**:cgssn=** (optional)

CgPA subsystem number.

**Range:** 0-255

**:eaglegen=** (optional)

This parameter specifies whether the selector is used by EAGLE 5 ISS generated messages.

**Range:** yes

yes — The selector is used by EAGLE 5 ISS generated messages

**:gti/gtia/gtii/gtin/gtin24=** (optional)

Global title indicator. For all EGTT selector commands, the domain is defined as **gti** and **gtia** (ANSI), **gtii** (ITU international), **gtin** (ITU national), and **gtin24** (24-bit ITU national).

For the selector commands, **gti** and **gtia** are equivalent; **gtii** and **gtin /gtin24** are mutually exclusive because the EGTT database does not distinguish between ITU national and ITU international translations. This means that while ITU-I and ITU-N selectors are stored separately, two separate ITU-I and ITU-N entries with the same selector values cannot exist. For example, if an entry with **gtii=2** and **tt=4** already exists, an entry of **gtin=2** and **tt=4** cannot be entered.

**Range:** Supported value for ANSI: **gti=2** and **gtia=2**  
Supported values for ITU: **gtii=2, 4** and **gtin /gtin24=2, 4**

**Default:** Display all

**:gttsn=** (optional)

GTT set name. A GTT set is an entity to which global title addresses and selectors are assigned.

**Range:** *ayyyyyyy*  
1 leading alphabetic and up to 8 following alphanumeric characters.

**Default:** Display all

**:lsn=** (optional)

Linkset name.

**Range:** *ayyyyyyy*  
1 alphabetic character followed by up to 9 alphanumeric characters

**:nai=** (optional)

Nature of Address indicator. The Nature of Address indicator can be specified by supplying either a mnemonic value (**nai** parameter) or an explicit numeric value (**naiv** parameter). Either the **nai** parameter or the **naiv** parameter, but not both, can be specified in the command. Table A-5 shows the mapping between the **naiv** and the **nai** parameter values.

**Range:** **sub, rsvd, natl, intl, dflt**

**Default:** Display all

**:naiv=** (optional)

Nature of Address indicator value. The Nature of Address indicator can be specified by supplying either a mnemonic value (**nai** parameter) or an explicit numeric value (**naiv** parameter). Either the **nai** parameter or the **naiv** parameter, but not both, can be specified in the command. Table A-5 shows the mapping between the **naiv** and the **nai** parameter values.

**Range:** **0-127**

**Default:** Display all

**:np=** (optional)

Numbering Plan. The numbering plan can be specified by supplying either a mnemonic value (**np** parameter) or an explicit numeric value (**npv** parameter). Either the **np** parameter or the **npv** parameter, but not both, can be specified in the command. Table A-6 shows the mapping between the **npv** and the **np** parameter values.

**Range:** **e164, generic, x121, f69, e210, e212, e214, private, dflt**

**Default:** Display all

**:npv=** (optional)

Numbering Plan value. The numbering plan can be specified by supplying either a mnemonic value (**np** parameter) or an explicit numeric value (**npv** parameter). Either the **np** parameter or the **npv** parameter, but not both, can be specified in the command. Table A-6 shows the mapping between the **npv** and the **np** parameter values.

**Range:** **0-15**

**Default:** Display all

**:selid=** (optional)  
 Selector ID.  
**Range:** 0-65534

**:tt=** (optional)  
 Translation type.  
**Range:** 0-255  
**Default:** Display all

### Example

```
rtrv-gttset
rtrv-gttset:gtii=2
rtrv-gttset:tt=0:np=e164
rtrv-gttset:gti=2:tt=10
rtrv-gttset:gttsn=setint000
rtrv-
gttset:gtia=2:tt=21:cggttsn=setcgpc:cdgttsn=setcdgta:cgssn=20:sel
id=1:lsn=ls10
rtrv-gttset:gtia=2:tt=2:lsn=ls1010
rtrv-gttset:gtia=2:eaglegen=yes
```

### Dependencies

The EGTT feature must be turned on before this command can be entered.

Only entries that exactly match all specified parameters will be displayed. If no match is found, the following message is displayed in the Scroll Area of the terminal:

```
No GTT Selectors matching the specified criteria were found.
```

The **np** and **npv** parameters cannot be specified together in the same command.

The **nai** and **naiv** parameters cannot be specified together in the same command.

The parameter values **gtia=4**, **gti/gtia/gtii/gtin/gtin24=1**, and **gti/gtia/gtii/gtin/gtin24=3** cannot be specified.

When the **gti/gtia/gtii/gtin/gtin24=2** parameter is specified, the **np/npv** and **nai/naiv** parameter combinations cannot be specified.

If a full GTT selector key is specified by the **gti(x)**, **tt**, **np/npv**, **nai/naiv**, **cgssn**, **selid**, and **lsn** parameters, then the GTT set specified by the **cgpcsn**, **cggtasn**, or **cggttsn** parameters cannot be specified.

The OBSR feature must be enabled before the **cggtasn**, **cgpcsn**, **cgssn**, or **cdgtasn** parameters can be specified.

The GTT set specified by the **cggtasn** or **cgpcsn** parameter must exist in the database before it is assigned to a GTT selector.

The set type of the **cggtasn** parameter or the **cgpcsn** parameter must match the set type of the corresponding entry in the GTT set table. For example, the **cggtasn** parameter should have a set type of **cggtas**, and the **cgpcsn** parameter should have a set type of **cgpc**.

The FLOBR feature must be turned on before the **lsn**, **eaglegen**, **cdgttsn**, or **cggttsn** parameter can be specified.

If the **eaglegen=yes** parameter is specified, then the **lsn**, **selid**, **gttsn**, **cgssn**, **cggtasn**, and **cgpcsn** parameters cannot be specified.



The OBSR feature must be enabled or the FLOBR feature must be turned on before the **selid** parameter can be specified.

The value specified for the **cdgtasn** or **gttsn** parameter must match the name of an existing GTT set.

The GTT set specified by the **cdgtasn** or **gttsn** parameter must have a set type of **cdgta** (see the **ent-gttset** command).

If the OBSR feature is enabled or the FLOBR feature is turned on, then the **gttsn** parameter cannot be specified.

The GTT set specified by the **cdgttsn**, **cdgtasn**, or **gttsn** parameter must have a set type of **cdgta** (see the **ent-gttset** command).

The linkset specified by the **lsn** parameter must already exist in the Linkset table.

The CdPA GTT Set specified by the **gttsn**, **cdgtasn**, or **cdgttsn** parameter must already exist in the GTT Set table.

A value of **dflt** must be specified for the **np** and **nai** parameters, or neither value can be **dflt**.

If a full GTT selector key is specified by the **gti(x)**, **tt**, **np/npv**, **nai/naiv**, **selid**, and **lsn** parameters, then the GTT set specified by the **gttsn**, **cdgtasn**, or **cdgttsn** parameters cannot be specified.

If the **lsn** parameter is specified, then the **cdgttsn** or **cggttsn** parameter must be specified.

The **cggtasn**, **cgpcsn**, and **cggttsn** parameters cannot be specified together in the command.

The **gttsn**, **cdgtasn**, and **cdgttsn** parameters cannot be specified together in the command.

If the **gttsn**, **cdgttsn**, or **cdgtasn** parameter is specified, then the **cgssn** parameter cannot be specified.

If the **gttsn** or **cdgtasn** parameter is specified, then the **selid** parameter cannot be specified.

If the **eaglegen=yes** parameter is specified, then the **lsn**, **selid**, **gttsn**, **cdgtasn**, **cgssn**, **cggttsn**, **cggtasn**, or **cgpcsn** parameters cannot be specified.

If the FLOBR feature is turned on, then the **cdgtasn**, **cggtasn**, and **cgpcsn** parameters cannot be specified.

If a value of **dflt** is specified for the **np** and **nai** parameters, then the **cggtasn**, **cgpcsn**, **cgssn**, **selid**, **lsn**, **cggttsn**, and **eaglegen** parameters cannot be specified.

A value of **none** cannot be specified for the **gttsn**, **cdgtasn**, **cdgttsn**, **cggttsn**, **cggtasn**, and **cgpcsn** parameters.

## Notes

When the EGTT feature is turned on, the GTT Selector (**ent/chg/dlt/rtrv-gttset**), GTT Set (**ent/dlt/rtrv-gttset**), and GTA (**ent/chg/dlt/rtrv-gta**) commands replace the Translation Type (**ent/dlt/rtrv-tt**) and Global Title Translation (**ent/chg/dlt/rtrv-gtt**) commands. All data previously provisioned with these commands is maintained.

**Output**

Retrieve all GTT selectors when EGTT is ON:

**rtrv-gttset**

sccprte 09-03-15 13:54:13 EST EAGLE 41.0.0

|      |     |    |     |           |
|------|-----|----|-----|-----------|
| GTIA | TT  | NP | NAI | GTTSN     |
| 2    | 101 | -- | --- | setans101 |
| 2    | 102 | -- | --- | a102      |
| 2    | 202 | -- | --- | a102      |

|      |     |      |      |           |
|------|-----|------|------|-----------|
| GTII | TT  | NP   | NAI  | GTTSN     |
| 2    | 101 | --   | ---  | setint101 |
| 2    | 102 | --   | ---  | int102    |
| 2    | 222 | --   | ---  | int102    |
| 4    | 101 | dflt | dflt | setint101 |
| 4    | 102 | dflt | dflt | int102    |
| 4    | 222 | dflt | dflt | int102    |

|      |     |      |      |           |
|------|-----|------|------|-----------|
| GTIN | TT  | NP   | NAI  | GTTSN     |
| 2    | 103 | --   | ---  | setnat103 |
| 2    | 104 | --   | ---  | n104      |
| 2    | 204 | --   | ---  | n104      |
| 4    | 103 | dflt | dflt | setnat103 |
| 4    | 104 | dflt | dflt | n104      |
| 4    | 204 | dflt | dflt | n104      |

|        |     |      |      |           |
|--------|-----|------|------|-----------|
| GTIN24 | TT  | NP   | NAI  | GTTSN     |
| 2      | 2   | --   | ---  | n24       |
| 2      | 124 | --   | ---  | n24       |
| 2      | 224 | --   | ---  | set24n224 |
| 4      | 2   | dflt | dflt | n24       |
| 4      | 124 | dflt | dflt | n24       |
| 4      | 224 | dflt | dflt | set24n224 |

;

Retrieve all GTT Selectors when the OBSR feature is enabled or the FLOBR feature is turned on:

**rtrv-gttset**

sccprte 09-03-15 14:31:52 EST EAGLE 41.0.0

|      |     |    |     |     |       |           |           |                         |
|------|-----|----|-----|-----|-------|-----------|-----------|-------------------------|
| GTI  |     |    |     | CG  |       | CDPA      |           | CGPA                    |
| ANSI | TT  | NP | NAI | SSN | SELID | LSN       | GTTSET    | GTTSET                  |
| 2    | 5   | -- | --- | any | none  | lsa03     | opc1      | (opc ) cgssn2 (cgssn)   |
| 2    | 5   | -- | --- | 202 | 1234  | any       | -----     | (--- ) cggtal (cggtal)  |
| 2    | 5   | -- | --- | any | none  | any       | cdgtal    | (cdgta) cggtal (cggtal) |
| 2    | 15  | -- | --- | --- | none  | Eagle-Gen | cdgta2    | (cdgta) ----- (--- )    |
| 2    | 15  | -- | --- | 202 | 1234  | lsa02     | -----     | (--- ) cgssn1 (cgssn)   |
| 2    | 101 | -- | --- | --- | none  | any       | setans101 | (cdgta) ----- (--- )    |
| 2    | 102 | -- | --- | --- | none  | any       | a102      | (cdgta) ----- (--- )    |
| 2    | 202 | -- | --- | --- | none  | any       | a102      | (cdgta) ----- (--- )    |

|     |  |  |  |    |  |      |  |      |
|-----|--|--|--|----|--|------|--|------|
| GTI |  |  |  | CG |  | CDPA |  | CGPA |
|-----|--|--|--|----|--|------|--|------|

Commands

rtrv-gttset

```

INTL TT NP      NAI  SSN SELID LSN      GTTSET          GTTSET
2    17  --      ---  --- none  Eagle-Gen  icdgta1  (cdgta)  -----  (--- )

2    101 --      ---  --- none  any       setint101(cdgta) -----  (--- )

2    102 --      ---  --- none  any       int102   (cdgta)  -----  (--- )

2    222 --      ---  --- none  any       int102   (cdgta)  -----  (--- )

4    101 dflt    dflt  --- none  any       setint101(cdgta) -----  (--- )

4    102 dflt    dflt  --- none  any       int102   (cdgta)  -----  (--- )

4    222 dflt    dflt  --- none  any       int102   (cdgta)  -----  (--- )

4    253 11      126  102 5678  any       -----  (--- ) icgpc2  (cgpc )

4    253 11      15   any 5678  lsint02   icgssn2  (cgssn)  iopc2   (opc )

```

```

GTI
NATL TT NP      NAI  SSN SELID LSN      CDPA          CGPA
GTTSET          GTTSET
2    103 --      ---  --- none  any       setnat103(cdgta) -----  (--- )

2    104 --      ---  --- none  any       n104     (cdgta)  -----  (--- )

2    204 --      ---  --- none  any       n104     (cdgta)  -----  (--- )

4    18  f69     5    --- none  Eagle-Gen  icdgta1  (cdgta)  -----  (--- )

4    103 dflt    dflt  --- none  any       setnat103(cdgta) -----  (--- )

4    104 dflt    dflt  --- none  any       n104     (cdgta)  -----  (--- )

4    204 dflt    dflt  --- none  any       n104     (cdgta)  -----  (--- )

```

```

GTI
N24  TT NP      NAI  SSN SELID LSN      CDPA          CGPA
GTTSET          GTTSET
2    2   --      ---  --- none  any       n24         (cdgta)  -----  (--- )

2    124 --      ---  --- none  any       n24         (cdgta)  -----  (--- )

2    224 --      ---  --- none  any       set24n224(cdgta) -----  (--- )

4    2   dflt    dflt  --- none  any       n24         (cdgta)  -----  (--- )

4    19  f69     5    --- none  Eagle-Gen  icdgta1  (cdgta)  -----  (--- )

4    124 dflt    dflt  --- none  any       n24         (cdgta)  -----  (--- )

4    224 dflt    dflt  --- none  any       set24n224(cdgta) -----  (--- )

```

;  
Retrieve all GTT Selectors that have specified GTII and TT values when the OBSR feature is enabled or the FLOBR feature is turned on:

**rtrv-gttset:gtii=4:tt=253**

sccprte 09-03-16 08:53:31 EST EAGLE 41.0.0

```

GTI              CG              CDPA              CGPA

```

```

INTL TT NP NAI SSN SELID LSN GTTSET GTTSET
4 253 11 126 102 5678 any ----- (--- ) icgpc2 (cgpc )

4 253 11 15 any 5678 lsint02 icgssn2 (cgssn) iopc2 (opc )
;

```

**Legend**

**GTI/GTIA/GTII/GTIN/GTIN24**—The global title indicator.

**TT**—The translation type.

**NP**—The number plan.

**NAI**—The nature of address indicator.

**GTTSN**—The GTT set name. A GTT set is an entity to which global title addresses and selectors are assigned.

**rtrv-gttset****Retrieve GTT Set**

Use this command to display a list of administered GTT sets. This list can be filtered by using the parameters shown.

**Keyword:** rtrv-gttset

**Related Commands:** chg-gttset, dlt-gttset, ent-gttset

**Command Class:** Database Administration

**Parameters**

**:gttsn=** (optional)

GTT set name. A GTT set is an entity to which global title addresses and selectors are assigned.

**Range:** ayyyyyyyy

1 leading alphabetic and up to 8 following alphanumeric characters.

**:netdom=** (optional)

Network domain. This command does not distinguish between ITU National or ITU International because the Enhanced Global Title Translation feature does not discriminate between the ITU-I and ITU-N translations.

**Range:** ansi, itu, cross

**Default:** Display all

**:setidx=** (optional)

GTT set index. This parameter allows GTT set information to be retrieved based on the GTT index number.

**Range:** 0-1999

**:settype=** (optional)

GTT set type.

This parameter is mandatory if the Origin-based SCCP Routing (OBSR) feature is enabled or the TCAP Opcode Based Routing (TOBR) feature is turned on.

**Range:** cdgta, cggta, cgpc, cgssn, opc, cdssn, opcode

**Default:** Display all

**Example**

```
rtrv-gttset
```

```
rtrv-gttset:netdom=ansi
```

```
rtrv-gttset:gttsn=t800
rtrv-gttset:netdom=ansi:settype=cdssn
rtrv-gttset:settype=opcode
rtrv-gttset:setidx=1
```

### Dependencies

The EGTT feature must be turned on before this command can be entered.

If the **gttsn** parameter is specified, it cannot have a value of **none**, and must match an existing **gttsn**.

If the **netdom** parameter is specified, at least one entry must exist that exactly matches the specified value. Otherwise, the following error message appears in the scroll area:

```
No GTT Sets matching the specified criteria were found.
```

The **netdom=cross** parameter is valid only if the **settype=cdgta** parameter is specified.

If the **gttsn** parameter is specified, the **settype** and **netdom** parameters cannot be specified.

The Origin-based SCCP Routing feature must be enabled if the value of the **settype** parameter is **cgta**, **cgssn**, **opc**, or **cgpc**.

The ANSI-ITU-China SCCP Conversion feature must be turned on before the **netdom=cross** parameter can be specified.

The TOBR feature must be turned before a value of **cdssn** or **opcode** can be specified for the **settype** parameter.

If the **setidx** parameter is specified, then no other parameter can be specified in the command.

### Notes

When the EGTT feature is turned on, the GTT Selector (**ent/chg/dlt/rtrv-gttset**), GTT Set (**ent/dlt/rtrv-gttset**), and GTA (**ent/chg/dlt/rtrv-gta**) commands replace the Translation Type (**ent/dlt/rtrv-tt**) and Global Title Translation (**ent/chg/dlt/rtrv-gtt**) commands. All data previously provisioned with these commands is maintained.

When the Origin-based SCCP Routing feature is turned on, the **settype** parameter is displayed regardless of feature key status. If the feature key is not enabled, the **settyp=cdgta** parameter (default value) is displayed.

**Output**

Retrieve all GTT sets:

**rtrv-gttset**

```
tekelecstp 09-08-14 12:57:51 EST EAGLE 41.1.0
GTTSN      NETDOM      NDGT
lidb       ansi          10
t800       ansi          6
s_i000     itu           15
imsi       itu           15
abcd1234   itu           12
```

GTT-SET table is (5 of 2000) 1% full.

;

Retrieve a specific GTT set:

**rtrv-gttset:gttsn=t800**

```
tekelecstp 09-08-14 13:46:14 EST EAGLE 41.1.0
GTTSN      NETDOM      NDGT
t800       ansi          6
```

GTT-SET table is (3 of 2000) 1% full.

;

Retrieve all GTT sets when the VGTT (Variable Length GTT) feature is turned on:

**rtrv-gttset**

```
tekelecstp 09-08-14 13:46:56 EST EAGLE 41.1.0
GTTSN      NETDOM      NDGT
lidb       ansi          3,7,10
t800       ansi          4,6
s_i000     itu           10,15
imsi       itu           10,15
abcd1234   itu           12
```

GTT-SET table is (5 of 2000) 1% full.

;

Retrieves GTT sets for a specified GTT set type when the Origin-based SCCP Routing feature is turned on.

**rtrv-gttset:settype=cgpc**

```
tekelecstp 09-08-14 12:59:19 EST EAGLE 41.1.0
GTTSN      NETDOM      SETTYPE  NDGT
pc00       ansi          CGPC      -
pc01       ansi          CGPC      -
pc02       itu           CGPC      -
pc03       ansi          CGPC      -
pc04       ansi          CGPC      -
pc05       ansi          CGPC      -
```

GTT-SET table is (8 of 2000) 1% full.

;

Retrieve all GTT sets when the Origin-based SCCP Routing feature is turned on.

**rtrv-gttset**

```
rlghncxa03w 09-08-14 08:10:20 EST EAGLE 41.1.0
GTTSN      NETDOM      SETTYPE  NDGT
Pc10       cross       CDGTA    6,8,10,17
Pc11       ansi        CGGTA    10
```

```
Pc12      itu      CGPC      -
Pc13      itu      CGSSN     -
Pc14      ansi     OPC        -
Pc15      ansi     CGPC        -
```

GTT-SET table is (6 of 2000) 1% full.

;

Retrieve all GTT sets when the ANSI-ITU-China SCCP Conversion feature is on and ANSI/ITU Translation is used for an entry with a network domain of **cross**:

**rtrv-gttset**

```
rlghncxa03w 09-08-13 08:29:15 EST  EAGLE 41.1.0
GTTSN      NETDOM  NDGT
lidb       ansi    10
t800       ansi    6
s_i000     itu     15
imsi       itu     15
abcd1234   cross   12
```

GTT-SET table is (5 of 2000) 1% full.

;

Retrieve all GTT sets when the Support for 16 GTT Lengths in VGTT feature is turned on.

**rtrv-gttset**

```
rlghncxa03w 09-08-13 08:16:15 EST  EAGLE 41.1.0
GTTSN      NETDOM  NDGT
lidb       ansi    1,3,5,6,7,8,9,10,11,12,13,14,18,21
t800       ansi    4,6
s_i000     itu     10,15
```

GTT-SET table is (3 of 2000) 1% full.

;

Retrieve all GTT sets when the TOBR feature is turned on.

**rtrv-gttset**

```
rlghncxa03w 09-08-14 08:10:20 EST  EAGLE 41.1.0
GTTSN      NETDOM  SETTYPE  NDGT
Pc10       cross   CDGTA    6,8,10,17
Pc11       ansi    CGGTA    10
Pc12       itu     CGPC      -
Pc13       itu     CGSSN     -
Pc14       ansi     OPC        -
Pc15       ansi     CGPC        -
Pc16       itu     CDSSN     -
Pc17       -       OPCODE    -
```

GTT-SET table is (8 of 2000) 1% full.

;

Retrieve the GTT set entry on the basis of set index.

**rtrv-gttset:setidx=1**

```
tekelecstp 09-08-13 10:57:14 EST  EAGLE 41.1.0
Command entered at terminal #4.
```

```
GTTSN      NETDOM  SETTYPE  NDGT
setcggta   ansi    CGGTA    0
```

GTT-SET table is (3 of 2000) 1% full.

;

**Legend**

**GTTSN**—The GTT set name. A GTT set is an entity to which global title addresses and selectors are assigned.

**NETDOM**—The network domain.

**SETTYPE**—The GTT set type.

**NDGT**—The number of digits required for GTAs associated with this set.

**rtrv-gtw-stp****Retrieve Gateway STP Parameters**

Use this command to display the level 3 ANSI transfer control status (TFCSTAT) parameter. This value is the level 3 control status used on a TFC message received from an ITU node destined for an ANSI node.

**Keyword:** rtrv-gtw-stp

**Related Commands:** chg-gtw-stp

**Command Class:** Database Administration

**Parameters**

This command has no parameters.

**Example**

```
rtrv-gtw-stp
```

**Dependencies**

None

**Notes**

None

**Output**

```
rtrv-gtw-stp
rlghncxa03w 03-03-11 11:34:04 EST EAGLE 31.3.0
TFCSTAT
1
;
```

**rtrv-gtwy-acthresh****Retrieve the Gateway Screening Activity Threshold**

Use this command to display the current values for the SS7 message rejection thresholds occurring because of the gateway screening process.

**Keyword:** rtrv-gtwy-acthresh

**Related Commands:** set-gtwy-acthresh

**Command Class:** Database Administration

**Parameters**

**:lsn=** (optional)

Linkset name.

**Range:** ayyyyyyyyy

1 alphabetic character followed by up to 9 alphanumeric characters

**Default:** Display all



**Example**

```
rtrv-gtwy-acthresh:lsn=wy644368
rtrv-gtwy-acthresh
```

**Dependencies**

The specified linkset must exist in the gateway linkset entity set of the requesting system.  
 The linkset specified must exist in the active database.  
 At least one optional parameter must be specified.

**Notes**

None

**Output**

The following example shows the display of the thresholds of all linksets:

```
rtrv-gtwy-acthresh
rlghncxa03w 04-02-18 08:50:12 EST EAGLE 31.3.0
LSN      REJ      RECV      INTRVL
WY644368 10       1000      10
WY234456 25       2000      20
LN123445 -        -         -
LN123556 25       2500      30
OP239900 -        5         5
;
```

The following example shows the display of the linkset **wy644368** rejection thresholds:

```
rtrv-gtwy-acthresh:lsn=wy644368
rlghncxa03w 04-02-18 08:50:12 EST EAGLE 31.3.0
LSN      REJ      RECV      INTRVL
wy644368 10       1000      10
:
```

**Legend**

**LSN**—Linkset name.  
**REJ**—Reject threshold.  
**RECV**—Received message threshold.  
**INTRVL**—Monitor interval.

**rtrv-gtwy-prmtrs****Retrieve Gateway Parameters**

Use this command to display the STP values that limit the display of certain notification messages that could become excessive. Only the values set by the **set-scrrej-prmtrs** command are displayed.

**Keyword:** **rtrv-gtwy-prmtrs**

**Related Commands:** **set-scrrej-prmtrs**

**Command Class:** Database Administration

**Parameters**

This command has no parameters.

**Example**

```
rtrv-gtwy-prmtrs
```

**Dependencies**

None

**Notes**

None

**Output****rtrv-gtwy-prmtrs**

```

rlghncxa03w 04-02-18 08:50:12 EST EAGLE 31.3.0
LIMIT INTRVL
1000 15
;

```

**Legend****LIMIT**—The threshold not to be exceeded.**INTRVL**—Monitor interval. The examination period, in minutes, during which the gateway screening activity thresholds are to be tested.**rtrv-gws-actset****Retrieve Gateway Screening Stop Action Sets**

Use this command to display the values defined for gateway screening stop actions.

**Keyword:** rtrv-gws-actset**Related Commands:** chg-gws-actset**Command Class:** Database Administration**Parameters****:actid=** (optional)

The identification number of the gateway screening stop action.

**Range:** 4-16**Default:** Display all**:actname=** (optional)

The name of the gateway screening stop action set.

**Range:** ayyyyy

One alphabetic character followed by up to five alphanumeric characters.

**Default:** Display all**Example**

```

rtrv-gws-actset
rtrv-gws-actset:actname=cr
rtrv-gws-actset:actid=6

```

**Dependencies**Either **actname** or **actid** can be specified, but not both.**Notes**

If neither **actname** nor **actid** are specified with the **rtrv-gws-actset** command, all gateway screening stop actions are displayed.

**Output**

```

rtrv-gws-actset:actname=cr
rlghncxa03w 03-03-07 00:57:31 EST EAGLE 31.3.0
ACT ACT ACT ACT ACT ACT ACT ACT ACT ACT ACT ACT
ID NAME 1 2 3 4 5 6 7 8 9 10
--
3 cr copy rdct

GWS action set table is (6 of 16) 38% full
;

rtrv-gws-actset
tekelecstp 09-06-11 16:02:09 EST EAGLE 41.1.0
ACT ACT ACT ACT ACT ACT ACT ACT ACT ACT ACT ACT
ID NAME 1 2 3 4 5 6 7 8 9 10
--
1 copy copy ----
2 rdct rdct ----
3 cr copy rdct ----
4 sccp sccp ----

GWS action set table is (4 of 16) 25% full
;

```

**rtrv-gws-redirect**

**Retrieve Gateway Screening Redirect**

Use this command to display the provisioning data for the redirect function. The parameters and values that are retrieved using this command are stored in the Redirect table, and they are used to set the variable fields of the MSUs being redirected.

**Keyword:** rtrv-gws-redirect

**Related Commands:** chg-gws-redirect, dlt-gws-redirect, ent-gws-redirect

**Command Class:** Database Administration

**Parameters**

This command has no parameters.

**Example**

```

rtrv-gws-redirect

```

**Dependencies**

None

**Notes**

None

**Output**

The second column in the output displays the type of point code used:

- ANSI—DPCA
- International—DPCI
- ITU National—DPCN
- ITU National 24—DPCN24

**rtrv-gws-redirect**

```
rlghncxa03w 09-04-10 11:43:04 EST EAGLE 41.0.0
ENABLED      DPCA          RI   SSN  TT   GTA
off          003-033-003    GT   0   0   1
;
```

In the following example, the gateway screening redirect function is not enabled.

**rtrv-gws-redirect**

```
rlghncxa03w 09-04-10 11:43:04 EST EAGLE 41.0.0
ENABLED      DPCA          RI   SSN  TT   GTA
Redirect function data is not provisioned.
;
```

**Legend**

**ENABLED**—Indicates whether the gateway screening redirect function is on or off

**DPCA/DPCI/DPCN/DPCN24**—The destination point code that the message is being redirected to.

**RI**—The routing indicator for the redirected message

**SSN**—The subsystem to which the redirected message is bound for.

**TT**—The translation type of the global title translation

**GTA**—The global title translation address

**rtrv-home-smsc****Retrieve HOME SMSC Address**

Use this command to retrieve HOME SMSC specific addresses currently used to identify Short Message Service Centers in the database. This command reads the HOME SMSCADDR table.

**Keyword:** rtrv-home-smsc

**Related Commands:** dlt-home-smsc, ent-home-smsc

**Command Class:** Database Administration

**Parameters**

**:force=** (optional)

Display more than 50 entries.

**Range:** yes, no

**Default:** no

**:num=** (optional)

Number of entries to display. The **force** parameter must also be specified to display more than 50 entries.

**Range:** 0-500

**Default:** 50

**:smc=** (optional)  
 Short Message Service Center address.  
**Range:** 1-21 digits  
 1-21 hexadecimal digits

### Example

```
rtrv-home-smc
rtrv-home-smc:smc=552611646
rtrv-home-smc:num=100:force=yes
```

### Dependencies

One of the following features must be enabled (see the **enable-ctrl-feat** command) before this command can be entered.

- MO SMS IS41-to-GSM Migration
- MO-based GSM SMS NP
- MO-based IS41 SMS NP
- MT-Based GSM SMS NP
- MT-Based IS41 SMS NP
- Portability Check for Mobile Originated SMS

When the specified **num** parameter value is greater than 50, the **force=yes** parameter must also be specified.

### Notes

None

### Output

```
rtrv-home-smc

rlghncxa03w 03-03-28 08:50:12 EST EAGLE 31.3.0
SMC ADDRESS

13214564894498
55231465465434
5465455655656456

HOME SMC ADDRESS TABLE IS 1 % FULL (3 of 500)

;
```

## rtrv-homern

### Retrieve Home Routing Number Prefix List

Use this command to retrieve a list of routing number prefixes that belong to the operating network.

**Keyword:** rtrv-homern

**Related Commands:** dlt-homern, ent-homern

**Command Class:** Database Administration

**Parameters**

This command has no parameters.

**Example**

```
rtrv-homern
```

**Dependencies**

None.

**Notes**

None

**Output**

```
rtrv-homern
rlghncxa03w 03-03-28 08:50:12 EST EAGLE 31.3.0
RN
-----
216780909087654
76345098
abc
abc1234
c10234567
cabade

HOMERN table is (6 of 100) 6% full
;
```

**Legend**

**RN**—Routing Number

**rtrv-inpopts****Retrieve INP Options**

Use this command to retrieve INP-specific options.

**Keyword:** rtrv-inpopts

**Related Commands:** chg-inpopts

**Command Class:** Database Administration

**Parameters**

This command has no parameters.

**Example**

```
rtrv-inpopts
```

**Dependencies****Notes**

If no DRANAI value or DRANAIV value has been provisioned, the command output displays the DRANAIV default value of 126.

If either the DRANAI value or DRANAIV value has been provisioned, the DRANAI mnemonic string for the provisioned value is displayed.

If no DRANP value or DRANPV value has been provisioned, the command output displays the DRANP default mnemonic value of E164.

If either the DRANP value or DRANPV value has been provisioned, the DRANP mnemonic string for the provisioned value is displayed.

The command output displays each CDPNPFX value with its associated DLTPFX setting.

The command output displays each CDPNNAI value with its associated SNAI value.

If no NEC value has been provisioned, a value of **none** is displayed.

If a RELCAUSE value was not provisioned, then the default value of **31** is displayed.

**Output**

The following example shows output with default INP options.

**rtrv-inpopts**

```
rlghncxa03w 09-06-17 15:35:05 EST EAGLE 41.1.0
INP OPTIONS
```

```
-----
NEC          = NONE
DRANAIV     = 126
DRANP      = E164
DRA         = RNDN
SPRESTYPE  = CONTINUE
RELCAUSE   = 31
SPORTTYPE  = NONE
DEFNRN     = NONE
```

```
CDPNPFX          DLTPFX
-----          ---
```

```
CDPNNAI          SNAI
---             ----
```

;

The following example shows output with some INP options provisioned.

**rtrv-inpopts**

```
rlghncxa03w 09-06-17 15:35:05 EST EAGLE 41.1.0
INP OPTIONS
```

```
-----
NEC          = abc1d
DRANAIV     = 126
DRANP      = E164
DRA         = CCRNDN
SPRESTYPE  = CONTINUE
RELCAUSE   = 30
SPORTTYPE  = ALL
DEFNRN     = 99887
```

```
CDPNPFX          DLTPFX
-----          ---
```

```
CDPNNAI          SNAI
---             ----
127              unknown
```

;

**Legend**

- **ASD**—Additional Subscriber Data
- **CDPNNAI**—Called Party Number Nature of Address Indicator
- **CDPNPFX**—Called Party Number Prefix
- **DLTPFX**—Delete Prefix
- **DRA**—Destination Routing Address.
- **DRANAI**—Nature of Address Indicator for the Destination Routing Address
- **DRANPV**—Numbering Plan Value for the Destination Routing Address
- **GRN**—Generic Routing Number.
- **NEC**—National Escape Code



- **SNAI**—Service Nature of Address Indicator
- **SPRESTYPE**—INP option to send a "Connect" message or a "Continue" message when IDP messages are received for INP services, the DN digits match, and the HLR ID is present
- **SPORTTYPE**—Service Portability Type
- **DEFNRN**—Default Routing Number
- **RELCAUSE**—INP CRP option, specifying the reason for releasing the call when an INP Circular Route is detected

## rtrv-ip-card

## Retrieve Internet Protocol Card

Use this command to retrieve IP networking parameters for a given card.

**Keyword:** rtrv-ip-card

**Related Commands:** chg-ip-card

**Command Class:** Database Administration

### Parameters

**:loc=** (optional)

Card location. The unique identifier of a specific application subsystem located in the system.

**Range:** 1101-1108, 1111-1112, 1201-1208, 1211-1218, 1301-1308, 1311-1318, 2101-2108, 2111-2118, 2201-2208, 2211-2218, 2301-2308, 2311-2318, 3101-3108, 3111-3118, 3201-3208, 3211-3218, 3301-3308, 3311-3318, 4101-4108, 4111-4118, 4201-4208, 4211-4218, 4301-4308, 4311-4318, 5101-5108, 5111-5118, 5201-5208, 5211-5218, 5301-5308, 5311-5318, 6101-6108, 6111-6118

### Example

```
rtrv-ip-card:loc=1211
```

```
rtrv-ip-card
```

### Dependencies

The **loc** parameter value must correspond to a DCM card in the card table.

### Notes

None

## Output

```

rtrv-ip-card:loc=1211
  rlghncxa03w 08-02-22 15:35:05 EST  EAGLE 38.0.0
  LOC 1211
    SRCHORDR  LOCAL
    DNSA      150.123.123.123
    DNSB      -----
    DEFROUTER -----
    DOMAIN    NC.TEKELEC.COM
    SCTPCSUM  adler32
;

```

```

rtrv-ip-card
  rlghncxa03w 08-02-22 15:35:05 EST  EAGLE 38.0.0
  LOC 1211
    SRCHORDR  LOCAL
    DNSA      150.1.1.1
    DNSB      -----
    DEFROUTER -----
    DOMAIN    NC.TEKELEC.COM
    SCTPCSUM  adler32

  LOC 1213
    SRCHORDR  LOCAL
    DNSA      150.1.1.1
    DNSB      -----
    DEFROUTER 150.1.1.25
    DOMAIN    NC.TEKELEC.COM
    SCTPCSUM  adler32

  LOC 1301
    SRCHORDR  SRVONLY
    DNSA      150.1.1.10
    DNSB      150.1.1.28
    DEFROUTER -----
    DOMAIN    NC.TEKELEC.COM
    SCTPCSUM  adler32
;

```

The following example displays the output that occurs when an E5-SM4G card is used.

```

rtrv-ip-card
  rlghncxa03w 08-05-04 22:12:42 EST  EAGLE5 39.0.0
  LOC 1105
    SRCHORDR  LOCAL
    DNSA      -----
    DNSB      -----
    DEFROUTER -----
    DOMAIN    -----
    SCTPCSUM  crc32c
    BPIPADDR  192.168.124.2
    BPSUBMASK 255.255.255.0
  LOC 1107
    SRCHORDR  LOCAL
    DNSA      -----
    DNSB      -----
    DEFROUTER -----
    DOMAIN    -----
    SCTPCSUM  crc32c
    BPIPADDR  192.168.124.4
    BPSUBMASK 255.255.255.0
  LOC 1111
    SRCHORDR  LOCAL
    DNSA      -----
    DNSB      -----

```

```

DEFROUTER -----
DOMAIN -----
SCTPCSUM   crc32c
BPADDR    192.168.124.3
BPSUBMASK 255.255.255.0
    
```

i

**Legend**

**LOC**—The card location.

**SRCHORDR**—The Host table search order. LOCAL indicates that the Local Host table is searched first. SRVR indicates that the Domain server is searched first. SRVROONLY indicates that only the Domain server is searched.

**DNSA**—The IP address of Domain Server A.

**DNSB**—The IP address of Domain Server B.

**DEFROUTER**—The IP address for the default router.

**DOMAIN**—The Domain name of the Domain server.

**SCTPCSUM**—The SCTP checksum algorithm type.

**BPADDR**—The bonded port IP address.

**BPSUBMASK**—The bonded port IP submask.

**rtrv-ip-host**

**Retrieve Internet Protocol Hostname**

Use this command to retrieve the IP Host table. The IP Host table defines local host names for IP addresses.

**Keyword:** rtrv-ip-host

**Related Commands:** dlt-ip-host, ent-ip-host

**Command Class:** Database Administration

**Parameters**

**:display=** (optional)

This parameter is specified to display all the provisioned local or remote IP Host entries.

**Range:** all

**:host=** (optional)

Host name. The logical name of the device associated with the indicated IP address.

**Range:** ~~~~~

Any string of characters beginning with a letter and comprising up to 60 characters in length. Valid characters are a–z, A–Z, 0–9, - (dash), . (period)

**:ipaddr=** (optional)

The IP address associated with the hostname. This is a TCP/IP address expressed in standard dot notation. IP addresses consist of the system’s network number and the machine’s unique host number. An example IP address is **192.126.100.5**, where **192.126.100** is the network number and **5** is the machine’s host number.

**Range:** 4 numbers separated by dots, with each number in the range of **0-255**.

**:num=** (optional)

This parameter specifies the number of IP Host entries that are displayed in the command output.

**Range:** **1-2048**

**System****Default:** 50**:type=** (optional)

This parameter specifies whether to retrieve entries for local or remote IPs.

**Range:** **local**, **remote****local**— The host name and address of the IP card for the local EAGLE 5 ISS**remote**— The host name and address of the IP card for a remote EAGLE 5 ISS**Example**

```
rtrv-ip-host:host=gw100-nc.tekelec.com:ipaddr=150.1.1.1
```

```
rtrv-ip-host:host=gw100.nc.tekelec.com
```

```
rtrv-ip-host:ipaddr=150.1.1.1
```

```
rtrv-ip-host
```

```
rtrv-ip-host:display=all
```

```
rtrv-ip-host:num=10
```

```
rtrv-ip-host:type=local:num=3
```

**Dependencies**

The value specified for the **host** parameter must begin with an alphabetic character and can contain **a..z**, **A..Z**, **0..9**, - (hyphen), or . (period). If the host name contains a hyphen, then the host name must be enclosed within quotation marks.

**Notes**

If optional parameters are specified, only the entries that match the entered parameters are retrieved.

**Output**

If the **rtrv-ip-host** command is entered without any parameter, then the command displays up to a maximum of 50 entries. The **display=all** parameter must be specified to display all entries in the IP Host table.

This example displays the output when no other parameter is specified.

**rtrv-ip-host**

```
tekelecstp 09-08-12 10:22:08 EST EAGLE 41.1.0
LOCAL IPADDR      LOCAL HOST
192.168.63.51     tekelecdmz11.com
192.168.63.115    tekelecdmz5.com
192.168.73.116    tekelecdmz7.com
192.168.63.52     tekelecdmz13.com
192.168.63.54     tekelecdmz14.com
192.168.63.55     hss4

REMOTE IPADDR     REMOTE HOST
192.168.63.235    tekelecdmz21.com
127.1.1.1         tekelec0.com
192.168.63.245    client
192.168.63.57     tekelec1.com
192.168.63.58     tekelec2.com
192.168.63.59     tekelec3.com
192.168.63.60     tekelec4.com
192.168.63.61     tekelec5.com
192.168.63.62     tekelec6.com
192.168.63.63     tekelec7.com
192.168.63.64     tekelec8.com
192.168.63.65     tekelec9.com
192.168.63.66     tekelec10.com
192.168.63.67     tekelec11.com
192.168.63.68     tekelec12.com
192.168.63.69     tekelec13.com
192.168.63.70     tekelec14.com
192.168.63.71     tekelec15.com
192.168.63.72     tekelec16.com
192.168.63.73     tekelec17.com
192.168.63.74     tekelec18.com
192.168.63.75     tekelec19.com
192.168.63.76     tekelec20.com
192.168.63.77     tekelec21.com
192.168.63.78     tekelec22.com
192.168.63.79     tekelec23.com
192.168.63.80     tekelec24.com
192.168.63.81     tekelec25.com
192.168.63.82     tekelec26.com
192.168.63.83     tekelec27.com
192.168.63.84     tekelec28.com
192.168.63.85     tekelec29.com
192.168.63.86     tekelec30.com
192.168.63.87     tekelec31.com
192.168.63.88     tekelec32.com
192.168.63.89     tekelec33.com
192.168.63.90     tekelec34.com
192.168.63.91     tekelec35.com
192.168.63.92     tekelec36.com
192.168.63.93     tekelec37.com
192.168.63.94     tekelec38.com
192.168.63.95     tekelec39.com
192.168.63.96     tekelec40.com
192.168.63.97     tekelec41.com
```

IP-HOST table is (68 of 2048) 3% full.

;

This example displays the output when the output is filtered.

**rtrv-ip-host:type=local:num=3**

```
tekelecstp 09-08-12 10:22:09 EST EAGLE 41.1.0
LOCAL IPADDR      LOCAL HOST
192.168.63.51     tekelecdmz11.com
192.168.63.115    tekelecdmz5.com
192.168.73.116    tekelecdmz7.com

IP-HOST table is (68 of 2048) 3% full.
```

;

This example displays the output when all entries are requested.

**rtrv-ip-host:display=all**

```
tekelecstp 09-08-12 10:22:09 EST EAGLE 41.1.0
LOCAL IPADDR      LOCAL HOST
192.168.63.51     tekelecdmz11.com
192.168.63.115    tekelecdmz5.com
192.168.73.116    tekelecdmz7.com
192.168.63.52     tekelecdmz13.com
192.168.63.54     tekelecdmz14.com
192.168.63.55     hss4

REMOTE IPADDR     REMOTE HOST
192.168.63.235    tekelecdmz21.com
127.1.1.1         tekelec0.com
192.168.63.245    client
192.168.63.57     tekelec1.com
192.168.63.58     tekelec2.com
192.168.63.59     tekelec3.com
192.168.63.60     tekelec4.com
192.168.63.61     tekelec5.com
192.168.63.62     tekelec6.com
192.168.63.63     tekelec7.com
192.168.63.64     tekelec8.com
192.168.63.65     tekelec9.com
192.168.63.66     tekelec10.com
192.168.63.67     tekelec11.com
192.168.63.68     tekelec12.com
192.168.63.69     tekelec13.com
192.168.63.70     tekelec14.com
192.168.63.71     tekelec15.com
192.168.63.72     tekelec16.com
192.168.63.73     tekelec17.com
192.168.63.74     tekelec18.com
192.168.63.75     tekelec19.com
192.168.63.76     tekelec20.com
192.168.63.77     tekelec21.com
192.168.63.78     tekelec22.com
192.168.63.79     tekelec23.com
192.168.63.80     tekelec24.com
192.168.63.81     tekelec25.com
192.168.63.82     tekelec26.com
192.168.63.83     tekelec27.com
192.168.63.84     tekelec28.com
192.168.63.85     tekelec29.com
192.168.63.86     tekelec30.com
192.168.63.87     tekelec31.com
192.168.63.88     tekelec32.com
192.168.63.89     tekelec33.com
192.168.63.90     tekelec34.com
192.168.63.91     tekelec35.com
192.168.63.92     tekelec36.com
```

```

192.168.63.93 tekelec37.com
192.168.63.94 tekelec38.com
192.168.63.95 tekelec39.com
192.168.63.96 tekelec40.com
192.168.63.97 tekelec41.com
192.168.63.98 tekelec42.com
192.168.63.99 tekelec43.com
192.168.63.20 tekelec44.com
192.168.63.21 tekelec45.com
192.168.63.22 tekelec46.com
192.168.63.23 tekelec47.com
192.168.63.24 tekelec48.com
192.168.63.25 tekelec49.com
192.168.63.26 tekelec50.com
192.168.63.27 tekelec51.com
192.168.63.28 tekelec52.com
192.168.63.29 tekelec53.com
192.168.63.30 tekelec54.com
192.168.63.31 tekelec55.com
192.168.63.32 tekelec56.com
192.168.63.33 tekelec57.com
192.168.63.34 tekelec58.com
192.168.63.35 tekelec59.com

```

IP-HOST table is (68 of 2048) 3% full.

;

## rtrv-ip-lnk

## Retrieve Internet Protocol Link

Use this command to retrieve the IP link table.

**Keyword:** rtrv-ip-lnk

**Related Commands:** chg-ip-lnk

**Command Class:** Database Administration

### Parameters

**:loc=** (optional)

Card location. The unique identifier of a specific application subsystem located in the system.

**Range:** 1101-1108, 1111-1112, 1201-1208, 1211-1218, 1301-1308, 1311-1318, 2101-2108, 2111-2118, 2201-2208, 2211-2218, 2301-2308, 2311-2318, 3101-3108, 3111-3118, 3201-3208, 3211-3218, 3301-3308, 3311-3318, 4101-4108, 4111-4118, 4201-4208, 4211-4218, 4301-4308, 4311-4318, 5101-5108, 5111-5118, 5201-5208, 5211-5218, 5301-5308, 5311-5318, 6101-6108, 6111-6118

**Default:** All card location link data are displayed.

**:port=** (optional)

Ethernet interface port ID.

**Range:** a, b

**Default:** All IP link port data associated with all ports on the card are displayed.

### Example

```
rtrv-ip-lnk:loc=1211:port=a
```

```
rtrv-ip-lnk:loc=1211
```

```
rtrv-ip-lnk
```

### Dependencies

The **loc** parameter value must correspond to a DCM card in the card table.

**Notes**

None

**Output****rtrv-ip-lnk**

```

rlghncxa03w 04-02-17 15:35:05 EST EAGLE 31.3.0
LOC  PORT  IPADDR          SUBMASK          DUPLEX  SPEED  MACTYPE  AUTO  MCAST
1211  A     150.123.123.123  255.255.255.0   HALF    10     DIX      NO   YES
1211  B     150.123.123.124  255.255.255.0   HALF    10     DIX      NO   NO
1213  A     150.123.123.125  255.255.255.0   ----    ---    DIX      YES  NO
1213  B     150.123.123.126  255.255.255.0   ----    ---    DIX      YES  NO
1215  A     150.123.123.127  255.255.255.0   FULL    100    DIX      NO   YES
1215  B     150.123.123.128  255.255.255.0   FULL    100    DIX      NO   NO

```

IP-Link table is (6 of 512) 1% full

;

**rtrv-ip-lnk:loc=1211**

```

rlghncxa03w 04-02-17 15:35:05 EST EAGLE 31.3.0
LOC  PORT  IPADDR          SUBMASK          DUPLEX  SPEED  MACTYPE  AUTO  MCAST
1211  A     150.123.123.123  255.255.255.0   HALF    10     DIX      NO   NO
1211  B     150.123.123.124  255.255.255.0   HALF    10     DIX      NO   NO

```

;

**rtrv-ip-lnk:loc=1211:port=a**

```

rlghncxa03w 04-02-17 15:35:05 EST EAGLE 31.3.0
LOC  PORT  IPADDR          SUBMASK          DUPLEX  SPEED  MACTYPE  AUTO  MCAST
1211  A     150.123.123.123  255.255.255.0   HALF    10     DIX      NO   NO

```

;

**Legend**

**LOC**—The card location.

**PORT**—The Ethernet interface port ID, **A** or **B**.

**IPADDR**—The IP address for the specified port.

**SUBMASK**—The subnet mask of the IP interface.

**DUPLEX**—The mode of operation of the interface, **HALF** or **FULL**.

**SPEED**—The bandwidth for the interface in megabits per second, **10** or **100**.

**MACTYPE**—The Media Access Control Type of the interface, **802.3** or **DIX**. **802.3** indicates the IEEE standard number 802.3 for Ethernet 1, and **DIX** indicates the Digital/Inter/Xerox *de facto* standard for Ethernet 2.

**AUTO**—Whether or not to automatically determine duplex and speed. If **YES**, duplex and speed are automatically determined. If **NO**, duplex and speed are not automatically determined.

**MCAST**—Multicast Control. Enables or disables multicast support for the interface. This parameter is necessary for INP, G-Port, and G-Flex to establish the connection from the Service Module card to the MPS system.

**rtrv-ip-node****Retrieve IP Node**

Use this command to display one or more nodes that are directly connected to a TCP/IP data link. A particular connection can be displayed, a particular application on a node can be displayed, or an entire node can be displayed. If an entire node is displayed, no parameters are required to perform



this action. A particular application can be specified by giving either the application's name or its IP port on the node.

**Keyword:** rtrv-ip-node

**Related Commands:** dlt-ip-node, ent-ip-node

**Command Class:** Database Administration

## Parameters

**:ipaddr=** (optional)

The remote host's IP address. This is a TCP/IP address expressed in standard dot notation. IP addresses consist of the system's network number and the machine's unique host number. An example IP address is **192.126.100.5**, where **192.126.100** is the network number and **5** is the machine's host number.

**Range:** 1-223, 0-255

4 numbers separated by dots

**1-223**—first number

**0-255**—the other three numbers

**Default:** Display all

**:ipappl=** (optional)

The IP application supported by the node.

**Range:** stplan

**:ipport=** (optional)

The logical IP port that addresses the application on the node.

**Range:** 1024-5000

**Default:** Display all

**:iprte=** (optional)

The default router's IP address. This is a TCP/IP address expressed in standard dot notation. IP addresses consist of the system's network number and the machine's unique host number. An example IP address is **192.126.100.5**, where **192.126.100** is the network number and **5** is the machine's host number.

**Range:** 1-223, 0-255

4 numbers separated by dots

**1-223**—first number

**0-255**—the other three numbers

**Default:** Display all

**:loc=** (optional)

The card location as stenciled on the shelf of the system that contains the TCP/IP link that will be directly connected to the node.

**Range:** 1101-1108, 1111-1112, 1201-1208, 1211-1218, 1301-1308, 1311-1318, 2101-2108, 2111-2118, 2201-2208, 2211-2218, 2301-2308, 2311-2318, 3101-3108, 3111-3118, 3201-3208, 3211-3218, 3301-3308, 3311-3318, 4101-4108, 4111-4118, 4201-4208, 4211-4218, 4301-4308, 4311-4318, 5101-5108, 5111-5118, 5201-5208, 5211-5218, 5301-5308, 5311-5318, 6101-6108, 6111-6118

**Default:** Display all

## Example

```
rtrv-ip-node
rtrv-ip-node:ipappl=stplan
rtrv-ip-node:ipaddr=193.4.201.50
```

```
rtrv-ip-node:ipaddr=193.4.201.50:ipport=1024  
rtrv-ip-node:loc=1201
```

### Dependencies

If the **ipappl**, **ipport**, or **loc** parameter is specified, the others cannot be specified.

The **ipport** parameter can be specified only if the **ipaddr** parameter is specified.

The ACM is the only valid card type for this command.

The shelf and card must be equipped.

If the **loc** parameter is specified, the card location must be equipped with a TCP/IP data link.

If the **ipaddr** parameter is specified, that IP address must be in the TCP/IP data link table.

If the **ipappl** parameter is specified, that IP application must be in the TCP/IP data link table.

If the **iprte** parameter is not specified, then all TCP/IP nodes meeting the display criteria are displayed. If the TCP/IP node has no TCP/IP router assigned to it, dashes are displayed in the IPRTE field.

### Notes

None

## Output

**rtrv-ip-node**

```

rlghncxa03w 04-02-04 21:16:43 EST EAGLE 31.3.0
IPADDR      IPPORT  IPAPPL  LOC   CAP  IPRTE
193.4.201.50 1024   stplan 1201  10%  --
193.4.201.50 1024   stplan 1202  10%  --
193.4.201.50 1024   stplan 1203  20%  --
193.4.202.30 2000   stplan 1204  40%  193.4.201.1
194.5.198.74 3000   stplan 1205  40%  193.4.201.1
197.4.217.39 4000   stplan 1206  40%  197.4.216.1

```

;

**rtrv-ip-node:ipappl=stplan**

```

rlghncxa03w 04-02-04 21:16:43 EST EAGLE 31.3.0
IPADDR      IPPORT  IPAPPL  LOC   CAP  IPRTE
193.4.201.50 1024   stplan 1201  10%  --
193.4.201.50 1024   stplan 1202  10%  --
193.4.201.50 1024   stplan 1203  20%  --
193.4.202.30 2000   stplan 1204  40%  193.4.201.1
194.5.198.74 3000   stplan 1205  40%  193.4.201.1
197.4.217.39 4000   stplan 1206  40%  197.4.216.1

```

;

**rtrv-ip-node:ipaddr=193.4.201.50**

```

rlghncxa03w 04-02-04 21:16:43 EST EAGLE 31.3.0
IPADDR      IPPORT  IPAPPL  LOC   CAP  IPRTE
193.4.201.50 1024   stplan 1201  10%  --
193.4.201.50 1024   stplan 1202  10%  --
193.4.201.50 1024   stplan 1203  20%  --

```

;

**rtrv-ip-node:ipaddr=193.4.201.50:ippport=1024**

```

rlghncxa03w 04-02-04 21:16:43 EST EAGLE 31.3.0
IPADDR      IPPORT  IPAPPL  LOC   CAP  IPRTE
193.4.201.50 1024   stplan 1201  10%  --
193.4.201.50 1024   stplan 1202  10%  --
193.4.201.50 1024   stplan 1203  20%  --

```

;

**rtrv-ip-node:loc=1201**

```

rlghncxa03w 04-02-04 21:16:43 EST EAGLE 31.3.0
IPADDR      IPPORT  IPAPPL  LOC   CAP  IPRTE
193.4.201.50 1024   stplan 1201  10%  --

```

;

**rtrv-ip-node:ipaddr=193.4.201.50:ippport=1022**

```

rlghncxa03w 04-02-04 21:16:43 EST EAGLE 31.3.0
IPADDR      IPPORT  IPAPPL  LOC   CAP  IPRTE
IPPORT on Node not connected to any TCP/IP link.

```

;

**rtrv-ip-node:ipaddr=193.4.111.55**

```

rlghncxa03w 04-02-04 21:16:43 EST EAGLE 31.3.0
IPADDR      IPPORT  IPAPPL  LOC   CAP  IPRTE
IPADDR not connected to any TCP/IP Link.

```

;

**Legend**

**IPADDR**—The remote host's IP address.

**IPPORT**—The logical IP port to address the application on the node.

**IPAPPL**—The IP application supported by the node.

**LOC**—The card location as stenciled on the shelf of the system that contains the TCP/IP link that will be directly connected to the node.

**CAP**—The maximum percentage of ethernet capacity for this node connection.

**IPRTE**—The default router's IP address.

## rtrv-ip-rte

### Retrieve IP Route

Use this command to display all static IP route entries in the Static IP Route table, or the entries for a specific card (destination IP addresses, subnet masks, and gateway IP addresses), or the entries for a specific destination IP address, or the entries for a specific gateway IP address.

**Keyword:** rtrv-ip-rte

**Related Commands:** , ent-ip-rte

**Command Class:** Database Administration

### Parameters

**:dest=** (optional)

Destination IP Address. The IP Address of a remote destination host or network.

**Range:** 4 numbers separated by dots, with each number in the range of **0–255**.  
The IP address **0.0.0.0** is not valid.

**:gtwy=** (optional)

Gateway IP Address. The IP address assigned to the gateway router that will properly forward IP datagrams with the destination IP address (dest) to the next-hop gateway router or final destination host.

**Range:** 4 numbers separated by dots, with each number in the range of **0–255**.  
The IP address **0.0.0.0** is not valid.

**:loc=** (optional)

Card location. The unique identifier of a specific IP card in the system.

**Range:** 1101-1108, 1111-1112, 1201-1208, 1211-1218, 1301-1308, 1311-1318, 2101-2108, 2111-2118, 2201-2208, 2211-2218, 2301-2308, 2311-2318, 3101-3108, 3111-3118, 3201-3208, 3211-3218, 3301-3308, 3311-3318, 4101-4108, 4111-4118, 4201-4208, 4211-4218, 4301-4308, 4311-4318, 5101-5108, 5111-5118, 5201-5208, 5211-5218, 5301-5308, 5311-5318, 6101-6108, 6111-6118

### Example

```
rtrv-ip-rte
rtrv-ip-rte:loc=1301
rtrv-ip-rte:dest=128.252.10.5
rtrv-ip-rte:gtwy=140.190.15.3
```

### Dependencies

Only one optional parameter can be specified in a single command.

The **loc** parameter value must correspond to a SSEDCCM card in the card table that is running the **ss7ipgw**, **ipgwi**, **iplim**, or **iplimi** application. The B network is used only on SSEDCCM cards.

The specified destination IP address (**dest** parameter):

- Must not be the default route (**0.0.0.0**)
- Must not correspond to any loopback address (i.e. 127.X.X.X)

The specified gateway IP address (**gtwy** parameter):

- Must not be the default route (**0.0.0.0**)
- Must not correspond to any loopback address (i.e. 127.X.X.X)

**Notes**

None

**Output**

```

rtrv-ip-rte
rlghncxa03w 04-01-07 09:50:17 EST EAGLE 34.0.0
LOC  DEST          SUBMASK          GTWY
1301 128.252.10.5   255.255.255.255 140.188.13.33
1301 128.252.0.0     255.255.0.0     140.188.13.34
1301 150.10.1.1      255.255.255.255 140.190.15.3
1303 192.168.10.1   255.255.255.255 150.190.15.23
1303 192.168.0.0     255.255.0.0     150.190.15.24

IP Route table is (5 of 1024) 1% full

;

rtrv-ip-rte:loc=1301
rlghncxa03w 04-01-07 09:50:17 EST EAGLE 34.0.0
LOC  DEST          SUBMASK          GTWY
1301 128.252.10.5   255.255.255.255 140.188.13.33
1301 128.252.0.0     255.255.0.0     140.188.13.34
1301 150.10.1.1      255.255.255.255 140.190.15.3

IP Route table is (5 of 1024) 1% full

;

rtrv-ip-rte:dest=128.252.10.5
rlghncxa03w 04-01-07 09:50:17 EST EAGLE 24.0.0
LOC  DEST          SUBMASK          GTWY
1301 128.252.10.5   255.255.255.255 140.188.13.33

IP Route table is (5 of 1024) 1% full

;

rtrv-ip-rte:gtwy=140.190.15.3
rlghncxa03w 04-01-07 09:50:17 EST EAGLE 34.0.0
LOC  DEST          SUBMASK          GTWY
1301 150.10.1.1      255.255.255.255 140.190.15.3

IP Route table is (5 of 1024) 1% full

;

```

**rtrv-is41-msg**

**Retrieve Configured IS41 Message**

Use this command to display the configured IS41 test message parameter values.

**Keyword:** rtrv-is41-msg

**Related Commands:** chg-is41-msg, tst-msg

**Command Class:** Database Administration

**Parameters**

**:msgn=** (mandatory)

Message number. This parameter specifies the test message number that is retrieved.

**Range:** 1-10

### Example

```
rtrv-is41-msg:msgn=5
```

### Dependencies

### Output

```
rtrv-is41-msg:msgn=1
tekelecstp 08-12-02 10:47:51 EST EAGLE 40.1.0
MSG = 1                ACTIVE = YES

CGPA_GT = 2
CGPA_GT_NAI = 4      CGPA = 919818000001

CDPA_GT = 2
CDPA_GT_NAI = 4      CDPA = 919818000002

CGPN_NAI = 1         CGPN_NP = 2
CGPN_ES = 1          CGPN = 919818000007

CDPN_NAI = 1         CDPN_NP = 2
CDPN_ES = 1          CDPN = 919818000008
```

## rtrv-is41opts

## Retrieve IS41 Options

Use this command to retrieve the IS41 option indicators maintained in the IS41OPTS table.

**Keyword:** rtrv-is41opts

**Related Commands:** chg-is41opts, chg-is41smsopts, rtrv-is41smsopts

**Command Class:** Database Administration

### Parameters

This command has no parameters.

### Example

```
rtrv-is41opts
```

### Dependencies

The APORT or IGM feature must be enabled before this command can be entered.

**Output**

The following example shows the output when APORT and/or IGM Feature is Enabled:

**rtrv-is41opts**

```
tekelecstp 08-04-15 12:49:20 EST EAGLE 39.0.0
```

```
IS41 OPTIONS
-----
SMSREQBYPASS      = NO
LOCREQDN          = SCCP
IEC               = NONE
NEC              = NONE
RSPCGPARI        = FRMSG
RSPCGPAPCP      = FRMSG
RSPCDPARI       = FRMSG
RSPCDPAPCP      = OFF
RSPCGPANAI      = NONE
RSPCGPANP       = NONE
RSPCGPATT       = NONE
MTPLOCREQNAI    = FRMSG
RSPPARM         = TLIST
RSPDIG          = RNDN
RSPNON          = NONE
RSPNP           = 2
RSPMIN          = HOMERN
MSCMKTID        = 0
MSCSWITCH       = 0
ESNMFG         = 0
ESNSN          = 0
RSPDIGTYPE     = 6
LOCREQRMHRN    = NO
TCAPSNAI       = FRMSG
MTPLOCREQLEN   = 15
```

```
;
```

**rtrv-is41smsopts****Retrieve IS41 SMS System Options**

Use this command to display all IS41 SMS options from the database.

**Keyword:** rtrv-is41smsopts

**Related Commands:** chg-is41opts, chg-is41smsopts, rtrv-is41opts

**Command Class:** Database Administration

**Parameters**

This command has no parameters.

**Example**

```
rtrv-is41smsopts
```

**Dependencies**

None.

**Notes**

None

**Output****rtrv-is41smsopts**

```
tekelecstp 09-06-20 11:49:00 EST EAGLE 41.1.0
IS41 SMS OPTIONS
```

```
-----
BPARTYGTTSN      = NONE           MODAPARAM        = DA
MOIGMPFX         = IS412GSM      MOSMSACLEN       = 0
MOSMSDIGMAT      = EXACT         MOSMSNAI         = NAT
MOSMSGTTDIG      = SCCPCDPA     MOSMSTYPE        = ALL
SPORTYPE         = GSM           SPFILL           = ON
DEFRN            = abcdef123456789

MTSMSACKN        = ACK           MTSMSCHKSRC     = NO
MTSMSDNFMT       = RN           MTMSDLTR        = NO
MTMSDLTRV        = NONE         MTMSDIGTYPE     = 6
MTSMSNAKERR      = 5           MTSMSPARM       = DIGIT
MTSMSESN         = NO           MTSMSSSN        = 6
MTSMSTYPE        = RN
```

```
;
```

**rtrv-isup-msg****Retrieve ISUP Message**

Use this command to display one ISUP test message or all ISUP test messages from the TESTMSG table. The TIF Test Tool processes ISUP test messages to verify the TIF and NPP provisioned configuration in the system.

**Keyword:** rtrv-isup-msg

**Related Commands:** chg-isup-msg, tst-msg

**Command Class:** Database Administration

**Parameters**

**:msgn=** (optional)

ISUP Test Message number. This parameter specifies the ISUP test message number for which parameter values are displayed.

**Range:** 1-10

**Dependencies**

None.



## Output

## rtrv-isup-msg

```

tekelecstp 08-10-30 14:55:45 EST EAGLE 40.0.0
MSG = 1          ACTIVE = NO
    CGPN_NAI = 4      CGPN = 01234567890abcdef
    CDPN_NAI = 4      CDPN = 01234567890abcdef

    CGPN_CAT = 0

    NMBITS = 0
MSG = 2          ACTIVE = YES
    CGPN_NAI = 4      CGPN = 01234567890abcdef
    CDPN_NAI = 4      CDPN = 01234567890abcdef

    CGPN_CAT = 0

    NMBITS = 0
MSG = 3          ACTIVE = NO
    CGPN_NAI = 4      CGPN = 01234567890abcdef
    CDPN_NAI = 4      CDPN = 01234567890abcdef

    CGPN_CAT = 0

    NMBITS = 0
MSG = 4          ACTIVE = NO
    CGPN_NAI = 4      CGPN = 01234567890abcdef
    CDPN_NAI = 4      CDPN = 01234567890abcdef

    CGPN_CAT = 0

    NMBITS = 0
MSG = 5          ACTIVE = NO
    CGPN_NAI = 4      CGPN = 01234567890abcdef
    CDPN_NAI = 4      CDPN = 01234567890abcdef

    CGPN_CAT = 0

    NMBITS = 0
MSG = 6          ACTIVE = NO
    CGPN_NAI = 4      CGPN = 01234567890abcdef
    CDPN_NAI = 4      CDPN = 01234567890abcdef

    CGPN_CAT = 0

    NMBITS = 0
MSG = 7          ACTIVE = NO
    CGPN_NAI = 4      CGPN = 01234567890abcdef
    CDPN_NAI = 4      CDPN = 01234567890abcdef

    CGPN_CAT = 0

    NMBITS = 0
MSG = 8          ACTIVE = NO
    CGPN_NAI = 4      CGPN = 01234567890abcdef
    CDPN_NAI = 4      CDPN = 01234567890abcdef

    CGPN_CAT = 0

    NMBITS = 0
MSG = 9          ACTIVE = NO
    CGPN_NAI = 4      CGPN = 01234567890abcdef
    CDPN_NAI = 4      CDPN = 01234567890abcdef

    CGPN_CAT = 0

```

```

        NMBITS = 0
MSG = 10          ACTIVE = NO
        CGPN_NAI = 4          CGPN = 01234567890abcdef
        CDPN_NAI = 4          CDPN = 01234567890abcdef

        CGPN_CAT = 0

        NMBITS = 0
;

rtrv-isup-msg:msgn=10
tekelecstp 08-10-30 14:57:07 EST EAGLE 40.0.0
MSG = 10          ACTIVE = NO
        CGPN_NAI = 4          CGPN = 01234567890abcdef
        CDPN_NAI = 4          CDPN = 01234567890abcdef

        CGPN_CAT = 0

        NMBITS = 0
;

```

**Legend****MSG**—ISUP Test Message number**ACTIVE**—Indicates whether the ISUP test message will be sent to the network card in the test (0=NO, 1=YES)**CGPN\_NAI**—Calling Party Number Nature of Address Indicator**CGPN\_CAT**—CgPN Category**CGPN**—Calling Party Number Digits**CDPN\_NAI**—Called Party Number Nature of Address Indicator**CDPN**—Called Party Number Digits**NMBITS**—Nm Bits that indicate whether a number portability lookup has already been performed in the network**rtrv-l2t****Retrieve Level 2 Timers**

Use this command to display the values of the SS7 MTP Level 2 timers.

**NOTE: The timers are organized in 35 timer sets of 9 timer values each. The timer sets are grouped and system default values are initialized by specification (ANSI, ITU, High Speed for China, High Speed for Q.703 Annex A, and High Speed for Unchannelized T1).**

**NOTE: Each timer set is administered individually by the chg-l2t command. The ent-slk command is used to assign an SS7 signaling link to any of the timer sets. Each assigned link is associated with a timer set.**

**Keyword:** rtrv-l2t**Related Commands:** chg-l2t, ent-slk, rtrv-slk**Command Class:** Database Administration**Parameters****:l2tset=** (optional)

Level 2 timer set identifier, or timer set number. Up to 35 different SS7 MTP Level 2 timer sets can be defined.

**Range:** 1-35  
**Default:** Displays all timer sets

**Example**

```
rtrv-l2t
```

```
rtrv-l2t:l2tset=3
```

**Dependencies**

None.

**Notes**

The timer values are shown in the output for this command in seconds, even though they were specified in milliseconds in the **chg-l2t** command.

**Output**

The timer values are shown in the output for the **rtrv-l2t** command in seconds.

**rtrv-l2t**

```
tekelecstp 09-04-03 10:56:27 EST EAGLE 41.0.0
LEVEL 2 TIMERS (IN SECONDS)
L2TSET    T1      T2      T3      T4NPP    T4EPP    T5      T6      T7      NODATA
  1      13.0    11.5    11.5    2.3      0.60     0.10    4.0    1.5    0.10
  2      13.0    11.5    11.5    2.3      0.60     0.10    4.0    1.5    0.10
  3      13.0    11.5    11.5    2.3      0.60     0.10    4.0    1.5    0.10
  4      13.0    11.5    11.5    2.3      0.60     0.10    4.0    1.5    0.10
  5      13.0    11.5    11.5    2.3      0.60     0.10    4.0    1.5    0.10
  6      13.0    11.5    11.5    2.3      0.60     0.10    4.0    1.5    0.10
  7      13.0    11.5    11.5    2.3      0.60     0.10    4.0    1.5    0.10
  8      13.0    11.5    11.5    2.3      0.60     0.10    4.0    1.5    0.10
  9      13.0    11.5    11.5    2.3      0.60     0.10    4.0    1.5    0.10
 10      13.0    11.5    11.5    2.3      0.60     0.10    4.0    1.5    0.10
 11      40.0    30.0     2.0    8.2      0.50     0.10    4.0    1.5    0.10
 12      40.0    30.0     2.0    8.2      0.50     0.10    4.0    1.5    0.10
 13      40.0    30.0     2.0    8.2      0.50     0.10    4.0    1.5    0.10
 14      40.0    30.0     2.0    8.2      0.50     0.10    4.0    1.5    0.10
 15      40.0    30.0     2.0    8.2      0.50     0.10    4.0    1.5    0.10
 16      40.0    30.0     2.0    8.2      0.50     0.10    4.0    1.5    0.10
 17      40.0    30.0     2.0    8.2      0.50     0.10    4.0    1.5    0.10
 18      40.0    30.0     2.0    8.2      0.50     0.10    4.0    1.5    0.10
 19      40.0    30.0     2.0    8.2      0.50     0.10    4.0    1.5    0.10
 20      40.0    30.0     2.0    8.2      0.50     0.10    4.0    1.5    0.10
 21      150.0   130.0     1.0   30.0     0.50     0.10    5.0    0.8    0.10
 22      150.0   130.0     1.0   30.0     0.50     0.10    5.0    0.8    0.10
 23      150.0   130.0     1.0   30.0     0.50     0.10    5.0    0.8    0.10
 24      150.0   130.0     1.0   30.0     0.50     0.10    5.0    0.8    0.10
 25      150.0   130.0     1.0   30.0     0.50     0.10    5.0    0.8    0.10
 26      300.0   130.0     1.0   30.0     0.50     0.10    5.0    0.8    0.10
 27      300.0   130.0     1.0   30.0     0.50     0.10    5.0    0.8    0.10
 28      300.0   130.0     1.0   30.0     0.50     0.10    5.0    0.8    0.10
 29      300.0   130.0     1.0   30.0     0.50     0.10    5.0    0.8    0.10
 30      300.0   130.0     1.0   30.0     0.50     0.10    5.0    0.8    0.10
 31      151.0    14.0    14.0   30.0     3.00     0.08    3.0    0.5    0.10
 32      151.0    14.0    14.0   30.0     3.00     0.08    3.0    0.5    0.10
 33      151.0    14.0    14.0   30.0     3.00     0.08    3.0    0.5    0.10
 34      151.0    14.0    14.0   30.0     3.00     0.08    3.0    0.5    0.10
 35      151.0    14.0    14.0   30.0     3.00     0.08    3.0    0.5    0.10
;
```

If the **l2tset** parameter is specified, then the timer values for the specified timer set are shown.

**rtrv-l2t:l2tset=1**

```
tekelecstp 08-05-03 10:56:27 EST EAGLE 39.0.0
LEVEL 2 TIMERS (IN SECONDS)
L2TSET    T1      T2      T3      T4NPP    T4EPP    T5      T6      T7      NODATA
  1      13.0    11.5    11.5    2.3      0.60     0.10    4.0    1.5    0.10
;
```

**Legend**

**L2TSET**—The SS7 MTP Level 2 timer set identifier or number

**T1**—Aligned ready

**T2**—Not aligned

**T3**—Aligned

**T4NPP**—Proving period normal

**T4EPP**—Proving period Emergency

**T5**—Sending SIB  
**T6**—Remote congestion  
**T7**—Excessive delay of acknowledgment  
**NODATA**—Amount of time with no data

## rtrv-l3t

## Retrieve Level 3 Timers

Use this command to show values of the SS7 level 3 timers. The timers are grouped into sets that are assigned to linksets.

**Keyword:** rtrv-l3t

**Related Commands:** chg-l2t, chg-l3t, ent-ls, rtrv-l2t, rtrv-ls

**Command Class:** Database Administration

### Parameters

**:l3tset=** (optional)

Level 3 timer set table. Only one level 3 timer set table can be defined. The timer set can then be assigned to a linkset using the **ent-ls** or **chg-l3t** command.

**Range:** 1

**Default:** Display table

### Example

```
rtrv-l3t:l3tset=1
```

### Dependencies

Only one timer set is supported in this release.

### Notes

The timer output for this command is in seconds, even though it could have been entered in milliseconds on the **chg-l3t** command.

## Output

```

rtrv-l3t:l3tset=1
rlghncxa03w 04-02-17 16:03:12 EST EAGLE 31.3.0
LEVEL 3 TIMERS (IN SECONDS)
  L3TSET   T1     T2     T3     T4     T5     T6     T7
           1     0.8   1.4   0.8   0.8   0.8   0.8   1.0
           T8     T9     T10    T11    T12    T13    T14
           0.8   --    30.0  30.0  0.8   0.8   2.0
           T15    T16    T17    T18    IT18   T19    IT19
           3.0   1.4   0.8   10.0  19.0  480.0  67.0
           T20/IT22 IT20   T21/IT23 IT21   T22   T23   T24
           90.0  59.0  90.0  63.0  10.0  10.0  10.0
           T25    T26    T27    T28    T29    T30    T31
           30.0  12.0  --    3.0   60.0  30.0  60.0
           T32
           60.0
;

```

**Legend**

**L3TSET**—The level 3 timer set table.

**T1**—The delay, in seconds, to avoid message missequencing on changeover. Also used as the ITU MTP restart isolation timer.

**T2**—The amount of time, in seconds, to wait for changeover acknowledgment.

**T3**—Time controlled diversion – the delay, in seconds, to avoid missequencing on changeback.

**T4**—The amount of time, in seconds, to wait for changeback acknowledgment, first attempt.

**T5**—The amount of time, in seconds, to wait for changeback acknowledgment, second attempt.

**T6**—The delay, in seconds, to avoid message missequencing on controlled rerouting.

**T7**—The amount of time, in seconds, to wait for signaling data link connection acknowledgment.

**T8**—The transfer-prohibited inhibited timer (transient solution).

**T10**—The amount of time, in seconds, to wait before repeating the signaling-route-set-test message.

**T11**—The transfer-restricted timer.

**T12**—The amount of time, in seconds, to wait for uninhibit acknowledgment.

**T13**—The amount of time, in seconds, to wait for force uninhibit.

**T14**—The amount of time, in seconds, to wait for inhibition acknowledgment.

**T15**—The amount of time, in seconds, to wait before repeating the signaling-route-set-congestion test.

**T16**—The amount of time, in seconds, to wait for route-set-congestion status update.

**T17**—The delay, in seconds, to avoid oscillation of initial alignment failure and link restart.

**T18**—The repeat TFR once by response method timers.

**IT18**—The timer within an STP whose MTP restarts to supervise the receipt of routing information and the activation of the link and link set. The amount of time, in seconds, to wait for links to align and to receive TRAs from all adjacent nodes.

**T19**—The failed link craft referral timer.

**IT19**—The amount of time, in seconds, for the supervision timer to wait during MTP restart to avoid ping-pong of TFP, TFR1, and TRA messages.

**T20/IT22**—The amount of time, in seconds, to wait before repeating the local inhibit test.

**IT20**—The amount of time, in seconds, to wait overall for the MTP restart at the signaling point whose MTP restarts.

**T21/IT23**—The amount of time, in seconds, to wait before repeating the remote inhibit test.

**IT21**—The overall MTP restart timer at a signaling point adjacent to one whose MTP restarts.

**T22**—The timer at the restarting STP. The amount of time, in seconds, to wait for signaling links to become available.

**T23**—The timer at the restarting STP. Starting after T22, the amount of time, in seconds, to wait to receive all TRA messages.

**T24**—The timer at the restarting STP with transfer function. Starting after T23, the amount of time, in seconds, to wait to broadcast all TRA messages.

**T25**—The timer at the adjacent and restarting STPs. The amount of time, in seconds, to wait for a TRA message (may be started at level 2).

**T26**—The timer at the restarting STP. The amount of time, in seconds, to wait to repeat a TRW message.

**T28**—The timer at the STP adjacent to the restarting STP. The amount of time, in seconds, to wait for a TRW message.

**T29**—The timer started when a TRA message is sent in response to an unexpected TRA or TRW. Also, the timer started when traffic is resumed without receipt of a TRA message.

**T30**—The timer used to limit the sending of TFPs/TFRs in response to an unexpected TRA or TRW message.

**T31**—The false link congestion detection timer.

**T32**—The link oscillation timer—Procedure A.

## rtrv-lbp

### Retrieve Loopback Point Attributes

Use this command to retrieve the current value of a far-end loopback point maintained in the link fault sectionalization table.

**Keyword:** rtrv-lbp

**Related Commands:** act-lbp, chg-lbp, dact-lbp, dlt-lbp, ent-lbp

**Command Class:** Database Administration

### Parameters

**:lbp=** (optional)

Loopback point ID. This parameter identifies a far-end loopback point that lies along an SS7 signaling link path between the STP and the target device (up to and including the target device).

**Range:** 1-32

**Default:** Display all

**:link=** (optional)

SS7 signaling link. The SS7 signaling link that is to be tested.

**Synonym:** port

**Range:** a, b, a1-a31, b1-b31

Not all card types support all **link** parameter values.

See Table A-1 for valid **link** parameter range values for each type of card that can have assigned signaling links.

**Default:** Display all

**:loc=** (optional)

Card location. The unique identifier of a specific application subsystem located in the STP.

**Range:** 1101-1108, 1111-1112, 1201-1208, 1211-1218, 1301-1308, 1311-1318, 2101-2108, 2111-2118, 2201-2208, 2211-2218, 2301-2308, 2311-2318, 3101-3108, 3111-3118, 3201-3208, 3211-3218, 3301-3308, 3311-3318, 4101-4108, 4111-4118, 4201-4208, 4211-4218, 4301-4308, 4311-4318, 5101-5108, 5111-5118, 5201-5208, 5211-5218, 5301-5308, 5311-5318, 6101-6108, 6111-6118

**Default:** All card locations.

### Example

```
rtrv-lbp
rtrv-lbp:loc=1202
rtrv-lbp:loc=1202:link=a
rtrv-lbp:loc=1202:link=a:lbp=3
```

### Dependencies

The Link Fault Sectionalization (LFS) feature must be on before this command can be entered.

The card location specified in the **loc** parameter cannot be reserved by the system.

If the **link** parameter is specified, the **loc** parameter must be specified. If the **lbp** parameter is specified, both the **loc** parameter and the **link** parameter must be specified.

The card location (**loc** parameter) must identify a provisioned **limds0**, **limt1**, or **limch** (associated to a **limt1**) card configured with either an **ss7ansi** or **ccs7itu** application.

The card location specified in the **loc** parameter must be equipped.

### Notes

This command can be canceled using the **F9** function key or the **canc-cmd** command. See **canc-cmd** for more information.



**Output**

The following example displays the attributes for all the loopback points for SS7 links assigned to the STP:

```

rtrv-lbp
rlghncxa03w 04-02-17 16:02:05 EST EAGLE 31.3.0
LOC  PORTLINK  LBP  RLE  REP  CLLI  LFST
1101  A      1   DS0  0  -----  LLT
      7   OCU  0  -----  NLT
      9   NEI  0  -----  LLT

1102  A      2   DS0  0  -----  LLT
      3   DS0  4  -----  LLT
      4   NEI  0  -----  LLT

1102  B      1   DS0  0  -----  LLT
      6   NEI  0  -----  LLT

1215  A      1   DS0  0  -----  LLT
      3   DS0  4  -----  LLT
      5   DS0  5  -----  LLT
      7   DS0  8  -----  LLT
      9   NEI  0  -----  LLT
;
    
```

The following example displays the attributes for all the loopback points for the SS7 links A and B of the LIM card residing in the first frame, first shelf, and second slot of the STP:

```

rtrv-lbp:loc=1202
rlghncxa03w 04-02-17 16:02:05 EST EAGLE 31.3.0
LOC  LINK  LBP  RLE  REP  CLLI  LFST
1102  A      2   DS0  0  -----  LLT
      3   DS0  4  -----  LLT
      4   NEI  0  -----  LLT

1102  B      1   DS0  0  -----  LLT
      6   NEI  0  -----  LLT
;
    
```

The following example displays the attributes for all the loopback points for the SS7 link A of the LIM card residing in the first frame, first shelf, and second slot of the STP:

```

rtrv-lbp:loc=1202:link=a
rlghncxa03w 04-02-17 16:02:05 EST EAGLE 31.3.0
LOC  LINK  LBP  RLE  REP  CLLI  LFST
1102  A      2   DS0  0  -----  LLT
      3   DS0  4  -----  LLT
      4   NEI  0  -----  LLT
;
    
```

The following example displays the attributes for loopback point 3 for the SS7 link A of the LIM card residing in the first frame, first shelf, and second slot of the STP:

```

rtrv-lbp:loc=1202:link=a:lbp=3
rlghncxa03w 04-02-17 16:02:05 EST EAGLE 31.3.0
LOC  LINK  LBP  RLE  REP  CLLI  LFST
1102  A      3   DS0  4  -----  LLT
;
    
```

The following example displays the attributes for all the loopback points for the SS7 link A of the LIM card residing in the first frame, first shelf, and second slot of the STP. However, no loopback points have been provisioned.

```
rtrv-lbp:loc=1202:link=a
rlghncxa03w 04-02-17 16:02:05 EST EAGLE 31.3.0
LOC LINK LBP RLE REP CLLI LFST

No loopback points meeting the requested criteria were found
;
```

## rtrv-lnp-serv

### Retrieve LNP Service

Use this command to retrieve all LNP services. This command displays the assigned translation type, translation type name, service type, LNP digit validity indication, and TT aliases.

**Keyword:** rtrv-lnp-serv

**Related Commands:** chg-lnp-serv, dlt-lnp-serv, ent-lnp-serv

**Command Class:** Database Administration

### Parameters

This command has no parameters.

### Example

```
rtrv-lnp-serv
```

### Dependencies

The LNP feature must be turned on (see the **enable-ctrl-feat** command) before this command can be entered.

### Notes

None

Output

```

rtrv-lnp-serv
rlghncxa03w 02-11-28 14:42:38 EST EAGLE 30.0.0
SERV TT TTN DV ALIAS
AIN 15 AINGTE TCAP 235
                236
LIDB 20 LIDB SCCP ---
WNP 22 WNP TCAP ---
LNPQS 11 LNPQS TCAP ---
PCS 12 PCS TCAP ---
CLASS 25 CLASSGTE SCCP ---
UDF1 201 UDF1 SCCP ---

LNP-SERV TABLE IS 2% FULL (7 of 256)
;

```

If the LNP SMS feature is turned on and provisioned, the WSMSC entry is included:

```

rtrv-lnp-serv
rlghncxa03w 02-11-28 14:42:38 EST EAGLE 30.0.0
SERV TT TTN DV ALIAS
AIN 15 AINGTE TCAP 235
                236
LIDB 20 LIDB SCCP ---
WNP 22 WNP TCAP ---
LNPQS 11 LNPQS TCAP ---
PCS 12 PCS TCAP ---
CLASS 25 CLASSGTE SCCP ---
WSMSC 55 WSMSC SCCP ---
UDF1 201 UDF1 SCCP ---

LNP-SERV TABLE IS 2% FULL (8 of 256)
;

```

If the LNP SMS feature is not turned on but is provisioned, the output includes the WSMSC entry with an asterisk:

```

rtrv-lnp-serv
rlghncxa03w 02-11-28 14:42:38 EST EAGLE 30.0.0
SERV TT TTN DV ALIAS
AIN 15 AINGTE TCAP 235
                236
LIDB 20 LIDB SCCP ---
WNP 22 WNP TCAP ---
LNPQS 11 LNPQS TCAP ---
PCS 12 PCS TCAP ---
CLASS 25 CLASSGTE SCCP ---
WSMSC* 55 WSMSC SCCP ---
UDF1 201 UDF1 SCCP ---

LNP-SERV TABLE IS 2% FULL (8 of 256)
;

```

The following example displays the output when an entry is provisioned for the LRNQT feature.

```

rtrv-lnp-serv
rlghncxa03w 08-10-01 14:42:38 EST EAGLE 40.0.0
SERV TT TTN DV ALIAS
LNPQS 11 LNPQS TCAP ---
PCS 12 PCS TCAP ---
AIN 15 AINGTE TCAP 235
                236
LIDB 20 LIDB SCCP ---
WNP 22 WNP TCAP ---

```

```

CLASS 25 CLASSGTE SCCP ---
UDF1 201 UDF1 SCCP ---
LRNQT 239 LRNQT TCAP ---

LNP-SERV TABLE IS 3% FULL (8 of 256)
;

```

**Legend****SERV**—Reserved service type name.**TT**—Translation type**TTN**—Translation type name**DV**—Digits valid**ALIAS**—Alias translation type**rtrv-lnpopts****Retrieve LNP System Options**

Use this command to display all the LNP-specific system options from the database.

**Keyword:** rtrv-lnpopts**Related Commands:** chg-lnpopts**Command Class:** Database Administration**Parameters**

This command has no parameters.

**Example**

```
rtrv-lnpopts
```

**Dependencies**

The LNP feature must be turned on (see the **enable-ctrl-feat** command) before this command can be entered.

**Notes**

None

**Output**

The JIPPROV and JIPDIGITS fields appear in the output only when the Triggerless LNP feature is turned on.

```
rtrv-lnpopts
  AMASLPID   = 123456789
  INCSLP     = yes
  AMATYPE    = 003
  AMAFEATID  = 010
  CIC        = 1369
  AUD        = on
  SP         = a123
  FRCSMPLX   = no
  ADMHIPRI   = yes
  GTWYSTP    = yes
  JIPPROV    = yes
  JIPDIGITS  = 919460
  CCP        = no
  SERVPOR    = no
  WQREDRCT   = off
  WSMS10DIG  = yes
```

;

**Legend**

**AMASLPID**—AMA slip ID

**INCSLP**—Whether the AMA slip ID included in the response

**AMATYPE**—AMA call type

**AMAFEATID**—AMA feature ID

**CIC**—Carrier identification code

**AUD**—Audit indicator

**SP**—Service provider ID

**FRCSMPLX**—Allow simplex database updates indicator

**ADMHIPRI**—Indicator that LNP database administration has the highest priority of all administration

**GTWYSTP**—Indicator that LNP system is also configured as a Gateway STP

**JIPPROV**—Indicator of whether a Jurisdictional Information Parameter (JIP) value is to be added to the IAM

**JIPDIGITS**—The Jurisdictional Information Parameter value

**CCP**—Copy Charge Parameters

**SERVPOR**—Service Portability

**WQREDRCT**—Wireless queries directed to default GTT

**WSMS10DIG**—SCCP GTA length indicator for 10 or 11 digits

**rtrv-log****Display Records from the Log**

Use this command to retrieve records from the active or standby Alarm and UIM logs generated by the Maintenance system. This command selects these records based on a span of time or a specific log file index.

**Keyword:** rtrv-log  
**Related Commands:**  
**Command Class:** System Maintenance

### Parameters

**:dir=** (optional)

Direction in which to obtain entries from within the log (forward or backward) for displaying. See the Dependencies and Notes sections for usage information.

**Range:** fwd, bkwd

**fwd**—Display entries from nearer the beginning of the log toward entries at the end of the log

**bkwd**—Display entries from nearer the end of the log toward entries at the beginning of the log

**Default:** fwd

**:edate=** (optional)

End date. Report only log entries that were created on or *before* the specified date (when **dir=fwd**), or only log entries that were created on or *after* the specified date (when **dir=bkwd**). See the Notes section for usage information.

**Range:** 000101-991231

(in the form *yymmdd*, where *yy* is year, *mm* is month, and *dd* is day)

**Default:** Report log entries regardless of their creation date

**:enum=** (optional)

Ending Message Reference Number (MRN) for which to display entries. The ending Alarm or UIM number if specifying a range.

**Range:** 1-1499

**1-999**—Alarms (UAMs)

**1000-1499**—UIMs

**Default:** If **enum** is not specified and:

If **snum** is specified, the default **enum** value is the same as the specified **snum** value.

If **snum** is not specified and **type** is **alarm** or not specified, **enum= 999**.

If **snum** is not specified and **type** is **all** or **uim**, **enum= 1499**.

**:etime=** (optional)

End time. Report only log entries that were created on or *before* the specified time (when **dir=fwd**), or only log entries that were created on or *after* the specified time (when **dir=bkwd**). See the Notes section for usage information.

**Range:** 000000-235959

(in the form *yymmdd*, where *yy* is year, *mm* is month, and *dd* is day)

**Default:** Report log entries regardless of their creation time

**:mode=** (optional)

Log display mode; display all information or just summary information from each log entry.

**NOTE: If the entry is only one line, the same information (one line) is displayed in brief and full mode for that entry.**

**Range:** brief, full

**brief**—Display only the first “Summary” line of the log entry

**full**—Display all information available in the log entry

**Default:** full

**:next=** (optional)

Number of additional records to display using the same direction (**dir**) and filtering criteria of **outgrp**, **type**, **slog**, and **mode** that were used for the previous successful **rtrv-log** command at the same terminal. This parameter cannot be specified with any other parameters in the command. See the Dependencies and Notes sections for usage information.

**Range:** 1-65500

**:num=** (optional)

Number of records that can be displayed before the report is stopped.

**Range:** 1-65500

**Default:** 15

**:outgrp=** (optional)

Output Group to sort or filter the Alarms (UAMs) and/or UIMs on. This parameter cannot be specified when the **snum** parameter is specified.

**Range:** **all, appserv, appss, card, clk, db, dbg, gtt, gws, link, meas, mon, mps, pu, sa, seas, slan, sys, traf**

**all**— Retrieve information for all Output Groups

**appserv**— Application Server

**appss**— Application Subsystem

**card**— Card

**clk**— Clock

**db**— Database

**dbg**— Debug

**gtt**— GTT Maintenance

**gws**— GWS Maintenance

**link**— Link Maintenance

**meas**— Measurements Maintenance

**mon**— Monitoring (Sentinel or IMF) Maintenance

**mps**— MPS Maintenance

**pu**— Program Update

**sa**— System Administration

**seas**— SEAS (Sentinel or IMF)

**slan**— SLAN Maintenance

**sys**— System Maintenance

**traf**— Traffic

**Default:** If the **next** parameter is not specified, the default is **all**.

If the **next** parameter is specified, the output is the same as the immediately previous successful **rtrv-log** command that was entered at the same terminal (and no **rtrv-log** command was entered at another terminal).

**:sdate=** (optional)

Start date. Report only log entries that were created on or *after* the specified date (when **dir=fwd**), or only log entries that were created on or *before* the specified date (when **dir=bkwd**). See the Notes section for usage information.

**Range:** 000101-991231

(in the form *yymmdd*, where *yy* is year, *mm* is month, and *dd* is day)

**Default:** Report log entries regardless of their creation date

**:slog=** (optional)

Source of log. Which OAM's Maintenance log to access: active or standby.

**Range:** **act, stb**

**act**—Active OAM

**stb**—Standby OAM

**Default:** act

**:snum=** (optional)

A single Alarm or UIM Message Reference Number (MRN), or the starting Alarm or UIM MRN if specifying a range. This parameter cannot be specified when the **outgrp** parameter is specified.

**Range:** 1-1499  
 1-999—Alarms (UAMs)  
 1000-1499—UIMs

**Default:** All entries for the specified **type** are displayed.  
 If **type** is **all**, **alarm**, or not specified, **snum=1**.  
 If **type** is **uim**, **snum=1000**.

**:stime=** (optional)

Start time. Report only log entries that were created on or *after* the specified time (when **dir=fwd**), or only log entries that were created on or *before* the specified time (when **dir=bkwd**). See the Notes section for usage information.

**Range:** 000000-235959  
*hhmmss*—*hh*=hours (00-23), *mm*=minutes (00-59), *ss*=seconds (00-59)

**Default:** Report log entries regardless of their creation time

**:type=** (optional)

Type of Maintenance log to access for the report: alarms (UAMs), UIMs, or both logs (**all**).

**Range:** all, alarm, uim  
**Default:** alarm

### Example

```
rtrv-log:sdate=960715:stime=220000:num=50
rtrv-log:sdate=960715:stime=220000:num=50:snum=106
rtrv-log:sdate=960715:stime=220000:num=50:snum=106:enum=350
rtrv-log:sdate=960715:stime=220000:num=50:outgrp=slan:type=all
rtrv-log:next=100
```

### Dependencies

No other **rtrv-log** command can already be in progress on the same OAM.

The initialization of the ELOG and UIM logs must be complete in the system before the **rtrv-log** command can be entered.

If both the **sdate** and **edate** parameters are specified,

- In the forward direction, the **sdate** value must be less than or equal to the **edate** value.
- In the backward direction, the **sdate** value must be greater than or equal to the **edate** value.

The month component of the **sdate** and **edate** parameters must be in the range 1–12.

The day component of the **sdate** and **edate** parameters must be in the range 1–31 and must accurately reflect the number of days in the month and year indicated (see Notes section).

The seconds component of the **stime** and **etime** parameters must be in the range 00–59.

The minutes component of the **stime** and **etime** parameters must be in the range 00–59.

If the **sdate** parameter value is equal to the **edate** parameter value,

- In the forward direction, the **stime** value must be less than or equal to the **etime** value.
- In the backward direction, the **stime** value must be greater than or equal to the **etime** value.



The **sdate** parameter value plus the **stime** parameter value must be less than the current time and date combination.

If **dir=bkwd** is specified with a date and time range, **sdate/stime** must be greater than **edate/etime**.

When the **enum** parameter is specified, the **snum** parameter must be specified with a value less than or equal to the specified **enum** value.

The specified **enum** parameter value and the specified **snum** value must be within the same range: **1-999** for Alarms (UAMs) and **1000-1499** for UIMs.

The **type** parameter and the **snum/enum** parameters cannot be specified together in the command.

The **rtrv-log:next=** command must be entered on the same terminal where the previous successful **rtrv-log** command was entered in the system. No other parameters can be entered with the **next** parameter in the command.

The **rtrv-log:next=** command cannot be entered following a **rtrv-log** command that contained the **type=all** parameter. A **rtrv-log** command without the **type=all** parameter must be entered before the **rtrv-log::next=** command can be entered.

Because entries can be overwritten between the entry of a **rtrv-log** command without the **next** parameter and the entry of a **rtrv-log:next=** command, the **rtrv-log:next:** command might not execute successfully. Another **rtrv-log** command without the **next** parameter must be entered before the **rtrv-log:next:** command can be entered again,

The values specified for the **edate** with the **stime** parameter combination is not valid.

The values specified for the **edate** with **stime** and **etime** parameter combination is not valid.

When an **enum** parameter is specified, it requires an **snum** as its mated parameter.

No other parameters can be entered with the **next** parameter in the command.

## Notes

This command can be canceled using the **F9** function key or the **canc-cmd** command. See **canc-cmd** for more information.

To accommodate the year 2000 and beyond, the two-digit year portion of dates is interpreted to be in the indicated century as follows:

years 95–99 = 1995 through 1999  
years 00–94 = 2000 through 2094

This means that date 000101 (Jan. 1, 2000) is greater than 991231 (Dec. 31, 1999).

The day portion of any **sdate/edate** value entered must be in agreement with the month and year. The system issues error message E2252 if the day is found to be not valid (for example, 960631 is not a valid date). The system software and date/time hardware properly handle leap years and leap centuries. The year 2000 is a leap year.

When no date or time parameters are specified, the log display depends on the specified or default values of two other parameters: **num** and **dir**. The **num** parameter determines the maximum number of entries to display, and the **dir** parameter determines whether entries are displayed from the oldest end (**dir=fwd** or not specified) or the newest end (**dir=bkwd**).

When **sdate** is specified and **edate** is not specified in the forward direction, **edate** is defaulted to be the end of the log.

When **edate** is specified and **sdate** is not specified in the forward direction, **sdate** is defaulted to be the beginning of the log.

When **sdate** is specified and **edate** is not specified in the backward direction, **edate** is defaulted to be the beginning of the log.

When **edate** is specified and **sdate** is not specified in the backward direction, **sdate** is defaulted to be the end of the log.

When **stime** is specified and **etime** is not specified in the forward direction, **etime** is defaulted to **235959**.

When **etime** is specified and **stime** is not specified in the forward direction, **stime** is defaulted to **000000**.

When **stime** is specified and **etime** is not specified in the backward direction, **rtime** is defaulted to **000000**.

When **etime** is specified and **stime** is not specified in the backward direction, **stime** is defaulted to **235959**.

When **stime** or **etime** is specified but neither the **sdate** or **edate** parameters are specified, **sdate** and **edate** are each defaulted to the value **today**.

The **num** parameter is used to control the maximum number of entries to be displayed by one command.

The **dir** parameter is used to control whether preceding (older) or following (newer) records are displayed. In either output format, records are displayed in time order regardless of the retrieval control of the **dir** parameter.

Because logging does not stop while records are displaying, old records that were displayed can be overwritten before they are accessed again.

After the date or time is changed in the system, output records can show anomalies in the date-time stamp. An example of this occurs when the time is changed back—in this case records may show that an earlier time follows a later time in the log.

When no Output Group (**outgrp**) is specified, no sorting based on Output Groups and no additional Alarm/UIM breakdown into Output Group categories is done for the report. The log entries will be shown only in the forward or reverse chronological ordering of the logs.

When a unique Output Group (**outgrp**) is specified, the report is separated into Alarm and UIM categories, and the entries for the specified Output Group are shown in each category.

When **outgrp=all** is specified, the report is separated into Alarm and UIM categories, and the available entries in each category are listed by Output Group.

The **next** parameter is used to display a specified number of additional log records after the previous **rtrv-log** entry at the terminal. New records that are logged after the previous **rtrv-log** command was entered will not be displayed when the **rtrv-log:next=** command is entered. The **next** parameter is valid only under the following conditions:

- The **rtrv-log:next=** command is entered at the same terminal from which the previous **rtrv-log** command was entered. The previous **rtrv-log** command must not include the **type=all** parameter.
- No other terminal has issued a **rtrv-log** command after the **rtrv-log** command entered at the terminal from which the **rtrv-log:next=** command is entered.
- The **next** parameter is the only parameter specified in the **rtrv-log** command.
- There are still logs present that match the conditions (except **time/date/num**) specified in the previous **rtrv-log** command.

When either a single **snum** or range of **snum/enum** is specified, only those Alarms or UIMs within the specified range are displayed.

When **snum** is specified and **enum** is not specified, the **enum** value defaults to the specified **snum** value.

When **enum** is specified, an **snum** value must be specified that is less than or equal to the specified **enum** value.

If an **snum** is specified within the range **1-999**, its corresponding **enum** must be greater than or equal to the **snum** and also within the range of **1-999**.

If an **snum** is specified within the range **1000-1499**, its corresponding **enum** must be greater than or equal to the **snum** and also within the range of **1000-1499**.

When **enum** is not specified and the specified **snum** Alarm or UIM does not exist (is not currently used in the system), a scroll area message indicates that the **snum** value is out of range.

If **snum** and **enum** are specified and one or both specified Alarms and/or UIMs do not exist (are not currently used in the system), the report lists all existing Alarms and/or UIMs that exist within the specified range.

## Output

In the following example, the sequence numbers that are replaced by the dashes (---) represent the UIMs that were discarded due to the UIM thresholding feature.

**rtrv-log:type=uim:sdate=960715:stime=220000:num=50**

```
rlghncxa03w 04-02-16 10:15:29 EST EAGLE 31.3.0
Card 1113; SYS REL= Rel 31.3.0; STP CLLI= ncralstp0001; Timezone= EST
```

```
**** Logged 99-07-16 01:03:09****
0001.1005 CARD 1105,B INFO GWS rcvd OPC that is not allowed
          SIO=01 OPC=001-001-001 DPC=002-002-002
          HOH1=000 AFTPC=003-003-003
          TEST MODE
          SR=scrib LSN=A1234567
          Report Date: 99-07-16 Time: 01:00:01
**** Logged 99-07-16 01:03:34****
----.1004 CARD 1205,B INFO MTP rcvd unknown DPC
          SIO=07 OPC=001-001-001 DPC=002-002-002
          LSN=A1234567
          Report Date: 99-07-16 Time: 01:01:00
**** Logged 99-07-16 01:03:55****
0014.1019 CARD 1103 INFO SCCP rcvd invalid UDTS msg
          SIO=03 OPC=001-001-001 DPC=002-002-002
          CDPA: SSN=005 TT=250
          CGPA: SSN=000 TT=000
          RETURN CAUSE=001
          DATA=26 80 03 09 0e 06 09 00 fe 08 50 55
          43 00
          LSN=A1234567
          Report Date: 99-07-16 Time: 01:00:05
```

;

The following example shows the records in the log created after 15 July 2003 at 10 PM up to a maximum of 50 records.

**rtrv-log:sdate=030715:stime=220000:num=50**

```
ncralstp00001 03-07-16 10:15:29 EST EAGLE 31.3.0
Card 1113; SYS REL= 31.3.0; STP CLLI= ncralstp00001; Timezone= EST
```

```
****03-07-15 22:03:09****
3159.0013 ** CARD 1207 CCS7ITU Card is isolated from the system
****03-07-15 22:03:11****
3160.0046 TERMINAL 10 Terminal enabled
****03-07-16 00:23:55****
3161.0200 SLK 1103,B RCVRY-LKF: link available
****03-07-16 01:42:18****
3162.0155 * DLK 2117,A STPLAN Connection unavailable
****03-07-16 01:43:51****
3163.0317 LSET A123456789 RCVRY-LKSTO: linkset allowed
****03-07-16 02:35:16****
3164.0082 * FUSE PANEL 11xx Alarm in fuse panel
****03-07-16 03:00:23****
3165.0108 ** IMT BUS A Major IMT fault detected
****03-07-16 03:37:59****
3166.0292 *C GLS SYSTEM GLS is not available
****03-07-16 07:22:06****
3167.0313 *C DPC 021-005-000 DPC is prohibited
****03-07-16 09:33:17****
3168.0348 * SEAS SYSTEM SEAS is at minimum service
****03-07-16 09:34:01****
3169.0112 * IMT SYSTEM Major Failures detected on both
****03-07-16 09:35:07****
3170.0160 * CLOCK SYSTEM 1116-S clock failed
```

```

****03-07-16 09:36:34****
3171.0160 * CARD 1116 OAM          1116-S clock failed
****03-07-16 09:37:23****
3172.0065 * CLOCK                  Minor holdover clock trouble detected
****03-07-16 09:38:12****
3173.0308 *C SYSTEM                Node isolated due to SLK failure
****03-07-16 09:39:56****
3174.0331 *C SCCP SYSTEM           SCCP is not available
****03-07-16 09:40:15****
3175.0002 * GPL SYSTEM OAM        Card is not running approved GP
****03-07-16 09:41:34****
3176.0153 *C SLAN SYSTEM          STPLAN not available
****03-07-16 09:42:45****
3177.0060 * CDT 9                 Minor customer trouble detected
****03-07-16 09:43:52****
3178.0344 * SEAS X25 LINK A1      SEAS PVC unavailable
****03-07-16 09:44:18****
3179.0344 * SEAS OAP A           SEAS UAL unavailable
****03-07-16 09:45:29****
3180.0321 * XLIST                 X-LIST occupancy threshold Exceeded
****03-07-16 09:48:48****
3181.0175 * SECURITY 1114         LOGBUFROVL-SECULOG - upload required
****03-07-16 10:23:47****
0259.0084 ** DSM 1101,B          IP Connection Unavailable
Failed Channels:  Prov Dnld TCP UDP
****03-07-16 10:25:41****
0069.0084 ** STC 1105,B          IP Connection Unavailable
ERROR STATUS: DHCP Lease. Physical Link.
;

UAM Report terminated - end of log reached.
END OF ALARM LOG REPORT.
;

```

The following example shows the records in the log created after 15 July 2003 at 10 PM for Alarm (UAM) 160.

```

rtrv-log:sdate=030715:stime=220000:num=50:snum=160
ncralstp00001 03-07-16 10:15:29 EST EAGLE 31.3.0
Card 1113; SYS REL= 31.3.0; STP CLLI= ncralstp00001; Timezone= EST

****03-07-16 09:35:07****
3170.0160 * CLOCK SYSTEM          1116-S clock failed
****03-07-16 09:36:34****
3171.0160 * CARD 1116 OAM          1116-S clock failed
;

UAM Report terminated - end of log reached.
END OF LOG REPORT.
;

```

The following example shows the records in the log created after 15 July 2003 at 10 PM that include Alarms (UAMs) 106 through 350.

```

rtrv-log:sdate=030715:stime=220000:num=50:snum=106:enum=350
ncralstp00001 03-07-16 10:15:29 EST EAGLE 31.3.0
Card 1113; SYS REL= 31.3.0; STP CLLI= ncralstp00001; Timezone= EST

****03-07-16 00:23:55****
3161.0200 SLK 1103,B             RCVRY-LKF: link available
****03-07-16 01:42:18****
3162.0155 * DLK 2117,A          STPLAN Exceededn unavailable
****03-07-16 01:43:51****
3163.0317 LSET A123456789       RCVRY-LKSTO: linkset allowed
****03-07-16 03:00:23****

```

```

3165.0108 ** IMT BUS A           Major IMT fault detected
****03-07-16 03:37:59****
3166.0292 *C GLS SYSTEM         GLS is not available
****03-07-16 07:22:06****
3167.0313 *C DPC 021-005-000    DPC is prohibited
****03-07-16 09:33:17****
3168.0348 * SEAS SYSTEM         SEAS is at minimum service
****03-07-16 09:34:01****
3169.0112 * IMT SYSTEM         Major Failures detected on both
****03-07-16 09:35:07****
3170.0160 * CLOCK SYSTEM       1116-S clock failed
****03-07-16 09:36:34****
3171.0160 * CARD 1116 OAM      1116-S clock failed
****03-07-16 09:38:12****
3173.0308 *C SYSTEM           Node isolated due to SLK failure
****03-07-16 09:39:56****
3174.0331 *C SCCP SYSTEM       SCCP is not available
****03-07-16 09:41:34****
3176.0153 *C SLAN SYSTEM       STPLAN not available
****03-07-16 09:43:52****
3178.0344 * SEAS X25 LINK A1   SEAS PVC unavailable
****03-07-16 09:44:18****
3179.0344 * SEAS OAP A        SEAS UAL unavailable
****03-07-16 09:45:29****
3180.0321 * XLIST              X-LIST occupancy threshold Exceeded
****03-07-16 09:48:48****
3181.0175 * SECURITY 1114      LOGBUFROVL-SECULOG - upload required
;

UAM Report terminated - end of log reached.
END OF LOG REPORT.
;

```

The following example shows the records in the log created after 15 July 2003 at 10 PM for Alarms (UAMs) and UIMs in the SLAN Output Group.

**rtrv-log:sdate=030715:stime=220000:num=50:outgrp=slan:type=all**

```

ncralstp00001 03-07-16 10:15:29 EST EAGLE 31.3.0
Card 1113; SYS REL= 31.3.0; STP CLLI= ncralstp00001; Timezone= EST

```

```

Alarm Output Group - SLAN
****03-07-16 09:41:34****
3176.0153 *C SLAN SYSTEM       STPLAN not available

```

```

UIM Output Group - SLAN
**** Logged 03-07-16 01:03:09****
0001.1005 CARD 1105,B INFO GWS rcvd OPC that is not allowed
SIO=01 OPC=001-001-001 DPC=002-002-002
HOH1=000 AFTPC=003-003-003
TEST MODE
SR=scrib LSN=A1234567
Report Date: 03-07-16 Time: 01:00:01

```

```

;
Report terminated - end of log reached.
END OF LOG REPORT.
;

```

The following example shows the records in the log in the backward direction that were created between 12 June 2003 at 4:48:27 PM and 11 June 2003 at 10:00:45 PM for Alarms (UAMs).

**rtrv-**

**log:dir=bkwd:stime=044827:sdate=030612:etime=100045:edate=030611**

```

tekelecstp 03-06-23 04:10:12 EST EAGLE 31.3.0
Card 1115; SYS REL= 31.3.0. STP CLLI= tekelecstp; Timezone= EST

```

```
Report Initiated - extended processing time required

****03-06-12 04:48:27****
5001.0009 CARD 1115 EOAM MASP became active
****03-06-11 13:38:55****
5003.0002 * GPL SYSTEM BPHMUX Card is not running approved GPL
****03-06-11 13:38:55****
5002.0002 * GPL SYSTEM BPDCM Card is not running approved GPL
****03-06-11 13:36:04****
5001.0009 CARD 1115 EOAM MASP became active
****03-06-11 12:15:29****
5001.0009 CARD 1115 EOAM MASP became active
****03-06-11 11:19:51****
5001.0009 CARD 1115 EOAM MASP became active
****03-06-11 10:00:46****
5019.0109 IMT SYSTEM All IMT System level alarms cleared
****03-06-11 10:00:45****
5018.0106 IMT BUS B IMT Bus alarm cleared
****03-06-11 10:00:45****
5017.0106 IMT BUS A IMT Bus alarm cleared
****03-06-11 10:00:45****
5016.0014 CARD 1107 SS7ANSI Card is present
ASSY SN: 10200301518
****03-06-11 10:00:45****
5015.0111 ** IMT SYSTEM Failure on both IMT A and IMT B
UAM Report terminated - 11 records displayed
END OF LOG REPORT.
```

;

The following example shows all the records in the log in the backward direction (UAMs and UIMs).

**rtrv-log:type=all**

```
tekelecstp 06-01-06 09:16:20 EST EAGLE 35.0.0
Card 1113; SYS REL= 35.0.0; STP CLLI= tekelecstp; Timezone= ****

****06-01-06 09:06:49****
0002.0009 CARD 1113 EOAM MASP became active
****06-01-06 09:11:16****
0004.0143 * CARD 1113 EOAM System release GPL(s) not approved
****06-01-06 09:13:54****
0005.0048 * TERMINAL 4 Terminal failed
****06-01-06 09:13:59****
0006.0046 TERMINAL 2 Terminal enabled
UAM Report terminated - end of log reached
```

;

```
tekelecstp 06-01-06 09:16:22 **** EST EAGLE 35.0.0
Card 1113; SYS REL= 35.0.0; STP CLLI= tekelecstp; Timezone= ****

****Logged 06-01-06 09:10:43****
0003.1083 SYSTEM INFO REPT COND: system alive
Report Date:06-01-06 Time:09:10:43
****Logged 06-01-06 09:15:43****
0007.1083 SYSTEM INFO REPT COND: system alive
Report Date:06-01-06 Time:09:15:43
UIM Report terminated - end of log reached
END OF LOG REPORT.
```

;

The following example shows the log records in the backward direction that include Alarms (UAMs) 937 and 938 for the RTD System.

**rtrv-log:dir=bkwd:num=10**

```
stdcfglb 13-06-23 00:05:42 WET EAGLE 35.6.0
Card 1113; SYS REL= 35.6.0; STP CLLI= stdcfglb; Timezone= WET
```

```

****13-06-23 00:03:42****
0936.0542 RTD SYSTEM MSU cksum error threshold cleared
****13-06-22 23:15:12****
0915.0541 *C RTD SYSTEM MSU cksum error threshold exceeded
****13-06-21 21:50:24****
0144.0542 RTD SYSTEM MSU cksum error threshold cleared
****13-06-21 21:48:47****
0142.0541 *C RTD SYSTEM MSU cksum error threshold exceeded
****13-06-21 21:32:03****
0138.0096 CARD 1101 SS7ML Card has been reloaded
****13-06-21 21:31:40****
0137.0002 * GPL SYSTEM SS7ML Card is not running approved GPL
****13-06-21 21:31:28****
0136.0109 IMT SYSTEM All IMT System level alarms cleared
Outstanding IMT BUS A failure for card 1111, 1113
****13-06-21 21:31:28****
0135.0106 IMT BUS B IMT Bus alarm cleared
UAM Report terminated - max. or num= count reached
END OF LOG REPORT.
;

```

**rtrv-loopset****Retrieve Loop Set Command**

Use this command to retrieve loopset data from the database.

**Keyword:** rtrv-loopset

**Related Commands:** chg-loopset, dlt-loopset, ent-loopset

**Command Class:** Database Administration

**Parameters**

**:disp=** (optional)

Display method. This parameter specifies the manner in which the retrieved data is displayed.

**Range:** detail, list

**detail**— Provides detailed information for a loopset entry.

**list**— Provides a list of loopset entries.

If the **name** parameter is specified, then the **disp=list** parameter cannot be specified.

**Default:** detail

**:force=** (optional)

The **force=yes** parameter must be specified if the value of the **num** parameter is greater than **50**.

**Range:** yes

**:mode=** (optional)

Mode of operation. This parameter retrieves loopset entries that have been assigned the specified mode.

**Range:** notify, discard

**notify**— Generates a UIM without discarding the message.

**discard**— Generates a UIM and discards the message.

**:name=** (optional)

Loopset name. This parameter retrieves a specified loopset.

The **name=none** parameter cannot be specified.

**Range:** ayyyyyyy

1 alphabetic and up to 7 alphanumeric characters.

**:num=** (optional)

Number. This parameter specifies the number of entries to be retrieved.

If the value of the **num** parameter is greater than **50**, then the **force=yes** parameter must be specified.

**Range:** 1-1000



**Default:** 50

### Example

This example provides detailed information for the first 50 valid loopset entries in the loopset table.

```
rtrv-loopset
```

This example provides detailed information for the loopset entry rtp1.

```
rtrv-loopset:name=rtp1
```

This example provides detailed information for the first 100 valid loopset entries in the loopset table.

```
rtrv-loopset:num=100:force=yes
```

This example provides a list of the first 100 valid loopset entries in the loopset table.

```
rtrv-loopset:force=yes:num=100:disp=list
```

This example provides detailed information for the first 100 valid loopset entries set to discard mode in the loopset table.

```
rtrv-loopset:force=yes:num=100:mode=discard
```

This example provides a list of the first 100 valid loopset entries set to notify mode in the loopset table.

```
rtrv-loopset:force=yes:num=100:mode=notify:disp=list
```

### Dependencies

If the value of the **num** parameter is greater than **50**, then the **force=yes** parameter must be specified.

The value of the **name** parameter must already exist in the database.

The SCCP Loop Detection feature must be enabled before this command can be entered.

The GTT feature must be turned on before this command can be entered.

The **name=none** parameter cannot be specified.

If the **name** parameter is specified, then the **disp=list** parameter cannot be specified.

**Output**

The following example displays the loopset entry details for loopset **rtp1**.

**rtrv-loopset:name=rtp1**

rlghncxa03w 07-02-10 08:52:38 EST EAGLE Rel 35.6.0

| LoopSet | Mode    | Point Codes                                                              |
|---------|---------|--------------------------------------------------------------------------|
| RTP1    | Discard | 005-005-005 007-007-007 (ANSI)<br>003-007-003 005-007-005<br>005-004-005 |

;

The following example displays details for up to 100 loopset entries.

**rtrv-loopset:num=100:force=yes**

rlghncxa03w 07-02-10 08:59:18 EST EAGLE Rel 35.6.0

| LoopSet | Mode    | Point Codes                                                                                                     |
|---------|---------|-----------------------------------------------------------------------------------------------------------------|
| Cary2   | Notify  | 005-015-005 007-007-007 (ANSI)<br>033-007-003 005-027-005                                                       |
| Cary4   | Notify  | 005-012-005 007-026-007 (ANSI)<br>033-002-003 005-008-055                                                       |
| Apex3   | Discard | 005-017-008 007-017-009 (ANSI)<br>005-014-005 005-017-005<br>033-002-043 005-038-005<br>033-003-043 005-012-005 |
| Apex4   | Discard | 005-007-008 027-007-009 (ANSI)<br>005-004-055 027-001-007<br>033-007-003 005-003-055                            |
| RAL5    | Notify  | 005-005-005 007-007-007 (ANSI)<br>003-001-003 005-007-005<br>003-002-003 005-008-005<br>003-003-003 005-002-005 |
| RAL6    | Notify  | 005-007-008 007-007-009 (ANSI)<br>003-007-003                                                                   |
| DUNN1   | Discard | 005-002-055 007-051-007 (ANSI)                                                                                  |
| RTP9    | Discard | 005-002-005 007-001-007 (ANSI)<br>003-007-003 005-003-005<br>005-004-005                                        |
| RTP5    | Discard | 005-007-008 007-007-009 (ANSI)                                                                                  |
| RTP1    | Discard | 005-005-005 007-007-007 (ANSI)<br>003-007-003 005-007-005<br>005-004-005                                        |
| RTP2    | Notify  | 005-007-008 007-007-009 (ANSI)                                                                                  |

;

The following example displays the names and modes of up to 100 loopset entries.

**rtrv-loopset:force=yes:num=100:disp=list**

rlghncxa03w 07-02-10 09:03:27 EST EAGLE Rel 35.6.0

| LoopSet | Mode    |  | LoopSet | Mode   |  | LoopSet | Mode    |
|---------|---------|--|---------|--------|--|---------|---------|
| Cary2   | Notify  |  | Cary4   | Notify |  | Apex3   | Discard |
| Apex4   | Discard |  | RAL5    | Notify |  | RAL6    | Notify  |

```

DUNN1   Discard  || RTP9   Discard  || RTP5   Discard
RTP1    Discard  || RTP2   Notify
;

```

The following example displays a list of up to 100 loopset entries that contain the **mode=notify** parameter.

```

rtrv-loopset:force=yes:num=100:mode=notify:disp=list
rlghncxa03w 07-02-10 09:10:07 EST EAGLE Rel 35.6.0

LoopSet  Mode      || LoopSet  Mode      || LoopSet  Mode
=====
Cary2    Notify    || Cary4    Notify    || RAL5     Notify
RAL6     Notify    || RTP2     Notify
;

```

**rtrv-ls**

**Retrieve Linkset**

Use this command to show the linkset information.

**Keyword:** rtrv-ls

**Related Commands:** chg-ls, chg-lsopts, dlt-ls, ent-ls, rept-stat-ls

**Command Class:** Database Administration

**Parameters**

**:apc=** (optional)

ANSI point code with subfields *network indicator-network cluster-network cluster member (ni-nc-ncm)*. The prefix subfield indicates a private point code (*prefix-ni-nc-ncm*).

**Range:** p-, 000-255

Specify a valid value for each subfield of the point code, and separate the subfields with a dash (-).

*prefix—p-*

When **chg-sid:pctype=ansi** is specified, *ni = 000* is not valid.

When **chg-sid:pctype=ansi** is specified, *nc = 000* is not valid if *ni = 001-005*.

When **chg-sid:pctype=ansi** is specified, *nc = 000* is valid if *ni = 006-255*.

The point code **000-000-000** is not a valid point code.

**:apc/apca/apci/apcn/apcn24=** (optional)

Adjacent point code.

**:apci=** (optional)

ITU international point code with subfields *zone-area-id*. The prefix subfield indicates a spare point code, private point code, or private and spare point code (*prefix-zone-area-id*).

**Range:** s-, p-, ps-, 0-255

Specify a valid value for each subfield of the point code, and separate the subfields with a dash (-).

*prefix—s-, p-, ps-*

*zone—0-7*

*area—000-255*

*id—0-7*

The point code **0-000-0** is not a valid point code.

**:apcn=** (optional)

ITU national point code in the format of a 5-digit number (*nnnnn*); or 2, 3, or 4 numbers (*members*) separated by dashes (*m1-m2-m3-m4*) as defined by the **chg-stpopts:npfnti** flexible

point code option. A group code must be specified when the ITUDUPPC feature is turned on (*nnnnn-gc*, *m1-m2-m3-m4-gc*). The prefix subfield indicates a spare point code, private point code, or private and spare point code (*prefix-nnnnn*, *prefix-nnnnn-gc*, *prefix-m1-m2-m3-m4*, *prefix-m1-m2-m3-m4-gc*).

**Range:** **s-, p-, ps-, 0-16383, aa-zz**

Specify a valid value for each subfield of the point code, and separate the subfields with a dash (-).

*prefix*—**s-, p-, ps-**

*nnnnn*—**0-16383**

*gc*—**aa-zz**

*m1-m2-m3-m4*—**0-14** for each member; values must sum to 14

**:apcn24=** (optional)

24-bit ITU national point code with subfields *main signaling area-sub signaling area-signaling point* (*msa-ssa-sp*). The prefix indicates a private point code (*prefix-msa-ssa-sp*).

**Range:** **p-, 000-255**

Specify a valid value for each subfield of the point code, and separate the subfields with a dash (-).

*prefix*—**p-**

*msa*—**000-255**

*ssa*—**000-255**

*sp*—**000-255**

**:cggtmod=** (optional)

Calling party GT modification indicator. This parameter displays the linksets that have the specified value of the calling party GT modification indicator.

**Range:** **yes, no**

**:islsrsb=** (optional)

Incoming rotated signaling link selection (SLS) bit. This parameter displays the linksets with the specified rotated bit.

**Range:** **1-8**

ITU linksets—**1-4**

ANSI linksets—**1-8**

**Default:** Display all link sets

**:itutfr=** (optional)

ITU TFR (Transfer Restricted) procedure indicator. This parameter displays the linksets that have the specified value of the **itutfr** parameter.

This parameter is valid for ITU national linksets only.

**Range:** **on, off**

**Default:** Display all link sets

**:lsn=** (optional)

Linkset name

**Range:** *ayyyyyyyyy*

1 alphabetic character followed by up to 9 alphanumeric characters

**Default:** Display all link sets

**:lst=** (optional)

Linkset type. This parameter specifies whether to display proxy links.

This parameter can be specified only when the Proxy Point Code feature is enabled.

**Range:** **prx**

**prx** — Display proxy links.

**:mtprse=** (optional)

ANSI or ITU MTP Restart equipped. This parameter specifies whether the node adjacent to the linkset is equipped with MTP Restart.

**Range:**     **yes, no**  
               **yes** — equipped  
               **no** — not equipped

**Default:**   Display all link sets

**:ppc=** (optional)

ANSI proxy point code with subfields *network indicator-network cluster-network cluster member (ni-nc-ncm)*.

The proxy point code must be a full point code.

**Synonym:** **ppca**

**Range:**     **000-255**

Specify a valid value for each subfield of the point code, and separate the subfields with a dash (-).

When **chg-sid:pctype=ansi** is specified, *ni = 000* is not valid.

When **chg-sid:pctype=ansi** is specified, *nc = 000* is not valid if *ni = 001-005*.

When **chg-sid:pctype=ansi** is specified, *nc = 000* is valid if *ni = 006-255*.

The point code **000-000-000** is not a valid point code.

**:ppc/ppca/ppci/ppcn/ppcn24=** (optional)

Proxy Point Code.

The proxy point code must be a full point code.

**:ppci=** (optional)

ITU international proxy point code with subfields *zone-area-id*. The prefix subfield indicates a spare point code (*prefix-zone-area-id*).

**Range:**     **s-, 0-255**

Specify a valid value for each subfield of the point code, and separate the subfields with a dash (-).

*prefix*—**s-**

*zone*—**0-7**

*area*—**000-255**

*id*—**0-7**

The point code **0-000-0** is not a valid point code.

**:ppcn=** (optional)

ITU national proxy point code in the format of a 5-digit number (*nnnnn*); or 2, 3, or 4 numbers (*members*) separated by dashes (*m1-m2-m3-m4*) as defined by the **chg-stpopts:npcfmti** flexible point code option. A group code must be specified when the ITUDUPPC feature is turned on (*nnnnn-gc*, *m1-m2-m3-m4-gc*). The prefix subfield indicates a spare point code (*prefix-nnnnn*, *prefix-nnnnn-gc*, *prefix-m1-m2-m3-m4*, *prefix-m1-m2-m3-m4-gc*).

**Range:**     **s-, 0-16383, aa-zz**

Specify a valid value for each subfield of the point code, and separate the subfields with a dash (-).

*prefix*—**s-**

*nnnnn*—**0-16383**

*gc—aa-zz*

*m1-m2-m3-m4—0-14* for each member; values must sum to 14

**:ppcn24=** (optional)

24-bit ITU national point code with subfields *main signaling area-sub signaling area-signaling point (msa-ssa-sp)*.

**Range:** **000-255**

Specify a valid value for each subfield of the point code, and separate the subfields with a dash (-).

*msa—000-255*

*ssa—000-255*

*sp—000-255*

**:randsls=** (optional)

Random SLS (signaling link selection). This parameter is used to display linksets that have the specified value of the **randsls** parameter.

**Range:** **off, class0, all**

**off**— Displays all linksets where random SLS is disabled.

**class0**— Displays linksets where random SLS generation for Class0 SCCP traffic is enabled.

**all**— Displays ITU linksets where random SLS generation for Class0 and Class1 SCCP traffic is enabled and ANSI linksets where random SLS generation for Class0 and ISUP traffic is enabled.

**Default:** **off**

**:slsocbit=** (optional)

Other CIC (Circuit Identification Code) Bit. This parameter displays all the linksets that have the **slsocbit** parameter set to a value from **5** to **16**.

**Range:** \*

\*— Specifies all possible values ( **5-16** )

**Default:** Display all link sets

**:slsrsb=** (optional)

Rotated SLS (Signaling Link Selection) Bit. This parameter displays the linksets with the specified rotated bit.

**Range:** **1-4**

**Default:** Display all link sets

**:spc=** (optional)

ANSI secondary point code with subfields *network indicator-network cluster-network cluster member (ni-nc-ncm)*.

**Range:** **000-255**

Specify a valid value for each subfield of the point code, and separate the subfields with a dash (-).

When **chg-sid:pctype=ansi** is specified, **ni = 000** is not valid.

When **chg-sid:pctype=ansi** is specified, **nc = 000** is not valid if **ni = 001-005**.

When **chg-sid:pctype=ansi** is specified, **nc = 000** is valid if **ni = 006-255**.

The point code **000-000-000** is not a valid point code.

**:spc/spca/spci/spcn/spcn24=** (optional)

Secondary point code.

**:spci=** (optional)

ITU international secondary point code with subfields *zone-area-id*. The *prefix* subfield indicates a spare point code (*prefix-zone-area-id*).

**Range:** **s-, 0-255**

Specify a valid value for each subfield of the point code, and separate the subfields with a dash (-).

*prefix*—**s-**

*zone*—**0-7**

*area*—**000-255**

*id*—**0-7**

The point code **0-000-0** is not a valid point code.

**:spcn=** (optional)

ITU national secondary point code in the format of a 5-digit number (*nnnnn*); or 2, 3, or 4 numbers (members) separated by dashes (*m1-m2-m3-m4*) as defined by the **chg-stpopts:npcfnti** flexible point code option. A group code must be specified when the ITUDUPPC feature is turned on (*nnnnn-gc*, *m1-m2-m3-m4-gc*). The *prefix* subfield indicates a spare point code (*prefix-nnnnn*, *prefix-nnnnn-gc*, *prefix-m1-m2-m3-m4*, *prefix-m1-m2-m3-m4-gc*).

**Range:** **s-, 0-16383, aa-zz**

Specify a valid value for each subfield of the point code, and separate the subfields with a dash (-).

*prefix*—**s-**

*nnnnn*—**0-16383**

*gc*—**aa-zz**

*m1-m2-m3-m4*—**0-14** for each member; values must sum to 14

**:spcn24=** (optional)

24-bit ITU national secondary point code with subfields *main signaling area-sub signaling area-signaling point* (*msa-ssa-sp*).

**Range:** **000-255**

Specify a valid value for each subfield of the point code, and separate the subfields with a dash (-).

*msa*—**000-255**

*ssa*—**000-255**

*sp*—**000-255**

**Example**

Display the attributes of all link sets:

```
rtrv-ls
```

Retrieve link set ls1:

```
rtrv-ls:lsn=ls1
```

Retrieve all link sets with the mtrprse parameter set to yes:

```
rtrv-ls:mtrprse=yes
```

Retrieve all link sets that use the slsocbit parameter with a value from 5 to 16:

```
rtrv-ls:slsocbit=*
```

Display a specified ITU linkset to view the settings for the slrsb or slsocbit parameters:

```
rtrv-ls:lsn=lsitu
```

Retrieve all ITU national linksets that have the `itutfr` parameter set to on:

**rtrv-ls:itutfr=on**

Retrieve the specified ITU national linkset and display its setting for the `itutfr` parameter:

**rtrv-ls:lsn=lsitun**

Retrieve all linksets where random SLS generation is enabled for SCCP ITU traffic and Class0 ANSI traffic.

**rtrv-ls:randsls=class0**

Display all proxy linksets.

**rtrv-ls:lst=prx**

Display all linksets using a specified proxy point code.

**rtrv-ls:ppc=11-11-11**

Display all linksets using a specified secondary point code.

**rtrv-ls:spc=2-2-2**

Display all linksets using a specified adjacent point code.

**rtrv-ls:apc=1-1-2**

Retrieves all linksets where calling party global title modification is requested:

**rtrv-ls:cggmod=yes**

Retrieves all link sets with the ISLSRSB value 6.

**rtrv-ls:islsrsb=6**

## Dependencies

The specified linkset must be in the database.

All optional parameters, except for the combination of the **slsocbit** and **slsrsb** parameters, can only be used individually. Any combination of 2 or more of the optional parameters, other than the specified exception, is invalid.

If the **apcn** parameter is specified as the Adjacent Point Code, then the format of the **apcn** parameter must match the format dictated by the **chg-stpopts:npcfmti** parameter.

The SLSOCB feature must be enabled before the **slsocbit** parameter can be specified.

The Multiple Linksets to Single Adjacent PC (MLS) feature must be turned on before the **apc** and **spc** parameters can be specified.

At least one linkset must be associated with the value of the **apc** parameter.

The Proxy Point Code feature must be enabled before the **lst=prx** parameter can be specified.

The Proxy Point Code feature must be enabled before the **ppc** parameter can be specified.

The value specified for the **ppc** parameter must be a full point code.

The value specified for the **ppc** parameter must already exist in the Destination table, and the **prx=yes** parameter must have been specified.

The value specified for the **apc** parameter must be a full point code.

The value specified for the **spc** parameter must be a full point code.

The AMGTT feature or the AMGTT CgPA Upgrade feature must be turned on before the **cggmod** parameter can be specified.

The ISLSRSB feature must be enabled before the **islsbr** parameter can be specified.



## Notes

This command can be canceled using the **F9** function key or the **canc-cmd** command. See **canc-cmd** for more information.

The CLLI, TFATCABMLQ, MTPRSE, and ASL8 fields are displayed only when a specific linkset is specified. The SLSOCBIT and SLSRSB fields are displayed only when a specific linkset is specified, and the linkset must be an ITU linkset.

If the **tfatcabmlq** parameter database value is **0** for a linkset, then the value displayed is one-half (rounded-up) of the number of links assigned to the given linkset (or **1** if there are 2 or fewer links in the linkset).

If the **tfatcabmlq** parameter database value is **0**, then the TFA/TCA broadcast minimum link quantity is calculated by the EAGLE 5 ISS to be a minimum of **1** for linksets containing 2 or fewer links, or half (rounded-up) of the number of links configured in the linkset for linksets containing more than 2 links. The calculated value is displayed in the **rtrv-ls** command output.

If the **tfatcabmlq** parameter value is set to a specific value greater than **0**, then the EAGLE 5 ISS does not calculate a TFA/TCA broadcast minimum link quantity. The provisioned value is displayed in the **rtrv-ls** command output.

The EAGLE 5 ISS **ent-ls** command allows 10-character linkset names, but entering a linkset name through SEAS is still restricted to 8 characters. In SEAS, a specific linkset with a name greater than 8 characters (entered using the EAGLE 5 ISS command) cannot be retrieved by name. If an asterisk is used for the linkset name in the SEAS **vfy-ls** command, all linksets will be shown; however, the linkset names that are more than 8 characters will have only the first 8 characters shown. Therefore it may appear that there are duplicate linkset names in SEAS **vfy-ls** output, but all linkset names are actually unique.

In this command, only ITU-international and ITU national point codes support the spare point code subtype prefix (**s-**) and the private and spare point code subtype prefix (**ps-**). All of the point code types support the private (internal) point code subtype prefix (**p-**).

The value specified for the **ppc** parameter must be a full point code. Cluster point codes and private point codes are not supported.

The ICNIMAP and OGNIMAP fields are displayed only if the linkset name is specified in the command, the ITU Spare Point Code feature is enabled, and an ITUN or ITUI point code is associated with the linkset.

## Output

The Multiple Linksets to Single Adjacent PC (MLS) feature must be turned on before information can be retrieved for an adjacent point code or a secondary point code.

The Proxy Point Code feature must be enabled before information can be retrieved by proxy point code or proxy linkset.

In Release 37.5.0, if information is requested for a linkset, then the secondary point code field is displayed in the output. If the MLS feature is not enabled, or if the linkset was not created with a secondary point code, the field contains dashes.

In Release 38.0, headings for unequipped cards are not displayed.

The following example shows all linksets where random SLS generation is enabled for Class0 and Class1 SCCP traffic for ITU linksets and Class0 and ISUP traffic for ANSI linksets:

### rtrv-ls:randsls=all

```
tekelecstp 08-10-30 19:36:00 EST EAGLE 40.0.0
```

| LSN    | APCA (SS7)  | SCRN | L3T | SLT | BEI | LST | LNKS | ACT | MES | DIS | SLSCI | NIS |
|--------|-------------|------|-----|-----|-----|-----|------|-----|-----|-----|-------|-----|
| lsa111 | 001-001-001 | none | 1   | 1   | no  | B   | 0    | off | off | off | no    | off |

| LSN    | APCI (SS7) | SCRN | L3T | SLT | BEI | LST | LNKS | ACT | MES | DIS | SLSCI | NIS |
|--------|------------|------|-----|-----|-----|-----|------|-----|-----|-----|-------|-----|
| lsi111 | 1-001-1    | none | 1   | 2   | no  | B   | 0    | off | off | off | no    | off |

Link set table is (2 of 1024) 1% full.

;

The following example shows detailed linkset configuration for linkset **lsi111**. Random SLS generation is enabled for Class0 and Class1 SCCP traffic.

### rtrv-ls:lsn=lsi111

```
tekelecstp 08-02-26 12:49:06 EST EAGLE 38.0.0
```

| LSN    | APCI (SS7) | SCRN | L3T | SLT | BEI | LST | LNKS | ACT | MES | DIS | SLSCI | NIS |
|--------|------------|------|-----|-----|-----|-----|------|-----|-----|-----|-------|-----|
| lsi111 | 1-000-1    | none | 1   | 2   | no  | A   | 0    | off | off | off | no    | off |

| SPCI  | CLLI  | TFATCABMLQ | MTPRSE | ASL8 |
|-------|-------|------------|--------|------|
| ----- | ----- | 1          | ---    | ---  |

| SLSRSB | RANDSLS | ITUTFR |
|--------|---------|--------|
| 1      | all     | off    |

| IPSG | IPGWAPC | GTTMODE | CGGTMOD |
|------|---------|---------|---------|
| no   | no      | CdPA    | no      |

Link set table is (1 of 1024) 1% full.

;

The following example shows detailed linkset configuration for linkset **ls4**. Random SLS generation is enabled for SCCP Class0 traffic, and the SLSOCB and the ITUDUPPC features are turned on.

### rtrv-ls:lsn=ls4

```
tekelecstp 08-02-05 06:44:15 EST EAGLE5 38.0.0
```

| LSN | APCI (SS7) | SCRN | L3T | SLT | BEI | LST | LNKS | ACT | MES | DIS | SLSCI | NIS |
|-----|------------|------|-----|-----|-----|-----|------|-----|-----|-----|-------|-----|
| ls4 | 1-007-4    | none | 1   | 2   | no  | A   | 4    | off | off | off | ---   | off |

| SPCA | CLLI | TFATCABMLQ | MTPRSE | ASL8 | GSMSCRN |
|------|------|------------|--------|------|---------|
|      |      |            |        |      |         |

```

----- 2 --- off
SLSOCBIT SLSRSB RANDSLS MULTGC ITUTFR
none 1 class0 no off
IPSG IPGWAPC GTTMODE CGGTMOD
no no CdPA no
LOC LINK SLC TYPE L2T PCR PCR E1 E1
SET BPS ECM N1 N2 LOC PORT TS
1202 B 0 LIME1 11 56000 BASIC --- ----- 1202 1 5
1202 B1 1 LIME1 11 56000 BASIC --- ----- 1202 1 6
1202 B2 2 LIME1 11 56000 BASIC --- ----- 1202 1 7
1202 B3 3 LIME1 11 56000 BASIC --- ----- 1202 1 8

```

Link set table is (167 of 1024) 16% full.

;

The following example displays the attributes of all linksets.

If the **mtrprse** or **slsocbit** parameters are specified (i.e. **rtrv-ls:mtrprse=**), then the output appears the same as the **rtrv-ls** output. The command filters the output to display only the linksets that have the specified value of the parameter.

**rtrv-ls**

tekelecstp 08-02-26 20:11:43 EST EAGLE 38.0.0

```

L3T SLT GWS GWS GWS
LSN APCA (SS7) SCR N SET SET BEI LST LNKS ACT MES DIS SLSCI NIS
lsa1111 011-001-001 none 1 1 no A 1 off off off no off
lsa1112 011-001-002 none 1 1 no A 1 off off off no off
lsa1121 011-002-001 none 1 1 no A 1 off off off no off
lsa1122 011-002-002 none 1 1 no A 1 off off off no off
lsa111111 011-011-011 none 1 1 no A 1 off off off no off

```

```

L3T SLT GWS GWS GWS
LSN APCI (SS7) SCR N SET SET BEI LST LNKS ACT MES DIS SLSCI NIS
lsi311 3-001-1 none 1 2 no A 0 off off off --- off

```

```

L3T SLT GWS GWS GWS
LSN APCN24 (SS7) SCR N SET SET BEI LST LNKS ACT MES DIS SLSCI NIS
lsn24 024-024-024 none 1 2 no A 0 off off off --- off

```

Link set table is (7 of 1024) 1% full.

;

In the following example for the specified linkset:

- The TFATCABMLQ and MTPRSE fields are displayed only when a linkset is specified. The TFACABMLQ and MTPRSE attribute values are "---" because these attributes are not supported for link sets terminating in the X.25 domain. The FE-PC of this link set has no CLLI; therefore the CLLI is shown as "-----".
- The SLSOCBIT and SLSRSB fields are not displayed for ANSI linksets.
- RANDSLS information is displayed for an ANSI linkset.

**rtrv-ls:lsn=ls1**

tekelecstp 09-08-09 00:36:40 EST EAGLE 41.1.0

```

L3T SLT GWS GWS GWS
LSN APCA (SS7) SCR N SET SET BEI LST LNKS ACT MES DIS SLSCI NIS
ls1 003-003-003 gws1 1 1 no A 15 on on on yes off

```

```

      SPCA          CLLI          TFATCABMLQ MTPRSE ASL8
-----
                                7          ---   no

RANDSLS
off

IPSG  IPGWAPC  GTTMODE          CGGTMOD
no    no      CdPA              no

      LOC  LINK  SLC  TYPE          L2T          PCR  PCR
      SET  BPS   ECM   N1   N2
1101 A    0    LIMDS0  1    56000  BASIC  ---  ---

      LOC  LINK  SLC  TYPE          LP          ATM          VCI  VPI  LL
      SET  BPS   TSEL  EXTERNAL  5    0    0
1102 A    2    LIMATM  1    1544000

      LOC  LINK  SLC  TYPE          IPLIML2
1201 A    5    IPLIM    M2PA

      LOC  LINK  SLC  TYPE          L2T          PCR  PCR  E1  E1
      SET  BPS   ECM   N1   N2   LOC  PORT  TS
1205 A    6    LIME1    1    56000  BASIC  ---  ---  1205  1    1

      LOC  LINK  SLC  TYPE          L2T          PCR  PCR  T1  T1
      SET  BPS   ECM   N1   N2   LOC  PORT  TS
1206 A    10   LIMT1    1    56000  BASIC  ---  ---  1206  1    1

```

Link set table is (7 of 1024) 1% full.

;  
The following example shows output that includes a multi-port LIM:

**rtrv-ls:lsn=ls1**

tekelecstp 09-08-09 00:39:45 EST EAGLE 41.1.0

```

      L3T SLT          GWS GWS GWS
LSN      APCA  (SS7)  SCRN SET SET BEI LST LNKS ACT MES DIS SLSCI NIS
ls1      240-020-000 none 1 2 no c 8 off off off no off

      SPCA          CLLI          TFATCABMLQ MTPRSE ASL8
-----
                                1          no    no

RANDSLS
off

IPSG  IPGWAPC  GTTMODE          CGGTMOD
no    no      CdPA              no

      LOC  LINK  SLC  TYPE          L2T          PCR  PCR
      SET  BPS   ECM   N1   N2
1201 A    0    LIMDS0  1    56000  BASIC  ---  ---
1201 A3   1    LIMDS0  2    56000  BASIC  ---  ---
1202 A1   2    LIMDS0  3    56000  BASIC  ---  ---
1202 B    3    LIMDS0  4    56000  BASIC  ---  ---
1202 B1   4    LIMDS0  5    56000  BASIC  ---  ---
1202 A2   5    LIMDS0  6    56000  BASIC  ---  ---
1202 B2   6    LIMDS0  7    56000  BASIC  ---  ---
1202 B3   7    LIMDS0  8    56000  BASIC  ---  ---

```

Link set table is (51 of 1024) 5% full.

;

The following example shows output that includes an E1 card.

**rtrv-ls:lsn=ls1**

tekelecstp 09-08-09 00:55:45 EST EAGLE 41.1.0

```

LSN          APCA (SS7)      SCRN  L3T SLT          GWS GWS GWS
ls1          003-003-003    none  1  1  no  A   14  off off off no  off

          SPCA          CLLI          TFATCABMLQ MTPRSE ASL8
          -----
          1          no          no

RANDSLS
off

IPSG  IPGWAPC  GTTMODE          CGGTMOD
no    no      CdPA          no

          L2T          PCR  PCR
LOC  LINK  SLC  TYPE      SET  BPS  ECM  N1  N2
1101 B3   1   LIMDS0    1   56000  BASIC ---  -----

          LP          ATM
LOC  LINK  SLC  TYPE      SET  BPS  TSEL          VCI  VPI  LL
1103 A   3   LIMATM    1   1544000  EXTERNAL  5   0   0

LOC  LINK  SLC  TYPE      IPLIML2
1201 A   5   IPLIM     M2PA

          L2T          PCR  PCR  E1  E1
LOC  LINK  SLC  TYPE      SET  BPS  ECM  N1  N2  LOC  PORT  TS
1205 A1   7   LIME1    1   56000  BASIC ---  -----  1205 1   2
    
```

Link set table is (7 of 1024) 1% full.

;

The following example includes an IPLIMx to 8 Points card.

**rtrv-ls:lsn=ls1**

tekelecstp 09-08-09 01:25:45 EST EAGLE 41.1.0

```

LSN          APCA (SS7)      SCRN  L3T SLT          GWS GWS GWS
ls1          003-003-003    gws1  1  1  no  A   15  on  on  on yes  off

          SPCA          CLLI          TFATCABMLQ MTPRSE ASL8
          -----
          1          no          no

RANDSLS
off

IPSG  IPGWAPC  GTTMODE          CGGTMOD
no    no      CdPA          no

          L2T          PCR  PCR
LOC  PORT  SLC  TYPE      SET  BPS  ECM  N1  N2
1101 A   0   LIMDS0    1   56000  BASIC ---  -----

          LP          ATM
LOC  PORT  SLC  TYPE      SET  BPS  TSEL          VCI  VPI  LL
1102 A   2   LIMATM    1   1544000  LINE     5   0   0
    
```

| LOC  | PORT | SLC | TYPE  | IPLIML2 |  |
|------|------|-----|-------|---------|--|
| 1201 | A    | 5   | IPLIM | M2PA    |  |

| LOC  | PORT | SLC | TYPE  | L2T | BPS   | ECM   | PCR | PCR   | E1   | E1   |    |
|------|------|-----|-------|-----|-------|-------|-----|-------|------|------|----|
|      |      |     |       | SET |       |       | N1  | N2    | LOC  | PORT | TS |
| 1205 | A    | 6   | LIME1 | 1   | 56000 | BASIC | --- | ----- | 1205 | 1    | 1  |

| LOC  | PORT | SLC | TYPE  | L2T | BPS   | ECM   | PCR | PCR   | T1   | T1   |    |
|------|------|-----|-------|-----|-------|-------|-----|-------|------|------|----|
|      |      |     |       | SET |       |       | N1  | N2    | LOC  | PORT | TS |
| 1206 | A    | 10  | LIMT1 | 1   | 56000 | BASIC | --- | ----- | 1206 | 1    | 1  |

Link set table is (7 of 1024) 1% full.

The adjacent point code (APCA/APCI/APCN) values shown in the following example include adjacent spare point codes (prefix **s-**), adjacent private point codes (prefix **p-**), and adjacent private and spare point codes (prefix **ps-**).

**rtrv-ls**

tekelecstp 08-03-05 10:12:31 EST EAGLE 38.0.0

| LSN  | APCA (SS7)    | SCRN | L3T | SLT | SET | BEI | LST | LNKS | GWS | GWS | GWS | SLSCI | NIS |
|------|---------------|------|-----|-----|-----|-----|-----|------|-----|-----|-----|-------|-----|
|      |               |      |     |     |     |     |     |      | ACT | MES | DIS |       |     |
| lsa1 | 001-001-002   | none | 1   | 1   | no  | A   | 0   | 0    | off | off | off | no    | off |
| lsa2 | p-001-002-004 | none | 1   | 1   | no  | A   | 0   | 0    | off | off | off | no    | off |
| lsa3 | p-001-002-005 | none | 1   | 1   | no  | A   | 0   | 0    | off | off | off | no    | off |

| LSN  | APCI (SS7) | SCRN | L3T | SLT | SET | BEI | LST | LNKS | GWS | GWS | GWS | SLSCI | NIS |
|------|------------|------|-----|-----|-----|-----|-----|------|-----|-----|-----|-------|-----|
|      |            |      |     |     |     |     |     |      | ACT | MES | DIS |       |     |
| lsn1 | s-1-002-3  | none | 1   | 2   | no  | A   | 1   | 1    | off | off | off | ---   | off |
| lsn2 | s-2-002-2  | none | 1   | 2   | no  | A   | 1   | 1    | off | off | off | ---   | off |
| lsn3 | s-2-100-1  | none | 1   | 2   | no  | A   | 1   | 1    | off | off | off | ---   | off |
| lsn4 | s-2-012-1  | none | 1   | 2   | no  | A   | 1   | 1    | off | off | off | ---   | off |
| lsn5 | 2-100-1    | none | 1   | 2   | no  | A   | 1   | 1    | off | off | off | ---   | off |
| lsn6 | s-3-134-1  | none | 1   | 2   | no  | A   | 1   | 1    | off | off | off | ---   | off |

| LSN        | APCN (SS7)       | SCRN | L3T | SLT | SET | BEI | LST | LNKS | GWS | GWS | GWS | SLSCI | NIS |
|------------|------------------|------|-----|-----|-----|-----|-----|------|-----|-----|-----|-------|-----|
|            |                  |      |     |     |     |     |     |      | ACT | MES | DIS |       |     |
| lsn410234  | ps-1-1-1-2047-aa | none | 1   | 2   | no  | B   | 0   | 0    | off | off | off | ---   | off |
| lsn410235  | p-1-1-1-0059-aa  | none | 1   | 2   | no  | B   | 0   | 0    | off | off | off | ---   | off |
| lsn4102356 | ps-1-1-1-0234-aa | none | 1   | 2   | no  | B   | 0   | 0    | off | off | off | ---   | off |

Link set table is (12 of 1024) 1% full.

The following example displays linksets using a specified adjacent point code. The MLS feature must be turned on before information can be retrieved for an adjacent point code.

**rtrv-ls:apc=1-1-2**

tekelecstp 07-07-26 12:49:06 EST EAGLE 37.5.0

APCA = 001-001-002

| LSN    | SPCA        | SCRN | L3T | SLT | SET | BEI | LST | LNKS | GWS | GWS | GWS | SLSCI | NIS |
|--------|-------------|------|-----|-----|-----|-----|-----|------|-----|-----|-----|-------|-----|
|        |             |      |     |     |     |     |     |      | ACT | MES | DIS |       |     |
| lsa1   | 002-002-002 | none | 1   | 1   | no  | A   | 0   | 0    | off | off | off | no    | off |
| rtp4   | 001-002-005 | none | 1   | 1   | no  | A   | 0   | 0    | off | off | off | no    | off |
| durl6  | 002-007-042 | none | 1   | 1   | no  | A   | 0   | 0    | off | off | off | no    | off |
| morv12 | 012-009-005 | none | 1   | 1   | no  | A   | 0   | 0    | off | off | off | no    | off |
| lsa22  | 004-002-022 | none | 1   | 1   | no  | A   | 0   | 0    | off | off | off | no    | off |

Link set table is (12 of 1024) 1% full.

The following example displays all linksets when the MLS feature is turned on. The MLS features allows multiple linksets to have the same adjacent point code.

**rtrv-ls**

| LSN    | APCA (SS7)    | SCRN | L3T SLT |     | BEI | LST | LNKS | GWS GWS GWS |     |     | SLSCI | NIS |
|--------|---------------|------|---------|-----|-----|-----|------|-------------|-----|-----|-------|-----|
|        |               |      | SET     | SET |     |     |      | ACT         | MES | DIS |       |     |
| lsa1   | 001-001-002   | none | 1       | 1   | no  | A   | 0    | off         | off | off | no    | off |
| lsa2   | p-001-002-004 | none | 1       | 1   | no  | A   | 0    | off         | off | off | no    | off |
| lsa3   | p-001-002-005 | none | 1       | 1   | no  | A   | 0    | off         | off | off | no    | off |
| rtp4   | 001-001-002   | none | 1       | 1   | no  | A   | 0    | off         | off | off | no    | off |
| dur16  | 001-001-002   | none | 1       | 1   | no  | A   | 0    | off         | off | off | no    | off |
| morv12 | 001-001-002   | none | 1       | 1   | no  | A   | 0    | off         | off | off | no    | off |
| lsa22  | 001-001-002   | none | 1       | 1   | no  | A   | 0    | off         | off | off | no    | off |

| LSN  | APCI (SS7) | SCRN | L3T SLT |     | BEI | LST | LNKS | GWS GWS GWS |     |     | SLSCI | NIS |
|------|------------|------|---------|-----|-----|-----|------|-------------|-----|-----|-------|-----|
|      |            |      | SET     | SET |     |     |      | ACT         | MES | DIS |       |     |
| lsn1 | s-1-002-3  | none | 1       | 2   | no  | A   | 1    | off         | off | off | ---   | off |
| lsn2 | 2-100-1    | none | 1       | 2   | no  | A   | 1    | off         | off | off | ---   | off |
| lsn3 | s-3-134-1  | none | 1       | 2   | no  | A   | 1    | off         | off | off | ---   | off |

| LSN       | APCN (SS7)       | SCRN | L3T SLT |     | BEI | LST | LNKS | GWS GWS GWS |     |     | SLSCI | NIS |
|-----------|------------------|------|---------|-----|-----|-----|------|-------------|-----|-----|-------|-----|
|           |                  |      | SET     | SET |     |     |      | ACT         | MES | DIS |       |     |
| lsn410234 | ps-1-1-1-2047-aa | none | 1       | 2   | no  | B   | 0    | off         | off | off | ---   | off |
| lsn410235 | p-1-1-1-0059-aa  | none | 1       | 2   | no  | B   | 0    | off         | off | off | ---   | off |

Link set table is (12 of 1024) 1% full.

The following example displays all linksets when the Proxy Point Code feature is enabled. Proxy point codes used by the linksets are displayed.

**rtrv-ls**

homenetwork 08-03-19 17:03:37 EST EAGLE 38.0.0

| LSN | APCA (SS7)  | SCRN | L3T SLT |     | BEI | LST | LNKS | GWS GWS GWS |     |     | SLSCI | NIS |
|-----|-------------|------|---------|-----|-----|-----|------|-------------|-----|-----|-------|-----|
|     |             |      | SET     | SET |     |     |      | ACT         | MES | DIS |       |     |
| x1  | 001-001-001 | none | 1       | 1   | no  | PRX | 0    | off         | off | off | no    | off |
| x2  | 001-001-002 | none | 1       | 1   | no  | PRX | 0    | off         | off | off | no    | off |
| x3  | 001-001-003 | none | 1       | 1   | no  | PRX | 0    | off         | off | off | no    | off |
| x4  | 001-001-004 | none | 1       | 1   | no  | PRX | 0    | off         | off | off | no    | off |
| x5  | 001-001-005 | none | 1       | 1   | no  | PRX | 0    | off         | off | off | no    | off |
| x6  | 001-001-006 | none | 1       | 1   | no  | PRX | 0    | off         | off | off | no    | off |
| x7  | 001-001-007 | none | 1       | 1   | no  | PRX | 0    | off         | off | off | no    | off |
| x8  | 001-001-008 | none | 1       | 1   | no  | PRX | 0    | off         | off | off | no    | off |
| x9  | 001-001-009 | none | 1       | 1   | no  | PRX | 0    | off         | off | off | no    | off |
| x10 | 001-001-010 | none | 1       | 1   | no  | PRX | 0    | off         | off | off | no    | off |
| y   | 002-002-002 | none | 1       | 1   | no  | A   | 0    | off         | off | off | no    | off |

Link set table is (11 of 1024) 1% full.

;

The following example displays linksets using a specified proxy point code.

**rtrv-ls:ppc=2-2-2**

homenetwork 07-05-19 17:05:04 EST EAGLE 37.5.0

PPCA = 002-002-002

| LSN | APCA (SS7)  | SCRN | L3T SLT |     | BEI | LST | LNKS | GWS GWS GWS |     |     | SLSCI | NIS |
|-----|-------------|------|---------|-----|-----|-----|------|-------------|-----|-----|-------|-----|
|     |             |      | SET     | SET |     |     |      | ACT         | MES | DIS |       |     |
| x1  | 001-001-001 | none | 1       | 1   | no  | PRX | 0    | off         | off | off | no    | off |
| x2  | 001-001-002 | none | 1       | 1   | no  | PRX | 0    | off         | off | off | no    | off |
| x3  | 001-001-003 | none | 1       | 1   | no  | PRX | 0    | off         | off | off | no    | off |
| x4  | 001-001-004 | none | 1       | 1   | no  | PRX | 0    | off         | off | off | no    | off |
| x5  | 001-001-005 | none | 1       | 1   | no  | PRX | 0    | off         | off | off | no    | off |
| x6  | 001-001-006 | none | 1       | 1   | no  | PRX | 0    | off         | off | off | no    | off |
| x7  | 001-001-007 | none | 1       | 1   | no  | PRX | 0    | off         | off | off | no    | off |

```
x8          001-001-008  none 1  1  no PRX 0   off off off no  off
x9          001-001-009  none 1  1  no PRX 0   off off off no  off
x10        001-001-010  none 1  1  no PRX 0   off off off no  off
```

Link set table is (11 of 1024) 1% full.

;

The following example displays all of the proxy linksets.

**rtrv-ls:lst=prx**

homenetwork 08-03-19 17:05:40 EST EAGLE 38.0.0

```

                L3T SLT                GWS GWS GWS
LSN          APCA  (SS7)  SCRN SET SET BEI LST LNKS ACT MES DIS SLSCI NIS
x1           001-001-001  none 1  1  no PRX 0   off off off no  off
x2           001-001-002  none 1  1  no PRX 0   off off off no  off
x3           001-001-003  none 1  1  no PRX 0   off off off no  off
x4           001-001-004  none 1  1  no PRX 0   off off off no  off
x5           001-001-005  none 1  1  no PRX 0   off off off no  off
x6           001-001-006  none 1  1  no PRX 0   off off off no  off
x7           001-001-007  none 1  1  no PRX 0   off off off no  off
x8           001-001-008  none 1  1  no PRX 0   off off off no  off
x9           001-001-009  none 1  1  no PRX 0   off off off no  off
x10          001-001-010  none 1  1  no PRX 0   off off off no  off
```

Link set table is (11 of 1024) 1% full.

;

The following example displays information for a specified linkset when the Proxy Point Code feature is enabled.

**rtrv-ls:lsn=x1**

tekelecstp 08-11-05 17:32:59 EST EAGLE 40.0.0

```

                L3T SLT                GWS GWS GWS
LSN          APCA  (SS7)  SCRN SET SET BEI LST LNKS ACT MES DIS SLSCI NIS
x1           001-001-001  none 1  1  no PRX 0   on  on  on  yes  off

                PPCA                CLLI                TFATCABMLQ MTPRSE ASL8
                002-002-002  ----- 7                ---  no

RANDSLS
off

IPGWAPC MATELSN  IPTPS  LSUSEALM SLKUSEALM GTTMODE
no      -----  ---  ---  ---  ---  CdPA
```

Link set table is (11 of 1024) 1% full.

;

The following example displays proxy linksets using a specified adjacent point code when the MLS feature is turned on and the Proxy Point Code feature is enabled.

**rtrv-ls:apc=1-1-1**

tekelecstp 07-03-05 17:32:59 EST EAGLE 37.5.0

APCA = 001-001-001

```

                L3T SLT                GWS GWS GWS
LSN          PPCA                SCRN SET SET BEI LST LNKS ACT MES DIS SLSCI NIS
x1           002-002-002  none 1  1  no PRX 0   off off off no  off
```

Link set table is (11 of 1024) 1% full.



;

The following example displays linksets using a specified secondary point code when the MLS feature is turned on.

**rtrv-ls:spc=2-2-2**

homenetwork 07-05-19 17:05:04 EST EAGLE 37.5.0

SPCA = 002-002-002

| LSN  | APCA (SS7)    | SCRN | L3T SLT |     | BEI | LST | LNKS | GWS GWS GWS |     |     | SLSCI | NIS |
|------|---------------|------|---------|-----|-----|-----|------|-------------|-----|-----|-------|-----|
|      |               |      | SET     | SET |     |     |      | ACT         | MES | DIS |       |     |
| lsa1 | 001-001-002   | none | 1       | 1   | no  | A   | 0    | off         | off | off | no    | off |
| lsa2 | p-001-002-004 | none | 1       | 1   | no  | A   | 0    | off         | off | off | no    | off |

Link set table is (12 of 1024) 1% full.

;

The following example displays information for a specific linkset when the MLS feature is turned on.

**rtrv-ls:lsn=lsa1**

tekelecstp 09-08-09 01:45:48 EST EAGLE 41.1.0

| LSN  | APCA (SS7)  | SCRN  | L3T SLT |     | BEI        | LST    | LNKS | GWS GWS GWS |     |     | SLSCI | NIS |
|------|-------------|-------|---------|-----|------------|--------|------|-------------|-----|-----|-------|-----|
|      |             |       | SET     | SET |            |        |      | ACT         | MES | DIS |       |     |
| lsa1 | 001-001-002 | gws1  | 1       | 1   | no         | A      | 4    | on          | on  | on  | yes   | off |
|      | SPCA        | CLLI  |         |     | TFATCABMLQ | MTPRSE | ASL8 |             |     |     |       |     |
|      | 002-002-002 | ----- |         |     | 2          | ---    | no   |             |     |     |       |     |

RANDSLS  
off

| IPSG | IPGWAPC | GTTMODE | CGGTMOD |
|------|---------|---------|---------|
| no   | no      | CdPA    | no      |

| LOC  | LINK | SLC | TYPE   | L2T |       | ECM   | PCR  |       |
|------|------|-----|--------|-----|-------|-------|------|-------|
|      |      |     |        | SET | BPS   |       | N1   | N2    |
| 1101 | A    | 0   | LIMDS0 | 1   | 56000 | BASIC | ---- | ----- |

| LOC  | LINK | SLC | TYPE   | LP | BPS     | TSEL     | ATM | VCI | VPI | LL |
|------|------|-----|--------|----|---------|----------|-----|-----|-----|----|
|      |      |     |        |    |         |          |     |     |     |    |
| 1102 | A    | 2   | LIMATM | 1  | 1544000 | EXTERNAL |     | 5   | 0   | 0  |

| LOC  | LINK | SLC | TYPE  | IPLIML2 |      |
|------|------|-----|-------|---------|------|
|      |      |     |       | SET     | M2PA |
| 1201 | A    | 5   | IPLIM |         |      |

| LOC  | LINK | SLC | TYPE  | L2T |       | ECM   | PCR  |       | E1   | E1 |     |
|------|------|-----|-------|-----|-------|-------|------|-------|------|----|-----|
|      |      |     |       | SET | BPS   |       | N1   | N2    |      |    | LOC |
| 1205 | A    | 6   | LIME1 | 1   | 56000 | BASIC | ---- | ----- | 1205 | 1  | 1   |

| LOC  | LINK | SLC | TYPE  | L2T |       | ECM   | PCR |       | T1   | T1 |     |
|------|------|-----|-------|-----|-------|-------|-----|-------|------|----|-----|
|      |      |     |       | SET | BPS   |       | N1  | N2    |      |    | LOC |
| 1206 | A    | 10  | LIMT1 | 1   | 56000 | BASIC | --- | ----- | 1206 | 1  | 1   |

Link set table is (1 of 1024) 1% full.

;

The following example displays output for a specified linkset when calling party GT modification is requested.

**rtrv-ls:lsn=ls3**

```
tekelecstp 09-07-09 01:55:38 EST EAGLE 41.1.0

LSN          APCA (SS7)  SCRN SET SET BEI LST LNKS ACT MES DIS SLSCI NIS
ls3          002-002-003 none 1 1 no A 0 off off off no off

          SPCA          CLLI          TFATCABMLQ MTPRSE ASL8 GSMSCRN
          -----          -----          1          ---          no          off

RANDSLS
off

IPSG IPGWAPC GTTMODE          CGGTMOD
no   no     AdvCdPA,CdPA,CgPA  yes
```

Link set table is (1 of 1024) 1% full.

The following example displays all of the linksets where calling party global title modification is requested.

**rtrv-ls:cggmod=yes**

```
tekelecstp 08-02-27 11:56:50 EST EAGLE 38.0.0

LSN          APCA (SS7)  SCRN SET SET BEI LST LNKS ACT MES DIS SLSCI NIS
abc14368     330-020-000 SEAS 1 1 yes a 2 off off off no off
abc34589     330-030-000 scr1 1 2 no c 3 on on on yes

LSN          APCA (SS7)  SCRN SET SET BEI LST LNKS ACT MES DIS SLSCI NIS
abc32261     330-044-000 scr1 1 1 yes a 1 off off off --- off

LSN          APCA (SS7)  SCRN SET SET BEI LST LNKS ACT MES DIS SLSCI NIS
LSN          APCA (SS7)  SCRN SET SET BEI LST LNKS ACT MES DIS SLSCI NIS
```

Link set table is (114 of 1024) 12% full

The following example displays output for an IPSG-M2PA linkset.

**rtrv-ls:lsn=m2pa12132**

```
e1001501 08-11-13 16:20:43 EST EAGLE 40.0.0

LSN          APCA (SS7)  SCRN SET SET BEI LST LNKS ACT MES DIS SLSCI NIS
m2pa12132   001-213-002 none 1 1 no A 1 off off off no off

          SPCA          CLLI          TFATCABMLQ MTPRSE ASL8
          -----          -----          1          no          no

RANDSLS
off

IPSG IPGWAPC GTTMODE          CGGTMOD
yes  no     CdPA          no

ADAPTER  SLKTPS  LSUSEALM  SLKUSEALM  RCONTEXT  ASNOTIF
m2pa    1000   100%     80%       none      no
```

```

LOC LINK SLC TYPE ANAME
1303 A 0 IPSG m2pa1303a
    
```

Link set table is (20 of 1024) 2% full.

;

The following example displays the output for an IPSG-M3UA linkset. If value of the **numslk** threshold parameter is provisioned to **0**, and the value is recalculated as per the provisioned links within the linkset, then an indication marker “\*” is printed as a superscript to the value of the corresponding parameter.

**rtrv-ls:lsn=ipsgm3ua**

e1001501 08-11-13 16:20:42 EST EAGLE 40.0.0

```

          L3T SLT          GWS GWS GWS
LSN      APCA  (SS7)  SCRN SET SET BEI LST LNKS ACT MES DIS SLSCI NIS
ipsgm3ua 008-008-004 none 1 1 no A 3 off off off no off

          SPCA          CLLI          TFATCABMLQ MTPRSE ASL8
-----
RANDSLS
off

IPSG IPGWAPC GTTMODE          CGGTMOD
yes no CdPA no

ADAPTER SLKTPS LSUSEALM SLKUSEALM RCONTEXT ASNOTIF
m3ua 100 100% 80% 1234567890 yes

NUMSLKALW NUMSLKRSTR NUMSLKPROH
2* 1 1

LOC LINK SLC TYPE ANAME
1102 A2 0 IPSG ipsgm3ua1102
1202 A3 1 IPSG ipsgm3ua1202
1302 A4 2 IPSG ipsgm3ua1302
    
```

Link set table is (1 of 1024) 1% full.

;

The following example displays linkset information when the ITU National and International Spare Point Code Support feature is enabled.

**rtrv-ls:lsn=lsnp1**

tekelecstp 09-07-09 04:52:38 EST EAGLE 41.1.0

```

          L3T SLT          GWS GWS GWS
LSN      APCI  (SS7)  SCRN SET SET BEI LST LNKS ACT MES DIS SLSCI NIS
lsnp1    1-002-1 none 1 2 no A 3 off off off no off

          SPCI          CLLI          TFATCABMLQ MTPRSE ASL8
-----
SLSRSB RANDSLS ITUTFR ICNIMAP          OGNIMAP
1 off off itui2ituis ituis2itui

IPSG IPGWAPC GTTMODE          CGGTMOD
no no CdPA no

          LP          ATM          E1ATM
LOC LINK SLC TYPE SET BPS TSEL VCI VPI CRC4 SI SN
    
```

```

1104 A    0  LIME1ATM 21  2.048M LINE    5    0  ON   3  0
1105 A    1  LIME1ATM 21  2.048M LINE    5    0  ON   3  0
1106 A    2  LIME1ATM 21  2.048M LINE    5    0  ON   3  0
    
```

Link set table is (1 of 1024) 1% full.

;

The following example displays output for an IPGWx linkset. It shows IPGWAPC information for a specific ANSI linkset.

**rtrv-ls:lsn=ls1315a**

eagle10212 08-11-06 17:00:42 EST EAGLE 40.0.0

```

                L3T SLT                GWS GWS GWS
LSN            APCA  (SS7)  SCRN SET SET BEI LST LNKS ACT MES DIS SLSCI NIS
ls1315a        000-015-000  none 1  1  no  A  1  off off off no  off

                SPCA            CLLI            TFATCABMLQ MTPRSE ASL8
-----
                1                no            no

RANDSLS
off

IPSG  IPGWAPC  GTTMODE            CGGTMOD
no    yes     CdPA                no

MATELSN  IPTPS  LSUSEALM  SLKUSEALM
-----  4000   100%      80%

LOC  LINK  SLC  TYPE
1315 A    0  SS7IPGW
    
```

Link set table is (18 of 1024) 2% full.

;

The following example displays linkset information for an ANSI linkset when the Incoming SLS Bit Rotation feature is enabled.

**rtrv-ls:lsn=ls6**

rlghncxa03w 09-04-27 11:43:04 GMT EAGLE 41.0.0

```

                L3T SLT                GWS GWS GWS
LSN            APCA  (SS7)  SCRN SET SET BEI LST LNKS ACT MES DIS SLSCI NIS
ls06           002-007-008  scr4 1  4  no  a  0  on  off off no  on

                SPCA            CLLI            TFATCABMLQ MTPRSE ASL8
-----
                ls06clli        1                no            no

RANDSLS
off

ISLSRSB RSL8
1        no

IPSG  IPGWAPC  GTTMODE            CGGTMOD
no    no     CdPA                no
    
```

Link set table is ( 20 of 1024) 2% full

;

The following example displays linkset information for an ITU linkset when the Incoming SLS Bit Rotation feature is enabled.

**rtrv-ls:lsn=lsi111**

```
tekelecstp 08-10-08 10:46:00 EST EAGLE 40.0.0

LSN          APCI   (SS7)  SCRN SET SET BEI LST LNKS ACT MES DIS SLSCI NIS
lsi111       1-001-1  none 1  2  no  A  0  off off off no  off

          SPCI          CLLI          TFATCABMLQ MTPRSE ASL8
          -----
          1

SLSOCSBIT SLSRSB RANDSL S ITUTFR
none      1      off    off

ISLSRSB
1

IPSG IPGWAPC GTTMODE          CGGTMOD
no    no      CdPA          no
```

Link set table is (1 of 1024) 1% full.

The following example displays the output when information for linksets with a specified ISLSRB filter is requested.

**rtrv-ls:islsrsb=4**

```
tekelecstp 08-10-21 09:46:52 EST EAGLE 40.0.0

LSN          APCI   (SS7)  SCRN SET SET BEI LST LNKS ACT MES DIS SLSCI NIS
lsi616       6-001-6  none 1  2  no  B  0  off off off no  off
lsi747       7-014-7  none 1  2  no  A  0  off off off no  off
```

Link set table is (16 of 1024) 2% full.

;

Following example displays linkset information for a specific linkset when the Flexible Linkset Optional Based Routing feature is turned on.

**rtrv-ls:lsn=ls8**

```
tekelecstp 09-04-12 12:29:09 EST EAGLE 41.0.0

LSN          APCA   (SS7)  SCRN SET SET BEI LST LNKS ACT MES DIS SLSCI NIS
ls8          001-001-001  none 1  1  no  A  0  off off off no  off

          SPCA          CLLI          TFATCABMLQ MTPRSE ASL8
          -----
          1          no

RANDSL S
off

IPSG IPGWAPC GTTMODE          CGGTMOD
no    no      FLCdPA,FLCgPA          no
```

Link set table is (2 of 1024) 1% full.

;

The following example displays linkset information for an ANSI linkset when the Incoming SLS Bit Rotation feature is enabled and the **islsrsb=6** parameter is specified.

**rtrv-ls:lsn=lsa**

```
tekelecstp 09-03-24 15:05:51 EST EAGLE 41.0.0

LSN          APCA  (SS7)  SCRN SET SET  BEI LST LNKS ACT MES DIS SLSCI NIS
lsa          001-001-001  none 1  1  no  A  0   off off off no  off

          SPCA          CLLI          TFATCABMLQ MTPRSE ASL8
-----
RANDSLS
off

ISLSRSB RLS8
6       yes

IPSG  IPGWAPC  GTTMODE          CGGTMOD
no    no      CdPA          no
```

Link set table is (1 of 1024) 1% full.

The following example displays link set information for an ITU link set, when the MPC, ITUDUPPC, Spare Point Code, SLSOCB and ISLSBR features are enabled.

**rtrv-ls:lsn=lsi**

```
tekelecstp 09-03-04 11:07:38 EST EAGLE 41.0.0

LSN          APCN  (SS7)  SCRN SET SET  BEI LST LNKS ACT MES DIS SLSCI NIS
lsi          01001-aa  none 1  2  no  A  0   off off off no  off

          SPCN          CLLI          TFATCABMLQ MTPRSE ASL8
-----

SLSOCBIT SLSRSB RANDSLS MULTGC ITUTFR ICNIMAP          OGNIMAP
none     1      off     no     off     none          none

ISLSRSB
1

IPSG  IPGWAPC  GTTMODE          CGGTMOD
no    no      CdPA          no
```

Link set table is (4 of 1024) 1% full.

;

**Legend**

**LSN**—The name of the linkset. When CHINA appears after the LSN heading, each linkset that is listed under the heading was defined with the **apctype=itunchina** parameter specified.

**APC/APCI/APCN/APCN24**—The adjacent DPC of the linkset.

**SPC/SPCI/SPCN/SPCN24**—The secondary PC of the linkset.

**SCRN**—The screen set assigned to the linkset.

**L3TSET**—The level 3 timer set value assigned to the linkset.

**SLTSET**—The SLTM record associated with the linkset.

**BEI**—The broadcast exception indicator. This field indicates whether TFP (transfer prohibited) messages are allowed to be broadcast on the linkset.

**LST**—The type of links in the linkset (access links, bridge links, etc.).

**LNKS**—The number of links in the linkset.

**GWSA**—Shows whether gateway screening is used on the specified linkset.

**GWSM**—Shows whether the display of messages generated for each screened message is turned on or off.

**GWSD**—Shows whether the gateway screening message discard function is turned on or off.

**SLSCI**—Shows whether the 5-to-8-bit SLS conversion feature is to be used to select links for outgoing messages directed to the given linkset.

**NIS**—Shows whether the Network Indicator Spare option is on or off for the specified linkset.

**CLLI**—The far end Common Language Location Identifier (CLLI).

**TFATCABMLQ**—Displays the minimum number of links in the given linkset (or in the combined linkset in which it resides) that must be available to user-part messages traffic in order for the STP to consider the first-choice ordered routes using that linkset as allowed rather than restricted.

**MTPRSE**—Shows whether the adjacent node is equipped with MTP restart.

**ASL8**—Shows whether the adjacent node is sending MSUs with 8-bit SLSs.

**MULTGC**—Shows whether multiple group codes are allowed.

**IPGWAPC**—Shows whether the adjacent point code is an IP Gateway adjacent point code.

**MATELSN**—The name of the mate IP Gateway linkset.

**IPTPS**—Provisioned or default TPS for the specific IPGWx linkset. This value is a user-defined or default portion of the total enabled system IP Signaling TPS.

**LSUSEALM**—The percent of the linkset TPS (**iptps**) at which an alarm is generated to indicate that the actual linkset TPS is approaching the configured **iptps** value for the linkset.

**SLKUSEALM**—The percent of the link "fair share" TPS at which an alarm is generated to indicate that the actual link TPS is approaching the link's "fair share" of its linkset's configured TPS (**iptps**). The "fair share" of the linkset TPS for a link is the configured linkset TPS divided by the number of in-service links in the linkset.

**LOC**—The location of the card containing the signaling links that make up the linkset.

**PORT**—The port on the card containing the signaling link.

**SLSOCBIT**—The setting of the Other CIC (Circuit Identification Code) Bit.

**SLRSRB**—The setting of the Rotated SLS (Signaling Link Selection) Bit.

**ISLSRSB**—The setting of the Incoming Rotated SLS (Signaling Link Selection) Bit.

**GSMSCRN**—Shows whether the GSM MAP screening indicator is turned on or off.

**ITUTFR**—Shows whether the ITU TFR procedure indicator is turned on or off.

**L2TSET**—The level 2 timer set value associated with the signaling link.

**SLC**—The signaling link code of the signaling link.

**TYPE**—The type of card.

**BPS**—The transmission rate for the link in bits per second.

**E1PORT**—The E1 port with the E1 interface that services the link.

**E1LOC**—The card location of the E1 card with the E1 interface that services the link.

**T1PORT**—The T1 port with the T1 interface that services the link.

**T1LOC**—The card location of the T1 card with the T1 interface that services the link.

**TS**—The timeslot assigned to the link that is serviced by the E1 or T1 interface.

**E1ATMCRC4**—The indicator of whether CRC4 multi-frame structure is enabled or disabled.

**E1ATMSI**—Value of two Spare International bits of NFAS data.

**E1ATMSN**—Value of five Spare National bits of NFAS data.

**RANDSLS**—The setting of linkset for Random SLS generation.

**ADAPTER**—Shows whether the linkset is IPSP M2PA or IPSP M3UA linkset.

**RCONTEXT**—The routing context id of IPSP M3UA linkset.

**ASNOTIF**—Shows whether AS notifications will be generated for IPSP M3UA linkset.

**ANAME**—The association name configured for signaling link of IPSP linkset.

**SLKTPS**—The provisioned TPS for concerned signaling link of the specified IPSP linkset.

**CGGTMOD**—Shows whether calling party global title modification indicator is yes or no for the linkset.

**PPC/PPCI/PPCN/PPCN24**—The proxy point code of the linkset.

**NUMSLKALW**—Threshold value for IPSP M3UA linkset used to transition to Allowed state from Restricted or Prohibited state.

**NUMSLKRSTR**—Threshold value for IPSP M3UA linkset used to transition to Restricted state from Allowed state.

**NUMSLKPROH**—Threshold value for IPSP M3UA linkset used to transition to Prohibited state from Restricted or Allowed state.

**ICNIMAP**—Incoming NI Map.

**OGNIMAP**—Outgoing NI Map.

**RSLS8**—Shows whether the incoming SLS is rotated by 8 bits.

## rtrv-m2pa-tset

## Retrieve M2PA Timer Set

Use this command to retrieve either one M2PA timer set or all M2PA timer sets.

**Keyword:** rtrv-m2pa-tset

**Related Commands:** chg-m2pa-tset

**Command Class:** Database Administration

### Parameters

**:tset=** (optional)  
The name of the M2PA timer set to be retrieved.

**Range:** 1-20

**:ver=** (optional)  
The M2PA version supported by the association.

**Range:** d6, rfc

### Example

```
rtrv-m2pa-tset
rtrv-m2pa-tset:tset=1
```

### Dependencies

None

### Notes

If a timer set is not specified in the command, all timer sets are retrieved.



Output

**rtrv-m2pa-tset:tset=1:ver=d6**

rlghncxa03w 06-01-18 08:16:14 EST EAGLE 34.3.0  
M2PA Draft 6 Timers (in msec, T16 in microsec)

| TSET | T1    | T2    | T3    | T4N   | T4E | T5   | T6   | T7   | T16    | T17 | T18  |
|------|-------|-------|-------|-------|-----|------|------|------|--------|-----|------|
| 1    | 10000 | ----- | 10000 | 10000 | 500 | 1000 | 3000 | 1200 | 200000 | 250 | 1000 |

;

**rtrv-m2pa-tset:tset=1:ver=rfc**

rlghncxa03w 06-01-18 08:16:14 EST EAGLE 34.3.0  
M2PA RFC Timers (in msec, T16 in microsec)

| TSET | T1     | T2    | T3   | T4N   | T4E | T5  | T6   | T7   | T16    | T17 | T18  |
|------|--------|-------|------|-------|-----|-----|------|------|--------|-----|------|
| 1    | 300000 | 20000 | 2000 | 30000 | 500 | 100 | 3000 | 1200 | 200000 | 250 | 1000 |

;

**rtrv-m2pa-tset:tset=1**

rlghncxa03w 06-01-18 08:16:14 EST EAGLE 34.3.0  
M2PA Draft 6 Timers (in msec, T16 in microsec)

| TSET | T1    | T2    | T3    | T4N   | T4E | T5   | T6   | T7   | T16    | T17 | T18  |
|------|-------|-------|-------|-------|-----|------|------|------|--------|-----|------|
| 1    | 10000 | ----- | 10000 | 10000 | 500 | 1000 | 3000 | 1200 | 200000 | 250 | 1000 |

M2PA RFC Timers (in msec, T16 in microsec)

| TSET | T1     | T2    | T3   | T4N   | T4E | T5  | T6   | T7   | T16    | T17 | T18  |
|------|--------|-------|------|-------|-----|-----|------|------|--------|-----|------|
| 1    | 300000 | 20000 | 2000 | 30000 | 500 | 100 | 3000 | 1200 | 200000 | 250 | 1000 |

;

**rtrv-m2pa-tset:ver=d6**

rlghncxa03w 06-01-18 08:16:14 EST EAGLE 34.3.0  
M2PA Draft 6 Timers (in msec, T16 in microsec)

| TSET | T1    | T2    | T3    | T4N   | T4E | T5   | T6   | T7   | T16    | T17 | T18  |
|------|-------|-------|-------|-------|-----|------|------|------|--------|-----|------|
| 1    | 10000 | ----- | 10000 | 10000 | 500 | 1000 | 3000 | 1200 | 200000 | 250 | 1000 |
| 2    | 10000 | ----- | 10000 | 10000 | 500 | 1000 | 3000 | 1200 | 200000 | 250 | 1000 |
| 3    | 10000 | ----- | 10000 | 10000 | 500 | 1000 | 3000 | 1200 | 200000 | 250 | 1000 |
| 4    | 10000 | ----- | 10000 | 10000 | 500 | 1000 | 3000 | 1200 | 200000 | 250 | 1000 |
| 5    | 10000 | ----- | 10000 | 10000 | 500 | 1000 | 3000 | 1200 | 200000 | 250 | 1000 |
| 6    | 10000 | ----- | 10000 | 10000 | 500 | 1000 | 3000 | 1200 | 200000 | 250 | 1000 |
| 7    | 10000 | ----- | 10000 | 10000 | 500 | 1000 | 3000 | 1200 | 200000 | 250 | 1000 |
| 8    | 10000 | ----- | 10000 | 10000 | 500 | 1000 | 3000 | 1200 | 200000 | 250 | 1000 |
| 9    | 10000 | ----- | 10000 | 10000 | 500 | 1000 | 3000 | 1200 | 200000 | 250 | 1000 |
| 10   | 10000 | ----- | 10000 | 10000 | 500 | 1000 | 3000 | 1200 | 200000 | 250 | 1000 |
| 11   | 10000 | ----- | 10000 | 10000 | 500 | 1000 | 3000 | 1200 | 200000 | 250 | 1000 |
| 12   | 10000 | ----- | 10000 | 10000 | 500 | 1000 | 3000 | 1200 | 200000 | 250 | 1000 |
| 13   | 10000 | ----- | 10000 | 10000 | 500 | 1000 | 3000 | 1200 | 200000 | 250 | 1000 |
| 14   | 10000 | ----- | 10000 | 10000 | 500 | 1000 | 3000 | 1200 | 200000 | 250 | 1000 |
| 15   | 10000 | ----- | 10000 | 10000 | 500 | 1000 | 3000 | 1200 | 200000 | 250 | 1000 |
| 16   | 10000 | ----- | 10000 | 10000 | 500 | 1000 | 3000 | 1200 | 200000 | 250 | 1000 |
| 17   | 10000 | ----- | 10000 | 10000 | 500 | 1000 | 3000 | 1200 | 200000 | 250 | 1000 |
| 18   | 10000 | ----- | 10000 | 10000 | 500 | 1000 | 3000 | 1200 | 200000 | 250 | 1000 |
| 19   | 10000 | ----- | 10000 | 10000 | 500 | 1000 | 3000 | 1200 | 200000 | 250 | 1000 |
| 20   | 10000 | ----- | 10000 | 10000 | 500 | 1000 | 3000 | 1200 | 200000 | 250 | 1000 |

;

**rtrv-m2pa-tset:ver=rfc**

rlghncxa03w 06-01-18 08:16:14 EST EAGLE 34.3.0  
M2PA RFC Timers (in msec, T16 in microsec)

| TSET | T1     | T2    | T3   | T4N   | T4E | T5  | T6   | T7   | T16    | T17 | T18  |
|------|--------|-------|------|-------|-----|-----|------|------|--------|-----|------|
| 1    | 300000 | 20000 | 2000 | 30000 | 500 | 100 | 3000 | 1200 | 200000 | 250 | 1000 |
| 2    | 300000 | 20000 | 2000 | 30000 | 500 | 100 | 3000 | 1200 | 200000 | 250 | 1000 |
| 3    | 300000 | 20000 | 2000 | 30000 | 500 | 100 | 3000 | 1200 | 200000 | 250 | 1000 |
| 4    | 300000 | 20000 | 2000 | 30000 | 500 | 100 | 3000 | 1200 | 200000 | 250 | 1000 |
| 5    | 300000 | 20000 | 2000 | 30000 | 500 | 100 | 3000 | 1200 | 200000 | 250 | 1000 |
| 6    | 300000 | 20000 | 2000 | 30000 | 500 | 100 | 3000 | 1200 | 200000 | 250 | 1000 |
| 7    | 300000 | 20000 | 2000 | 30000 | 500 | 100 | 3000 | 1200 | 200000 | 250 | 1000 |
| 8    | 300000 | 20000 | 2000 | 30000 | 500 | 100 | 3000 | 1200 | 200000 | 250 | 1000 |
| 9    | 300000 | 20000 | 2000 | 30000 | 500 | 100 | 3000 | 1200 | 200000 | 250 | 1000 |
| 10   | 300000 | 20000 | 2000 | 30000 | 500 | 100 | 3000 | 1200 | 200000 | 250 | 1000 |
| 11   | 300000 | 20000 | 2000 | 30000 | 500 | 100 | 3000 | 1200 | 200000 | 250 | 1000 |
| 12   | 300000 | 20000 | 2000 | 30000 | 500 | 100 | 3000 | 1200 | 200000 | 250 | 1000 |
| 13   | 300000 | 20000 | 2000 | 30000 | 500 | 100 | 3000 | 1200 | 200000 | 250 | 1000 |
| 14   | 300000 | 20000 | 2000 | 30000 | 500 | 100 | 3000 | 1200 | 200000 | 250 | 1000 |
| 15   | 300000 | 20000 | 2000 | 30000 | 500 | 100 | 3000 | 1200 | 200000 | 250 | 1000 |
| 16   | 300000 | 20000 | 2000 | 30000 | 500 | 100 | 3000 | 1200 | 200000 | 250 | 1000 |
| 17   | 300000 | 20000 | 2000 | 30000 | 500 | 100 | 3000 | 1200 | 200000 | 250 | 1000 |
| 18   | 300000 | 20000 | 2000 | 30000 | 500 | 100 | 3000 | 1200 | 200000 | 250 | 1000 |
| 19   | 300000 | 20000 | 2000 | 30000 | 500 | 100 | 3000 | 1200 | 200000 | 250 | 1000 |
| 20   | 300000 | 20000 | 2000 | 30000 | 500 | 100 | 3000 | 1200 | 200000 | 250 | 1000 |

;

**rtrv-m2pa-tset**

rlghncxa03w 06-01-18 08:16:14 EST EAGLE 34.3.0  
M2PA Draft 6 Timers (in msec)

| TSET | T1    | T2    | T3    | T4N   | T4E | T5   | T6   | T7   | T16    | T17 | T18  |
|------|-------|-------|-------|-------|-----|------|------|------|--------|-----|------|
| 1    | 10000 | ----- | 10000 | 10000 | 500 | 1000 | 3000 | 1200 | 200000 | 250 | 1000 |
| 2    | 10000 | ----- | 10000 | 10000 | 500 | 1000 | 3000 | 1200 | 200000 | 250 | 1000 |
| 3    | 10000 | ----- | 10000 | 10000 | 500 | 1000 | 3000 | 1200 | 200000 | 250 | 1000 |
| 4    | 10000 | ----- | 10000 | 10000 | 500 | 1000 | 3000 | 1200 | 200000 | 250 | 1000 |
| 5    | 10000 | ----- | 10000 | 10000 | 500 | 1000 | 3000 | 1200 | 200000 | 250 | 1000 |
| 6    | 10000 | ----- | 10000 | 10000 | 500 | 1000 | 3000 | 1200 | 200000 | 250 | 1000 |
| 7    | 10000 | ----- | 10000 | 10000 | 500 | 1000 | 3000 | 1200 | 200000 | 250 | 1000 |
| 8    | 10000 | ----- | 10000 | 10000 | 500 | 1000 | 3000 | 1200 | 200000 | 250 | 1000 |
| 9    | 10000 | ----- | 10000 | 10000 | 500 | 1000 | 3000 | 1200 | 200000 | 250 | 1000 |
| 10   | 10000 | ----- | 10000 | 10000 | 500 | 1000 | 3000 | 1200 | 200000 | 250 | 1000 |
| 11   | 10000 | ----- | 10000 | 10000 | 500 | 1000 | 3000 | 1200 | 200000 | 250 | 1000 |
| 12   | 10000 | ----- | 10000 | 10000 | 500 | 1000 | 3000 | 1200 | 200000 | 250 | 1000 |
| 13   | 10000 | ----- | 10000 | 10000 | 500 | 1000 | 3000 | 1200 | 200000 | 250 | 1000 |
| 14   | 10000 | ----- | 10000 | 10000 | 500 | 1000 | 3000 | 1200 | 200000 | 250 | 1000 |
| 15   | 10000 | ----- | 10000 | 10000 | 500 | 1000 | 3000 | 1200 | 200000 | 250 | 1000 |
| 16   | 10000 | ----- | 10000 | 10000 | 500 | 1000 | 3000 | 1200 | 200000 | 250 | 1000 |
| 17   | 10000 | ----- | 10000 | 10000 | 500 | 1000 | 3000 | 1200 | 200000 | 250 | 1000 |
| 18   | 10000 | ----- | 10000 | 10000 | 500 | 1000 | 3000 | 1200 | 200000 | 250 | 1000 |
| 19   | 10000 | ----- | 10000 | 10000 | 500 | 1000 | 3000 | 1200 | 200000 | 250 | 1000 |
| 20   | 10000 | ----- | 10000 | 10000 | 500 | 1000 | 3000 | 1200 | 200000 | 250 | 1000 |

M2PA RFC Timers (in msec, T16 in microsec)

| TSET | T1     | T2    | T3   | T4N   | T4E | T5  | T6   | T7   | T16    | T17 | T18  |
|------|--------|-------|------|-------|-----|-----|------|------|--------|-----|------|
| 1    | 300000 | 20000 | 2000 | 30000 | 500 | 100 | 3000 | 1200 | 200000 | 250 | 1000 |
| 2    | 300000 | 20000 | 2000 | 30000 | 500 | 100 | 3000 | 1200 | 200000 | 250 | 1000 |
| 3    | 300000 | 20000 | 2000 | 30000 | 500 | 100 | 3000 | 1200 | 200000 | 250 | 1000 |
| 4    | 300000 | 20000 | 2000 | 30000 | 500 | 100 | 3000 | 1200 | 200000 | 250 | 1000 |
| 5    | 300000 | 20000 | 2000 | 30000 | 500 | 100 | 3000 | 1200 | 200000 | 250 | 1000 |
| 6    | 300000 | 20000 | 2000 | 30000 | 500 | 100 | 3000 | 1200 | 200000 | 250 | 1000 |
| 7    | 300000 | 20000 | 2000 | 30000 | 500 | 100 | 3000 | 1200 | 200000 | 250 | 1000 |
| 8    | 300000 | 20000 | 2000 | 30000 | 500 | 100 | 3000 | 1200 | 200000 | 250 | 1000 |
| 9    | 300000 | 20000 | 2000 | 30000 | 500 | 100 | 3000 | 1200 | 200000 | 250 | 1000 |
| 10   | 300000 | 20000 | 2000 | 30000 | 500 | 100 | 3000 | 1200 | 200000 | 250 | 1000 |
| 11   | 300000 | 20000 | 2000 | 30000 | 500 | 100 | 3000 | 1200 | 200000 | 250 | 1000 |
| 12   | 300000 | 20000 | 2000 | 30000 | 500 | 100 | 3000 | 1200 | 200000 | 250 | 1000 |
| 13   | 300000 | 20000 | 2000 | 30000 | 500 | 100 | 3000 | 1200 | 200000 | 250 | 1000 |

```

14 300000 20000 2000 30000 500 100 3000 1200 200000 250 1000
15 300000 20000 2000 30000 500 100 3000 1200 200000 250 1000
16 300000 20000 2000 30000 500 100 3000 1200 200000 250 1000
17 300000 20000 2000 30000 500 100 3000 1200 200000 250 1000
18 300000 20000 2000 30000 500 100 3000 1200 200000 250 1000
19 300000 20000 2000 30000 500 100 3000 1200 200000 250 1000
20 300000 20000 2000 30000 500 100 3000 1200 200000 250 1000

```

;

**rtrv-map****Retrieve Mate Applications**

Use this command to show the mated application relationship information and Alternate RI Mate information maintained by the system. The GTT Load Sharing with Alternate Routing Indicator (GTT LS ARI) feature must be enabled to view Alternate RI Mate information. This information is used to support the routing of SCCP management SSP/SSA messages.

**Keyword:** rtrv-map

**Related Commands:** chg-map, dlt-map, ent-map

**Command Class:** Database Administration

**Parameters**

**NOTE:** See "Point Code Formats and Conversion" for a detailed description of point code formats, rules for specification, and examples.

**:mapset=** (optional)

The MAP set ID.

**Range:** 1-36000 dflt  
dflt—Default MAP set

**Default:** dflt - The default value of the **mapset** parameter is **dflt** only when the Flexible GTT Load Sharing feature is not enabled.

**:pc=** (optional)

ANSI point code in the form of *network indicator-network cluster-network cluster member (ni-nc-ncm)*.

**Synonym:** pca

**Range:** 000-255

Specify a valid value for each subfield of the point code, and separate the subfields with a dash (-).

When **chg-sid:pctype=ansi** is specified, *ni* = 000 is not valid.

When **chg-sid:pctype=ansi** is specified, *nc* = 000 is not valid if *ni* = 001-005.

When **chg-sid:pctype=ansi** is specified, *nc* = 000 is valid if *ni* = 006-255.

The point code 000-000-000 is not a valid point code.

**:pc/pca/pci/pcn/pcn24=** (optional)

Point code.

**:pci=** (optional)

ITU international point code in the form of *zone-area-id*.

**Range:** s-, 0-255

Specify a valid value for each subfield of the point code, and separate the subfields with a dash (-).

*prefix*—s-

*zone*—0-7

*area*—000-255

*id*—0-7

The point code **0-000-0** is not a valid point code.

**:pcn=** (optional)

ITU national point code in the format of a 5-digit number (*nnnnn*); or 2, 3, or 4 numbers (members) separated by dashes (*m1-m2-m3-m4*) as defined by the **chg-stpopts:npcfmti** flexible point code option. A group code must be specified when the ITUDUPPC feature is turned on (*nnnnn-gc*, *m1-m2-m3-m4-gc*). The *prefix* subfield indicates a spare point code (*prefix-nnnnn*, *prefix-nnnnn-gc*, *prefix-m1-m2-m3-m4*, *prefix-m1-m2-m3-m4-gc*).

**Range:** **s-, 0-16383, aa-zz**

Specify a valid value for each subfield of the point code, and separate the subfields with a dash (-).

*prefix*—s-

*nnnnn*—0-16383

*gc*—aa-zz

*m1-m2-m3-m4*—0-14 for each member; values must sum to 14

**:pcn24=** (optional)

24-bit ITU national point code in the form of *main signaling area-sub signaling area-signaling point*.

**Range:** **000-255**

Specify a valid value for each subfield of the point code, and separate the subfields with a dash (-).

*msa*—000-255

*ssa*—000-255

*sp*—000-255

**:ssn=** (optional)

Subsystem number

**Range:** **2-255**

**Default:** All subsystem numbers and their mates are shown for the given point code.

### Example

```
rtrv-map
rtrv-map:pc=2-2-2
rtrv-map:pca=1-1-4
rtrv-map:pca=1-1-4:ssn=15
rtrv-map:mapset=2
rtrv-map:mapset=df1t:pcn=s-10155-ab
rtrv-map:pci=1-110-0
rtrv-map:pcn=6-7-1
rtrv-map:pcn24=0-1-2
```

### Dependencies

The value of the **pc/pca/pci/pcn/pcn24** parameter must already exist in the MAP entity set. All subsystem numbers for the specified PC and mate are displayed.

The remote PC must be specified as a full PC.

Asterisk entries are not allowed.

If an SSN is specified, the PC/SSN pair must exist in the MAP table. The PC/SSN entry and its mate are shown.

The DPC of the primary subsystem must be a full PC.

If the SSN is specified, then the remote PC must be specified.

The Flexible GTT Load Sharing feature must be enabled before the **mapset** parameter can be specified.

The specified MAP set must exist in the database.

If the PC and MAP set are specified, and the SSN is not specified, then at least one entry for that PC/MAP set must exist in the MAP table.

If the PC, SSN, and MAP set are specified, then they must already be provisioned in the MAP table.

## Notes

This command can be canceled using the **F9** function key or the **canc-cmd** command. See the **canc-cmd** command for more information.

In this command, only ITU-international and ITU national point codes support the spare point code subtype prefix (**s-**).

If the Flexible GTT Load Sharing feature is enabled, then the retrieved MAP examples contain the MAPSET ID for each MAP set. MAP sets that were configured before the Flexible GTT Load Sharing feature was enabled are shown as MAPSET ID=DFLT after the Flexible GTT Load Sharing feature is enabled.

The **pc/pca/pci/pcn/pcn24**, **ssn**, and **mapset** parameters can be used to screen the output of all MAP sets. These parameters allow retrieval of only those MAP sets that contain the desired parameters. A MAP set can contain one primary entry and up to 31 mated entries.

If no parameters are entered, all defined mated point codes (up to 36,000) are shown.

If the Flexible Final GTT Loadsharing feature is not enabled, then the number of entries in the MAP table is based on unique point codes. Point codes that are duplicated in MRN sets using different SSNs are counted only once in the number of entries.

If the Flexible Final GTT Loadsharing feature is enabled, then the number of entries in the MAP table is based on unique point code and SSN combinations. Point codes that are duplicated in MRN sets are counted in the number of entries).

When the GTT LS ARI feature is enabled, the Alternate RI Mate, identified by the MRNSET and MRNPC fields, is displayed for all MAP Sets. When the GTT LS ARI feature is not enabled, the Alternate RI Mate is not displayed, and the display is unchanged.

**Output**

All subsystem numbers for the specified point code and its mates are shown.

The NET column is shown only when a MAP set contains mixed network point code types. Addition of the NET column realigns all remaining columns in the output. The re-alignment is constant even if the NET column is not shown.

If an MRC value is preceded with an "\*", then the MRC value is not applicable for the current multiplicity mode (MULT field). The MRC value is only valid when MULT is *DOM*.

If an SRM value is preceded with an "\*", then the SRM value is not applicable for the current multiplicity mode (MULT field). The SRM value is only valid when MULT is *DOM* or *COM*.

The following example retrieves an ANSI MAP set for a specified point code.

**rtrv-map:pc=2-2-2**

```
flexgttoff 09-08-09 12:05:28 EST EAGLE 41.1.0
PCA           Mate PCA           SSN RC MULT SRM MRC GRP NAME SSO
002-002-002           10 10 SHR *Y *Y ----- OFF
                   002-002-003   20 10 SHR *Y *Y ----- OFF
```

MAP table is (8 of 1024) 1% full.

The following example includes MAP sets with a Concerned Signaling Point Code group name and spare point codes, (prefix *s-*). The ITUDUPPC (ITU National Duplicate Point Code) feature is on, and the Flexible ITU National Point Code STP option is set to **4-4-3-3**.

**rtrv-map**

```
spareduppc 09-08-09 12:05:28 EST EAGLE 41.1.0
PCA           Mate PCA           SSN RC MULT SRM MRC GRP NAME SSO
002-002-002           10 10 SHR *Y *Y ----- OFF
                   002-002-003   20 10 SHR *Y *Y ----- OFF

PCA           Mate PCA           SSN RC MULT SRM MRC GRP NAME SSO
003-101-001           10 30 DOM YES YES abcdefg OFF
                   003-001-000   10 40 DOM YES YES abcdefg OFF

PCI           NET Mate PC           SSN RC MULT SRM MRC GRP NAME SSO
1-109-0           I   1-110-0           90 20 COM NO *N ----- OFF
                   N   00-01-7-3-aa       90 20 COM NO *N ----- OFF
                   N   01-03-2-2-aa       90 30 COM NO *N ----- OFF

PCN           Mate PCN           SSN RC MULT SRM MRC GRP NAME SSO
03-00-1-2-aa           55 10 DOM NO NO ----- OFF
                   s-09-14-5-3-ab       45 99 DOM NO NO ----- OFF

PCN           Mate PCN           SSN RC MULT SRM MRC GRP NAME SSO
12-00-7-1-aa           5 10 DOM NO NO ----- OFF
                   12-00-7-3-aa       5 20 DOM NO NO ----- OFF

PCI           Mate PCI           SSN RC MULT SRM MRC GRP NAME SSO
s-1-128-6           55 10 SOL *N *N ----- OFF
```

MAP table is (13 of 1024) 1% full.

The following example includes an Flexible ITU National Point Code STP option of 3-8-3-0.

**rtrv-map**

```
spareduppc 09-08-09 12:05:28 EST EAGLE 41.1.0
PCA           Mate PCA           SSN RC MULT SRM MRC GRP NAME SSO
001-001-001           10 25 SHR *Y *Y ----- OFF
```

|             |     |              |             |        |              |           |       |     |
|-------------|-----|--------------|-------------|--------|--------------|-----------|-------|-----|
|             |     |              | 001-001-004 |        | 20 25        | SHR *Y *Y | ----- | OFF |
| PCA         |     | Mate PCA     |             | SSN RC | MULT SRM MRC | GRP NAME  | SSO   |     |
| 001-001-002 |     |              |             | 55 5   | DOM YES YES  | -----     | OFF   |     |
|             |     |              | 001-001-002 | 15 15  | DOM YES YES  | -----     | ON    |     |
|             |     |              | 001-001-003 | 25 20  | DOM YES YES  | -----     | ON    |     |
|             |     |              | 001-001-002 | 40 35  | DOM YES YES  | -----     | OFF   |     |
| PCA         |     | Mate PCA     |             | SSN RC | MULT SRM MRC | GRP NAME  | SSO   |     |
| 001-001-003 |     |              |             | 30 10  | COM NO *N    | -----     | OFF   |     |
|             |     |              | 001-010-010 | 30 30  | COM NO *N    | -----     | OFF   |     |
|             |     |              | 001-001-004 | 15 30  | COM YES *Y   | -----     | OFF   |     |
| PCA         |     | Mate PCA     |             | SSN RC | MULT SRM MRC | GRP NAME  | SSO   |     |
| 001-001-004 |     |              |             | 5 25   | SHR *Y *Y    | -----     | OFF   |     |
|             |     |              | 001-001-001 | 50 25  | SHR *Y *Y    | -----     | OFF   |     |
| PCA         |     | Mate PCA     |             | SSN RC | MULT SRM MRC | GRP NAME  | SSO   |     |
| 001-001-004 |     |              |             | 25 10  | DOM YES YES  | -----     | OFF   |     |
|             |     |              | 001-001-004 | 10 15  | DOM YES YES  | -----     | OFF   |     |
| PCA         |     | Mate PCA     |             | SSN RC | MULT SRM MRC | GRP NAME  | SSO   |     |
| 001-102-001 |     |              |             | 110 5  | SHR *Y *Y    | -----     | OFF   |     |
|             |     |              | 002-001-000 | 110 5  | SHR *Y *Y    | -----     | OFF   |     |
|             |     |              | 003-001-000 | 110 5  | SHR *Y *Y    | -----     | OFF   |     |
| PCA         |     | Mate PCA     |             | SSN RC | MULT SRM MRC | GRP NAME  | SSO   |     |
| 002-001-000 |     |              |             | 10 20  | SOL *Y *Y    | -----     | OFF   |     |
| PCA         |     | Mate PCA     |             | SSN RC | MULT SRM MRC | GRP NAME  | SSO   |     |
| 002-002-002 |     |              |             | 10 10  | SHR *Y *Y    | -----     | OFF   |     |
|             |     |              | 002-002-003 | 20 10  | SHR *Y *Y    | -----     | OFF   |     |
| PCA         |     | Mate PCA     |             | SSN RC | MULT SRM MRC | GRP NAME  | SSO   |     |
| 003-101-001 |     |              |             | 10 30  | DOM YES YES  | abcdefg   | OFF   |     |
|             |     |              | 003-001-000 | 10 40  | DOM YES YES  | abcdefg   | OFF   |     |
| PCA         |     | Mate PCA     |             | SSN RC | MULT SRM MRC | GRP NAME  | SSO   |     |
| 007-101-001 |     |              |             | 254 10 | SOL *Y *Y    | -----     | OFF   |     |
| PCA         |     | Mate PCA     |             | SSN RC | MULT SRM MRC | GRP NAME  | SSO   |     |
| 007-101-001 |     |              |             | 255 10 | COM YES *Y   | -----     | OFF   |     |
|             |     |              | 007-001-000 | 251 10 | COM YES *Y   | -----     | OFF   |     |
|             |     |              | 007-001-000 | 249 10 | COM YES *Y   | -----     | OFF   |     |
|             |     |              | 007-001-000 | 253 15 | COM YES *Y   | -----     | OFF   |     |
| PCI         |     | Mate PCI     |             | SSN RC | MULT SRM MRC | GRP NAME  | SSO   |     |
| 1-101-0     |     |              |             | 10 10  | SHR *N *N    | -----     | OFF   |     |
|             |     |              | 1-102-0     | 10 10  | SHR *N *N    | -----     | OFF   |     |
|             |     |              | 1-103-0     | 30 10  | SHR *N *N    | -----     | OFF   |     |
|             |     |              | 1-104-0     | 40 10  | SHR *N *N    | -----     | OFF   |     |
|             |     |              | 1-105-0     | 50 10  | SHR *N *N    | -----     | OFF   |     |
|             |     |              | 1-106-0     | 60 10  | SHR *N *N    | -----     | OFF   |     |
|             |     |              | 1-107-0     | 70 10  | SHR *N *N    | -----     | OFF   |     |
|             |     |              | 1-108-0     | 80 10  | SHR *N *N    | -----     | OFF   |     |
| PCI         | NET | Mate PC      |             | SSN RC | MULT SRM MRC | GRP NAME  | SSO   |     |
| 1-109-0     |     |              |             | 90 10  | COM NO *N    | -----     | OFF   |     |
|             | I   | 1-110-0      |             | 90 20  | COM NO *N    | -----     | OFF   |     |
|             | N   | 0-015-3-aa   |             | 90 20  | COM NO *N    | -----     | OFF   |     |
|             | N   | 0-154-2-aa   |             | 90 30  | COM NO *N    | -----     | OFF   |     |
| PCN         |     | Mate PCN     |             | SSN RC | MULT SRM MRC | GRP NAME  | SSO   |     |
| 1-129-2-aa  |     |              |             | 55 10  | DOM NO NO    | -----     | OFF   |     |
|             |     | s-4-245-3-ab |             | 45 99  | DOM NO NO    | -----     | OFF   |     |

```

PCN           Mate PCN      SSN RC MULT SRM MRC GRP NAME SSO
6-007-1-aa           5 10  DOM NO  NO  ----- OFF
                   6-007-3-aa  5 20  DOM NO  NO  ----- OFF

PCI           Mate PCI      SSN RC MULT SRM MRC GRP NAME SSO
s-1-128-6           55 10  SOL *N *N  ----- OFF
    
```

MAP table is (30 of 1024) 3% full.

The following example shows retrieval of all MAP sets containing a specified ANSI point code.

**rtrv-map:pca=1-1-4**

```

spareduppc 09-08-09 12:05:28 EST  EAGLE 41.1.0
PCA           Mate PCA      SSN RC MULT SRM MRC GRP NAME SSO
001-001-004           5 25  SHR *Y *Y  ----- OFF
                   001-001-001  50 25  SHR *Y *Y  ----- OFF

PCA           Mate PCA      SSN RC MULT SRM MRC GRP NAME SSO
001-001-004           10 15  DOM YES YES  ----- OFF
                   001-001-004  25 10  DOM YES YES  ----- OFF

PCA           Mate PCA      SSN RC MULT SRM MRC GRP NAME SSO
001-001-003           15 30  COM YES *Y  ----- OFF
                   001-001-004  30 10  COM NO *N  ----- OFF
                   001-010-010  30 30  COM NO *N  ----- OFF

PCA           Mate PCA      SSN RC MULT SRM MRC GRP NAME SSO
001-001-001           20 25  SHR *Y *Y  ----- OFF
                   001-001-004  10 25  SHR *Y *Y  ----- OFF

PCA           Mate PCA      SSN RC MULT SRM MRC GRP NAME SSO
001-001-004           25 10  DOM YES YES  ----- OFF
                   001-001-004  10 15  DOM YES YES  ----- OFF
    
```

MAP table is (30 of 1024) 3% full.

The following example shows retrieval of a unique ANSI point code and SSN combination.

**rtrv-map:pca=1-1-4:ssn=15**

```

spareduppc 09-08-09 12:05:28 EST  EAGLE 41.1.0
PCA           Mate PCA      SSN RC MULT SRM MRC GRP NAME SSO
001-001-003           15 30  COM YES *Y  ----- OFF
                   001-001-004  30 10  COM NO *N  ----- OFF
                   001-010-010  30 30  COM NO *N  ----- OFF
    
```

MAP table is (30 of 1024) 3% full.

The following example shows output when the Flexible Final GTT Loadsharing feature is enabled.

**rtrv-map:mapset=2**

```

flexgtton 08-12-09 12:05:28 EST  EAGLE 40.1.0

MAPSET ID=2
PCA           Mate PCA      SSN RC MULT SRM MRC GRP NAME SSO
001-001-002           50  5  DOM YES YES  ----- OFF
                   001-001-002  10 15  DOM YES YES  ----- ON
                   001-001-003  20 20  DOM YES YES  ----- ON
                   001-001-002  40 35  DOM YES YES  ----- OFF
    
```

MAP table is (49 of 36000) 1% full.

**rtrv-map:mapset=dflt:pcn=s-10155-ab**

```

flexgtton 08-12-10 12:01:04 EST  EAGLE 40.1.0

MAPSET ID=DFLT
    
```



```

PCN           Mate PCN      SSN RC MULT SRM MRC GRP NAME SSO
03082-aa          s-10155-ab      55 10  DOM NO  NO  ----- OFF
                                     45 99  DOM NO  NO  ----- OFF
    
```

MAP table is (49 of 36000) 1% full.

The following example shows output when the Weighted GTT Loadsharing feature is enabled, and the Flexible Final GTT Loadsharing feature is not enabled.

**rtrv-map:pci=1-110-0**

```

wgtonflxoff 09-08-10 12:03:44 EST EAGLE 41.1.0
PCI          NET  Mate PC      SSN RC MULT SRM MRC GRP NAME SSO WT %WT THR
1-110-0          I    1-109-0      90 20  COM NO  *N  ----- OFF 10  20  60
                  N    00123        90 20  COM NO  *N  ----- OFF 20  40  60
                  N    01234        90 30  COM NO  *N  ----- OFF 30 100  60
    
```

MAP table is (14 of 1024) 1% full.

The following example shows a Flexible ITU National Point Code STP option of 3-8-3-0. The Weighted GTT Loadsharing and Flexible Final GTT Loadsharing features are enabled.

**rtrv-map:pcn=6-7-1**

```

npcfnti3830 08-12-10 12:03:44 EST EAGLE 40.1.0

MAPSET ID=DFLT
PCN           Mate PCN      SSN RC MULT SRM MRC GRP NAME SSO WT %WT THR
6-007-1          6-007-3      5 10  DOM NO  NO  ----- OFF  --  --  --
                                     5 20  DOM NO  NO  ----- OFF  --  --  --
    
```

MAP table is (19 of 36000) 1% full.

The following example shows a PCN24 point code. The Weighted GTT Loadsharing and Flexible Final GTT Loadsharing features are not enabled.

**rtrv-map**

```

wgttgflxoff 09-08-10 15:00:37 EST EAGLE 41.1.0
PCA          Mate PCA      SSN RC MULT SRM MRC GRP NAME SSO
001-001-001          001-001-002      10 10  SHR *Y  *Y  ----- ON
                                     20 10  SHR *Y  *Y  ----- OFF

PCI          Mate PCI      SSN RC MULT SRM MRC GRP NAME SSO
1-101-0          1-102-0      10 10  SHR *N  *N  ----- OFF
                                     10 10  SHR *N  *N  ----- OFF

PCN24        Mate PCN24     SSN RC MULT SRM MRC GRP NAME SSO
000-000-001          000-001-002      5 30  SHR *N  *N  ----- OFF
                                     5 30  SHR *N  *N  ----- OFF
    
```

MAP table is (6 of 1024) 1% full.

The following example shows weighted MAP sets.

**rtrv-map**

```

wgtonflxoff 09-08-08 15:00:37 EST EAGLE 41.1.0
PCA          Mate PCA      SSN RC MULT SRM MRC GRP NAME SSO WT %WT THR
001-001-001          001-001-002      10 10  SHR *Y  *Y  ----- ON 20  67  50
                                     20 10  SHR *Y  *Y  ----- OFF 10  33  50

PCI          Mate PCI      SSN RC MULT SRM MRC GRP NAME SSO WT %WT THR
1-101-0          1-102-0      10 10  SHR *N  *N  ----- OFF 10  33   1
                                     10 10  SHR *N  *N  ----- OFF 20  67   1

PCN24        Mate PCN24     SSN RC MULT SRM MRC GRP NAME SSO WT %WT THR
000-000-001          000-001-002      5 30  SHR *N  *N  ----- OFF 50  91  80
                                     5 30  SHR *N  *N  ----- OFF  5   9   80
    
```

MAP table is (6 of 1024) 1% full.

The following example shows output when the Flexible Final GTT Loadsharing feature is enabled.

**rtrv-map:pcn24=0-1-2**

wgtonflxoff 09-08-10 15:00:37 EST EAGLE 41.1.0

```

MAPSET ID=DFLT
PCN24      Mate PCN24      SSN RC MULT SRM MRC GRP NAME SSO WT %WT THR
000-000-001      5 30 SHR *N *N ----- OFF 50 91 80
                000-001-002      5 30 SHR *N *N ----- OFF 5 9 80
    
```

MAP table is (6 of 36000) 1% full.

The following example shows output when the Flexible GTT Load Sharing and GTT LS ARI features are enabled. The Weighted GTT Load Sharing feature is turned off.

**rtrv-map**

tekelecstp 09-08-22 13:36:31 EST EAGLE 41.1.0

```

MAPSET ID=DFLT MRNSET ID=---- MRNPC=-----
PCI      Mate PCI      SSN RC MULT SRM MRC GRP NAME SSO
1-101-1      11 10 SHR *N *N itugrp OFF
                1-101-2      12 10 SHR *N *N itugrp OFF

MAPSET ID=1      MRNSET ID=---- MRNPC=-----
PCN      Mate PCN      SSN RC MULT SRM MRC GRP NAME SSO
s-02001      21 10 SHR *N *N ----- OFF
                s-02002      22 10 SHR *N *N ----- OFF
    
```

MAP table is (4 of 36000) 1% full.

The following example shows output when the Flexible GTT Load Sharing and GTT LS ARI features are enabled, and ARI Mates are provisioned. The Weighted GTT Load Sharing feature is turned off.

**rtrv-map**

tekelecstp 09-08-22 13:36:31 EST EAGLE 41.1.0

```

MAPSET ID=DFLT MRNSET ID=DFLT MRNPC= 001-001-004
PCA      Mate PCA      SSN RC MULT SRM MRC GRP NAME SSO
001-001-001      11 10 SHR *Y *Y ----- OFF
                001-001-002      12 10 SHR *Y *Y ----- OFF

MAPSET ID=2      MRNSET ID=DFLT MRNPC= 001-001-003
PCA      Mate PCA      SSN RC MULT SRM MRC GRP NAME SSO
001-001-005      11 20 SHR *Y *Y ----- OFF
                001-001-006      10 20 SHR *Y *Y ----- OFF

MAPSET ID=DFLT MRNSET ID=---- MRNPC=-----
PCI      Mate PCI      SSN RC MULT SRM MRC GRP NAME SSO
1-101-1      11 10 SHR *N *N itugrp OFF
                1-101-2      12 10 SHR *N *N itugrp OFF

MAPSET ID=5      MRNSET ID=DFLT MRNPC= 1-101-3
PCI      NET Mate PC      SSN RC MULT SRM MRC GRP NAME SSO
1-101-1      11 10 SHR *N *N itugrp OFF
                I s-2-202-1      12 10 SHR *N *N ----- OFF
                N 01002      12 10 SHR *N *N ----- OFF

MAPSET ID=3      MRNSET ID=1      MRNPC= 01003
PCN      Mate PCN      SSN RC MULT SRM MRC GRP NAME SSO
01001      11 10 SHR *N *N ----- OFF
                01002      12 10 SHR *N *N ----- OFF

MAPSET ID=4      MRNSET ID=2      MRNPC= s-2-202-3
PCI      Mate PCI      SSN RC MULT SRM MRC GRP NAME SSO
    
```

```

s-2-202-1          21 10 SHR *N *N ----- OFF
                   s-2-202-2          22 10 SHR *N *N ----- OFF

MAPSET ID=1      MRNSET ID=---- MRNPC=-----
PCN              Mate PCN        SSN RC MULT SRM MRC GRP NAME SSO
s-02001          s-02002          21 10 SHR *N *N ----- OFF
                   22 10 SHR *N *N ----- OFF
    
```

MAP table is (15 of 36000) 1% full.

;

The following example shows output when data is retrieved for a specific point code. The Flexible GTT Load Sharing and GTT LS ARI features are enabled, and the Weighted GTT Load Sharing feature is turned off.

**rtrv-map:pcn=1001**

eaglestp 09-08-22 18:41:14 EST EAGLE 41.1.0

```

MAPSET ID=3      MRNSET ID=1      MRNPC= 01003
PCN              Mate PCN        SSN RC MULT SRM MRC GRP NAME SSO
01001           01002           11 10 SHR *N *N ----- OFF
                   12 10 SHR *N *N ----- OFF
    
```

MAP table is (15 of 36000) 1% full.

;

The following example shows output when data is requested for a specific point code and subsystem number. The Flexible GTT Load Sharing and GTT LS ARI features are enabled. The Weighted GTT Load Sharing feature is turned off.

**rtrv-map:pcn=1002:ssn=12**

eaglestp 09-08-12 18:41:20 EST EAGLE 41.1.0

```

MAPSET ID=3      MRNSET ID=1      MRNPC= 01003
PCN              Mate PCN        SSN RC MULT SRM MRC GRP NAME SSO
01001           01002           11 10 SHR *N *N ----- OFF
                   12 10 SHR *N *N ----- OFF

MAPSET ID=5      MRNSET ID=DFLT  MRNPC= 1-101-3
PCN              NET  Mate PC      SSN RC MULT SRM MRC GRP NAME SSO
1-101-1          I   s-2-202-1    11 10 SHR *N *N itugrp  OFF
                   N   01002      12 10 SHR *N *N ----- OFF
                   N   01002      12 10 SHR *N *N ----- OFF
    
```

MAP table is (15 of 36000) 1% full.

;

The following example shows output when the Flexible GTT Load Sharing and GTT LS ARI features are enabled, and the Weighted GTT Load Sharing feature is turned on.

**rtrv-map**

eaglestp 09-08-12 18:43:29 EST EAGLE 41.1.0

```

MAPSET ID=DFLT  MRNSET ID=DFLT  MRNPC= 001-001-004
PCA              Mate PCA        SSN RC MULT SRM MRC GRP NAME SSO WT %WT THR
001-001-001     001-001-002     11 10 SHR *Y *Y ----- OFF -- --- ---
                   12 10 SHR *Y *Y ----- OFF -- --- ---

MAPSET ID=2      MRNSET ID=DFLT  MRNPC= 001-001-003
PCA              Mate PCA        SSN RC MULT SRM MRC GRP NAME SSO WT %WT THR
001-001-005     001-001-006     11 20 SHR *Y *Y ----- OFF 20 67 50
                   10 20 SHR *Y *Y ----- OFF 10 33 50

MAPSET ID=DFLT  MRNSET ID=----  MRNPC=-----
PCI              Mate PCI        SSN RC MULT SRM MRC GRP NAME SSO WT %WT THR
    
```

```

1-101-1                11 10 SHR *N *N itugrp  OFF -- --- ---
                        1-101-2        12 10 SHR *N *N itugrp  OFF -- --- ---

MAPSET ID=5           MRNSET ID=DFLT MRNPC=  1-101-3
PCI      NET  Mate PC      SSN RC MULT SRM MRC GRP NAME SSO WT %WT THR
1-101-1                11 10 SHR *N *N itugrp  OFF 30 33 1
                        I s-2-202-1    12 10 SHR *N *N ----- OFF 30 33 1
                        N   01002      12 10 SHR *N *N ----- OFF 30 33 1

MAPSET ID=3           MRNSET ID=1      MRNPC=  01003
PCN      Mate PCN      SSN RC MULT SRM MRC GRP NAME SSO WT %WT THR
01001                11 10 SHR *N *N ----- OFF 40 67 1
                        01002      12 10 SHR *N *N ----- OFF 20 33 1

MAPSET ID=4           MRNSET ID=2      MRNPC= s-2-202-3
PCI      Mate PCI      SSN RC MULT SRM MRC GRP NAME SSO WT %WT THR
s-2-202-1            21 10 SHR *N *N ----- OFF -- --- ---
                        s-2-202-2    22 10 SHR *N *N ----- OFF -- --- ---

MAPSET ID=1           MRNSET ID=----- MRNPC=-----
PCN      Mate PCN      SSN RC MULT SRM MRC GRP NAME SSO WT %WT THR
s-02001            21 10 SHR *N *N ----- OFF -- --- ---
                        s-02002      22 10 SHR *N *N ----- OFF -- --- ---

```

MAP table is (15 of 36000) 1% full.

;

The following example shows output when information is retrieved for a specific point code. The Flexible GTT Load Sharing and GTT LS ARI features are enabled, and the Weighted GTT Load Sharing feature is turned on.

**rtrv-map:pcn=1001**

eaglestp 09-08-12 18:43:34 EST EAGLE 41.1.0

```

MAPSET ID=3           MRNSET ID=1      MRNPC=  01003
PCN      Mate PCN      SSN RC MULT SRM MRC GRP NAME SSO WT %WT THR
01001                11 10 SHR *N *N ----- OFF 40 67 1
                        01002      12 10 SHR *N *N ----- OFF 20 33 1

```

MAP table is (15 of 36000) 1% full.

;

The following example shows output when information is retrieved for a specific point code and subsystem number. The Flexible GTT Load Sharing and GTT LS ARI features are enabled, and the Weighted GTT Load Sharing feature is turned on.

**rtrv-map:pcn=1002:ssn=12**

eaglestp 09-08-12 18:43:39 EST EAGLE 41.1.0

```

MAPSET ID=3           MRNSET ID=1      MRNPC=  01003
PCN      Mate PCN      SSN RC MULT SRM MRC GRP NAME SSO WT %WT THR
01001                11 10 SHR *N *N ----- OFF 40 67 1
                        01002      12 10 SHR *N *N ----- OFF 20 33 1

MAPSET ID=5           MRNSET ID=DFLT MRNPC=  1-101-3
PCN      NET  Mate PC      SSN RC MULT SRM MRC GRP NAME SSO WT %WT THR
1-101-1                11 10 SHR *N *N itugrp  OFF 30 33 1
                        I s-2-202-1    12 10 SHR *N *N ----- OFF 30 33 1
                        N   01002      12 10 SHR *N *N ----- OFF 30 33 1

```

MAP table is (15 of 36000) 1% full.

;

**Legend**

**MAPSET ID**—This field specifies the MAP set number or DFLT when numbered MAP sets are allowed.

**PCA/PCI/PCN/PCN24**—This field identifies the point code of the SCP where the primary application resides.

**NET**—This field identifies the mate network type of the point code when an ITU MAP set contains both ITU-I and ITU-N point codes. The field can show I if the MATE PC is an ITU-I point code or N if the MATE PC is an ITU-N point code.

**MATE PC/PCA/PCI/PCN/PCN24**—This field identifies the point code of the SCP where the mate application resides.

**SSN**—This field identifies the applications subsystem number.

**RC**—This field identifies the relative cost of the point code/subsystem.

**MULT**—Multiplicity mode SOL (Solitary), DOM (Dominant), SHR (Shared), or COM (Combined - Shared and Dominant) Load sharing. See the "Notes" section in the **ent-map** command description for an explanation of multiplicity modes.

**SRM**—This field specifies whether subsystem routing messages are transmitted is on (YES), off (NO), not applicable (\*Y) but would be YES if applicable, or not applicable (\*N) but would be NO if applicable. See the "Notes" section in the rtrv-map command description for SRM non applicable Load sharing modes.

**MRC**—This field specifies whether message routing under congestion is on (YES), off (NO), not applicable (\*Y) but would be YES if applicable, or not applicable (\*N) but would be NO if applicable. See the "Notes" section in the rtrv-map command for **MRC** non applicable Load sharing modes.

**GRP NAME**—This field identifies the name of a group of point codes (the broadcast list group name) that should be notified of the subsystem status.

**SSO**—Subsystem Status Option. Indicates the subsystem status (ON=prohibited or OFF=allowed) for PC/SSN MAP entries.

**WT**—This field specifies the weight assigned to the PC.

**%WT**—This field specifies the relative percentage, according to weight, of an in-service PC within an RC group.

**THR**—This field specifies the service threshold. If the relative percentage, according to weight, of in-service PCs within an RC group falls below the in-service threshold, that RC group is considered out-of-service and traffic is routed to the next lowest RC group.

**MRNSET** —This field specifies the Alternate RI Mate MRN Set ID.

**MRNPC** —This field specifies the Alternate RI Mate point code.

**rtrv-meas-sched****Retrieve Measurements Schedule**

Use this command to retrieve the list of measurement reports currently scheduled to be dumped to the UI, and the collection settings for EOAM based measurements.

**NOTE: This command provides no information on Measurements Platform (MCP) scheduled FTP reports or on the status of MCP measurements (see rtrv-measopts).**

**NOTE: Refer to the *Maintenance Manual* for specific details on measurement reports.**

**Keyword:** rtrv-meas-sched  
**Related Commands:** chg-meas, rept-meas, rtrv-measopts  
**Command Class:** Link Maintenance

**Parameters**

This command has no parameters.

**Example**

```
rtrv-meas-sched
```

**Dependencies**

None

**Notes**

None

**Output**

Output with measurement collection on.

```
rtrv-meas-sched
rlghncxa03w 04-02-27 07:19:51 EST EAGLE 31.3.0
COLLECT          = on
GTWYLSFLTR      = both
-----
SYSTOT-STP      = on
SYSTOT-TT       = off
SYSTOT-STPLAN   = off
COMP-LNKSET     = on
COMP-LINK       = on
GTWY-STP        = on
GTWY-LNKSET     = on
MTCD-STP        = on
MTCD-LINK       = on
MTCD-STPLAN     = on
MTCD-LNKSET     = on
;

```

Output with measurement collection off. The parentheses () indicate that a setting is not in effect because collection is turned off.

```
rtrv-meas-sched
rlghncxa03w 04-02-27 07:19:51 EST EAGLE 31.3.0
COLLECT          = off
GTWYLSFLTR      = (both)
-----
SYSTOT-STP      = (off)
SYSTOT-TT       = (off)
SYSTOT-STPLAN   = (off)
COMP-LNKSET     = (off)
COMP-LINK       = (off)
GTWY-STP        = (off)
GTWY-LNKSET     = (off)
MTCD-STP        = (on)
MTCD-LINK       = (on)
MTCD-STPLAN     = (on)
MTCD-LNKSET     = (on)
;

```

**Legend**

**COLLECT**—Shows whether measurement collection is on or off.

**GTWYLSFLTR**—Shows the setting that filters the linksets included in the GTWY report. The settings are as follows:

**both**—Only gateway linksets are included in the report to the terminal and SEAS.

**stp**—Only gateway linksets are included in the report to the terminal. All defined linksets are included in the report to SEAS.

**seas**—All defined linksets are included in the report to the terminal. Only gateway linksets are included in the report to SEAS.

**none**—All defined linksets are included in the report to the terminal and SEAS.

**SYSTOT-STP**—System total–STP measurement collection is on or off.

**SYSTOT-TT**—System total–translation type measurement collection is on or off.

**SYSTOT-STPLAN**—System total–STP LAN measurement collection is on or off.

**COMP-LNKSET**—Component-linkset measurement collection is on or off.

**COMP-LINK**—Component-link measurement collection is on or off.

**GTWY-STP**—Gateway administration-STP measurement report is on or off.

**GTWY-LNKSET**—Gateway administration-LNKSET measurement report is on or off.

**MTCD-STP**—Maintenance daily-STP measurement collection is on or off.

**MTCD-LINK**—Maintenance daily-link measurement collection is on or off.

**MTCD-STPLAN**—Maintenance daily-STP LAN measurement collection is on or off.

**MTCD-LNKSET**—Maintenance daily-LNKSET measurement report is on or off.

## rtrv-measopts

## Retrieve Measurement Options

Use this command for the following functions:

- Show the enabled/disabled status of all FTP scheduled measurements reports
- Verify that the Measurements Platform has been enabled (PLATFORMENABLE setting)
- Verify that the 15 Minute Measurements collection option has been turned on (COLLECT15MIN setting)
- Verify that the CLI-based report file name option is turned on or off (CLLIBASEDNAME setting)

**Keyword:** rtrv-measopts

**Related Commands:** chg-measopts, chg-mtc-measopts, rtrv-mtc-measopts

**Command Class:** Link Maintenance

### Parameters

This command has no parameters.

### Example

```
rtrv-measopts
```

### Dependencies

The Measurements Platform feature must be on before this command can be entered.

This command cannot be entered while in upgrade mode.

### Notes

None



Output

```

rtrv-measopts
rlghncxa03w 08-02-07 00:57:31 EST EAGLE 38.0.0

PLATFORMENABLE = on
COLLECT15MIN   = off
CLLIBASEDNAME  = on
-----
SYSTOTSTP     = on
SYSTOTTT      = off
SYSTOTSTPLAN  = on
COMPLINK      = off
COMPLNKSET    = on
COMPCTPASOC   = on
COMPCTPCARD   = off
COMPUPA       = off
GTWYSTP       = on
GTWYLNKSET    = on
GTWYORIGNI    = on
GTWYORIGNINC  = on
GTWYLSORIGNI  = on
GTWYLSDESTNI  = off
GTWYLSONISMT  = off
MTCHLNP       = on
MTCHNP        = off
MTCHMAP       = off
MTCHEIR       = off
MTCNSTP       = on
MTCNLINK      = off
MTCNLNKSET    = off
MTCNSTCTPASOC = off
MTCNSTCTPCARD = on
MTCNSTDUA     = off
MTCNSTSTPLAN  = on
MTCNLNP       = on
MTCNDNP       = on
MTCNDMAP      = on
MTCNDEIR      = on
NMSTP         = on
NMLINK        = on
NMLNKSET      = on
AVLLINK       = on
AVLSTPLAN     = on
AVLDLINK      = on
;

```

**Legend**

**PLATFORMENABLE**—Indicator that measurements collection is enabled or disabled when the Measurements Platform feature is turned on. See the **chg-measopts** command.

**COLLECT15MIN**—Indicator that 15 Minute Measurements collection is enabled or disabled when the 15 Minute Measurements feature is turned on. See the **chg-measopts** command **collect15min** parameter.

**CLLIBASEDNAME**—Indicator that the CLI-based file name option is turned on or off.

**SYSTOTSTP**—System Total measurements report for the entire STP.

**SYSTOTTT**—System Total report for Translation Type measurements.

**SYSTOTSTPLAN**—System Total report STP LAN measurements.

**COMPLINK**—Component measurements report for links.

**COMPLNKSET**—Component measurements report for link sets.

**COMPSCTPASOC**—Component measurements report for SCTP associations.

**COMPSCTPCARD**—Component measurements report for SCTP cards.

**COMPUA**—Component measurements report for M3UA and SUA application server/association pairs.

**GTWYORIGNI**—Gateway Administration measurements report per originating network (large network uniquely identified by NI only).

**GTWYORIGNINC**—Gateway Administration measurements report per originating network (small network identified by NI-NC).

**GTWYLSORIGNI**—Gateway Administration measurements report per link set and originating network.

**GTWYLSDESTNI**—Gateway Administration measurements report per link set and destination network.

**GTWYLSONISMT**—Gateway Administration measurements report per link set, per originating network, per ISUP message type.

**MTCHEIR**—Maintenance Hourly (marginal) measurements report for Equipment Identity Register

**MTCHNP**—Maintenance Hourly (marginal) measurements report for INP, INP CRP, and G-Port.

**MTCHLNP**—Maintenance Hourly (marginal) measurements report for LNP.

**MTCHMAP**—Maintenance Hourly (marginal) measurements report for GSM Map Screening.

**MTCDEIR**—Maintenance Daily measurements report for Equipment Identity Register

**MTCDSTP**—Maintenance Daily measurements report for STP.

**MTCDLNK**—Maintenance Daily measurements report for links.

**MTCDLNKSET**—Maintenance Daily measurements report for linksets.

**MTCDSCTPASOC**—Maintenance Daily measurements report for SCTP associations.

**MTCDSCTPCARD**—Maintenance Daily measurements report for SCTP cards.

**MTCDDUA**—Maintenance Daily measurements report for M3UA and SUA application server/association pairs.

**MTCDDSTPLAN**—Maintenance Daily measurements report for STPLAN.

**MTCDDLNP**—Maintenance Daily measurements report for LNP.

**MTCDDNP**—Maintenance Daily measurements report for INP, INP CRP, and G-Port.

**MTCDDMAP**—Maintenance Daily measurements report for GSM Map Screening.

**NMLINK**—Network Management measurements report for links.

**NMLNKSET**—Network Management measurements report for link sets.

**NMSTP**—Network Management measurements report for the entire STP.

**AVLINK**—Hourly Availability report for links.

**AVLSTPLAN**—Hourly Availability report for STP LAN.

**AVLDLINK**—Daily Availability report for links.

**rtrv-mrn****Retrieve Mated Relay Node**

Use this command to display the Mated Relay Node application relationship information maintained by the EAGLE 5 ISS. This information is used to support the routing of SCCP management SSP/SSA messages.

If the Intermediate GTT Load-Sharing feature is on and the Flexible GTT Load-Sharing feature is enabled, then use this command to retrieve MRN set information.

If the GTT Load Sharing with Alternate Routing Indicator (GTT LS ARI) feature is enabled, then use this command to display Alternate RI Mate information.

**Keyword:** rtrv-mrn

**Related Commands:** chg-mrn, dlt-mrn, ent-mrn

**Command Class:** Database Administration

### Parameters

**NOTE:** See "Point Code Formats and Conversion" for a detailed description of point code formats, rules for specification, and examples.

**:mrnset=** (optional)

The MRN set ID.

**Range:** 1-3000 dflt

dflt—Default MRN set

**:pc=** (optional)

ANSI point code in the form of *network indicator-network cluster-network cluster member (ni-nc-ncm)*.

**Synonym:** pca

**Range:** 000-255

Specify a valid value for each subfield of the point code, and separate the subfields with a dash (-).

When **chg-sid:pctype=ansi** is specified, *ni* = 000 is not valid.

When **chg-sid:pctype=ansi** is specified, *nc* = 000 is not valid if *ni* = 001–005.

When **chg-sid:pctype=ansi** is specified, *nc* = 000 is valid if *ni* = 006–255.

The point code 000-000-000 is not a valid point code.

**:pc/pca/pci/pcn/pcn24=** (optional)

Post-GTT-translated point code.

**:pci=** (optional)

ITU international point code with subfields *zone-area-id*. The *prefix* subfield indicates a spare point code (*prefix-zone-area-id*).

**Range:** s-, 0-255

Specify a valid value for each subfield of the point code, and separate the subfields with a dash (-).

*prefix*—s-

*zone*—0-7

*area*—000-255

*id*—0-7

The point code 0-000-0 is not a valid point code.

**:pcn=** (optional)

ITU national point code in the format of a 5-digit number (*nnnnn*); or 2, 3, or 4 numbers (members) separated by dashes (*m1-m2-m3-m4*) as defined by the **chg-stpopts:npcfmti** flexible point code option. A group code must be specified when the ITUDUPPC feature is turned on (*nnnnn-gc*, *m1-m2-m3-m4-gc*). The *prefix* subfield indicates a spare point code (*prefix-nnnnn*, *prefix-nnnnn-gc*, *prefix-m1-m2-m3-m4*, *prefix-m1-m2-m3-m4-gc*).

**Range:** **s-, 0-16383, aa-zz**  
 Specify a valid value for each subfield of the point code, and separate the subfields with a dash (-).  
*prefix—s-*  
*nnnnn—0-16383*  
*gc—aa-zz*  
*m1-m2-m3-m4—0-14* for each member; values must sum to 14

**:pcn24=** (optional)

24-bit ITU national point code with subfields *main signaling area-sub signaling area-signaling point (msa-ssa-sp)*.

**Range:** **000-255**  
 Specify a valid value for each subfield of the point code, and separate the subfields with a dash (-).  
*msa—000-255*  
*ssa—000-255*  
*sp—000-255*

### Example

```
rtrv-mrn
rtrv-mrn:pc=1-1-2
rtrv-mrn:pci=s-2-2-1
rtrv-mrn:pcn=s-1-1-1-123-aa
rtrv-mrn:pci=1-55-1:mrnset=2
```

### Dependencies

A point code that is specified in the command must already exist in the MRN table.

The **mrnset** parameter can only be specified when the Flexible GTT Load-Sharing feature is enabled.

If the Flexible GTT Load Sharing feature is ON, then the PC and MRN set must be specified together.

The specified MRN set must already exist in the MRN table.

If the Flexible GTT Load Sharing feature is enabled, then the specified PC must already exist in the specified MRN set.

The Intermediate Global Title Translation Load Sharing (IGTTLS) feature must be turned on before this command can be entered.

### Notes

This command can be canceled using the **F9** function key or the **canc-cmd** command. See **canc-cmd** for more information.

In this command, only ITU-international and ITU national point codes support the spare point code subtype prefix (**s-**).

If any entries are provisioned in the SCCP-SERV table, then the maximum number of entries shown for the MRN table are reduced by that amount.

When the GTT LS ARI feature is enabled, the Alternate RI Mate, identified by the MAPSET, MAPPCC, and MAPSSN fields, is displayed for all MRN Sets. When the GTT LS ARI feature is not enabled, the Alternate RI Mate is not displayed, and the display is unchanged.

**Output**

The NET column is shown only when an MRN set contains mixed network point code types. Addition of the NET column realigns all remaining columns in the output. The re-alignment is constant even if the NET column is not shown.

**rtrv-mrn**

spareduppc 08-12-13 11:35:12 EST EAGLE 40.1.0

| PC          | RC |
|-------------|----|
| 001-001-000 | 5  |
| 001-001-001 | 10 |
| 001-001-002 | 20 |
| 001-001-003 | 30 |
| 001-001-004 | 40 |

| PC          | RC |
|-------------|----|
| 001-002-001 | 20 |
| 001-001-007 | 25 |
| 001-001-008 | 30 |
| 001-003-002 | 30 |

| PCI       | RC |
|-----------|----|
| s-2-100-1 | 10 |
| s-2-002-1 | 10 |
| s-2-002-2 | 10 |

| PCN             | RC |
|-----------------|----|
| s-1-1-1-0123-aa | 1  |
| s-1-1-1-0235-aa | 2  |
| s-1-1-1-0555-aa | 3  |

MRN table is (15 of 3000) 1% full.

**rtrv-mrn:pc=1-1-2**

spareduppc 08-12-13 11:35:12 EST EAGLE 40.1.0

| PC          | RC |
|-------------|----|
| 001-001-000 | 5  |
| 001-001-001 | 10 |
| 001-001-002 | 20 |
| 001-001-003 | 30 |
| 001-001-004 | 40 |

MRN table is (15 of 3000) 1% full.

**rtrv-mrn:pci=s-2-2-1**

spareduppc 08-12-13 11:35:12 EST EAGLE 40.1.0

| PCI       | RC |
|-----------|----|
| s-2-100-1 | 10 |
| s-2-002-1 | 10 |
| s-2-002-2 | 10 |

MRN table is (15 of 3000) 1% full.

**rtrv-mrn:pcn=s-1-1-1-123-aa**

spareduppc 08-12-13 11:35:12 EST EAGLE 40.1.0

| PCN             | RC |
|-----------------|----|
| s-1-1-1-0123-aa | 1  |
| s-1-1-1-0235-aa | 2  |
| s-1-1-1-0555-aa | 3  |

MRN table is (15 of 3000) 1% full.

The following example shows output when the Weighted GTT Load Sharing feature is on, and weights are added to an existing MRN set.

**rtrv-mrn:pci=s-2-2-2**

weighton 08-12-13 11:35:12 EST EAGLE 40.1.0

| PCI       | RC | WT | %WT | THR |
|-----------|----|----|-----|-----|
| s-2-002-1 | 10 | 5  | 17  | 50  |
| s-2-002-2 | 10 | 10 | 33  | 50  |
| s-2-100-1 | 10 | 15 | 50  | 50  |

MRN table is (15 of 3000) 1% full.

The following example shows output when the Flexible Final GTT Load Sharing feature is enabled, and the first new ANSI MRN set is added.

**rtrv-mrn**

gflexon 08-12-13 11:35:12 EST EAGLE 40.1.0

| MRNSET | PC              | RC | WT | %WT | THR |
|--------|-----------------|----|----|-----|-----|
| DFLT   | 001-001-000     | 5  | -- | --- | --- |
|        | 001-001-001     | 10 | -- | --- | --- |
|        | 001-001-002     | 20 | -- | --- | --- |
|        | 001-001-003     | 30 | -- | --- | --- |
|        | 001-001-004     | 40 | -- | --- | --- |
| MRNSET | PC              | RC | WT | %WT | THR |
| DFLT   | 001-002-001     | 20 | -- | --- | --- |
|        | 001-001-007     | 25 | -- | --- | --- |
|        | 001-001-008     | 30 | -- | --- | --- |
|        | 001-003-002     | 30 | -- | --- | --- |
| MRNSET | PCI             | RC | WT | %WT | THR |
| DFLT   | s-2-100-1       | 10 | 15 | 50  | 50  |
|        | s-2-002-1       | 10 | 5  | 17  | 50  |
|        | s-2-002-2       | 10 | 10 | 33  | 50  |
| MRNSET | PCN             | RC | WT | %WT | THR |
| DFLT   | s-1-1-1-0123-aa | 1  | -- | --- | --- |
|        | s-1-1-1-0235-aa | 2  | -- | --- | --- |
|        | s-1-1-1-0555-aa | 3  | -- | --- | --- |
| MRNSET | PC              | RC | WT | %WT | THR |
| 1      | 001-003-001     | 10 | -- | --- | --- |
|        | 001-003-002     | 10 | -- | --- | --- |
|        | 001-003-003     | 30 | -- | --- | --- |
|        | 001-003-004     | 30 | -- | --- | --- |
|        | 001-003-006     | 60 | -- | --- | --- |
|        | 001-003-007     | 60 | -- | --- | --- |
|        | 001-003-008     | 80 | -- | --- | --- |
|        | 001-003-009     | 80 | -- | --- | --- |

MRN table is (23 of 6000) 1% full.

The following example shows the output when a mixed ITU network weighted MRN set is used.

**rtrv-mrn:pci=1-55-1:mrnset=2**

gflexon 08-12-13 11:35:12 EST EAGLE 40.1.0

| MRNSET | NET | PC              | RC | WT | %WT | THR |
|--------|-----|-----------------|----|----|-----|-----|
| 2      | N   | s-1-1-1-0235-aa | 30 | 20 | 20  | 1   |
|        | I   | 1-055-1         | 30 | 20 | 20  | 1   |
|        | I   | s-2-002-1       | 30 | 20 | 20  | 1   |
|        | I   | s-2-002-2       | 30 | 20 | 20  | 1   |
|        | N   | 1-1-1-0444-bb   | 30 | 20 | 20  | 1   |

MRN table is (28 of 6000) 1% full.

The following example shows output when the Flexible GTT Loadsharing and GTT LS ARI features are enabled, and the Weighted GTT Loadsharing feature is not turned on.

**rtrv-mrn**

```
eaglestp 08-12-22 19:03:49 EST EAGLE 40.1.0

MRNSET MAPSET MAPPEN MAPSSN PCN RC
DFLT DFLT 01003 10 01002 10
01001 10

MRNSET MAPSET MAPPEN MAPSSN PC RC
1 -----
001-001-002 10
001-001-001 10

MRNSET MAPSET MAPPEN MAPSSN PCI RC
2 1 1-101-3 10 1-101-2 10
1-101-1 10

MRNSET MAPSET MAPPEN MAPSSN PCI RC
3 2 s-2-202-3 * s-2-202-2 10
s-2-202-1 10

MRNSET MAPSET MAPPEN MAPSSN PCN RC
4 DFLT s-02003 * s-02002 20
s-02001 20

MRNSET MAPSET MAPPEN MAPSSN NET PC RC
5 DFLT 01004 20 I 1-101-1 10
N 01001 10
I s-2-202-1 30
```

MRN table is (13 of 6000) 1% full.

;

The following example shows output when the Flexible GTT Loadsharing and GTT LS ARI features are enabled, and the Weighted GTT LS feature is turned on.

**rtrv-mrn**

```
eaglestp 08-12-22 19:04:42 EST EAGLE 40.1.0

MRNSET MAPSET MAPPEN MAPSSN PCN RC WT %WT THR
DFLT DFLT 01003 10 01002 10 5 50 1
01001 10 5 50 1

MRNSET MAPSET MAPPEN MAPSSN PC RC WT %WT THR
1 -----
001-001-002 10 20 67 20
001-001-001 10 10 33 20

MRNSET MAPSET MAPPEN MAPSSN PCI RC WT %WT THR
2 1 1-101-3 10 1-101-2 10 40 57 1
1-101-1 10 30 43 1

MRNSET MAPSET MAPPEN MAPSSN PCI RC WT %WT THR
3 2 s-2-202-3 * s-2-202-2 10 50 50 1
s-2-202-1 10 50 50 1

MRNSET MAPSET MAPPEN MAPSSN PCN RC WT %WT THR
4 DFLT s-02003 * s-02002 20 -- --- ---
s-02001 20 -- --- ---

MRNSET MAPSET MAPPEN MAPSSN NET PC RC WT %WT THR
5 DFLT 01004 20 I 1-101-1 10 20 50 1
N 01001 10 20 50 1
I s-2-202-1 30 20 100 1
```

MRN table is (13 of 6000) 1% full.

;

The following example shows output for a specific point code and MRN Set. The Flexible GTT Loadsharing and GTT LS ARI features are enabled, and the Weighted GTT Loadsharing feature is turned off.

**rtrv-mrn:pcn=1001:mrnset=df1t**

eaglestp 08-12-22 19:03:53 EST EAGLE 40.1.0

| MRNSET | MAPSET | MAPPEN | MAPSSN | PCN   | RC |
|--------|--------|--------|--------|-------|----|
| DFLT   | DFLT   | 01003  | 10     | 01002 | 10 |
|        |        |        |        | 01001 | 10 |

MRN table is (13 of 6000) 1% full.

;

The following example shows output for a specific point code and MRN Set. The Flexible GTT Loadsharing and GTT LS ARI features are enabled, and the Weighted GTT Loadsharing feature is turned on.

**rtrv-mrn:pcn=1001:mrnset=df1t**

eaglestp 08-12-22 19:04:47 EST EAGLE 40.1.0

| MRNSET | MAPSET | MAPPEN | MAPSSN | PCN   | RC | WT | %WT | THR |
|--------|--------|--------|--------|-------|----|----|-----|-----|
| DFLT   | DFLT   | 01003  | 10     | 01002 | 10 | 5  | 50  | 1   |
|        |        |        |        | 01001 | 10 | 5  | 50  | 1   |

MRN table is (13 of 6000) 1% full.

;

**Legend**

- **MRNSET**—MRN set ID
- **NET**—This field identifies the mated network type of the point code when an ITU MRN set contains both ITU-I and ITU-N point codes. The field can show I if the PC is an ITU-I point code or N if the PC is an ITU-N point code.
- **PC/PCI/PCN**—Point Code
- **RC**—Relative Cost
- **WT**—PC Weight
- **%WT**—Relative percentage, according to weight, of an in-service PC within an RC group.
- **THR**—Service threshold. If the relative percentage, according to weight, of in-service PCs within a RC group falls below the in-service threshold, that RC group is considered out-of-service, and traffic is routed to the next lowest RC group.
- **MAPSET**—This field specifies the secondary mate MAP Set.
- **MAPPEN**—This field specifies the Alternate RI Mate point code.
- **MAPSSN**—This field specifies the Alternate RI Mate subsystem number.

**rtrv-mtc-measopts**

**Retrieve Maintenance Measurement Options**

Use this command to show the enabled/disabled status of all hourly and daily scheduled maintenance measurements reports.



**Keyword:** rtrv-mtc-measopts

**Related Commands:** chg-measopts, chg-mtc-measopts, chg-netopts, rtrv-measopts, rtrv-netopts

**Command Class:** Link Maintenance

**Parameters**

This command has no parameters.

**Example**

```
rtrv-mtc-measopts
```

**Dependencies**

The Measurements Platform feature must be on before this command can be entered.

This command cannot be entered while in upgrade mode.

**Notes**

None

**Output****rtrv-mtc-measopts**

```

tekelecstp 08-08-01 16:31:40 EST EAGLE 39.2.0
MTCHLNP           = off
MTCHNP           = off
MTCHMAP          = off
MTCHEIR          = off
MTCHVFLEX        = on
MTCHATINPQ       = off
MTC DSTP         = off
MTC DLNK         = off
MTC DLNKSET      = off
MTC DSTPLAN      = off
MTC DLNP         = off
MTC DNP          = off
MTC DMAP         = off
MTC DEIR         = off
MTC DVFLEX       = on
MTC DATINPQ      = off
MTC DSCTPASOC    = off
MTC DSCTPCARD    = off
MTC DUA          = off

```

;

**Legend**

**MTCHEIR**—Maintenance Hourly (marginal) measurements report for Equipment Identity Register.

**MTCHVFLEX**—Maintenance Hourly (marginal) measurements report for V-Flex (Voice Mail Router).

**MTCHATINPQ**—Maintenance Hourly (marginal) measurements report for ATINP Query.

**MTCHNP**—Maintenance Hourly (marginal) measurements report for INP, INP CRP, and G-Port.

**MTCHLNP**—Maintenance Hourly (marginal) measurements report for LNP.

**MTCHMAP**—Maintenance Hourly (marginal) measurements report for GSM Map Screening.

**MTCDEIR**—Maintenance Daily measurements report for Equipment Identity Register.

**MTC DVFLEX**—Maintenance Daily measurements report for V-Flex (Voice Mail Router).

**MTC DSTP**—Maintenance Daily measurements report for STP.

**MTC DLNK**—Maintenance Daily measurements report for links.

**MTC DLNKSET**—Maintenance Daily measurements report for linksets.

**MTC DSTPLAN**—Maintenance Daily measurements report for STPLAN.

**MTC DLNP**—Maintenance Daily measurements report for LNP.

**MTC DNP**—Maintenance Daily measurements report for INP/AINPQ, INP CRP, and G-Port.

**MTC DMAP**—Maintenance Daily measurements report for GSM Map Screening.

**MTC DSCTPASOC**—Maintenance Daily measurements report for SCTP associations

**MTC DSCTPCARD**—Maintenance Daily measurements report for SCTP cards

**MTC DUA**—Maintenance Daily measurements report for UA associations

**rtrv-na****Retrieve Network Appearance**

Use this command to display the configured network appearances.

**Keyword:** rtrv-na  
**Related Commands:** dlt-na, ent-na  
**Command Class:** Database Administration

### Parameters

This command has no parameters.

### Example

```
rtrv-na
```

### Dependencies

None

### Notes

None

### Output

```
rtrv-na
rlghncxa03w 05-01-20 09:07:58 EST EAGLE 31.12.0
TYPE      GC          NA
ANSI      --          0
ITUI      --          1
ITUN      aa          2
ITUN24    --          3
ITUIS     --          4
ITUNS     bb          5
;
```

## rtrv-netopts

## Retrieve Network Options

Use this command to retrieve the user-specified options for the IP and Fast Copy (FC) networks used by the EAGLE 5 ISS. This command displays the PVN IP address, PVN subnet mask, and FC Network parameters.

**Keyword:** rtrv-netopts  
**Related Commands:** chg-netopts  
**Command Class:** Database Administration

### Parameters

This command has no parameters.

### Example

```
rtrv-netopts
```

### Dependencies

The EAGLE 5 Integrated Monitoring Support (E5IS) feature must be turned on before this command can be entered.

### Notes

None

**Output**

```
rtrv-netopts
rlghncxa03w 08-12-11 16:35:57 IST EAGLE 40.1.0
NETWORK OPTIONS
-----
PVN           = 170.120.50.1
PVNMASK       = 255.255.252.0
FCNA          = 170.21.96.0
FCNAMASK      = 255.255.254.0
FCNB          = 170.22.96.0
FCNBMASK      = 255.255.254.0
;
```

**rtrv-npp-as****Retrieve NPP Action Set(s)**

Use this command to display a Numbering Plan Processor (NPP) Action Set (AS) entry.

**Keyword:** rtrv-npp-as

**Command Class:** Database Administration

**Parameters**

**:asn=** (optional)

Action set name. This parameter specifies the name of the AS.

**Range:** ayyyyyyyyy

1 alphabetic character followed by up to 9 alphanumeric characters

**Dependencies**

None

**Output**

The following example displays all AS entries.

**rtrv-npp-as**

tekelecstp 09-03-05 15:37:41 EMS EAGLE 41.0.0

| ASN  | CA                | SA                                       | FA             | OFNAI | REFS |
|------|-------------------|------------------------------------------|----------------|-------|------|
| asn1 | znx               | asdlkup                                  | asd            | inc   | 0    |
| asn2 | znx               | grnlkup                                  | grn            | inc   | 0    |
| asn3 | znx               | cgpnasdrqd<br>nprls                      | zn             | inc   | 0    |
| asn4 | znx               | cgpnasdrqd<br>cgpngrnrqd<br>nprelay      | grn            | inc   | 0    |
| asn5 | ac8<br>sn8<br>cc3 | rtdbtrn<br>rtdbtsp<br>rtdbtrnsp<br>cdial | sn<br>ac<br>cc | inc   | 0    |
| asn6 | cc3<br>ac8<br>sn8 | nscdpn<br>nscgpn                         | cc<br>ac<br>sn | intl  | 0    |

NPP-AS table is (5 of 1024) 1% full.

;

The following example displays a specific AS entry that contains TIF Number Substitution Service Actions.

**rtrv-npp-as:asn=asn6**

tekelecstp 09-04-05 15:37:41 EMS EAGLE 41.0.0

| ASN  | CA                | SA               | FA             | OFNAI | REFS |
|------|-------------------|------------------|----------------|-------|------|
| asn6 | cc3<br>ac8<br>sn8 | nscdpn<br>nscgpn | cc<br>ac<br>sn | intl  | 0    |

NPP-AS table is (5 of 1024) 1% full.

;

**Legend**

**ASN**—Action Set Name

**CA**—Conditioning Action

**SA**—Service Action

**FA**—Formatting Action

**OFNAI**—Outgoing Filter Nature of Address Indicator

**REFS**—NPP Rule References

**rtrv-npp-serv**

**Retrieve a NPP Service Data**

Use this command to display a Numbering Plan Processor (NPP) Service Data entry.

**Keyword:** rtrv-npp-serv

**Related Commands:** chg-npp-serv, chg-npp-srs, dlt-npp-srs, ent-npp-srs

**Command Class:** Database Administration

### Parameters

**:mode=** (optional)

This parameter allows the command to display NAI and delimiter values.

**Range:** full

**:srvn=** (optional)

Service name. This parameter specifies the name of the NPP Service.

**Range:** nppt, idprcdpn, idprcgp, tif, tif2, tif3, mosmsicgpn, mosmsicdpn, mosmsgcgp, mosmsgcdpn, iarcdpn, iarcgpn

**nppt** — NPP Test Service

**idprcdpn** — IDPRCDPN Service

**idprcgp** — IDPRCGPN Service

**tif** — TIF Service

**tif2** — TIF2 Service

**tif3** — TIF3 Service

**mosmsicgpn** — MOSMSICGPN service

**mosmsicdpn** — MOSMSICDPN Service

**mosmsgcgp** — MOSMSGCGPN Service

**mosmsgcdpn** — MOSMSGCDPN Service

**iarcdpn** — IARCDPN Service

**iarcgpn** — IARCGN Service

### Example

```
rtrv-npp-serv:srvn=tif:mode=full
```

```
rtrv-npp-serv:srvn=tif
```

### Dependencies

None

**Output**

The following example displays all NPP Service table entries.

**rtrv-npp-serv**

tekelecstp 09-06-12 10:24:32 EST EAGLE 41.1.0

| SERVICE | STATUS | SA        | PRECEDENCE |
|---------|--------|-----------|------------|
| nppt    | on     | rtdbtrnsp | 100        |
|         |        | rtdbtrn   | 50         |
|         |        | rtdbtsp   | 50         |
|         |        | cdial     | 10         |

| SERVICE | STATUS | SA         | PRECEDENCE |
|---------|--------|------------|------------|
| tif     | off    | cdial      | 10         |
|         |        | fwdscls    | 5          |
|         |        | crp        | 92         |
|         |        | npnrls     | 91         |
|         |        | nprelay    | 80         |
|         |        | npnrls     | 80         |
|         |        | snsccgpn   | 75         |
|         |        | cgpnsvcrqd | 80         |
|         |        | asdlkup    | 90         |
|         |        | grnlkup    | 90         |
|         |        | cgpnasdrqd | 90         |
|         |        | cgpngrnrqd | 90         |
|         |        | nscdpn     | 80         |
|         |        | nscgpn     | 75         |

| SERVICE | STATUS | SA         | PRECEDENCE |
|---------|--------|------------|------------|
| tif2    | off    | cdial      | 10         |
|         |        | fwdscls    | 5          |
|         |        | crp        | 92         |
|         |        | npnrls     | 91         |
|         |        | nprelay    | 80         |
|         |        | npnrls     | 80         |
|         |        | snsccgpn   | 75         |
|         |        | cgpnsvcrqd | 80         |
|         |        | asdlkup    | 90         |
|         |        | grnlkup    | 90         |
|         |        | cgpnasdrqd | 90         |
|         |        | cgpngrnrqd | 90         |
|         |        | nscdpn     | 80         |
|         |        | nscgpn     | 75         |

| SERVICE | STATUS | SA         | PRECEDENCE |
|---------|--------|------------|------------|
| tif3    | off    | cdial      | 10         |
|         |        | fwdscls    | 5          |
|         |        | crp        | 92         |
|         |        | npnrls     | 91         |
|         |        | nprelay    | 80         |
|         |        | npnrls     | 80         |
|         |        | snsccgpn   | 75         |
|         |        | cgpnsvcrqd | 80         |
|         |        | asdlkup    | 90         |
|         |        | grnlkup    | 90         |
|         |        | cgpnasdrqd | 90         |
|         |        | cgpngrnrqd | 90         |
|         |        | nscdpn     | 80         |
|         |        | nscgpn     | 75         |

```

SERVICE      STATUS  SA          PRECEDENCE
-----
idpredpn     off    ccncchk    100
             cdppnp     80
             lacck      60
             cgpnsvcraqd 60
             asdlkup    50
             grnlkup    50
             cgpnasdrqd 50
             cgpngrnrqd 50

SERVICE      STATUS  SA          PRECEDENCE
-----
idpregpn     off    cgpnpnp    80
             asdlkup    50
             grnlkup    50
             blklstqry   90
             blklstrly  90
             cgpnrty   70

```

i

The following example displays NPP Service table data for a specific Service Name.

**rtrv-npp-serv:svrn=tif**

```
tekelecstp 09-05-02 08:46:47 EST EAGLE 41.0.0
```

```

SERVICE      STATUS  SA          PRECEDENCE
-----
tif           off    crp         92
             npnrsls   91
             nprelay   90
             nprls     90
             cgpnsvcraqd 90
             snscgpn   80
             cdial     10
             fwdscs    5
             nprelay   80
             nprls     80
             snscgpn   75
             cgpnnprqd 80
             asdlkup    90
             grnlkup    90
             cgpnasdrqd 90
             cgpngrnrqd 90
             nscdpn    80
             nscgpn    75

```

i

The following example displays all NPP Service data for a specified Service Name when the **mode=full** parameter is specified.

**rtrv-npp-serv:svrn=tif:mode=full**

```
tekelecstp 09-05-02 08:46:52 EST EAGLE 41.0.0
```

```

SERVICE      STATUS  SA          PRECEDENCE  FNAI  NAI
-----
tif           off    cdial       10          unkn   0
             fwdscs    5           intl    4
             crp      92          natl    3
             npnrsls   91          nail    none
             nprelay   90          nai2    none
             nprls     90          nai3    none
             snscgpn   80
             cgpnnprqd 80
             asdlkup    90

```



```

grnlkup      90
cgpnasdrqd  90
cgpngrnrqd  90
nscdpn      80
nscgpn      75
    
```

```

                                DELIMITERS
dlma=1234567890abcdef  dlmb=aaaaabbbbcccccd  dlmc=1020304050607080
dlmd=d0d0              dlme=e0e0              dlmf=f0f0
dlmg=9010              dlmh=9020              dlmi=9030
dlmj=9040              dlmk=9050              dlml=9050
dlmm=9060              dlmn=9070              dlmo=9080
dlmp=9090
    
```

;

## rtrv-npp-srs

## Retrieve a NPP Service Rule Set

Use this command to display a Numbering Plan Processor (NPP) Service Rule Set entry.

**Keyword:** rtrv-npp-srs

**Related Commands:** chg-npp-serv, chg-npp-srs, dlt-npp-srs, ent-npp-srs

**Command Class:** Database Administration

### Parameters

**:asn=** (optional)

Action set name. This parameter displays the rules associated with the specified action set.

**Range:** ayyyyyyyyy

1 alphabetic character followed by up to 9 alphanumeric characters

**:fdl=** (optional)

Filter digit length. This parameter specifies the number of digits on the incoming digit string that is filtered by the NPP.

**Range:** 1-32 \*

\*—multiple lengths of digit strings can be filtered

**:fnai=** (optional)

Filter nature of address indicator. This parameter specifies the filter Nature of Address Indicator (NAI) class.

**Range:** intl, natl, nai1, nai2, nai3, unkn

**intl**— filter messages with NAI=INTL

**natl**— filter messages with NAI=NATL

**nai1**— filter messages with NAI=NAI1

**nai2**— filter messages with NAI=NAI2

**nai3**— filter messages with NAI=NAI3

**unkn**— filter messages with NAI=UNKN

The **chg-npp-serv** command is used to assign values to the various FNAI classes.

**:fpx=** (optional)

Filter prefix. This parameter specifies the prefix used to filter incoming digit strings.

**Range:** 1-16 digits, \*, ?

1 - 16 hexadecimal digits inclusive of single digit wildcard (?); or wildcard (\*) matching the entire digit string; valid digits are ?, 0-9, a-f, A-F.

**:srvn=** (optional)

Service name. This parameter displays the rules associated with the specified service.

**Range:** **nppt, idprcdpn, idprcgpn, tif, tif2, tif3, mosmsicgpn, mosmsicdpn, mosmsgcgpn, mosmsgcdpn, iarcdpn, iarcgpn**  
**nppt** — NPP Test Service  
**idprcdpn** — IDPRCDPN Service  
**idprcgpn** — IDPRCGPN Service  
**tif** — TIF Service  
**tif2** — TIF2 Service  
**tif3** — TIF3 Service  
**mosmsicgpn** — MOSMSICGPN Service  
**mosmsicdpn** — MOSMSICDPN Service  
**mosmsgcgpn** — MOSMSGCGPN Service  
**mosmsgcdpn** — MOSMSGCDPN Service  
**iarcdpn** — IARCDPN Service  
**iarcgpn** — IARCGPN Service

### Example

Display all NPP Service Rule Set table entries for a given service.

```
rtrv-npp-srs
```

Display NPP Service Rule Set table entries for a specified digit length.

```
rtrv-npp-srs:fdl=*
```

Display NPP Service Rule Set table entries for a specified filter prefix and filter digit length.

```
rtrv-npp-srs:fpfx=91:fdl=16
```

### Dependencies

The value specified for the **fpfx** parameter cannot have a **?** as the final character.

### Output

Display all NPP Service Rule Set table entries for a given service.

```
rtrv-npp-srs
```

```
tekelecstp 09-07-02 13:57:06 EST EAGLE 41.1.0
```

```
Command entered at terminal #4.
```

| SRVN | FPFX | FDL | FNAI | ASN  |
|------|------|-----|------|------|
| nppt | a    | 10  | intl | asn2 |
| nppt | a    | 16  | intl | asn3 |
| tif2 | b    | 12  | natl | asn5 |

```
NPP-SRS table is (3 of 8192) 1% full.
```

```
;
```

### Legend

- **SRVN**—Service Name
- **FPFX**—Filter Prefix
- **FDL**—Filter Digit Length
- **FNAI**—Filter Nature of Address Indicator
- **ASN**—Action Set Name

**rtrv-oap-config****Retrieve OAP Configuration**

Use this command to display the OAP configuration information in the EAGLE 5 ISS database configured with the **chg-oap-config** command.

**Keyword:** **rtrv-oap-config**

**Related Commands:** **chg-oap-config**

**Command Class:** Database Administration

**Parameters**

This command has no parameters.

**Example**

```
rtrv-oap-config
```

**Dependencies**

The SEAS feature must be on (**seas=on** in the **rtrv-feat** command output) before this command can be entered.

**Notes**

None

**Output**

In the following example, the SEAS feature is on.

```
rtrv-oap-config
```

```
rlghncxa03w 03-03-07 00:57:31 EST EAGLE 31.3.0
OAP CONFIGURATION REPORT
DATA                OAP A                OAP B
Hostname            tekelec-8            tekelec-9
IP Address          128.132.064.015     128.132.064.016
IP Netmask          255.255.255.000     255.255.255.000
Default Router      128.132.064.001     128.132.064.001
Config              dual                 dual
SEAC CLLI           SEASNJPYRRC         SEASNJPYRRC
X25 Packet Size     7                    7
X25 Mode            DTE                  DTE
;
```

**Legend**

**HOSTNAME**—Host name of OAP A or OAP B.

**IP ADDRESS**—IP address of OAP A or OAP B.

**IP NETMASK**—The netmask for OAP A or OAP B.

**DEFAULT ROUTER**—The IP address of the default router assigned to OAP A or OAP B.

**CONFIG**—The number of OAPs configured (single or dual).

**SEAC CLLI**—The common language location identifier (CLLI) of the SEAC to which the OAP connects.

**X25 PACKET SIZE**—The X.25 package size for the link to the SEAC (7 or 8).

**X25 MODE**—The mode of the X.25 link to the SEAC (DTE or DTC).

**rtrv-obit****Retrieve Obituary Report**

Use this command to show the obituaries that were most recently logged in the system. The report shows the obituaries from either the active or standby OAM, and the report indicates which card and processor generated the obituary.

An obituary is a set of data that describes the status of the system just before a processor restarted due to a fault in hardware or software. The data includes a register and stack dump of the processor, card location, reporting module number, software code location, and class of the fault detected.

**Keyword:** rtrv-obit

**Related Commands:** act-alm-trns, dact-alm-trns, rept-stat-clk, rept-stat-trbl, rls-alm, rtrv-trbl

**Command Class:** System Maintenance

**Parameters**

**:loc=** (mandatory)

The address of the card that is running the OAM from which the obituary information is to be retrieved.

**Range:** 1113, 1115

**:mode=** (optional)

Display mode

**Range:** c, m

**c**—Continuous mode; shows obituaries already logged and new obituaries as they occur.

**m**—Manual mode; shows obituaries on demand only, when this command is entered.

**Default:** c

**:num=** (optional)

This parameter specifies the number of obituaries to display.

**Range:** 1-150

**Default:** 150

**Example**

```
rtrv-obit:loc=1115:num=2
```

**Dependencies**

The obituary log on the specified OAM must contain at least one obituary; otherwise, the command is rejected.

If the **mode** parameter is specified without the **num** parameter, the entire log is displayed.

Only one **rtrv-obit** or **rtrv-trbl** command at a time can be in progress throughout the entire system.

The card location specified by the **loc** parameter must be either **1113** or **1115**.

If the **loc** parameter specifies the card that is running the standby OAM, that card must be available.

The **num** parameter value must be between **1** and **150**.

**Notes**

This command can be canceled using the **F9** function key or the **canc-cmd** command when the command is entered for the active OAM. See **canc-cmd** for more information.

In most situations, obituary reports are generated automatically when a card is reset. Automatic report generation can be turned off by selecting the **mode=m** parameter for manual mode.

The obituary from a 186 processor displays the register dump and a 16-word stack dump.

The obituary from a 486 processor is different from 186 because the register set is larger. Also, only 12 words of the stack are dumped for the 486.

The obituary from an IXP-based processor card (which includes HIPR, HIPR2 and HC MIM cards) contains significantly more information than an obituary from an X86-based processor card. The data in an IXP obituary is spread over multiple system buffers, where each buffer is logged and printed as an independent obituary. Sequence numbers are displayed in the output so that it is clear which buffers comprise a given obituary. There is an overall sequence number, and a sequence number within each class (such as IXP register set or user data) of information.

**Output**

The following example shows output for two obituaries from an x86-based card.

**rtrv-obit:loc=1115:num=2**

```

rlghncxa03w 03-03-30 08:43:14 EST EAGLE 31.3.0
-----
STH: Received a BOOT 286-obituary reply for 1 restart(s)
Primary: Card 1203 Module 4608 Mod_loc 1 Class 0080
Register Dump :
    FL=338e    CS=4a9c    IP=01c0
    AX=0000    CX=0100    DX=21c1    BX=078a
    SP=01a6    BP=01a6    SI=0fe4    DI=3ece
    DS=dce8    ES=21c1    SS=336b
Stack Dump :
[SP+1E]=3ece    [SP+16]=46cc    [SP+0E]=0001    [SP+06]=0246
[SP+1C]=078a    [SP+14]=dce8    [SP+0C]=4608    [SP+04]=338e
[SP+1A]=078a    [SP+12]=078a    [SP+0A]=0001    [SP+02]=4a9c
[SP+18]=0100    [SP+10]=336b    [SP+08]=0080    [SP+00]=01c0

STH: Received a BOOT 486-obituary reply for 1 restart(s)
Primary: Card 1213 Module 0047 Mod_loc 5 Class 0241
Register Dump :
    EFL=00000000    CS =0208    EIP=0003e75f    SS =0060
    EAX=0009a90b    ECX=0009a915    EDX=00000000    EBX=00000000
    ESP=000ddaf2    EBP=000ddb6c    ESI=00090241    EDI=00141df8
    DS =0060    ES =0060    FS =0060    GS =0060
Stack Dump :
[ESP+2E]=0009    [ESP+28]=1df8    [ESP+22]=0000    [ESP+1C]=a915
[ESP+2C]=a90b    [ESP+26]=0009    [ESP+20]=0000    [ESP+1A]=0009
[ESP+2A]=0014    [ESP+24]=a8c0    [ESP+1E]=0009    [ESP+18]=a90b
User Data Dump :
    0a 06 00 00 46 01 08 04 00 00 00
Report Date:03-03-04 Time:09:19:59
-----
;

```

The following example shows output for six obituaries from an IXP-based card.

**rtrv-obit:loc=1113:num=6**

```

rlghncxa03w 03-01-23 08:43:14 EST EAGLE 30.0.0
-----
STH: Received a BOOT IMT-obituary reply for 1 restart(s)
Card 1209 Module TKS_SBFR.C Line 728 Class 01cc
StrongARM Core Register Dump (1 of 1): [Overall: 1 of 6]
    r0 =00008b22    r1 =00004e72    r2 =0003e75f    r3 =0060024a
    r4 =0004a92b    r5 =000019c5    r6 =0000a57c    r7 =00005521
    r8 =0000b1f7    r9 =0000836c    r10=0000e251    r11=00141d42
    r12=006055a3    sp =0000727c    lr =0000003f    pc =00006429
Report Date:03-01-23 Time:12:20:45
-----

```

```

rlghncxa03w 03-01-23 08:43:14 EST EAGLE 30.0.0
-----
STH: Received a BOOT IMT-obituary reply for 1 restart(s)
Card 1209 Module TKS_SBFR.C Line 728 Class 01cc
StrongARM Core Stack Dump (1 of 1): [Overall: 2 of 6]
System Mode Stack:
    0000 15a3a816 0012be0a 06000046 01080400 .....
    0010 00a2342c 07f7b83a 15729dd2 05580601 .....
    0020 1a22a616 7072b91a 46304a44 06887400 .....
    0030 25a33b12 01a4ba22 17e03026 11483402 .....
    0040 00130811 0033a30a 14008149 0cab6130 .....

```

```

0050 00000000 00000000 00000000 00000000 .....
0060 15a3a816 0012be0a 06000046 01080400 .....
0070 00a2342c 07f7b83a 15729dd2 05580601 .....
0080 1a22a616 7072b91a 46304a44 06887400 .....
Abort Mode Stack:
0000 25a33b12 01a4ba22 17e03026 11483402 .....
0010 00130811 0033a30a 14008149 0cab6130 .....
0020 1a22a616 7072b91a 46304a44 06887400 .....
0030 25a33b12 01a4ba22 17e03026 11483402 .....
0040 00130811 0033a30a 14008149 0cab6130 .....
0050 00000000 00000000 00000000 00000000 .....
0060 15a3a816 0012be0a 06000046 01080400 .....
Report Date:03-01-23 Time:12:20:45
-----

```

rlghncxa03w 03-01-23 08:43:14 EST EAGLE 30.0.0

STH: Received a BOOT IMT-obituary reply for 1 restart(s)  
Card 1209 Module TKS\_SBFR.C Line 728 Class 01cc

IXP Register Dump (1 of 2): [Overall: 3 of 6]

\*\*\*\*\* FBI Registers: \*\*\*\*\*

```

IREG =00000000          SOP_SEQ1=00000000
SOP_SEQ2=0003e75f      ENQUEUE_SEQ1=0060024a
ENQUEUE_SEQ2=0060024a  THREAD_DONE_REG0=00600231
THREAD_DONE_REG1=00600231  RCV_RDY_CNT=000012d4
RCV_RDY_HI =0009a90b     RCV_RDY_LO=00000000
RCV_RDY_CTL=0009a915    RCV_CNTL=00000000
REC_FASTPORT_CTL =000ddaf2  FLOWCTL_MASK =000ddb6c
RDYBUS_SYN_CNT_DEF=00090241  SELF_DESTRUCT=00141df8
HASH_MULTIPLIER_64_HI=006011a3  HASH_MULTIPLIER_64_LO=00000000
HASH_MULTIPLIER_48_HI=006011a3  HASH_MULTIPLIER_48_LO=00000000
GET_CMD=00000000          XMIT_RDY_LO=00000000
XMIT_RDY_HI=00000000     XMIT_RDY_CTL=00000000
XMIT_PTR =0003e75f

```

\*\*\*\*\* SDRAM Registers: \*\*\*\*\*

```

SDRAM_CSR=0060024a      SDRAM_MEMCTL0=0060024a
SDRAM_MEMCTL1=00600231  DRAM_MEMINIT=00600231

```

\*\*\*\*\* StrongARM System Registers: \*\*\*\*\*

```

PLL_CFG=0060024a      GPIO_EN=0060024a
GPIO_DATA=00600231    RTC_DIV=00600231
RTC_INIT=000012d4     RTC_TVAL=0009a90b
RTC_CNTR=00000000     RTC_ALM=0009a915
UART_SR=0009a915     UART_CR=00000000
UART_DR=00090241     TIMER_1_LOAD=000ddb6c
TIMER_2_LOAD=00090241  TIMER_3_LOAD=00141df8
TIMER_4_LOAD=00000000  TIMER_1_VALUE=00000000
TIMER_2_VALUE=006011a3  TIMER_3_VALUE=00000000
TIMER_4_VALUE=00090241  TIMER_1_CONTROL=00141df8
TIMER_2_CONTROL=00000000  TIMER_3_CONTROL=00000000
TIMER_4_CONTROL=006011a3  FIQ=00000000
IRQ=00000000

```

\*\*\*\*\* PCI Configuration Space Registers: \*\*\*\*\*

```

PCI_VEN_DEV_ID=0060024a  PCI_CMD_STAT=0060024a
PCI_REV_CLASS=00600231  PCI_CACHE_LAT_HDR_BIST=00600231
PCI_MEM_BAR=000012d4    PCI_IO_BAR=0009a90b
PCI_DRAM_BAR=00000000   PCI_SUBSYS=0009a915
PCI_INT_LAT=0009a915

```

\*\*\*\*\* PCI Shared Control Registers: \*\*\*\*\*

```

CAP_PTR_EXT=00090241    PWR_MGMT=000ddb6c
IXP1200_RESET=00090241  PCI_OUT_INT_MASK=00141df8
I2O_INB_FIFO=00000000  I2O_OUTB_FIFO=00000000
MAILBOX_0=006011a3     MAILBOX_1=00000000
MAILBOX_2=006011a3     MAILBOX_3=00000000

```

```

DOORBELL=006011a3          DOORBELL_SETUP=00000000
***** PCI Control Registers: *****
CHAN_1_BYTE_COUNT=0060024a  CHAN_2_BYTE_COUNT=0060024a
CHAN_1_PCI_BAR=00600231     CHAN_2_PCI_BAR=00600231
CHAN_1_DRAM_ADDR=000012d4   CHAN_2_DRAM_ADDR=0009a90b
CHAN_1_DESC_PTR=00000000    CHAN_2_DESC_PTR=0009a915
CHAN_1_CONTROL=0009a915     CHAN_2_CONTROL=00000000
DMA_INF_MODE=00090241       CSR_BASE_ADDR_MASK=000ddb6c
DRAM_BASE_ADDR_MASK=000ac14c I20_INB_FLIST_HPTR=00141df8
I20_INB_PLIST_TPTR=006011a3 I20_OUTB_PLIST_HPTR =00000000
I20_OUTB_FLIST_TPTR =00000000 I20_INB_FLIST_CNT=00000000
I20_OUTB_PLIST_CNT =006011a3 I20_INB_PLIST_CNT =00000000
SA_CONTROL=00090241         PCI_ADDR_EXT=000ddb6c
DBELL_PCI_MASK=00090241     DBELL_SA_MASK=00141df8
IRQ_STATUS=00000000         FIQ_STATUS=00000000
IRQ_RAW_STATUS=006011a3     FIQ_RAW_STATUS=00000000
IRQ_ENABLE=006011a3        FIQ_ENABLE=00000000
***** Coprocessor 15 Registers: *****
ID_CHIP=0060024a           CONTROL_CP15=0060024a
TRANSLATION_TAB_BASE=00600231 DOMAIN_ACCESS_CONTROL=00600231
FAULT_STATUS=000012d4      FAULT_ADDRESS=0009a90b
CACHE_CONTROL_OPER=00000000 READ_BUFFER_OPER=0009a915
PROC_ID_VIRT_ADDR_MAP=00000000
DATA_BREAKPT_CONTROL_REG=0009a915

```

Report Date:03-01-23 Time:12:20:45

rlghncxa03w 03-01-23 08:43:14 EST EAGLE 30.0.0

STH: Received a BOOT IMT-obituary reply for 1 restart(s)

Card 1209 Module TKS\_SBFRC Line 728 Class 01cc

IXP Register Dump (2 of 2): [Overall: 4 of 6]

```

***** SRAM Registers: *****
SRAM_CSR=0060024a          SRAM_AUTO_BASE=0060024a
SRAM_AUTO_PTR=00600231     SRAM_AUTO_END=00600231
SRAM_TEST_MOD=000012d4    SRAM_SLOW_CONFIG=0009a90b
SRAM_BOOT_CONFIG=00000000 SRAM_SLOWPORT_CONFIG=0009a915

```

```

***** Microengine 0 Registers: *****
USTORE_DATA=0060024a       ALU_OUTPUT=0060024a
CTX_ENABLES=000012d4       CC_ENABLE=0009a90b
CTX_0_SIG_EVENTS=00090241  CTX_1_SIG_EVENTS=000ddb6c
CTX_2_SIG_EVENTS=00090241  CTX_3_SIG_EVENTS=00141df8
CTX_0_WAKEUP_EVENTS=00000000 CTX_1_WAKEUP_EVENTS=00000000
CTX_2_WAKEUP_EVENTS=006011a3 CTX_3_WAKEUP_EVENTS=00000000
CTX_ARB_CNTL=00600231

```

```

ACTIVE_CTX_STS:  SEG=1  ACNO=1  AB=0  ACTXPC: 38
CTX_0_STS:       SEG=1  ACNO=2  RR=0  CTX_PC:
245
CTX_1_STS:       SEG=0  ACNO=1  RR=1  CTX_PC:
15
CTX_2_STS:       SEG=0  ACNO=0  RR=0  CTX_PC:
75
CTX_3_STS:       SEG=1  ACNO=3  RR=1  CTX_PC:
132

```

```

***** Microengine 1 Registers: *****
USTORE_DATA=0060024a       ALU_OUTPUT=0060024a
CTX_ENABLES=000012d4       CC_ENABLE=0009a90b
CTX_0_SIG_EVENTS=00090241  CTX_1_SIG_EVENTS=000ddb6c
CTX_2_SIG_EVENTS=00090241  CTX_3_SIG_EVENTS=00141df8
CTX_0_WAKEUP_EVENTS=00000000 CTX_1_WAKEUP_EVENTS=00000000
CTX_2_WAKEUP_EVENTS=006011a3 CTX_3_WAKEUP_EVENTS=00000000
CTX_ARB_CNTL=00600231
ACTIVE_CTX_STS:  SEG=1  ACNO=1  AB=0  ACTXPC: 38
CTX_0_STS:       SEG=1  ACNO=2  RR=0  CTX_PC:
245

```



```

15      CTX_1_STS:      SEG=0   ACNO=1   RR=1   CTX_PC:
128     CTX_2_STS:      SEG=0   ACNO=0   RR=0   CTX_PC:
72      CTX_3_STS:      SEG=1   ACNO=3   RR=1   CTX_PC:

***** Microengine 2 Registers: *****
USTORE_DATA=0060024a      ALU_OUTPUT=0060024a
CTX_ENABLES=000012d4      CC_ENABLE=0009a90b
CTX_0_SIG_EVENTS=00090241  CTX_1_SIG_EVENTS=000ddb6c
CTX_2_SIG_EVENTS=00090241  CTX_3_SIG_EVENTS=00141df8
CTX_0_WAKEUP_EVENTS=00000000  CTX_1_WAKEUP_EVENTS=00000000
CTX_2_WAKEUP_EVENTS=006011a3  CTX_3_WAKEUP_EVENTS=00000000
CTX_ARB_CNTL=00600231
ACTIVE_CTX_STS:  SEG=1   ACNO=1   AB=0   ACTXPC: 38
245     CTX_0_STS:      SEG=1   ACNO=2   RR=0   CTX_PC:

125     CTX_1_STS:      SEG=0   ACNO=1   RR=1   CTX_PC:
75      CTX_2_STS:      SEG=0   ACNO=0   RR=0   CTX_PC:
62      CTX_3_STS:      SEG=1   ACNO=3   RR=1   CTX_PC:

***** Microengine 3 Registers: *****
USTORE_DATA=0060024a      ALU_OUTPUT=0060024a
CTX_ENABLES=000012d4      CC_ENABLE=0009a90b
CTX_0_SIG_EVENTS=00090241  CTX_1_SIG_EVENTS=000ddb6c
CTX_2_SIG_EVENTS=00090241  CTX_3_SIG_EVENTS=00141df8
CTX_0_WAKEUP_EVENTS=00000000  CTX_1_WAKEUP_EVENTS=00000000
CTX_2_WAKEUP_EVENTS=006011a3  CTX_3_WAKEUP_EVENTS=00000000
CTX_ARB_CNTL=00600231
ACTIVE_CTX_STS:  SEG=1   ACNO=1   AB=0   ACTXPC: 38
245     CTX_0_STS:      SEG=1   ACNO=2   RR=0   CTX_PC:

125     CTX_1_STS:      SEG=0   ACNO=1   RR=1   CTX_PC:
75      CTX_2_STS:      SEG=0   ACNO=0   RR=0   CTX_PC:
62      CTX_3_STS:      SEG=1   ACNO=3   RR=1   CTX_PC:

***** Microengine 4 Registers: *****
USTORE_DATA=0060024a      ALU_OUTPUT=0060024a
CTX_ENABLES=000012d4      CC_ENABLE=0009a90b
CTX_0_SIG_EVENTS=00090241  CTX_1_SIG_EVENTS=000ddb6c
CTX_2_SIG_EVENTS=00090241  CTX_3_SIG_EVENTS=00141df8
CTX_0_WAKEUP_EVENTS=00000000  CTX_1_WAKEUP_EVENTS=00000000
CTX_2_WAKEUP_EVENTS=006011a3  CTX_3_WAKEUP_EVENTS=00000000
CTX_ARB_CNTL=00600231
ACTIVE_CTX_STS:  SEG=1   ACNO=1   AB=0   ACTXPC: 38
245     CTX_0_STS:      SEG=1   ACNO=2   RR=0   CTX_PC:

15      CTX_1_STS:      SEG=0   ACNO=1   RR=1   CTX_PC:
75      CTX_2_STS:      SEG=0   ACNO=0   RR=0   CTX_PC:
132     CTX_3_STS:      SEG=1   ACNO=3   RR=1   CTX_PC:

***** Microengine 5 Registers: *****
USTORE_DATA=0060024a      ALU_OUTPUT=0060024a
CTX_ENABLES=000012d4      CC_ENABLE=0009a90b
CTX_0_SIG_EVENTS=00090241  CTX_1_SIG_EVENTS=000ddb6c
CTX_2_SIG_EVENTS=00090241  CTX_3_SIG_EVENTS=00141df8
CTX_0_WAKEUP_EVENTS=00000000  CTX_1_WAKEUP_EVENTS=00000000
CTX_2_WAKEUP_EVENTS=006011a3  CTX_3_WAKEUP_EVENTS=00000000
CTX_ARB_CNTL=00600231

```

```

ACTIVE_CTX_STS:  SEG=1  ACNO=1  AB=0  ACTXPC: 38
CTX_0_STS:       SEG=1  ACNO=2  RR=0  CTX_PC:
245
CTX_1_STS:       SEG=0  ACNO=1  RR=1  CTX_PC:
15
CTX_2_STS:       SEG=0  ACNO=0  RR=0  CTX_PC:
75
CTX_3_STS:       SEG=1  ACNO=3  RR=1  CTX_PC:
132

```

Report Date:03-01-23 Time:12:20:45

rlghncxa03w 03-01-23 08:43:14 EST EAGLE 30.0.0

STH: Received a BOOT IMT-obituary reply for 1 restart(s)

Card 1209 Module TKS\_SBFR.C Line 728 Class 01cc

User Data Dump (1 of 2): [Overall: 5 of 6]

```

0000 15a3a816 0012be0a 06000046 01080400 .....
0010 00a2342c 07f7b83a 15729dd2 05580601 .....
0020 1a22a616 7072b91a 46304a44 06887400 .....
0030 25a33b12 01a4ba22 17e03026 11483402 .....
0040 00130811 0033a30a 14008149 0cab6130 .....
0050 00000000 00000000 00000000 00000000 .....
0060 15a3a816 0012be0a 06000046 01080400 .....
0070 00a2342c 07f7b83a 15729dd2 05580601 .....
0080 1a22a616 7072b91a 46304a44 06887400 .....
0090 25a33b12 01a4ba22 17e03026 11483402 .....
00a0 00130811 0033a30a 14008149 0cab6130 .....
00b0 1a22a616 7072b91a 46304a44 06887400 .....
00c0 25a33b12 01a4ba22 17e03026 11483402 .....
00d0 00130811 0033a30a 14008149 0cab6130 .....
00e0 00000000 00000000 00000000 00000000 .....
00f0 15a3a816 0012be0a 06000046 01080400 .....
0100 00a2342c 07f7b83a 15729dd2 05580601 .....
0110 1a22a616 7072b91a 46304a44 06887400 .....
0120 25a33b12 01a4ba22 17e03026 11483402 .....
0130 25a33b12 01a4ba22 17e03026 11483402 .....
0140 00130811 0033a30a 14008149 0cab6130 .....
0150 00000000 00000000 00000000 00000000 .....
0160 15a3a816 0012be0a 06000046 01080400 .....
0170 00a2342c 07f7b83a 15729dd2 05580601 .....
0180 1a22a616 7072b91a 46304a44 06887400 .....
0190 25a33b12 01a4ba22 17e03026 11483402 .....
01a0 00130811 0033a30a 14008149 0cab6130 .....
01b0 1a22a616 7072b91a 46304a44 06887400 .....
01c0 25a33b12 01a4ba22 17e03026 11483402 .....

```

Report Date:03-01-23 Time:12:20:45

rlghncxa03w 03-01-23 08:43:14 EST EAGLE 30.0.0

STH: Received a BOOT IMT-obituary reply for 1 restart(s)

Card 1209 Module TKS\_SBFR.C Line 728 Class 01cc

User Data Dump (2 of 2): [Overall: 6 of 6]

```

0000 15a3a816 0012be0a 06000046 01080400 .....
0010 00a2342c 07f7b83a 15729dd2 05580601 .....
0020 1a22a616 7072b91a 46304a44 06887400 .....
0030 25a33b12 01a4ba22 17e03026 11483402 .....
0040 00130811 0033a30a 14008149 0cab6130 .....
0050 00000000 00000000 00000000 00000000 .....
0060 15a3a816 0012be0a 06000046 01080400 .....
0070 00a2342c 07f7b83a 15729dd2 05580601 .....
0080 1a22a616 7072b91a 46304a44 06887400 .....
0090 25a33b12 01a4ba22 17e03026 11483402 .....
00a0 00130811 0033a30a 14008149 0cab6130 .....

```

```

00b0 1a22a616 7072b91a 46304a44 06887400 .....
00c0 25a33b12 01a4ba22 17e03026 11483402 .....
00d0 00130811 0033a30a 14008149 0cab6130 .....
00e0 00000000 00000000 00000000 00000000 .....
00f0 15a3a816 0012be0a 06000046 01080400 .....
0100 00a2342c 07f7b83a 15729dd2 05580601 .....
0110 1a22a616 7072b91a 46304a44 06887400 .....
0120 25a33b12 01a4ba22 17e03026 11483402 .....
Report Date:03-01-23 Time:12:20:45
-----

```

;

**rtrv-obit:loc=1115**

Command Accepted - Processing

stdcfg1b 05-06-13 16:32:30 EST EAGLE 34.0.0  
NOTICE: Only 7 obit(s) to retrieve in the log.

;

stdcfg1b 05-06-13 16:32:30 EST EAGLE 34.0.0

-----  
STH: Received a BOOT IMT-Obituary reply for restart  
Card 1103 Module ATH\_386A.ASM Line 988 Class 0400

Register Dump :  
EFL=00000246 CS =0058 EIP=0041cf03 SS =0060  
EAX=00000046 ECX=00000000 EDX=005245d9 EBX=00000001  
ESP=00483f80 EBP=00483f88 ESI=00000000 EDI=00000000  
DS =0060 ES =0060 FS =0060 GS =0060

Stack Dump :  
[SP+1E]=0048 [SP+16]=0000 [SP+0E]=0041 [SP+06]=0000  
[SP+1C]=3fd0 [SP+14]=0001 [SP+0C]=cecc [SP+04]=0000  
[SP+1A]=0048 [SP+12]=0000 [SP+0A]=0048 [SP+02]=0041  
[SP+18]=3fbc [SP+10]=0a0a [SP+08]=3f9c [SP+00]=e600

Report Date:05-06-10 Time:19:20:55

;

stdcfg1b 05-06-13 16:32:31 EST EAGLE 34.0.0

-----  
STH: Received a BOOT IMT-Obituary reply for restart  
Card 1209 Module sds\_arm\_send Line 356 Class 0001  
StrongARM Core Register Dump (1 of 1): [Overall: 1 of 6]

SYSTEM MODE REGISTERS:  
r0 = 00116bd4 r1 = 00000164 r2 = 00000001 r3 = 00000003  
r4 = 00f5f3f0 r5 = 00000000 r6 = 0000001f r7 = 001251a0  
r8 = 00177be0 r9 = 10ffbfcc r10= 00118b74 r11= 00000000  
r12= 642b0002 sp = 000cffa8 lr = 00116b88 pc = 00102424  
cpsr=400000df

Register Dump 2 is empty

Report Date:05-06-13 Time:16:30:42

;

stdcfg1b 05-06-13 16:32:33 EST EAGLE 34.0.0

-----  
STH: Received a BOOT IMT-Obituary reply for restart  
Card 1209 Module sds\_arm\_send Line 356 Class 0001  
StrongARM Core Stack Dump (1 of 1): [Overall: 2 of 6]

```

SYSTEM MODE STACK (Length=192):
0000 00e00000 00000007 00e00000 00102ab0 .....*..
0010 00178698 00000000 000000f8 000cff08 .....
0020 00000001 00116bd4 00000164 00000001 ....k..d.....
0030 000cff68 00000000 00000000 0000001f h.....
0040 001251a0 00177be0 10ffbfcc 00118b74 .Q...{.....t...
0050 00000000 00102468 00000000 00000000 ....h$.....
0060 000cffa8 00116bd4 00000164 00000001 ....k..d.....
0070 00000003 00f5f3f0 00000000 0000001f .....
0080 001251a0 00177be0 10ffbfcc 00118b74 .Q...{.....t...
0090 00000000 642b0002 00116b88 00102424 .....+d.k..$$..
00a0 00000000 00000000 0000001f 00115e10 .....^..
00b0 00177c4c 00177bf0 0000001f 00125268 L|...{.....hR..

```

;

```

stdcfg1b 05-06-13 16:32:34 EST EAGLE 34.0.0
Stack Dump 2 is empty

```

```

Report Date:05-06-13 Time:16:30:42
-----

```

;

```

stdcfg1b 05-06-13 16:32:35 EST EAGLE 34.0.0
-----

```

```

STH: Received a BOOT IMT-Obituary reply for restart
Card 1209 Module sds_arm_send Line 356 Class 0001
User Data Dump (1 of 1): [Overall: 3 of 6]

```

```

User Data is empty

```

```

Report Date:05-06-13 Time:16:30:42
-----

```

;

```

stdcfg1b 05-06-13 16:32:36 EST EAGLE 34.0.0
-----

```

```

STH: Received a BOOT IMT-Obituary reply for restart
Card 1209 Module sds_arm_send Line 356 Class 0001
EP9312 Register Dump (1 of 2): [Overall: 4 of 6]

```

```

***** DMA Registers *****
DMA_CTRL_M2M0= 0608d40c DMA_INTR_STAT_M2M0= 00000000
DMA_STAT_M2M0= 00000000 DMA_BCR0_M2M0= 0608d40c
DMA_BASE_SRC0_M2M0= 00000000 DMA_CRNT_SRC0_M2M0= 00000000
DMA_BASE_DSTN0_M2M0= 00000000 DMA_CRNT_DSTN0_M2M0= 00000000
DMA_BCR1_M2M0= 000001fc DMA_BASE_SRC1_M2M0= 00000000
DMA_CRNT_SRC1_M2M0= 00000000 DMA_BASE_DSTN1_M2M0= 00000000
DMA_CRNT_DSTN1_M2M0= 00000000
DMA_CTRL_M2M1= 0608d40c DMA_INTR_STAT_M2M1= 00000000
DMA_STAT_M2M1= 00000000 DMA_BCR0_M2M1= 00000000
DMA_BASE_SRC0_M2M1= 00000000 DMA_CRNT_SRC0_M2M1= 00000000
DMA_BASE_DSTN0_M2M1= 00000000 DMA_CRNT_DSTN0_M2M1= 00000000
DMA_BCR1_M2M1= 00000000 DMA_BASE_SRC1_M2M1= 00000000
DMA_CRNT_SRC1_M2M1= 00000000 DMA_BASE_DSTN1_M2M1= 00000000
DMA_CRNT_DSTN1_M2M1= 00000000
DMA_ACTIVE_INTR= 00000000

```

```

***** TIMER Registers *****
TMR1_CURR_VALUE= 00000000 TMR1_CTRL_REG= 00000000
TMR1_LOAD_REG= 00000000 TMR2_CURR_VALUE= 00000000
TMR2_CTRL_REG= 00000000 TMR2_LOAD_REG= 00000000
TMR3_CURR_VALUE= 00000001 TMR3_CTRL_REG= 000000d5
TMR3_LOAD_REG= 00000001 TMR4_VALUE_LOW= 413c60f3
TMR4_VALUE_HI= 0000015f

```

```
***** SYSCON Registers *****
PWRSTS=          4320ace3      PWRCNT=          0c000000
CLKSET1=         00a5a127      CLKSET2=         0003c317
SCRATCH0=        00000040      SCRATCH1=        00000000
DEVCFG=          6902090e      CHIP_ID=         34009213
SYSCFG=          340000d6      APB_WAIT=        00000001
ARB_REG=         00000000      VID_REG=         00000000
MIR_REG=         00000000      I2S_REG=         00000000
TCH_REG=         00000000
```

```
***** GPIO Registers *****
PADR=            0000007f      PBDR=            000000e9
PCDR=            000000c0      PDDR=            000000c4
PEDR=            00000000      PFDR=            000000ff
PGDR=            00000002      PHDR=            0000007f
PADDR=           00000000      PBDDR=           00000009
PCDDR=           000000fb      PDDDR=           000000fb
PEDDR=           00000003      PFDDR=           00000000
PGDDR=           0000000c      PHDDR=           00000007
PA_TYPE1=        00000000      PB_TYPE1=        00000080
PF_TYPE1=        00000000      PA_TYPE2=        00000000
PB_TYPE2=        00000000      PF_TYPE2=        00000000
PA_INT_EN=       00000000      PB_INT_EN=       00000080
PF_INT_EN=       00000000      PA_RAW_STAT=     00000080
PB_RAW_STAT=     0000001f      PF_RAW_STAT=     00000000
PA_INT_STAT=     00000000      PB_INT_STAT=     00000000
PF_INT_STAT=     00000000      PA_DB=           00000000
PB_DB=           00000000      PF_DB=           00000000
EE_REG=          00000000
```

```
***** Coprocessor 15 Registers *
ID_CODE_CP15_0=  41129200      CACHE_CODE_CP15_0= 0d172172
CONTROL_CP15_1= c000107d      TRANS_BASE_TBL_CP15_2=10ffc000
DOMAIN_ACCESS_CP15_3= ffffffff  FAULT_STATUS_CP15_5= 0000000d
FAULT_PREFETCH_CP15_5=000000fa  FAULT_ADDR_CP15_6=  d3b765e8
CACHE_OPER_CP15_7= 00000000      TLB_OPER_CP15_8=   00000000
DCACHE_LOCKDN_CP15_9= 00000000      ICACHE_LOCKDN_CP15_9= 00000000
D_TLB_LOCKDN_CP15_10= 00b00000      I_TLB_LOCKDN_CP15_10= 00200000
FCSE_PID_CP15_13= 00000000
```

Report Date:05-06-13 Time:16:30:42

-----  
;
stdcfg1b 05-06-13 16:32:40 EST EAGLE 34.0.0  
-----

STH: Received a BOOT IMT-Obituary reply for restart  
Card 1209 Module sds\_arm\_send Line 356 Class 0001  
EP9312 Register Dump (2 of 2): [Overall: 5 of 6]

```
***** VIC Registers *****
VIC_1_IRQ_STATUS= 00000000      VIC_1_FIQ_STATUS= 00000000
VIC_1_RAW_INTR=   25000008      VIC_1_INT_SELECT= 00000000
VIC_1_INT_ENABLE= 00060000      VIC_1_SOFT_INT=   00000000
VIC_1_SOFT_INT_CLEAR= 00000000
VIC_2_IRQ_STATUS= 00000000      VIC_2_FIQ_STATUS= 00000000
VIC_2_RAW_INTR=   000021b      VIC_2_INT_SELECT= 00080000
VIC_2_INT_ENABLE= 08080004      VIC_2_SOFT_INT=   00000000
VIC_2_SOFT_INT_CLEAR= 00000000
```

```
***** SMC Registers *****
BANK_CONFIG0=     70001c80      BANK_CONFIG1=     70001420
BANK_CONFIG2=     40001480      BANK_CONFIG3=     70000400
```

```

BANK_CONFIG6=          70001440    BANK_CONFIG7=          70001440

***** UART3 Registers *****
LINE_CTRL_LOW=        00000003    LINE_CTRL_MID=        00000000
LINE_CTRL_HIGH=       00000074    CTRL_REG=             00000001
STATUS_REG=           00000000    FLAGS_REG=            00000090
DATA_REG=             00000020

***** Watchdog Registers *****
WDOG_REG=             00806c69

```

Report Date:05-06-13 Time:16:30:42

;

stdcfig1b 05-06-13 16:32:42 EST EAGLE 34.0.0

STH: Received a BOOT IMT-Obituary reply for restart  
Card 1209 Module sds\_arm\_send Line 356 Class 0001  
SIFB Register Dump (1 of 1): [Overall: 6 of 6]

```

***** BCM5630 Switch0 Registers *****
Switch0 Port0 Status= 00c06c00    Switch0 Port1 Status= 00c06c00
Switch0 Port2 Status= 00806c00    Switch0 Port3 Status= 00806c00
Switch0 Port4 Status= 00806c00    Switch0 Port5 Status= 00806c00
Switch0 Port6 Status= 00806c00    Switch0 Port7 Status= 00800000
Switch0 Port12 Status=00806c00

```

```

***** BCM5630 Switch1 Registers *****
Switch1 Port0 Status= 00806c00    Switch1 Port1 Status= 00806c00
Switch1 Port2 Status= 00806c00    Switch1 Port3 Status= 00806c00
Switch1 Port4 Status= 00806c00    Switch1 Port5 Status= 00806c00
Switch1 Port6 Status= 00806c00    Switch1 Port7 Status= 00806c00
Switch1 Port8 Status= 00806c00    Switch1 Port9 Status= 00806c00
Switch1 Port10 Status=00806c00    Switch1 Port11 Status=00800000
Switch1 Port12 Status=aaaaaa00

```

Report Date:05-06-13 Time:16:30:43

;

The following example shows output for seven obituaries from an IXP2350-based card.

**rtrv-obit:loc=1113**

tekelecstp 09-06-12 08:40:04 GMT EAGLE 41.1.0

STH: Received a BOOT IXP2350-Obituary reply for restart  
Card 1109 Module hiprop\_init. Line 489 Class 0001  
StrongARM Core Register Dump (1 of 1): [Overall: 1 of 7]

```

SYSTEM MODE REGISTERS:
r0= 00607964    r1= 000001e9    r2= 00000001    r3= 00000003
r4= 003dffec    r5= 00000000    r6= 42000360    r7= 0002c498
r8= 0000006f    r9= 90003c00    r10= 00606e54    r11= 00000000
r12= 00000000    sp= 003dff78    lr= 006079f4    pc= 00601ae4
cpsr=400000df

```

Register Dump 2 is empty

Report Date:09-06-12 Time:08:40:04

;

tekelecstp 09-06-12 08:40:05 GMT EAGLE 41.1.0

```

0007.0106      IMT BUS A                      IMT Bus alarm cleared
;

tekelecstp 09-06-12 08:40:07 GMT  EAGLE 41.1.0
-----
STH: Received a BOOT IXP2350-Obituary reply for restart
      Card 1109  Module hiprop_init.  Line 489  Class 0001
      StrongARM Core Stack Dump (1 of 1):  [Overall: 2 of 7]

SYSTEM MODE STACK (Length=132):
0000  00000000  00000000  00000001  003d0000  .....=.
0010  003dffec  00615b98  00000001  00606f00  ..=..[a.....o`.
0020  00000000  00000000  00000000  00000000  .....
0030  00000000  00000000  00000000  00000000  .....
0040  00000000  00000000  00000000  00000000  .....
0050  00000000  00000000  00000000  00000000  .....
0060  00000000  00000000  00000000  00000000  .....
0070  00000000  00000001  00000001  00000000  .....
0080  00000000  .....
;

tekelecstp 09-06-12 08:40:09 GMT  EAGLE 41.1.0
Stack Dump 2 is empty

Report Date:09-06-12  Time:08:40:04
-----
;

tekelecstp 09-06-12 08:40:10 GMT  EAGLE 41.1.0
-----
STH: Received a BOOT IXP2350-Obituary reply for restart
      Card 1109  Module hiprop_init.  Line 489  Class 0001
      User Data Dump (1 of 1):  [Overall: 3 of 7]

User Data is empty

Report Date:09-06-12  Time:08:40:04
-----
;

tekelecstp 09-06-12 08:40:12 GMT  EAGLE 41.1.0
-----
STH: Received a BOOT IXP2350-Obituary reply for restart
      Card 1109  Module hiprop_init.  Line 489  Class 0001
      IXP Register Dump (1 of 3):  [Overall: 4 of 7]

***** XSI SDRAM Registers *****
SDIR=                00730000  SDCR=                06553100
ESDCR=               93005001  SDBR=                008000b6
SBR0=                02000000  SBR1=                02000000
ECC=                 0f000000  ELOC0=               00000000
ELOC1=               00000000  ECAR_0=              00000000
ECAR_1=              00000000  ECTST=               00000000
MCISR=               00000000  MPTCR=               1c000000
MPCR=                00000000  RFR=                 8a000000
SDPR0=               01008002  SDPR1=               00000070
SDPR2=               0000ffa0  SDPR3=               0000fff8
SDPR4=               000000b0  SDPR5=               00000000
SDPR6=               00000000  SDPR7=               00000000
DDR_RCOMP_SETUP_CTRL= 60000000  PMOS_RCOMP_MEAS=    8f000000
NMOS_RCOMP_MEAS=     8f000005  PMOS_RCOMP_OVRD_REG_1= 00000016
NMOS_RCOMP_OVRD_REG_1= 00000000  PMOS_NMOS_SCOMP_OVRD_REG_1=002d0000
SLEW_RATE_INDEX_SEL= 39009b00  CTL_PMOS_PULL_UP_OFST= 0100005b
CTL_PMOS_PULL_DW_OFST= 01000000  CKE_PMOS_PULL_UP_OFST= 01000000

```

```

CKE_PMOS_PULL_DW_OFST=      01000000 CK_PMOS_PULL_UP_OFST=      01000000
CK_PMOS_PULL_DW_OFST=      01000000 DQ_PMOS_PULL_UP_OFST=      01000000
DQ_PMOS_PULL_DW_OFST=      01000000 PMOS_NMOS_RCOMP_OVRD_REG_1=00000000
PMOS_RCOMP_OVRD_REG_2=      00000000 NMOS_RCOMP_OVRD_REG_2=      00000000
PMOS_RCOMP_OVRD_REG_3=      00000000 NMOS_RCOMP_OVRD_REG_3=      00000000
PMOS_RCOMP_OVRD_REG_4=      00000000 NMOS_RCOMP_OVRD_REG_4=      00000000
PMOS_NMOS_SCOMP_OVRD_2=      00000000 CS_PMOS_PULL_UP_OFST=      01000000
CS_NMOS_PULL_DW_OFST=      01000000 RCVEN_PMOS_PULL_UP_OFST=    01000000
RCVEN_NMOS_PULL_DW_OFST=    01000000 GMII_PMOS_PULL_UP_OFST=    00000000
GMII_NMOS_PULL_DW_OFST=      00000000 SLEW_RATE_IDX_SEL_REG_2=    06000000
SETUP_AND_CTRL_REG=         00000000 DDR_ACIO_RX_DDL_SETTINGS=    13000000
DDR_RX_DESKEW=              13000013 DDR_RDDLSELEL_RECVEN=    13000000
    
```

\*\*\*\*\* MSG SDRAM Registers \*\*\*\*\*

```

SRAM_CONTROL=               00000000 SRAM_PARITY_STATUS_1=      00000028
SRAM_PARITY_STATUS_2=       00001f00 MSG_STAT=                   00000000
MSG_RET_STAT=               00000000 MSG_OVFL_INT_ENB=         00000000
    
```

\*\*\*\*\* COPROCESSOR Registers \*\*\*\*\*

```

ID_CHIP=                    05040500 CONTROL_CP15=              fd030066
TRANSLATION_TBL_BASE=       00ffff10 DOMAIN_ACCESS_CONTROL=    fd00ff80
FAULT_STATUS=               066000ff FAULT_ADDRESS=              c7000e04
PROC_ID_VIRTUAL_ADDR_MAPPING=0000000eb
    
```

Report Date:09-06-12 Time:08:40:04

tekelecstp 09-06-12 08:40:19 GMT EAGLE 41.1.0

STH: Received a BOOT IXP2350-Obituary reply for restart  
 Card 1109 Module hiprop\_init. Line 489 Class 0001  
 IXP Register Dump (2 of 3): [Overall: 5 of 7]

\*\*\*\*\* Microengine 0 Registers \*\*\*\*\*

```

USTORE_ERROR_STATUS=        02020202 ALU_OUTPUT=                02020202
CTX_ARB_CNTL=               02020202 CTX_ENABLES=                02020202
CC_ENABLE=                   02020202
INDIRECT_CTX_STS0:          SEG=0 ACNO=02 RR=0 CTX_PC=0064
INDIRECT_CTX_STS1:          SEG=0 ACNO=02 RR=0 CTX_PC=0064
INDIRECT_CTX_STS2:          SEG=0 ACNO=02 RR=0 CTX_PC=0064
INDIRECT_CTX_STS3:          SEG=0 ACNO=02 RR=0 CTX_PC=0064
INDIRECT_CTX_STS4:          SEG=0 ACNO=02 RR=0 CTX_PC=0064
INDIRECT_CTX_STS5:          SEG=0 ACNO=02 RR=0 CTX_PC=0064
INDIRECT_CTX_STS6:          SEG=0 ACNO=02 RR=0 CTX_PC=0064
INDIRECT_CTX_STS7:          SEG=0 ACNO=02 RR=0 CTX_PC=0064
ACTIVE_CTX_STS: SEG=0 ACNO=02 AB=0 ACTXPC=0064
INDIRECT_CTX_0_SIG_EVNT=    02020202 INDIRECT_CTX_1_SIG_EVNT=    02020202
INDIRECT_CTX_2_SIG_EVNT=    02020202 INDIRECT_CTX_3_SIG_EVNT=    02020202
INDIRECT_CTX_4_SIG_EVNT=    02020202 INDIRECT_CTX_5_SIG_EVNT=    02020202
INDIRECT_CTX_6_SIG_EVNT=    02020202 INDIRECT_CTX_7_SIG_EVNT=    02020202
ACTIVE_CTX_SIG_EVNT=        02020202 INDIRECT_CTX_0_WAKEUP_EVNT=02020202
INDIRECT_CTX_1_WAKEUP_EVNT= 02020202 INDIRECT_CTX_2_WAKEUP_EVNT=02020202
INDIRECT_CTX_3_WAKEUP_EVNT=02020202 INDIRECT_CTX_4_WAKEUP_EVNT=02020202
INDIRECT_CTX_5_WAKEUP_EVNT=02020202 INDIRECT_CTX_6_WAKEUP_EVNT=02020202
INDIRECT_CTX_7_WAKEUP_EVNT=02020202 ACTIVE_CTX_WAKEUP_EVNT=    02020202
    
```

\*\*\*\*\* Microengine 1 Registers \*\*\*\*\*

```

USTORE_ERROR_STATUS=        02020202 ALU_OUTPUT=                02020202
CTX_ARB_CNTL=               02020202 CTX_ENABLES=                02020202
CC_ENABLE=                   02020202
INDIRECT_CTX_STS0:          SEG=0 ACNO=02 RR=0 CTX_PC=0064
INDIRECT_CTX_STS1:          SEG=0 ACNO=02 RR=0 CTX_PC=0064
INDIRECT_CTX_STS2:          SEG=0 ACNO=02 RR=0 CTX_PC=0064
    
```



```

INDIRECT_CTX_STS3:      SEG=0  ACNO=02  RR=0  CTX_PC=0064
INDIRECT_CTX_STS4:      SEG=0  ACNO=02  RR=0  CTX_PC=0064
INDIRECT_CTX_STS5:      SEG=0  ACNO=02  RR=0  CTX_PC=0064
INDIRECT_CTX_STS6:      SEG=0  ACNO=02  RR=0  CTX_PC=0064
INDIRECT_CTX_STS7:      SEG=0  ACNO=02  RR=0  CTX_PC=0064
ACTIVE_CTX_STS:  SEG=0  ACNO=02  AB=0  ACTXPC=0064
INDIRECT_CTX_0_SIG_EVNT= 02020202  INDIRECT_CTX_1_SIG_EVNT= 02020202
INDIRECT_CTX_2_SIG_EVNT= 02020202  INDIRECT_CTX_3_SIG_EVNT= 02020202
INDIRECT_CTX_4_SIG_EVNT= 02020202  INDIRECT_CTX_5_SIG_EVNT= 02020202
INDIRECT_CTX_6_SIG_EVNT= 02020202  INDIRECT_CTX_7_SIG_EVNT= 02020202
ACTIVE_CTX_SIG_EVNT= 02020202  INDIRECT_CTX_0_WAKEUP_EVNT=02020202
INDIRECT_CTX_1_WKEUP_EVNT= 02020202  INDIRECT_CTX_2_WAKEUP_EVNT=02020202
INDIRECT_CTX_3_WAKEUP_EVNT=02020202  INDIRECT_CTX_4_WAKEUP_EVNT=02020202
INDIRECT_CTX_5_WAKEUP_EVNT=02020202  INDIRECT_CTX_6_WAKEUP_EVNT=02020202
INDIRECT_CTX_7_WAKEUP_EVNT=02020202  ACTIVE_CTX_WAKEUP_EVNT= 02020202

***** Microengine 2 Registers *****
USTORE_ERROR_STATUS= 02020202  ALU_OUTPUT= 02020202
CTX_ARB_CNTL= 02020202  CTX_ENABLES= 02020202
CC_ENABLE= 02020202
INDIRECT_CTX_STS0:      SEG=0  ACNO=02  RR=0  CTX_PC=0064
INDIRECT_CTX_STS1:      SEG=0  ACNO=02  RR=0  CTX_PC=0064
INDIRECT_CTX_STS2:      SEG=0  ACNO=02  RR=0  CTX_PC=0064
INDIRECT_CTX_STS3:      SEG=0  ACNO=02  RR=0  CTX_PC=0064
INDIRECT_CTX_STS4:      SEG=0  ACNO=02  RR=0  CTX_PC=0064
INDIRECT_CTX_STS5:      SEG=0  ACNO=02  RR=0  CTX_PC=0064
INDIRECT_CTX_STS6:      SEG=0  ACNO=02  RR=0  CTX_PC=0064
INDIRECT_CTX_STS7:      SEG=0  ACNO=02  RR=0  CTX_PC=0064
ACTIVE_CTX_STS:  SEG=0  ACNO=02  AB=0  ACTXPC=0064
INDIRECT_CTX_0_SIG_EVNT= 02020202  INDIRECT_CTX_1_SIG_EVNT= 02020202
INDIRECT_CTX_2_SIG_EVNT= 02020202  INDIRECT_CTX_3_SIG_EVNT= 02020202
INDIRECT_CTX_4_SIG_EVNT= 02020202  INDIRECT_CTX_5_SIG_EVNT= 02020202
INDIRECT_CTX_6_SIG_EVNT= 02020202  INDIRECT_CTX_7_SIG_EVNT= 02020202
ACTIVE_CTX_SIG_EVNT= 02020202  INDIRECT_CTX_0_WAKEUP_EVNT=02020202
INDIRECT_CTX_1_WKEUP_EVNT= 02020202  INDIRECT_CTX_2_WAKEUP_EVNT=02020202
INDIRECT_CTX_3_WAKEUP_EVNT=02020202  INDIRECT_CTX_4_WAKEUP_EVNT=02020202
INDIRECT_CTX_5_WAKEUP_EVNT=02020202  INDIRECT_CTX_6_WAKEUP_EVNT=cc000002
INDIRECT_CTX_7_WAKEUP_EVNT=cc0000cc  ACTIVE_CTX_WAKEUP_EVNT= cc0001cc
IXP Register Dump (2 of 2):  [Overall: 2 of 2]
    
```

Report Date:09-06-12 Time:08:40:04

-----  
;
  
tekelecstp 09-06-12 08:40:31 GMT EAGLE 41.1.0

-----  
STH: Received a BOOT IXP2350-Obituary reply for restart  
Card 1109 Module hiprop\_init. Line 489 Class 0001  
IXP Register Dump (3 of 3): [Overall: 6 of 7]

```

***** Microengine 3 Registers *****
USTORE_ERROR_STATUS= 02020202  ALU_OUTPUT= 02020202
CTX_ARB_CNTL= 02020202  CTX_ENABLES= 02020202
CC_ENABLE= 02020202
INDIRECT_CTX_STS0:      SEG=0  ACNO=02  RR=0  CTX_PC=0064
INDIRECT_CTX_STS1:      SEG=0  ACNO=02  RR=0  CTX_PC=0064
INDIRECT_CTX_STS2:      SEG=0  ACNO=02  RR=0  CTX_PC=0064
INDIRECT_CTX_STS3:      SEG=0  ACNO=02  RR=0  CTX_PC=0064
INDIRECT_CTX_STS4:      SEG=0  ACNO=02  RR=0  CTX_PC=0064
INDIRECT_CTX_STS5:      SEG=0  ACNO=02  RR=0  CTX_PC=0064
INDIRECT_CTX_STS6:      SEG=0  ACNO=02  RR=0  CTX_PC=0064
INDIRECT_CTX_STS7:      SEG=0  ACNO=02  RR=0  CTX_PC=0064
ACTIVE_CTX_STS:  SEG=0  ACNO=02  AB=0  ACTXPC=0064
INDIRECT_CTX_0_SIG_EVNT= 02020202  INDIRECT_CTX_1_SIG_EVNT= 02020202
    
```

```

INDIRECT_CTX_2_SIG_EVNT= 02020202 INDIRECT_CTX_3_SIG_EVNT= 02020202
INDIRECT_CTX_4_SIG_EVNT= 02020202 INDIRECT_CTX_5_SIG_EVNT= 02020202
INDIRECT_CTX_6_SIG_EVNT= 02020202 INDIRECT_CTX_7_SIG_EVNT= 02020202
ACTIVE_CTX_SIG_EVNT= 02020202 INDIRECT_CTX_0_WAKEUP_EVNT=02020202
INDIRECT_CTX_1_WAKEUP_EVNT= 02020202 INDIRECT_CTX_2_WAKEUP_EVNT=02020202
INDIRECT_CTX_3_WAKEUP_EVNT=02020202 INDIRECT_CTX_4_WAKEUP_EVNT=02020202
INDIRECT_CTX_5_WAKEUP_EVNT=02020202 INDIRECT_CTX_6_WAKEUP_EVNT=02020202
INDIRECT_CTX_7_WAKEUP_EVNT=02020202 ACTIVE_CTX_WAKEUP_EVNT= 02020202

```

\*\*\*\*\* DDR SDRAM Registers \*\*\*\*\*

```

DU_CONTROL= 04031000 DU_ERROR_STATUS_1= 20018544
DU_ERROR_STATUS_2= a3003426 DU_ECC_TEST= 00000000
DU_INIT= 00000100 DU_CNTR_2= 38000000
DDR_RCOMP_CSR= 60000000 PMOS_RCOMP_MEAS= 8f000000
NMOS_RCOMP_MEAS= 9f000005 PMOS_RCOMP_OVRD_REG_1= 00000016
NMOS_RCOMP_OVRD_REG_1= 00000000 PMOS_NMOS_SCOMP_OVRD_1= 002d0000
SLEW_RATE_IDX_SEL_REG_1= 39009c00 CTL_PMOS_PULL_UP_OFST= 010000db
CTL_PMOS_PULL_DW_OFST= 01000000 CKE_PMOS_PULL_UP_OFST= 01000000
CKE_NMOS_PULL_DW_OFST= 01000000 CK_PMOS_PULL_UP_OFST= 01000000
CK_NMOS_PULL_DW_OFST= 01000000 DQ_PMOS_PULL_UP_OFST= 01000000
DQ_NMOS_PULL_DW_OFST= 01000000 PMOS_NMOS_RCOMP_OVRD= 00000000
PMOS_RCOMP_OVRD_REG_2= 00000000 NMOS_RCOMP_OVRD_REG_2= 00000000
PMOS_RCOMP_OVRD_REG_3= 00000000 NMOS_RCOMP_OVRD_REG_3= 00000000
PMOS_RCOMP_OVRD_REG_4= 00000000 NMOS_RCOMP_OVRD_REG_4= 00000000
PMOS_NMOS_SCOMP_OVRD_2= 00000000 RCVEN_PMOS_PULL_UP_OFST= 01000000
RCVEN_NMOS_PULL_DW_OFST= 01000000 GMII_PMOS_PULL_UP_OFST= 01000000
GMII_NMOS_PULL_DW_OFST= 01000000 SLEW_RATE_IDX_SEL_REG_2= 06000000
SETUP_AND_CTRL_REG= 00000000 DDR_ACIO_RX_DDL_SETTINGS= 13000000
DDR_RX_DESKEW= 13000013 DDR_RDDLSESEL_RECVEN= 13000000

```

Report Date:09-06-12 Time:08:40:04

;

tekelecstp 09-06-12 08:40:31 GMT EAGLE 41.1.0

```

STH: Received a BOOT IXP2350-Obituary reply for restart
Card 1109 Module hiprop_init. Line 489 Class 0001
Instruction Trace Dump (1 of 1): [Overall: 7 of 7]

```

Length: 415

```

0000 02 02 02 02 02 02 02 02 02 02 02 02 02 02 02 02 .....
0010 02 02 02 02 02 02 02 02 02 02 02 02 02 02 02 .....
0020 02 02 02 02 02 02 02 02 02 02 02 02 02 02 02 .....
0030 02 02 02 02 02 02 02 02 02 02 02 02 02 02 02 .....
0040 02 02 02 02 02 02 02 02 02 02 02 02 02 02 02 .....
0050 02 02 02 02 02 02 02 02 02 02 02 02 02 02 02 .....
0060 02 02 02 02 02 02 02 02 02 02 02 02 02 02 02 .....
0070 02 02 02 02 02 02 02 02 02 02 02 02 02 02 02 .....
0080 02 02 02 02 02 02 02 02 02 02 02 02 02 02 02 .....
0090 02 02 02 02 02 02 02 02 02 02 02 02 02 02 02 .....
00a0 02 02 02 02 02 02 02 02 02 02 02 02 02 02 02 .....
00b0 02 02 02 02 02 02 02 02 02 02 02 02 02 02 02 .....
00c0 02 02 02 02 02 02 02 02 02 02 02 02 02 02 02 .....
00d0 02 02 02 02 02 02 02 02 02 02 02 02 02 02 02 .....
00e0 02 02 02 02 02 02 02 02 02 02 02 02 02 02 02 .....
00f0 02 02 02 02 02 02 02 02 02 02 02 02 02 02 02 .....
0100 02 02 02 02 02 02 02 02 02 02 02 02 02 02 02 .....
0110 02 02 02 02 02 02 02 02 02 02 02 02 02 02 02 .....
0120 02 02 02 02 02 02 02 02 02 02 02 02 02 02 02 .....
0130 02 02 02 02 02 02 02 02 02 02 02 02 02 02 02 .....
0140 02 02 02 02 02 02 02 02 02 02 02 02 02 02 02 .....
0150 02 02 02 02 02 02 02 02 02 02 02 02 02 02 02 .....
0160 02 02 02 02 02 02 02 02 02 02 02 02 02 02 02 .....

```

```
0170 02 00 00 cc cc 00 00 cc cc 01 00 cc cc 00 00 cc .....
0180 cc 00 00 cc cc 58 fa 12 00 0a b8 6d 00 6c fd 12 .....X.....m.l..
0190 00 fa 00 00 00 00 70 fd 7f cc cc cc cc cc cc .....p.....
```

Report Date:09-06-12 Time:08:40:04

i

**rtrv-ppsopts**

**Retrieve Prepaid SMS Options**

Use this command to display Prepaid Short Message Service options from the PPSOPTS table.

**Keyword:** rtrv-ppsopts

**Related Commands:** chg-ppsopts

**Command Class:** Database Administration

**Parameters**

**:ppt=** (optional)

Prepaid portability type. This parameter specifies an IN platform.

**Range:** 1-32

**Example**

```
rtrv-ppsopts
```

```
rtrv-ppsopts:ppt=2
```

**Dependencies**

The Prepaid SMS Intercept Ph1, IDP A-Party Routing, or IDP Service Key Routing feature must be enabled and turned on before this command can be entered.

**Output**

Set ID values are displayed only if the Flexible GTT Load Sharing (FGTTLS) feature is enabled. The following example displays Prepaid SMS options for a specific Prepaid Type.

**rtrv-ppsopts:ppt=1**

tekelecstp 08-12-17 15:07:01 EST EAGLE 40.1.0

Prepaid SMS Options

```

-----
BPARTYCHK          = OFF
PPT      PCA/PCI/PCN          SSN   RI
---      -
1        PCI:    1-001-1      1     GT
    
```

;

The following example displays Prepaid SMS options for all Prepaid Types.

**rtrv-ppsopts**

tekelecstp 08-12-17 15:11:22 EST EAGLE 40.1.0

Prepaid SMS Options

```

-----
BPARTYCHK          = OFF
PPT      PCA/PCI/PCN          SSN   RI
---      -
1        PCI:    1-001-1      1     GT
2        PCI:    1-001-2      1     SSN
3        -----          NONE  GT
4        -----          NONE  GT
5        -----          NONE  GT
6        -----          NONE  GT
7        -----          NONE  GT
8        -----          NONE  GT
9        -----          NONE  GT
10       -----          NONE  GT
11       -----          NONE  GT
12       -----          NONE  GT
13       -----          NONE  GT
14       -----          NONE  GT
15       -----          NONE  GT
16       -----          NONE  GT
17       -----          NONE  GT
18       -----          NONE  GT
19       -----          NONE  GT
20       -----          NONE  GT
21       -----          NONE  GT
22       -----          NONE  GT
23       -----          NONE  GT
24       -----          NONE  GT
25       -----          NONE  GT
26       -----          NONE  GT
27       -----          NONE  GT
28       -----          NONE  GT
29       -----          NONE  GT
30       -----          NONE  GT
31       -----          NONE  GT
32       -----          NONE  GT
    
```

```

GTA
---
1110
1111
NONE
NONE
    
```



|    |       |      |    |      |
|----|-------|------|----|------|
| 11 | ----- | NONE | GT | DFLT |
| 12 | ----- | NONE | GT | DFLT |
| 13 | ----- | NONE | GT | DFLT |
| 14 | ----- | NONE | GT | DFLT |
| 15 | ----- | NONE | GT | DFLT |
| 16 | ----- | NONE | GT | DFLT |
| 17 | ----- | NONE | GT | DFLT |
| 18 | ----- | NONE | GT | DFLT |
| 19 | ----- | NONE | GT | DFLT |
| 20 | ----- | NONE | GT | DFLT |
| 21 | ----- | NONE | GT | DFLT |
| 22 | ----- | NONE | GT | DFLT |
| 23 | ----- | NONE | GT | DFLT |
| 24 | ----- | NONE | GT | DFLT |
| 25 | ----- | NONE | GT | DFLT |
| 26 | ----- | NONE | GT | DFLT |
| 27 | ----- | NONE | GT | DFLT |
| 28 | ----- | NONE | GT | DFLT |
| 29 | ----- | NONE | GT | DFLT |
| 30 | ----- | NONE | GT | DFLT |
| 31 | ----- | NONE | GT | DFLT |
| 32 | ----- | NONE | GT | DFLT |

GTA

---

1122

NONE

NONE

NONE

NONE

NONE

NONE

NONE

NONE

NONE

NONE

NONE

NONE

NONE

NONE

NONE

NONE

NONE

NONE

NONE

NONE

NONE

NONE

NONE

NONE

NONE

NONE

NONE

NONE

NONE

NONE

;

**Legend**

- **PPT**—Prepaid Portability Type
- **PCI**—An ITU international point code for an IN platform

- **PCN**—An ITU national point code for an IN platform
- **RI**—A routing indicator for an IN platform
- **SETID**—Specifies the MAP Set ID or MRN Set ID based on the RI value
- **GTA**—Entity addresses for up to 32 IN platforms. An unprovisioned GTA has a value of **none**.
- **SSN**—Subsystem Number.

## rtrv-prefix

## Retrieve Prefix

Use this command to retrieve provisioned prefix information for all supported features or for a specified feature.

**Keyword:** rtrv-prefix

**Related Commands:** chg-prefix, dlt-prefix, rtrv-ctrl-feat

**Command Class:** Database Administration

### Parameters

**:feature=** (optional)

Feature Name. This parameter specifies the name of an enabled controlled feature that is supported by this command. The parameter value must match the feature name as it is displayed in the **rtrv-ctrl-feat** command output.

**Range:** *abcdefghijklmnopqrstuvwxyz*

1 alphabetic character and up to 24 optional alphanumeric characters and spaces, enclosed in double quotation marks.

The parameter value is not case-sensitive; upper case or lower case or both can be entered.

Part or all of the feature name can be entered. If part of the feature name is specified, the entry must start with the first letter of the name, and must contain enough of the name to uniquely identify the feature. For example, there are two feature names that begin with "GSM MAP." Enough additional characters to identify which GSM MAP feature is being entered (at least "GSM MAP SR" to identify the "GSM MAP SRI Redirect" feature). This command supports the following controlled features:

- GSM MAP SRI Redirect
- ISUP NP for EPAP

### Example

Retrieve provisioned prefix information for all supported features.

```
rtrv-prefix
```

Retrieve prefix information for the GSM MAP SRI Redirect feature.

```
rtrv-prefix:feature="GSM MAP SRI Redirect"
```

### Dependencies

The specified feature name must be the name of an enabled controlled feature as it is displayed in the **rtrv-ctrl-feat** command output. The following controlled features are supported by this command:

- GSM MAP SRI Redirect

- ISUP NP for EPAP

### Notes

None

### Output

For all features, retrieve the provisioned prefix information. There is additional information displayed in the function column for prefix numbers 6 and 7 of the “ISUP NP with EPAP” feature.

#### rtrv-prefix

```
rlghncxa03w 04-09-20 09:04:14 EST EAGLE 34.1.0
```

| Feature              | NUM | Prefix | Function               |
|----------------------|-----|--------|------------------------|
| GSM MAP SRI Redirect | 1   | 1a1a   |                        |
| GSM MAP SRI Redirect | 2   | ffff   |                        |
| GSM MAP SRI Redirect | 3   | 1234   |                        |
| ISUP NP with EPAP    | 1   | 3b4c   |                        |
| ISUP NP with EPAP    | 6   | 886    | Insertion Country Code |
| ISUP NP with EPAP    | 7   | 0      | Deletion Condition     |

```
FEATPFX table is (6 of 256) 2% full
```

;

For the “GSM MAP SRI Redirect” feature, retrieve the provisioned prefix information. The table capacity for the total number of entries in use is reported, not just the number of entries displayed. There is no additional information displayed in the Function column for this feature.

#### rtrv-prefix:feature="GSM MAP SRI Redirect"

```
rlghncxa03w 04-09-20 09:04:14 EST EAGLE 31.11.0
```

| Feature              | NUM | Prefix | Function |
|----------------------|-----|--------|----------|
| GSM MAP SRI Redirect | 1   | 1a1a   |          |
| GSM MAP SRI Redirect | 2   | ffff   |          |
| GSM MAP SRI Redirect | 3   | 1234   |          |

```
FEATPFX table is (6 of 256) 2% full
```

;

## rtrv-rmt-appl

### Retrieve Remote Application

Use this command to retrieve a list of remote application assignments.

**Keyword:** rtrv-rmt-appl

**Related Commands:** dlt-rmt-appl, ent-rmt-appl

**Command Class:** Database Administration

### Parameters

This command has no parameters.

### Example

```
rtrv-rmt-appl
```

### Dependencies

None



**Notes**

None

**Output**

**rtrv-rmt-appl**

```
rlghncxa03w 05-01-07 12:05:33 EST EAGLE 31.12.0
  IPCA          SI SSN
  003-003-003  3 100, 110-119, 200
                5
  IPCI          SI SSN
  3-003-3      3 5, 50-100, 250
                5

  IPCN          SI SSN
  16380        3 250
                5

  IPCN24        SI SSN
  100-200-100  5
```

;

**rtrv-rmt-appl**

```
rlghncxa03w 05-01-07 12:05:33 EST EAGLE 31.12.0
  IPCA          SI SSN
  p-001-001-001 3 5-102

  IPCI          SI SSN
  ps-2-002-2    5

  IPCN          SI SSN
  s-16380       3 250

  IPCN24        SI SSN
```

;

**Legend**

**IPC/IPCA/IPCI/PCN/PCN24**—End node's internal point code.

**SI**—Service indicator value that designates which user part is assigned to the IPC.

**SSN**—SCCP subsystem number.

Point code subtype prefixes—

- s-** Spare point code
- p-** Private point code
- ps-** Private and spare point code

**rtrv-rte**

**Retrieve Route**

This command is used to display the parameter information for the route entries in the database.

Asterisks can be specified to select and display only point codes that have the same point code subfields. See the "Notes" section for this command for details.

**Keyword:** rtrv-rte

**Related Commands:** chg-dstn,, dlt-dstn, dlt-rte, ent-dstn, ent-rte, rept-stat-dstn, rept-stat-rte, rtrv-dstn

**Command Class:** Database Administration

### Parameters

**NOTE:** See "Point Code Formats and Conversion" for a detailed description of point code formats, rules for specification, and examples.

**:cli=** (optional)

Common Language Location Identifier. This parameter specifies the Common Language Location Identifier assigned to the link.

**Range:** ayyyyyyyyyy  
1 alphabetic character followed by 10 alphanumeric characters

**Default:** No value given

**:dpc=** (optional)

ANSI destination point code with subfields network indicator-network cluster-network cluster member (*ni-nc-ncm*). The *prefix* subfield indicates a private point code (*prefix-ni-nc-ncm*).

**Synonym:** dpca

**Range:** p-, 000-255, \*, \*\*, \*\*\*  
Specify a valid value for each subfield of the point code, and separate the subfields with a dash (-).

*prefix*—p-

The asterisk values \*, \*\*, and \*\*\* are not valid for the *ni* subfield.

If \*\* or \*\*\* is specified for the *nc* subfield, either \*, \*\*, or \*\*\* must be specified for the *ncm* subfield.

When **chg-sid:pctype=ansi** is specified, *ni* = 000 is not valid.

When **chg-sid:pctype=ansi** is specified, *nc* = 000 is not valid if *ni* = 001-005.

When **chg-sid:pctype=ansi** is specified, *nc* = 000 is valid if *ni* = 006-255.

When **chg-sid:pctype=ansi** is specified, *ni*-\*- is valid if *ni* = 006-255.

The point code 000-000-000 is not a valid point code.

**:dpc/dpca/dpci/dpcn/dpcn24=** (optional)

Destination point code.

**:dpci=** (optional)

ITU international point code with subfields *zone-area-id*. The *prefix* subfield indicates a spare point code, private point code, or private and spare point code (*prefix-zone-area-id*).

**Range:** s-, p-, ps-, 0-255  
Specify a valid value for each subfield of the point code, and separate the subfields with a dash (-).

*prefix*—s-, p-, ps-

*zone*—0-7

*area*—000-255

*id*—0-7

The point code 0-000-0 is not a valid point code.

**:dpcn=** (optional)

ITU national point code in the format of a 5-digit number (*nnnnn*); or 2, 3, or 4 numbers (members) separated by dashes (*m1-m2-m3-m4*) as defined by the **chg-stpopts:npcfmti** flexible point code

option. A group code must be specified when the ITUDUPPC feature is turned on (*nnnnn-gc, m1-m2-m3-m4-gc*). The *prefix* subfield indicates a spare point code, private point code, or private and spare point code (*prefix-nnnnn, prefix-nnnnn-gc, prefix-m1-m2-m3-m4, prefix-m1-m2-m3-m4-gc*).

**Range:** **s-, p-, ps-, 0-16383, aa-zz, \***

Specify a valid value for each subfield of the point code, and separate the subfields with a dash (-).

An asterisk (\*) can be specified for the node (*nnnnn* or every member of a flexible point code) or for the group code (*gc*) only when group codes are present in the point codes.

An asterisk (\*) can be specified either for the node or for the group code, but not both.

*prefix*—**s-, p-, ps-**

*nnnnn*—**0-16383, \***

*gc*—**aa-zz, \***

*m1-m2-m3-m4*—**0-14** for each member; values must sum to 14; or **\*-\*-\*** when the point code includes a group code.

**:dpcn24=** (optional)

24-bit ITU national point code with subfields *main signaling area-sub signaling area-signaling point (msa-ssa-sp)*. The *prefix* indicates a private point code (*prefix-msa-ssa-sp*).

**Range:** **p-, 000-255**

Specify a valid value for each subfield of the point code, and separate the subfields with a dash (-).

*prefix*—**p-**

*msa*—**000-255**

*ssa*—**000-255**

*sp*—**000-255**

**:lsn=** (optional)

Linkset name

**Range:** *ayyyyyyyyy*

1 alphabetic character followed by up to 9 alphanumeric characters

**Default:** Display all

**:mode=** (optional)

This parameter displays the method used to display the output report.

**Range:** **full**

**:pcst=** (optional)

Point code subtype. If selected, this parameter causes the command to display only the point codes that have no subtype prefix, or display only the point codes that have the specified subtype prefix.

**Range:** **none, s, p, ps**

**none** — Display all point codes that do not have subtype prefixes

**s** — Display only spare point codes

**p** — Display only private point codes

**ps** — Display only private and spare point codes

**:pctype=** (optional)

Point code domain. This parameter causes the command to display only the point codes of the specified domain type.

**Range:** **ansi, itui, itun, itun24**

## Example

```
rtrv-rte
```

```

rtrv-rte:dpc=240-012-004:lsn=ls000001
rtrv-rte:clli=dp1:lsn=ls000001
rtrv-rte:dpc=140-012-008
rtrv-rte:clli=dp1rtrv-rte
rtrv-rte:dpcn=3-15-15-15-fr
rtrv-rte:lsn=elm3itun
rtrv-rte:dpcn24=10-100-14
rtrv-rte:pcst=s
rtrv-rte:pcst=none
rtrv-rte:pctype=ansi
rtrv-rte:pctype=itun24:pcst=none
rtrv-rte:dpc=1-1-**
rtrv-rte:dpc=1-1-***
rtrv-rte:dpc=1-**-*
rtrv-rte:dpc=1-***-*
rtrv-rte:dpc=1-***-*:lsn=ab64
rtrv-rte:dpc=1-***-*:lsn=xx64
rtrv-rte:dpcn=1000-*
rtrv-rte:dpcn=1000-*:lsn=dpcn64
rtrv-rte:dpcn=p-*aa
rtrv-rte:dpcn=s-9000-*

```

### Dependencies

The value of the **dcp/dpca/dpci/dpcn/dpcn24** parameter must exist in the Destination Point Code table.

The value specified for the **lsn** parameter must exist in the routeset of the destination if the **dpc** parameter is specified.

If the **dpcn** parameter is specified, its format must match the format that was assigned with the **chg-stpopts** command **npcfmti** parameter.

If the **pctype** parameter has a value of **ansi** or **itun24**, then the **pcst** parameter cannot have a value of **s** or **ps**.

The **pctype** and **pcst** parameters cannot be specified in the same command with the destination point code, alias point code, secondary point code, **clli**, **msar=only**, and **ncai** parameters.

The NRT feature must be turned on before the **dcp/dpca/dpci/dpcn/dpcn24** parameter can be specified.

When using network routing, if the destination point code has a value of \* in the NC field, the NCM field must also be \* (for example, **dpc=21-\*-\***).

The value of the **dcp/dpca/dpci/dpcn/dpcn24** parameter must be a valid point code.

If the **clli** parameter is specified, then the value must exist in the Route table.

All link sets currently assigned to a route set must still be equipped.

All link sets must be defined in the route set.

The value specified for the **lsn** parameter must already be assigned to the specified routeset.

## Notes

This command can be canceled using the **F9** function key or the **canc-cmd** command. See **canc-cmd** for more information.

In this command, only ITU-international and ITU national point codes support the spare point code subtype prefix (**s-**) and the private and spare point code subtype prefix (**ps-**). All of the point code types support the private (internal) point code subtype prefix (**p-**).

### *Asterisks in ANSI Point Codes*

Two asterisks in the *ncm* subfield of a cluster point code produces a summary report that shows all point code destinations residing in the given cluster (for example, **20-2-\*\***). This does not include the specified cluster point code (for example, **20-2-\***).

Three asterisks in the *ncm* subfield of a cluster point code (for example, **20-2-\*\*\***) produces a summary report that shows all point code destinations residing in the given network cluster. The specified cluster point code is also displayed if it exists.

If the linkset name is specified (**lsn** parameter) and the **dpc/dpca** parameter *ncm* subfield is specified with asterisks, all route entries are displayed that have the specified linkset and that match the specified **dpc/dpca** parameter subfield values.

### *Asterisks in ITU-N Duplicate Point Codes and Flexible Format Point Codes*

When the ITU Duplicate Point Code (ITUDUPPC) feature is on,

- An asterisk (\*) can be specified for the group code of an ITU-N duplicate point code to display all ITU-N point codes that have the specified node value (for example, **10101-\***).
- An asterisk (\*) can be specified for the node of an ITU-N duplicate point code to display all ITU-N point codes that have the specified group code value (for example, **\*-ab**).

When the ITUDUPPC feature is on and the STP flexible point code option (**npcfmti**) is used to change the ITU-N point format to four members (*m1-m2-m3-m4-gc*),

- An asterisk (\*) can be specified for the group code of an ITU-N flexible point code to display all ITU-N point codes that have the specified point code value (for example, **15-15-15-3-\***).
- An asterisk (\*) can be specified for every member of the ITU-N flexible point code to display all ITU-N flexible point codes that have the same group code (for example, **\*-\*-\*-ab** is valid; **\*-15-\*-\*-ab** is not valid).

**Output**

In the **rtrv-rte** command output examples, the point code prefixes **s-**, **p-**, and **ps-** indicate that the point code is a spare point code, a private point code, or a private and spare point, respectively.

Abbreviated output is indicated by 3 vertical dots as shown:

.  
.
  
.

The following example displays the output when the Route table is provisioned. This example displays abbreviated output.

**rtrv-rte**

eagle10115 08-12-09 10:00:37 EST EAGLE 40.1.0

| DPCA          | ALIASI    | ALIASN/N24<br>LSN | RTX<br>RC | CLLI<br>APCA |
|---------------|-----------|-------------------|-----------|--------------|
| 001-001-000   | -----     | -----             | No        | stp1         |
|               |           | e2e1              | 10        | 001-001-000  |
| 003-001-000   | -----     | -----             | No        | mstp         |
|               |           | e2e3              | 10        | 003-001-000  |
| 004-001-000   | -----     | -----             | No        | stp4         |
|               |           | e2e4              | 10        | 004-001-000  |
| 007-001-000   | -----     | -----             | No        | stp7         |
|               |           | e2e7              | 10        | 007-001-000  |
| 002-101-001   | -----     | -----             | No        | ssp201       |
|               |           | e2m1s1            | 10        | 002-101-001  |
|               |           | e2e3              | 20        | 003-001-000  |
| 002-102-001   | -----     | -----             | No        | ssp202       |
|               |           | e2m1s2            | 10        | 002-102-001  |
|               |           | e2e3              | 20        | 003-001-000  |
| 001-101-001   | -----     | -----             | No        | ssp101       |
|               |           | e2e1              | 10        | 001-001-000  |
|               |           | e2e4              | 20        | 004-001-000  |
|               |           | e2e3              | 30        | 003-001-000  |
| .             |           |                   |           |              |
| .             |           |                   |           |              |
| .             |           |                   |           |              |
| 200-200-*     | -----     | -----             | No        | cluster2     |
| 005-006-001   | -----     | 005-006-001       | No        | -----        |
| 001-001-001   | -----     | -----             | No        | dstn01       |
|               |           | lsn01             | 10        | 001-001-001  |
| p-001-001-001 | -----     | -----             | No        | dstn01p      |
| 001-001-002   | 1-001-2   | -----             | No        | dstn02       |
|               |           | lsn02             | 10        | 001-001-002  |
| p-001-001-002 | 1-011-2   | -----             | No        | dstn02p      |
| 001-001-003   | s-1-001-3 | -----             | No        | dstn03       |
|               |           | lsn03             | 10        | 001-001-003  |
| p-001-001-003 | s-1-011-3 | -----             | No        | dstn03p      |
| 001-001-004   | -----     | 02060-aa          | No        | dstn04       |
|               |           | lsn04             | 10        | 001-001-004  |
| p-001-001-004 | -----     | 01060-aa          | No        | dstn04p      |
| 001-070-001   | -----     | -----             | No        | tgtansi001   |
|               |           | lsn01             | 10        | 001-001-001  |
|               |           | lsn02             | 20        | 001-001-002  |
|               |           | lsn03             | 30        | 001-001-003  |
|               |           | lsn04             | 40        | 001-001-004  |
| .             |           |                   |           |              |
| .             |           |                   |           |              |
| .             |           |                   |           |              |
| 200-002-001   | -----     | -----             | Yes       | rtxroute001  |
|               |           | lsn12             | 10        | 001-002-004  |

Commands

rtrv-rte

|             |             |             |     |             |
|-------------|-------------|-------------|-----|-------------|
| 040-001-*   | -----       | -----       | No  | myncaibeno  |
| 040-010-*   | -----       | -----       | No  | myncaibeno2 |
| 010-*-*     | -----       | -----       | No  | -----       |
| 040-*-*     | -----       | -----       | No  | -----       |
| 040-001-001 | -----       | -----       | No  | noncluster1 |
| 040-001-002 | -----       | -----       | No  | noncluster2 |
| DPCI        | ALIASA      | ALIASN/N24  | RTX | CLLI        |
|             |             | LSN         | RC  | APCI        |
| s-4-002-0   | 010-001-001 | s-08228-aa  | No  | -----       |
| 2-010-0     | -----       | -----       | No  | dstn13      |
|             |             | lsn13       | 10  | 2-010-0     |
| p-2-010-0   | -----       | -----       | No  | dstn13p     |
| 2-010-1     | 002-010-001 | -----       | No  | dstn14      |
|             |             | lsn14       | 10  | 2-010-1     |
| p-2-010-1   | 002-100-001 | -----       | No  | dstn14p     |
| 2-010-2     | -----       | 04178-aa    | No  | dstn15      |
|             |             | lsn15       | 10  | 2-010-2     |
| p-2-010-2   | -----       | 08178-aa    | No  | dstn15p     |
| 2-010-3     | -----       | s-04179-aa  | No  | dstn16      |
|             |             | lsn16       | 10  | 2-010-3     |
| p-2-010-3   | -----       | s-08179-aa  | No  | dstn16p     |
| 2-070-1     | -----       | -----       | No  | tgtitui001  |
|             |             | lsn13       | 10  | 2-010-0     |
|             |             | lsn14       | 20  | 2-010-1     |
|             |             | lsn15       | 30  | 2-010-2     |
|             |             | lsn16       | 40  | 2-010-3     |
| 2-010-4     | -----       | 002-010-004 | No  | dstn17      |
|             |             | lsn17       | 10  | 2-010-4     |
| p-2-010-4   | -----       | 002-100-004 | No  | dstn17p     |
| .           |             |             |     |             |
| .           |             |             |     |             |
| s-2-020-0   | -----       | -----       | No  | dstn21      |
|             |             | lsn21       | 10  | s-2-020-0   |
| ps-2-020-0  | -----       | -----       | No  | dstn21p     |
| s-2-020-1   | 002-020-001 | -----       | No  | dstn22      |
|             |             | lsn22       | 10  | s-2-020-1   |
| ps-2-020-1  | 002-200-001 | -----       | No  | dstn22p     |
| s-2-020-2   | -----       | 04258-aa    | No  | dstn23      |
|             |             | lsn23       | 10  | s-2-020-2   |
| ps-2-020-2  | -----       | 08258-aa    | No  | dstn23p     |
| s-2-020-3   | -----       | s-04259-aa  | No  | dstn24      |
|             |             | lsn24       | 10  | s-2-020-3   |
| ps-2-020-3  | -----       | s-08259-aa  | No  | dstn24p     |
| s-2-070-3   | -----       | -----       | No  | tgtitui003  |
|             |             | lsn21       | 10  | s-2-020-0   |
|             |             | lsn22       | 20  | s-2-020-1   |
|             |             | lsn23       | 30  | s-2-020-2   |
|             |             | lsn24       | 40  | s-2-020-3   |
| .           |             |             |     |             |
| .           |             |             |     |             |
| .           |             |             |     |             |
| DPCI        | ALIASI      | ALIASN/N24  | RTX | CLLI        |
|             |             | LSN         | RC  | APCI        |
| 3-030-0     | s-3-030-0   | -----       | No  | dstn29      |
|             |             | lsn29       | 10  | 3-030-0     |
| p-3-030-0   | s-3-031-0   | -----       | No  | dstn29p     |
| 3-030-1     | s-3-030-1   | 06385-aa    | No  | dstn30      |
|             |             | lsn30       | 10  | 3-030-1     |
| p-3-030-1   | s-3-031-1   | 07385-aa    | No  | dstn30p     |
| 3-030-2     | s-3-030-2   | s-06386-aa  | No  | dstn31      |
|             |             | lsn31       | 10  | 3-030-2     |
| p-3-030-2   | s-3-031-2   | s-07386-aa  | No  | dstn31p     |

|            |             |             |     |            |
|------------|-------------|-------------|-----|------------|
| 3-070-1    | s-3-070-1   | -----       | No  | tgtitui005 |
|            |             | lsn29       | 10  | 3-030-0    |
|            |             | lsn30       | 20  | 3-030-1    |
|            |             | lsn31       | 30  | 3-030-2    |
| 3-030-3    | s-3-030-3   | 003-030-003 | No  | dstn32     |
|            |             | lsn32       | 10  | 3-030-3    |
| p-3-030-3  | s-3-031-3   | 003-031-003 | No  | dstn32p    |
| 3-070-2    | s-3-070-2   | -----       | No  | tgtitui006 |
|            |             | lsn32       | 10  | 3-030-3    |
|            |             | lsn33       | 20  | 3-030-4    |
|            |             | lsn34       | 30  | 3-030-5    |
| s-3-040-2  | 3-040-2     | -----       | No  | dstn35     |
|            |             | lsn35       | 10  | s-3-040-2  |
| ps-3-040-2 | 3-041-2     | -----       | No  | dstn35p    |
| s-3-040-3  | 3-040-3     | 06467-aa    | No  | dstn36     |
|            |             | lsn36       | 10  | s-3-040-3  |
| ps-3-040-3 | 3-041-3     | 07467-aa    | No  | dstn36p    |
| s-3-040-4  | 3-040-4     | s-06468-aa  | No  | dstn37     |
|            |             | lsn37       | 10  | s-3-040-4  |
| ps-3-040-4 | 3-041-4     | s-07468-aa  | No  | dstn37p    |
| s-3-040-5  | 3-040-5     | 003-040-005 | No  | dstn38     |
|            |             | lsn38       | 10  | s-3-040-5  |
| ps-3-040-5 | 3-041-5     | 003-041-005 | No  | dstn38p    |
| DPCI       | ALIASN      | ALIASN      | RTX | CLLI       |
|            |             | LSN         | RC  | APCI       |
| 3-030-4    | s-06388-aa  | 06388-aa    | No  | dstn33     |
|            |             | lsn33       | 10  | 3-030-4    |
| p-3-030-4  | s-07388-aa  | 07388-aa    | No  | dstn33p    |
| 3-030-5    | 06389-aa    | s-06389-aa  | No  | dstn34     |
|            |             | lsn34       | 10  | 3-030-5    |
| p-3-030-5  | 07389-aa    | s-07389-aa  | No  | dstn34p    |
| s-3-040-6  | s-06471-aa  | 06471-aa    | No  | dstn39     |
|            |             | lsn39       | 10  | s-3-040-6  |
| ps-3-040-6 | s-07471-aa  | 07471-aa    | No  | dstn39p    |
| s-3-040-7  | 06472-aa    | s-06472-aa  | No  | dstn40     |
|            |             | lsn40       | 10  | s-3-040-7  |
| ps-3-040-7 | 07472-aa    | s-07472-aa  | No  | dstn40p    |
| DPCN       | ALIASA      | ALIASI      | RTX | CLLI       |
|            |             | LSN         | RC  | APCN       |
| 06157-aa   | 020-005-002 | -----       | No  | -----      |
| 08192-aa   | -----       | -----       | No  | dstn41     |
|            |             | lsn41       | 10  | 08192-aa   |
| p-08192-aa | -----       | -----       | No  | dstn41p    |
| 08193-aa   | 004-000-001 | -----       | No  | dstn42     |
|            |             | lsn42       | 10  | 08193-aa   |
| p-08193-aa | 004-200-001 | -----       | No  | dstn42p    |
| 08194-aa   | -----       | 4-000-2     | No  | dstn43     |
|            |             | lsn43       | 10  | 08194-aa   |
| p-08194-aa | -----       | 4-040-2     | No  | dstn43p    |
| 08195-aa   | -----       | s-4-000-3   | No  | dstn44     |
|            |             | lsn44       | 10  | 08195-aa   |
| p-08195-aa | -----       | s-4-040-3   | No  | dstn44p    |
| 08753-aa   | -----       | -----       | No  | tgtitun001 |
|            |             | lsn41       | 10  | 08192-aa   |
|            |             | lsn42       | 20  | 08193-aa   |
|            |             | lsn43       | 30  | 08194-aa   |
|            |             | lsn44       | 30  | 08195-aa   |
| 08196-aa   | 004-000-004 | 4-000-4     | No  | dstn45     |
|            |             | lsn45       | 10  | 08196-aa   |
| p-08196-aa | 004-200-004 | 4-040-4     | No  | dstn45p    |
| 08197-aa   | 004-000-005 | s-4-000-5   | No  | dstn46     |
|            |             | lsn46       | 10  | 08197-aa   |
| p-08197-aa | 004-200-005 | s-4-040-5   | No  | dstn46p    |



Commands

rtrv-rte

|             |             |           |     |             |
|-------------|-------------|-----------|-----|-------------|
| 08754-aa    | -----       | -----     | No  | tgtitun002  |
|             |             | lsn45     | 10  | 08196-aa    |
|             |             | lsn46     | 20  | 08197-aa    |
|             |             | lsn47     | 30  | 08198-aa    |
|             |             | lsn48     | 30  | 08199-aa    |
| s-08272-aa  | -----       | -----     | No  | dstn49      |
|             |             | lsn49     | 10  | s-08272-aa  |
| ps-08272-aa | -----       | -----     | No  | dstn49p     |
| s-08273-aa  | 004-010-001 | -----     | No  | dstn50      |
|             |             | lsn50     | 10  | s-08273-aa  |
| ps-08273-aa | 004-200-010 | -----     | No  | dstn50p     |
| s-08274-aa  | -----       | 4-010-2   | No  | dstn51      |
|             |             | lsn51     | 10  | s-08274-aa  |
| ps-08274-aa | -----       | 4-050-2   | No  | dstn51p     |
| s-08275-aa  | -----       | s-4-010-3 | No  | dstn52      |
|             |             | lsn52     | 10  | s-08275-aa  |
| ps-08275-aa | -----       | s-4-050-3 | No  | dstn52p     |
| .           |             |           |     |             |
| .           |             |           |     |             |
| .           |             |           |     |             |
| DPCN        | ALIASI      | ALIASI    | RTX | CLLI        |
|             |             | LSN       | RC  | APCN        |
| 08198-aa    | s-4-000-6   | 4-000-6   | No  | dstn47      |
|             |             | lsn47     | 10  | 08198-aa    |
| p-08198-aa  | s-4-040-6   | 4-040-6   | No  | dstn47p     |
| 08199-aa    | 4-000-7     | s-4-000-7 | No  | dstn48      |
|             |             | lsn48     | 10  | 08199-aa    |
| p-08199-aa  | 4-040-7     | s-4-040-7 | No  | dstn48p     |
| s-08278-aa  | s-4-010-6   | 4-010-6   | No  | dstn55      |
|             |             | lsn55     | 10  | s-08278-aa  |
| ps-08278-aa | s-4-050-6   | 4-050-6   | No  | dstn55p     |
| s-08279-aa  | 4-010-7     | s-4-010-7 | No  | dstn56      |
|             |             | lsn56     | 10  | s-08279-aa  |
| ps-08279-aa | 4-050-7     | s-4-050-7 | No  | dstn56p     |
| s-08379-aa  | s-4-058-7   | 4-058-7   | Yes | rtxrout003  |
|             |             | lsn55     | 80  | s-08278-aa  |
| 08198-fr    | s-4-005-7   | 4-005-7   | No  | dstn47dupfr |
| 08198-tk    | 4-006-0     | s-4-006-0 | No  | dstn47dupTk |
| DPCN        | ALIASN      | ALIASI    | RTX | CLLI        |
|             |             | LSN       | RC  | APCN        |
| 12688-aa    | s-12688-aa  | -----     | No  | dstn57      |
|             |             | lsn57     | 10  | 12688-aa    |
| p-12688-aa  | s-13688-aa  | -----     | No  | dstn57p     |
| 12689-aa    | s-12689-aa  | 6-050-1   | No  | dstn58      |
|             |             | lsn58     | 10  | 12689-aa    |
| p-12689-aa  | s-13689-aa  | 6-060-1   | No  | dstn58p     |
| 12690-aa    | s-12690-aa  | s-6-050-2 | No  | dstn59      |
|             |             | lsn59     | 10  | 12690-aa    |
| p-12690-aa  | s-13690-aa  | s-6-060-2 | No  | dstn59p     |
| s-12691-aa  | 12691-aa    | -----     | No  | dstn60      |
|             |             | lsn60     | 10  | s-12691-aa  |
| ps-12691-aa | 13691-aa    | -----     | No  | dstn60p     |
| s-12692-aa  | 12692-aa    | 6-050-4   | No  | dstn61      |
|             |             | lsn61     | 10  | s-12692-aa  |
| ps-12692-aa | 13692-aa    | 6-060-4   | No  | dstn61p     |
| s-12693-aa  | 12693-aa    | s-6-050-5 | No  | dstn62      |
|             |             | lsn62     | 10  | s-12693-aa  |
| ps-12693-aa | 13693-aa    | s-6-060-5 | No  | dstn62p     |
| s-08272-fr  | 08300-fr    | -----     | No  | dstn49dupfr |
| s-08272-tk  | 08300-tk    | 4-006-7   | No  | dstn49dupTk |
| DPCN24      | ALIASA      | ALIASI    | RTX | CLLI        |
|             |             | LSN       | RC  | APCN24      |

```

003-003-004      003-003-003      3-003-4      No      -----
006-005-001      -----
                                lsn63      10      006-005-001
p-006-005-001      -----
006-005-002      006-005-002      -----      No      dstn63p
                                lsn64      10      006-005-002
p-006-005-002      006-005-020      -----      No      dstn64p
006-005-003      -----
                                6-005-3      No      dstn65
                                lsn65      10      006-005-003
p-006-005-003      -----
006-070-001      -----
                                6-050-3      No      dstn65p
                                lsn63      10      tgtitun24a
                                lsn64      20      006-005-001
                                lsn65      30      006-005-002
006-005-004      -----
                                s-6-005-4      No      dstn66
                                lsn66      10      006-005-004
p-006-005-004      -----
006-005-005      006-005-005      6-005-5      No      dstn66p
                                lsn67      10      dstn67
p-006-005-005      006-005-050      6-050-5      No      006-005-005
006-070-002      -----
                                6-050-5      No      dstn67p
                                lsn66      10      tgtitun24b
                                lsn67      20      006-005-004
                                lsn67      20      006-005-005

```

;

The following example displays the output when the Route table is empty.

**rtrv-rte**

```

tekelecstp 08-01-01 12:31:35 EST EAGLE 38.0.0
rtrv-rte
Command entered at terminal #4.

No routes meeting the requested criteria were found

```

;

The following example retrieves a route by linkset name.

**rtrv-rte:lsn=e2e1**

```

eagle10115 08-12-09 10:00:37 EST EAGLE 40.1.0
LSN          DPCA          RC
e2e1         001-001-000    10
              001-101-001    10
              004-101-001    20
              100-100-*      10
              100-100-001    10

```

;

The following example retrieves a route by linkset name and destination point code.

**rtrv-rte:dpc=4-101-1:lsn=e2e1**

```

eagle10115 08-12-09 10:00:37 EST EAGLE 40.1.0
LSN          DPCA          RC
e2e1         004-101-001    20

```

In the following example, the **chg-stpopts:npfmti** value is set to **7-4-3**.

**rtrv-rte:dpcn=127-15-7**

```

eagle10115 08-12-09 10:00:37 EST EAGLE 40.1.0

DPCN          ALIASA          ALIASI          LSN          RC          APCN
127-15-7      -----
                                -----
                                ls1          10          100-10-2
                                RTX: No      CLLI: -----

```

In the following example, the **chg-stptopts:npcfmti** value is set to **11-1-1-1** and the ITUDUPPC feature is on.

**rtrv-rte:lsn=ls3**

```
eagle10115 08-12-09 10:00:37 EST EAGLE 40.1.0
LSN          DPCN          RC
lsn47        1024-1-1-0-aa 10
              1094-0-1-0-aa 30
```

;

In the following example, the **chg-stptopts:npcfmti** value is set to **2-4-4-4** and the ITUDUPPC feature is on.

**rtrv-rte:dpcn=s-2-00-05-00-tk**

```
eagle10115 08-12-09 10:00:37 EST EAGLE 40.1.0

DPCN          ALIASN          ALIASI          RTX  CLLI
              LSN          RC          APCN
s-2-00-05-00-tk  2-00-06-12-tk  4-006-7        No   dstn49dupTk
```

;

In the following example, the **chg-stptopts:npcfmti** value is set to **11-1-1-1** and the ITUDUPPC feature is on.

**rtrv-rte:lsn=elm3itun**

```
eagle10115 08-12-09 10:00:37 EST EAGLE 40.1.0
LSN          DPCN          RC
elm3itun     2047-1-1-1-pe 10
```

;

The following example contains a route with 24-bit ITU-N point codes.

**rtrv-rte:lsn=lsn66**

```
eagle10115 08-12-09 10:00:37 EST EAGLE 40.1.0
LSN          DPCN24          RC
lsn66        006-005-004    10
              006-070-002    10
```

;

The following example displays ANSI point codes.

**rtrv-rte:pctype=ansi**

```
eagle10115 08-12-09 10:00:37 EST EAGLE 40.1.0

DPCA          ALIASI          ALIASN/N24      RTX  CLLI
              LSN          RC          APCA
001-001-000   -----
              e2e1          10          001-001-000
003-001-000   -----
              e2e3          10          003-001-000
004-001-000   -----
              e2e4          10          004-001-000
007-001-000   -----
              e2e7          10          007-001-000
002-101-001   -----
              e2m1s1         10          002-101-001
              e2e3          20          003-001-000
002-102-001   -----
              e2m1s2         10          002-102-001
              e2e3          20          003-001-000
001-101-001   -----
              e2e1          10          001-001-000
              e2e4          20          004-001-000
              e2e3          30          003-001-000
003-101-001   -----
              No           ssp301
```

|               |           |                 |    |             |
|---------------|-----------|-----------------|----|-------------|
|               |           | e2m1s3          | 10 | 003-101-001 |
|               |           | e2e3            | 20 | 003-001-000 |
| 004-101-001   | -----     | -----           | No | ssp401      |
|               |           | e2e4            | 10 | 004-001-000 |
|               |           | e2e1            | 20 | 001-001-000 |
| 007-101-001   | -----     | -----           | No | ssp701      |
|               |           | e2e7            | 10 | 007-001-000 |
| 100-100-*     | -----     | -----           | No | cluster1    |
|               |           | e2e1            | 10 | 001-001-000 |
|               |           | e2e3            | 20 | 003-001-000 |
| 100-100-001   | -----     | -----           | No | -----       |
|               |           | e2e1            | 10 | 001-001-000 |
| 200-200-*     | -----     | -----           | No | cluster2    |
| 005-006-001   | -----     | 005-006-001     | No | -----       |
| 001-001-001   | -----     | -----           | No | dstn01      |
|               |           | lsn01           | 10 | 001-001-001 |
| p-001-001-001 | -----     | -----           | No | dstn01p     |
| 001-001-002   | 1-001-2   | -----           | No | dstn02      |
|               |           | lsn02           | 10 | 001-001-002 |
| p-001-001-002 | 1-011-2   | -----           | No | dstn02p     |
| 001-001-003   | s-1-001-3 | -----           | No | dstn03      |
|               |           | lsn03           | 10 | 001-001-003 |
| p-001-001-003 | s-1-011-3 | -----           | No | dstn03p     |
| 001-001-004   | -----     | 0257-1-0-0-aa   | No | dstn04      |
|               |           | lsn04           | 10 | 001-001-004 |
| p-001-001-004 | -----     | 0132-1-0-0-aa   | No | dstn04p     |
| 001-070-001   | -----     | -----           | No | tgtansi001  |
|               |           | lsn01           | 10 | 001-001-001 |
|               |           | lsn02           | 20 | 001-001-002 |
|               |           | lsn03           | 30 | 001-001-003 |
|               |           | lsn04           | 40 | 001-001-004 |
| 001-001-005   | -----     | s-0257-1-0-1-aa | No | dstn05      |
|               |           | lsn05           | 10 | 001-001-005 |
| p-001-001-005 | -----     | s-0132-1-0-1-aa | No | dstn05p     |
| 001-001-006   | -----     | 001-001-006     | No | dstn06      |
|               |           | lsn06           | 10 | 001-001-006 |
| p-001-001-006 | -----     | 001-011-006     | No | dstn06p     |
| 001-001-007   | 1-001-7   | 0257-1-1-1-aa   | No | dstn07      |
|               |           | lsn07           | 10 | 001-001-007 |
| p-001-001-007 | 1-011-7   | 0132-1-1-1-aa   | No | dstn07p     |
| 001-002-000   | 1-002-0   | s-0258-0-0-0-aa | No | dstn08      |
|               |           | lsn08           | 10 | 001-002-000 |
| p-001-002-000 | 1-012-0   | s-0133-0-0-0-aa | No | dstn08p     |
| 001-070-002   | -----     | -----           | No | tgtansi002  |
|               |           | lsn05           | 10 | 001-001-005 |
|               |           | lsn06           | 20 | 001-001-006 |
|               |           | lsn07           | 30 | 001-001-007 |
|               |           | lsn08           | 40 | 001-002-000 |
| 001-002-001   | s-1-002-1 | 0258-0-0-1-aa   | No | dstn09      |
|               |           | lsn09           | 10 | 001-002-001 |
| p-001-002-001 | s-1-012-1 | 0133-0-0-1-aa   | No | dstn09p     |
| 001-002-002   | s-1-002-2 | s-0258-0-1-0-aa | No | dstn10      |
|               |           | lsn10           | 10 | 001-002-002 |
| p-001-002-002 | s-1-012-2 | s-0133-0-1-0-aa | No | dstn10p     |
| 001-002-003   | 1-002-3   | 001-002-003     | No | dstn11      |
|               |           | lsn11           | 10 | 001-002-003 |
| p-001-002-003 | 1-012-3   | 001-012-003     | No | dstn11p     |
| 001-002-004   | s-1-002-4 | 001-002-004     | No | dstn12      |
|               |           | lsn12           | 10 | 001-002-004 |
| p-001-002-004 | s-1-012-4 | 001-012-004     | No | dstn12p     |
| 001-070-003   | -----     | -----           | No | tgtansi003  |
|               |           | lsn09           | 10 | 001-002-001 |
|               |           | lsn10           | 20 | 001-002-002 |
|               |           | lsn11           | 30 | 001-002-003 |
|               |           | lsn12           | 40 | 001-002-004 |

|             |           |                 |     |             |
|-------------|-----------|-----------------|-----|-------------|
| 200-002-001 | -----     | -----           | Yes | rtxroute001 |
|             |           | lsn12           | 10  | 001-002-004 |
| 001-015-001 | s-1-015-1 | 0271-0-0-1-aa   | No  | gx25dstn001 |
| 001-015-002 | 1-015-2   | -----           | No  | gx25dstn002 |
|             |           | lsngx25a01      | 10  | 001-015-001 |
| 001-015-003 | -----     | s-0271-0-1-1-aa | No  | gx25dstn003 |
| 002-015-001 | -----     | -----           | No  | gx25dstn004 |
| 002-015-002 | -----     | -----           | No  | gx25dstn005 |
| 002-015-003 | -----     | -----           | No  | gx25dstn006 |
| 002-015-004 | -----     | -----           | No  | gx25dstn007 |
|             |           | lsngx25b01      | 10  | 002-015-002 |
| 040-001-*   | -----     | -----           | No  | myncaibeno  |
| 040-010-*   | -----     | -----           | No  | myncaibeno2 |
| 010-*-*     | -----     | -----           | No  | -----       |
| 040-*-*     | -----     | -----           | No  | -----       |
| 040-001-001 | -----     | -----           | No  | noncluster1 |
| 040-001-002 | -----     | -----           | No  | noncluster2 |

;  
The following example displays ITU-I point codes.

**rtrv-rte:pctype=itui**

eagle10115 08-12-09 10:00:37 EST EAGLE 40.1.0

| DPCI       | ALIASA      | ALIASN/N24<br>LSN | RTX<br>RC | CLLI<br>APCI |
|------------|-------------|-------------------|-----------|--------------|
| s-4-002-0  | 010-001-001 | s-1028-1-0-0-aa   | No        | -----        |
| 2-010-0    | -----       | -----             | No        | dstn13       |
|            |             | lsn13             | 10        | 2-010-0      |
| p-2-010-0  | -----       | -----             | No        | dstn13p      |
| 2-010-1    | 002-010-001 | -----             | No        | dstn14       |
|            |             | lsn14             | 10        | 2-010-1      |
| p-2-010-1  | 002-100-001 | -----             | No        | dstn14p      |
| 2-010-2    | -----       | 0522-0-1-0-aa     | No        | dstn15       |
|            |             | lsn15             | 10        | 2-010-2      |
| p-2-010-2  | -----       | 1022-0-1-0-aa     | No        | dstn15p      |
| 2-010-3    | -----       | s-0522-0-1-1-aa   | No        | dstn16       |
|            |             | lsn16             | 10        | 2-010-3      |
| p-2-010-3  | -----       | s-1022-0-1-1-aa   | No        | dstn16p      |
| 2-070-1    | -----       | -----             | No        | tgtitui001   |
|            |             | lsn13             | 10        | 2-010-0      |
|            |             | lsn14             | 20        | 2-010-1      |
|            |             | lsn15             | 30        | 2-010-2      |
|            |             | lsn16             | 40        | 2-010-3      |
| 2-010-4    | -----       | 002-010-004       | No        | dstn17       |
|            |             | lsn17             | 10        | 2-010-4      |
| p-2-010-4  | -----       | 002-100-004       | No        | dstn17p      |
| 2-010-5    | 002-010-005 | 0522-1-0-1-aa     | No        | dstn18       |
|            |             | lsn18             | 10        | 2-010-5      |
| p-2-010-5  | 002-100-005 | 1022-1-0-1-aa     | No        | dstn18p      |
| 2-010-6    | 002-010-006 | s-0522-1-1-0-aa   | No        | dstn19       |
|            |             | lsn19             | 10        | 2-010-6      |
| p-2-010-6  | 002-100-006 | s-1022-1-1-0-aa   | No        | dstn19p      |
| 2-010-7    | 002-010-007 | 002-010-007       | No        | dstn20       |
|            |             | lsn20             | 10        | 2-010-7      |
| p-2-010-7  | 002-100-007 | 002-100-007       | No        | dstn20p      |
| 2-070-2    | -----       | -----             | No        | tgtitui002   |
|            |             | lsn17             | 10        | 2-010-4      |
|            |             | lsn18             | 20        | 2-010-5      |
|            |             | lsn19             | 30        | 2-010-6      |
|            |             | lsn20             | 40        | 2-010-7      |
| s-2-020-0  | -----       | -----             | No        | dstn21       |
|            |             | lsn21             | 10        | s-2-020-0    |
| ps-2-020-0 | -----       | -----             | No        | dstn21p      |
| s-2-020-1  | 002-020-001 | -----             | No        | dstn22       |
|            |             | lsn22             | 10        | s-2-020-1    |

|            |             |                 |     |             |
|------------|-------------|-----------------|-----|-------------|
| ps-2-020-1 | 002-200-001 | -----           | No  | dstn22p     |
| s-2-020-2  | -----       | 0532-0-1-0-aa   | No  | dstn23      |
|            |             | lsn23           | 10  | s-2-020-2   |
| ps-2-020-2 | -----       | 1032-0-1-0-aa   | No  | dstn23p     |
| s-2-020-3  | -----       | s-0532-0-1-1-aa | No  | dstn24      |
|            |             | lsn24           | 10  | s-2-020-3   |
| ps-2-020-3 | -----       | s-1032-0-1-1-aa | No  | dstn24p     |
| s-2-070-3  | -----       | -----           | No  | tgtitui003  |
|            |             | lsn21           | 10  | s-2-020-0   |
|            |             | lsn22           | 20  | s-2-020-1   |
|            |             | lsn23           | 30  | s-2-020-2   |
|            |             | lsn24           | 40  | s-2-020-3   |
| s-2-020-4  | -----       | 002-020-004     | No  | dstn25      |
|            |             | lsn25           | 10  | s-2-020-4   |
| ps-2-020-4 | -----       | 002-200-004     | No  | dstn25p     |
| s-2-020-5  | 002-020-005 | 0532-1-0-1-aa   | No  | dstn26      |
|            |             | lsn26           | 10  | s-2-020-5   |
| ps-2-020-5 | -----       | -----           | No  | dstn26p     |
| s-2-020-6  | 002-020-006 | s-0532-1-1-0-aa | No  | dstn27      |
|            |             | lsn27           | 10  | s-2-020-6   |
| ps-2-020-6 | 002-200-005 | 1032-1-0-1-aa   | No  | dstn27p     |
| s-2-020-7  | 002-020-007 | 002-020-007     | No  | dstn28      |
|            |             | lsn28           | 10  | s-2-020-7   |
| ps-2-020-7 | 002-200-007 | 002-200-007     | No  | dstn28p     |
| s-2-070-4  | -----       | -----           | No  | tgtitui004  |
|            |             | lsn25           | 10  | s-2-020-4   |
|            |             | lsn26           | 20  | s-2-020-5   |
|            |             | lsn27           | 30  | s-2-020-6   |
|            |             | lsn28           | 40  | s-2-020-7   |
| s-3-070-3  | -----       | -----           | No  | tgtitui007  |
|            |             | lsn35           | 10  | s-3-040-2   |
|            |             | lsn36           | 20  | s-3-040-3   |
|            |             | lsn37           | 30  | s-3-040-4   |
| s-3-070-4  | -----       | -----           | No  | tgtitui008  |
|            |             | lsn38           | 10  | s-3-040-5   |
|            |             | lsn39           | 20  | s-3-040-6   |
|            |             | lsn40           | 30  | s-3-040-7   |
| s-2-029-6  | 002-029-006 | s-0533-1-0-1-aa | Yes | rtxroute002 |
|            |             | lsn26           | 5   | s-2-020-5   |
| DPCI       | ALIASI      | ALIASN/N24      | RTX | CLLI        |
|            |             | LSN             | RC  | APCI        |
| 3-030-0    | s-3-030-0   | -----           | No  | dstn29      |
|            |             | lsn29           | 10  | 3-030-0     |
| p-3-030-0  | s-3-031-0   | -----           | No  | dstn29p     |
| 3-030-1    | s-3-030-1   | 0798-0-0-1-aa   | No  | dstn30      |
|            |             | lsn30           | 10  | 3-030-1     |
| p-3-030-1  | s-3-031-1   | 0923-0-0-1-aa   | No  | dstn30p     |
| 3-030-2    | s-3-030-2   | s-0798-0-1-0-aa | No  | dstn31      |
|            |             | lsn31           | 10  | 3-030-2     |
| p-3-030-2  | s-3-031-2   | s-0923-0-1-0-aa | No  | dstn31p     |
| 3-070-1    | s-3-070-1   | -----           | No  | tgtitui005  |
|            |             | lsn29           | 10  | 3-030-0     |
|            |             | lsn30           | 20  | 3-030-1     |
|            |             | lsn31           | 30  | 3-030-2     |
| 3-030-3    | s-3-030-3   | 003-030-003     | No  | dstn32      |
|            |             | lsn32           | 10  | 3-030-3     |
| p-3-030-3  | s-3-031-3   | 003-031-003     | No  | dstn32p     |
| 3-070-2    | s-3-070-2   | -----           | No  | tgtitui006  |
|            |             | lsn32           | 10  | 3-030-3     |
|            |             | lsn33           | 20  | 3-030-4     |
|            |             | lsn34           | 30  | 3-030-5     |
| s-3-040-2  | 3-040-2     | -----           | No  | dstn35      |
|            |             | lsn35           | 10  | s-3-040-2   |
| ps-3-040-2 | 3-041-2     | -----           | No  | dstn35p     |

|            |                 |                 |     |           |
|------------|-----------------|-----------------|-----|-----------|
| s-3-040-3  | 3-040-3         | 0808-0-1-1-aa   | No  | dstn36    |
|            |                 | lsn36           | 10  | s-3-040-3 |
| ps-3-040-3 | 3-041-3         | 0933-0-1-1-aa   | No  | dstn36p   |
| s-3-040-4  | 3-040-4         | s-0808-1-0-0-aa | No  | dstn37    |
|            |                 | lsn37           | 10  | s-3-040-4 |
| ps-3-040-4 | 3-041-4         | s-0933-1-0-0-aa | No  | dstn37p   |
| s-3-040-5  | 3-040-5         | 003-040-005     | No  | dstn38    |
|            |                 | lsn38           | 10  | s-3-040-5 |
| ps-3-040-5 | 3-041-5         | 003-041-005     | No  | dstn38p   |
| DPCI       | ALIASN          | ALIASN          | RTX | CLLI      |
|            |                 | LSN             | RC  | APCI      |
| 3-030-4    | s-0798-1-0-0-aa | 0798-1-0-0-aa   | No  | dstn33    |
|            |                 | lsn33           | 10  | 3-030-4   |
| p-3-030-4  | s-0923-1-0-0-aa | 0923-1-0-0-aa   | No  | dstn33p   |
| 3-030-5    | 0798-1-0-1-aa   | s-0798-1-0-1-aa | No  | dstn34    |
|            |                 | lsn34           | 10  | 3-030-5   |
| p-3-030-5  | 0923-1-0-1-aa   | s-0923-1-0-1-aa | No  | dstn34p   |
| s-3-040-6  | s-0808-1-1-1-aa | 0808-1-1-1-aa   | No  | dstn39    |
|            |                 | lsn39           | 10  | s-3-040-6 |
| ps-3-040-6 | s-0933-1-1-1-aa | 0933-1-1-1-aa   | No  | dstn39p   |
| s-3-040-7  | 0809-0-0-0-aa   | s-0809-0-0-0-aa | No  | dstn40    |
|            |                 | lsn40           | 10  | s-3-040-7 |
| ps-3-040-7 | 0934-0-0-0-aa   | s-0934-0-0-0-aa | No  | dstn40p   |

;  
The following example displays ITU-N point codes.

**rtrv-rte:pctype=itun**

eagle10115 08-12-09 10:00:37 EST EAGLE 40.1.0

| DPCN        | ALIASA      | ALIASI<br>LSN | RTX<br>RC | CLLI<br>APCN |
|-------------|-------------|---------------|-----------|--------------|
| 06157-aa    | 020-005-002 | -----         | No        | -----        |
| 08192-aa    | -----       | -----         | No        | dstn41       |
|             |             | lsn41         | 10        | 08192-aa     |
| p-08192-aa  | -----       | -----         | No        | dstn41p      |
| 08193-aa    | 004-000-001 | -----         | No        | dstn42       |
|             |             | lsn42         | 10        | 08193-aa     |
| p-08193-aa  | 004-200-001 | -----         | No        | dstn42p      |
| 08194-aa    | -----       | 4-000-2       | No        | dstn43       |
|             |             | lsn43         | 10        | 08194-aa     |
| p-08194-aa  | -----       | 4-040-2       | No        | dstn43p      |
| 08195-aa    | -----       | s-4-000-3     | No        | dstn44       |
|             |             | lsn44         | 10        | 08195-aa     |
| p-08195-aa  | -----       | s-4-040-3     | No        | dstn44p      |
| 08753-aa    | -----       | -----         | No        | tgtitun001   |
|             |             | lsn41         | 10        | 08192-aa     |
|             |             | lsn42         | 20        | 08193-aa     |
|             |             | lsn43         | 30        | 08194-aa     |
|             |             | lsn44         | 30        | 08195-aa     |
| 08196-aa    | 004-000-004 | 4-000-4       | No        | dstn45       |
|             |             | lsn45         | 10        | 08196-aa     |
| p-08196-aa  | 004-200-004 | 4-040-4       | No        | dstn45p      |
| 08197-aa    | 004-000-005 | s-4-000-5     | No        | dstn46       |
|             |             | lsn46         | 10        | 08197-aa     |
| p-08197-aa  | 004-200-005 | s-4-040-5     | No        | dstn46p      |
| 08754-aa    | -----       | -----         | No        | tgtitun002   |
|             |             | lsn45         | 10        | 08196-aa     |
|             |             | lsn46         | 20        | 08197-aa     |
|             |             | lsn47         | 30        | 08198-aa     |
|             |             | lsn48         | 30        | 08199-aa     |
| s-08272-aa  | -----       | -----         | No        | dstn49       |
|             |             | lsn49         | 10        | s-08272-aa   |
| ps-08272-aa | -----       | -----         | No        | dstn49p      |
| s-08273-aa  | 004-010-001 | -----         | No        | dstn50       |

|             |             |           |     |             |
|-------------|-------------|-----------|-----|-------------|
|             |             | lsn50     | 10  | s-08273-aa  |
| ps-08273-aa | 004-200-010 | -----     | No  | dstn50p     |
| s-08274-aa  | -----       | 4-010-2   | No  | dstn51      |
|             |             | lsn51     | 10  | s-08274-aa  |
| ps-08274-aa | -----       | 4-050-2   | No  | dstn51p     |
| s-08275-aa  | -----       | s-4-010-3 | No  | dstn52      |
|             |             | lsn52     | 10  | s-08275-aa  |
| ps-08275-aa | -----       | s-4-050-3 | No  | dstn52p     |
| s-08755-aa  | -----       | -----     | No  | tgtitun003  |
|             |             | lsn49     | 10  | s-08272-aa  |
|             |             | lsn50     | 20  | s-08273-aa  |
|             |             | lsn51     | 30  | s-08274-aa  |
|             |             | lsn52     | 30  | s-08275-aa  |
| s-08276-aa  | 004-010-004 | 4-010-4   | No  | dstn53      |
|             |             | lsn53     | 10  | s-08276-aa  |
| ps-08276-aa | 004-200-040 | 4-050-4   | No  | dstn53p     |
| s-08277-aa  | 004-010-005 | s-4-010-5 | No  | dstn54      |
|             |             | lsn54     | 10  | s-08277-aa  |
| ps-08277-aa | 004-200-050 | s-4-050-5 | No  | dstn54p     |
| s-08756-aa  | -----       | -----     | No  | tgtitun004  |
|             |             | lsn53     | 10  | s-08276-aa  |
|             |             | lsn54     | 20  | s-08277-aa  |
|             |             | lsn55     | 30  | s-08278-aa  |
|             |             | lsn56     | 30  | s-08279-aa  |
| 08757-aa    | -----       | -----     | No  | tgtitun005  |
|             |             | lsn57     | 10  | 12688-aa    |
|             |             | lsn58     | 20  | 12689-aa    |
|             |             | lsn59     | 30  | 12690-aa    |
| s-08758-aa  | -----       | -----     | No  | tgtitun006  |
|             |             | lsn60     | 10  | s-12691-aa  |
|             |             | lsn61     | 20  | s-12692-aa  |
|             |             | lsn62     | 30  | s-12693-aa  |
| 08199-fr    | -----       | s-4-006-1 | No  | dstn48dupfr |
| 08199-tk    | -----       | 4-006-2   | No  | dstn48duptk |
| 08198-nz    | -----       | -----     | No  | dstn47dupnz |
| s-08273-fr  | -----       | 4-006-3   | No  | dstn50dupfr |
| DPCN        | ALIASI      | ALIASI    | RTX | CLLI        |
|             |             | LSN       | RC  | APCN        |
| 08198-aa    | s-4-000-6   | 4-000-6   | No  | dstn47      |
|             |             | lsn47     | 10  | 08198-aa    |
| p-08198-aa  | s-4-040-6   | 4-040-6   | No  | dstn47p     |
| 08199-aa    | 4-000-7     | s-4-000-7 | No  | dstn48      |
|             |             | lsn48     | 10  | 08199-aa    |
| p-08199-aa  | 4-040-7     | s-4-040-7 | No  | dstn48p     |
| s-08278-aa  | s-4-010-6   | 4-010-6   | No  | dstn55      |
|             |             | lsn55     | 10  | s-08278-aa  |
| ps-08278-aa | s-4-050-6   | 4-050-6   | No  | dstn55p     |
| s-08279-aa  | 4-010-7     | s-4-010-7 | No  | dstn56      |
|             |             | lsn56     | 10  | s-08279-aa  |
| ps-08279-aa | 4-050-7     | s-4-050-7 | No  | dstn56p     |
| s-08379-aa  | s-4-058-7   | 4-058-7   | Yes | rtxroute003 |
|             |             | lsn55     | 80  | s-08278-aa  |
| 08198-fr    | s-4-005-7   | 4-005-7   | No  | dstn47dupfr |
| 08198-tk    | 4-006-0     | s-4-006-0 | No  | dstn47duptk |
| DPCN        | ALIASN      | ALIASI    | RTX | CLLI        |
|             |             | LSN       | RC  | APCN        |
| 12688-aa    | s-12688-aa  | -----     | No  | dstn57      |
|             |             | lsn57     | 10  | 12688-aa    |
| p-12688-aa  | s-13688-aa  | -----     | No  | dstn57p     |
| 12689-aa    | s-12689-aa  | 6-050-1   | No  | dstn58      |
|             |             | lsn58     | 10  | 12689-aa    |
| p-12689-aa  | s-13689-aa  | 6-060-1   | No  | dstn58p     |
| 12690-aa    | s-12690-aa  | s-6-050-2 | No  | dstn59      |



```

                lsn59          10    12690-aa
p-12690-aa      s-13690-aa      s-6-060-2    No    dstn59p
s-12691-aa      12691-aa      -----      No    dstn60
                lsn60          10    s-12691-aa
ps-12691-aa     13691-aa      -----      No    dstn60p
s-12692-aa     12692-aa      6-050-4      No    dstn61
                lsn61          10    s-12692-aa
ps-12692-aa     13692-aa      6-060-4      No    dstn61p
s-12693-aa     12693-aa      s-6-050-5      No    dstn62
                lsn62          10    s-12693-aa
ps-12693-aa     13693-aa      s-6-060-5      No    dstn62p
s-08272-fr     08300-fr      -----      No    dstn49dupfr
s-08272-tk     08300-tk      4-006-7      No    dstn49dupTk
    
```

The following example displays ANSI point codes that have the private point code subtype prefix (p-).

**rtrv-rte:pctype=ansi:pcst=p**

```

eagle10115 08-12-09 10:00:37 EST EAGLE 40.1.0

      DPCA          ALIASI          ALIASN/N24    RTX    CLLI
                        ALIASN/N24    RC          APCA
                        LSN
p-001-001-001  -----      -----      No    dstn01p
p-001-001-002      1-011-2      -----      No    dstn02p
p-001-001-003  s-1-011-3      -----      No    dstn03p
p-001-001-004  -----      01060-aa      No    dstn04p
p-001-001-005  -----      s-01061-aa      No    dstn05p
p-001-001-006  -----      001-011-006      No    dstn06p
p-001-001-007      1-011-7      01063-aa      No    dstn07p
p-001-002-000      1-012-0      s-01064-aa      No    dstn08p
p-001-002-001  s-1-012-1      01065-aa      No    dstn09p
p-001-002-002  s-1-012-2      s-01066-aa      No    dstn10p
p-001-002-003      1-012-3      001-012-003      No    dstn11p
p-001-002-004  s-1-012-4      001-012-004      No    dstn12p
    
```

The following example displays ITU-I point codes that have the private and spare point code subtype prefix (ps-).

**rtrv-rte:pctype=itui:pcst=ps**

```

eagle10115 08-12-09 10:00:37 EST EAGLE 40.1.0

      DPCI          ALIASA          ALIASN/N24    RTX    CLLI
                        ALIASN/N24    RC          APCI
                        LSN
ps-2-020-0      -----      -----      No    dstn21p
ps-2-020-1      002-200-001  -----      No    dstn22p
ps-2-020-2      -----      08258-aa      No    dstn23p
ps-2-020-3      -----      s-08259-aa      No    dstn24p
ps-2-020-4      -----      002-200-004      No    dstn25p
ps-2-020-5      -----      -----      No    dstn26p
ps-2-020-6      002-200-005  08261-aa      No    dstn27p
ps-2-020-7      002-200-007  002-200-007      No    dstn28p

      DPCI          ALIASI          ALIASN/N24    RTX    CLLI
                        ALIASN/N24    RC          APCI
                        LSN
ps-3-040-2      3-041-2      -----      No    dstn35p
ps-3-040-3      3-041-3      07467-aa      No    dstn36p
ps-3-040-4      3-041-4      s-07468-aa      No    dstn37p
ps-3-040-5      3-041-5      003-041-005      No    dstn38p

      DPCI          ALIASN          ALIASN          RTX    CLLI
                        ALIASN          LSN          RC          APCI
ps-3-040-6      s-07471-aa      07471-aa      No    dstn39p
ps-3-040-7      07472-aa      s-07472-aa      No    dstn40p
    
```

;

The following example displays ITU-N point codes that have the spare point code subtype prefix (s-).

**rtrv-rte:pcst=itun:pcst=s**

eagle10115 08-12-09 10:00:37 EST EAGLE 40.1.0

| DPCN       | ALIASA      | ALIASI<br>LSN | RTX<br>RC | CLLI<br>APCN |
|------------|-------------|---------------|-----------|--------------|
| s-08272-aa | -----       | -----         | No        | dstn49       |
|            |             | lsn49         | 10        | s-08272-aa   |
| s-08273-aa | 004-010-001 | -----         | No        | dstn50       |
|            |             | lsn50         | 10        | s-08273-aa   |
| s-08274-aa | -----       | 4-010-2       | No        | dstn51       |
|            |             | lsn51         | 10        | s-08274-aa   |
| s-08275-aa | -----       | s-4-010-3     | No        | dstn52       |
|            |             | lsn52         | 10        | s-08275-aa   |
| s-08755-aa | -----       | -----         | No        | tgtitun003   |
|            |             | lsn49         | 10        | s-08272-aa   |
|            |             | lsn50         | 20        | s-08273-aa   |
|            |             | lsn51         | 30        | s-08274-aa   |
|            |             | lsn52         | 30        | s-08275-aa   |
| s-08276-aa | 004-010-004 | 4-010-4       | No        | dstn53       |
|            |             | lsn53         | 10        | s-08276-aa   |
| s-08277-aa | 004-010-005 | s-4-010-5     | No        | dstn54       |
|            |             | lsn54         | 10        | s-08277-aa   |
| s-08756-aa | -----       | -----         | No        | tgtitun004   |
|            |             | lsn53         | 10        | s-08276-aa   |
|            |             | lsn54         | 20        | s-08277-aa   |
|            |             | lsn55         | 30        | s-08278-aa   |
|            |             | lsn56         | 30        | s-08279-aa   |
| s-08758-aa | -----       | -----         | No        | tgtitun006   |
|            |             | lsn60         | 10        | s-12691-aa   |
|            |             | lsn61         | 20        | s-12692-aa   |
|            |             | lsn62         | 30        | s-12693-aa   |
| s-08273-fr | -----       | 4-006-3       | No        | dstn50dupfr  |
| DPCN       | ALIASI      | ALIASI<br>LSN | RTX<br>RC | CLLI<br>APCN |
| s-08278-aa | s-4-010-6   | 4-010-6       | No        | dstn55       |
|            |             | lsn55         | 10        | s-08278-aa   |
| s-08279-aa | 4-010-7     | s-4-010-7     | No        | dstn56       |
|            |             | lsn56         | 10        | s-08279-aa   |
| s-08379-aa | s-4-058-7   | 4-058-7       | Yes       | rtxroute003  |
|            |             | lsn55         | 80        | s-08278-aa   |
| DPCN       | ALIASN      | ALIASI<br>LSN | RTX<br>RC | CLLI<br>APCN |
| s-12691-aa | 12691-aa    | -----         | No        | dstn60       |
|            |             | lsn60         | 10        | s-12691-aa   |
| s-12692-aa | 12692-aa    | 6-050-4       | No        | dstn61       |
|            |             | lsn61         | 10        | s-12692-aa   |
| s-12693-aa | 12693-aa    | s-6-050-5     | No        | dstn62       |
|            |             | lsn62         | 10        | s-12693-aa   |
| s-08272-fr | 08300-fr    | -----         | No        | dstn49dupfr  |
| s-08272-tk | 08300-tk    | 4-006-7       | No        | dstn49dupfk  |

;

The following example displays point codes that have no point code subtype prefix. This example displays abbreviated output.

**rtrv-rte:pcst=none**

eagle10115 08-12-09 10:00:37 EST EAGLE 40.1.0

Commands

rtrv-rte

| DPCA        | ALIASI      | ALIASN/N24<br>LSN | RTX<br>RC | CLLI<br>APCA |
|-------------|-------------|-------------------|-----------|--------------|
| 001-001-000 | -----       | -----             | No        | stp1         |
|             |             | e2e1              | 10        | 001-001-000  |
| 003-001-000 | -----       | -----             | No        | mstp         |
|             |             | e2e3              | 10        | 003-001-000  |
| 004-001-000 | -----       | -----             | No        | stp4         |
|             |             | e2e4              | 10        | 004-001-000  |
| 007-001-000 | -----       | -----             | No        | stp7         |
|             |             | e2e7              | 10        | 007-001-000  |
| 002-101-001 | -----       | -----             | No        | ssp201       |
|             |             | e2m1s1            | 10        | 002-101-001  |
|             |             | e2e3              | 20        | 003-001-000  |
| .           |             |                   |           |              |
| .           |             |                   |           |              |
| 200-200-*   | -----       | -----             | No        | cluster2     |
| 005-006-001 | -----       | 005-006-001       | No        | -----        |
| 001-001-001 | -----       | -----             | No        | dstn01       |
|             |             | lsn01             | 10        | 001-001-001  |
| 001-001-002 | 1-001-2     | -----             | No        | dstn02       |
|             |             | lsn02             | 10        | 001-001-002  |
| 001-001-003 | s-1-001-3   | -----             | No        | dstn03       |
|             |             | lsn03             | 10        | 001-001-003  |
| 001-001-004 | -----       | 02060             | No        | dstn04       |
|             |             | lsn04             | 10        | 001-001-004  |
| 001-070-001 | -----       | -----             | No        | tgtansi001   |
|             |             | lsn01             | 10        | 001-001-001  |
|             |             | lsn02             | 20        | 001-001-002  |
|             |             | lsn03             | 30        | 001-001-003  |
|             |             | lsn04             | 40        | 001-001-004  |
| 001-001-005 | -----       | s-02061           | No        | dstn05       |
|             |             | lsn05             | 10        | 001-001-005  |
| .           |             |                   |           |              |
| .           |             |                   |           |              |
| .           |             |                   |           |              |
| 010-**-*    | -----       | -----             | No        | dstnnrtison  |
| DPCI        | ALIASA      | ALIASN/N24<br>LSN | RTX<br>RC | CLLI<br>APCI |
| 2-010-0     | -----       | -----             | No        | dstn13       |
|             |             | lsn13             | 10        | 2-010-0      |
| 2-010-1     | 002-010-001 | -----             | No        | dstn14       |
|             |             | lsn14             | 10        | 2-010-1      |
| 2-010-2     | -----       | 04178             | No        | dstn15       |
|             |             | lsn15             | 10        | 2-010-2      |
| 2-010-3     | -----       | s-04179           | No        | dstn16       |
|             |             | lsn16             | 10        | 2-010-3      |
| 2-070-1     | -----       | -----             | No        | tgtitui001   |
|             |             | lsn13             | 10        | 2-010-0      |
|             |             | lsn14             | 20        | 2-010-1      |
|             |             | lsn15             | 30        | 2-010-2      |
|             |             | lsn16             | 40        | 2-010-3      |
| 2-010-4     | -----       | 002-010-004       | No        | dstn17       |
|             |             | lsn17             | 10        | 2-010-4      |
| .           |             |                   |           |              |
| .           |             |                   |           |              |
| .           |             |                   |           |              |
| DPCI        | ALIASI      | ALIASN/N24<br>LSN | RTX<br>RC | CLLI<br>APCI |
| 3-030-0     | s-3-030-0   | -----             | No        | dstn29       |
|             |             | lsn29             | 10        | 3-030-0      |
| 3-030-1     | s-3-030-1   | 06385             | No        | dstn30       |
|             |             | lsn30             | 10        | 3-030-1      |

|             |             |             |     |             |
|-------------|-------------|-------------|-----|-------------|
| 3-030-2     | s-3-030-2   | s-06386     | No  | dstn31      |
|             |             | lsn31       | 10  | 3-030-2     |
| 3-070-1     | s-3-070-1   | -----       | No  | tgtitui005  |
|             |             | lsn29       | 10  | 3-030-0     |
|             |             | lsn30       | 20  | 3-030-1     |
|             |             | lsn31       | 30  | 3-030-2     |
| 3-030-3     | s-3-030-3   | 003-030-003 | No  | dstn32      |
|             |             | lsn32       | 10  | 3-030-3     |
| 3-070-2     | s-3-070-2   | -----       | No  | tgtitui006  |
|             |             | lsn32       | 10  | 3-030-3     |
|             |             | lsn33       | 20  | 3-030-4     |
|             |             | lsn34       | 30  | 3-030-5     |
| DPCI        | ALIASN      | ALIASN      | RTX | CLLI        |
|             |             | LSN         | RC  | APCI        |
| 3-030-4     | s-06388     | 06388       | No  | dstn33      |
|             |             | lsn33       | 10  | 3-030-4     |
| 3-030-5     | 06389       | s-06389     | No  | dstn34      |
|             |             | lsn34       | 10  | 3-030-5     |
| DPCN        | ALIASA      | ALIASI      | RTX | CLLI        |
|             |             | LSN         | RC  | APCN        |
| 06157       | 020-005-002 | -----       | No  | -----       |
| 08192       | -----       | -----       | No  | dstn41      |
|             |             | lsn41       | 10  | 08192       |
| 08193       | 004-000-001 | -----       | No  | dstn42      |
|             |             | lsn42       | 10  | 08193       |
| 08194       | -----       | 4-000-2     | No  | dstn43      |
|             |             | lsn43       | 10  | 08194       |
| 08195       | -----       | s-4-000-3   | No  | dstn44      |
|             |             | lsn44       | 10  | 08195       |
| 08753       | -----       | -----       | No  | tgtitun001  |
|             |             | lsn41       | 10  | 08192       |
|             |             | lsn42       | 20  | 08193       |
|             |             | lsn43       | 30  | 08194       |
|             |             | lsn44       | 30  | 08195       |
| .           |             |             |     |             |
| .           |             |             |     |             |
| .           |             |             |     |             |
| DPCN        | ALIASI      | ALIASI      | RTX | CLLI        |
|             |             | LSN         | RC  | APCN        |
| 08198       | s-4-000-6   | 4-000-6     | No  | dstn47      |
|             |             | lsn47       | 10  | 08198       |
| 08199       | 4-000-7     | s-4-000-7   | No  | dstn48      |
|             |             | lsn48       | 10  | 08199       |
| DPCN        | ALIASN      | ALIASI      | RTX | CLLI        |
|             |             | LSN         | RC  | APCN        |
| 12688       | s-12688     | -----       | No  | dstn57      |
|             |             | lsn57       | 10  | 12688       |
| 12689       | s-12689     | 6-050-1     | No  | dstn58      |
|             |             | lsn58       | 10  | 12689       |
| 12690       | s-12690     | s-6-050-2   | No  | dstn59      |
|             |             | lsn59       | 10  | 12690       |
| DPCN24      | ALIASA      | ALIASI      | RTX | CLLI        |
|             |             | LSN         | RC  | APCN24      |
| 003-003-004 | 003-003-003 | 3-003-4     | No  | -----       |
| 006-005-001 | -----       | -----       | No  | dstn63      |
|             |             | lsn63       | 10  | 006-005-001 |
| 006-005-002 | 006-005-002 | -----       | No  | dstn64      |
|             |             | lsn64       | 10  | 006-005-002 |
| 006-005-003 | -----       | 6-005-3     | No  | dstn65      |
|             |             | lsn65       | 10  | 006-005-003 |

```

006-070-001 -----
                    lsn63      10    tgtitun24a
                    lsn64      20    006-005-001
                    lsn65      30    006-005-002
006-005-004 ----- s-6-005-4   No    dstn66
                    lsn66      10    006-005-004
006-005-005      006-005-005  6-005-5 No    dstn67
                    lsn67      10    006-005-005
006-070-002 -----
                    lsn66      10    tgtitun24b
                    lsn67      20    006-005-004
                    lsn67      20    006-005-005
    
```

i

The following example displays point codes that have the private point code subtype prefix (p-).

**rtrv-rte:pcst=p**

eagle10115 08-12-09 10:00:37 EST EAGLE 40.1.0

| DPCA          | ALIASI    | ALIASN/N24<br>LSN | RTX<br>RC | CLLI<br>APCA |
|---------------|-----------|-------------------|-----------|--------------|
| p-001-001-001 | -----     | -----             | No        | dstn01p      |
| p-001-001-002 | 1-011-2   | -----             | No        | dstn02p      |
| p-001-001-003 | s-1-011-3 | -----             | No        | dstn03p      |
| p-001-001-004 | -----     | 01060-aa          | No        | dstn04p      |
| p-001-001-005 | -----     | s-01061-aa        | No        | dstn05p      |
| p-001-001-006 | -----     | 001-011-006       | No        | dstn06p      |
| p-001-001-007 | 1-011-7   | 01063-aa          | No        | dstn07p      |
| p-001-002-000 | 1-012-0   | s-01064-aa        | No        | dstn08p      |
| p-001-002-001 | s-1-012-1 | 01065-aa          | No        | dstn09p      |
| p-001-002-002 | s-1-012-2 | s-01066-aa        | No        | dstn10p      |
| p-001-002-003 | 1-012-3   | 001-012-003       | No        | dstn11p      |
| p-001-002-004 | s-1-012-4 | 001-012-004       | No        | dstn12p      |

| DPCI      | ALIASA      | ALIASN/N24<br>LSN | RTX<br>RC | CLLI<br>APCI |
|-----------|-------------|-------------------|-----------|--------------|
| p-2-010-0 | -----       | -----             | No        | dstn13p      |
| p-2-010-1 | 002-100-001 | -----             | No        | dstn14p      |
| p-2-010-2 | -----       | 08178-aa          | No        | dstn15p      |
| p-2-010-3 | -----       | s-08179-aa        | No        | dstn16p      |
| p-2-010-4 | -----       | 002-100-004       | No        | dstn17p      |
| p-2-010-5 | 002-100-005 | 08181-aa          | No        | dstn18p      |
| p-2-010-6 | 002-100-006 | s-08182-aa        | No        | dstn19p      |
| p-2-010-7 | 002-100-007 | 002-100-007       | No        | dstn20p      |

| DPCI      | ALIASI    | ALIASN/N24<br>LSN | RTX<br>RC | CLLI<br>APCI |
|-----------|-----------|-------------------|-----------|--------------|
| p-3-030-0 | s-3-031-0 | -----             | No        | dstn29p      |
| p-3-030-1 | s-3-031-1 | 07385-aa          | No        | dstn30p      |
| p-3-030-2 | s-3-031-2 | s-07386-aa        | No        | dstn31p      |
| p-3-030-3 | s-3-031-3 | 003-031-003       | No        | dstn32p      |

| DPCI      | ALIASN     | ALIASN<br>LSN | RTX<br>RC | CLLI<br>APCI |
|-----------|------------|---------------|-----------|--------------|
| p-3-030-4 | s-07388-aa | 07388-aa      | No        | dstn33p      |
| p-3-030-5 | 07389-aa   | s-07389-aa    | No        | dstn34p      |

| DPCN       | ALIASA      | ALIASI<br>LSN | RTX<br>RC | CLLI<br>APCN |
|------------|-------------|---------------|-----------|--------------|
| p-08192-aa | -----       | -----         | No        | dstn41p      |
| p-08193-aa | 004-200-001 | -----         | No        | dstn42p      |
| p-08194-aa | -----       | 4-040-2       | No        | dstn43p      |
| p-08195-aa | -----       | s-4-040-3     | No        | dstn44p      |
| p-08196-aa | 004-200-004 | 4-040-4       | No        | dstn45p      |
| p-08197-aa | 004-200-005 | s-4-040-5     | No        | dstn46p      |

| DPCN | ALIASI | ALIASI | RTX | CLLI |
|------|--------|--------|-----|------|
|------|--------|--------|-----|------|

|               |             | LSN       | RC  | APCN    |
|---------------|-------------|-----------|-----|---------|
| p-08198-aa    | s-4-040-6   | 4-040-6   | No  | dstn47p |
| p-08199-aa    | 4-040-7     | s-4-040-7 | No  | dstn48p |
| DPCN          | ALIASN      | ALIASI    | RTX | CLLI    |
|               |             | LSN       | RC  | APCN    |
| p-12688-aa    | s-13688-aa  | -----     | No  | dstn57p |
| p-12689-aa    | s-13689-aa  | 6-060-1   | No  | dstn58p |
| p-12690-aa    | s-13690-aa  | s-6-060-2 | No  | dstn59p |
| DPCN24        | ALIASA      | ALIASI    | RTX | CLLI    |
|               |             | LSN       | RC  | APCN24  |
| p-006-005-001 | -----       | -----     | No  | dstn63p |
| p-006-005-002 | 006-005-020 | -----     | No  | dstn64p |
| p-006-005-003 | -----       | 6-050-3   | No  | dstn65p |
| p-006-005-004 | -----       | s-6-050-4 | No  | dstn66p |
| p-006-005-005 | 006-005-050 | 6-050-5   | No  | dstn67p |

;

The following example displays point codes that have the spare point code subtype prefix (s-).

**rtrv-rte:pcst=s**

eagle10115 08-12-09 10:00:37 EST EAGLE 40.1.0

| DPCI      | ALIASA      | ALIASN/N24  | RTX | CLLI        |
|-----------|-------------|-------------|-----|-------------|
|           |             | LSN         | RC  | APCI        |
| s-4-002-0 | 010-001-001 | s-08228-aa  | No  | -----       |
| s-2-020-0 | -----       | -----       | No  | dstn21      |
|           |             | lsn21       | 10  | s-2-020-0   |
| s-2-020-1 | 002-020-001 | -----       | No  | dstn22      |
|           |             | lsn22       | 10  | s-2-020-1   |
| s-2-020-2 | -----       | 04258-aa    | No  | dstn23      |
|           |             | lsn23       | 10  | s-2-020-2   |
| s-2-020-3 | -----       | s-04259-aa  | No  | dstn24      |
|           |             | lsn24       | 10  | s-2-020-3   |
| s-2-070-3 | -----       | -----       | No  | tgtitui003  |
|           |             | lsn21       | 10  | s-2-020-0   |
|           |             | lsn22       | 20  | s-2-020-1   |
|           |             | lsn23       | 30  | s-2-020-2   |
|           |             | lsn24       | 40  | s-2-020-3   |
| s-2-020-4 | -----       | 002-020-004 | No  | dstn25      |
|           |             | lsn25       | 10  | s-2-020-4   |
| s-2-020-5 | 002-020-005 | 04261-aa    | No  | dstn26      |
|           |             | lsn26       | 10  | s-2-020-5   |
| s-2-020-6 | 002-020-006 | s-04262-aa  | No  | dstn27      |
|           |             | lsn27       | 10  | s-2-020-6   |
| s-2-020-7 | 002-020-007 | 002-020-007 | No  | dstn28      |
|           |             | lsn28       | 10  | s-2-020-7   |
| s-2-070-4 | -----       | -----       | No  | tgtitui004  |
|           |             | lsn25       | 10  | s-2-020-4   |
|           |             | lsn26       | 20  | s-2-020-5   |
|           |             | lsn27       | 30  | s-2-020-6   |
|           |             | lsn28       | 40  | s-2-020-7   |
| s-3-070-3 | -----       | -----       | No  | tgtitui007  |
|           |             | lsn35       | 10  | s-3-040-2   |
|           |             | lsn36       | 20  | s-3-040-3   |
|           |             | lsn37       | 30  | s-3-040-4   |
| s-3-070-4 | -----       | -----       | No  | tgtitui008  |
|           |             | lsn38       | 10  | s-3-040-5   |
|           |             | lsn39       | 20  | s-3-040-6   |
|           |             | lsn40       | 30  | s-3-040-7   |
| s-2-029-6 | 002-029-006 | s-04269-aa  | Yes | rtxroute002 |
|           |             | lsn26       | 5   | s-2-020-5   |
| DPCI      | ALIASI      | ALIASN/N24  | RTX | CLLI        |
|           |             | LSN         | RC  | APCI        |

Commands

rtrv-rte

|            |             |             |     |             |
|------------|-------------|-------------|-----|-------------|
| s-3-040-2  | 3-040-2     | -----       | No  | dstn35      |
|            |             | lsn35       | 10  | s-3-040-2   |
| s-3-040-3  | 3-040-3     | 06467-aa    | No  | dstn36      |
|            |             | lsn36       | 10  | s-3-040-3   |
| s-3-040-4  | 3-040-4     | s-06468-aa  | No  | dstn37      |
|            |             | lsn37       | 10  | s-3-040-4   |
| s-3-040-5  | 3-040-5     | 003-040-005 | No  | dstn38      |
|            |             | lsn38       | 10  | s-3-040-5   |
| DPCI       | ALIASN      | ALIASN      | RTX | CLLI        |
|            |             | LSN         | RC  | APCI        |
| s-3-040-6  | s-06471-aa  | 06471-aa    | No  | dstn39      |
|            |             | lsn39       | 10  | s-3-040-6   |
| s-3-040-7  | 06472-aa    | s-06472-aa  | No  | dstn40      |
|            |             | lsn40       | 10  | s-3-040-7   |
| DPCN       | ALIASA      | ALIASI      | RTX | CLLI        |
|            |             | LSN         | RC  | APCN        |
| s-08272-aa | -----       | -----       | No  | dstn49      |
|            |             | lsn49       | 10  | s-08272-aa  |
| s-08273-aa | 004-010-001 | -----       | No  | dstn50      |
|            |             | lsn50       | 10  | s-08273-aa  |
| s-08274-aa | -----       | 4-010-2     | No  | dstn51      |
|            |             | lsn51       | 10  | s-08274-aa  |
| s-08275-aa | -----       | s-4-010-3   | No  | dstn52      |
|            |             | lsn52       | 10  | s-08275-aa  |
| s-08755-aa | -----       | -----       | No  | tgtitun003  |
|            |             | lsn49       | 10  | s-08272-aa  |
|            |             | lsn50       | 20  | s-08273-aa  |
|            |             | lsn51       | 30  | s-08274-aa  |
|            |             | lsn52       | 30  | s-08275-aa  |
| s-08276-aa | 004-010-004 | 4-010-4     | No  | dstn53      |
|            |             | lsn53       | 10  | s-08276-aa  |
| s-08277-aa | 004-010-005 | s-4-010-5   | No  | dstn54      |
|            |             | lsn54       | 10  | s-08277-aa  |
| s-08756-aa | -----       | -----       | No  | tgtitun004  |
|            |             | lsn53       | 10  | s-08276-aa  |
|            |             | lsn54       | 20  | s-08277-aa  |
|            |             | lsn55       | 30  | s-08278-aa  |
|            |             | lsn56       | 30  | s-08279-aa  |
| s-08758-aa | -----       | -----       | No  | tgtitun006  |
|            |             | lsn60       | 10  | s-12691-aa  |
|            |             | lsn61       | 20  | s-12692-aa  |
|            |             | lsn62       | 30  | s-12693-aa  |
| s-08273-fr | -----       | 4-006-3     | No  | dstn50dupfr |
| DPCN       | ALIASI      | ALIASI      | RTX | CLLI        |
|            |             | LSN         | RC  | APCN        |
| s-08278-aa | s-4-010-6   | 4-010-6     | No  | dstn55      |
|            |             | lsn55       | 10  | s-08278-aa  |
| s-08279-aa | 4-010-7     | s-4-010-7   | No  | dstn56      |
|            |             | lsn56       | 10  | s-08279-aa  |
| s-08379-aa | s-4-058-7   | 4-058-7     | Yes | rtxroute003 |
|            |             | lsn55       | 80  | s-08278-aa  |
| DPCN       | ALIASN      | ALIASI      | RTX | CLLI        |
|            |             | LSN         | RC  | APCN        |
| s-12691-aa | 12691-aa    | -----       | No  | dstn60      |
|            |             | lsn60       | 10  | s-12691-aa  |
| s-12692-aa | 12692-aa    | 6-050-4     | No  | dstn61      |
|            |             | lsn61       | 10  | s-12692-aa  |
| s-12693-aa | 12693-aa    | s-6-050-5   | No  | dstn62      |
|            |             | lsn62       | 10  | s-12693-aa  |
| s-08272-fr | 08300-fr    | -----       | No  | dstn49dupfr |
| s-08272-tk | 08300-tk    | 4-006-7     | No  | dstn49dupTk |

;

The following example displays point codes that have the private and spare point code subtype prefix (ps-).

**rtrv-rte:pcst=ps**

eagle10115 08-12-09 10:00:37 EST EAGLE 40.1.0

| DPCI       | ALIASA      | ALIASN/N24<br>LSN | RTX<br>RC | CLLI<br>APCI |
|------------|-------------|-------------------|-----------|--------------|
| ps-2-020-0 | -----       | -----             | No        | dstn21p      |
| ps-2-020-1 | 002-200-001 | -----             | No        | dstn22p      |
| ps-2-020-2 | -----       | 08258-aa          | No        | dstn23p      |
| ps-2-020-3 | -----       | s-08259-aa        | No        | dstn24p      |
| ps-2-020-4 | -----       | 002-200-004       | No        | dstn25p      |
| ps-2-020-5 | -----       | -----             | No        | dstn26p      |
| ps-2-020-6 | 002-200-005 | 08261-aa          | No        | dstn27p      |
| ps-2-020-7 | 002-200-007 | 002-200-007       | No        | dstn28p      |

| DPCI       | ALIASI  | ALIASN/N24<br>LSN | RTX<br>RC | CLLI<br>APCI |
|------------|---------|-------------------|-----------|--------------|
| ps-3-040-2 | 3-041-2 | -----             | No        | dstn35p      |
| ps-3-040-3 | 3-041-3 | 07467-aa          | No        | dstn36p      |
| ps-3-040-4 | 3-041-4 | s-07468-aa        | No        | dstn37p      |
| ps-3-040-5 | 3-041-5 | 003-041-005       | No        | dstn38p      |

| DPCI       | ALIASN     | ALIASN<br>LSN | RTX<br>RC | CLLI<br>APCI |
|------------|------------|---------------|-----------|--------------|
| ps-3-040-6 | s-07471-aa | 07471-aa      | No        | dstn39p      |
| ps-3-040-7 | 07472-aa   | s-07472-aa    | No        | dstn40p      |

| DPCN        | ALIASA      | ALIASI<br>LSN | RTX<br>RC | CLLI<br>APCN |
|-------------|-------------|---------------|-----------|--------------|
| ps-08272-aa | -----       | -----         | No        | dstn49p      |
| ps-08273-aa | 004-200-010 | -----         | No        | dstn50p      |
| ps-08274-aa | -----       | 4-050-2       | No        | dstn51p      |
| ps-08275-aa | -----       | s-4-050-3     | No        | dstn52p      |
| ps-08276-aa | 004-200-040 | 4-050-4       | No        | dstn53p      |
| ps-08277-aa | 004-200-050 | s-4-050-5     | No        | dstn54p      |

| DPCN        | ALIASI    | ALIASI<br>LSN | RTX<br>RC | CLLI<br>APCN |
|-------------|-----------|---------------|-----------|--------------|
| ps-08278-aa | s-4-050-6 | 4-050-6       | No        | dstn55p      |
| ps-08279-aa | 4-050-7   | s-4-050-7     | No        | dstn56p      |

| DPCN        | ALIASN   | ALIASI<br>LSN | RTX<br>RC | CLLI<br>APCN |
|-------------|----------|---------------|-----------|--------------|
| ps-12691-aa | 13691-aa | -----         | No        | dstn60p      |
| ps-12692-aa | 13692-aa | 6-060-4       | No        | dstn61p      |
| ps-12693-aa | 13693-aa | s-6-060-5     | No        | dstn62p      |

;

**rtrv-rte:dpc=40-1-\*\*\***

eagle10115 08-12-09 10:00:37 EST EAGLE 40.1.0

| DPCA        | ALIASI | ALIASN/N24<br>LSN | RTX<br>RC | CLLI<br>APCA |
|-------------|--------|-------------------|-----------|--------------|
| 040-001-*   | -----  | -----             | No        | myncaibeno   |
|             |        | lsn01             | 10        | 001-001-001  |
| 040-001-001 | -----  | -----             | No        | noncluster1  |
|             |        | lsn01             | 10        | 001-001-001  |
| 040-001-002 | -----  | -----             | No        | noncluster2  |
|             |        | lsn01             | 10        | 001-001-001  |

;



**rtrv-rte:dpc=40-\*\*\*-\*:lsn=lsn01**

eagle10115 08-12-09 10:00:37 EST EAGLE 40.1.0

| LSN   | DPCA        | RC |
|-------|-------------|----|
| lsn01 | 040-001-*   | 10 |
|       | 040-001-001 | 10 |
|       | 040-001-002 | 10 |

;

**rtrv-rte:dpcn=8199-\***

eagle10115 08-12-09 10:00:37 EST EAGLE 40.1.0

| DPCN     | ALIASA | ALIASI<br>LSN | RTX<br>RC | CLLI<br>APCN |
|----------|--------|---------------|-----------|--------------|
| 08199-fr | -----  | s-4-006-1     | No        | dstn48dupfr  |
| 08199-tk | -----  | 4-006-2       | No        | dstn48dupTk  |

| DPCN     | ALIASI  | ALIASI<br>LSN      | RTX<br>RC | CLLI<br>APCN       |
|----------|---------|--------------------|-----------|--------------------|
| 08199-aa | 4-000-7 | s-4-000-7<br>lsn48 | No<br>10  | dstn48<br>08199-aa |

;

**rtrv-rte:dpcn=8199-\*:lsn=lsn48**

eagle10115 08-12-09 10:00:37 EST EAGLE 40.1.0

| LSN   | DPCN     | RC |
|-------|----------|----|
| lsn48 | 08199-aa | 10 |

;

**rtrv-rte:dpcn=p-\*-aa**

eagle10115 08-12-09 10:00:37 EST EAGLE 40.1.0

| DPCN       | ALIASA      | ALIASI<br>LSN | RTX<br>RC | CLLI<br>APCN |
|------------|-------------|---------------|-----------|--------------|
| p-08192-aa | -----       | -----         | No        | dstn41p      |
| p-08193-aa | 004-200-001 | -----         | No        | dstn42p      |
| p-08194-aa | -----       | 4-040-2       | No        | dstn43p      |
| p-08195-aa | -----       | s-4-040-3     | No        | dstn44p      |
| p-08196-aa | 004-200-004 | 4-040-4       | No        | dstn45p      |
| p-08197-aa | 004-200-005 | s-4-040-5     | No        | dstn46p      |

| DPCN       | ALIASI    | ALIASI<br>LSN | RTX<br>RC | CLLI<br>APCN |
|------------|-----------|---------------|-----------|--------------|
| p-08198-aa | s-4-040-6 | 4-040-6       | No        | dstn47p      |
| p-08199-aa | 4-040-7   | s-4-040-7     | No        | dstn48p      |

| DPCN       | ALIASN     | ALIASI<br>LSN | RTX<br>RC | CLLI<br>APCN |
|------------|------------|---------------|-----------|--------------|
| p-12688-aa | s-13688-aa | -----         | No        | dstn57p      |
| p-12689-aa | s-13689-aa | 6-060-1       | No        | dstn58p      |
| p-12690-aa | s-13690-aa | s-6-060-2     | No        | dstn59p      |

;

**rtrv-rte:dpcn=s-9000-\***

eagle10115 08-12-09 10:00:37 EST EAGLE 40.1.0

| DPCN     | ALIASA | ALIASI<br>LSN | RTX<br>RC | CLLI<br>APCN |
|----------|--------|---------------|-----------|--------------|
| 09000-fr | -----  | s-4-007-1     | No        | dstn9xfr     |
| 09000-tk | -----  | 4-007-2       | No        | dstn9xtk     |

```

DPCN          ALIASI          ALIASI          RTX  CLLI
              ALIASI          LSN            RC    APCN
09000-aa      4-001-7          s-4-000-7      No   dstn9x
              ALIASI          LSN            10   09000-aa
    
```

;

This example displays the output when the **full** mode is requested. This example displays abbreviated output.

**rtrv-rte:mode=full**

eagle10115 08-12-09 10:00:37 EST EAGLE 40.1.0

```

DPCA          ALIASI          ALIASN/N24      RTX  CLLI
              ALIASI          LSN            RC    APCA
001-001-000   -----          -----          No   stp1
              ALIASI          LSN            10   001-001-000
              ALIASI          LSN            10   003-001-000
003-001-000   -----          -----          No   mstp
              ALIASI          LSN            10   003-001-000
004-001-000   -----          -----          No   stp4
              ALIASI          LSN            10   004-001-000
007-001-000   -----          -----          No   stp7
              ALIASI          LSN            10   007-001-000
002-101-001   -----          -----          No   ssp201
              ALIASI          LSN            10   002-101-001
              ALIASI          LSN            20   003-001-000
.
.
.
200-200-*     -----          -----          No   cluster2
005-006-001   -----          005-006-001   No   -----
001-001-001   -----          -----          No   dstn01
              ALIASI          LSN            10   001-001-001
p-001-001-001 -----          -----          No   dstn01p
001-001-002   1-001-2          -----          No   dstn02
              ALIASI          LSN            10   001-001-002
p-001-001-002 1-011-2          -----          No   dstn02p
001-001-003   s-1-001-3          -----          No   dstn03
              ALIASI          LSN            10   001-001-003
p-001-001-003 s-1-011-3          -----          No   dstn03p
001-001-004   -----          02060-aa       No   dstn04
              ALIASI          LSN            10   001-001-004
p-001-001-004 -----          01060-aa       No   dstn04p
001-070-001   -----          -----          No   tgtansi001
              ALIASI          LSN            10   001-001-001
              ALIASI          LSN            20   001-001-002
              ALIASI          LSN            30   001-001-003
              ALIASI          LSN            40   001-001-004
001-001-005   -----          s-02061-aa     No   dstn05
              ALIASI          LSN            10   001-001-005
p-001-001-005 -----          s-01061-aa     No   dstn05p
001-001-006   -----          001-001-006    No   dstn06
              ALIASI          LSN            10   001-001-006
.
.
.
200-002-001   -----          -----          Yes  rtxroute001
              ALIASI          LSN            10   001-002-004

              OPCA
001-001-001   ALIASI          LSN            15   001-002-003
001-002-001   ALIASI          LSN            99   001-002-002

              CIC - ECIC
0      9          LSN            1    001-002-002
10     16383     LSN            2    001-002-002
    
```

| DPCI        | ALIASA      | ALIASN/N24<br>LSN | RTX<br>RC | CLLI<br>APCI |
|-------------|-------------|-------------------|-----------|--------------|
|             | SI          |                   |           |              |
|             | 3           | lsn12             | 1         | 001-002-004  |
|             | 9           | lsn12             | 21        | 001-002-004  |
|             | 11          | lsn12             | 9         | 001-002-004  |
| 001-015-001 | s-1-015-1   | 02169-aa          | No        | gx25dstn001  |
| 001-015-002 | 1-015-2     | -----             | No        | gx25dstn002  |
|             |             | lsngx25a01        | 10        | 001-015-001  |
| .           |             |                   |           |              |
| .           |             |                   |           |              |
| .           |             |                   |           |              |
| s-4-002-0   | 010-001-001 | s-08228-aa        | No        | -----        |
| 2-010-0     | -----       | -----             | No        | dstn13       |
|             |             | lsn13             | 10        | 2-010-0      |
| p-2-010-0   | -----       | -----             | No        | dstn13p      |
| 2-010-1     | 002-010-001 | -----             | No        | dstn14       |
|             |             | lsn14             | 10        | 2-010-1      |
| p-2-010-1   | 002-100-001 | -----             | No        | dstn14p      |
| 2-010-2     | -----       | 04178-aa          | No        | dstn15       |
|             |             | lsn15             | 10        | 2-010-2      |
| p-2-010-2   | -----       | 08178-aa          | No        | dstn15p      |
| 2-010-3     | -----       | s-04179-aa        | No        | dstn16       |
|             |             | lsn16             | 10        | 2-010-3      |
| p-2-010-3   | -----       | s-08179-aa        | No        | dstn16p      |
| 2-070-1     | -----       | -----             | No        | tgtitui001   |
|             |             | lsn13             | 10        | 2-010-0      |
|             |             | lsn14             | 20        | 2-010-1      |
|             |             | lsn15             | 30        | 2-010-2      |
|             |             | lsn16             | 40        | 2-010-3      |
| 2-010-4     | -----       | 002-010-004       | No        | dstn17       |
|             |             | lsn17             | 10        | 2-010-4      |
| .           |             |                   |           |              |
| .           |             |                   |           |              |
| s-2-020-0   | -----       | -----             | No        | dstn21       |
|             |             | lsn21             | 10        | s-2-020-0    |
| ps-2-020-0  | -----       | -----             | No        | dstn21p      |
| s-2-020-1   | 002-020-001 | -----             | No        | dstn22       |
|             |             | lsn22             | 10        | s-2-020-1    |
| ps-2-020-1  | 002-200-001 | -----             | No        | dstn22p      |
| s-2-020-2   | -----       | 04258-aa          | No        | dstn23       |
|             |             | lsn23             | 10        | s-2-020-2    |
| ps-2-020-2  | -----       | 08258-aa          | No        | dstn23p      |
| s-2-020-3   | -----       | s-04259-aa        | No        | dstn24       |
|             |             | lsn24             | 10        | s-2-020-3    |
| ps-2-020-3  | -----       | s-08259-aa        | No        | dstn24p      |
| s-2-070-3   | -----       | -----             | No        | tgtitui003   |
|             |             | lsn21             | 10        | s-2-020-0    |
|             |             | lsn22             | 20        | s-2-020-1    |
|             |             | lsn23             | 30        | s-2-020-2    |
|             |             | lsn24             | 40        | s-2-020-3    |
| .           |             |                   |           |              |
| .           |             |                   |           |              |
| s-2-029-6   | 002-029-006 | s-04269-aa        | Yes       | rtxroute002  |
|             |             | lsn26             | 5         | s-2-020-5    |
|             | OPCI        |                   |           |              |
|             | 3-030-0     | lsn27             | 28        | s-2-020-6    |
|             | CIC - ECIC  |                   |           |              |

|            |             |             |       |            |           |
|------------|-------------|-------------|-------|------------|-----------|
|            | 34          | 44          | lsn27 | 6          | s-2-020-6 |
|            | 45          | 55          | lsn27 | 16         | s-2-020-6 |
|            | SI          |             |       |            |           |
|            | 3           |             | lsn27 | 7          | s-2-020-6 |
|            | 15          |             | lsn27 | 14         | s-2-020-6 |
| DPCI       | ALIASI      | ALIASN/N24  | RTX   | CLLI       |           |
|            |             | LSN         | RC    | APCI       |           |
| 3-030-0    | s-3-030-0   | -----       | No    | dstn29     |           |
|            |             | lsn29       | 10    | 3-030-0    |           |
| p-3-030-0  | s-3-031-0   | -----       | No    | dstn29p    |           |
| 3-030-1    | s-3-030-1   | 06385-aa    | No    | dstn30     |           |
|            |             | lsn30       | 10    | 3-030-1    |           |
| p-3-030-1  | s-3-031-1   | 07385-aa    | No    | dstn30p    |           |
| 3-030-2    | s-3-030-2   | s-06386-aa  | No    | dstn31     |           |
|            |             | lsn31       | 10    | 3-030-2    |           |
| p-3-030-2  | s-3-031-2   | s-07386-aa  | No    | dstn31p    |           |
| 3-070-1    | s-3-070-1   | -----       | No    | tgtitui005 |           |
|            |             | lsn29       | 10    | 3-030-0    |           |
|            |             | lsn30       | 20    | 3-030-1    |           |
|            |             | lsn31       | 30    | 3-030-2    |           |
| 3-030-3    | s-3-030-3   | 003-030-003 | No    | dstn32     |           |
|            |             | lsn32       | 10    | 3-030-3    |           |
| p-3-030-3  | s-3-031-3   | 003-031-003 | No    | dstn32p    |           |
| 3-070-2    | s-3-070-2   | -----       | No    | tgtitui006 |           |
|            |             | lsn32       | 10    | 3-030-3    |           |
|            |             | lsn33       | 20    | 3-030-4    |           |
|            |             | lsn34       | 30    | 3-030-5    |           |
| s-3-040-2  | 3-040-2     | -----       | No    | dstn35     |           |
|            |             | lsn35       | 10    | s-3-040-2  |           |
| ps-3-040-2 | 3-041-2     | -----       | No    | dstn35p    |           |
| s-3-040-3  | 3-040-3     | 06467-aa    | No    | dstn36     |           |
|            |             | lsn36       | 10    | s-3-040-3  |           |
| ps-3-040-3 | 3-041-3     | 07467-aa    | No    | dstn36p    |           |
| s-3-040-4  | 3-040-4     | s-06468-aa  | No    | dstn37     |           |
|            |             | lsn37       | 10    | s-3-040-4  |           |
| ps-3-040-4 | 3-041-4     | s-07468-aa  | No    | dstn37p    |           |
| s-3-040-5  | 3-040-5     | 003-040-005 | No    | dstn38     |           |
|            |             | lsn38       | 10    | s-3-040-5  |           |
| ps-3-040-5 | 3-041-5     | 003-041-005 | No    | dstn38p    |           |
| DPCI       | ALIASN      | ALIASN      | RTX   | CLLI       |           |
|            |             | LSN         | RC    | APCI       |           |
| 3-030-4    | s-06388-aa  | 06388-aa    | No    | dstn33     |           |
|            |             | lsn33       | 10    | 3-030-4    |           |
| p-3-030-4  | s-07388-aa  | 07388-aa    | No    | dstn33p    |           |
| 3-030-5    | 06389-aa    | s-06389-aa  | No    | dstn34     |           |
|            |             | lsn34       | 10    | 3-030-5    |           |
| p-3-030-5  | 07389-aa    | s-07389-aa  | No    | dstn34p    |           |
| s-3-040-6  | s-06471-aa  | 06471-aa    | No    | dstn39     |           |
|            |             | lsn39       | 10    | s-3-040-6  |           |
| ps-3-040-6 | s-07471-aa  | 07471-aa    | No    | dstn39p    |           |
| s-3-040-7  | 06472-aa    | s-06472-aa  | No    | dstn40     |           |
|            |             | lsn40       | 10    | s-3-040-7  |           |
| ps-3-040-7 | 07472-aa    | s-07472-aa  | No    | dstn40p    |           |
| DPCN       | ALIASA      | ALIASI      | RTX   | CLLI       |           |
|            |             | LSN         | RC    | APCN       |           |
| 06157-aa   | 020-005-002 | -----       | No    | -----      |           |
| 08192-aa   | -----       | -----       | No    | dstn41     |           |
|            |             | lsn41       | 10    | 08192-aa   |           |
| p-08192-aa | -----       | -----       | No    | dstn41p    |           |
| 08193-aa   | 004-000-001 | -----       | No    | dstn42     |           |

Commands

rtrv-rte

|             |             |           |     |            |
|-------------|-------------|-----------|-----|------------|
|             |             | lsn42     | 10  | 08193-aa   |
| p-08193-aa  | 004-200-001 | -----     | No  | dstn42p    |
| 08194-aa    | -----       | 4-000-2   | No  | dstn43     |
|             |             | lsn43     | 10  | 08194-aa   |
| p-08194-aa  | -----       | 4-040-2   | No  | dstn43p    |
| 08195-aa    | -----       | s-4-000-3 | No  | dstn44     |
|             |             | lsn44     | 10  | 08195-aa   |
| p-08195-aa  | -----       | s-4-040-3 | No  | dstn44p    |
| 08753-aa    | -----       | -----     | No  | tgtitun001 |
|             |             | lsn41     | 10  | 08192-aa   |
|             |             | lsn42     | 20  | 08193-aa   |
|             |             | lsn43     | 30  | 08194-aa   |
|             |             | lsn44     | 30  | 08195-aa   |
| 08196-aa    | 004-000-004 | 4-000-4   | No  | dstn45     |
|             |             | lsn45     | 10  | 08196-aa   |
| p-08196-aa  | 004-200-004 | 4-040-4   | No  | dstn45p    |
| 08197-aa    | 004-000-005 | s-4-000-5 | No  | dstn46     |
|             |             | lsn46     | 10  | 08197-aa   |
| p-08197-aa  | 004-200-005 | s-4-040-5 | No  | dstn46p    |
| 08754-aa    | -----       | -----     | No  | tgtitun002 |
|             |             | lsn45     | 10  | 08196-aa   |
|             |             | lsn46     | 20  | 08197-aa   |
|             |             | lsn47     | 30  | 08198-aa   |
|             |             | lsn48     | 30  | 08199-aa   |
| s-08272-aa  | -----       | -----     | No  | dstn49     |
|             |             | lsn49     | 10  | s-08272-aa |
| ps-08272-aa | -----       | -----     | No  | dstn49p    |
| s-08273-aa  | 004-010-001 | -----     | No  | dstn50     |
|             |             | lsn50     | 10  | s-08273-aa |
| ps-08273-aa | 004-200-010 | -----     | No  | dstn50p    |
| s-08274-aa  | -----       | 4-010-2   | No  | dstn51     |
|             |             | lsn51     | 10  | s-08274-aa |
| ps-08274-aa | -----       | 4-050-2   | No  | dstn51p    |
| s-08275-aa  | -----       | s-4-010-3 | No  | dstn52     |
|             |             | lsn52     | 10  | s-08275-aa |
| ps-08275-aa | -----       | s-4-050-3 | No  | dstn52p    |
| s-08755-aa  | -----       | -----     | No  | tgtitun003 |
|             |             | lsn49     | 10  | s-08272-aa |
|             |             | lsn50     | 20  | s-08273-aa |
|             |             | lsn51     | 30  | s-08274-aa |
|             |             | lsn52     | 30  | s-08275-aa |
| .           |             |           |     |            |
| .           |             |           |     |            |
| .           |             |           |     |            |
| DPCN        | ALIASI      | ALIASI    | RTX | CLLI       |
|             |             | LSN       | RC  | APCN       |
| 08198-aa    | s-4-000-6   | 4-000-6   | No  | dstn47     |
|             |             | lsn47     | 10  | 08198-aa   |
| p-08198-aa  | s-4-040-6   | 4-040-6   | No  | dstn47p    |
| 08199-aa    | 4-000-7     | s-4-000-7 | No  | dstn48     |
|             |             | lsn48     | 10  | 08199-aa   |
| p-08199-aa  | 4-040-7     | s-4-040-7 | No  | dstn48p    |
| s-08278-aa  | s-4-010-6   | 4-010-6   | No  | dstn55     |
|             |             | lsn55     | 10  | s-08278-aa |
| ps-08278-aa | s-4-050-6   | 4-050-6   | No  | dstn55p    |
| s-08279-aa  | 4-010-7     | s-4-010-7 | No  | dstn56     |
|             |             | lsn56     | 10  | s-08279-aa |
| ps-08279-aa | 4-050-7     | s-4-050-7 | No  | dstn56p    |
| s-08379-aa  | s-4-058-7   | 4-058-7   | Yes | rtxrout003 |
|             |             | lsn55     | 80  | s-08278-aa |
|             | OPCN        |           |     |            |
|             | s-08278-aa  | lsn62     | 8   | s-12693-aa |
|             | CIC - ECIC  |           |     |            |

```

          99    100      lsn62      9  s-12693-aa
          999  1989    lsn62      99 s-12693-aa

          SI
          4          lsn56      29 s-08279-aa
          14        lsn56      44 s-08279-aa

08198-fr    s-4-005-7      4-005-7      No  dstn47dupfr
08198-tk    4-006-0      s-4-006-0    No  dstn47dupTk

DPCN       ALIASN       ALIASI       RTX  CLLI
          LSN          RC          APCN
12688-aa   s-12688-aa   -----    No  dstn57
          lsn57          10        12688-aa
p-12688-aa s-13688-aa   -----    No  dstn57p
.
.
.
DPCN24    ALIASA       ALIASI       RTX  CLLI
          LSN          RC          APCN24
003-003-004 003-003-003 3-003-4     No  -----
006-005-001 -----    -----    No  dstn63
          lsn63          10        006-005-001
p-006-005-001 -----    -----    No  dstn63p
.
.
.
;

```

**Legend**

**DPC, DPCA, DPCI, DPCN, DPCN24**—The destination point code to be reached through this route.

**ALIAS, ALIASA, ALIASI, ALIASN/N24**—The alias associated with the route.

**CLLI**—The CLLI associated with the route.

**LSN**—The name of the linkset assigned to this route.

**RC**—The relative cost (priority) assigned to the route.

**APC, APCA, APCI, APCN, APCN24**—The point code of the STP or SSP that is directly adjacent to the linkset. The point code may or may not be the same as the destination point code assigned to this route.

**rtrv-rtx****Retrieve Exception Route**

Use this command to retrieve one or more exception route entries. Because all parameters are optional, the retrieve examines the entire Route table to find all entries that match the specified parameters. Entries with CIC-ECIC range values that fall in the range specified by the **cic** and **ecic** parameters are displayed.

**Keyword:** rtrv-rtx

**Related Commands:** chg-rtx, dlt-rtx, ent-rtx, rept-stat-rtx

**Command Class:** Database Administration

**Parameters**

**:cic=** (optional)

Starting Circuit Identification Code. This parameter is used alone or together with the **ecic** parameter as exception routing criteria for the specified exception route.

**Range:** 0-16383

**:class=** (optional)

Exception routing class. This parameter causes all exception route sets provisioned for the specified class to be displayed.

**Range:** **opc, ilsn, cic, si**

**:dpc=** (optional)

ANSI destination point code with subfields *network indicator-network cluster-network cluster member (ni-nc-ncm)*. The *prefix* subfield indicates a private point code (*prefix-ni-nc-ncm*).

**Synonym:** **dpca**

**Range:** **p-, 000-255, \*, \*\*, \*\*\***

Specify a valid value for each subfield of the point code, and separate the subfields with a dash (-).

*prefix*—**p-**

The asterisk values \*, \*\*, and \*\*\* are not valid for the *ni* subfield.

If \*\* or \*\*\* is specified for the *nc* subfield, either \*, \*\*, or \*\*\* must be specified for the *ncm* subfield.

When **chg-sid:pctype=ansi** is specified, *ni* = **000** is not valid.

When **chg-sid:pctype=ansi** is specified, *nc* = **000** is not valid if *ni* = **001-005**.

When **chg-sid:pctype=ansi** is specified, *nc* = **000** is valid if *ni* = **006-255**.

When **chg-sid:pctype=ansi** is specified, *ni*-\*-\* is valid if *ni* = **006-255**.

The point code **000-000-000** is not a valid point code.

**:dpci=** (optional)

Destination Point Code. ITU international point code with subfields *zone-area-id*. The *prefix* subfield indicates a spare point code, private point code, or private and spare point code (*prefix-zone-area-id*).

**Range:** **s-, p-, ps-, 0-255**

Specify a valid value for each subfield of the point code, and separate the subfields with a dash (-).

*prefix*—**s-, p-, ps-**

*zone*—**0-7**

*area*—**000-255**

*id*—**0-7**

The point code **0-000-0** is not a valid point code.

**:dpcn=** (optional)

ITU national point code in the format of a 5-digit number (*nnnnn*); or 2, 3, or 4 numbers (members) separated by dashes (*m1-m2-m3-m4*) as defined by the **chg-stpopts:npcfmti** flexible point code option. A group code must be specified with the ITUDUPPC feature is turned on (*nnnnn-gc, m1-m2-m3-m4-gc*). The *prefix* subfield indicates a spare point code, private point code, or private and spare point code (*prefix-nnnnn, prefix-nnnnn-gc, prefix-m1-m2-m3-m4, prefix-m1-m2-m3-m4-gc*).

**Range:** **s-, p-, ps-, 0-16383, aa-zz, \***

Specify a valid value for each subfield of the point code, and separate the subfields with a dash (-).

An asterisk (\*) can be specified for the node (*nnnnn* or every member of a flexible point code) or for the group code (*gc*) only when group codes are present in the point codes.

An asterisk (\*) can be specified either for the node or for the group code, but not both.

*prefix*—**s-, p-, ps-**

*nnnnn*—**0-16383, \***

*gc*—**aa-zz**, \*

*m1-m2-m3-m4*—**0-14** for each member; values must sum to 14; or *\*-\*-\** when the point code includes a group code.

**:dpcn24=** (optional)

24-bit ITU national point code with subfields *main signaling area-sub signaling area-signaling point (msa-ssa-sp)*. The *prefix* subfield indicates a private point code (*prefix-msa-ssa-sp*).

**Range:** **p-**, **000-255**

Specify a valid value for each subfield of the point code, and separate the subfields with a dash (-).

*prefix*—**p-**

*msa*—**000-255**

*ssa*—**000-255**

*sp*—**000-255**

**:ecic=** (optional)

Ending Circuit Identification Code. This parameter, together with the **cic** parameter, defines the CIC range that is used as exception routing criteria for the specified exception route.

**Range:** **0-16383**

**:ilsn=** (optional)

Incoming Link Set Name. This parameter contains the name of the originating linkset. The parameter value is used as part of the exception routing criteria for the specified exception route.

**Range:** *ayyyyyyyyy*

1 alphabetic character followed by up to 9 alphanumeric characters.

**:lsn=** (optional)

Link Set Name. The linkset associated with the specified exception route.

**Range:** *ayyyyyyyyy*

1 alphabetic character followed by up to 9 alphanumeric characters.

**:opc=** (optional)

ANSI origination point code with subfields *network indicator-network cluster-network cluster member (ni-nc-ncm)*. The *prefix* subfield indicates a private point code (*prefix-ni-nc-ncm*).

**Range:** **p-**, **000-255**, **\***, **\*\***, **\*\*\***

Specify a valid value for each subfield of the point code, and separate the subfields with a dash (-).

*prefix*—**p-**

The asterisk values **\***, **\*\***, and **\*\*\*** are not valid for the *ni* subfield.

If **\*\*** or **\*\*\*** is specified for the *nc* subfield, either **\***, **\*\***, or **\*\*\*** must be specified for the *ncm* subfield.

When **chg-sid:pctype=ansi** is specified, *ni* = **000** is not valid.

When **chg-sid:pctype=ansi** is specified, *nc* = **000** is not valid if *ni* = **001-005**.

When **chg-sid:pctype=ansi** is specified, *nc* = **000** is valid if *ni* = **006-255**.

When **chg-sid:pctype=ansi** is specified, *ni*-\*-\* is valid if *ni* = **006-255**.

The point code **000-000-000** is not a valid point code.

**:opci=** (optional)

ITU international point code with subfields *zone-area-id*. The *prefix* subfield indicates a spare point code, private point code, or private and spare point code (*prefix-zone-area-id*).

**Range:** **s-**, **p-**, **ps-**, **0-255**



Specify a valid value for each subfield of the point code, and separate the subfields with a dash (-).

*prefix*—**s-, p-, ps-**

*zone*—**0-7**

*area*—**000-255**

*id*—**0-7**

The point code **0-000-0** is not a valid point code.

**:open=** (optional)

ITU national point code in the format of a 5-digit number (*nnnnn*); or 2, 3, or 4 numbers (members) separated by dashes (*m1-m2-m3-m4*) as defined by the **chg-stpopts:npcfmti** flexible point code option. A group code must be specified with the ITUDUPPC feature is turned on (*nnnnn-gc*, *m1-m2-m3-m4-gc*). The *prefix* subfield indicates a spare point code, private point code, or private and spare point code (*prefix-nnnnn*, *prefix-nnnnn-gc*, *prefix-m1-m2-m3-m4*, *prefix-m1-m2-m3-m4-gc*).

**Range:** **s-, p-, ps-, 0-16383, aa-zz, \***

Specify a valid value for each subfield of the point code, and separate the subfields with a dash (-).

An asterisk (\*) can be specified for the node (*nnnnn* or every member of a flexible point code) or for the group code (*gc*) only when group codes are present in the point codes.

An asterisk (\*) can be specified either for the node or for the group code, but not both.

*prefix*—**s-, p-, ps-**

*nnnnn*—**0-16383, \***

*gc*—**aa-zz, \***

*m1-m2-m3-m4*—**0-14** for each member; values must sum to 14; or **\*-\*-\*-\*** when the point code includes a group code.

**:open24=** (optional)

24-bit ITU national point code with subfields *main signaling area-sub signaling area-signaling point* (*msa-ssa-sp*). The *prefix* subfield indicates a private point code (*prefix-msa-ssa-sp*).

**Range:** **p-, 000-255**

Specify a valid value for each subfield of the point code, and separate the subfields with a dash (-).

*prefix*—**p-**

*msa*—**000-255**

*ssa*—**000-255**

*sp*—**000-255**

**:si=** (optional)

Service Indicator. This parameter is used as part of the exception routing criteria for the specified exception route.

**Range:** **3-15**

**Example**

**rtrv-rtx:dpca=1-1-1**

**rtrv-rtx:opca=6-\*-\***

**rtrv-rtx:ilsn=1set4**

**rtrv-rtx:si=5**

**rtrv-rtx:cic=0:ecic=16383**

## Dependencies

Only one of the **opc**, **ilsn**, **cic**, **si**, or **class** parameters can be specified.

If the **ecic** parameter is specified, the **cic** parameter must also be specified.

The **ecic** parameter value cannot be less than the **cic** parameter value.

The Origin-Based MTP Routing feature must be enabled and turned on before this command can be entered.

The linkset name, as defined by the **ilsn** or **lsn** parameter, must exist.

The value specified for the destination point code must be a full point code and not a cluster or network point code.

## Notes

\*\* can be used in the network cluster member (*ncm*) subfield of **dpc/dpca** and **opc/opca** parameters to retrieve all point codes residing in (members of) a given network cluster (*ni-nc*).

\*\* can be used in the network cluster (*nc*) subfield of **dpc/dpca** and **opc/opca** parameters to retrieve all point codes residing in (members of) a given network (*ni*).

\*\*\* can be used in the network cluster member (*ncm*) subfield of **dpc/dpca/opc/opca** to retrieve all point codes residing in (members of) a given network cluster (*ni-nc*), and the network cluster address (if any).

\*\*\* can be used in the network cluster (*nc*) subfield of **dpc/dpca** and **opc/opca** to retrieve all point codes residing in (members of) a given network (*ni*), and the network address (if any).

\* is allowed only for retrieves (for example, **rtrv-rtx:dpcn=-aa** or **rtrv-rtx:opc=-xy**) on ITU-N DPCs and ITU-N OPCs if the ITUDUPPC feature is on. \*\* and \*\*\* is not allowed for ITU-N DPCs and OPCs (for example, **dpcn=-\*-xy** is rejected). The node and group code cannot both be \* (**dpcn=-\*-\*** is rejected).

**Output**

Retrieve all provisioned exception routes.

**rtrv-rtx**

eagle10115 08-12-09 10:00:37 EST EAGLE 40.1.0

| DPCA                                | RTX-CRITERIA | LSN   | RC | APC         |
|-------------------------------------|--------------|-------|----|-------------|
| 200-002-001                         | OPCA         |       |    |             |
|                                     | 001-001-001  | lsn11 | 15 | 001-002-003 |
|                                     | 001-002-001  | lsn10 | 99 | 001-002-002 |
|                                     | CIC - ECIC   |       |    |             |
|                                     | 0 9          | lsn10 | 1  | 001-002-002 |
|                                     | 10 16383     | lsn10 | 2  | 001-002-002 |
|                                     | SI           |       |    |             |
|                                     | 3            | lsn12 | 1  | 001-002-004 |
|                                     | 9            | lsn12 | 21 | 001-002-004 |
|                                     | 11           | lsn12 | 9  | 001-002-004 |
| DPCI                                | RTX-CRITERIA | LSN   | RC | APC         |
| s-2-029-6                           | OPCI         |       |    |             |
|                                     | 3-030-0      | lsn27 | 28 | s-2-020-6   |
|                                     | CIC - ECIC   |       |    |             |
|                                     | 34 44        | lsn27 | 6  | s-2-020-6   |
|                                     | 45 55        | lsn27 | 16 | s-2-020-6   |
|                                     | SI           |       |    |             |
|                                     | 3            | lsn27 | 7  | s-2-020-6   |
|                                     | 15           | lsn27 | 14 | s-2-020-6   |
| DPCN                                | RTX-CRITERIA | LSN   | RC | APC         |
| s-08379-aa                          | OPCN         |       |    |             |
|                                     | s-08278-aa   | lsn62 | 8  | s-12693-aa  |
|                                     | CIC - ECIC   |       |    |             |
|                                     | 99 100       | lsn62 | 9  | s-12693-aa  |
|                                     | 999 1989     | lsn62 | 99 | s-12693-aa  |
|                                     | SI           |       |    |             |
|                                     | 4            | lsn56 | 29 | s-08279-aa  |
|                                     | 14           | lsn56 | 44 | s-08279-aa  |
| DESTINATION ENTRIES ALLOCATED: 2000 |              |       |    |             |
| FULL DPC(s): 188                    |              |       |    |             |
| EXCEPTION DPC(s): 17                |              |       |    |             |
| NETWORK DPC(s): 2                   |              |       |    |             |
| CLUSTER DPC(s): 4                   |              |       |    |             |
| TOTAL DPC(s): 211                   |              |       |    |             |
| CAPACITY (% FULL): 11%              |              |       |    |             |
| ALIASES ALLOCATED: 12000            |              |       |    |             |
| ALIASES USED: 216                   |              |       |    |             |
| CAPACITY (% FULL): 2%               |              |       |    |             |
| X-LIST ENTRIES ALLOCATED: 500       |              |       |    |             |

;

Retrieve all exception routes provisioned for a specific DPC.

**rtrv-rtx:dpcn=s-08379-aa**

eagle10115 08-12-09 10:00:37 EST EAGLE 40.1.0

| DPCN       | RTX-CRITERIA       | LSN   | RC | APC        |
|------------|--------------------|-------|----|------------|
| s-08379-aa | OPCN<br>s-08278-aa | lsn62 | 8  | s-12693-aa |
|            | CIC - ECIC         |       |    |            |
|            | 99 100             | lsn62 | 9  | s-12693-aa |
|            | 999 1989           | lsn62 | 99 | s-12693-aa |
|            | SI                 |       |    |            |
|            | 4                  | lsn56 | 29 | s-08279-aa |
|            | 14                 | lsn56 | 44 | s-08279-aa |

DESTINATION ENTRIES ALLOCATED: 2000  
 FULL DPC(s): 188  
 EXCEPTION DPC(s): 17  
 NETWORK DPC(s): 2  
 CLUSTER DPC(s): 4  
 TOTAL DPC(s): 211  
 CAPACITY (% FULL): 11%  
 ALIASES ALLOCATED: 12000  
 ALIASES USED: 216  
 CAPACITY (% FULL): 2%  
 X-LIST ENTRIES ALLOCATED: 500

;  
 Retrieve all provisioned exception routes for a specific exception criteria.

**rtrv-rtx:dpcn=s-08379-aa:opcn=s-08278-aa**

eagle10115 08-12-09 10:00:37 EST EAGLE 40.1.0

| DPCN       | RTX-CRITERIA       | LSN   | RC | APC        |
|------------|--------------------|-------|----|------------|
| s-08379-aa | OPCN<br>s-08278-aa | lsn62 | 8  | s-12693-aa |

DESTINATION ENTRIES ALLOCATED: 2000  
 FULL DPC(s): 188  
 EXCEPTION DPC(s): 17  
 NETWORK DPC(s): 2  
 CLUSTER DPC(s): 4  
 TOTAL DPC(s): 211  
 CAPACITY (% FULL): 11%  
 ALIASES ALLOCATED: 12000  
 ALIASES USED: 216  
 CAPACITY (% FULL): 2%  
 X-LIST ENTRIES ALLOCATED: 500

;  
 Retrieve all provisioned exception routes for a specific exception criteria.

**rtrv-rtx:dpci=s-2-029-6:cic=45:ecic=55**

eagle10115 08-12-09 10:00:37 EST EAGLE 40.1.0

| DPCI      | RTX-CRITERIA        | LSN   | RC | APC       |
|-----------|---------------------|-------|----|-----------|
| s-2-029-6 | CIC - ECIC<br>45 55 | lsn27 | 16 | s-2-020-6 |

DESTINATION ENTRIES ALLOCATED: 2000  
 FULL DPC(s): 188  
 EXCEPTION DPC(s): 17  
 NETWORK DPC(s): 2  
 CLUSTER DPC(s): 4  
 TOTAL DPC(s): 211  
 CAPACITY (% FULL): 11%

```
ALIASES ALLOCATED:          12000
ALIASES USED:              216
CAPACITY (% FULL):        2%
X-LIST ENTRIES ALLOCATED:  500
```

;  
Retrieve exception routes for a specific class.

**rtrv-rtx:opc=1-1-1**

```
eagle10115 08-12-09 10:00:37 EST EAGLE 40.1.0
```

| DPCA        | RTX-CRITERIA        | LSN   | RC | APC         |
|-------------|---------------------|-------|----|-------------|
| 200-002-001 | OPCA<br>001-001-001 | lsn11 | 15 | 001-002-003 |

```
DESTINATION ENTRIES ALLOCATED:  2000
FULL DPC(s):                    188
EXCEPTION DPC(s):                17
NETWORK DPC(s):                  2
CLUSTER DPC(s):                  4
TOTAL DPC(s):                    211
CAPACITY (% FULL):              11%
ALIASES ALLOCATED:              12000
ALIASES USED:                    216
CAPACITY (% FULL):              2%
X-LIST ENTRIES ALLOCATED:      500
```

;  
Retrieve exception routes for a specific linkset.

**rtrv-rtx:lsn=lsn27**

```
eagle10115 08-12-09 10:00:37 EST EAGLE 40.1.0
```

| DPCI      | RTX-CRITERIA        | LSN   | RC | APC       |
|-----------|---------------------|-------|----|-----------|
| s-2-029-6 | OPCI<br>3-030-0     | lsn27 | 28 | s-2-020-6 |
|           | CIC - ECIC<br>34 44 | lsn27 | 6  | s-2-020-6 |
|           | 45 55               | lsn27 | 16 | s-2-020-6 |
|           | SI<br>3             | lsn27 | 7  | s-2-020-6 |
|           | 15                  | lsn27 | 14 | s-2-020-6 |

```
DESTINATION ENTRIES ALLOCATED:  2000
FULL DPC(s):                    188
EXCEPTION DPC(s):                17
NETWORK DPC(s):                  2
CLUSTER DPC(s):                  4
TOTAL DPC(s):                    211
CAPACITY (% FULL):              11%
ALIASES ALLOCATED:              12000
ALIASES USED:                    216
CAPACITY (% FULL):              2%
X-LIST ENTRIES ALLOCATED:      500
```

;  
Retrieve exception routes for the network cluster members of an OPC.

**rtrv-rtx:opc=40-\*\*-\***

```
eagle10115 08-12-09 10:00:37 EST EAGLE 40.1.0
```

| DPCA | RTX-CRITERIA | LSN | RC | APC |
|------|--------------|-----|----|-----|
|------|--------------|-----|----|-----|

```

002-002-003      OPCA
                  040-001-001      bd1      10      002-002-002
                  040-001-002      bd1      15      002-002-002
                  040-001-*        bd1      5       002-002-002

DESTINATION ENTRIES ALLOCATED:  2000
FULL DPC(s):                    190
EXCEPTION DPC(s):                21
NETWORK DPC(s):                  2
CLUSTER DPC(s):                  4
TOTAL DPC(s):                    217
CAPACITY (% FULL):               11%
ALIASES ALLOCATED:              12000
ALIASES USED:                    216
CAPACITY (% FULL):               2%
X-LIST ENTRIES ALLOCATED:       500
    
```

;

Retrieve exception routes for all cluster member plus itself of an OPC.

**rtrv-rtx:opc=40-\*\*\*-\***

```

eagle10115 08-12-09 10:00:37 EST EAGLE 40.1.0

DPCA      RTX-CRITERIA      LSN      RC      APC

002-002-003      OPCA
                  040-001-001      bd1      10      002-002-002
                  040-001-002      bd1      15      002-002-002
                  040-*-*        bd1      0       002-002-002
                  040-001-*        bd1      5       002-002-002

DESTINATION ENTRIES ALLOCATED:  2000
FULL DPC(s):                    190
EXCEPTION DPC(s):                21
NETWORK DPC(s):                  2
CLUSTER DPC(s):                  4
TOTAL DPC(s):                    217
CAPACITY (% FULL):               11%
ALIASES ALLOCATED:              12000
ALIASES USED:                    216
CAPACITY (% FULL):               2%
X-LIST ENTRIES ALLOCATED:       500
    
```

;

Retrieve route exceptions by criteria class.

**rtrv-rtx:class=cic**

```

eagle10115 08-12-09 10:00:37 EST EAGLE 40.1.0

DPCA      RTX-CRITERIA      LSN      RC      APC

200-002-001      CIC - ECIC
                  0      9      lsn10      1      001-002-002
                  10     16383     lsn10      2      001-002-002

DPCI      RTX-CRITERIA      LSN      RC      APC

s-2-029-6      CIC - ECIC
                  34     44      lsn27      6      s-2-020-6
                  45     55      lsn27      16     s-2-020-6

DPCN      RTX-CRITERIA      LSN      RC      APC

s-08379-aa      CIC - ECIC
                  99     100     lsn62      9      s-12693-aa
    
```

```

          999   1989           lsn62           99  s-12693-aa

DESTINATION ENTRIES ALLOCATED:  2000
FULL DPC(s):                    188
EXCEPTION DPC(s):               17
NETWORK DPC(s):                 2
CLUSTER DPC(s):                 4
TOTAL DPC(s):                   211
CAPACITY (% FULL):              11%
ALIASES ALLOCATED:              12000
ALIASES USED:                   216
CAPACITY (% FULL):              2%
X-LIST ENTRIES ALLOCATED:       500

```

;

## rtrv-sccp-msg

## Retrieve Configured SCCP messages

Use this command to display the configured SCCP message parameter values.

**NOTE: The Flexible Linkset Optional Based Routing (FLOBR) feature must be turned on before this command can be entered.**

**Keyword:** rtrv-sccp-msg

**Related Commands:** chg-sccp-msg, tst-msg

**Command Class:** Database Administration

### Parameters

**:msgn=** (optional)

Message number. This parameter specifies the number of the SCCP message.

**Range:** 1-10

### Example

```
rtrv-sccp-msg:msgn=1
```

### Dependencies

The FLOBR feature must be turned on before this command can be entered.

## Output

```

rtrv-sccp-msg:msgn=1
tekelecstp 09-03-30 16:10:59 EST EAGLE 41.0.0
MSG = 1
ACTIVE = YES
OPC = 010-010-010

CDPA_GTI = 2
CDPA_TT = 0
CDPA_SSN = 6
CDPCI = 3-004-5
CDPA_NP = 1 ( e164 )
CDPA_NAI = 1 ( sub )
CDPA_GTA = 1234567890

CGPA_GTI = 2
CGPA_TT = 0
CGPA_SSN = 8
CGPC = 020-020-020
CGPA_NP = 1 ( e164 )
CGPA_NAI = 1 ( sub )
CGPA_GTA = 1234567890

LSN = ls111
EAGLEGEN = NO

```

;

The following example displays output when the TCAP Opcode Based Routing feature is turned on.

```

rtrv-sccp-msg:msgn=1
tekelecstp 09-03-02 16:17:34 EST EAGLE 41.0.0
MSG = 1
ACTIVE = YES
OPC = 010-010-010

CDPA_GTI = 2
CDPA_TT = 0
CDPA_SSN = 6
CDPC = 010-010-010
CDPA_NP = 1 ( e164 )
CDPA_NAI = 1 ( sub )
CDPA_GTA = 1234567890

CGPA_GTI = 2
CGPA_TT = 0
CGPA_SSN = 8
CGPC = 020-020-020
CGPA_NP = 1 ( e164 )
CGPA_NAI = 1 ( sub )
CGPA_GTA = 1234567890

LSN = ls111
EAGLEGEN = NO

TCAP_FAMILY = 67

TCAP_OPCODE = 32

TCAP_PACKAGE = bgn (0x62)

TCAP_ACN = 6-7-8-9-3

```

;



**rtrv-sccp-serv****Retrieve SCCP Service**

Use this command to display the SCCP Service application relationship information maintained by the EAGLE 5 ISS.

**Keyword:** rtrv-sccp-serv

**Related Commands:** chg-sccp-serv, dlt-sccp-serv

**Command Class:** Basic

**Parameters**

**:serv=** (optional)

Name of the service to be retrieved.

**Range:** gflex, gport, mnp

**gflex** — G-Flex (GSM Flexible Numbering)

**gport** — G-Port (GSM Mobile Number Portability)

**mnp** — Mobile Number Portability

**Dependencies**

- The A-Port or IGM feature must be enabled before the **serv=mnp** parameter can be specified.
- The G-Flex feature must be enabled before the **serv=gflex** parameter can be specified.
- The G-Port feature must be enabled before the **serv=gport** parameter can be specified.

**Notes**

Point codes are grouped by service in the output.

**Output**

The number of entries that is reported in use for the SCCPSRV table includes an entry for each point code network type. This entry is not displayed with the point code entries in the output. For example, if 3 ANSI point codes are used, the reported number of ANSI entries is 4.

The following example displays output when no supporting features are turned on, and the SCCP Service table is empty.

**rtrv-sccp-serv**

```
tekelecstp 06-10-30 09:26:14 EST  EAGLE 36.0.0
No Entries Found.
```

;

The following example displays output when the G-Port feature is turned on, and the SCCP Service table is empty.

**rtrv-sccp-serv**

```
tekelecstp 06-10-30 09:26:14 EST  EAGLE 36.0.0
```

```
-----
Service      : GPORT
State        : Offline
GTT Option   : Yes
-----
```

```
SCCPSRV table is (0 of 384) 0% full.
```

;

The following example displays output when the G-Port and G-Flex features are turned on, and the SCCP Service table is empty.

**rtrv-sccp-serv**

```
tekelecstp 06-10-30 09:26:47 EST  EAGLE 36.0.0
```

```
-----
Service      : GFLEX
State        : Offline
GTT Option   : Yes
-----
```

```
-----
Service      : GPORT
State        : Offline
GTT Option   : Yes
-----
```

```
SCCPSRV table is (0 of 384) 0% full.
```

;

The following example displays output when the G-Port and G-Flex features are turned on, and the service set contains ANSI point codes.

**rtrv-sccp-serv**

```
tekelecstp 06-10-30 09:30:02 EST  EAGLE 36.0.0
```

```
-----
Service      : GFLEX
State        : Offline
GTT Option   : Yes
-----
```

```
-----
Service      : GPORT
```

```

State      : Offline
GTT Option : Yes
-----

```

```

ANSI PC    RC
001-001-001 01
001-001-002 01
001-001-003 01

```

SCCPSRV table is (4 of 384) 1% full.

;

The following example displays output when the G-Port and G-Flex services are turned on, and the service set contains ANSI and ITU-I point codes.

**rtrv-sccp-serv**

tekelecstp 06-10-30 09:32:30 EST EAGLE 36.0.0

```

-----
Service    : GFLEX
State      : Offline
GTT Option : Yes
-----

```

```

-----
Service    : GPORT
State      : Offline
GTT Option : Yes
-----

```

```

ANSI PC    RC
001-001-001 01
001-001-002 01
001-001-003 01

```

```

ITU I PC   RC
2-001-1    02
2-001-2    02
2-001-3    02

```

SCCPSRV table is (8 of 384) 2% full.

;

The following example displays output when the GPORT and GFLEX services are ONLINE, and the service set contains ANSI, ITU, and ITU-N point codes.

**rtrv-sccp-serv**

tekelecstp 06-10-30 09:37:03 EST EAGLE 36.0.0

```

-----
Service    : GFLEX
State      : Online
GTT Option : Yes
-----

```

```

ITUN PC    RC
00001      02

```

```

-----
Service    : GPORT
State      : Online
GTT Option : Yes
-----

```

```

ANSI PC    RC
001-001-001 01

```

```

001-001-002 01
001-001-003 01

ITUI PC      RC
2-001-1     02
2-001-2     02
2-001-3     02

```

SCCPSRV table is (10 of 384) 3% full.

;

The following example displays output when the A-Port or IGM feature is enabled, and the MNP and GFLEX services are ONLINE. This example also displays spare point codes.

**rtrv-sccp-serv**

tekelecstp 06-10-30 09:37:03 EST EAGLE 36.0.0

```

-----
Service      : GFLEX
State        : Online
GTT Option   : Yes
-----

```

```

ITUN PC      RC
00001        02

```

```

-----
Service      : MNP
State        : Online
GTT Option   : Yes
-----

```

```

ANSI PC      RC
001-001-001 01
001-001-002 01
001-001-003 01

```

```

ITUI PC      RC
2-001-1     02
2-001-2     02
2-01-3      02

```

```

ITUI SPARE   RC
s-4-201-0    10
s-4-201-1    10

```

```

ITUN SPARE   RC
s-2-102-0-aa 10
s-2-102-1-aa 10

```

SCCPSRV table is (16 of 384) 4% full.

;

**rtrv-sccpopts**

**Retrieve SCCP Options**

Use this command to display the current value of one or more of the SCCP option indicators maintained in the STP options table.

**Keyword:** rtrv-sccpopts

**Related Commands:** chg-sccpopts

**Command Class:** Database Administration

**Parameters**

This command has no parameters.

**Example**

```
rtrv-sccopts
```

**Dependencies**

None.

**Notes**

None.

**Output**

The following example displays output when the Origin-based MTP Routing feature is enabled and turned on.

**rtrv-sccpopts**

```
tekelecstp 09-06-15 14:07:11 EST EAGLE 41.1.0
SCCP OPTIONS
-----
CLASS1SEQ                off
CCLEN                    1
ACLEN                    3
INTLUNKNNAI              no
MOBRSCCPOPC              MTP
DFLTGTTMODE              CdPA
```

;

The following example displays output that results when the Transaction-based GTT Loadsharing feature is enabled.

**rtrv-sccpopts**

```
tekelecstp 09-06-15 14:07:11 EST EAGLE 41.1.0

SCCP OPTIONS
-----
CLASS1SEQ                on
CCLEN                    1
ACLEN                    3
INTLUNKNNAI              no
TGTT0                    NONE
TGTT1                    NONE
TGTTUDTKEY               MTP
TGTTXUDTKEY              MTP
```

;

The following example displays output when the GSM MAP Screening feature is enabled and turned on, and GSM MAP Screening is enabled for TCAP\_Continue and TCAP\_End messages.

**rtrv-sccpopts**

```
tekelecstp 09-06-15 14:07:11 EST EAGLE 41.1.0

SCCP OPTIONS
-----
CLASS1SEQ                off
CCLEN                    1
ACLEN                    3
INTLUNKNNAI              yes
DFLTGTTMODE              CdPA
GMSTCAPCE                on
```

;

The following example displays output when the ANSI-ITU-China SCCP Conversion feature is on.

**rtrv-sccpopts**

```
tekelecstp 09-06-15 14:07:11 EST EAGLE 41.1.0

SCCP OPTIONS
-----
CLASS1SEQ                on
CCLEN                    1
ACLEN                    3
INTLUNKNNAI              no
DFLTGTTMODE              CdPA
CNVAINAT                 1
TGTT0                    NONE
```

```
TGTT1                UDT, XUDT
TGTTUUDTKKEY        MTP
TGTTXUDTKKEY        MTP
```

;

The following example displays the command output when the FLOBR feature is turned on.

```
rtrv-sccpopts
tekelecstp 09-04-04 05:46:41 EST EAGLE 41.0.0

SCCP OPTIONS
-----
CLASS1SEQ                off
DFLTGTTMODE  FLOBRCdPA, FLOBRCgPA
DFLTFALLBACK            yes
```

;

## rtrv-scr-aftpc

## Retrieve Allowed Affected Point Code

Use this command to show the allowed affected point code (AFTPC) screening references in the AFTPC entity set.

**Keyword:** **rtrv-scr-aftpc**

**Related Commands:** **chg-scr-aftpc**, **dlt-scr-aftpc**, **ent-scr-aftpc**

**Command Class:** Database Administration

### Parameters

**:actname=** (optional)

The name of the gateway screening stop action set. Stop actions must be administered using the **actname** parameter in conjunction with the gateway screening stop action table (see **chg-gws-actset** and **rtrv-gws-actset**).

**Range:** *ayyyyy*, **none**

1 alphabetic character followed by up to 5 alphanumeric characters.

**none**—Display only those gateway screening rules that do not have a gateway screening stop action set assigned to them

**:all=** (optional)

Displays all AFTPC screening references.

**Range:** **yes**, **no**

**Default:** **no**

**:area=** (optional)

The ITU international area. The area is specified in the point code. The format of the point code is *zone-area-id*. An asterisk (\*) indicates the full range of values from **000-255**.

**Range:** **000-255** \*

**:id=** (optional)

The ITU international ID. The parameter specifies the ID in the point code represented by format *zone-area-id*. An asterisk (\*) indicates the full range of values from **0-7**.

**Range:** **0-7** \*

**:msa=** (optional)

The 24-bit ITU national main signaling area. The main signaling area is specified in the point code. The format of the point code is *msa-ssa-sp*. An asterisk (\*) indicates the full range of values from **000-255**.

**Range:** **000-255** \*

**:nc=** (optional)

The network cluster identifier value. This parameter restricts display to those entries containing this specific cluster of the point code represented by *ni-nc-ncm*. A single value or a range of values can be specified. An asterisk (\*) indicates the full range of values from **0-255**.

**Range:**     **0-255 \***

**Default:**    Display all

**:ncm=** (optional)

The network cluster member identifier value. This parameter restricts display to those entries containing this specific cluster member of the point code represented by *ni-nc-ncm*. A single value or a range of values can be specified. An asterisk (\*) indicates the full range of values from **0-255**.

**Range:**     **0-255 \***

**Default:**    Display all

**:ni=** (optional)

The network identifier value. This parameter restricts display to those entries containing this specific network of the point code represented by *ni-nc-ncm*. A single value or a range of values can be specified. An asterisk (\*) indicates the full range of values from **0-255**.

**Range:**     **0-255 \***

**Default:**    Display all

**:npc=** (optional)

The ITU national point code. An asterisk (\*) indicates the full range of values from **00000-16383**.

**NOTE: Gateway screening allows the ITU national point code to be displayed and entered in the database only as a single number. If you are using multiple-part ITU national point codes, see "Converting ITU National Point Code Formats" in Appendix A.**

**Range:**     **00000-16383 \***

**:nsfi=** (optional)

This parameter specifies the next screening category that is used in the gateway screening process, or it indicates that the gateway screening process should stop.

**Range:**     **stop**

**stop**—The gateway screening process ends and the message proceeds through normal routing.

**Default:**    Display all

**:nsr=** (optional)

The next screening reference parameter indicates which screening reference in the specified screening category (**nsfi**) is to be used in the screening process.

**Range:**     *ayyy*

1 alphabetic character followed by up to 3 alphanumeric characters

**Default:**    Display all

**:pcst=** (optional)

Point code subtype. This parameter indicates whether the specified ITU international or ITU national point code has no subtype prefix or has the spare point code prefix (s-).

**Range:**     **none, s**

**Default:**    **none**

**:sp=** (optional)

The 24-bit ITU national signaling point. This parameter specifies the signaling point (sp) in the point code represented by *msa-ssa-sp*. An asterisk (\*) indicates the full range of values from **000-255**.

**Range:**     **000-255 \***



**:sr=** (optional)

The AFTPC screening reference name

**Range:** *ayyy*

1 alphabetic character followed by up to 3 alphanumeric characters

**Default:** Display all

**:ssa=** (optional)

The 24-bit ITU national sub signaling area. The sub signaling area is specified in the point code. The format of the point code is *msa-ssa-sp*. An asterisk (\*) indicates the full range of values from **000-255**.

**Range:** **0-255 \***

**:ssn=** (optional)

Subsystem number. An asterisk (\*) indicates the full range of values from **0-255**.

**Range:** **1-255**

**Default:** Display all.

**:zone=** (optional)

The ITU international zone. The parameter specifies the zone in the point code represented by format *zone-area-id*. An asterisk (\*) indicates the full range of values from **0-7**.

**Range:** **0-7, \***

### Example

```
rtrv-scr-aftpc
```

```
rtrv-scr-aftpc:sr=iec:ni=240:nc=001:ncm=010&&014:ssn=012
```

```
rtrv-scr-aftpc:sr=iec
```

```
rtrv-scr-aftpc:all=yes
```

```
rtrv-scr-aftpc:sr=iec:ni=240:nc=001:ncm=010:ssn=012:actname=copy
```

```
rtrv-scr-aftpc:sr=aft1
```

```
rtrv-scr-aftpc:sr=aft1:zone=1:area=2:id=3:nsfi=stop:ssn=1:pcst=s
```

### Dependencies

If the **nsfi** parameter is specified, the parameter value must be **stop**.

ANSI point code value **000-000-000** and ITU-International point code value **0-000-0** are not allowed.

If **nc=\*** is specified, **ncm=\*** must be specified. If **ni=\*** is specified, **nc=\*** and **nc=\*** must be specified. If **zone=\*** is specified, **area=\*** and **id=\*** must be specified. If **area=\*** is specified, **id=\*** must be specified. If **msa=\*** is specified, **ssa=\*** and **sp=\*** must be specified. If **ssa=\*** is specified, **sp=\*** must be specified.

The character **c** is not a valid value for the **ni**, **nc**, **ncm**, **zone**, **area**, **id**, **msa**, **ssa**, **sp**, and **npc** parameters.

The **nsr** parameter cannot be specified if the **actname** parameter is specified.

The **nsr** parameter cannot be specified if the **nsfi=stop** parameter is specified.

The value of the **actname** parameter must be defined in the gateway screening stop action table with the **chg-gws-actset** command. These values are shown in the ACT NAME field of the **rtrv-gws-actset** command output.

If the **actname** parameter is specified with the **sr** parameter, the specified value for the **actname** parameter must be assigned to that screening reference name.

If specified, the **sr** parameter value must exist in the AFTPC screen entity set.

The Spare Point Code Support feature must be enabled before the **pcst** parameter can be specified.

The spare point code subtype prefix (**s-**) is not supported for ANSI point codes (parameters **ni**, **nc**, **ncm**) or for 24-bit ITU national point codes (parameters **msa**, **ssa**, **sp**). The **pcst** parameter cannot be specified for ANSI and ITU-N24 point codes.

Any specified **ni**, **nc**, **ncm**, **zone**, **area**, **id**, **msa**, **ssa**, **sp**, **nep**, **nsfi**, and **nsr** parameters must already exist in the AFTPC entity for the screening reference.

If the **pcst** parameter is specified, point codes with the specified subtype prefix (no prefix or **s-**) must exist in the database.

If the **nc** parameter is specified as a single value or a range, a single value must be specified for the **ni** parameter.

If the **nc** parameter is specified as a range, the **ncm** parameter must be specified as an asterisk or as the full range **000-255**.

The Gateway Screening Stop Action table must be accessible.

## Notes

An asterisk as a parameter value in this command displays only entries that have an asterisk as the same parameter value in the entry.

A range of values is defined by separating the values that define the range by two ampersands (**&&**); for example, **ni=025&&100** specifies all network indicators for ANSI point codes from **25** to **100**.

If no parameters are specified, a list of allowed AFTPC references is produced indicating whether they are referenced or not.

If only the **all=yes** parameter is specified, detailed information for every rule in every allowed AFTPC screening table is displayed.

If the **all** parameter is specified and other parameters are also specified, the **all** parameter is ignored.

The spare point code subtype prefix **s-** is supported only for ITU international and ITU national point codes. The **pcst** parameter indicates whether the specified point code has no subtype prefix or has the spare point code prefix.

Output

**rtrv-scr-aftpc**

```
rlghncxa03w 03-03-13 13:12:38 EST EAGLE 31.3.0
SCREEN = ALLOWED AFTPC
SR   REF  RULES
IEC  YES   2
WRD2 YES   1
WRD3 NO    4
WRD4 YES   9
```

;

**rtrv-scr-**

**aftpc:sr=iec:ni=240:nc=001:ncm=010&&014:ssn=012:actname=copy**

```
rlghncxa03w 03-03-14 15:23:18 EST EAGLE 31.3.0
SCREEN = ALLOWED AFTPC
SR   NI      NC      NCM      SSN      NSFI      NSR/ACT
IEC  240     001     010&&012  012     STOP     COPY
```

;

**rtrv-scr-aftpc:sr=aft1:zone=1:area=2:id=3:nsfi=stop:ssn=1:pcst=s**

```
tekelecstp 05-01-05 10:19:51 EST EAGLE 31.12.0
SCREEN = ALLOWED AFTPC
SR   ZONE  AREA  ID      SSN      NSFI      NSR/ACT
aft1 s-1    002   3       1       STOP     -----
```

;

**rtrv-scr-aftpc:sr=aft1**

```
tekelecstp 05-01-05 10:19:51 EST EAGLE 31.12.0
SCREEN = ALLOWED AFTPC
SR   ZONE  AREA  ID      SSN      NSFI      NSR/ACT
aft1 s-2    002   3       1       STOP     -----

SR   NPC
aft1 s-00128          1       STOP     -----
```

;

**Legend**

For a summary report:

**REF**—This indicates whether a screen is referenced by another screen. If NO, the screen is not used. If you need a more detailed output, use the **rtrv-scr-blkdpc:all=yes** command, or specify the specific screening reference.

**RULES**—The number of screening rules in that screening table.

For a detailed report:

**SCREEN = ALLOWED AFTPC**—This is the screen type.

**SR**—This is used to identify the various screen sets being used. It can be up to four characters in length.

**NI-NC-NCM**—The point code referenced within the screen. For international point codes, these columns are ZONE - AREA - ID. For 24-bit ITU national point codes, these columns are MSA - SSA - SP. For national point codes, these columns become the single column NPC.

**SSN**—The subsystem number associated with the point code identified by *ni-nc-ncm*.

**NSFI**—The next screening category to be used.

**NSR/ACT**—The name of the next screening reference (NSR—up to four characters) or action to be taken (ACT—up to six characters), if the message passes this screen.

## rtrv-scr-blkdpc

## Retrieve Blocked DPC

Use this command to show the blocked destination point code (BLKDPC) screening references in the BLKDPC entity set.

**Keyword:** rtrv-scr-blkdpc

**Related Commands:** chg-scr-blkdpc, dlt-scr-blkdpc, ent-scr-blkdpc

**Command Class:** Database Administration

### Parameters

**:actname=** (optional)

The name of the gateway screening stop action set. Stop actions must be administered using the **actname** parameter in conjunction with the gateway screening stop action table (see **chg-gws-actset** and **rtrv-gws-actset**).

**Range:** *ayyyyy*, **none**

1 alphabetic character followed by up to 5 alphanumeric characters.

**none**—Display only those gateway screening rules that do not have a gateway screening stop action set assigned to them

**:all=** (optional)

Displays all blocked DPC screening references.

**Range:** **yes**, **no**

**Default:** **no**

**:area=** (optional)

The ITU international area. The area is specified in the point code. The format of the point code is *zone-area-id*. An asterisk (\*) indicates the full range of values from **000–255**.

**Range:** **000-255** \*, C

**:id=** (optional)

The ITU international ID. The parameter specifies the ID in the point code represented by format *zone-area-id*. An asterisk (\*) indicates the full range of values from **0–7**.

**Range:** **0-7**, \*

**:msa=** (optional)

The 24-bit ITU national main signaling area. The main signaling area is specified in the point code. The format of the point code is *msa-ssa-sp*. An asterisk (\*) indicates the full range of values from **000-255**.

**Range:** **000-255** \*, C

**:nc=** (optional)

The network cluster identifier value. This parameter restricts display to those entries containing this specific cluster of the point code represented by *ni-nc-ncm*. A single value or a range of values can be specified. An asterisk (\*) indicates the full range of values from **0–255**.

**Range:** **0-255** \*, C

**Default:** Display all

**:ncm=** (optional)

The network cluster member identifier value. This parameter restricts display to those entries containing this specific cluster member of the point code represented by *ni-nc-ncm*. A single value or a range of values can be specified. An asterisk (\*) indicates the full range of values from **0–255**.

**Range:** 0-255 \*  
**Default:** Display all

**:ni=** (optional)

The network identifier value. This parameter restricts display to those entries containing this specific network of the point code represented by *ni-nc-ncm*. A single value or a range of values can be specified. An asterisk (\*) indicates the full range of values from 0-255.

**Range:** 0-255 \*, C  
**Default:** Display all

**:npc=** (optional)

The ITU national point code. An asterisk (\*) indicates the full range of values from 00000-16383.

**NOTE: Gateway screening allows the ITU national point code to be displayed and entered in the database only as a single number. If you are using multiple-part ITU national point codes, see "Converting ITU National Point Code Formats" in Appendix A.**

**Range:** 00000-16383 \*, C

**:nsfi=** (optional)

This parameter specifies the next screening category that is used in the gateway screening process, or it indicates that the gateway screening process should stop.

**Range:** cgpa, destfld, fail, isup, stop

**cgpa**—Allowed calling party address is the next screening category.

**destfld**—Allowed destination field (DESTFLD) is the next screening category.

**fail**—The received message should be discarded.

**isup**—ISUP message type (ISUP) is the next screening category.

**stop**—The gateway screening process ends and the message proceeds through normal routing.

**Default:** Display all

**:nsr=** (optional)

The next screening reference parameter indicates which screening reference in the specified screening category (**nsfi**) is to be used in the screening process. This parameter is mandatory if **nsfi** is other than **stop** or **fail**. The **nsr** parameter cannot be entered if **nsfi** is **stop** or **fail**, or the **copy=yes** parameter is specified.

**Range:** ayyy  
 1 alphabetic character followed by up to 3 alphanumeric characters

**Default:** Display all

**:pcst=** (optional)

Point code subtype. This parameter indicates whether the specified ITU international or ITU national point code has no subtype prefix or has the spare point code prefix (s-).

**Range:** none, s

**Default:** none

**:sp=** (optional)

The 24-bit ITU national signaling point. This parameter specifies the signaling point (sp) in the point code represented by *msa-ssa-sp*. An asterisk (\*) indicates the full range of values from 000-255.

**Range:** 000-255 \*, C

**:sr=** (optional)

The BLKDPC screening reference name

**Range:** ayyy  
 1 alphabetic character followed by up to 3 alphanumeric characters

**Default:** Display all.

**:ssa=** (optional)

The 24-bit ITU national sub signaling area. The sub signaling area is specified in the point code. The format of the point code is *msa-ssa-sp*. An asterisk (\*) indicates the full range of values from **000-255**.

**Range:**     **0-255 \*, C**

**:zone=** (optional)

The ITU international zone. The parameter specifies the zone in the point code represented by format *zone-area-id*. An asterisk (\*) indicates the full range of values from **0-7**.

**Range:**     **0-7, \*, C**

### Example

```
rtrv-scr-blkdpc
rtrv-scr-
blkdpc:sr=iec:ni=240:nc=001:ncm=010&&018:nsfi=stop:actname=rdct
rtrv-scr-blkdpc:sr=iec
rtrv-scr-blkdpc:all=yes
rtrv-scr-blkdpc:sr=bdp1:npc=128:nsfi=fail:pcst=s
```

### Dependencies

A complete point code must be specified, and must be one and only one of the four point code parameter combinations: **ni-nc-ncm**; **zone-area-id**; **msa-ssa-sp**; or **npc**, except in the special case of entering **c** for "continue."

If the **ni=c** parameter is specified, then the **nc** and the **ncm** parameters must have a value of **c** or must not be specified. If the **ni=c** parameter is specified, and the **nc** and the **ncm** parameters are not specified, then the **nc** and **ncm** parameters default to a value of **c**.

If the **zone=c** parameter is specified, then the **area** and the **id** parameters must have a value of **c** or must not be specified. If the **zone=c** parameter is specified, and the **area** and the **id** parameters are not specified, then the **area** and **id** parameters default to a value of **c**.

If the **msa=c** parameter is specified, then the **ssa** and the **sp** parameters must have a value of **c** or must not be specified. If the **msa=c** parameter is specified, and the **ssa** and the **sp** parameters are not specified, then the **ssa** and **sp** parameters default to a value of **c**.

ANSI point code value **000-000-000** and ITU-International point code value **0-000-0** are not allowed.

If the **area=\*** parameter is specified, then the **id=\*** parameter must be specified.

If the value of the **nsfi** parameter is **stop** or **fail**, then the **nsr** parameter cannot be specified.

If the **actname** parameter is specified, the **nsr** parameter cannot be specified.

If the **actname** parameter is specified, then the **nsfi=stop** parameter must be specified.

If the **actname** parameter is specified with the **sr** parameter, the specified value for the **actname** parameter must be assigned to that screening reference name.

The value of the **actname** parameter must already be defined in the Gateway Screening Stop Action table with the **chg-gws-actset** command. These values are shown in the ACT NAME field of the **rtrv-gws-actset** command output.

If the **ni** parameter is specified as an asterisk (**ni=\***) or as a range, the **nc** and **ncm** parameters must be specified as an asterisk or as the full range **000-255**.

If the **nc** parameter is specified as a single value or a range, a single value must be specified for the **ni** parameter.

If the **nc** parameter is specified as a range, the **ncm** parameter must be specified as an asterisk or as the full range **000-255**.

If the **ncm** parameter is specified as a single value, or a range other than the full range of **000–255**, the **ni** and the **nc** parameters must be specified with a single value.

The value of the **sr** parameter must already exist in the BLKDPC entity set.

The Spare Point Code Support feature must be enabled before the **pcst** parameter can be specified.

The spare point code subtype prefix (**s-**) is not supported for ANSI point codes (parameters **ni**, **nc**, **ncm**) or for 24-bit ITU national point codes (parameters **msa**, **ssa**, **sp**). The **pcst** parameter cannot be specified for ANSI and ITU-N24 point codes.

Any specified **id** or **sp** parameter must already exist in the database.

If the **pcst** parameter is specified, point codes with the specified subtype prefix (no prefix or **s-**) must exist in the database.

Any specified **nc** parameter must already exist in the database

Any specified **ncm** parameter must already exist in the database

Any specified **zone** or **msa** parameter must already exist in the database.

Any specified **ni** parameter must already exist in the database

Any specified **nsr** parameter must already exist in the database

Any specified **nsfi** parameter must already exist in the database

Any specified **npc** parameter must already exist in the database

Any specified **area** or **ssa** parameter must already exist in the database.

Any specified **pcst** parameter must already exist in the database

The Gateway Screening Stop Action table must be accessible.

If the **zone=\*** parameter is specified, then the **area=\*** and the **id=\*** parameters must be specified.

If the **msa=\*** parameter is specified, then the **ssa=\*** and the **sp=\*** parameters must be specified.

If the **ssa=\*** parameter is specified, then the **sp=\*** parameter must be specified.

## Notes

If no parameters are specified, a list of blocked DPC screening references is displayed indicating whether they are referenced or not.

If only the **all=yes** parameter is specified, detailed information for every rule in every blocked DPC screening table is output.

If the **all** parameter is specified and other parameters are also specified, the **all** parameter is ignored.

An asterisk as a parameter value in this command displays only entries that have an asterisk as the same parameter value in the entry.

A range of values is specified by separating the values that define the range by two ampersands (**&&**); for example, **:ni=025&&100** specifies all network indicators for ANSI point codes from **25** to **100**.

The character **c** is used in the blocked DPC screens to allow the screening process to continue for messages with point codes that do not match any point codes in the blocked DPC screens. When screening for a blocked DPC and the point code being screened does not match any of the point codes in the blocked DPC screens, the message is not rejected and the screening process continues. There must be an entry in the blocked DPC screens to allow the screening process to continue. This entry consists of a screening reference, point code, **nsfi**, and **nsr**. The point code has the value **c-c-c**.

If the character **c** is specified for any subfield of a three-subfield point code, all three subfields must have the value **c**. No other values can be used. For example, a point code **c-c-255** is not allowed. The

point code must be **c-c-c**. The asterisk (\*) value cannot be used with the character **c** (for example, a point code **c-c-\*** is not allowed).

In all cases, if **c** for "continue" is entered for the first subfield in the point code, the other subfields default to **c** in the database.

When the point code does not match any entries in the blocked DPC screens, the screening process is directed to the screening reference with the point code **c-c-c**. The **nsfi** and **nsr** in this entry are examined to determine the next step in the screening process.

The spare point code subtype prefix **s-** is supported only for ITU international and ITU national point codes. The **pst** parameter indicates whether the specified point code has no subtype prefix or has the spare point code prefix.



**Output**

**rtrv-scr-blkdpc**

```
rlghncxa03w 03-03-13 13:12:38 EST EAGLE 31.3.0
SCREEN = BLOCKED DPC
SR   REF  RULES
IEC  YES   2
WRD2 YES   1
WRD3 NO    4
WRD4 YES   9
```

;

**rtrv-scr-blkdpc:sr=iec:ni=240:nc=001:ncm=010&&018**

```
rlghncxa03w 03-03-13 13:13:21 EST EAGLE 31.3.0
SCREEN = BLOCKED DPC
SR   NI      NC      NCM      NSF1     NSR/ACT
IEC  240     001     010&&020 STOP  -----
```

;

**rtrv-scr-blkdpc:actname=rdct**

```
rlghncxa03w 03-03-13 13:13:21 EST EAGLE 31.3.0
SCREEN = BLOCKED DPC
SR   NI      NC      NCM      NSF1     NSR/ACT
IEC  C        C        C        STOP     RDCT
```

;

**rtrv-scr-blkdpc:nsr=is02**

```
tekelecstp 02-08-30 09:25:54 EST EAGLE 30.0.0
rtrv-scr-blkdpc:nsr=is02
Command entered at terminal #4.
SCREEN = BLOCKED DPC
SR   NI      NC      NCM      NSF1     NSR/ACT
bdp3 C        C        C        ISUP     is02
```

;

**rtrv-scr-blkdpc:sr=bdp1:npc=128:nsfi=fail**

```
tekelecstp 05-01-25 15:57:51 EST EAGLE 31.12.0
SCREEN = BLOCKED DPC
SR   NPC      NSF1     NSR/ACT
bdp1 s-00128   FAIL     -----
```

;

**Legend**

For a summary report:

**REF**—This indicates whether a screen is referenced by another screen. If **NO**, the screen is not used. If you need a more detailed output, use the **rtrv-scr-blkdpc:all=yes** command, or specify the specific screening reference.

**RULES**—The number of screening rules in that screening table.

For a detailed report:

**SCREEN = BLOCKED DPC**—This is the screen type.

**SR**—This is used to identify the various screen sets being used. It can be up to four characters in length.

**NI - NC - NCM**—The point code referenced within the screen. For international point codes, these columns are ZONE - AREA - ID. For 24-bit ITU national point codes, these columns are MSA-SSA-SP. For national point codes, these columns become the single column NPC.

**NSFI**—The next screening category to be used.

**NSR/ACT**—The name of the next screening reference (NSR - up to four characters) or action to be taken (ACT - up to six characters), if the message passes this screen.

## rtrv-scr-blkopc

## Retrieve Blocked OPC

Use this command to show the blocked originating point code (BLKOPC) screening references in the BLKOPC entity set.

**Keyword:** rtrv-scr-blkopc

**Related Commands:** chg-scr-blkopc, dlt-scr-blkopc, ent-scr-blkopc

**Command Class:** Database Administration

### Parameters

**:actname=** (optional)

The name of the gateway screening stop action set. Stop actions must be administered using the **actname** parameter in conjunction with the gateway screening stop action table (see **chg-gws-actset** and **rtrv-gws-actset**).

**Range:** ayyyyy, none

1 alphabetic character followed by up to 5 alphanumeric characters.

**none**—Display only those gateway screening rules that do not have a gateway screening stop action set assigned to them

**:all=** (optional)

Displays all blocked OPC screening references.

**Range:** yes, no

**Default:** no

**:area=** (optional)

The ITU international area. The area is specified in the point code. The format of the point code is *zone-area-id*. An asterisk (\*) indicates the full range of values from **000-255**.

**Range:** 000-255 \*, C

**:id=** (optional)

The ITU international ID. The parameter specifies the ID in the point code represented by format *zone-area-id*. An asterisk (\*) indicates the full range of values from **0-7**.

**Range:** 0-7, \*, C

**:msa=** (optional)

The 24-bit ITU national main signaling area. The main signaling area is specified in the point code. The format of the point code is *msa-ssa-sp*. An asterisk (\*) indicates the full range of values from **000-255**.

**Range:** 000-255 \*, C

**:nc=** (optional)

The network cluster identifier value. This parameter restricts display to those entries containing this specific cluster of the point code represented by *ni-nc-ncm*. A single value or a range of values can be specified. An asterisk (\*) indicates the full range of values from **0-255**.

**Range:** 0-255 \*, C

**Default:** Display all

**:ncm=** (optional)

The network cluster member identifier value. This parameter restricts display to those entries containing this specific cluster member of the point code represented by *ni-nc-ncm*. A single value or a range of values can be specified. An asterisk (\*) indicates the full range of values from **0–255**.

**Range:** **0-255** \*, C

**Default:** Display all

**:ni=** (optional)

The network identifier value. This parameter restricts display to those entries containing this specific network of the point code represented by *ni-nc-ncm*. A single value or a range of values can be specified. An asterisk (\*) indicates the full range of values from **0–255**.

**Range:** **0-255** \*, C

**Default:** Display all

**:npc=** (optional)

The ITU national point code. An asterisk (\*) indicates the full range of values from **00000–16383**.

**NOTE: Gateway screening allows the ITU national point code to be displayed and entered in the database only as a single number. If you are using multiple-part ITU national point codes, see "Converting ITU National Point Code Formats" in Appendix A.**

**Range:** **00000-16383** \*, C

**:nsfi=** (optional)

This parameter specifies the next screening category that is used in the gateway screening process, or it indicates that the gateway screening process should stop.

**Range:** **cgpa, stop, fail, sio, dpc, blkdpc**

**cgpa**—Allowed calling party address is the next screening category.

**stop**—The gateway screening process ends and the message proceeds through normal routing.

**fail**—The received message should be discarded.

**sio**—Allowed SIO is the next screening category.

**dpc**—Allowed DPC is the next screening category.

**blkdpc**—Blocked DPC is the next screening category.

**Default:** Display all

**:nsr=** (optional)

The next screening reference parameter indicates which screening reference in the specified screening category (**nsfi**) is to be used in the screening process. This parameter is mandatory if **nsfi** is other than **stop** or **fail**. The **nsr** parameter cannot be entered if **nsfi** is **stop** or **fail**, or the **copy=yes** parameter is specified.

**Range:** *ayyy*

1 alphabetic character followed by up to 3 alphanumeric characters

**Default:** Display all

**:pcst=** (optional)

Point code subtype. This parameter indicates whether the specified ITU international or ITU national point code has no subtype prefix or has the spare point code prefix (**s-**).

**Range:** **none, s**

**Default:** **none**

**:sp=** (optional)

The 24-bit ITU national signaling point. This parameter specifies the signaling point (**sp**) in the point code represented by *msa-ssa-sp*. An asterisk (\*) indicates the full range of values from **000-255**.

**Range:** **000-255** \*, C

**:sr=** (optional)

The BLKOPC screening reference name

**Range:** *ayyy*

1 alphabetic character followed by up to 3 alphanumeric characters

**Default:** Display all.

**:ssa=** (optional)

The 24-bit ITU national sub signaling area. The sub signaling area is specified in the point code. The format of the point code is *msa-ssa-sp*. An asterisk (\*) indicates the full range of values from **000-255**.

**Range:** **0-255** \*, C

**:zone=** (optional)

The ITU international zone. The parameter specifies the zone in the point code represented by format *zone-area-id*. An asterisk (\*) indicates the full range of values from **0-7**.

**Range:** **0-7** \*, C

### Example

```
rtrv-scr-blkopc
```

```
rtrv-scr-blkopc:sr=iec:ni=240:nc=001:ncm=010&&018:actname=copy
```

```
rtrv-scr-blkopc:sr=iec
```

```
rtrv-scr-blkopc:all=yes
```

```
rtrv-scr-blkopc:sr=bop1:npc=128:nsfi=fail
```

```
rtrv-scr-blkopc:sr=bop1:zone=2:area=2:id=3:nsfi=fail:pcst=s
```

### Dependencies

ANSI point code value **000-000-000** and ITU-International point code value **0-000-0** are not allowed.

Any specified **ni**, **nc**, **ncm**, **zone**, **area**, **id**, **msa**, **ssa**, **sp**, **npc**, **nsfi**, and **nsr** parameters must already exist in the database.

If the **pcst** parameter is specified, point codes with the specified subtype prefix (no prefix or **s-**) must exist in the database.

If the **area=\*** parameter is specified, then the **id=\*** parameter must be specified.

If the **nsr** parameter is specified, then the **actname** parameter cannot be specified.

If the value of the **nsfi** parameter is **stop** or **fail**, then the **nsr** parameter cannot be specified.

If the **actname** parameter is specified, the **nsfi=stop** parameter must be specified.

If the value **c** is specified for any subfield of a three-subfield point code, then all three subfields must have a value of **c** (**c-c-c**). No other values, including asterisks can be used. If the value of the first subfield is **c**, then the other subfields default to **c** in the database.

The value of the **actname** parameter must already be defined in the Gateway Screening Stop Action table with the **chg-gws-actset** command. These values are shown in the ACT NAME field of the **rtrv-gws-actset** command output.

If the **actname** parameter is specified with the screening reference name parameter, the specified value for the **actname** parameter must be assigned to that screening reference name.

The Spare Point Code Support feature must be enabled before the **pcst** parameter can be specified.

The spare point code subtype prefix (**s-**) is not supported for ANSI point codes (parameters **ni**, **nc**, **ncm**) or for 24-bit ITU national point codes (parameters **msa**, **ssa**, **sp**). The **pcst** parameter cannot be specified for ANSI and ITU-N24 point codes.

If the **nc=\*** parameter is specified, then the **ncm=\*** parameter must be specified.

The Gateway Screening Stop Action table must be accessible.

If the **ni=\*** parameter is specified, then the **nc=\*** and the **ncm=\*** parameters must be specified.

If the **zone=\*** parameter is specified, then the **area=\*** and the **id=\*** parameters must be specified.

If the **msa=\*** parameter is specified, then the **ssa=\*** and the **sp=\*** parameters must be specified.

If the **ssa=\*** parameter is specified, then the **sp=\*** parameter must be specified.

## Notes

An asterisk as a parameter value in this command displays only entries that have an asterisk as the same parameter value in the entry.

If no parameters are specified, a list of blocked OPC references is displayed indicating whether they are referenced or not.

If only the **all=yes** parameter is specified, detailed information for every rule in every blocked OPC screening table is displayed.

If the **all** parameter is specified and other parameters are also specified, the **all** parameter is ignored.

A range of values is specified by separating the values that define the range by two ampersands (**&&**); for example, **:ni=025&&100** specifies all network indicators for ANSI point codes from **25** to **100**.

For point codes with three subfields, the value **c** (continue) is used as a place holder. In the event the point code is not found in this screen set, the continue value points to the **nsfi** and **nsr** to be applied next.

The character **c** is used in the blocked OPC screens to allow the screening process to continue for messages with point codes that do not match any point codes in the blocked OPC screens. When screening for a blocked OPC and the point code being screened does not match any of the point codes in the blocked OPC screens, the message is not rejected and the screening process continues. There must be an entry in the blocked OPC screens to allow the screening process to continue. This entry consists of a screening reference, point code, **nsfi**, and **nsr**. The point code **c-c-c**.

When the point code does not match any entries in the blocked OPC screens, the screening process is directed to the screening reference with the point code **c-c-c**. The **nsfi** and **nsr** in this entry are examined to determine the next step in the screening process.

The spare point code subtype prefix **s-** is supported only for ITU international and ITU national point codes. The **pcst** parameter indicates whether the specified point code has no subtype prefix or has the spare point code prefix.

## Output

**rtrv-scr-blkopc**

```

rlghncxa03w 03-03-13 13:12:38 EST EAGLE 31.3.0
SCREEN = BLOCKED OPC
SR    REF  RULES
IEC   YES   2
WRD2  YES   1
WRD3  NO    4
WRD4  YES   9

```

;

**rtrv-scr-blkopc:sr=iec:ni=240:nc=001:ncm=010&&018**

```

rlghncxa03w 03-03-13 13:13:21 EST EAGLE 31.3.0
SCREEN = BLOCKED OPC
SR    NI    NC    NCM    NSFI    NSR/ACT
IEC   240   001   010&&020  FAIL   -----

```

;

**rtrv-scr-blkopc:actname=cncf**

```

rlghncxa03w 03-03-13 10:34:07 EST EAGLE 31.3.0
SCREEN = BLOCKED OPC
SR    NI    NC    NCM    NSFI    NSR/ACT
IEC   C     C     C     STOP   CNCF

```

;

**rtrv-scr-blkopc:all=yes**

```

rlghncxa03w 03-03-13 10:34:07 EST EAGLE 31.3.0
SCREEN = BLOCKED OPC
SR    NI    NC    NCM    NSFI    NSR/ACT
IEC   240   001   010   FAIL   -----
IEC   241   010   *     FAIL   -----

SR    ZONE  AREA  ID    NSFI    NSR/ACT
IEC   1     003   4     FAIL   -----
IEC   1     003   5     FAIL   -----

SR    NI    NC    NCM    NSFI    NSR/ACT
IEC   C     C     C     STOP   CRNCF

SR    NI    NC    NCM    NSFI    NSR/ACT
WRD2  243   015   001   FAIL   -----
WRD2  243   105   002   FAIL   -----
WRD2  C     C     C     STOP   CNCF

```

;

**rtrv-scr-blkopc:sr=bo01:nsfi=sio:nsr=si01:msa=c:ssa=c:sp=c**

```

tekelecstp 03-03-25 15:57:07 EST EAGLE 31.0.0
SCREEN = BLOCKED OPC
SR    MSA   SSA   SP    NSFI    NSR/ACT
bo01  C     C     C     SIO     si01

```

;

**rtrv-scr-blkopc:sr=bop1**

```

tekelecstp 05-01-25 15:57:07 EST EAGLE 31.12.0
SCREEN = BLOCKED OPC
SR    ZONE  AREA  ID    NSFI    NSR/ACT
bop1  s-2    002   3     FAIL   -----

SR    NPC
bop1  s-00128      NSFI    NSR/ACT
                        FAIL   -----

```

| SR   | ZONE | AREA | ID | NSFI | NSR/ACT |
|------|------|------|----|------|---------|
| bop1 | C    | C    | C  | STOP | -----   |

i

**Legend**

For a summary report:

**REF**—This indicates whether a screen is referenced by another screen. If NO, the screen is not used. If you need a more detailed output, use the **rtrv-scr-blkopc:all=yes** command, or specify the specific screening reference.

**RULES**—The number of screening rules in that screening table.

For a detailed report:

**SCREEN = BLOCKED OPC**—This is the screen type.

**SR**—This is used to identify the various screen sets being used. It can be up to four characters in length.

**NI - NC - NCM**—The point code referenced within the screen. For international point codes, these columns are ZONE - AREA - ID. For 24-bit ITU national point codes, these columns are MSA-SSA-SP. For national point codes, these columns become the single column NPC.

**NSFI**—The next screening category to be used.

**NSR/ACT**—The name of the next screening reference (NSR - up to four characters) or action to be taken (ACT - up to six characters), if the message passes this screen.

**rtrv-scr-cdpa**

**Retrieve Allowed Called Party Address**

Use this command to show the allowed called party address (CDPA) screening references in the CDPA entity set.

**Keyword:** rtrv-scr-cdpa

**Related Commands:** chg-scr-cdpa, dlt-scr-cdpa, ent-scr-cdpa

**Command Class:** Database Administration

**Parameters**

**:actname=** (optional)

The name of the gateway screening stop action set. Stop actions must be administered using the **actname** parameter in conjunction with the gateway screening stop action table (see **chg-gws-actset** and **rtrv-gws-actset**).

**Range:** ayyyy, none

1 alphabetic character followed by up to 5 alphanumeric characters.

**none**—Display only those gateway screening rules that do not have a gateway screening stop action set assigned to them

**:all=** (optional)

Displays all allowed CDPA screening references.

**Range:** yes, no

**Default:** no

**:area=** (optional)

The ITU international area. The area is specified in the point code. The format of the point code is *zone-area-id*. An asterisk (\*) indicates the full range of values from **000-255**.

**Range:** 000-255 \*

**:id=** (optional)

The ITU international ID. The parameter specifies the ID in the point code represented by format *zone-area-id*. An asterisk (\*) indicates the full range of values from **0–7**.

**Range:**     **0-7, \***

**:msa=** (optional)

The 24-bit ITU national main signaling area. The main signaling area is specified in the point code. The format of the point code is *msa-ssa-sp*. An asterisk (\*) indicates the full range of values from **000-255**.

**Range:**     **000-255 \***

**:nc=** (optional)

The network cluster identifier value. This parameter restricts display to those entries containing this specific cluster of the point code represented by *ni-nc-ncm*. A single value or a range of values can be specified. An asterisk (\*) indicates the full range of values from **0–255**.

**Range:**     **0-255 \***

**Default:**   Display all

**:ncm=** (optional)

The network cluster member identifier value. This parameter restricts display to those entries containing this specific cluster member of the point code represented by *ni-nc-ncm*. A single value or a range of values can be specified. An asterisk (\*) indicates the full range of values from **0–255**.

**Range:**     **0-255 \***

**Default:**   Display all

**:ni=** (optional)

The network identifier value. This parameter restricts display to those entries containing this specific network of the point code represented by *ni-nc-ncm*. A single value or a range of values can be specified. An asterisk (\*) indicates the full range of values from **0–255**.

**Range:**     **0-255 \***

**Default:**   Display all

**:npc=** (optional)

The ITU national point code. An asterisk (\*) indicates the full range of values from **00000–16383**.

**NOTE: Gateway screening allows the ITU national point code to be displayed and entered in the database only as a single number. If you are using multiple-part ITU national point codes, see "Converting ITU National Point Code Formats" in Appendix A.**

**Range:**     **00000-16383 \***

**:nsfi=** (optional)

This parameter specifies the next screening category that is used in the gateway screening process, or it indicates that the gateway screening process should stop.

**Range:**     **aftpc, stop**

**aftpc** — Allowed affected point code is the next screening category

**stop** — The gateway screening process ends and the message proceeds through normal routing

**Default:**   Display all

**:nsr=** (optional)

The next screening reference parameter indicates which screening reference in the specified screening category (**nsfi**) is to be used in the screening process. This parameter is mandatory if **nsfi** is other than **stop** or **fail**. The **nsr** parameter cannot be entered if **nsfi** is **stop** or **fail**, or the **copy=yes** parameter is specified.

**Range:**     *ayyy*

1 alphabetic character followed by up to 3 alphanumeric characters



**Default:** Display all

**:pcst=** (optional)

Point code subtype indicator. This parameter indicates whether the ITU international or ITU national point codes to be displayed must have the spare point code prefix (s-).

**Range:** **none, s**  
**none** — No spare point code prefix required  
**s** — Spare point code prefix required

**Default:** none

**:scmgfid=** (optional)

The SCCP management (SCMG) format ID, which consists of a 1-octet field and uniquely defines the function and format of each SCMG message. A single value or a range of values can be specified. An asterisk (\*) indicates the full range of values from **1-255**. The following SCCP message types are screened against the Allowed CDPA table and all others are passed: UDT, UDTS, XUDT, XUDTS

**Range:** **1-255 \***  
**Default:** All SCMG format IDs are shown.

**:sp=** (optional)

The 24-bit ITU national signaling point. This parameter specifies the signaling point (sp) in the point code represented by *msa-ssa-sp*. An asterisk (\*) indicates the full range of values from **000-255**.

**Range:** **000-255 \***

**:sr=** (optional)

Displays all allowed CDPA screening references.

**Range:** *ayyy*  
 1 alphabetic character followed by up to 3 alphanumeric characters

**Default:** Display all.

**:ssa=** (optional)

The 24-bit ITU national sub signaling area. The sub signaling area is specified in the point code. The format of the point code is *msa-ssa-sp*. An asterisk (\*) indicates the full range of values from **000-255**.

**Range:** **0-255 \***

**:ssn=** (optional)

Subsystem number. An asterisk (\*) indicates the full range of values from **0-255**.

**Range:** **1-255**

**Default:** Display all.

**:zone=** (optional)

The ITU international zone. The parameter specifies the zone in the point code represented by format *zone-area-id*. An asterisk (\*) indicates the full range of values from **0-7**.

**Range:** **0-7, \***

## Example

```
rtrv-scr-cdpa
rtrv-scr-cdpa:sr=iec:ni=240:nc=001:ncm=010:ssn=001
rtrv-scr-cdpa:sr=iec:ni=240:nc=001:ssn=002&&005
rtrv-scr-cdpa:sr=iec
rtrv-scr-cdpa:sr=iec:actname=copy
rtrv-scr-
cdpa:sr=cdp1:zone=1:area=2:id=3:ssn=1:nsfi=stop:scmgfid=1:pcst=s
```

**rtrv-scr-cdpa :sr=cdp1**

### Dependencies

If the **actname** parameter is specified, the **nsr** parameter cannot be specified.

If the **actname** parameter is specified, the **nsfi=stop** parameter must be specified.

The **nsr** parameter cannot be specified when **nsfi=stop**.

If **zone=\*** is specified, **area=\*** and **id=\*** must be specified. If **area** is specified or respecified as an asterisk, **id** must also be an asterisk. If **msa=\*** is specified, **ssa=\*** and **sp=\*** must be specified. If **ssa=\*** is specified, **sp=\*** must be specified.

If the **ni** parameter is specified as an asterisk (**ni=\*** ) or as a range, the **nc** and **ncm** parameters must be specified as an asterisk or as the full range **000–255**.

If the **nc** parameter is specified as an asterisk (**nc=\*** ), the **ncm** parameter must be specified as an asterisk or as the full range **000–255**.

If the **nc** parameter is specified as a single value or a range, a single value must be specified for the **ni** parameter.

If the **nc** parameter is specified as a range, the **ncm** parameter must be specified as an asterisk or as the full range **000–255**.

If the **ncm** parameter is specified as a single value, or a range other than the full range of **000–255**, the **ni** and the **nc** parameters must be specified with a single value.

ANSI point code value **000-000-000** and ITU-International point code value **0-000-0** are not allowed.

If the **actname** parameter is specified with the screening reference name parameter, the specified value for the **actname** parameter must be assigned to that screening reference name.

The value of the **actname** parameter must already be defined in the Gateway Screening Stop Action table with the **chg-gws-actset** command. These values are shown in the ACT NAME field of the **rtrv-gws-actset** command output.

The Spare Point Code Support feature must be enabled before the **pcst** parameter can be specified.

The spare point code subtype prefix (**s-**) is not supported for ANSI point codes (parameters **ni**, **nc**, **ncm**) or for 24-bit ITU national point codes (parameters **msa**, **ssa**, **sp**). The **pcst** parameter cannot be specified for ANSI and ITU-N24 point codes.

Any specified **ni**, **nc**, **ncm**, **zone**, **area**, **id**, **msa**, **ssa**, **sp**, **ncp**, **nsfi**, **ri**, **ssn**, and **nsr** parameters must already exist in the CGPA entity for the screening reference.

If the **pcst** parameter is specified, point codes with the specified subtype prefix (no prefix or **s-**) must exist in the database.

The specified screening function identifier(**nsfi**) must be in the allowed CDPA entity set.

If specified, the **sr** parameter value must exist in the AFTPC screen entity set.

### Notes

If no parameters are specified, the system displays a summary output.

If only the **all=yes** parameter is specified, the system displays a detailed output.

If the **all** parameter and any point code parameter are specified, the **all** parameter is ignored.

The REF column of the output of this command displays **YES** when the screen is referenced by another screen; otherwise, it displays **NO**.

An asterisk as a parameter value in this command displays only entries that have an asterisk as the same parameter value in the entry.

A range of values is specified by separating the values that define the range by two ampersands (&&); for example, **:ni=025&&100** specifies all network indicators for ANSI point codes from **25** to **100**.

The spare point code subtype prefix **s-** is supported only for ITU international and ITU national point codes. The **pcst** parameter indicates whether the specified point code has no subtype prefix or has the spare point code prefix.

## Output

**rtrv-scr-cdpa:sr=iec:ni=240:nc=001:ncm=010:ssn=001**

```
rlghncxa03w 03-03-07 12:05:33 EST EAGLE 31.3.0
SCREEN = ALLOWED CDPA
SR  NI      NC      NCM      SSN      SCMGFID  NSF1  NSR/ACT
IEC 240     001     010     001     002&&003 STOP  -----
```

;

**rtrv-scr-cdpa:sr=iec:ni=240:nc=001:ssn=002&&005**

```
rlghncxa03w 03-03-07 12:05:33 EST EAGLE 31.3.0
SCREEN = ALLOWED CDPA
SR  NI      NC      NCM      SSN      SCMGFID  NSF1  NSR/ACT
IEC 240     001     010     002     -----  STOP  -----
IEC 240     001     011     002&&003 -----  STOP  -----
```

;

**rtrv-scr-cdpa:sr=iec**

```
rlghncxa03w 03-03-07 12:05:33 EST EAGLE 31.3.0
SCREEN = ALLOWED CDPA
SR  NI      NC      NCM      SSN      SCMGFID  NSF1  NSR/ACT
IEC 240     001     010     12     -----  STOP  -----
IEC 241     010     *      *      -----  AFTPC IAFT
```

;

**rtrv-scr-cdpa**

```
rlghncxa03w 03-03-07 12:05:33 EST EAGLE 31.3.0
SCREEN = ALLOWED CDPA
SR  REF  RULES
IEC  YES  2
WRD2 YES  1
WRD4 YES  4
```

;

**rtrv-scr-cdpa:sr=iec:actname=copy**

```
rlghncxa03w 03-03-07 12:05:33 EST EAGLE 31.3.0
SCREEN = ALLOWED CDPA
SR  NI      NC      NCM      SSN      SCMGFID  NSF1  NSR/ACT
IEC 245     001     010     001     002&&003 STOP  COPY
IEC 246     001     010     001     002&&003 STOP  COPY

U0 - CNCF
```

;

**rtrv-scr-**

**cdpa:sr=cdp1:zone=1:area=2:id=3:ssn=1:nsfi=stop:scmgfid=1:pcst=s**

```
rlghncxa03w 05-01-07 12:05:33 EST EAGLE 31.12.0
SCREEN = ALLOWED CDPA
SR  ZONE  AREA  ID      SSN      SCMGFID  NSF1  NSR/ACT
cdp1 s-1    002   3      1      1      STOP  -----
```

;

**rtrv-scr-cdpa:sr=cdp1**

```
rlghncxa03w 05-01-07 12:05:33 EST EAGLE 31.12.0
SCREEN = ALLOWED CDPA
SR  ZONE  AREA  ID      SSN      SCMGFID  NSF1  NSR/ACT
cdp1 s-2    002   3      1      1      STOP  -----

SR      NPC      SSN      SCMGFID  NSF1  NSR/ACT
```

```

cdp1 s-00128          1      1      STOP      -----
;

```

**Legend**

For a summary report:

**REF**—This indicates whether a screen is referenced by another screen. If NO, the screen is not used. If you need a more detailed output, use the **rtrv-scr-cdpa:all=yes** command, or specify the specific screening reference.

**RULES**—The number of screening rules in that screening table.

For a detailed report:

**SCREEN = ALLOWED CDPA**—This is the screen type.

**SR**—This is used to identify the various screen sets being used. It can be up to four characters in length.

**NI - NC - NCM**—The point code referenced within the screen. For international point codes, these columns are ZONE - AREA - ID. For 24-bit national point codes, these columns are MSA - SSA - SP. For national point codes, these columns become the single column NPC.

**SSN**—The subsystem number associated with the point code identified by the **ni-nc-ncm**.

**SCMGFID**—The SCMGFID format ID.

**NSFI**—The next screening category to be used.

**NSR/ACT**—The name of the next screening reference (NSR - up to four characters) or action to be taken (ACT - up to six characters), if the message passes this screen.

**rtrv-scr-cgpa****Retrieve Allowed Calling Party Address**

Use this command to show the allowed calling party address (CGPA) screening references in the CGPA entity set.

**Keyword:** **rtrv-scr-cgpa**

**Related Commands:** **chg-scr-cgpa, dlt-scr-cgpa, ent-scr-cgpa**

**Command Class:** Database Administration

**Parameters**

**:actname=** (optional)

The name of the gateway screening stop action set. Stop actions must be administered using the **actname** parameter in conjunction with the gateway screening stop action table (see **chg-gws-actset** and **rtrv-gws-actset**).

**Range:** *ayyyyy*, **none**

1 alphabetic character followed by up to 5 alphanumeric characters.

**none**—Display only those gateway screening rules that do not have a gateway screening stop action set assigned to them

**:all=** (optional)

Displays all allowed CGPA screening references.

**Range:** **yes, no**

**Default:** **no**

**:area=** (optional)

The ITU international area. The area is specified in the point code. The format of the point code is *zone-area-id*. An asterisk (\*) indicates the full range of values from **000–255**.

**Range:** 000-255 \*

**:id=** (optional)

The ITU international ID. The parameter specifies the ID in the point code represented by format *zone-area-id*. An asterisk (\*) indicates the full range of values from 0–7.

**Range:** 0-7, \*

**:msa=** (optional)

The 24-bit ITU national main signaling area. The main signaling area is specified in the point code. The format of the point code is *msa-ssa-sp*. An asterisk (\*) indicates the full range of values from 000-255.

**Range:** 000-255 \*

**:nc=** (optional)

The network cluster identifier value. This parameter restricts display to those entries containing this specific cluster of the point code represented by *ni-nc-ncm*. A single value or a range of values can be specified. An asterisk (\*) indicates the full range of values from 0–255.

**Range:** 0-255 \*

**Default:** Display all

**:ncm=** (optional)

The network cluster member identifier value. This parameter restricts display to those entries containing this specific cluster member of the point code represented by *ni-nc-ncm*. A single value or a range of values can be specified. An asterisk (\*) indicates the full range of values from 0–255.

**Range:** 0-255 \*

**Default:** Display all

**:ni=** (optional)

The network identifier value. This parameter restricts display to those entries containing this specific network of the point code represented by *ni-nc-ncm*. A single value or a range of values can be specified. An asterisk (\*) indicates the full range of values from 0–255.

**Range:** 0-255 \*

**Default:** Display all

**:npc=** (optional)

The ITU national point code. An asterisk (\*) indicates the full range of values from 00000–16383.

**NOTE: Gateway screening allows the ITU national point code to be displayed and entered in the database only as a single number. If you are using multiple-part ITU national point codes, see "Converting ITU National Point Code Formats" in Appendix A.**

**Range:** 00000-16383 \*

**:nsfi=** (optional)

This parameter specifies the next screening category that is used in the gateway screening process, or it indicates that the gateway screening process should stop.

**Range:** cdpa, stop, tt

**cdpa**—Allowed called party address point code is the next screening category.

**stop**—The gateway screening process ends and the message proceeds through normal routing.

**tt**—Allowed translation type point code is the next screening category.

**Default:** Display all

**:nsr=** (optional)

The next screening reference parameter indicates which screening reference in the specified screening category (**nsfi**) is to be used in the screening process. This parameter is mandatory if **nsfi** is other than **stop** or **fail**. The **nsr** parameter cannot be entered if **nsfi** is **stop** or **fail**, or the **copy=yes** parameter is specified.

**Range:** *ayyy*  
1 alphabetic character followed by up to 3 alphanumeric characters

**Default:** Display all

**:pcst=** (optional)

Point code subtype indicator. This parameter indicates whether the ITU international or ITU national point codes to be displayed must have the spare point code prefix (s-).

**Range:** **none, s**  
**none**— No spare point code prefix required.  
**s**— Spare point code prefix required.

**Default:** **none**

**:ri=** (optional)

The routing indicator provides routing instructions to the receiving signaling point. In gateway screening, messages may be screened based on the value of the routing indicator.

**Range:** **gt, dpc, \***  
**gt**—Allow a called party address with a routing indicator value of "global title."  
**dpc**—Allow a called party address with a routing indicator value of "DPC/SSN."  
**\***—Allow both routing indicator values.

**Default:** Display all

**:sccpmt=** (optional)

The SCCP message type. An asterisk (\*) indicates all possible allowed values; that is, **9, 10, 17, and 18**.

**Range:** **9, 10, 17, 18, \***  
**9, \***— UDT  
**10, \***—  
UDTS  
**17, \***— XUDT  
**18, \***— XUDTS

**Default:** Display all SCCP message types

**:sp=** (optional)

The 24-bit ITU national signaling point. This parameter specifies the signaling point (sp) in the point code represented by *msa-ssa-sp*. An asterisk (\*) indicates the full range of values from **000-255**.

**Range:** **000-255 \***

**:sr=** (optional)

The CGPA screening reference name

**Range:** *ayyy*  
1 alphabetic character followed by up to 3 alphanumeric characters

**Default:** Display all.

**:ssa=** (optional)

The 24-bit ITU national sub signaling area. The sub signaling area is specified in the point code. The format of the point code is *msa-ssa-sp*. An asterisk (\*) indicates the full range of values from **000-255**.

**Range:** **0-255 \***

**:ssn=** (optional)

Subsystem number. An asterisk (\*) indicates the full range of values from **0-255**.

**Range:** **0-255**

**Default:** Display all.

**:zone=** (optional)

The ITU international zone. The parameter specifies the zone in the point code represented by format *zone-area-id*. An asterisk (\*) indicates the full range of values from **0-7**.

**Range:** **0-7, \***

### Example

```
rtrv-scr-cgpa:sr=iec:ni=240:nc=001:ncm=010:ssn=012
rtrv-scr-cgpa:sr=iec:ni=240:nc=001:ncm=010:actname=copy
rtrv-scr-cgpa:sr=cgpl
rtrv-scr-
cgpa:sr=cgpa:zone=1:area=2:id=3:ssn=1:sccpmt=9:ri=*:nsfi=stop:pcst=s
```

### Dependencies

If the **ni** parameter is specified as an asterisk (**ni=\***) or as a range, the **nc** and **ncm** parameters must be specified as an asterisk or as the full range **000-255**.

If the **nc** parameter is specified as an asterisk (**nc=\***), the **ncm** parameter must be specified as an asterisk or as the full range **000-255**.

If the **nc** parameter is specified as a single value or a range, a single value must be specified for the **ni** parameter.

If the **nc** parameter is specified as a range, the **ncm** parameter must be specified as an asterisk or as the full range **000-255**.

If the **ncm** parameter is specified as a single value, or a range other than the full range of **000-255**, the **ni** and the **nc** parameters must be specified with a single value.

If the **actname** parameter is specified, the **nsr** parameter cannot be specified.

If the **actname** parameter is specified, the **nsfi=stop** parameter must be specified.

If the **actname** parameter is specified with the screening reference name parameter, the specified value for the **actname** parameter must be assigned to that screening reference name.

ANSI point code value **000-000-000** and ITU-International point code value **0-000-0** are not allowed.

If **zone=\*** is specified, **area=\*** and **id=\*** must be specified. If **area=\*** is specified, **id=\*** must be specified. If **msa=\*** is specified, **ssa=\*** and **sp=\*** must be specified. If **ssa=\*** is specified or re-specified, **sp=\*** must also be specified.

The Spare Point Code Support feature must be enabled before the **pcst** parameter can be specified.

Any specified **ni**, **nc**, **ncm**, **zone**, **area**, **id**, **msa**, **ssa**, **sp**, **ncp**, **nsfi**, **ri**, **ssn**, and **nsr** parameters must already exist in the CGPA entity for the screening reference.

If the **pcst** parameter is specified, point codes with the specified subtype prefix (no prefix or **s-**) must exist in the database.

The specified screening reference (**sr**) must be in the allowed CGPA entity set.

If the **nsfi=stop** parameter is specified, the **nsr** parameter cannot be specified.

The spare point code subtype prefix (**s-**) is not supported for ANSI point codes (parameters **ni**, **nc**, **ncm**) or for 24-bit ITU national point codes (parameters **msa**, **ssa**, **sp**). The **pcst** and **npcst** parameters cannot be specified for ANSI and ITU-N24 point codes.

The value of the **actname** parameter must already be defined in the Gateway Screening Stop Action table with the **chg-gws-actset** command. These values are shown in the *ACTNAME* field of the **rtrv-gws-actset** command output.

The Gateway Screening Stop Action table must be accessible.



**Notes**

If no parameters are specified, the system displays a summary output.

If only the **all=yes** parameter is specified, the system displays a detailed output.

If the **all** parameter and any point code parameter are specified, the **all** parameter is ignored.

An asterisk as a parameter value in this command displays only entries that have an asterisk as the same parameter value in the entry.

A range of values is specified by separating the values that define the range by two ampersands (**&&**); for example, **:ni=025&&100** specifies all network indicators for ANSI point codes from **25** to **100**.

The spare point code subtype prefix **s-** is supported only for ITU international and ITU national point codes. The **pcst** parameter indicates whether the specified point code has no subtype prefix or has the spare point code prefix.

## Output

**rtrv-scr-cgpa:sr=iec:ni=240:nc=001:ncm=010:ssn=012**

```
rlghncxa03w 03-03-14 15:58:16 EST EAGLE 31.3.0
SCREEN = ALLOWED CGPA
SR  NI      NC      NCM      SSN      RI      SCCPMT  NSFI     NSR/ACT
IEC 240     001     010     012     DPC    009&&010 STOP    -----
```

;

**rtrv-scr-cgpa:sr=iec:ni=240:nc=001-004:ri=dpc:sccpmt=000&&010**

```
rlghncxa03w 03-03-14 15:58:16 EST EAGLE 31.3.0
SCREEN = ALLOWED CGPA
SR  NI      NC      NCM      SSN      RI      SCCPMT  NSFI     NSR/ACT
IEC 240     001     010     012     DPC    017&&018 STOP    -----
IEC 240     002&&003 *      004     DPC    009     STOP    -----
```

;

**rtrv-scr-cgpa:actname=none**

```
rlghncxa03w 03-03-14 15:58:16 EST EAGLE 31.3.0
SCREEN = ALLOWED CGPA
SR  NI      NC      NCM      SSN      RI      SCCPMT  NSFI     NSR/ACT
IEC 240     001     010     012     DPC    017     STOP    -----
IEC 240     001     010     014     GT     *      STOP    -----
IEC 241     002     011     014     GT     *      CDPA    CDPI
```

;

**rtrv-scr-**

**cgpa:sr=cg01:nsfi=tt:nsr=tt01:ri=gt:ssn=1:sccpmt=9:msa=255:ssa=255:sp=255**

```
tekelecstp 03-03-05 14:41:37 EST EAGLE 31.0.0
SCREEN = ALLOWED CGPA
SR  MSA     SSA     SP      NSFII   NSR/ACT
cg01 255     255     255     1       GT     9       TT      tt01
```

;

**rtrv-scr-**

**cgpa:sr=cgpa:zone=1:area=2:id=3:ssn=1:sccpmt=9:ri=\*:nsfi=stop:pcst=s**

```
tekelecstp 05-01-05 14:41:37 EST EAGLE 31.12.0
SCREEN = ALLOWED CGPA
SR  ZONE   AREA   ID     SSN     RI     SCCPMT  NSFI     NSR/ACT
cgpa s-1     002    3      1       *     9       STOP    -----
```

;

**rtrv-scr-cgpa:sr=cgp1**

```
tekelecstp 05-01-05 14:41:37 EST EAGLE 31.12.0
SCREEN = ALLOWED CGPA
SR  ZONE   AREA   ID     SSN     RI     SCCPMT  NSFI     NSR/ACT
cgp1 s-2     002    3      1       *     *       STOP    -----

SR  NPC
cgp1 s-00128      1       *     *       STOP    -----
```

;

**Legend**

For a summary report:

**REF**—This indicates whether a screen is referenced by another screen. If NO, the screen is not used. If you need a more detailed output, use the **rtrv-scr-cgpa:all=yes** command, or specify the specific screening reference.

**RULES**—The number of screening rules in that screening table.

For a detailed report:

**SCREEN = ALLOWED CGPA**—This is the screen type.

**SR** —This is used to identify the various screen sets being used. It can be up to four characters in length.

**NI - NC - NCM**—The point code referenced within the screen. For international point codes, these columns are ZONE - AREA - ID. For 24-bit ITU national point codes, these columns are MSA-SSA-SP. For national point codes, these columns become the single column NPC.

**SSN**—The subsystem number associated with the point code identified by the *ni-nc-ncm* .

**RI**—The routing indicator in the called party address.

**SCCPMT**—The SCCP message type.

**NSFI**—The next screening category to be used.

**NSR/ACT**—The name of the next screening reference (NSR - up to four characters) or action to be taken (ACT - up to six characters), if the message passes this screen.

## rtrv-scr-destfld

## Retrieve Allowed DESTFLDs

Use this command to show the attributes of one or more allowed affected destination field (DESTFLD) screening references and associated attributes (destination point code, next screening function identifier, next screening function reference) that are allowed to receive SS7 messages from another network.

**Keyword:** **rtrv-scr-destfld**

**Related Commands:** **chg-scr-destfld, dlt-scr-destfld, ent-scr-destfld**

**Command Class:** Database Administration

### Parameters

**:actname=** (optional)

The name of the gateway screening stop action set. Stop actions must be administered using the **actname** parameter in conjunction with the gateway screening stop action table (see **chg-gws-actset** and **rtrv-gws-actset**).

**Range:** *ayyyyy*, **none**

1 alphabetic character followed by up to 5 alphanumeric characters.

**none**—Display only those gateway screening rules that do not have a gateway screening stop action set assigned to them

**:all=** (optional)

Displays all allowed DPC screening references.

**Range:** **yes, no**

**Default:** **no**

**:area=** (optional)

The ITU international area. The area is specified in the point code. The format of the point code is *zone-area-id*. An asterisk (\*) indicates the full range of values from **000-255**.

**Range:** **000-255 \***

**Default:** Display all

**:id=** (optional)

The ITU international ID. The parameter specifies the ID in the point code represented by format *zone-area-id*. An asterisk (\*) indicates the full range of values from **0-7**.

**Range:** **0-7 \***

**Default:** Display all

**:msa=** (optional)

The 24-bit ITU national main signaling area. The main signaling area is specified in the point code. The format of the point code is *msa-ssa-sp*. An asterisk (\*) indicates the full range of values from **000-255**.

**Range:** **000-255 \***

**:nc=** (optional)

The network cluster identifier value. This parameter restricts display to those entries containing this specific cluster of the point code represented by *ni-nc-ncm*. A single value or a range of values can be specified. An asterisk (\*) indicates the full range of values from **0-255**.

**Range:** **0-255 \***

**Default:** Display all

**:ncm=** (optional)

The network cluster member identifier value. This parameter restricts display to those entries containing this specific cluster member of the point code represented by *ni-nc-ncm*. A single value or a range of values can be specified. An asterisk (\*) indicates the full range of values from **0-255**.

**Range:** **0-255 \***

**Default:** Display all

**:ni=** (optional)

The network identifier value. This parameter restricts display to those entries containing this specific network of the point code represented by *ni-nc-ncm*. A single value or a range of values can be specified. An asterisk (\*) indicates the full range of values from **0-255**.

**Range:** **0-255 \***

**Default:** Display all

**:npc=** (optional)

The ITU national point code. An asterisk (\*) indicates the full range of values from **00000-16383**.

**NOTE: Gateway screening allows the ITU national point code to be displayed and entered in the database only as a single number. If you are using multiple-part ITU national point codes, see "Converting ITU National Point Code Formats" in Appendix A.**

**Range:** **00000-16383 \***

**:nsfi=** (optional)

This parameter indicates that the gateway screening process should stop. If specified for this command, the parameter must have the value of **stop**. The value of **stop** means that the gateway screening process ends and the message proceeds through normal routing.

**Range:** **stop**

**Default:** Display all screening references

**:nsr=** (optional)

The next screening reference parameter indicates which screening reference in the specified screening category (**nsfi**) is to be used in the screening process.

**Range:** *ayyy*

1 alphabetic character followed by up to 3 alphanumeric characters

**Default:** Display all

**:pcst=** (optional)

Point code subtype. This parameter indicates whether the specified ITU international or ITU national point code has no subtype prefix or has the spare point code prefix (s-).

**Range:** none, s

**Default:** none

**:sp=** (optional)

The 24-bit ITU national signaling point. This parameter specifies the signaling point (*sp*) in the point code represented by *msa-ssa-sp*. An asterisk (\*) indicates the full range of values from **000-255**.

**Range:** 000-255 \*

**:sr=** (optional)

The name of the individual DESTFLD screen to be displayed.

**Range:** ayyy

1 alphabetic character followed by up to 3 alphanumeric characters

**Default:** Display all.

**:ssa=** (optional)

The 24-bit ITU national sub signaling area. The sub signaling area is specified in the point code. The format of the point code is *msa-ssa-sp*. An asterisk (\*) indicates the full range of values from **000-255**.

**Range:** 0-255 \*, C

**:zone=** (optional)

The ITU international zone. The parameter specifies the zone in the point code represented by format *zone-area-id*. An asterisk (\*) indicates the full range of values from **0-7**.

**Range:** 0-7 \*, C

**Example**

```
rtrv-scr-destfld
rtrv-scr-destfld:sr=iec:ni=240:nc=001:ncm=010&&018
rtrv-scr-destfld:sr=iec:id=4:actname=cncf
rtrv-scr-destfld:all=yes
rtrv-scr-destfld:sr=dst1:zone=1:area=2:id=3:nsfi=stop:pcst=s
rtrv-scr-destfld:sr=dst1
```

**Dependencies**

If the **actname** parameter is specified, the **nsfi=stop** parameter must be specified.

The **nsfi=stop** parameter must be specified.

The **nsr** parameter cannot be specified in the command.

If the **actname** parameter is specified, the **nsr** parameter cannot be specified.

The value of the **actname** parameter must already be defined in the Gateway Screening Stop Action table with the **chg-gws-actset** command. These values are shown in the ACT NAME field of the **rtrv-gws-actset** command output.

If the **actname** parameter is specified with the screening reference name parameter, the specified value for the **actname** parameter must be assigned to that screening reference name.

If the **ni** parameter is specified as an asterisk (**ni=\***) or as a range, the **nc** and **ncm** parameters must be specified as an asterisk or as the full range **000-255**.

If the **nc** parameter is specified as an asterisk (**nc=\***), the **ncm** parameter must be specified as an asterisk or as the full range **000-255**.

If the **nc** parameter is specified as a single value or a range, a single value must be specified for the **ni** parameter.

If the **nc** parameter is specified as a range, the **ncm** parameter must be specified as an asterisk or as the full range **000-255**.

If the **ncm** parameter is specified as a single value, or a range other than the full range of **000-255**, the **ni** and the **nc** parameters must be specified with a single value.

ANSI point code value **000-000-000** and ITU-International point code value **0-000-0** are not allowed.

If the **zone=\*** parameter is specified, then the **area=\*** and the **id=\*** parameters must be specified.

If the **area=\*** parameter is specified, then the **id=\*** parameter must be specified.

If the **msa=\*** parameter is specified, then the **ssa=\*** and the **sp=\*** parameters must be specified.

If the **ssa=\*** parameter is specified, then the **sp=\*** parameter must be specified.

The specified screening reference (**sr**) must be in the allowed DESTFLD entity set.

The Spare Point Code Support feature must be enabled before the **pcst** parameter can be specified.

The spare point code subtype prefix (**s-**) is not supported for ANSI point codes (parameters **ni**, **nc**, **ncm**) or for 24-bit ITU national point codes (parameters **msa**, **ssa**, **sp**). The **pcst** parameter cannot be specified for ANSI and ITU-N24 point codes.

If the **pcst** parameter is specified, point codes with the specified subtype prefix (no prefix or **s-**) must exist in the database.

Any specified **area** or **ssa** parameter must already exist in the database.

Any specified **id** or **sp** parameter must already exist in the database.

Any specified **zone** or **msa** parameter must already exist in the database.

Any specified **nc** parameter must already exist in the database.

Any specified **ncm** parameter must already exist in the database.

Any specified **ni** parameter must already exist in the database.

Any specified **npc** parameter must already exist in the database.

Any specified **nsfi** parameter must already exist in the database.

Any specified **nsr** parameter must already exist in the database.

Any specified **pcst** parameter must already exist in the database.

If the **nsfi=fail** parameter is specified, then the **nni**, **nc**, **ncm**, **narea**, **nzone**, **nid**, **nmsa**, **nssa**, **nsp**, and **npc** parameters cannot have a value of **c**.

The Gateway Screening Stop Action table must be accessible.

## Notes

If no parameters are specified, the system displays a summary output.

If only the **all=yes** parameter is specified, the system displays a detailed output.

If the **all** parameter and any point code parameter are specified, the **all** parameter is ignored.

The REF column of the output of this command displays **YES** when the screen is referenced by another screen; otherwise, it displays **NO**.

An asterisk as a parameter value in this command displays only entries that have an asterisk as the same parameter value in the entry.

A range of values is specified by separating the values that define the range by two ampersands (**&&**); for example, **ni=025&&100** specifies all network indicators for ANSI point codes from **25** to **100**.

The spare point code subtype prefix **s-** is supported only for ITU international and ITU national point codes. The **pcst** parameter indicates whether the specified point code has no subtype prefix or has the spare point code prefix.

## Output

**rtrv-scr-destfld**

```

rlghncxa03w 03-03-13 13:12:38 EST EAGLE 31.3.0
SCREEN = ALLOWED DESTFLD
SR      REF  RULES
IEC     YES  2
WRD2    YES  1
WRD3    NO   4
WRD4    YES  9

```

;

**rtrv-scr-destfld:sr=iec:ni=240:nc=001:ncm=010&&018**

```

rlghncxa03w 03-03-13 13:13:21 EST EAGLE 31.3.0
SCREEN = ALLOWED DESTFLD
SR      NI      NC      NCM      NSFI  NSR/ACT
IEC     240     001     010&&020 STOP  -----

```

;

**rtrv-scr-destfld:sr=iec:id=4:actname=cncf**

```

rlghncxa03w 03-03-13 13:13:56 EST EAGLE 31.3.0
SCREEN = ALLOWED DESTFLD
SR      ZONE     AREA     ID      NSFI  NSR/ACT
IEC     1        003      4       STOP  CNCF

```

;

**rtrv-scr-destfld:all=yes**

```

rlghncxa03w 03-03-13 13:14:18 EST EAGLE 31.3.0
SCREEN = ALLOWED DESTFLD
SR      NI      NC      NCM      NSFI  NSR/ACT
IEC     240     001     010     STOP  CNCF
IEC     241     010     *       STOP  -----

SR      ZONE     AREA     ID      NSFI  NSR/ACT
IEC     1        003      4       STOP  -----
IEC     1        003      5       STOP  CR

SR      NPC
IEC     00235
IEC     00240
NSFI  NSR/ACT
STOP  CNCF
STOP  -----

```

;

**rtrv-scr-destfld:sr=dst1:zone=1:area=2:id=3:nsfi=stop:pcst=s**

```

tekelecstp 05-01-06 11:40:26 EST EAGLE 31.12.0
SCREEN = ALLOWED DESTFLD
SR      ZONE     AREA     ID      NSFI  NSR/ACT
dst1    s-1      002      3       STOP  -----

```

;

**rtrv-scr-destfld:sr=dst1**

```

tekelecstp 05-01-06 11:40:26 EST EAGLE 31.12.0
SCREEN = ALLOWED DESTFLD
SR      ZONE     AREA     ID      NSFI  NSR/ACT
dst1    s-1      002      3       STOP  -----

SR      NPC
dst1    s-00128
NSFI  NSR/ACT
STOP  -----

```

;



**Legend**

For a summary report:

**REF**—This indicates whether a screen is referenced by another screen. If **NO**, the screen is not used. If you need a more detailed output, use the **rtrv-scr-destfld:all=yes** command, or specify the specific screening reference.

**RULES**—The number of screening rules in that screening table.

For a detailed report:

- **SCREEN = ALLOWED DESTFLD**—This is the screen type.
- **SR**—This is used to identify the various screen sets being used. It can be up to four characters in length.
- **NI - NC - NCM**—The point code referenced within the screen. For international point codes, these columns are ZONE - AREA - ID. For 24-bit ITU national point codes, these columns are MSA-SSA-SP. For national point codes, these columns become the single column NPC.
- **NSFI**—The next screening category to be used.
- **NSR/ACT**—The name of the next screening reference (NSR - up to four characters) or action to be taken (ACT - up to six characters), if the message passes this screen.

**rtrv-scr-dpc****Retrieve Allowed DPC**

Use this command to show the attributes of one or more allowed DPC screening references and associated attributes (destination point code, next screening function identifier, next screening function reference) that are allowed to receive SS7 messages from another network.

**Keyword:** **rtrv-scr-dpc**

**Related Commands:** **chg-scr-dpc, dlt-scr-dpc, ent-scr-dpc**

**Command Class:** Database Administration

**Parameters**

**:actname=** (optional)

The name of the gateway screening stop action set. Stop actions must be administered using the **actname** parameter in conjunction with the gateway screening stop action table (see **chg-gws-actset** and **rtrv-gws-actset**).

**Range:** *ayyyyy*, **none**

1 alphabetic character followed by up to 5 alphanumeric characters.

**none**—Display only those gateway screening rules that do not have a gateway screening stop action set assigned to them

**:all=** (optional)

Displays all allowed DPC screening references.

**Range:** **yes, no**

**Default:** **no**

**:area=** (optional)

The ITU international area. The area is specified in the point code. The format of the point code is *zone-area-id*. An asterisk (\*) indicates the full range of values from **000–255**.

**Range:** **000-255 \***

**:id=** (optional)

The ITU international ID. The parameter specifies the ID in the point code represented by format *zone-area-id*. An asterisk (\*) indicates the full range of values from **0–7**.

**Range:** **0-7, \***

**:msa=** (optional)

The 24-bit ITU national main signaling area. The main signaling area is specified in the point code. The format of the point code is *msa-ssa-sp*. An asterisk (\*) indicates the full range of values from **000-255**.

**Range:** **000-255 \***

**:nc=** (optional)

The network cluster identifier value. This parameter restricts display to those entries containing this specific cluster of the point code represented by *ni-nc-ncm*. A single value or a range of values can be specified. An asterisk (\*) indicates the full range of values from **0–255**.

**Range:** **0-255 \*, C**

**Default:** Display all

**:ncm=** (optional)

The network cluster member identifier value. This parameter restricts display to those entries containing this specific cluster member of the point code represented by *ni-nc-ncm*. A single value or a range of values can be specified. An asterisk (\*) indicates the full range of values from **0–255**.

**Range:** **0-255 \***

**Default:** Display all

**:ni=** (optional)

The network identifier value. This parameter restricts display to those entries containing this specific network of the point code represented by *ni-nc-ncm*. A single value or a range of values can be specified. An asterisk (\*) indicates the full range of values from **0–255**.

**Range:** **0-255 \***

**Default:** Display all

**:npc=** (optional)

The ITU national point code. An asterisk (\*) indicates the full range of values from **00000–16383**.

**NOTE: Gateway screening allows the ITU national point code to be displayed and entered in the database only as a single number. If you are using multiple-part ITU national point codes, see "Converting ITU National Point Code Formats" in Appendix A.**

**Range:** **00000-16383 \***

**:nsfi=** (optional)

This parameter specifies the next screening category that is used in the gateway screening process, or it indicates that the gateway screening process should stop.

**Range:** **blkdpc, cgpa, destfld, isup, stop**

**blkdpc**—Blocked DPC is the next screening category.

**cgpa**—Allowed calling party address is the next screening category.

**destfld**—Allowed destination field (DESTFLD) is the next screening category.

**isup**—ISUP message type (ISUP) is the next screening category.

**stop**—The gateway screening process ends and the message proceeds through normal routing.

**Default:** Display all screen references

**:nsr=** (optional)

The next screening reference parameter indicates which screening reference in the specified screening category (**nsfi**) is to be used in the screening process. This parameter is mandatory if

**nsfi** is other than **stop** or **fail**. The **nsr** parameter cannot be entered if **nsfi** is **stop** or **fail**, or the **copy=yes** parameter is specified.

**Range:** *ayyy*  
1 alphabetic character followed by up to 3 alphanumeric characters

**Default:** Display all

**:pcst=** (optional)

Point code subtype. This parameter indicates whether the specified ITU international or ITU national point code has no subtype prefix or has the spare point code prefix (s-).

**Range:** **none, s**

**Default:** **none**

**:sp=** (optional)

The 24-bit ITU national signaling point. This parameter specifies the signaling point (sp) in the point code represented by *msa-ssa-sp*. An asterisk (\*) indicates the full range of values from **000-255**.

**Range:** **000-255 \***

**:sr=** (optional)

The allowed DPC screening reference name

**Range:** *ayyy*  
1 alphabetic character followed by up to 3 alphanumeric characters

**Default:** Display all.

**:ssa=** (optional)

The 24-bit ITU national sub signaling area. The sub signaling area is specified in the point code. The format of the point code is *msa-ssa-sp*. An asterisk (\*) indicates the full range of values from **000-255**.

**Range:** **0-255 \***

**:zone=** (optional)

The ITU international zone. The parameter specifies the zone in the point code represented by format *zone-area-id*. An asterisk (\*) indicates the full range of values from **0-7**.

**Range:** **0-7 \***

### Example

```
rtrv-scr-dpc
rtrv-scr-dpc:sr=iec:ni=240:nc=001:ncm=010&&018
rtrv-scr-dpc:sr=iec:id=4
rtrv-scr-dpc:all=yes
rtrv-scr-dpc:all=yes:actname=cncf
rtrv-scr-dpc:sr=dpc1:npc=128:nsfi=stop:pcst=s
```

### Dependencies

ANSI point code value **000-000-000** and ITU-International point code value **0-000-0** are not allowed.

The specified screening reference (**sr**) must be in the allowed DPC entity set.

Any specified **ni** parameter must already exist in the allowed DPC entity for the screening reference.

The Spare Point Code Support feature must be enabled before the **pcst** parameter can be specified.

The spare point code subtype prefix (s-) is not supported for ANSI point codes (parameters **ni**, **nc**, **ncm**) or for 24-bit ITU national point codes (parameters **msa**, **ssa**, **sp**). The **pcst** parameter cannot be specified for ANSI and ITU-N24 point codes.

If the **pcst** parameter is specified, point codes with the specified subtype prefix (no prefix or s-) must exist in the database.

If **ni=\*** is specified, **nc=\*** and **ncm=\*** must be specified.

If **nc=\*** is specified, **ncm=\*** must be specified.

If the **zone=\*** parameter is specified, then the **area=\*** and the **id=\*** must be specified.

If the **area=\*** parameter is specified, then the **id=\*** parameter must be specified.

If the **msa=\*** parameter is specified, then the **ssa=\*** and the **sp=\*** must be specified.

If the **ssa=\*** parameter is specified, then the **sp=\*** parameter must be specified.

If the value of the **nsfi=stop** parameter is specified, then the **nsr** parameter cannot be specified.

If the **nsr** parameter is specified, then the **actname** parameter cannot be specified.

If the **actname** parameter is specified, the **nsfi=stop** parameter must be specified.

The value of the **actname** parameter must already be defined in the Gateway Screening Stop Action table with the **chg-gws-actset** command. These values are shown in the ACT NAME field of the **rtrv-gws-actset** command output.

If the **actname** parameter is specified with the screening reference name parameter, the specified value for the **actname** parameter must be assigned to that screening reference name.

Any specified **npc** parameter must already exist in the allowed DPC entity for the screening reference.

Any specified **ncm** parameter must already exist in the allowed DPC entity for the screening reference.

Any specified **nc** parameter must already exist in the allowed DPC entity for the screening reference.

Any specified **nsfi** parameter must already exist in the allowed DPC entity for the screening reference.

Any specified **nsr** parameter must already exist in the allowed DPC entity for the screening reference.

Any specified **pcst** parameter must already exist in the allowed DPC entity for the screening reference.

Any specified **area** or **ssa** parameter must already exist in the allowed DPC entity for the screening reference.

Any specified **id** or **sp** parameter must already exist in the allowed DPC entity for the screening reference.

Any specified **zone** or **msa** parameter must already exist in the allowed DPC entity for the screening reference.

If the **nsfi=fail** parameter is specified, then the **nni**, **nc**, **ncm**, **narea**, **nzone**, **nid**, **nmsa**, **nssa**, **nsp**, and **npc** parameters cannot have a value of **c**.

## Notes

If no parameters are specified, a list of allowed DPC references is displayed indicating whether they are referenced or not.

If a single allowed DPC screening reference is specified, the specified entity set requested is shown.

If **all=yes** and no other parameter is specified, detailed information for all of the screening reference entities in the allowed DPC entity set are shown.

If the **all** parameter is specified and other parameters are also specified, the **all** parameter is ignored.

An asterisk as a parameter value in this command displays only entries that have an asterisk as the same parameter value in the entry.

A range of values is specified by separating the values that define the range by two ampersands (**&&**); for example, **:ni=025&&100** specifies all network indicators for ANSI point codes from **25** to **100**.

The spare point code subtype prefix **s-** is supported only for ITU international and ITU national point codes. The **pcst** parameter indicates whether the specified point code has no subtype prefix or has the spare point code prefix.

## Output

**rtrv-scr-dpc**

```

rlghncxa03w 03-03-13 13:12:38 EST EAGLE 31.3.0
SCREEN = ALLOWED DPC
SR    REF  RULES
IEC   YES   2
WRD2  YES   1
WRD3  NO    4
WRD4  YES   9

```

;

**rtrv-scr-dpc:sr=iec:ni=240:nc=001:ncm=010&&018**

```

rlghncxa03w 03-03-13 13:13:21 EST EAGLE 31.3.0
SCREEN = ALLOWED DPC
SR    NI      NC      NCM      NSFI      NSR/ACT
IEC   240     001     010&&020 STOP     -----

```

;

**rtrv-scr-dpc:sr=iec:id=4**

```

rlghncxa03w 03-03-13 13:13:56 EST EAGLE 31.3.0
SCREEN = ALLOWED DPC
SR    ZONE    AREA    ID      NSFI      NSR/ACT
IEC   1       003     4       BLKOPC   blk1

```

;

**rtrv-scr-dpc:all=yes**

```

rlghncxa03w 03-03-13 13:14:18 EST EAGLE 31.3.0
SCREEN = ALLOWED DPC
SR    NI      NC      NCM      NSFI      NSR/ACT
IEC   240     001     010     STOP     -----
IEC   241     010     *       CGPA     cg04

SR    ZONE    AREA    ID      NSFI      NSR/ACT
IEC   1       003     4       BLKDPC   blk1
IEC   1       003     5       STOP     -----

SR    NPC
IEC   00235
IEC   00240
NSFI      NSR/ACT
CGPA     cg04
CGPA     cg01

```

;

**rtrv-scr-dpc:sr=dpcl:actname=copy**

```

rlghncxa03w 03-03-13 13:16:13 EST EAGLE 31.3.0
SCREEN = ALLOWED DPC
SR    NI      NC      NCM      NSFI      NSR/ACT
dpcl  010     010     010     STOP     COPY
dpcl  010     010     012     STOP     COPY

```

;

**rtrv-scr-dpc:sr=dpcl:npc=128:pcst=s**

```

tekelecstp 05-01-06 11:29:11 EST EAGLE 31.12.0
SCREEN = ALLOWED DPC
SR    NPC
dpcl  s-00128
NSFI      NSR/ACT
STOP     -----

```

;

**rtrv-scr-dpc:sr=dpcl**

```

tekelecstp 05-01-06 11:29:11 EST EAGLE 31.12.0
SCREEN = ALLOWED DPC
SR    ZONE    AREA    ID      NSFI      NSR/ACT

```

```

dpc1  s-1      002      3          STOP    -----
SR      NPC
dpc1  s-00128          NSFI    NSR/ACT
                              STOP    -----
;

```

**Legend**

For a summary report:

**REF**—This indicates whether a screen is referenced by another screen. If NO, the screen is not used. If you need a more detailed output, use the **rtrv-scr-dpc:all=yes** command, or specify the specific screening reference.

**RULES**—The number of screening rules in that screening table.

For a detailed report:

**SCREEN = ALLOWED DPC**—This is the screen type.

**SR**—This is used to identify the various screen sets being used. It can be up to four characters in length.

**NI - NC - NCM**—The point code referenced within the screen. For international point codes, these columns are ZONE - AREA - ID. For 24-bit ITU national point codes, these columns are MSA-SSA-SP. For national point codes, these columns become the single column NPC.

**NSFI**—The next screening category to be used.

**NSR/ACT**—The name of the next screening reference (NSR - up to four characters) or action to be taken (ACT - up to six characters), if the message passes this screen.

**rtrv-scr-isup**

**Retrieve Allowed ISUP Screening Reference**

Use this command to display one allowed ISUP screening reference or all allowed ISUP screening references in the Allowed ISUP entity set.

**Keyword:** rtrv-scr-isup

**Related Commands:** chg-scr-isup, dlt-scr-isup, ent-scr-isup

**Command Class:** Database Administration

**Parameters**

**:actname=** (optional)

The name of the gateway screening stop action set. Stop actions must be administered using the **actname** parameter in conjunction with the gateway screening stop action table (see **chg-gws-actset** and **rtrv-gws-actset**).

**Range:** ayyyyy  
 1 alphabetic character followed by up to 5 alphanumeric characters.

**:all=** (optional)

This parameter is specified to display all allowed ISUP screening references in the Allowed ISUP entity set.

**Range:** yes, no

**Default:** no

**:isupmt/tupmt=** (optional)

ISUP message type or TUP message type in the specified entry. The **tupmt** parameter is not valid for SEAS. A single value or range of values can be entered. An asterisk (\*) indicates the entire range of 0-255.

**Range:** 000-255 \*

**:nsfi=** (optional)

This parameter specifies the next screening category that is used in the gateway screening process. If specified, the parameter must have the value of **stop**.

**Range:** **stop**

**stop**—The gateway screening process ends and the message proceeds through normal routing.

**:nsr=** (optional)

Next screening reference. The **nsr** parameter cannot be specified if **nsfi=stop** is specified.

**Range:** *ayyy*

1 alphabetic character followed by up to 3 alphanumeric characters

**Default:** No value given

**:sr=** (optional)

The individual ISUP screen to be displayed.

**Range:** *ayyy*

1 alphabetic character followed by up to 3 alphanumeric characters

### Example

```
rtrv-scr-isup:sr=iec:isupmt=1:nisupmt=1&&2
```

```
rtrv-scr-isup:sr=tu01:tupmt=0&&255
```

### Dependencies

If the **nsfi** parameter is specified, the value must be **stop**.

The **nsr** parameter cannot be specified if the **actname** parameter is specified.

The **nsr** parameter cannot be specified if the **nsfi=stop** parameter is specified.

If **sr** is specified, the value must exist in the database.

The value of the **actname** parameter must be defined in the gateway screening stop action table with the **chg-gws-actset** command. These values are shown in the ACT NAME field of the **rtrv-gws-actset** command output.

### Notes

A range of values for the **isupmt** parameter or **tupmt** parameter can be specified by separating the values that define the range by two ampersands (&&); for example, **:isupmt=025&&100** specifies all ISUP message types from **25** to **100**. The value to the left of the && must be less than the value to the right of the && in the range.

An asterisk can be used for a parameter value in the **chg-scr-isup**, **rtrv-scr-isup**, and **rtrv-scr-isup** commands only if that parameter value was specified as an asterisk in the **ent-scr-isup** command to define the parameter value.

If no parameters are specified, a list of allowed ISUP references is produced indicating whether they are referenced or not.



## Output

**rtrv-scr-isup**

```

tekelecstp 02-09-02 11:10:38 EST  EAGLE 30.0.0
SCREEN = ALLOWED ISUP
SR   REF  RULES
iall NO    1
ibig NO    1
iec  NO    2
is01 YES   1
is02 YES   1
isu  NO    1
isu1 NO    1
isu2 NO    1
isw1 NO    1

```

;

**rtrv-scr-isup:sr=iall**

```

tekelecstp 02-09-02 11:13:25 EST  EAGLE 30.0.0
SCREEN = ALLOWED ISUP
SR   ISUPMT  NSFI  NSR/ACT
iall *        STOP  -----

```

;

**rtrv-scr-isup:sr=iec:isupmt=1&&9**

```

tekelecstp 02-09-02 11:13:25 EST  EAGLE 30.0.0
SCREEN = ALLOWED ISUP
SR   ISUPMT  NSFI  NSR/ACT
iec  001&&002 STOP  -----
iec  009      STOP  -----

```

;

**rtrv-scr-isup:isupmt=\***

```

tekelecstp 02-09-02 11:13:25 EST  EAGLE 30.0.0
SCREEN = ALLOWED ISUP
SR   ISUPMT  NSFI  NSR/ACT
iall *        STOP  -----
isu2 *        STOP  -----
isw1 *        STOP  -----

```

;

**rtrv-scr-isup:sr=tu01:tupmt=0&&255**

```

tekelecstp 03-11-13 13:10:02 EST  EAGLE 31.4.0
SCREEN = ALLOWED ISUP
SR   ISUPMT  NSFI  NSR/ACT
      TUPMT/
tu01 002      STOP  -----

```

;

**rtrv-scr-isup:all=yes**

```

tekelecstp 02-09-13 13:10:02 EST  EAGLE 30.0.0
SCREEN = ALLOWED ISUP
SR   ISUPMT  NSFI  NSR/ACT
is01 001      STOP  -----
is02 001&&010 STOP  -----

```

```
is03 *          STOP  -----
```

```
;
```

### Legend

**REF**—This indicates whether a screen is referenced by another screen. If NO, the screen is not used. If you need a more detailed output, use the **rtrv-scr-isup:all=yes** command, or specify the specific screening reference.

**RULES**—The number of screening rules in that screening table.

For a detailed report:

**SCREEN = ALLOWED ISUP**— This is the screen type.

**SR**—This is used to identify the various screen sets being used. It can be up to four characters in length.

**ISUPMT/TUPMT**—The ISUP message type or TUP Message type in the entry.

**NSFI**—The next screening category to be used.

**NSR/ACT**—The name of the next screening reference (NSR - up to four characters) or action to be taken (ACT - up to six characters), if the message passes this screen.

## rtrv-scr-opc

### Retrieve Allowed OPC

Use this command to show an allowed OPC screening reference and associated attributes (originating point code, next screening function identifier, next screening function reference).

**Keyword:** **rtrv-scr-opc**

**Related Commands:** **chg-scr-opc, dlt-scr-opc, ent-scr-opc**

**Command Class:** Database Administration

### Parameters

**:actname=** (optional)

The name of the gateway screening stop action set. Stop actions must be administered using the **actname** parameter in conjunction with the gateway screening stop action table (see **chg-gws-actset** and **rtrv-gws-actset**).

**Range:** *ayyyyy*, **none**

1 alphabetic character followed by up to 5 alphanumeric characters.

**none**—Display only those gateway screening rules that do not have a gateway screening stop action set assigned to them

**:all=** (optional)

Displays all allowed OPC screening references.

**Range:** **yes, no**

**Default:** Display all

**:area=** (optional)

The ITU international area. The area is specified in the point code. The format of the point code is *zone-area-id*. An asterisk (\*) indicates the full range of values from **000–255**.

**Range:** **000-255\***

**:id=** (optional)

The ITU international ID. The parameter specifies the ID in the point code represented by format *zone-area-id*. An asterisk (\*) indicates the full range of values from **0–7**.

**Range:** **0-7,\***

**:msa=** (optional)

The 24-bit ITU national main signaling area. The main signaling area is specified in the point code. The format of the point code is *msa-ssa-sp*. An asterisk (\*) indicates the full range of values from **000-255**.

**Range:** 000-255 \*

**:nc=** (optional)

The network cluster identifier value. This parameter restricts display to those entries containing this specific cluster of the point code represented by *ni-nc-ncm*. A single value or a range of values can be specified. An asterisk (\*) indicates the full range of values from **0-255**.

**Range:** 0-255 \*

**Default:** Display all

**:ncm=** (optional)

The network cluster member identifier value. This parameter restricts display to those entries containing this specific cluster member of the point code represented by *ni-nc-ncm*. A single value or a range of values can be specified. An asterisk (\*) indicates the full range of values from **0-255**.

**Range:** 0-255 \*

**Default:** Display all

**:ni=** (optional)

The network identifier value. This parameter restricts display to those entries containing this specific network of the point code represented by *ni-nc-ncm*. A single value or a range of values can be specified. An asterisk (\*) indicates the full range of values from **0-255**.

**Range:** 0-255 \*

**Default:** Display all

**:npc=** (optional)

The ITU national point code. An asterisk (\*) indicates the full range of values from **00000-16383**.

**NOTE: Gateway screening allows the ITU national point code to be displayed and entered in the database only as a single number. If you are using multiple-part ITU national point codes, see "Converting ITU National Point Code Formats" in Appendix A.**

**Range:** 00000-16383 \*

**:nsfi=** (optional)

This parameter specifies the next screening category that is used in the gateway screening process, or it indicates that the gateway screening process should stop.

**Range:** blkopc, sio, dpc, blkdpc, cgpa, stop

**blkopc**—Blocked OPC is the next screening category.

**sio**—Allowed SIO is the next screening category

**dpc**—Allowed DPC is the next screening category.

**blkdpc**—Blocked DPC is the next screening category.

**cgpa**—Allowed calling party address is the next screening category.

**stop**—The gateway screening process ends and the message proceeds through normal routing.

**Default:** Display all screening referenes

**:nsr=** (optional)

The next screening reference parameter indicates which screening reference in the specified screening category (**nsfi**) is to be used in the screening process. This parameter is mandatory if **nsfi** is other than **stop** or **fail**. The **nsr** parameter cannot be entered if **nsfi** is **stop** or **fail**, or the **copy=yes** parameter is specified.

**Range:** ayyy

1 alphabetic character followed by up to 3 alphanumeric characters

**Default:** Display all

**:pcst=** (optional)

Point code subtype. This parameter indicates whether the specified ITU international or ITU national point code has no subtype prefix or has the spare point code prefix (s-).

**Range:** none, s

**Default:** none

**:sp=** (optional)

The 24-bit ITU national signaling point. This parameter specifies the signaling point (*sp*) in the point code represented by *msa-ssa-sp*. An asterisk (\*) indicates the full range of values from **000-255**.

**Range:** 000-255 \*

**:sr=** (optional)

The allowed OPC screening reference name

**Range:** ayyy

1 alphabetic character followed by up to 3 alphanumeric characters

**Default:** Display all.

**:ssa=** (optional)

The 24-bit ITU national sub signaling area. The sub signaling area is specified in the point code. The format of the point code is *msa-ssa-sp*. An asterisk (\*) indicates the full range of values from **000-255**.

**Range:** 0-255 \*

**:zone=** (optional)

The ITU international zone. The parameter specifies the zone in the point code represented by format *zone-area-id*. An asterisk (\*) indicates the full range of values from **0-7**.

**Range:** 0-7, \*, C

### Example

```
rtrv-scr-opc
rtrv-scr-opc:sr=iec:ni=240:nc=001:ncm=010&&018
rtrv-scr-opc:sr=iec:id=4
rtrv-scr-opc:all=yes
rtrv-scr-opc:sr=opc1:actname=cr
rtrv-scr-opc:sr=opc1:npc=128:nsfi=fail:pcst=s
```

### Dependencies

ANSI point code value **000-000-000** and ITU-International point code value **0-000-0** are not allowed.

If the **ni=\*** parameter is specified, the **nc=\*** and the **ncm=\*** parameters must be specified.

If the **nc=\*** parameter is specified, then the **ncm=\*** parameter must be specified.

If the **zone=\*** parameter is specified, then the **area=\*** and the **id=\*** parameters must be specified.

If the **area=\*** parameter is specified, then the **id=\*** parameter must be specified.

If the **msa=\*** parameter is specified, then the **ssa=\*** and the **sp=\*** parameters must be specified.

If the **ssa=\*** parameter is specified, then the **sp=\*** parameter must be specified.

If the **ni** parameter is specified as an asterisk (**ni=\***) or as a range, the **nc** and **ncm** parameters must be specified as an asterisk or as the full range **000-255**.

If the **nc** parameter is specified as an asterisk (**nc=\***), the **ncm** parameter must be specified as an asterisk or as the full range **000-255**.

If the **nc** parameter is specified as a single value or a range, a single value must be specified for the **ni** parameter.

If the **nc** parameter is specified as a range, the **ncm** parameter must be specified as an asterisk or as the full range **000–255**.

If the **ncm** parameter is specified as a single value, or a range other than the full range of **000–255**, the **ni** and the **nc** parameters must be specified with a single value.

If the **nsr** parameter is specified, then the **actname** parameter cannot be specified.

If the **actname** parameter is specified, the **nsfi=stop** parameter must be specified.

If the value of the **nsfi=stop** parameter is specified, then the **nsr** parameter cannot be specified.

The value of the **actname** parameter must already be defined in the Gateway Screening Stop Action table with the **chg-gws-actset** command. These values are shown in the ACT NAME field of the **rtrv-gws-actset** command output.

If the **actname** parameter is specified with the screening reference name parameter, the specified value for the **actname** parameter must be assigned to that screening reference name.

The specified screening reference (**sr**) must be in the allowed OPC entity set.

The Spare Point Code Support feature must be enabled before the **pcst** parameter can be specified.

The spare point code subtype prefix (**s-**) is not supported for ANSI point codes (parameters **ni**, **nc**, **ncm**) or for 24-bit ITU national point codes (parameters **msa**, **ssa**, **sp**). The **pcst** parameter cannot be specified for ANSI and ITU-N24 point codes.

If the **pcst** parameter is specified, point codes with the specified subtype prefix (no prefix or **s-**) must exist in the database.

Any specified **ni** parameter must already exist in the allowed OPC entity for the screening reference.

Any specified **nc** parameter must already exist in the allowed OPC entity for the screening reference.

Any specified **ncm** parameter must already exist in the allowed OPC entity for the screening reference.

Any specified **npc** parameter must already exist in the allowed OPC entity for the screening reference.

Any specified **nsfi** parameter must already exist in the allowed OPC entity for the screening reference.

Any specified **nsr** parameter must already exist in the allowed OPC entity for the screening reference.

Any specified **pcst** parameter must already exist in the allowed OPC entity for the screening reference.

Any specified **area** or **ssa** parameter must already exist in the allowed OPC entity for the screening reference.

Any specified **id** or **sp** parameter must already exist in the allowed OPC entity for the screening reference.

Any specified **zone** or **msa** parameter must already exist in the allowed OPC entity for the screening reference.

If the **nsfi=fail** parameter is specified, then the **nmi**, **nc**, **ncm**, **narea**, **nzone**, **nid**, **nmsa**, **nssa**, **nsp**, and **npc** parameters cannot have a value of **c**.

The Gateway Screening Stop Action table must be accessible.

## Notes

If no parameters are specified, a list of allowed OPC references is produced indicating whether they are referenced or not.

If a single allowed OPC screening reference is specified, the specified entity set requested is shown.

If **all=yes** and no other parameter is specified, detailed information for all of the screening reference entities in the allowed OPC entity set are shown.

If **all** is specified and other parameters are also specified, the **all** parameter is ignored.

An asterisk specified as a parameter value in this command displays only entries that have an asterisk as the same parameter value in the entry.

A range of values is specified by separating the values that define the range by two ampersands (**&&**); for example, **:ni=025&&100** specifies all network indicators for ANSI point codes from **25** to **100**.

The spare point code subtype prefix **s-** is supported only for ITU international and ITU national point codes. The **pcst** parameter indicates whether the specified point code has no subtype prefix or has the spare point code prefix.

Output

**rtrv-scr-opc**

```
rlghncxa03w 03-03-13 13:12:38 EST EAGLE 31.3.0
SCREEN = ALLOWED OPC
SR   REF  RULES
IEC  YES   2
WRD2 YES   1
WRD3 NO    4
WRD4 YES   9
```

;

**rtrv-scr-opc:sr=iec:ni=240:nc=001:ncm=010&&018**

```
rlghncxa03w 03-03-13 13:13:21 EST EAGLE 31.3.0
SCREEN = ALLOWED OPC
SR   NI      NC      NCM      NSF1     NSR/ACT
IEC  240     001     010&&020 STOP  -----
```

;

**rtrv-scr-opc:sr=iec:id=4**

```
rlghncxa03w 03-03-13 13:13:56 EST EAGLE 31.3.0
SCREEN = ALLOWED OPC
SR   ZONE   AREA   ID      NSF1     NSR/ACT
IEC  1      003    4       BLKOPC  blk1
```

;

**rtrv-scr-opc:all=yes**

```
rlghncxa03w 03-03-13 13:14:18 EST EAGLE 31.3.0
SCREEN = ALLOWED OPC
SR   NI      NC      NCM      NSF1     NSR/ACT
IEC  240     001     010     STOP  -----
IEC  241     010     *       CGPA   cg04

SR   ZONE   AREA   ID      NSF1     NSR/ACT
IEC  1      003    4       BLKOPC  blk1
IEC  1      003    5       STOP  -----

SR   NPC
IEC  00235  CGPA   cg04
IEC  00240  CGPA   cg01

SR   NI      NC      NCM      NSF1     NSR/ACT
WRD2 243     015     001     STOP  -----
WRD3 243     105     002     CGPA   WRD4
```

;

**rtrv-scr-opc:sr=opc1:actname=cr**

```
rlghncxa03w 03-03-13 13:16:13 EST EAGLE 31.3.0
SCREEN = ALLOWED OPC
SR   NI      NC      NCM      NSF1     NSR/ACT
opc1 010     010     010     STOP  CR
opc1 010     010     012     STOP  CR
```

;

**rtrv-scr-opc:sr=op55**

```
tekelecstp 03-03-06 11:30:42 EST EAGLE 31.0.0
SR   MSA     SSA     SP      NSF1     NSR/ACT
op55 007     077     007     BLKOPC  bo55
```

;

```
rtrv-scr-opc:sr=opc1:npc=128:nsfi=fail
```

```
tekelecstp 05-01-06 11:30:42 EST EAGLE 31.12.0
SR      NPC      NSFI      NSR/ACT
opc1   s-00128   FAIL      -----
```

;

### Legend

For a summary report:

**REF**—This indicates whether a screen is referenced by another screen. If NO, the screen is not used. If you need a more detailed output, use the **rtrv-scr-opc:all=yes** command, or specify the specific screening reference.

**RULES**—The number of screening rules in that screening table.

For a detailed report:

**SCREEN = ALLOWED OPC**— This is the screen type.

**SR**—This is used to identify the various screen sets being used. It can be up to four characters in length.

**NI - NC - NCM**—The point code referenced within the screen. For international point codes, these columns are ZONE - AREA - ID. For 24-bit ITU national point codes, these columns are MSA-SSA-SP. For national point codes, these columns become the single column NPC.

**NSFI**—The next screening category to be used.

**NSR/ACT**—The name of the next screening reference (NSR - up to four characters) or action to be taken (ACT - up to six characters), if the message passes this screen.

## rtrv-scr-sio

### Retrieve Allowed SIO

Use this command to show the attributes of one or more **nic/si/h0/h1** combinations that are allowed for SS7 messages from another network.

**Keyword:** rtrv-scr-sio

**Related Commands:** chg-scr-sio, dlt-scr-sio, ent-scr-sio

**Command Class:** Database Administration

### Parameters

**:actname=** (optional)

The name of the gateway screening stop action set. Stop actions must be administered using the **actname** parameter in conjunction with the gateway screening stop action table (see **chg-gws-actset** and **rtrv-gws-actset**).

**Range:** ayyyyy

1 alphabetic character followed by up to 5 alphanumeric characters.

**none**—Display only those gateway screening rules that do not have a gateway screening stop action set assigned to them

**:all=** (optional)

Displays all allowed SIO screening references.

**Range:** yes, no

**Default:** no



**:h0=** (optional)

H0 heading code. A single value or a range of values can be specified. An asterisk (\*) indicates all possible values; that is, the entire range of **0–15**.

**Range:** **0-15 \***

**Default:** Display all

**:h1=** (optional)

H1 heading code. A single value or a range of values can be specified. An asterisk (\*) indicates all possible values; that is, the entire range of **0–15**.

**Range:** **0-15 \***

**Default:** Display all

**:nic=** (optional)

The network indicator code. An asterisk (\*) indicates all possible values; that is, the entire range of **0–3**.

**Range:** **0-3 \***

**Default:** Display all

**:nsfi=** (optional)

This parameter specifies the next screening category that is used in the gateway screening process, or it indicates that the gateway screening process should stop.

**Range:** **blkdpc, cgpa, cdpa, destfld, dpc, isup, stop**

**blkdpc**—Blocked DPC is the next screening category.

**cgpa**—Allowed calling party address is the next screening category.

**cdpa**—Allowed called party address is the next screening category.

**destfld**—Allowed destination field (DESTFLD) is the next screening category.

**dpc**—Allowed DPC is the next screening category.

**isup**—ISUP message type (ISUP) is the next screening category.

**stop**—The gateway screening process ends and the message proceeds through normal routing.

**Default:** Display all screening references

**:nsr=** (optional)

The next screening reference parameter indicates which screening reference in the specified screening category (**nsfi**) is to be used in the screening process.

(optional; mandatory if **nsfi** is other than **stop**; cannot be entered if **nsfi=stop**)

**Range:** *ayyy*

1 alphabetic character followed by up to 3 alphanumeric characters

**Default:** Display all

**:pri=** (optional)

Message priority. A single value or a range of values can be specified. An asterisk (\*) indicates all possible values; that is, the entire range of **0–3**.

**Range:** **0-3 \***

**Default:** Display all

**:si=** (optional)

The service indicator.

**Range:** **0-15 \***

**Default:** Display all

**:sr=** (optional)

The allowed SIO screening reference name

**Range:** *ayyy*

1 alphabetic character followed by up to 3 alphanumeric characters

**Default:** Display all

### Example

```
rtrv-scr-sio
rtrv-scr-sio:sr=iec:nic=1:si=3:pri=2&&3
rtrv-scr-sio:sr=sio1:nic=1:si=1
rtrv-scr-sio:sr=sio1:nic=1:si=1:h0=1:h1=*
rtrv-scr-sio:sr=sio1:si=1:h0=1:h1=1
rtrv-scr-sio:all=yes
rtrv-scr-sio:sr=iec:nic=1:si=1:actname=crncf
```

### Dependencies

If the **si** parameter is not equal to **00**, **01**, or **02**, the **h0** and **h1** parameters cannot be specified.

If the **nic**, **si**, and **h0/h1** parameters are specified, the SIO screening reference must be in the allowed SIO entity set.

The network indicator code (**nic**) must be specified if the service indicator is specified.

The network indicator code (**nic**) and the service indicator (**si**) must be specified if the **h0** and **h1** parameters are specified.

If an asterisk value is specified for the **h0** parameter, the **h1** parameter cannot be specified.

If the **nsfi=stop** parameter is specified, then the **nsr** parameter cannot be specified.

If the **actname** parameter is specified, then the **nsfi=stop** parameter must be specified.

If the **nsr** parameter is specified, then the **actname** parameter cannot be specified.

If the **actname** parameter is specified with the screening reference name parameter, the specified value for the **actname** parameter must be assigned to that screening reference name.

The value of the **actname** parameter must be defined in the gateway screening stop action table with the **chg-gws-actset** command. These values are shown in the ACT NAME field of the **rtrv-gws-actset** command output.

If the **sr** parameters are specified, the SIO screening reference must be in the allowed SIO entity set.

The Gateway Screening Stop Action table must be accessible.

Invalid **ent-scr-sio nsfi** and **si** parameter combinations specified.

### Notes

An asterisk as a parameter value in this command displays only entries that have an asterisk as the same parameter value in the entry.

If no parameters are specified, a list of allowed SIO references is output indicating whether they are referenced or not.

If only the **all** parameter is specified and is **yes**, detailed information for every rule in every allowed SIO screening table is displayed.

If the **all** parameter is specified and other parameters are also specified, the **all** parameter is ignored.

Output

**rtrv-scr-sio**

```
SCREEN = ALLOWED SIO
SR   REF  RULES
s    NO   1
s999 NO   1
si   NO   1
si01 NO   1
si1  NO   1
siol NO   3
swl1 NO   1
swl2 NO   1
```

;

**rtrv-scr-sio:sr=iec:nic=1:si=3:pri=2&&3**

```
rlghncxa03w 03-03-15 08:36:43 EST  EAGLE 31.3.0
SCREEN = ALLOWED SIO
SR   NIC PRI  SI  H0  H1  NSFI  NSR/ACT
IEC  1  0&&2  3  --  --  BLKDPC WDB2
IEC  1  3    3  --  --  DPC   ABC2
```

;

**rtrv-scr-**

**sio:sr=sio1:nic=1:si=1:h1=1:pri=1:h0=15:nsfi=blkdpc:nsr=bdp1**

```
rlghncxa03w 03-03-07 12:05:33 EST  EAGLE 31.3.0
SCREEN = ALLOWED SIO
SR   NIC PRI  SI  H0  H1  NSFI  NSR/ACT
sio1 1  1  1  15  01  BLKDPC bdp1
```

;

**rtrv-scr-sio:sr=sio1:h0=1:h1=1**

```
rlghncxa03w 03-03-07 12:05:33 EST  EAGLE 31.3.0
SCREEN = ALLOWED SIO
SR   NIC PRI  SI  H0  H1  NSFI  NSR/ACT
sio1 1  1  1  01  *  STOP  -----
sio1 2  1  1  01  *  STOP  -----
```

;

**rtrv-scr-sio:sr=sio1:nic=1:si=1**

```
rlghncxa03w 03-03-07 12:05:33 EST  EAGLE 31.3.0
SCREEN = ALLOWED SIO
SR   NIC PRI  SI  H0  H1  NSFI  NSR/ACT
sio1 1  1  1  01  *  STOP  -----
sio1 1  1  1  02  01  STOP  -----
```

;

**rtrv-scr-sio:sr=sio1:nic=1:si=1:h0=1:h1=\***

```
rlghncxa03w 03-03-07 12:05:33 EST  EAGLE 31.3.0
SCREEN = ALLOWED SIO
SR   NIC PRI  SI  H0  H1  NSFI  NSR/ACT
sio1 1  1  1  01  *  STOP  -----
```

;

**rtrv-scr-sio:sr=iec:nic=1:si=1:actname=crncf**

```
rlghncxa03w 03-03-19 21:16:37 EST  EAGLE 31.3.0
SCREEN = ALLOWED SIO
SR   NIC PRI  SI  H0  H1  NSFI  NSR/ACT
iec  1  1  1  15  01  STOP  CRNCF
```

;

```

rtrv-scr-sio:si=5
tekelecstp 02-08-28 16:47:06 EST EAGLE 30.0.0
SCREEN = ALLOWED SIO
SR  NIC  PRI  SI  H0  H1  NSFI  NSR/ACT
si01 1    1    5  --  --  STOP  -----
si02 1    1    5  --  --  ISUP  is01

```

;

**Legend**

For a summary report:

**SR**—This is used to identify the various screen sets being used. It can be up to four characters in length.

**REF**—This indicates whether a screen is referenced by another screen. If **NO**, the screen is not used. If you need a more detailed output, use the **rtrv-scr-sio:all=yes** command, or specify the specific screening reference.

**RULES**—The number of screening rules in that screening table.

For a detailed report:

**SCREEN = ALLOWED SIO**—This is the screen type.

**SR**—This is used to identify the various screen sets being used. It can be up to four characters in length.

**NIC**—The network indicator code in the service information octet.

**PRI**—The priority of a single message or the beginning message priority in a range of priorities in the service information octet.

**SI**—The service indicator for the service information octet, which are the last two bits of the subservice field.

**H0**—The H0 heading code.

**H1**—The H1 heading code.

**NSFI**—The next screening category to be used.

**NSR/ACT**—The name of the next screening reference (**NSR** - up to four characters) or action to be taken (**ACT** - up to six characters), if the message passes this screen.

**rtrv-scr-tt****Retrieve Allowed Translation Type**

Use this command to show the allowed translation type (TT) screening reference in the TT entity set.

**Keyword:** rtrv-scr-tt

**Related Commands:** chg-scr-tt, dlt-scr-tt, ent-scr-tt

**Command Class:** Database Administration

**Parameters**

**:actname=** (optional)

The name of the gateway screening stop action set. Stop actions must be administered using the **actname** parameter in conjunction with the gateway screening stop action table (see **chg-gws-actset** and **rtrv-gws-actset**).

**Range:** ayyyyy  
1 alphabetic character followed by up to 5 alphanumeric characters.

**none**—Display only those gateway screening rules that do not have a gateway screening stop action set assigned to them

**:all=** (optional)

Displays all allowed TT screening references.

**Range:** **yes, no**

**Default:** **no**

**:nsfi=** (optional)

This parameter specifies the next screening category that is used in the gateway screening process, or it indicates that the gateway screening process should stop.

**Range:** **cdpa, stop**

**cdpa**—Allowed called party address is the next screening category.

**stop**—The gateway screening process ends and the message proceeds through normal routing.

**Default:** Display all screening references

**:nsr=** (optional)

The next screening reference parameter indicates which screening reference in the specified screening category (**nsfi**) is to be used in the screening process. This parameter is mandatory if **nsfi** is other than **stop**. The **nsr** parameter cannot be entered if **nsfi** is **stop**, or the **copy=yes** parameter is specified.

**Range:** *ayyy*

1 alphabetic character followed by up to 3 alphanumeric characters

**Default:** Display all

**:sr=** (optional)

The TT screening reference name

**Range:** *ayyy*

1 alphabetic character followed by up to 3 alphanumeric characters

**Default:** Display all

**:type=** (optional)

The translation type. The translation type identifies the global title translation type value in the called party address. It is the decimal representation of the 1-byte field used in SS7. A single value or a range of values can be specified.

**Range:** **1-255 \***

**Default:** Display all.

### Example

```
rtrv-scr-tt
```

```
rtrv-scr-tt:sr=iec
```

```
rtrv-scr-tt:all=yes
```

```
rtrv-scr-tt:sr=iec:type=1&&15:actname=copy
```

### Dependencies

If the **nsr** parameter is specified, **nsfi=stop** cannot be specified.

If the **actname** parameter is specified and **nsfi** is specified, the value specified for **nsfi** must be **stop**.

The value of the **actname** parameter must be defined in the gateway screening stop action table with the **chg-gws-actset** command. These values are shown in the ACT NAME field of the **rtrv-gws-actset** command output.

The **nsr** parameter cannot be specified if the **actname** parameter is specified.

If the **actname** parameter is specified with the screening reference name parameter, the specified value for the **actname** parameter must be assigned to that screening reference name.

The **copy** parameter is obsolete. Stop actions must be administered using the **actname** parameter in conjunction with the gateway screening stop action table (see **chg-gws-actset** and **rtrv-gws-actset**).

The specified value for the **nsfi** parameter is not valid for TT screen.

The **actname** parameter value must already be defined in the Gateway Screening Stop Action table with the **chg-gws-actset** command. These values are shown in the ACT NAME field of the **rtrv-gws-actset** command output.

The screening reference and translation type for which the attributes are to be retrieved must exist.

## Notes

An asterisk as a parameter value in this command displays only entries that have an asterisk as the same parameter value in the entry.

If no parameters are specified, a list of allowed TT references is produced indicating whether they are referenced or not.

If only the **all** parameter is specified and is **yes**, detailed information for every rule in every allowed TT screening table is displayed.

If the **all** parameter is specified and other parameters are also specified, the **all** parameter is ignored.

**Output**

**rtrv-scr-tt**

```
rlghncxa03w 03-03-07 12:05:33 EST EAGLE 31.3.0
SCREEN = ALLOWED TT
SR   REF  RULES
IEC  YES  2
WRD2 YES  1
WRD4 YES  4
```

;

**rtrv-scr-tt:sr=iec**

```
rlghncxa03w 03-03-07 12:05:33 EST EAGLE 31.3.0
SCREEN = ALLOWED TT
SR   TYPE  NSFI  NSR/ACT
IEC  005&&010 STOP  -----
IEC  012    STOP  -----
IEC  016    CDPA  IEC
```

;

**rtrv-scr-tt:all=yes**

```
rlghncxa03w 03-03-07 12:05:33 EST EAGLE 31.3.0
SCREEN = ALLOWED TT
SR   TYPE  NSFI  NSR/ACT
IEC  005&&010 STOP  -----
IEC  012    STOP  -----
IEC  016    CDPA  IEC
WRD2 243    STOP  -----
WRD4 *      STOP  -----
```

;

**rtrv-scr-tt:sr=iec:type=1&&15:actname=copy**

```
rlghncxa03w 03-03-15 08:54:35 EST EAGLE 31.3.0
SCREEN = ALLOWED TT
SR   TYPE  NSFI  NSR/ACT
IEC  005&&010 STOP  COPY
IEC  012    STOP  COPY
```

;

**Legend**

**SCREEN = ALLOWED TT**—This is the screen type.

**SR**—This is used to identify the various screen sets being used. It can be up to four characters in length.

**REF**—This indicates whether a screen is referenced by another screen. If NO, the screen is not used. If a more detailed output is needed, the **rtrv-scr-tt:all=yes** command should be used, or specify the specific screening reference.

**TYPE**—The translation type of that is allowed for global title translation.

**NSFI**—The next screening category to be used.

**NSR/ACT**—The name of the next screening reference (NSR - up to four characters) or action to be taken (ACT - up to six characters), if the message passes this screen.

**rtrv-scrset**

**Retrieve Screen Set**

Use this command to show the attributes of one or more screen sets in the screen set entity set.

**Keyword:** rtrv-scrset

**Related Commands:** chg-scrset, dlt-scrset, ent-scrset

**Command Class:** Database Administration

## Parameters

**:actname=** (optional)

The name of the gateway screening stop action set. Stop actions must be administered using the **actname** parameter in conjunction with the gateway screening stop action table (see **chg-gws-actset** and **rtrv-gws-actset**).

**Range:** ayyyyy

1 alphabetic character followed by up to 5 alphanumeric characters.

**none**—Display only those gateway screening rules that do not have a gateway screening stop action set assigned to them

**:all=** (optional)

Displays all screen sets (except “placeholder” screen sets that contain only one rule with **nsfi=stop** specified in the rule).

**Range:** yes, no

**Default:** no

**:destfld=** (optional)

This parameter displays the indicator that specifies whether to apply the automatic allowed affected destination screening for network management messages against the routing table, self point codes, and capability point codes. When this parameter is on in the screen set rule, the automatic screening is applied at the end of the provisioned screen set.

**Range:** yes, no

**Default:** Display all

**:nsfi=** (optional)

The values of this parameter indicate in the screen set rules the next screening category that is used in the gateway screening process, or that the gateway screening process should stop. In this command, information is displayed for one or more screen sets containing rules with the specified **nsfi** parameter value.

**NOTE: When nsfi=stop is specified for this command, the command displays only the “placeholder” screen sets that have only one rule, with nsfi=stop specified in the rule. This is a way to locate those “placeholder” screen sets, so that you can add or change the rules to accomplish appropriate screening.**

**Range:** opc, blkopc, sio, dpc, blkdpc, stop

**opc**—Display rules with Allowed OPC as the next screening category.

**blkopc**—Display rules with Blocked OPC as the next screening category.

**sio**—Display rules with Allowed SIO as the next screening category.

**dpc**—Display rules with Allowed DPC as the next screening category.

**blkdpc**—Display rules with Blocked DPC as the next screening category.

**stop**—Display only “placeholder” screen sets that have only one rule in the screen set, with **nsfi=stop** specified as the next screening category.

**Default:** Display all

**:nsr=** (optional)

The next screening reference parameter indicates which screening reference in the specified screening category (**nsfi**) is to be used in the screening process. In this command, the **nsr** parameter is used to display information for one or more screen sets with rules that have the specified **nsr** parameter value.

**Range:** ayyy

1 alphabetic character followed by up to 3 alphanumeric characters



**Default:** Display all

**:scrn=** (optional)

The screen set name. When this parameter is specified, the information for only the specified screen set is displayed.

**Range:** *xyyy*

1 alphabetic character followed by up to 3 alphanumeric characters

**Default:** Display all

### Example

```
rtrv-scrset
rtrv-scrset:scrn=scr1
rtrv-scrset:nsr=opc4
rtrv-scrset:nsfi=dpc
rtrv-scrset:actname=copy
```

### Dependencies

The screen set name must already exist.

The **nsfi=stop** parameter must be specified before the **actname** parameter can be specified.

The **nsr** parameter cannot be specified if the **actname** parameter is specified.

If the **actname** parameter is specified with the screen set name parameter, the specified value for the **actname** parameter must be assigned to that screen set name.

If the **nsfi=stop** parameter is not specified, then the **nsr** parameter must be specified.

The **nsr** parameter cannot be entered if the **nsfi** parameter value equals **stop**.

### Notes

If no parameters are specified for the **rtrv-scrset** command, the output shows all the screen sets, the screening function identifier of the root screening table, the screening reference of the root screening table, the memory usage (percentage), the number of entries in the screen set and the overall gateway screening statistics, followed by a summary of statistics for each screen set.

For the **rtrv-scrset:all=yes** command, the output consists of every screen set and every screening reference in each screen set (except “placeholder” screen sets that have only one rule with **nsfi=stop** specified in the rule). The **all=yes** and **nsfi=stop** parameters cannot be specified in the same command.

If the **scrn**, **nsfi**, or **nsr** parameter is entered, summary information for all screens that match the specified parameters is shown.

When the % FULL is over 100%, the screen is inaccessible. A screenset over 100% capacity size will not bind correctly. A screenset can become provisioned over capacity when linking one screen reference to another causes the size to become too large. To reduce a screenset that is over 100% capacity, screen rules must be deleted (see the **dlt-scr-xxx** commands)

**Output**

In the following example the % full is over 100% and the screen is inaccessible.

**rtrv-scrset**

```
rlghncxa03w 03-03-14 16:37:05 EST EAGLE 31.3.0
ENTIRE GWS DATABASE IS 1% FULL
CDPA + AFTPC TABLES ARE 0% FULL
SCREEN SET TABLE IS (2 OF 255) 2% FULL
THERE ARE 0 SEAS SCREEN SETS USED ( prefix 00nn )
THERE ARE 2 EAGLE SCREEN SETS USED
```

THE FOLLOWING ARE OVER 80% FULL:

| SCRN | NSFI | NSR/ACT | FULL | RULES | TABLES | DESTFLD |
|------|------|---------|------|-------|--------|---------|
| scr1 | OPC  |         | 101% | 4093  | 2      | Y       |

| SCRN | NSFI | NSR/ACT | FULL | RULES | TABLES | DESTFLD |
|------|------|---------|------|-------|--------|---------|
| scr1 | OPC  | opc1    | 101% | 4093  | 2      | Y       |
| scr2 | OPC  | opc2    | 1%   | 3     | 2      | Y       |

;

**rtrv-scrset:nsfi=opc**

```
rlghncxa03w 03-03-14 16:37:54 EST EAGLE 31.3.0
SCRN NSFI NSR/ACT RULES DESTFLD
att1 OPC att1 111 Y
atx1 OPC atx1 2 Y
bam1 OPC bam1 3 Y
ctt1 OPC ctt1 1 Y
ctw1 OPC ctw 39 Y
mcil OPC mcil 3 Y
wtl1 OPC wtl1 339 Y
```

;

**rtrv-scrset:nsr=dpc3**

```
rlghncxa03w 03-03-14 16:38:28 EST EAGLE 31.3.0
SCRN NSFI NSR/ACT RULES
ss01 DPC dpc3 3
ss02 DPC dpc3 3
ss03 DPC dpc3 3
ss04 DPC dpc3 3
ss05 DPC dpc3 3
```

;

**rtrv-scrset:scrn=ss53**

```
rlghncxa03w 03-03-14 16:39:04 EST EAGLE 31.3.0
SCRN NSFI NSR/ACT RULES DESTFLD
ss53 BLKDPC bkd2 2 Y
CGPA cgp1 3
TT tt1 3
TT tt2 3
TT tt3 4
CDPA cdp1 3
CDPA cdp2 3
CDPA cdp3 4
AFTPC end1 9
```

;

**rtrv-scrset:scrn=gws1**

```
e1070402 02-07-22 10:06:09 EST EAGLE 30.0.0
rtrv-scrset:scrn=gws1
Command entered at terminal #4.
SCRN NSFI NSR/ACT RULES DESTFLD
```

|      |        |      |      |   |
|------|--------|------|------|---|
| gws1 | OPC    | opc1 | 17   | Y |
|      | BLKOPC | bop1 | 1812 |   |
|      | SIO    | sio1 | 80   |   |
|      | DPC    | dpc1 | 17   |   |
|      | BLKDPC | bdp1 | 1812 |   |
|      | CGPA   | cga1 | 34   |   |
|      | TT     | tt01 | 256  |   |
|      | CDPA   | cda1 | 17   |   |
|      | CDPA   | cdb1 | 6    |   |
|      | AFTPC  | apc1 | 17   |   |
|      | ISUP   | isu1 | 17   |   |

i

**Legend**

**SCRN**—The name of the screen set.

**NSFI**—The next screening category to be used.

**NSR/ACT**—The name of the next screening reference (NSR - up to four characters) or action to be taken (ACT - up to six characters), if the message passes this screen.

**FULL**—The capacity of allowed memory a given screen set occupies, expressed as a percentage.

**RULES**—The number of entries in the screen set.

**TABLES**—The number of tables in the screen set.

**DESTFLD**—Displays whether to apply the automatic allowed affected destination screening for network management messages against the routing table, self point codes, and capability point codes. When this parameter is on, the automatic screening is applied at the end of the provisioned screen set.

**rtrv-seas-config**

**rtrv-seas-config**

Use this command to retrieve configuration information for the CCS Message Router (CCS MR) and the name of the EAGLE 5 ISS source node for the SEAS Over IP interface.

**Keyword:** rtrv-seas-config

**Related Commands:** chg-seas-config

**Command Class:** Database Administration

**Parameters**

**Example**

**rtrv-seas-config**

**Dependencies**

The SEAS Over IP feature must be enabled before this command can be entered.

**Output****rtrv-seas-config**

```
tekelecstp 07-01-23 18:46:01 EST EAGLE 37.5.0
SEASCLLI      AUTHMODE
-----
DEVEAGLE001  Password
```

| CONN  | TERM | IPADDR       | PORT | LOGIN   | HNAME    |
|-------|------|--------------|------|---------|----------|
| IPMR1 | 25   | 128.96.75.45 | 4010 | ccscoor | tcpipmr1 |
| IPMR2 | 33   | 128.96.75.46 | 4011 | ccscoor | tcpipmr2 |

**rtrv-secu-dflt****Display System-Wide Security-Related Defaults**

Use this command to display the current values of the various security-related parameters that have been configured with the **chg-secu-dflt** command.

**Keyword:** **rtrv-secu-dflt**

**Related Commands:** **chg-pid, chg-secu-dflt**

**Command Class:** Security Administration

**Parameters**

**:msg=** (optional)

Use this parameter to specify whether the text of the login warning message is to be displayed also.

**Range:** **yes, no**

**Default:** **no**

**Example**

```
rtrv-secu-dflt
rtrv-secu-dflt:msg=yes
```

**Dependencies**

None

**Notes**

None

**Output**

```

rtrv-secu-dflt:msg=yes
rlghncxa03w 08-03-17 16:02:05 EST EAGLE 38.0.0
-----
PAGE                60
UOUT                90
MULTLOG            NO
MINLEN              8
ALPHA               1
NUM                 1
PUNC                1
WARNING MESSAGE
-----
1:*****"
2:** NOTICE: This is a private computer system.   **
3:** Unauthorized Access or use may lead to       **
4:** prosecution.                                  **
5:** 08-03-01 Notice!!! Eagle will be upgraded between **
6:**                the hours of 2am-3am on 08-03-15. **
7:**                                                                 **
8:** Today's happy message: Go with Tekelec!!     **
9:*****"
10:" "
11:" "
12:" "
13:" "
14:" "
15:" "
16:" "
17:" "
18:" "
19:" "
20:" "
;

rtrv-secu-dflt
rlghncxa03w 03-03-17 16:02:05 EST EAGLE 31.3.0
-----
PAGE                60
UOUT                90
MULTLOG            NO
MINLEN              8
ALPHA               1
NUM                 1
PUNC                1
;

```

**Legend**

- PAGE**—The default password aging interval for newly created user IDs
- UOUT**—The number of successive days a user ID can go unused (no successful login) before the system denies login.
- MULTLOG**—Indicates whether users can be logged on to multiple terminals at the same time
- MINLEN**—The minimum password length.
- ALPHA**—The minimum number of alphabetic characters (a–z) required in a new password.
- NUM**—The minimum number of numeric characters (0–9) required in a new password.
- PUNC**—The minimum number of punctuation characters required in a new password. A punctuation character is any character that is not an alphabetic or numeric character.

**WARNING MESSAGE**—The message displayed when a user has successfully logged in.

## **rtrv-secu-trm**

### **Display Terminal Access Rights**

Use this command to display the access rights for a terminal. Only a user with system security administration authority can change a terminal's access rights. Access rights determine whether a terminal or port has command access to the system.

**Keyword:** **rtrv-secu-trm**

**Related Commands:** **chg-secu-trm**

**Command Class:** Security Administration

#### **Parameters**

**:trm=** (optional)

Specifies the port about which information will be displayed.

**Range:** **1-16**

**Default:** Display all

#### **Example**

```
rtrv-secu-trm
```

```
rtrv-secu-trm:trm=9
```

#### **Dependencies**

None

#### **Notes**

None

**Output**

The following example shows attributes of all terminals when the Command Class Management feature is off.

**rtrv-secu-trm**

```
e5oam 08-12-01 23:40:14 EST EAGLE 40.1.0
TRM LINK SA SYS PU DB DBG
1 YES *** YES YES YES YES
2 YES *** YES YES YES YES
3 YES YES YES YES YES YES
4 YES YES YES YES YES YES
5 YES YES YES YES YES YES
6 YES YES YES YES YES YES
7 NO *** NO NO NO NO
8 YES *** YES YES YES YES
9 YES *** YES YES YES YES
10 YES *** YES YES YES YES
11 YES *** YES YES YES YES
12 NO *** NO NO NO NO
13 NO *** NO NO NO NO
14 NO *** NO NO NO NO
15 NO YES NO NO NO NO
16 NO *** NO NO NO NO
```

;

The following example shows attributes of all terminals when the Command Class Management feature is on.

**rtrv-secu-trm**

```
rlghncxa03w 08-12-01 12:30:07 EST EAGLE 40.1.0
```

```
trm link sa sys pu db dbg
1 NO NO YES NO YES NO
2 NO YES NO NO NO NO
3 YES *** YES YES YES YES
4 NO NO NO NO NO NO
5 YES *** YES NO YES YES
6 NO NO NO NO NO NO
.
.
.
16 NO YES NO NO YES YES YES
```

```
trm U01 U02 U03 U04 U05 U06 U07 U08 U09 U10 U11 U12 U13 U14 U15 U16
1 NO NO YES NO YES NO YES YES NO YES NO NO NO YES NO
2 NO YES NO NO NO NO YES NO NO NO YES NO YES NO YES NO
3 YES NO YES YES YES YES YES NO NO YES NO NO YES NO YES
4 NO NO NO NO NO NO YES NO YES NO YES NO YES NO YES NO
5 YES YES YES NO YES YES YES YES YES YES NO NO NO YES NO YES
6 NO NO NO NO NO NO YES YES YES NO YES NO YES NO YES NO
.
.
.
16 NO YES NO NO YES YES YES YES YES YES YES YES NO YES NO YES
```

```
trm U17 U18 U19 U20 U21 U22 U23 U24 U25 U26 U27 U28 U29 U30 U31 U32
1 NO NO YES NO YES NO YES YES NO YES NO NO NO YES NO YES
2 NO NO NO NO NO NO YES NO YES NO YES NO YES NO YES NO
3 YES YES YES NO YES YES YES YES YES YES NO NO NO YES NO YES
4 NO NO NO NO NO NO YES YES YES NO YES NO YES NO YES NO
5 NO NO YES NO YES NO YES YES NO YES NO NO NO NO YES NO
6 NO YES NO NO NO NO YES NO NO NO YES NO YES NO YES NO
.
.
.
```

```
.
16      NO  YES NO  NO  YES YES YES YES NO  YES NO  YES NO  YES NO  YES
```

```
;
```

The following example shows attributes of terminal 9; the Command Class Management feature is off.

**rtrv-secu-trm:trm=9**

```
rlghncxa03w 08-12-01 12:30:07 EST  EAGLE 40.1.0
```

```
TRM      LINK SA  SYS  PU   DB   DBG
9        NO  NO  YES  NO   YES  NO
```

```
;
```

The following example shows attributes of terminal 9; the Command Class Management feature is on.

**rtrv-secu-trm:trm=9**

```
rlghncxa03w 08-12-01 12:30:07 EST  EAGLE 40.1.0
```

```
TRM      LINK SA  SYS  PU   DB   DBG
9        NO  NO  YES  NO   YES  NO
```

```
trm      U01 U02 U03 U04 U05 U06 U07 U08 U09 U10 U11 U12 U13 U14 U15 U16
9        NO  NO  YES NO  YES NO  YES YES YES YES NO  YES NO  YES NO  YES
```

```
trm      U17 U18 U19 U20 U21 U22 U23 U24 U25 U26 U27 U28 U29 U30 U31 U32
9        NO  NO  YES YES YES YES YES YES YES YES YES YES YES NO  YES NO  NO
```

```
;
```

### Legend

**TRM**—The ID number of the terminal whose characteristics are to be changed.

**LINK**—Shows whether the Link Maintenance class of commands is allowed for this terminal.

**SA**—Shows whether the Security Administration class of commands is allowed for this terminal.

**SYS**—Shows whether the System Maintenance class of commands is allowed for this terminal.

**PU**—Shows whether the Program Update class of commands is allowed for this terminal.

**DB**—Shows whether the Database class of commands is allowed for this terminal.

**DBG**—Shows whether the Debug class of commands is allowed for this terminal.

**\*\*\***—Denotes a Security Administration port whose port type has been configured with a value of **oap**, **none**, or **printer**. These terminal types do not allow you to enter commands.

**LNPBAS**—Shows whether the LNP BASIC class of commands is allowed for this terminal.

(Appears only if LNP is turned on.)

**U01 - U32**—Configurable command class default names. (If configured with a user-specified name, that name appears.)

## rtrv-secu-user

## Retrieve Security User

Use this command to show the security information for all users in the system.

**Keyword:** rtrv-secu-user

**Related Commands:** act-user, chg-pid, chg-user, dact-user, dlt-user, ent-user, login, logout, rept-stat-user, rtrv-user

**Command Class:** Security Administration



**Parameters**

**:uid=** (optional)

User ID

**Range:** *azzzzzzzzzzzzzzzzz*

1 alphabetic character followed by up to 15 alphanumeric characters

**Default:** Display all

**Example**

```
rtrv-secu-user : uid = rogers
```

**Dependencies**

If a user ID is specified, the user ID must exist in the UserID table.

**Notes**

Only the system administrator should have access to this command.

Passwords cannot be shown.

This command can be canceled using the **F9** function key or the **canc-cmd** command. See **canc-cmd** for more information.

**Output**

The following example shows a display when the Command Class Management feature is not enabled:

```

rtrv-secu-user
rlghncxa03w 08-12-01 09:50:17 EST EAGLE 40.1.0

user id          age page uout rev link sa  sys pu  db  dbg
eagle1longname16 750 0    0    NO  YES  YES  YES  YES  YES  YES

user id          age page uout rev link sa  sys pu  db  dbg
manny           36  60   60   NO  YES  YES  YES  YES  YES  YES

user id          age page uout rev link sa  sys pu  db  dbg
moe             100 30   60   YES YES  YES  YES  YES  YES  YES

user id          age page uout rev link sa  sys pu  db  dbg
jack            10  30   30   NO  YES  YES  YES  YES  YES  YES
;
    
```

The following example shows a display when the Command Class Management feature is enabled:

```

rtrv-secu-user
rlghncxa03w 08-12-01 09:50:17 EST EAGLE 40.1.0

user id          age page uout rev link sa  sys pu  db  dbg
eagle1longname16 750 0    0    NO  YES  YES  YES  YES  YES  YES

                u01 u02 u03 u04 u05 u06 u07 u08 u09 u10 u11 u12 u13 u14 u15 u16
                YES YES YES YES YES YES YES YES YES YES YES YES YES YES YES NO

                u17 u18 u19 u20 u21 u22 u23 u24 u25 u26 u27 u28 u29 u30 u31 u32
                YES YES YES YES YES YES YES YES YES YES YES NO  NO  NO  NO  YES

user id          age page uout rev link sa  sys pu  db  dbg
manny           36  60   60   NO  YES  YES  YES  YES  YES  YES

                u01 u02 u03 u04 u05 u06 u07 u08 u09 u10 u11 u12 u13 u14 u15 u16
                NO  NO  NO  NO  YES YES YES YES YES YES YES YES YES YES YES YES

                u17 u18 u19 u20 u21 u22 u23 u24 u25 u26 u27 u28 u29 u30 u31 u32
                YES YES YES YES YES YES YES YES YES YES YES NO  NO  NO  NO  YES

user id          age page uout rev link sa  sys pu  db  dbg
moe             100 30   60   YES YES  YES  YES  YES  YES  YES

                u01 u02 u03 u04 u05 u06 u07 u08 u09 u10 u11 u12 u13 u14 u15 u16
                YES YES YES YES YES YES YES YES YES YES YES YES YES YES YES NO

                u17 u18 u19 u20 u21 u22 u23 u24 u25 u26 u27 u28 u29 u30 u31 u32
                YES YES YES YES YES YES YES YES YES YES YES YES YES NO  NO  NO

user id          age page uout rev link sa  sys pu  db  dbg
jack            10  30   30   NO  YES  YES  YES  YES  YES  YES
    
```

```

u01 u02 u03 u04 u05 u06 u07 u08 u09 u10 u11 u12 u13 u14 u15 u16
YES YES YES YES YES YES YES YES YES YES YES YES YES YES YES
u17 u18 u19 u20 u21 u22 u23 u24 u25 u26 u27 u28 u29 u30 u31 u32
YES YES YES YES YES YES NO NO NO NO YES YES YES YES YES NO

```

;

**Legend**

**USER-ID**—The name of the user

**AGE**—Shows the current age, in days, of the password associated with this user ID. If the password age is greater than 999 days, the value **999** is displayed.

**PAGE**—Shows the maximum password age established for this user ID. When AGE becomes greater than PAGE, the system forces the user to change the password at the next login. An asterisk (\*) displayed after the value indicates that the system-wide default page parameter value, as configured on the **chg-secu-dflt** command, is in effect for the user ID.

**UOUT**—Shows the user ID aging interval, in days. If the user ID is not used (that is, no successful login) for longer than this interval, the system does not allow a login. An asterisk (\*) displayed after the value indicates that the system-wide default **uout** parameter value, as configured on the **chg-secu-dflt** command, is in effect for the user ID.

**REV**—Shows whether the user ID is denied login (revoked). YES indicates that the user ID is revoked, NO indicates that the user ID is not revoked.

**LINK** —Shows whether the user has access to all commands in the Link Maintenance command class.

**SA** —Shows whether the user has access to all commands in the Security Administration command class.

**SYS** —Shows whether the user has access to all commands in the System Maintenance command class.

**PU**—Shows whether the user has access to all commands in the Program Update command class.

**DB** —Shows whether the user has access to all commands in the Database Administration command class.

**DBG**—Shows whether the user has access to all commands in the Debug command class.

If the Command Class Management feature is enabled, the following fields appear:

**U01 - U32**—Default configurable command class names. If user-defined names have been provisioned, they will appear instead of the default names.

If the LNP feature is turned on, the following field is displayed:

**LNPBAS**—Shows whether the user has access to all commands in the LNP Basic command class.

**rtrv-seculog**

**Generate Report from Security Log Contents**

Use this command to retrieve the contents of a security log and display it to the user in the scroll area. Various reports can be produced by varying the values of the command parameters. By default, the report is generated from the log on the active fixed disk, although the **slog** parameter can be used to generate the report from the log on the standby fixed disk.

**Keyword:** rtrv-seculog

**Related Commands:**

**Command Class:** Security Administration

## Parameters

**:edate=** (optional)

End date. Use this parameter to report log entries only if they were created on or before the specified date. If the **sdate** parameter is also specified, log entries are reported only if they were created for the date period specified by the **sdate** and **edate** combination.

**Range:** **000101-991231**

(in the form *yymmdd*, where *yy* is year, *mm* is month, and *dd* is day)

The date must be specified with 6 digits. For example, enter 1/1/96 as **960101**.

**Default:** Report log entries regardless of their creation date

**:etime=** (optional)

End time. Use this parameter to report log entries only if they were created between midnight (00:00:00) and the time specified on this parameter. If the **stime** parameter is also specified, log entries are reported only if they were created in the time period specified by the **stime** and **etime** combination.

**Range:** **000000-235959**

(in the form *yymmdd*, where *yy* is year, *mm* is month, and *dd* is day)

The time must be specified with 6 digits in a 24-hour format. For example, enter 1:05:03 P.M. as **130503**.

**Default:** Report log entries regardless of their creation time

**:mode=** (optional)

Use this parameter to produce a either full log report or an abbreviated log report.

**Range:** **brief, full**

**brief**—Causes only one line of output to be generated for each log entry reported. Some information in each reported log entry is not shown.

**full**—Produces a report showing multiple lines of output for each log record that is reported. This report displays more information from each log record (including the entire command) than the **mode=brief** report.

**Default:** **brief**

**:num=** (optional)

Maximum number of records to be displayed. This parameter specifies how many records are to be displayed before the report is terminated.

**Range:** **1-50000**

**Default:** **500**—if **mode=brief** is specified

**250**—if **mode=full** is not specified

**:rectype=** (optional)

Use this parameter to specify whether you want all records in the log to be considered for reporting or only new (that is, un-uploaded) records.

**Range:** **new, both**

**new**—The report generator scans only new (that is, un-uploaded) records when generating the report. Old records are not considered for reporting, even if they match the reporting criteria.

**both**—All records in the log are considered for reporting.

**Default:** **new**

**:sdate=** (optional)

Start date. Use this parameter to report log entries only if they were created on or after the specified date. If the **edate** parameter is also specified, log entries are reported only if they were created for the date period specified by the **sdate** and **edate** combination.

**Range:** **000101-991231**

(in the form *yymmdd*, where *yy* is year, *mm* is month, and *dd* is day)

The date must be specified with 6 digits. For example, enter 1/1/96 as **960101**.

**Default:** Report log entries regardless of their creation date

**:slog=** (optional)

Source log indicator. This parameter specifies which log is to be copied to the FTA.

**Range:** **act, stb**

**act**—Specify **act** to produce the report from the log on the active MASP

**stb**—Specify **stb** to produce the report from the log on the standby MASP

**Default:** **act**

**:stime=** (optional)

Start time. Use this parameter to report log entries only if they were created between the time specified on this parameter and the end of the day (23:59:59) inclusive. If the **etime** parameter is also specified, log entries are reported only if they were created in the time period specified by the **stime** and **etime** combination.

**Range:** **000000-235959**

The time must be specified with 6 digits in a 24-hour format (*hhmmss*). For example, enter 1:05:03 p.m. as **130503**.

*hhmmss*—*hh*=hours (**00-23**), *mm*=minutes (**00-59**), *ss*=seconds (**00-59**)

**Default:** Report log entries regardless of their creation time

**:trm=** (optional)

Terminal ID. Use this parameter to report only those log entries created by the specified terminal.

**Range:** **1-16**

**Default:** Report log entries regardless of the associated terminal

**:uid=** (optional)

User ID. Use this parameter to report only those log entries created by the specified user ID. Specify **uid=seas** to report only those commands received on a SEAS terminal. Specify **uid=none** to report only those commands not associated with a user ID. For example, commands issued prior to login.

**Range:** *azzzzzzzzzzzzzzzzzzz*

1 alphabetic character followed by up to 15 alphanumeric characters

**Default:** Display all

**Example**

```
rtrv-seculog:sdate=021496:edate=021596:num=7
```

```
rtrv-
```

```
seculog:mode=full:sdate=021496:edate=021496:stime=062900:etime=063200
```

**Dependencies**

If both the **sdate** and **edate** parameters are specified, the date that is specified for the **sdate** parameter must be earlier than or equal to the date specified for the **edate** parameter.

If both the **stime** and **etime** parameters are specified, the time that is specified for the **stime** parameter must be earlier than or equal to the time specified for the **etime** parameter.

The month component of the **sdate** and **edate** parameter combination must be specified in the range **1-12**.

The day component of **sdate** and **edate** parameter combination must be specified in the range **1–31**. This value must accurately reflect the number of days in the month and year indicated. For example, **sdate=960631** is not a valid parameter value because June has only 30 days.

The second component of the **stime** and **etime** parameter combination must be specified in the range **00–59**.

The minute component of the **stime** and **etime** parameter combination must be specified in the range **00–59**.

No other security log command can be in progress when this command is entered.

## Notes

To accommodate the year 2000 and beyond, the two-digit year portion of dates is interpreted to be in the indicated century as follows:

years 95–99 = 1995 through 1999

years 00–36 = 2000 through 2036

A consequence of this is that date 000101 (Jan 1, 2000) is greater than 991231 (December 31, 1999).

If the **mode=brief** parameter is specified and the output report has a plus (+) symbol appearing at the end of the command, the plus symbol indicates that more command characters are available to be displayed. Specify the **mode=full** parameter to see these additional characters.

In the **mode=full** output report, a plus (+) symbol appearing at the end of the command indicates the command is longer than 150 characters. Note that even in the uploaded log, each record in the log has room to record only 150 characters of the entered command. If the command is longer than 150 characters, then only the first 149 characters of the command and the plus symbol (to indicate that truncation has occurred) are recorded.

Security log size is limited to 50,000 records. Data from a query that exceeds the size limit of the security log cannot be displayed.

The system checks to ensure that the day portion of any **sdate/edate** value entered is in agreement with the month and year. It issues error message E2252 if the day is found to be invalid (for example, **960631** is not a valid date). The system software and date/time hardware properly handle leap years and leap centuries. The year 2000 is a leap year.

The system uses the **sdate/edate** and **stime/etime** parameters to select log records for reporting as follows:

- If the date on which the log record was created is not in the date range specified by the **sdate/edate** parameters, the record is not reported. The default **sdate** is the date of the oldest record in the log, and the default **edate** is the current date.
- If the time of day at which the log record was created is not in the time range specified by the **stime/etime** parameters, the record is not reported. The default **stime** is 00:00:00 (midnight), and the default **etime** is 23:59:59.
- Otherwise, the log record is reported, unless it is disqualified by other parameters such as **uid** or **trm**.

As an example, if the following command is entered, records are displayed for October 10, 1996 from 2:00 p.m. until 4:00 p.m., for October 11, 1996, from 2:00 p.m. until 4:00 p.m., and for October 12, 1996, from 2:00 p.m. until 4:00 p.m.

**rtrv-seculog:sdate=961010:edate=961012:stime=140000:etime=160000**

It takes the system approximately one minute to display 500 lines of data in the scroll area. To output a complete **mode=full** report (150,000 lines maximum) takes approximately 300 minutes. For this reason, the **num** parameter defaults to either **125 (mode=full)** or **500 (mode=brief)**, to prevent an excessively long process time, unless you deliberately choose a longer report.

This command can be canceled using the **F9** function key or the **canc-cmd** command. See **canc-cmd** for more information.

The following message message appears in the scroll area if the **slog=stb** parameter is specified (either explicitly or by default) and the standby fixed disk is not available (for example, simplex mode).

```
Command Failed - unable to read security log
```

When the **rtrv-seculog** command is entered, one of the first things that the reporting function does is to examine the log overflowed and logging failure flags in the header of the specified log. Depending on the nature of the information found, one of the following notices is displayed in the output:

```
Notice: Log overflow has occurred -- report may be incomplete.  
Notice: Logging failure -- report may be incomplete.
```

**Output**

The following example shows how all records in the log created between 2/14/96 and 2/15/96 are to be displayed, up to a maximum of 9 records.

**rtrv-seculog:sdate=960214:edate=960215:num=9**

```
rlghncxa03w 96-02-14 06:32:20 EST EAGLE Release 34.0
Notice: Log overflow has occurred -- report may be incomplete.
Reporting parameters:
  sdate   = 960214
  edate   = 960215
  num     = 9
```

| uid      | trm | date   | time   | st | cmd                                  |
|----------|-----|--------|--------|----|--------------------------------------|
| NONE     | 03  | 960214 | 063000 | OK | login:uid=johnlamb                   |
| SEAS     | 15  | 960214 | 063010 | OK | CHG-SLK::LSN123-03:123456:50,RCH::S+ |
| johnlamb | 03  | 960214 | 063021 | OK | rept-stat-trbl                       |
| SEAS     | 15  | 960214 | 063032 | OK | CHG-RTE::LSNABC-001001001:123456:55+ |
| johnlamb | 05  | 960215 | 064524 | RJ | ent-crad:loc=1201:type=limds0:appl=+ |
| johnlamb | 05  | 960215 | 064528 | OK | ent-card:loc=1201:type=limds0:appl=+ |
| johnlamb | 03  | 960215 | 063030 | AB | rept-stat-card                       |
| johnlamb | 03  | 960215 | 063031 | OK | canc-cmd                             |
| johnlamb | 05  | 960215 | 064533 | OK | logout                               |

```
Report terminated -- output length limitation (NUM=) reached.
9 records reported of 5613 records scanned.
END OF SECURITY LOG REPORT.
```

;

The following example shows that all records in the log created between 2/14/96 and 2/15/96 between the hours of 06:29:00 and 06:32:00 are to be displayed.

**rtrv-****seculog:mode=full:sdate=960214:edate=960214:stime=062900:etime=063200**

```
rlghncxa03w 96-02-14 06:32:20 EST EAGLE Release 34.0
Reporting parameters:
  sdate   = 960214
  edate   = 960214
  stime   = 062900
  etime   = 063200
```

| uid                  | trm | date   | time   | result |
|----------------------|-----|--------|--------|--------|
| NONE                 | 05  | 960214 | 062912 | E1234  |
| Cmd: login:uid=eagle |     |        |        |        |
| johnlamb             | 03  | 960214 | 063000 | OK     |
| Cmd: rept-stat-card  |     |        |        |        |
| SEAS                 | 16  | 960214 | 063123 | OK     |

```
Cmd: CHG-
SLK::LSN12345-12:123456:50,RCH::OOS:::D,PRV123456-106-12,96-02-14-06-31-22;
Johnlamb 03 960214 063128 OK
Cmd: chg-lnp-lrn:lrn=1234567890:nmrgt1=255-255-255-255-255-dpcssn-ssn-255-
yes:nmrgt2=255-255-255-255-dpcssn-ssn-255-yes:nmrgt3=255-255-255-255-255-
dpcssn+
```

```
3 records reported of 50000 records scanned.
END OF SECURITY LOG REPORT.
```

;



The following example shows a maximum of 10 records (SEAS commands) in the log when the SEAS Over IP feature is turned on and SEAS commands are issued through the SEAS terminals.

```
rtrv-seculog:uid=seas:num=10
tekelecstp 07-03-09 11:57:50 IST EAGLE 37.5.0
Reporting parameters:
  uid      = seas
  num      = 10

uid          trm date   time    st cmd
-----
SEAS         17 070902 124846 RJ ASGN-SLK::LS111-00:AJP6OD:50,SOM::1+
SEAS         17 070902 124856 OK ASGN-SLK::LS111-02:AJP6OD:50,SOM::1+
SEAS         17 070902 124944 OK ASGN-SLK::LS111-03:AJP6OD:50,SOM::1+
SEAS         17 070902 125238 OK ASGN-SLK::LS111-11:AJP6OD:50,SOM::1+
SEAS         17 070902 125245 OK ASGN-SLK::LS111-05:AJP6OD:50,SOM::1+
SEAS         17 070902 125257 OK ASGN-SLK::LS111-13:AJP6OD:50,SOM::1+
SEAS         17 070902 130331 OK ASGN-SLK::LS111-02:AJP6OD:50,SOM::1+
SEAS         17 070902 130539 OK ASGN-SLK::LS111-02:AJP6OD:50,SOM::1+
SEAS         25 070902 131327 OK ASGN-SLK::LS111-03:AJP6OD:50,SOM::1+
SEAS         25 070902 184758 OK ASGN-SLK::LS111-02:AJP6OD:50,SOM::1+

Report terminated -- output length limitation (NUM=) reached

10 records reported of 240 records scanned.
END OF SECURITY LOG REPORT.
```

**Legend**

**UID**—The user ID that issued the command. The value **SEAS** appears if the command was received on a SEAS port. The value **NONE** appears if no user ID was associated with the port at the time the command was logged.

**TRM**—The terminal ID of the terminal where the command was received.

**DATE**—The date when the log entry was made; that is, the date on which the command was received for execution.

**TIME**—The time when the log entry was made; that is, the time the command was received for execution. A 24-hour time format is used (for example, 1:00 p.m. = 130000).

**ST**—The two-letter shorthand notation of the command’s status. The complete status can be obtained by re-entering the **rtrv-seculog** command and specifying the **mode=full** parameter. The status abbreviations are as follows:

- **AB**—Command aborted. Displayed when the **canc-cmd:trm** command is issued to abort the following commands: **rept-stat-card**, **rept-stat-dstn**, **rept-stat-ls**, **rept-stat-slk**, **rtrv-dstn**, **rtrv-gta**, **rtrv-gtt**, **rtrv-ls**, **rtrv-map**, **rtrv-rte**, **rtrv-seculog**, and **rtrv-slk**. An AB status indicates that processing and output of the command have been halted. This status is also displayed for SEAS flow-thru commands that are canceled with the **canc-cmd** (without the **trm** parameter).

- **RJ**—Command rejected. Displayed whenever the results value that would be displayed in the **mode=full** report would be one of the following:

```
Edddd
FAILED
rrrrr/mmmmm
```

- **RL**—Retry later. The system is busy.
- **IP**—In Progress

- **OK**—Command successfully executed
- **TO**—Timed out.

**CMD**—The command that was recorded. In the **mode=brief** report, if the length of the recorded command is greater than or equal to 35 characters (as this much as can be displayed on a single line of the output report), then only the first 34 characters of the command are displayed, and the 35th character is displayed as a plus symbol (+) to indicate that more information is available in the log. Re-enter the **rtrv-seculog** command with the **mode=full** parameter to see the additional information. In the **mode=full** report, a plus symbol at the end of a command indicates that the command is longer than 150 characters.

## rtrv-serial-num

## Retrieve Serial Number

Use this command to retrieve the NT serial number for the system.

**Keyword:** rtrv-serial-num

**Related Commands:** ent-serial-num

**Command Class:** Database Administration

### Parameters

This command has no parameters.

### Example

```
rtrv-serial-num
```

### Dependencies

None

### Notes

None

### Output

Dashes appear if the serial number has not yet been entered into the database.

```
rtrv-serial-num
rlghncxa03w 03-03-29 16:40:40 EST  EAGLE 31.3.0
System serial number = nt00001231

System serial number is locked.

rlghncxa03w 03-03-29 16:40:40 EST  EAGLE 31.3.0
Command Completed
;
```

## rtrv-sg-opts

## Retrieve IP7 Secure Gateway Options

Use this command to retrieve information about the currently chosen IP<sup>7</sup> Secure Gateway protocol options.

**Keyword:** rtrv-sg-opts

**Related Commands:** chg-sg-opts, rtrv-appl-rtkey

**Command Class:** Database Administration

**Parameters**

This command has no parameters.

**Example**

```
rtrv-sg-opts
```

**Dependencies**

None

**Notes**

None

**Output**

```
rtrv-sg-opts
rlghncxa03w 08-02-07 09:50:17 EST EAGLE 38.0.0
SRKQ:                250
SNMPCONT:            john doe 555-123-4567
GETCOMM:             public
SETCOMM:             private
TRAPCOMM:            public
SCTPCSUM:            adler32
IPGWABATE:           NO
UAMEASUSEDFTAS:     YES
;
```

**Legend**

**SRKQ**—The static routing key quantity. The maximum number of routing key entries in the Static Routing Key table.

**SNMPCONT**—The system contact information for each SSED CM SNMP agent.

**GETCOMM**—The community name used for messages sent by SS7IPGW cards (SNMP Get and GetNext request validations).

**SETCOMM**—The community name used for SNMP set request validation. This value applies for each SSED CM SNMP agent in the system.

**TRAPCOMM**—The community name used when SNMP traps are generated. This value applies for each SSED CM SNMP agent in the system.

**SCTPCSUM**—The SCTP checksum algorithm type.

**IPGWABATE**—The IPGWx SS7 congestion abatement procedures.

**UAMEASUSEDFTAS**—The UA measurements are generated.

**rtrv-shlf****Retrieve Shelf**

Use this command to display the frames and shelves that are currently provisioned in the system. The type of shelf is also shown.

**Keyword:** rtrv-shlf

**Related Commands:** dlt-shlf, ent-shlf

**Command Class:** Database Administration

**Parameters**

**:loc=** (optional)

The shelf location.

**Range:** 1100, 1200, 1300, 2100, 2200, 2300, 3100, 3200, 3300, 4100, 4200, 4300, 5100, 5200, 5300, 6100

**Default:** Display all configured locations

### Example

```
rtrv-shlf
rtrv-shlf:loc=1300
rtrv-shlf:loc=2100
```

### Dependencies

The frame and shelf values of the shelf location parameter (**loc**) must be within the valid range (xyzz, where x=frame and y=shelf; zz is always 00 for this command).

### Notes

None

**Output**

The following example displays all configured STP equipment shelves.

```
rtrv-shlf
rlghncxa03w 04-01-07 09:50:17 EST EAGLE 31.3.0
SHELF DISPLAY
FRAME SHELF      TYPE
  1      1      CONTROL
  1      2      EXTENSION
  1      3      EXTENSION
  2      3      EXTENSION
;
```

The following example displays a specific STP equipment shelf.

```
rtrv-shlf:loc=1300
rlghncxa03w 04-01-07 09:50:17 EST EAGLE 31.3.0
SHELF DISPLAY LOCATION=1300
FRAME SHELF      TYPE
  1      3      EXTENSION
CARD  TYPE      APPL      LSET NAME      PORT SLC LSET NAME      PORT SLC
1301  LIMDS0    SS7ANSI  -----      --  --  -----      --  --
1302  LIMDS0    SS7ANSI  -----      --  --  -----      --  --
1303  LIMDS0    SS7ANSI  -----      --  --  -----      --  --
1304  LIMDS0    SS7ANSI  -----      --  --  -----      --  --
1305  LIMDS0    SS7ANSI  -----      --  --  -----      --  --
;
```

The following example displays a specific STP equipment shelf that is not configured (unequipped).

```
rtrv-shlf:loc=2100
rlghncxa03w 04-01-07 09:50:17 EST EAGLE 31.3.0
SHELF DISPLAY LOCATION=2100
FRAME SHELF      TYPE

This shelf is UNEQUIPPED in the database.
;
```

**Legend**

- FRAME**—The frame location of the shelf.
- SHELF** —The location of the shelf within the frame.
- TYPE** —The type of shelf.
- CARD**—Card location in the specified shelf.
- TYPE**—Card type
- APPL**—Application running on the card.
- LSET NAME**—Linkset name defined for the port on the card.
- PORT**—Port used by the linkset defined on the card.
- SLC**—Signaling link code for the linkset.

**rtrv-sid**

**Retrieve Self Identification**

Use this command to retrieve site identification characteristics of the system. It shows the point code assigned to this system, the CLI code of the system, the capability code of the STP, and the type of point codes supported by the system.

**Keyword:** rtrv-sid

**Related Commands:** chg-sid, ent-sid

**Command Class:** Security Administration

### Parameters

**NOTE:** See "Point Code Formats and Conversion" for a detailed description of point code formats, rules for specification, and examples.

**:cpc=** (optional)

ANSI capability point code in the form of *network indicator-network cluster-network cluster member (ni-nc-ncm)*.

**Synonym:** cpc

**Range:** 000-255

Specify a valid value for each subfield of the point code, and separate the subfields with a dash (-).

When **chg-sid:pctype=ansi** is specified, *ni = 000* is not valid.

When **chg-sid:pctype=ansi** is specified, *nc = 000* is not valid if *ni = 001-005*.

When **chg-sid:pctype=ansi** is specified, *nc = 000* is valid if *ni = 006-255*.

The point code **000-000-000** is not a valid point code.

**Default:** Display all

**:cpc/cpc/cpci/cpcn/cpcn24=** (optional)

Capability point code. The code used by the SS7 protocol to identify a group of functionally related STPs in the signaling network to which the STP belongs.

**:cpci=** (optional)

ITU international point code with subfields *zone-area-id*. The *prefix* subfield indicates a spare point code (*prefix-zone-area-id*).

**Range:** s-, 0-255

Specify a valid value for each subfield of the point code, and separate the subfields with a dash (-).

*prefix*—s-

*zone*—0-7

*area*—000-255

*id*—0-7

The point code **0-000-0** is not a valid point code.

**Default:** Display all

**:cpcn=** (optional)

ITU national point code in the format of a 5-digit number (*nnnnn*); or 2, 3, or 4 numbers (members) separated by dashes (*m1-m2-m3-m4*) as defined by the **chg-stpopts:npcfmti** flexible point code option. A group code must be specified when the ITUDUPPC feature is turned on (*nnnnn-gc*, *m1-m2-m3-m4-gc*). The *prefix* subfield indicates a spare point code (*prefix-nnnnn*, *prefix-nnnnn-gc*, *prefix-m1-m2-m3-m4*, *prefix-m1-m2-m3-m4-gc*).

**Range:** s-, 0-16383, aa-zz

Specify a valid value for each subfield of the point code, and separate the subfields with a dash (-).

*prefix*—s-

*nnnnn*—0-16383

*gc*—**aa-zz**

*m1-m2-m3-m4*—**0-14** for each member; values must sum to 14

**Default:** Display all

**:cpcn24=** (optional)

24-bit ITU national point code with subfields *main signaling area-sub signaling area-signaling point (msa-ssa-sp)*.

**Range:** **000-255**

Specify a valid value for each subfield of the point code, and separate the subfields with a dash (-).

*msa*—**000-255**

*ssa*—**000-255**

*sp*—**000-255**

**Default:** Display all

**:cpctype=** (optional)

Capability point code type. This parameter displays the CPCs that are provisioned for the specified service.

**Range:** **stp, lnp, inp, eir, gport, gflex, mnp, atinpq, vflex**

**Default:** **stp**

### Example

```
rtrv-sid
rtrv-sid:cpc=3-3-3
rtrv-sid:cpcn24=001-001-001
rtrv-sid:cpctype=inp
rtrv-sid:cpci=2-100-4
rtrv-sid:cpcn24=33-33-33
rtrv-sid:cpcn=s-00456
```

### Dependencies

The STP destination point codes and capability point codes can be specified only as full point codes.

The ANSI point code **0-0-0** and the ITU-I point code **0-000-0** are invalid for STP capability point codes.

The LNP feature must be turned on before the **cpctype=lnp** parameter can be specified.

The INP feature must be turned on before the **cpctype=inp** parameter can be specified.

The EIR feature must be turned on before the **cpctype=eir** parameter can be specified.

The Spare Point Code Support feature must be enabled before an ITU-I or ITU-N spare point code can be retrieved.

If the **cpcn** parameter is specified, the format of the specified point code must match the format that was assigned with the **chg-stpopts** command **npcfnti** parameter.

The ATINP feature must be enabled before the **cpctype=atinpq** parameter can be specified.

The V-Flex feature must be turned on before the **cpctype=vflex** parameter can be specified.

The A-Port or the IS41 GSM Migration (IGM) feature must be enabled, before the **cpctype=mnp** parameter can be specified.

**Notes**

If the **cpc/cpca/cpci/cpcn/cpcn24** parameter is not specified, all site identification characteristics are displayed.

If the STP capability point code is specified and not provisioned, the report contains only the PCA, PCI, PCN or PCN24, CLLI, and PCTYPE fields, with the message:

Compatibility Point Code specified is not provisioned.

In this command, only ITU-international and ITU national point codes support the spare point code subtype prefix (s-).



**Output**

The **rtrv-sid** command CPC output is sorted using three sort keys.

- The first sort key is by the **cpctype** service, ordered by: **stp** (own STP, unlabeled), **inp**, **eir**, **gflex**, and either **gport** or **mnp** depending on whether A-Port, ATINP, G-Port or V-Flex is enabled.
- The second sort key is by network type, ordered by: ANSI, ITU-I, ITU-N, then ITU-N24.
- The third sort key is by point code value, ordered low to high.

In the following output examples:

- When a 24-bit ITU-N site identification STP point code is configured, the PCN header is changed to PCN24.
- The **s-** point code prefix indicates an ITU national or international spare point code or spare capability point code.
- INP, LNP, EIR, G-Flex, G-Port and V-Flex capability point codes are indicated in parentheses after the capability point code header.
- STP capability point codes have no parentheses after the header.

The examples show all site identification characteristics provisioned in the system at the time the command was entered.

The following example shows all site identification characteristics provisioned in the system at the time the command was entered. The output includes spare point codes.

**rtrv-sid**

```
tekelecstp 04-06-14 15:18:11 EST EAGLE 31.12.0
PCA          PCI          PCN          CLLI          PCTYPE
005-067-000  1-023-4      01234       tekelecstp   ANSI
              s-1-023-4    s-01234

CPCI
s-4-056-0

CPCN
s-00456
```

;

The following example shows a display of a particular STP capability point code.

**rtrv-sid:cpc=5-5-4**

```
rlghncxa03w 03-03-18 09:33:58 EST EAGLE 31.3.0
PCA          PCI          PCN          CLLI          PCTYPE
008-013-008  -----    -----    tklcstn14    OTHER

CPCA
005-005-004
```

;

The following example shows a particular LNP capability point code.

**rtrv-sid:cpc=3-3-3**

```
rlghncxa03w 03-03-10 09:33:58 EST EAGLE 31.3.0
PCA          PCI          PCN          CLLI          PCTYPE
008-013-008  -----    -----    tklcstn14    OTHER
```

```

CPCA (LNP)
003-003-003

```

```
;
```

The following example shows the message that appears when no match for the specified capability point code is found in the Site ID table.

**rtrv-sid:cpc=100-100-100**

```

rlghncxa03w 03-03-18 09:33:58 EST EAGLE 31.3.0
PCA          PCI          PCN          CLLI          PCTYPE
008-013-008  -----          -----          tklcstn14     OTHER

```

Capability Point Code specified is not provisioned.

```
;
```

The following example shows a display of a site identification STP point code with a group code (the ITUDUPPC feature must be on).

**rtrv-sid**

```

rlghncxa03w 03-03-18 09:33:58 EST EAGLE 31.3.0
PCA          PCI          PCN          CLLI          PCTYPE
008-013-008  -----          128-15-1-1-si tklcstn14     OTHER

```

```
;
```

The following example shows all provisioned INP capability point codes.

**rtrv-sid:cpctype=inp**

```

rlghncxa03w 03-03-18 09:33:58 EST EAGLE 31.3.0
PCA          PCI          PCN          CLLI          PCTYPE
-----          2-150-4          12345          tklcstn14     OTHER

```

```

CPCN (INP)
1234 34567

```

```

CPCI (INP)
3-050-2          4-100-3

```

```
;
```

The following example shows a specific 24-bit ITU-N capability point code.

**rtrv-sid:cpcn24=33-33-33**

```

rlghncxa03w 02-03-18 09:33:58 EST EAGLE 31.0.0
PCA          PCI          PCN24        CLLI          PCTYPE
001-001-001  -----          011-011-011  tekelecstp    ANSI

```

```

CPCN24
033-033-033

```

```
;
```

The following example contains capability point codes provisioned with **cpctype=gflex** and **cpctype=gport**.

**rtrv-sid**

```

tekelecstp 06-01-09 15:46:50 EST EAGLE 34.3.0
PCA          PCI          PCN          CLLI          PCTYPE
001-001-001  2-002-2          00333          tekelecstp    ANSI

```

```

CPCI (GFLEX)
2-002-3          2-002-4

```

```

CPCA (GPORT)
001-001-002          001-001-003

```

```

;
rtrv-sid
tekelecstp 04-06-14 15:18:11 EST EAGLE 31.12.0
PCA          PCI          PCN          CLLI          PCTYPE
008-013-008  -----          -----          tklcstn14     OTHER

CPCA
005-005-002          005-005-004          005-005-005

CPCA (LNP)
005-005-002          005-005-004          005-005-005
;

```

The following example retrieves a specific spare ITU-N capability point code.

```

rtrv-sid:cpcn=s-00456
rlghncxa03w 05-01-07-18 09:33:58 EST EAGLE 31.12.0
PCA          PCI          PCN          CLLI          PCTYPE
005-067-000  1-023-4          01234          tekelecstp     ANSI
              s-1-023-4          s-01234

CPCN
s-00456

CPCN (EIR)
s-123
;

```

### Legend

**PCA**—The ANSI point code of the STP.

**PCI**—The ITU-TSS international point code of the STP.

**PCN**—The ITU-TSS national point code of the STP.

**PCN24**—The 24-bit ITU national point code of the STP.

**CPCA**—The ANSI capability point code used by the SS7 protocol to identify a group of functionally related STPs in the signaling network.

**CPCN**—The ITU-TSS national capability point code used by the SS7 protocol to identify a group of functionally related STPs in the signaling network.

**CPCI**—The ITU-TSS international capability point code used by the SS7 protocol to identify a group of functionally related STPs in the signaling network.

**CPCN24**—The ITU-TSS 24-bit national capability point code used by the SS7 protocol to identify a group of functionally related STPs in the signaling network.

**(EIR)**—The identified point code is an Equipment Identity Register (EIR) point code.

**(INP)**—The identified point code is an INAP Number Portability (INP) point code.

**(LNP)**—The identified point code is a local number portability (LNP) point code.

**(GFLEX)**—The identified point code is a G-Flex (GFLEX) point code.

**(GPORT)**—The identified point code is a G-Port (GPORT) point code.

**(MNP)**—The identified point code is an MNP point code.

**(VFLEX)**—The identified point code is a V-Flex (VFLEX) point code.

**(ATINP)**—The identified point code is an ATINP feature (ATINPQ) point code.

**CLLI**—The common language location identifier of the STP

**PCTYPE**—The type of point code used by the STP. There are two types of point codes that the EAGLE 5 ISS STP can use, ANSI and OTHER. The value ANSI means the EAGLE 5 ISS STP supports point codes that meet the ANSI standard. The value OTHER means that the EAGLE 5 ISS STP supports point codes that do not meet the ANSI standard.

**rtrv-slk****Retrieve Signaling Link**

Use this command to show the parameters for low-speed signaling links, ATM high-speed signaling links, or both.

**Keyword:** rtrv-slk

**Related Commands:** act-slk, blk-slk, dact-slk, dlt-slk, ent-slk, inh-slk, rept-stat-slk, tst-slk, ublk-slk, unhb-slk

**Command Class:** Database Administration

**Parameters**

**:aname=** (optional)

Association name. This parameter specifies the name of the association assigned to the links to be displayed.

**Range:** ayyyyyyyyyyyyyy

Up to 15 alphanumeric characters; the first character must be a letter

**:link=** (optional)

The signaling link on the card specified in the **loc** parameter. The links can be specified in any sequence or pattern.

**Synonym:** port

**Range:** a, b, a1-a31, b1-b31

Not all card types support all **link** parameter values.

See Table A-1 for valid **link** parameter range values for each type of card that can have assigned signaling links.

**Default:** Display all

**:loc=** (optional)

The card location as stenciled on the shelf of the system.

**Range:** 1101-1108, 1111-1112, 1201-1208, 1211-1218, 1301-1308, 1311-1318, 2101-2108, 2111-2118, 2201-2208, 2211-2218, 2301-2308, 2311-2318, 3101-3108, 3111-3118, 3201-3208, 3211-3218, 3301-3308, 3311-3318, 4101-4108, 4111-4118, 4201-4208, 4211-4218, 4301-4308, 4311-4318, 5101-5108, 5111-5118, 5201-5208, 5211-5218, 5301-5308, 5311-5318, 6101-6108, 6111-6118

**Default:** All signaling links are shown.

**:type=** (optional)

Link type. This parameter specifies to display a sub-set of links.

**Range:** mtp2, saal, e1, t1, ipsg, iplim, ipgw

**mtp2**— Display low-speed signaling links

**saal**— Display ATM high-speed signaling links

**e1**— Display signaling links for E1 cards. Includes low speed E1 and SE-HSL links.

**t1**— Display signaling links for T1 cards. Includes low speed T1 and ST-HSL-A links.

**ipsg**— Display signaling links configured for IPSG linksets

**iplim**— Display signaling links configured for IPLIM linksets

**ipgw**— Display signaling links configured for IPGW linksets

**Default:** Display all signaling links

**Example**

```

rtrv-slk:loc=1302:link=a
rtrv-slk:loc=1302:link=b2
rtrv-slk:loc=1303:link=a31
rtrv-slk:aname=asocm2pa
rtrv-slk:loc=1305

```

**Dependencies**

If the **link** parameter is specified, the **loc** parameter must be specified. The **loc** parameter can be specified without the **link** parameter.

The **loc** parameter or the **class** parameter, but not both, can be specified in the command.

The slot portion of the specified **loc** parameter must be **01** through **18**, except **09** and **10** cannot be specified (**loc=xyss**, where *x* is the frame, *y* is the shelf, and *ss* is the slot).

Card locations **1113** through **1118** cannot be specified for the **loc** parameter.

The frame and shelf portion of the specified **loc** parameter must be **11**, **12**, **13**, **21**, **22**, **23**, **31**, **32**, **33**, **41**, **42**, **43**, **51**, **52**, **53**, or **61** (**loc=xyss**, where *x* is the frame, *y* is the shelf, and *ss* is the slot).

The **limatm**, **lime1atm**, **limds0**, **limocu**, **limv35**, **lime1**, **limt1**, **limch**, and **dcm** card types are the only valid card types for this command.

The card must be a LIM, an E1/T1 MIM, or an HC-MIM.

The specified card location must be equipped.

The following **link** parameter values can be specified for the following cards that support more than 2 links per card:

- **a1-a3, b1-b3**—Multi-port LIM (MPL), SSEDCCM card running the **iplim** or **iplimi** application with links having **ipliml2=m2pa**, E1/T1 MIM card
- **a1-a31, b1-b31**—HC-MIM card
- **a1-a15, b1-b15**—E5-E1T1 card
- **a1-a7, b1-b7**—E5-ENET card running the **iplim** or **iplimi** application that supports 16 links.
- **a1-a15, b1-b15**—E5-ENET card running the **ipsg** application

The **link** parameter values **a4-a31** and **b4-b31** can be specified only for the HC-MIM card that is used as an E1 card or a T1 card. The **link** parameter values **a4-a31** and **b4-b31** cannot be specified for Channel cards.

The **link** parameter values **a4-a31** and **b4-b31** cannot be specified for even-numbered card locations.

If the card application is **ss7gx25**, **link=a** must be specified.

The associated location must be empty, or an E5-ATM card must be provisioned in the location before the **link=b** parameter can be specified. Upon initialization, the E5-ATM card is in **boot phase-0** for up to 30 secs. During this period, the E5-ATM hardware is not detected, which may result in a lack of support for signalling link **b**.

If an E5-ATM card is used, then the value specified for the **link** parameter must be **a** or **b**.

**Notes**

This command can be canceled using the **F9** function key or the **canc-cmd** command. See **canc-cmd** for more information.

Not every card location represents a signaling link. Be sure to address a signaling link in this command.

The *Installation Manual – EAGLE 5 ISS* provides an illustration of the card locations.

Output

rtrv-slk

tekelecstp 09-07-10 13:54:32 EST EAGLE 41.1.0

rtrv-slk

Command entered at terminal #4.

| LOC  | LINK | LSN    | SLC | TYPE   | L2T SET | BPS   | ECM   | PCR N1 | PCR N2 |
|------|------|--------|-----|--------|---------|-------|-------|--------|--------|
| 1201 | A    | e3m1s1 | 0   | LIMDS0 | 1       | 56000 | BASIC | ----   | -----  |
| 1201 | B    | e3m1s2 | 0   | LIMDS0 | 1       | 56000 | BASIC | ----   | -----  |
| 1202 | A    | e3m1s1 | 1   | LIMDS0 | 1       | 56000 | BASIC | ----   | -----  |
| 1202 | B    | e3m1s2 | 1   | LIMDS0 | 1       | 56000 | BASIC | ----   | -----  |
| 1203 | A    | e3m1s1 | 2   | LIMDS0 | 1       | 56000 | BASIC | ----   | -----  |
| 1203 | B    | e3m1s2 | 2   | LIMDS0 | 1       | 56000 | BASIC | ----   | -----  |
| 1204 | A    | e3m1s1 | 3   | LIMDS0 | 1       | 56000 | BASIC | ----   | -----  |
| 1204 | B    | e3m1s2 | 3   | LIMDS0 | 1       | 56000 | BASIC | ----   | -----  |
| 1205 | A    | e3m1s1 | 4   | LIMDS0 | 1       | 56000 | BASIC | ----   | -----  |
| 1205 | B    | e3m1s2 | 4   | LIMDS0 | 1       | 56000 | BASIC | ----   | -----  |
| 1206 | A    | e3m1s1 | 5   | LIMDS0 | 1       | 56000 | BASIC | ----   | -----  |
| 1206 | B    | e3m1s2 | 5   | LIMDS0 | 1       | 56000 | BASIC | ----   | -----  |
| 1207 | A    | e3m1s1 | 6   | LIMDS0 | 1       | 56000 | BASIC | ----   | -----  |
| 1207 | B    | e3m1s2 | 6   | LIMDS0 | 1       | 56000 | BASIC | ----   | -----  |
| 1211 | A    | e3m2s1 | 0   | LIMDS0 | 11      | 56000 | BASIC | ----   | -----  |
| 1211 | B    | e3m2s2 | 0   | LIMDS0 | 11      | 56000 | BASIC | ----   | -----  |
| 1212 | A    | e3m2s1 | 1   | LIMDS0 | 11      | 56000 | BASIC | ----   | -----  |
| 1212 | B    | e3m2s2 | 1   | LIMDS0 | 11      | 56000 | BASIC | ----   | -----  |
| 1213 | A    | e3m2s1 | 2   | LIMDS0 | 11      | 56000 | BASIC | ----   | -----  |
| 1213 | B    | e3m2s2 | 2   | LIMDS0 | 11      | 56000 | BASIC | ----   | -----  |
| 1214 | A    | e3m2s1 | 3   | LIMDS0 | 11      | 56000 | BASIC | ----   | -----  |
| 1214 | B    | e3m2s2 | 3   | LIMDS0 | 11      | 56000 | BASIC | ----   | -----  |
| 1215 | A    | e3m2s1 | 4   | LIMDS0 | 11      | 56000 | BASIC | ----   | -----  |
| 1215 | B    | e3m2s2 | 4   | LIMDS0 | 11      | 56000 | BASIC | ----   | -----  |
| 1216 | A    | e3m2s1 | 5   | LIMDS0 | 11      | 56000 | BASIC | ----   | -----  |
| 1216 | B    | e3m2s2 | 5   | LIMDS0 | 11      | 56000 | BASIC | ----   | -----  |
| 1217 | A    | e3m2s1 | 6   | LIMDS0 | 11      | 56000 | BASIC | ----   | -----  |
| 1217 | B    | e3m2s2 | 6   | LIMDS0 | 11      | 56000 | BASIC | ----   | -----  |

| LOC  | LINK | LSN  | SLC | TYPE   | LP SET | BPS     | ATM TSEL | VCI | VPI | LL |
|------|------|------|-----|--------|--------|---------|----------|-----|-----|----|
| 1208 | A    | e3e4 | 4   | LIMATM | 1      | 1544000 | LINE     | 5   | 0   | 0  |
| 1218 | A    | e3e4 | 5   | LIMATM | 1      | 1544000 | LINE     | 5   | 0   | 0  |

| LOC  | LINK | LSN       | SLC | TYPE | ANAME     | SLKTPS |
|------|------|-----------|-----|------|-----------|--------|
| 1303 | A    | m2pa12132 | 0   | IPSG | m2pa1303a | 1000   |
| 1303 | B    | m3ua333a  | 0   | IPSG | m3ua1303b | 500    |
| 1303 | A1   | m3ua323a  | 0   | IPSG | m3ua1303a | 1000   |
| 1303 | B1   | m3ua333i  | 0   | IPSG | m3ua1303b | 500    |
| 1303 | B2   | m3ua333n  | 0   | IPSG | m3ua1303b | 500    |
| 1305 | A    | ls1305a   | 0   | IPSG | sg1305a   | 1000   |
| 1305 | B    | ls1305i   | 0   | IPSG | sg1305i   | 500    |
| 1305 | A1   | ls1305a   | 1   | IPSG | a1        | 1000   |
| 1305 | B1   | ls1305i   | 1   | IPSG | a1        | 500    |
| 1305 | B14  | lsitunbb  | 0   | IPSG | a1        | 1000   |
| 1305 | B15  | lsitunaa  | 0   | IPSG | a1        | 1000   |

| LOC  | LINK | LSN   | SLC | TYPE   | IPLIML2 |
|------|------|-------|-----|--------|---------|
| 1301 | A    | e3e4  | 0   | IPLIM  | M2PA    |
| 1301 | B    | e3e4  | 2   | IPLIM  | M2PA    |
| 1311 | A    | e3e4a | 0   | IPLIM  | M2PA    |
| 1313 | A    | e3e4i | 0   | IPLIMI | M2PA    |

| LOC  | LINK | LSN     | SLC | TYPE    |
|------|------|---------|-----|---------|
| 1307 | A    | ls1307a | 0   | SS7IPGW |
| 1315 | A    | ls1315a | 0   | SS7IPGW |
| 1317 | A    | ls1317i | 0   | IPGWI   |

SLK table is (48 of 1200) 4% full.

;

The following example shows output for a specific card location, which contains an SSED CM with 4 M2PA IPLIM links.

**rtrv-slk:loc=1307**

```
tekelecstp 09-04-21 08:40:18 EST EAGLE5 41.0.0
LOC LINK LSN          SLC TYPE      IPLIML2
1307 A2  lsetC        4  IPLIM      M2PA
1307 B2  lsetC        5  IPLIM      M2PA
1307 A3  lsetC        6  IPLIM      M2PA
1307 B3  lsetC        7  IPLIM      M2PA
```

;

The following example includes signaling links assigned to an HC-MIM card used as an E1 card.

**rtrv-slk:loc=1311**

```
tekelecstp 09-04-08 16:22:25 EST EAGLE5 41.0.0
LOC LINK LSN          SLC TYPE      SET  BPS   ECM  PCR  PCR   E1  E1
                                L2T                                N1  N2   LOC PORT TS
1311 A   e11311a        0  LIME1        1   56000 BASIC ---- - 1311 1  1
1311 B   e11311b        0  LIME1        1   56000 BASIC ---- - 1311 1  2
1311 A1  e11311a        1  LIME1        1   56000 BASIC ---- - 1311 1  3
1311 B1  e11311b        1  LIME1        1   56000 BASIC ---- - 1311 2  4
1311 A2  e11311a        2  LIME1        1   56000 BASIC ---- - 1311 2  5
1311 B2  e11311b        3  LIME1        1   56000 BASIC ---- - 1311 3  6
1311 B3  e11311b        2  LIME1        1   56000 BASIC ---- - 1311 3  7
1311 A4  e11311b        4  LIME1        1   56000 BASIC ---- - 1311 4  14
1311 B6  e11311a        3  LIME1        1   56000 BASIC ---- - 1311 5  13
1311 A11 e11311b        5  LIME1        1   56000 BASIC ---- - 1311 5  12
1311 B17 e11311a        4  LIME1        1   56000 BASIC ---- - 1311 6  11
1311 A29 e11311b        6  LIME1        1   56000 BASIC ---- - 1311 7  10
1311 B31 e11311a        5  LIME1        1   56000 BASIC ---- - 1311 8  9
```

;

The following example includes signaling links assigned to an HC-MIM card used as a T1 card.

**rtrv-slk:loc=1307**

```
tekelecstp 09-04-08 16:22:25 EST EAGLE5 41.0.0
LOC LINK LSN          SLC TYPE      SET  BPS   ECM  PCR  PCR   T1  T1
                                L2T                                N1  N2   LOC PORT TS
1307 A   t11307          0  LIMT1        1   56000 BASIC ---- - 1307 2  12
1307 B   t11307          1  LIMT1        1   56000 BASIC ---- - 1307 1  1
1307 B1  t11307          2  LIMT1        1   56000 BASIC ---- - 1307 1  2
1307 A2  t11307          3  LIMT1        1   56000 BASIC ---- - 1307 1  3
1307 B3  t11307          4  LIMT1        1   56000 BASIC ---- - 1307 1  4
1307 A5  t11307          5  LIMT1        1   56000 BASIC ---- - 1307 1  5
1307 B8  t11307          6  LIMT1        1   56000 BASIC ---- - 1307 1  6
1307 B11 t11307          7  LIMT1        1   56000 BASIC ---- - 1307 1  7
1307 A21 t11307          8  LIMT1        1   56000 BASIC ---- - 1307 3  16
1307 B24 t11307          9  LIMT1        1   56000 BASIC ---- - 1307 4  17
1307 A25 t11307         10  LIMT1        1   56000 BASIC ---- - 1307 6  18
1307 B25 t11307         11  LIMT1        1   56000 BASIC ---- - 1307 6  19
1307 A27 t11307         12  LIMT1        1   56000 BASIC ---- - 1307 7  20
1307 B29 t11307         13  LIMT1        1   56000 BASIC ---- - 1307 8  21
1307 A31 t11307         14  LIMT1        1   56000 BASIC ---- - 1307 2  22
1307 B31 t11307         15  LIMT1        1   56000 BASIC ---- - 1307 1  23
```

;



The following example shows the signaling link **a31** assigned to an HC-MIM card used as a T1 card.

**rtrv-slk:loc=1307:link=a31**

```
tekelecstp 09-04-08 16:22:25 EST EAGLE5 41.0.0
      L2T          PCR PCR   T1  T1
LOC  LINK LSN      SLC TYPE  SET  BPS   ECM  N1  N2   LOC  PORT TS
1307 A31 t11307   14  LIMT1   1   64000 BASIC ---- ------ 1307 2    22
```

;

The following example includes E1 signaling links assigned to HC-MIM cards. The link with BPS value 1984000 is an SE-HSL link.

**rtrv-slk**

```
tekelecstp 09-04-08 16:22:25 EST EAGLE5 41.0.0
      L2T          PCR PCR   E1  E1
LOC  LINK LSN      SLC TYPE  SET  BPS   ECM  N1  N2   LOC  PORT TS
1101 B   e11s     0  LIME1   11  56000 BASIC ---- ------ 1101 2    2
1102 A   e21s     0  LIME1   21  1.984M BASIC ---- ------ 1102 1    1
```

SLK table is (2 of 1200) 0% full.

;

The following example shows the link information for an E5-ENET card.

**rtrv-slk:loc=1303**

```
eagle10110 09-04-05 08:37:15 EST EAGLE 41.0.0
      L2T          PCR PCR
LOC  LINK LSN      SLC TYPE  IPLIML2
1303 A   e5e6     2  IPLIM   M2PA
1303 B   e5e6     6  IPLIM   M2PA
1303 A1  e5e6     1  IPLIM   M2PA
1303 B1  e5e6     9  IPLIM   M2PA
1303 B2  e5e6    10  IPLIM   M2PA
1303 A3  e5e6     3  IPLIM   M2PA
1303 B3  e5e6    11  IPLIM   M2PA
1303 A4  e5e6     4  IPLIM   M2PA
1303 B4  e5e6    12  IPLIM   M2PA
1303 A5  e5e6     5  IPLIM   M2PA
1303 B5  e5e6    13  IPLIM   M2PA
1303 B6  e5e6    14  IPLIM   M2PA
1303 A7  e5e6     7  IPLIM   M2PA
1303 B7  e5e6    15  IPLIM   M2PA
```

;

The following example shows the link information for an LIMATM card.

**rtrv-slk:loc=1304:link=a**

```
tekelecstp 09-01-14 12:17:00 EST EAGLE 41.0.0
      LP          ATM
LOC  LINK LSN      SLC TYPE  SET  BPS   TSEL  VCI  VPI  LL
1304 A   ls1     3  LIMATM   1  1544000 LINE  5    0    0
```

The following example shows the link information for an IPSP card.

**rtrv-slk:loc=1301**

```
e1001501 09-02-23 16:20:45 EST EAGLE 41.0.0
      ANAME      SLKTPS
LOC  LINK LSN      SLC TYPE  ANAME      SLKTPS
1301 A   SCS1     0  IPSP    sg1301a     500
1301 B   SCS2     0  IPSP    sg1301b     1000
1301 A1  MGC1     0  IPSP    sg1301a1    700
1301 B1  MGC2     0  IPSP    sg1301b1    1200
```

IPTPS for LOC = 1301 is (3400 of 5000) 68%

;

The following example shows link information for signaling links configured for a specified association.

**rtrv-slk:aname=m3ua1211a1**

e1001501 09-02-23 16:20:45 EST EAGLE 41.0.0

| LOC  | LINK | LSN     | SLC | TYPE | ANAME      | SLKTPS |
|------|------|---------|-----|------|------------|--------|
| 1211 | A1   | ls1211b | 0   | IPSG | m3ua1211a1 | 600    |
| 1211 | A2   | ls1211c | 0   | IPSG | m3ua1211a1 | 700    |

;

The following example shows the link information for an E5-ATM card.

**rtrv-slk:loc=1305**

tekelecstp 09-01-14 12:17:00 EST EAGLE 41.0.0

| LOC  | LINK | LSN | SLC | TYPE   | LP | BPS     | ATM  | VCI | VPI | LL |
|------|------|-----|-----|--------|----|---------|------|-----|-----|----|
| 1305 | A    | ls1 | 0   | LIMATM | 1  | 1544000 | LINE | 5   | 0   | 0  |
| 1305 | B    | ls1 | 1   | LIMATM | 1  | 1544000 | LINE | 5   | 0   | 0  |

The following example shows the link **b** information for an E5-ATM card.

**rtrv-slk:loc=1305:link=b**

tekelecstp 09-01-14 12:17:00 EST EAGLE 41.0.0

| LOC  | LINK | LSN | SLC | TYPE   | LP | BPS     | ATM  | VCI | VPI | LL |
|------|------|-----|-----|--------|----|---------|------|-----|-----|----|
| 1305 | B    | ls1 | 1   | LIMATM | 1  | 1544000 | LINE | 5   | 0   | 0  |

The following example includes T1 signaling links assigned to E5-E1T1 cards. The link with BPS value 1536000 is an ST-HSL-A link.

**rtrv-slk**

tekelecstp 09-04-14 16:22:25 EST EAGLE5 41.0.0

| LOC  | LINK | LSN  | SLC | TYPE  | L2T | BPS    | ECM   | PCR  | PCR   | T1   | T1  |
|------|------|------|-----|-------|-----|--------|-------|------|-------|------|-----|
| 1201 | B    | t11s | 0   | LIMT1 | 11  | 56000  | BASIC | ---- | ----- | 1201 | 2 2 |
| 1202 | A    | t21s | 0   | LIMT1 | 21  | 1.536M | PCR   | 608  | 32224 | 1202 | 5 1 |

SLK table is (2 of 1200) 0% full.

;

**Legend**

**LOC**—The location of the card containing the signaling link.

**LINK**—The signaling link assigned to the card.

**LSN**—The name of the linkset containing the signaling link.

**SLC**—The signaling link code of the signaling link.

**TYPE**—The type of card.

**L2TSET**—The number of the level 2 timer set associated with the signaling link.

**BPS**—The transmission rate of the signaling link in bits per second.

**ECM**—The basic of PC for transmission.

**PCRN1**—The MSU number.

**PCRN2**—The octet number.

**LPSET**—The ATM link parameter set identifier.

**ATMTSEL**—The ATM timing selector. Possible values are as follows:

**INTERNAL**—Derived from an internal clock source operating at 1.544 MHz  $\pm$  200 Hz (ANSI) or 2.048 MHz  $\pm$  103 Hz (ITU).

**EXTERNAL**—Derived from the High-Speed Master Clock (T1 or E1).

**LINE**—Derived from its received data stream, if present.

**VCI**—The ATM virtual channel identifier.

**VPI**—The ATM virtual path identifier.

**LL**—The ATM line length.

**E1PORT**—The E1 card port that has an E1 interface assigned to it.

**E1LOC**—The card location of an E1 card with an E1 interface assigned to it.

**T1PORT**—The T1 card port that has a T1 interface assigned to it.

**T1LOC**—The card location of a T1 card with a T1 interface assigned to it.

**TS**—The timeslot associated with the signaling link that is serviced by the E1 or T1 interface.

**E1ATMCRC4**—E1 ATM card CRC4 multi-frame structure enable/disable indicator.

**E1ATMSI**—Value of two Spare International bits of NFAS data for the E1 ATM card.

**E1ATMSN**—Value of five Spare National bits of NFAS data for the E1 ATM card.

**IPLIML2**—IPLIM Level 2 stack (M2PA)

## rtrv-slt

## Retrieve Signaling Link Test Message

Use this command to display the fields of an SLTM (signaling link test message) record in the SLTM table.

**Keyword:** rtrv-slt

**Related Commands:** chg-l3t, chg-slt, ent-ls, rtrv-ls

**Command Class:** Database Administration

### Parameters

**:enabled=** (optional)

Displays the SLTM records that are either enabled (**on**) or disabled (**off**).

**Range:** on, off

**Default:** All SLTM records with the specified value for the enabled parameter are shown.

**:sltset=** (optional)

The signaling link test message (SLTM) record number in the SLTM table.

**Range:** 1-20

**Default:** Display all

### Example

```
rtrv-slt
rtrv-slt:sltset=1
rtrv-slt:enabled=off
```

### Dependencies

None

### Notes

None

## Output

**rtrv-slt**

```

rlghncxa03w 03-03-07 00:21:24 EST EAGLE 31.3.0
SLTM PARAMETERS
SLTSET  T1  T2  MODE  ENABLED  PATTERN
1      9.0 60.0 SPECIAL ON      AA2233445566778899AABBCCDDEEFF
2     12.0 30.0 SPECIAL OFF     F01234BCDE
3      4.0 50.0 REGULAR ON      CC2233445566778899AABBCCDDEEFF
4      6.0 90.0 SPECIAL OFF     BB23446789BCABEFG
5      6.0 90.0 SPECIAL OFF     BB23446789BCABEFG
6      6.0 90.0 SPECIAL OFF     BB23446789BCABEFG
7      6.0 90.0 SPECIAL OFF     BB23446789BCABEFG
8      6.0 90.0 SPECIAL OFF     BB23446789BCABEFG
9      6.0 90.0 REGULAR OFF     BB23446789BCABEFG
10     6.0 90.0 REGULAR OFF     BB23446789BCABEFG
11     6.0 90.0 REGULAR OFF     BB23446789BCABEFG
12     4.0 50.0 SPECIAL ON      FFEEDDCCBBAA998877665544332211
13     4.0 50.0 SPECIAL ON      EE22334455
14     6.0 90.0 SPECIAL ON      AABCCDD
15     6.0 90.0 REGULAR ON      AABCCDD
16     6.0 90.0 REGULAR ON      AABCCDD
17     6.0 90.0 REGULAR ON      AABCCDD
18     6.0 90.0 SPECIAL ON      AABCCDD
19     6.0 90.0 SPECIAL ON      AABCCDD
20     6.0 90.0 SPECIAL ON      AABCCDD

```

;

**rtrv-slt:sltset=1**

```

rlghncxa03w 03-03-07 00:21:24 EST EAGLE 31.3.0
SLTM PARAMETERS
SLTSET  T1  T2  MODE  ENABLED  PATTERN
1      9.0 60.0 SPECIAL ON      112233445566778899AABBCCDDEEFF

```

;

**rtrv-slt:enabled=off**

```

rlghncxa03w 03-03-07 00:21:24 EST EAGLE 31.3.0
SLTM PARAMETERS
SLTSET  T1  T2  MODE  ENABLED  PATTERN
2     12.0 30.0 SPECIAL OFF     F01234BCDE
4      6.0 90.0 SPECIAL OFF     0123446789BCABEFG
5      6.0 90.0 SPECIAL OFF     0123446789BCABEFG
6      6.0 90.0 SPECIAL OFF     0123446789BCABEFG
7      6.0 90.0 SPECIAL OFF     0123446789BCABEFG
8      6.0 90.0 SPECIAL OFF     0123446789BCABEFG
9      6.0 90.0 REGULAR OFF     0123446789BCABEFG
10     6.0 90.0 REGULAR OFF     0123446789BCABEFG
11     6.0 90.0 REGULAR OFF     0123446789BCABEFG

```

;

**Legend**

**SLTSET**—The signaling link test message record number in the SLTM table.

**T1**—The T1 timer value for the SLTM record. After an SLTM test fails, this parameter specifies the amount of time, in seconds, to wait before running the SLTM test again.

**T2**—The T2 timer value for the SLTM record. This parameter specifies the amount of time, in seconds, to wait between running SLTM tests for a normally functioning signaling link.

**MODE**—The SLTM mode to be used when sending test messages.

**ENABLED**—Indicates whether the signaling link test message is enabled.

**PATTERN**—The test pattern to be sent with a signaling link test message.

**rtrv-spc****Retrieve Secondary Point Code**

Use this command to retrieve an SPC (secondary point code) from the active database.

**Keyword:** rtrv-spc

**Related Commands:** dlt-spc, ent-spc

**Command Class:** Database Administration

**Parameters**

**NOTE:** See "Point Code Formats and Conversion" for a detailed description of point code formats, rules for specification, and examples.

**:spc=** (optional)

ANSI point code in the form of *network indicator-network cluster-network cluster member (ni-nc-ncm)*.

**Synonym:** spca

**Range:** 000-255

Specify a valid value for each subfield of the point code, and separate the subfields with a dash (-).

When **chg-sid:pctype=ansi** is specified, *ni = 000* is not valid.

When **chg-sid:pctype=ansi** is specified, *nc = 000* is not valid if *ni = 001-005*.

When **chg-sid:pctype=ansi** is specified, *nc = 000* is valid if *ni = 006-255*.

The point code **000-000-000** is not a valid point code.

**:spc/spca/spci/spcn/spcn24=** (optional)

The secondary point code.

**:spci=** (optional)

ITU international secondary point code with subfields *zone-area-id*. The *prefix* subfield indicates a spare point code (*prefix-zone-area-id*).

**Range:** s-, 0-255

Specify a valid value for each subfield of the point code, and separate the subfields with a dash (-).

*prefix*—s-

*zone*—0-7

*area*—000-255

*id*—0-7

The point code **0-000-0** is not a valid point code.

**:spcn=** (optional)

ITU national point code in the format of a 5-digit number (*nnnnn*); or 2, 3, or 4 numbers (members) separated by dashes (*m1-m2-m3-m4*) as defined by the **chg-stpopts:npcfmti** flexible point code option. A group code must be specified when the ITUDUPPC feature is turned on (*nnnnn-gc*, *m1-m2-m3-m4-gc*). The *prefix* subfield indicates a spare point code (*prefix-nnnnn*, *prefix-nnnnn-gc*, *prefix-m1-m2-m3-m4*, *prefix-m1-m2-m3-m4-gc*).

**Range:** s-, 0-16383, aa-zz

Specify a valid value for each subfield of the point code, and separate the subfields with a dash (-).

*prefix*—s-

*nnnnn*—0-16383

*gc*—**aa-zz**

*m1-m2-m3-m4*—**0-14** for each member; values must sum to 14

**:spcn24=** (optional)

24-bit ITU national point code with subfields *main signaling area-sub signaling area-signaling point* (*msa-ssa-sp*).

**Range:** **000-255**

Specify a valid value for each subfield of the point code, and separate the subfields with a dash (-).

*msa*—**000-255**

*ssa*—**000-255**

*sp*—**000-255**

### Example

```
rtrv-spc
```

```
rtrv-spc:spc=5-3-3
```

```
rtrv-spc:spcn24=98-98-98
```

```
rtrv-spc:spcn=s-00345
```

### Dependencies

The MPC feature must be turned on before this command can be entered.

The value of the **spc** parameter must be a full point code.

### Notes

In this command, only ITU-international and ITU national point codes support the spare point code subtype prefix (s-).

**Output**

The following example shows the output for all provisioned secondary point codes. (SPC-N is a flexible point code format as defined with the **chg-stpopts:npcfmti** parameter).

```
rtrv-spc
rlghncxa03w 03-03-18 08:50:12 EST EAGLE 31.0.0
SPC (Secondary Point Codes)

SPCA
    001-010-010
    002-010-010
    003-010-010

SPC-I
    01-253-05
    02-254-06
    03-255-07

SPC-N
    120-01-0-1
    100-02-1-0

SPC-N24
    099-099-099

Secondary Point Code table is (9 of 40) 25% full
```

;

The following example shows the output for all provisioned secondary point codes. Spare point codes are included in the output.

```
rtrv-spc
rlghncxa03w 05-01-18 08:50:12 EST EAGLE 31.12.0
SPC (Secondary Point Codes)

SPCA
    001-001-001
    001-123-003

SPC-I
    1-001-1
    s-1-001-1
    2-003-4
    s-4-003-4

SPC-N
    00234
    s-00345

SPC-N24
    011-011-011

Secondary Point Code table is (9 of 40) 22% full.
```

;

The following example shows the only provisioned secondary point code, which is a 24-bit ITU-N secondary point code.

```
rtrv-spc
rlghncxa03w 05-03-18 08:50:12 EST EAGLE 31.0.0
SPC (Secondary Point Codes)
```

SPCA  
none

SPC-I  
none

SPC-N  
none

SPC-N24  
099-099-099

Secondary Point Code table is (1 of 40) 2% full.

;

The following example shows information for a specific ANSI secondary point code.

**rtrv-spc:spc=5-3-3**

rlghncxa03w 03-03-18 08:50:12 EST EAGLE 31.3.0  
SPC (Secondary Point Codes)  
005-003-003

Secondary Point Code table is (8 of 40) 25% full.

;

In the following example, the specified secondary point code is not provisioned.

**rtrv-spc:spc=5-3-1**

rlghncxa03w 03-03-18 08:50:12 EST EAGLE 31.3.0  
SPC (Secondary Point Codes)

Secondary Point Code specified is not provisioned

Secondary Point Code table is (3 of 40) 8% full.

;

The following example shows information for a specific ITU-N secondary spare point code.

**rtrv-spc:spcn=s-00345**

rlghncxa03w 03-03-18 08:50:12 EST EAGLE 31.12.0  
SPC (Secondary Point Codes)  
s-00345

Secondary Point Code table is (2 of 40) 5% full.

;

The following example shows output for a specific 24-bit ITU-N secondary point code.

**rtrv-spc:spcn24=98-98-98**

rlghncxa03w 03-03-18 08:50:12 EST EAGLE 31.0.0  
SPC (Secondary Point Codes)  
098-098-098

Secondary Point Code table is (2 of 40) 5% full.

;

**Legend**

**SPC**—Secondary point code

**SPCA**—ANSI secondary point code

**SPC-I**—ITU international secondary point code



SPC-N—ITU national secondary point code

SPC-N24—24-bit ITU national secondary point code

## rtrv-srvsel

## Retrieve Service Selector

Use this command to display a list of administered service selector combinations. The list can be filtered using various parameter combinations.

**NOTE: The rtrv-srvsel operation may be lengthy because the service selector table can contain over 1,000 entries.**

**Keyword:** rtrv-srvsel

**Related Commands:** chg-srvsel, dlt-srvsel, ent-srvsel

**Command Class:** Database Administration

### Parameters

**:force=** (optional)

The **force=yes** parameter must be specified when a **num** parameter value greater than **50** is specified to display more than 50 entries.

**Range:** yes, no

**Default:** no

**:gti/gtia/gtii/gtin/gtin24=** (optional)

Global title indicator. For all service selector commands, the domain is defined as **gti** and **gtia** (ANSI), **gtii** (ITU international), **gtin** (ITU national) and **gtin24** (24-bit ITU national). For the service selector commands, **gti** and **gtia** are equivalent.

**Range:** Supported value for ANSI: **gti=2** and **gtia=2**

Supported values for ITU: **gtii=2, 4; gtin=2, 4; gtin24=2, 4**

**Default:** Display all

**:nai=** (optional)

Nature of Address indicator. The Nature of Address indicator can be specified by supplying either a mnemonic value (**nai** parameter) or an explicit numeric value (**naiv** parameter). Either the **nai** parameter or the **naiv** parameter, but not both, can be specified in the command. Table A-5 shows the mapping between the **naiv** and the **nai** parameter values.

**Range:** sub, rsvd, natl, intl

**Default:** Display all

**:naiv=** (optional)

Nature of Address indicator value. The Nature of Address indicator can be specified by supplying either a mnemonic value (**nai** parameter) or an explicit numeric value (**naiv** parameter). Either the **nai** parameter or the **naiv** parameter, but not both, can be specified in the command. Table A-5 shows the mapping between the **naiv** and the **nai** parameter values.

**Range:** 0-127

**Default:** Display all

**:np=** (optional)

Numbering Plan. The numbering plan can be specified by supplying either a mnemonic value (**np** parameter) or an explicit numeric value (**npv** parameter). Either the **np** parameter or the **npv** parameter, but not both, can be specified in the command. Table A-6 shows the mapping between the **npv** and the **np** parameter values.

**Range:** e164, generic, x121, f69, e210, e212, e214, private

**Default:** Display all

**:npv=** (optional)

Numbering Plan value. The numbering plan can be specified by supplying either a mnemonic value (**np** parameter) or an explicit numeric value (npv parameter). Either the **np** parameter or the **npv** parameter, but not both, can be specified in the command. Table A-6 shows the mapping between the **npv** and the **np** parameter values.

**Range:** 0-15

**Default:** Display all

**:num=** (optional)

Number of entries to display. The **force=yes** parameter is required when this parameter value is specified greater than 50 entries.

**Range:** 1-20992

**Default:** 50

**:serv=** (optional)

The Service Module card service.

**Range:** **eir, gflex, gport, inpq, inpmr, smsmr, idps, idpr, mnp, vflex, atinp, ttr**

**eir**— Equipment Identity Register

**gflex**— GSM flexible numbering

**gport**— GSM number portability

**inpq**— INP query

**inpmr**— INP message relay

**smsmr**— Prepaid SMS Intercept Phase 1, Portability Check for Mobile Originated SMS, MO SMS GSM NP, MO SMS IS41 NP, MO SMS IS41-to-GSM Migration, MO SMS ASD, MO SMS GRN, MO SMS B-Party routing.

**idps**— IDP Screening for Prepaid

**idpr**— Prepaid IDP Query Relay

**mnp**— mobile number portability

**vflex**— Voice Mail Router

**atinp**— ATI Number Portability Query (ATINP)

**ttr**— Triggerless TCAP Relay

**Default:** Display all

**:snai=** (optional)

The service nature of address indicator.

**Range:** **sub, natl, intl, rnidn, rnrndn, rnsdn, ccrndn**

**sub**—Subscriber number

**natl**—National significant number

**intl**—International number

**rnidn**—Routing number prefix and international dialed/directory number

**rnrndn**—Routing number prefix and national dialed/directory number

**rnsdn**—Routing number prefix and subscriber dialed/directory number

**ccrndn**—Country code, routing number, and national directory number

**Default:** Display all

**:snp=** (optional)

The service numbering plan.

**Range:** **e164, e212, e214**

**e164**—E.164 numbering plan

**e212**—E.212 numbering plan

**e214**—E.214 numbering plan

**Default:** Display all

**:ssn=** (optional)

Subsystem number.

**Range:** 0-255 \*

**:tt=** (optional)

Translation type.

**Range:** 0-255

**Default:** Display all

### Example

```
rtrv-srvsel
rtrv-srvsel:gtii=2
rtrv-srvsel:tt=0:np=e164
rtrv-srvsel:serv=vflex
```

### Dependencies

The INP feature or the AINPQ feature must be turned on before the **serv=inpmr** or **serv=inpq** parameter can be specified.

The G-Flex feature must be turned on before the **serv=gflex** parameter can be specified.

The G-Port feature must be turned on before the **serv=gport** parameter can be specified.

The **np** and **npv** parameters cannot be specified together in the command.

The **nai** and **naiv** parameters cannot be specified together in the command.

The values **1** and **3** are not valid for the **gti/gtia/gtii/gtin/gtin24** parameters.

The value **4** is not valid for the **gti/gtia** parameters.

If the **gti/gtia/gtii/gtin/gtin24=2** parameter is specified, then no **np(v)** and **nai(v)** parameter combinations can be specified.

If the **serv** parameter has a value of **inpmr**, **inpq**, **gport**, or **eir**, then the **gtia** and **gti** parameters cannot be specified.

If the **serv=inpmr** parameter is specified, then the value of the **snp** parameter must be **e164** if specified.

If the value specified for the **snai** parameter is **rnidn**, **rnndn**, or **rnsdn**, then the value of the **serv** parameter must be **inpmr**, **gport**, or **smsmr** if it is specified.

If the **serv=inpq** parameter is specified, then the **gtii** parameter cannot be specified.

If the value specified for the **snai** parameter is **rnidn**, **rnndn**, or **rnsdn**, then the **serv=gflex** parameter cannot be specified.

If the value specified for the **serv** parameter is **inpq**, **vflex**, or **eir**, then the **snp** and **snai** parameters cannot be specified.

If the **snai=ccrndn** parameter is specified, then the value specified for the **serv** parameter must be **gport**, or **smsmr**.

If the value specified for the **num** parameter is greater than **50**, then the **force=yes** parameter must be specified.

The Prepaid IDP Query Relay feature must be turned on or the IAR Base feature must be enabled before the **serv=ttr** parameter can be specified.

If a value of **idpr** or **ttr** is specified for the **serv** parameter, then the only valid parameters are **tt**, **ssn**, and **gti/gtia/gtii/gtin**, and the only valid optional parameters are **np** and **nai**.

The IDP Screening for Prepaid feature must be turned on before the **serv=idps** parameter can be specified.

The V-flex feature must be turned on before the **serv=vflex** parameter can be specified.

The Portability Check for Mobile Originated SMS or the PPSMS feature must be turned on, or the MO SMS ASD, MO SMS B-Party Routing, MO SMS GRN, MO SMS IS41-to-GSM Migration, MO-based GSM SMS NP, or MO-based IS41 SMS NP feature must be enabled before the **serv=smsmr** parameter can be specified.

The ATINP feature must be enabled before the **serv=atinp** parameter can be specified.

If the **serv=atinp** parameter is specified, then the **gtin24** parameter cannot be specified.

The Prepaid IDP Query Relay feature must be turned on before the **serv=idpr** parameter can be specified.

## Notes

None

**Output**

The following example displays all provisioned service selectors:

**rtrv-srvsel**

```
rlghncxa03w 00-03-29 16:40:40 EST EAGLE 31.3.0
GTIA TT NP NAI NPV NAIV SNP SNAI SERV
2 9 -- --- --- --- e212 intl gflex
2 10 -- --- --- --- e164 intl gflex
2 253 -- --- --- --- e214 natl gflex

GTII TT NP NAI NPV NAIV SNP SNAI SERV
2 0 -- --- --- --- e164 intl gflex
2 18 -- --- --- --- e164 rnsdn inpmr
4 0 e214 sub --- --- e214 sub gflex

GTIN TT NP NAI NPV NAIV SNP SNAI SERV
2 2 -- --- --- --- e164 intl gflex
2 9 -- --- --- --- --- --- inpq
4 2 e164 natl --- --- e164 rnndn inpmr
4 9 --- --- 10 128 --- --- inpq
```

;

The following example displays all service selectors containing the specified GTI value:

**rtrv-srvsel:gtii=2**

```
rlghncxa03w 07-09-29 16:40:40 EST EAGLE 37.6.0
GTII TT NP NAI SSN SNP SNAI SERV
2 0 -- --- 7 e164 intl gflex
2 18 -- --- 7 e164 rnidn inpmr
```

;

The following example includes a **gtin24** entry:

**rtrv-srvsel**

```
rlghncxa03w 07-09-29 16:40:40 EST EAGLE 37.6.0
GTIN TT NP NAI SSN SNP SNAI SERV
4 4 e164 intl 8 e164 intl gport

GTIN24 TT NP NAI SSN SNP SNAI SERV
4 4 e164 intl 2 e164 intl gport

SRV SELECTOR table is (2 of 20992) 1 % full
```

;

The following examples display service selectors containing the **eir**, **smsmr**, **mnpsms** and **idps** services:

**rtrv-srvsel**

```
tekelecstp 03-03-28 15:43:22 EST EAGLE5 31.0.0
GTII TT NP NAI NPV NAIV SSN SNP SNAI SERV
4 1 e214 intl --- --- 3 --- --- eir
4 1 e214 intl --- --- 4 e164 intl gport
4 1 e214 intl --- --- 5 e164 intl smsmr
4 2 e214 intl --- --- 5 e164 intl mnpsms
4 2 e214 intl --- --- * --- --- eir
4 20 e164 intl --- --- 6 --- --- idps

GTIN TT NP NAI NPV NAIV SSN SNP SNAI SERV
4 4 e214 natl --- --- --- e164 intl gflex
4 9 e214 natl --- --- --- e164 intl gflex

SRV SELECTOR table is (7 of 20992) 1 % full
```

;

**rtrv-srvsel:ssn=3**

```
tekelecstp 07-09-28 15:43:22 EST EAGLE5 37.6.0
GTII TT NP NAI SSN SNP SNAI SERV
4 1 e214 intl 3 --- --- eir
```

SRV SELECTOR table is (4 of 20992) 1 % full

;

**rtrv-srvsel**

```
tekelecstp 05-08-17 17:05:51 EST 33.1.0
GTII TT NP NAI NPV NAIV SSN SNP SNAI SERV
4 20 e164 intl --- --- 123 ---- ---- idpr
```

SRV SELECTOR table is (1 of 20992) 1 % full

;

**rtrv-srvsel:serv=mp**

```
rlghncxa03w 07-09-29 16:40:40 EST EAGLE 37.6.0
GTIN TT NP NAI SSN SNP SNAI SERV
4 0 e164 128 8 e164 ccrndn mp
```

;

```
tekelecstp 07-09-16 17:09:08 EST EAGLE 37.6.0
GTIA TT NP NAI SSN SNP SNAI SERV
2 9 -- --- * e212 intl gflex
2 10 -- --- 3 e164 intl gflex
2 253 -- --- 4 e214 natl gflex
```

```
GTII TT NP NAI SSN SNP SNAI SERV
2 0 -- --- 2 e164 intl gflex
2 18 -- --- * e164 rnsdn inpmr
4 0 e214 sub * e214 sub gflex
```

```
GTIN TT NP NAI SSN SNP SNAI SERV
2 2 -- --- 3 e164 intl gflex
2 9 -- -- * --- inpq
4 2 e164 natl * e164 rnndn inpmr
4 9 --- --- 4 --- --- inpq
```

;

**rtrv-srvsel:serv=vflex**

```
tekelecstp 07-08-28 16:35:22 EST EAGLE 37.6.0
GTII TT NP NAI SSN SNP SNAI SERV
4 1 e164 intl 3 --- --- vflex
4 2 e164 intl * --- --- vflex
```

```
GTIN TT NP NAI SSN SNP SNAI SERV
4 4 e164 natl 4 --- --- vflex
```

SRV SELECTOR table is (3 of 20992) 1 % full

;

**rtrv-srvsel:serv=smsmr**

```
tekelecstp 08-04-07 09:33:26 EST EAGLE 39.0.0
GTII TT NP NAI NPV NAIV SSN SNP SNAI SERV
2 6 -- ---- --- ---- 10 e164 intl smsmr
```

SRV SELECTOR table is (1 of 20992) 1 % full

;

**rtrv-srvsel:serv=atinp**

```
tekelecstp 08-08-28 15:43:22 EST EAGLE5 39.2.0
GTII TT NP NAI SSN SNP SNAI SERV
4 0 e214 intl 8 --- --- atinp
```

SRV SELECTOR table is (4 of 20992) 1 % full

;

The following example displays the output when no service selectors are provisioned:

```
rtrv-srvsel
      tekelecstp 09-01-04 13:28:13 EST EAGLE 40.1.0

      GTIA TT NP NAI SSN SNP SNAI SERV
      No SRV Selector found in range
;
```

### **Legend**

**GTI/GTIA/GTII/GTIN/GTIN24**—Global title indicator.

**TT**—Translation type.

**NP**—Numbering plan.

**NAI**—Nature of address indicator.

**NPV**—Numbering plan value.

**NAIV**—Nature of address indicator value.

**SSN**—Subsystem number.

**SNP**—Service numbering plan.

**SNAI**—Service nature of address indicator.

**SERV**—Service Module card service.

## **rtrv-ss-appl**

### **Retrieve Subsystem Application**

Use this command to retrieve information for all provisioned subsystem applications from the database. The command displays the application type, subsystem number, and application status.

**Keyword:** **rtrv-ss-appl**

**Related Commands:** **chg-ss-appl, dlt-ss-appl, ent-ss-appl**

**Command Class:** Database Administration

### **Parameters**

This command has no parameters.

### **Example**

```
rtrv-ss-appl
```

### **Dependencies**

The EIR, LNP, or V-Flex feature must be enabled, or the AINPQ, ATINP, or INP feature must be turned on before this command can be entered.

### **Notes**

None

**Output**

```

rtrv-ss-appl
rlghncxa03w 08-08-17 16:02:05 EST  EAGLE 39.2.0
APPL  SSN  STAT
LNP   15   online

SS-APPL TABLE IS 20% FULL (1 OF 5)
;

rtrv-ss-appl
tekelecstp 08-08-28 14:42:38 EST  EAGLE 39.2.0
APPL  SSN  STAT
EIR   11   online
ATINPQ 10   online
SS-APPL TABLE IS 40% FULL (2 OF 5)
;

```

**Legend****APPL**—Application type**SSN**—Subsystem number**STAT**—Status:online or offline**rtrv-ss7opts****Retrieve SS7 Options**

This command retrieves the current values of the SS7 option indicators maintained in the STP options table. SS7 options can modify normal handling of SS7 traffic.

**Keyword:** rtrv-ss7opts**Related Commands:** chg-ss7opts**Command Class:** Database Administration**Parameters**

This command has no parameters.

**Example**

```
rtrv-ss7opts
```

**Dependencies**

None

**Notes**

None



**Output**

```

rtrv-ss7opts
tekelecstp 09-05-10 03:59:31 EST EAGLE 41.0.0

SS7 OPTIONS
-----
LSRESTRICT    off
DISCARDTFCI   off
DISCARDTFCN   off
SLSREPLACE    yes
SLANCPORGOPC off
DDBAUDTIMER   10
SLANLSN       off
MSGPRI2ITUI   3
MSGPRI2ITUN   0
;

```

**rtrv-stp****Retrieve STP Information**

Use this command to retrieve information related to the STP at which the command is entered.

The command can retrieve frame and card power consumption and threshold values (in Amps or milliAmps and Watts) for all provisioned frames or for a specified frame. (See the **ent-frm-pwr** command.)

The command can retrieve hardware configuration information (card location, board part number, revision, serial number, card type, card memory, APPL, and GPL version):

- For all provisioned STP frames and shelves
- For a specific provisioned frame
- For a specific provisioned shelf
- For a specific equipped card
- For all cards of the specified card type
- For all cards that contain the specified Board Part Number
- For all cards that are running the specified GPL or GPL version.

**Keyword:** **rtrv-stp**

**Related Commands:** **chg-frm-pwr, dlt-frm-pwr, ent-frm-pwr, rtrv-frm-pwr**

**Command Class:** Database Administration

**Parameters**

**:display=** (optional)

Display the power consumption and power threshold value for all provisioned frames or for one specific provisioned frame.

This parameter must be specified when the **frm** parameter is specified, to display the power information for one frame.

**Range:** **power**

**power** — Display frame power information in the command output.

**:frm=** (optional)

Frame ID. The command displays information for the specified provisioned frame.

**Range:** **cf00, ef00, ef01, ef02, ef03, ef04**

**cf00** — Control Frame identifier

**ef00**— Identifier for the first Extension Frame  
**ef01**— Identifier for the second Extension Frame  
**ef02**— Identifier for the third Extension Frame  
**ef03**— Identifier for the fourth Extension Frame  
**ef04**— Identifier for the fifth Extension Frame

**:gpl=** (optional)

Generic program load. The parameter is specified to display hardware configuration information for all card locations equipped with cards that are running the specified GPL.

This parameter must be specified when the **ver** parameter is specified, to display information for a specific version of the GPL.

**Range:** *xyyyyyyy*

1 alphabetic character followed by up to 7 alphanumeric characters. Valid GPLs are:

**atmansi**—Used by the LIM cards to support the high-speed ATM signaling link feature

**atmhc**—Supports functionality for the E5-ATM card. The E5-ATM card runs either the ATMANSI or ATMITU application. The GPL allows the card to support up to 2 signaling links.

**atmitu**—Used by E1 ATM cards to support the high-speed E1 ATM signaling link feature

**blbepm**—Flash GPL containing the BIOS ROM image on E5-E1T1 and E5-ENET cards

**blbios**—Flash GPL containing the BIOS ROM image on HC-MIM cards that are used for E1 or T1 signaling links

**blbsmg**—Flash GPL containing the BIOS ROM image on E5-SM4G cards

**blepld**—Flash GPL containing the bit files for the CPLD on HC-MIM, E5-E1T1, and E5-ENET cards that are used for E1 or T1 signaling links.

**bldiag6**—Flash GPL containing the diagnostic code on E5-E1T1 cards, HC-MIM cards, and E5-ENET cards

**blmcap**—Flash GPL containing a tar image with all code required on E5-MCAP cards

**blvxw6**—Flash GPL containing the VxWorks operating system on E5-E1T1 cards, HC-MIM cards, and E5-ENET cards

**blrom1**—Flash GPL containing the bootloader code for VxWorks operating system on HC-MIM cards

**bpdcn**—Used to support the flash memory Board PROM for DCM, DSM, and GPSM boards, original design

**bpdcn2**—Used to support the flash memory Board PROM for DCM and GPSM boards, revised design

**bphcap**—Used to support Board PROM for HCAP flash memory

**bphcapt**—Supports Board PROM for HCAP-T flash memory

**bphmux**—Supports Board PROM for HMUX flash memory

**bpmpl**—Supports Board PROM for MPL flash memory

**bpmplt**—Supports Board PROM for E1/T1 flash memory

**cd**—Used in the card manufacturing process.

**eoam**—Used by the GPSM-II card for enhanced OAM functions

**eroute**—Used by the STC card for EAGLE 5 Integrated Monitoring Support functions

**erthc**—Used by the E5-ENET card when the card acts as an STC card (E5-STC card) for EAGLE 5 Integrated Monitoring Support functions

**gls**—Used by TSM cards to download gateway screening to LIM cards

**glshe**—Used by E5-TSM cards to download gateway screening to LIM and SCCP cards

**hipr**—Communication software used on the High Speed IMT Packet Router (HIPR) card

**hipr2**—Communication software used on the High Speed IMT Packet Router (HIPR2) card

**imt**—Communication processor on the logical processing element (LPE)

**imtpci**—Communication software that operates the IMT bus on HC-MIM, E5-E1T1, and E5-ENET cards

**ipghe**—Used by E5-ENET cards to support TCP/IP point-to-multipoint connectivity for both ANSI and ITU point codes

**ipgwi**—Used by SSEDCCM cards for TCP/IP point-to-point connectivity for ITU point codes

**iplhe**—Used by E5-ENET cards for TCP/IP point-to-point connectivity for both ANSI and ITU point codes

**iplim**—Used by SSEDCCM cards for TCP/IP point-to-point connectivity for ANSI point codes

**iplimi**—Used by SSEDCCM cards for TCP/IP point-to-point connectivity for ITU point codes

**ips**—Used by IPSM cards for the IP User Interface feature

**ipsg**—Used by E5-ENET cards to support the combined functionality of IPLIMx M2PA and IPGWx M3UA

**ipshc**—Used by E5-IPSM cards to support the IPS application

**mcp**—Used by MCPM cards for the Measurements Platform feature

**oamhc**—Used by E5-MCAP cards for enhanced OAM functions

**pldpmc1**—Flash GPL used on HC-MIM and E5-E1T1 cards for E1 and T1 signaling links

**sccphe**—Used by E5-SM4G cards to support the EPAP-based features and the LNP ELAP Configuration feature. If no EPAP-based or LNP ELAP Configuration feature is turned on, and if an E5-SM4G card when the card acts as an STC card (E5-STC card) for EAGLE 5 Integrated Monitoring Support functions.

**ss7hc**—Supports the functionality for HC-MIM or E5-E1T1 cards. The HC-MIM and E5-E1T1 cards run the SS7ANSI or CCS7ITU application; the GPL allows the card to support up to 64 signaling links for E1 and T1 functions.

**ss7ipgw**—Used by SSEDCCM cards to support TCP/IP point-to-multipoint connectivity

**ss7ml**—Support functionality for MPL and the E1/T1 MIM cards. MPL cards run the SS7ANSI application on a LIMDS0 card (as in the command **ent-card:type=limds0:appl=ss7ansi**); the GPL allows the card to support 8 signaling links rather than the usual 2 links for LIM cards. MPL cards support only the DS0 interface. E1/T1 MIM card runs either the SS7ANSI or CCS7ITU application; the GPL allows the card to support 8 signaling links for E1 and T1 functions.

**utility**—Used by the factory for testing, and when directed by the Customer Care Center

**vedu**—Used in the card manufacturing process

**vsccp**—Used by Service Module cards to support the EPAP-based and the LNP ELAP Configuration features. If no EPAP-based or LNP ELAP Configuration feature is turned on, and if a Service Module card is present, then the GPL processes normal GTT traffic.

**vxwslan**—Used by SSEDCCM cards to support the STP LAN application

**:partnum=** (optional)

Display the hardware configuration for all card locations that contain a card with the specified Board Part Number.

**Range:** *zzz-zzzz-zz*

Specify the Board Part Number in the format *xxx-xxxx-xx*. See the Hardware Baseline appendix in the *Feature Notice* for a list of Board Part Numbers that are supported for the EAGLE 5 ISS release.

**:shelf=** (optional)

Display the hardware configuration information for all card locations in the specified EAGLE shelf.

**Range:** **1100, 1200, 1300, 2100, 2200, 2300, 3100, 3200, 3300, 4100, 4200, 4300, 5100, 5200, 5300, 6100**

**:type=** (optional)

Display the hardware configuration information for all card locations that contain cards of the specified card type.

**Range:** **dcm, dsm, ipsm, limatm, limch, limds0, lime1, limt1, mcpm, stc, tsm, enet, lime1atm**

**:ver=** (optional)

Display the hardware configuration information for all the card locations that have cards with the specified GPL Type and the specified GPL Version. The version format is *major-minor-fix*.

**Range:** *major-minor-fix*

*major*—Range **0-255**

*minor*—Range **0-255**

*fix*—Range **0-255**

### Example

Retrieve the frame power information for all provisioned frames of the STP.

**rtrv-stp:display=power**

Retrieve the card level power information for the control frame in the STP.

**rtrv-stp:display=power:frm=cf00**

Retrieve the hardware configuration information for the STP control shelf (shelf 1100).

**rtrv-stp:shelf=1100**

Retrieve the hardware configuration information for all cards equipped in the STP that have the specified Board Part Number.

**rtrv-stp:partnum=870-1275-01**

Retrieve the hardware configuration information for all provisioned TSM cards in the STP.

**rtrv-stp:type=tsm**

Retrieve the hardware configuration information for all cards in the STP that are running the imt communication GPL with GPL version 126-039-043.

**rtrv-stp:gpl=imt:ver=126-039-043**

Retrieve the hardware configuration information for all provisioned frames in the STP.

**rtrv-stp**

Retrieve the hardware configuration information for all cards in the STP that are running the atmhc GPL.

**rtrv-stp:gpl=atmhc**

### Dependencies

The **display** parameter must be specified when the **frm** parameter is specified.

The **gpl** parameter must be specified when the **ver** parameter is specified.

Only one optional parameter can be specified in the command, except for the following parameter combinations:

- The **display** parameter must be specified when the **frm** parameter is specified.
- The **gpl** parameter must be specified when the **ver** parameter is specified.

The **frm** parameter value must specify a provisioned frame.

The value specified for the **gpl** parameter must be supported. See the **gpl** definition for a list of supported GPLs.

### Notes

When the power threshold value has not been provisioned for a provisioned frame, the default frame power threshold value is displayed and prefixed with a plus sign (+).

For an un-provisioned card that is present in the frame, the card power consumption value is displayed prefixed with a plus sign (+).

For the TDM and MDAL cards in the Control Frame and for the HMUX/HIPR cards in all the frames, "TDM", "E5-TDM", "MDAL", "E5-MDAL" or "MUX", respectively, is displayed as the Part Number of the card.

For HIPR2 cards in all the frames, the actual Board Part Number is displayed. If a MUX card is not present, then "Empty" is displayed.

If the Board Part Number received in the BIP response from a card is not present in the Assembly Power table, then the Part Number for the card is displayed with a prefix of a plus sign (+).

If the Card power value is not present in the BIP data and the Assembly Power table, then the default card power value of **1563 milliAmps** is displayed for the card.

If board information is not available from a card,

- **BIP Data inv** is displayed as the Part number for the card.
- The default card power value of **1563 milliAmps** is displayed for the card.

If a card location is empty (no card is present in that slot),

- **Empty** is displayed as the Part Number for the card
- A card power value of **0** is assumed and displayed.

For Standby GPSM-II, E5-MCAP, and TDM cards, "Unavailable" is displayed as the Part Number if either the card is absent. In this case, the card power of the Active GPSM-II or E5-MCAP card is shown for the card power of the standby card also.

If a flash or communication GPL is specified with the **rtrv-stp** command, then the GPL output displays the version of the application GPL that is running on the card and not the version of the specified flash or communication GPL.

An unequipped MUX location does not have any type of MUX card in the slot. If a HIPR2, HIPR or HMUX card is present in the slot, then the location is equipped. When a location is unequipped, the "EMPTY" is displayed for the slots, and an error message is generated. Locations 1109 and 1110,

which support the control shelf, must contain MUX cards before the EAGLE 5 ISS is considered fully operational.

The **rtrv-stp** command can be used to display the power consumption of HMUX/HIPR/HIPR2 cards within a frame. The power consumption displays **0** for an unequipped MUX location. A MUX location with HIPR or HMUX cards displays the default power consumption value. If the location contains a HIPR2 card, then the Part Number, Revision, and Power Consumption obtained from the BIP data associated with the HIPR2 card are displayed.

The EAGLE 5 ISS can have a mixture of HIPR2 cards and any other type of MUX card in the same shelf and can also contain a mixture of MUX cards on the same Bus.

**Output**

If a flash or communication GPL is specified, then the output displays the GPL version of the application GPL running on the card instead of the GPL version of the specified flash or communication GPL.

The power consumption values that are displayed in the **rtrv-stp:display=power** or the **rtrv-stp:display=power:frm=** commands indicate the maximum calculated power for the frame. The calculation is based on the cards that are populated in the system, and includes a fan tray assembly for every shelf (the system cannot detect the presence or absence of a fan tray, and assumes presence for the calculation). These values are typically much higher than the actual power being drawn; the values cannot be used as a gauge of the actual power consumption of the EAGLE 5 ISS.

The following example retrieves the hardware configuration information for a specific shelf containing a HIPR2 card at **loc = 1109**.

**rtrv-stp:shelf=1100**

tekelecstp 09-06-30 11:07:17 EST EAGLE 41.1.0

| Card | Part Number | Rev | Serial Number | Type   | DB    | APPL    | GPL Version |
|------|-------------|-----|---------------|--------|-------|---------|-------------|
| 1101 | 870-1275-01 | W   | 10245689323   | DSM    | 4096M | VSCCP   | 027-010-000 |
| 1102 | Empty       |     |               |        |       |         |             |
| 1103 | 870-1788-03 | A   | 10234658345   | TSM    | 128M  | GLS     | 027-010-000 |
| 1104 | Empty       |     |               |        |       |         |             |
| 1105 | 870-1339-06 | A   | 10274568974   | LIMATM | -     | ATMANSI | 027-010-000 |
| 1106 | Empty       |     |               | DSM    |       | VSCCP   |             |
| 1107 | Empty       |     |               |        |       |         |             |
| 1108 | 870-1456-05 | A   | 10204764378   | DCM    | 512M  | SS7IPGW | 027-010-000 |
| 1109 | 870-2872-01 | A   | 10207185554   | HIPR2  | -     | HIPR2   | 129-001-000 |
| 1110 | MUX         |     |               |        |       | BPHMUX  | 027-345-000 |
| 1111 | 870-1788-05 | A   | 10205734657   | MCPM   | 4096M | MCP     | 027-010-000 |
| 1112 | 870-1789-04 | A   | 10302135627   | LIMDSO | -     | SS7ANSI | 027-010-000 |
| 1113 | 870-2360-01 | A   | 10346357678   | GPSM   | 1024M | EOAM    | 025-340-000 |
| 1114 | TDM         |     |               |        |       |         |             |
| 1115 | Unavailable |     |               | GPSM   |       | EOAM    |             |
| 1116 | Unavailable |     |               |        |       |         |             |
| 1117 | MDAL        |     |               |        |       |         |             |
| 1118 | Empty       |     |               |        |       |         |             |

Command Completed.

;

The following example retrieves the frame power information for all provisioned frames in the STP.

**rtrv-stp:display=power**

tekelecstp 07-03-30 11:07:17 EST EAGLE 37.0.0

| Frame | Power Threshold |         | Power Consumption |         |
|-------|-----------------|---------|-------------------|---------|
|       | (Amps)          | (Watts) | (Amps)            | (Watts) |
| CF00  | 45              | 2160    | 37.71             | 1810    |
| EF00  | 40              | 1920    | 33.99             | 1631    |
| EF01  | 35              | 1680    | 10.00             | 480     |
| EF04  | +30             | +1440   | 14.06             | 675     |

Command Completed.

;

The following example retrieves the frame and card power information for the control frame in the system. The frame contains HIPR cards at **loc=1109** and **1110**, HMUX card at **loc=1209**, and HIPR2 cards at **loc=1309** and **1310**. MUX location **loc=1210** is unequipped.

**rtrv-stp:display=power:frm=cf00**

tekelecstp 09-06-30 11:07:17 EST EAGLE 5 41.1.0

| Frame | Power Threshold |         | Power Consumption |         |
|-------|-----------------|---------|-------------------|---------|
|       | (Amps)          | (Watts) | (Amps)            | (Watts) |
| CF00  | 45              | 2160    | 34.58             | 1795    |

| Card | Part Number   | Revision | Power Consumption |         |
|------|---------------|----------|-------------------|---------|
|      |               |          | (MilliAmps)       | (Watts) |
| 1101 | 850-0484-01   | E        | 313               | 15      |
| 1102 | 870-2372-01   | J        | 521               | 25      |
| 1103 | 870-1289-04   | K        | 313               | 15      |
| 1104 | + 870-2198-01 | M        | + 1563            | + 75    |
| 1105 | 870-1984-05   | M        | + 646             | + 31    |
| 1106 | 870-2372-01   | J        | 521               | 25      |
| 1107 | 870-2061-01   | K        | 542               | 26      |
| 1108 | 870-2061-01   | K        | + 542             | + 26    |
| 1109 | MUX           |          | 313               | 15      |
| 1110 | MUX           |          | 313               | 15      |
| 1111 | 870-2061-01   | B        | 542               | 26      |
| 1112 | 850-0419-03   | C        | 521               | 25      |
| 1113 | 870-2360-01   | B        | 625               | 30      |
| 1114 | TDM           |          | 333               | 16      |
| 1115 | Unavailable   |          | 625               | 30      |
| 1116 | Unavailable   |          | 333               | 16      |
| 1117 | MDAL          |          | 333               | 16      |
| 1118 | Empty         |          | 0                 | 0       |
| 1201 | 870-2061-01   | A        | 542               | 26      |
| 1202 | 870-2061-01   | A        | 542               | 26      |
| 1203 | 850-0549-01   | A        | 313               | 15      |
| 1204 | + 870-2198-01 | M        | 1563              | 75      |
| 1205 | 850-0549-01   | A        | 313               | 15      |
| 1206 | + 870-2198-01 | M        | 1563              | 75      |
| 1207 | 870-2371-02   | E        | 625               | 30      |
| 1208 | 870-1293-02   | B        | 521               | 25      |
| 1209 | MUX           |          | 313               | 15      |
| 1210 | Empty         |          | 0                 | 0       |
| 1211 | 870-2061-01   | D        | 542               | 26      |
| 1212 | 850-0549-01   | A        | 313               | 15      |
| 1213 | 850-0549-01   | A        | 313               | 15      |
| 1214 | 850-0549-01   | A        | 313               | 15      |
| 1215 | 870-2061-01   | C        | 542               | 26      |
| 1216 | 870-1945-03   | D        | 646               | 31      |
| 1217 | Empty         |          | 0                 | 0       |
| 1218 | 870-2061-01   | K        | 542               | 26      |
| 1301 | 870-1984-05   | M        | 646               | 31      |
| 1302 | 850-0549-01   | A        | 313               | 15      |
| 1303 | + 870-2198-01 | M        | 1563              | 75      |
| 1304 | 870-2371-02   | E        | 625               | 30      |
| 1305 | 870-2371-02   | E        | 625               | 30      |
| 1306 | 850-0419-03   | C        | 521               | 25      |
| 1307 |               |          |                   |         |
| 1308 | 870-2061-01   | K        | 542               | 26      |
| 1309 | 870-2872-01   | A        | 313               | 15      |
| 1310 | 870-2872-01   | A        | 313               | 15      |
| 1311 | 850-0484-01   | E        | 313               | 15      |



```

1312 + 870-2198-01 M + 1563 + 75
1313 BIP Data inv + 1563 + 75
1314 BIP Data inv 1563 75
1315 Empty 0 0
1316 Empty 0 0
1317 Empty 0 0
1318 850-0419-03 C 521 25

FAN ASSYs Power Consumption 7812 375
Command Completed.

```

;

The following example retrieves the hardware configuration information for all equipped DSM cards that contain the specified Board Part Number.

**rtrv-stp:partnum=870-1275-01**

```
tekelecstp 07-03-30 11:07:17 EST EAGLE 37.0.0
```

| Card | Part Number | Rev | Serial Number | Type | DB    | APPL  | GPL Version |
|------|-------------|-----|---------------|------|-------|-------|-------------|
| 1101 | 870-1275-01 | W   | 10245689323   | DSM  | 4096M | VSCCP | 027-010-000 |
| 1205 | 870-1275-01 | W   | 10246789323   | DSM  | 4096M | VSCCP | 027-010-000 |
| 1307 | 870-1275-01 | W   | 10204764378   |      |       |       |             |

Command Completed.

;

The following example retrieves the hardware configuration information for all cards of the specified card type.

**rtrv-stp:type=tsm**

```
tekelecstp 08-10-10 11:07:17 EST EAGLE 40.0.0
```

| Card | Part Number | Rev | Serial Number | Type | DB   | APPL | GPL Version |
|------|-------------|-----|---------------|------|------|------|-------------|
| 1103 | 870-1788-03 | A   | 10234658345   | TSM  | 128M | GLS  | 027-010-000 |
| 1212 | 870-1788-03 | A   | 10234632455   | TSM  | 128M | GLS  | 027-010-000 |
| 2105 |             |     |               | TSM  |      | GLS  |             |
| 2217 | 870-2943-03 | A   | 10229185653   | TSM  | 512M | GLS  | 030-005-000 |

Command Completed.

;

The following example retrieves the hardware configuration information for all cards that are running the specified GPL.

**rtrv-stp:gpl=ss7ansi**

```
tekelecstp 07-03-30 11:07:17 EST EAGLE 37.0.0
```

| Card | Part Number | Rev | Serial Number | Type   | DB   | APPL    | GPL |
|------|-------------|-----|---------------|--------|------|---------|-----|
| 1112 | 870-1789-04 | A   | 10302135627   | LIMDS0 | -    | SS7ANSI |     |
| 1203 | 870-1789-04 | A   | 10302135777   | LIMDS0 | -    | SS7ANSI |     |
| 1216 | 870-1789-04 | A   | 10302135655   | LIMDS0 | -    | SS7ANSI |     |
| 1301 | 870-2671-02 | C   | 10145689323   | LIMT1  | 512M | SS7ANSI |     |
| 1303 | 870-1873-01 | C   | 10345689323   | LIMT1  | 512M | SS7ANSI |     |

Command Completed.

;

The following example retrieves the hardware configuration information for all cards that are running the specified version of the specified GPL.

**rtrv-stp:gpl=ss7ansi:ver=126-033-000**

tekelecstp 07-03-30 11:07:17 EST EAGLE 37.0.0

| Card | Part Number | Rev | Serial Number | Type  | DB   | APPL    | GPL |
|------|-------------|-----|---------------|-------|------|---------|-----|
| 1301 | 870-2671-02 | C   | 10145689323   | LIMT1 | 512M | SS7ANSI |     |
| 1303 | 870-1873-01 | C   | 10345689323   | LIMT1 | 512M | SS7ANSI |     |

Command Completed.

;

The following example shows the hardware configuration information for all frames of the STP, without specifying any optional parameters in the command.

**rtrv-stp**

tekelecstp 09-06-30 11:07:17 EST EAGLE 41.1.0

| Card | Part Number  | Rev | Serial Number | Type   | DB    | APPL    | GPL Version |
|------|--------------|-----|---------------|--------|-------|---------|-------------|
| 1101 | 870-1275-01  | W   | 10245689323   | DSM    | 4096M | VSCCP   | 027-010-000 |
| 1102 | Empty        |     |               |        |       |         |             |
| 1103 | 870-1788-03  | A   | 10234658345   | TSM    | 128M  | GLS     | 027-010-000 |
| 1104 | Empty        |     |               |        |       |         |             |
| 1105 | 870-1339-06  | A   | 10274568974   | LIMATM | -     | ATMANSI | 027-010-000 |
| 1106 | Empty        |     |               | DSM    |       | VSCCP   |             |
| 1107 | 870-2212-02  | A   | 10206265084   | DCM    | 512M  | STPLAN  | 128-002-000 |
| 1108 | 870-1456-05  | A   | 10204764378   | DCM    | 512M  | SS7IPGW | 027-010-000 |
| 1109 | 870-2877-01  | A   | 10207185554   | HIPR2  |       | HIPR2   | 128-023-000 |
| 1110 | 870-2877-01  | A   | 10207185554   | HIPR2  |       | HIPR2   | 128-023-000 |
| 1111 | 870-1788-05  | A   | 10205734657   | MCPM   | 2048M | MCP     | 027-010-000 |
| 1112 | 870-1789-04  | A   | 10302135627   | LIMDS0 | -     | SS7ANSI | 027-010-000 |
| 1113 | 870-2360-01  | A   | 10346357678   | GPSM   | 1024M | EOAM    | 025-340-000 |
| 1114 | TDM          |     |               |        |       |         |             |
| 1115 | Unavailable  |     |               | GPSM   |       | EOAM    |             |
| 1116 | Unavailable  |     |               |        |       |         |             |
| 1117 | MDAL         |     |               |        |       |         |             |
| 1118 | Empty        |     |               |        |       |         |             |
| 1201 | 870-1339-06  | A   | 10245667974   | LIMATM | -     | ATMANSI | 027-010-000 |
| 1202 | Empty        |     |               |        |       |         |             |
| 1203 | 870-1789-04  | A   | 10302135777   | LIMDS0 | -     | SS7ANSI | 027-010-000 |
| 1204 | Empty        |     |               |        |       |         |             |
| 1205 | 870-1275-01  | W   | 10246789323   | DSM    | 4096M | VSCCP   | 027-010-000 |
| 1206 | Empty        |     |               |        |       |         |             |
| 1207 | Empty        |     |               | DCM    |       | SS7IPGW |             |
| 1208 | 870-1456-05  | A   | 10204764222   | DCM    | 512M  | SS7IPGW | 027-010-000 |
| 1209 | MUX          |     |               |        |       | BPHMUX  | 027-345-000 |
| 1210 | MUX          |     |               |        |       | BPHMUX  | 027-345-000 |
| 1211 | 870-1788-05  | A   | 10205737777   | MCPM   | 2048M | MCP     | 027-010-000 |
| 1212 | 870-1788-03  | A   | 10234632455   | TSM    | 128M  | GLS     | 027-010-000 |
| 1213 | Empty        |     |               |        |       |         |             |
| 1214 | Auto-Inhibit |     |               | IPSM   |       | IPS     |             |
| 1215 | 870-1788-05  | A   | 10205736734   | MCPM   | 2048M | MCP     | 027-010-000 |
| 1216 | 870-1789-04  | A   | 10302135655   | LIMDS0 | -     | SS7ANSI | 027-010-010 |
| 1217 | Empty        |     |               |        |       |         |             |
| 1218 | Empty        |     |               |        |       |         |             |
| .    |              |     |               |        |       |         |             |
| .    |              |     |               |        |       |         |             |
| .    |              |     |               |        |       |         |             |
| 6118 | 870-2453-06  | A   | 10444135655   | LIMATM | -     | ATMANSI | 028-010-000 |

Command Completed.

;

Retrieve the hardware configuration information for cards, including an E5-STC card.

This example displays abridged output.

**rtrv-stp**

tekelecstp 07-05-03 13:19:14 GMT EAGLE 37.0.0

| Card | Part Number | Rev | Serial Number | Type | DB    | APPL   | GPL Version |
|------|-------------|-----|---------------|------|-------|--------|-------------|
| 1101 | 870-1289-04 | K   | 10206035030   | TSM  | 256M  | GLS    | 128-018-000 |
| 1102 | Empty       |     |               |      |       |        |             |
| 1103 | 870-2212-02 | A   | 10206385320   | DCM  | 512M  | IPLIM  | 128-018-000 |
| 1104 | Empty       |     |               |      |       |        |             |
| 1105 | Empty       |     |               |      |       |        |             |
| 1106 | Empty       |     |               |      |       |        |             |
| 1107 | Empty       |     |               |      |       |        |             |
| 1108 | 870-2212-02 | A   | 10206365046   | DCM  | 512M  | STPLAN | 128-018-000 |
| 1109 | MUX         |     |               |      |       | HIPR   | 128-016-000 |
| 1110 | MUX         |     |               |      |       | HIPR   | 128-016-000 |
| 1111 | 870-2212-02 | A   | 10206275736   | STC  | 512M  | EROUTE | 028-018-000 |
| 1112 | 870-2372-08 | D   | 10206125537   | STC  | -     | EROUTE | 028-018-000 |
| 1113 | 870-2360-06 | C   | 10206255064   | GPSM | 1024M | EOAM   | 128-018-000 |
| 1114 | TDM         |     |               |      |       |        |             |
| 1115 | 870-2360-06 | C   | 10206255165   | GPSM | 1024M | EOAM   | 128-018-000 |
| 1116 | TDM         |     |               |      |       |        |             |
| 1117 | MDAL        |     |               |      |       |        |             |
| 1118 | Empty       |     |               |      |       |        |             |
| 1201 | Empty       |     |               |      |       |        |             |
| 1202 | Empty       |     |               |      |       |        |             |
| 1203 | Empty       |     |               |      |       |        |             |
| 1204 | Empty       |     |               |      |       |        |             |
| 1205 | Empty       |     |               |      |       |        |             |
| 1206 | Empty       |     |               |      |       |        |             |
| 1207 | Empty       |     |               |      |       |        |             |
| 1208 | Empty       |     |               | DCM  |       | STPLAN |             |
| 1209 | MUX         |     |               |      |       | HIPR   | 128-016-000 |
| 1210 | MUX         |     |               |      |       | HIPR   | 128-016-000 |
| 1211 | Empty       |     |               |      |       |        |             |
| 1212 | Empty       |     |               |      |       |        |             |
| 1213 | Empty       |     |               |      |       |        |             |
| 1214 | Empty       |     |               |      |       |        |             |

**Legend**

**FRAME**—Frame ID for the control shelf or an extension shelf

**POWER THRESHOLD**—The power threshold (in Amps or Milliamps and Watts) at which an alarm is generated to indicate that power consumption is approaching a maximum allowed level. (See the **ent-frm-pwr** command.)

**POWER CONSUMPTION**—The current calculated power consumption (in Amps or Milliamps and Watts) of the frame or card

**CARD**—Card Location

**PART NUMBER**—Board Part Number

**REV**—Board Part Number revision

**SERIAL NUMBER**—Card serial number

**TYPE**—Card type

**DB**—Daughterboard memory

**APPL**—Application that has been provisioned on the card

**GPL VERSION**—GPL version of the Application GPL being used by the card

## rtrv-stpopts

## Retrieve STP Options

Use this command to retrieve the current value of the system's node-level processing option indicators maintained in the system's options table.

**Keyword:** rtrv-stpopts

**Related Commands:** chg-stpopts

**Command Class:** Database Administration

### Parameters

This command has no parameters.

### Example

```
rtrv-stpopts
```

### Dependencies

None

### Notes

The timer output for this command is in milliseconds, even though the timer could have been entered in seconds on the **chg-stpopts** command.

**Output**

The following example displays MTP STP options with no affecting features on. Certain features that are shown in other examples control changes and additional options in this option list:

```
rtrv-stpopts
rlghncxa03w 08-09-17 16:02:05 EST EAGLE 39.2.0
STP OPTIONS
-----
MTP31CTL                1
MTPPLTI                 yes
MTPPLTCTDPCQ           3
MTPPLTST                10000
MTPDPCQ                 2000
TFATFRPR                1000
MTPPLPRST               yes
MTPPT10ALT              30000
UIMRD                   yes
SLSCNV                  perls
CRITALMINH              yes
DISPACTALMS             no
NPCFMTI                 14-0-0-0
RPTLNPMRSS              yes
RANDSLS                 off
RSTRDEV                 on
HSCLKSRC                 RS422
HSCLKGAIN                LONGHAUL
ARCHBLDID               off
;
```

The following example displays all MTP STP options. The following list indicates which options appear in the output when the associated features are on:

**NOTE: All options will not appear in actual output, because all features that cause these options to appear cannot be on in the system at the same time.**

- Cluster Routing and Management Diversity (CRMD) feature—MTPXLQ, MTPXLET, MTPXLOT
- MTP Restart (MTPRS or ITUMTPRS) feature—MTPRSI, MTPRSIT
- 6000, 7000, or 8000 Routesets feature—MTPDPCQ=6000 or 7000 or 8000
- GSM MAP Screening (GSMSCRN) feature—GSMDFLT, GSMDECERR
- GSM Mobile Number Portability (G-Port), IS41 to GSM Migration (IGM), Prepaid SMS Intercept (PPSMS) Ph1, Voice Mail Router (V-Flex), Prepaid IDP Query Relay (IDPR), ANSI-41 Mobile Number Portability (A-Port), or any TIF feature is enabled **OR** INAP Number Portability (INP) or GSM Flexible Numbering (G-Flex) feature is ON—DEFCC, DEFNDC
- ATINP feature is enabled—DEFCC
- EPAP-based features or LNP ELAP Configuration feature—DSMAUD
- GSM Flexible Numbering (G-Flex) feature—ANSIGFLEX
- Network Security (NSE) feature—SECMTPMATE, SECMTPSID, SECMTPSNM, SECSCCPSCMG

- ANSI-ITU-China SCCP Conversion (SCCP Conversion) feature is enabled—CNVCGDA, CNVCGDI, CNVCGDN, CNVCGDN24, GTCNVDFLT

**rtrv-stpopts**

```

rlghncxa03w 08-09-17 16:02:05 EST  EAGLE 39.2.0
STP OPTIONS
-----
MTPT31CTL          1
MTPLTI             yes
MTPLTCTDPCQ       3
MTPLTST           10000
MTPXLQ             500
MTPXLET            0100
MTPXLOT            90%
MTPDPCQ            8000
TFATFRPR           1000
MTPRSI             yes
MTPRSIT            5000
MTPLPRST           yes
MTPT10ALT          30000
UIMRD              yes
SLSCNV             perls
CRITALMINH         yes
DISPACTALMS        no
NPCFMTI            14-0-0-0
GSMDFLT            PASS
GSMDECERR          PASS
DEFCC              49
DEFNDC             177
DSMAUD             no
RPTLNPMRSS        yes
RANDSLS            all
RSTRDEV            on
SECMTPMATE         off
SECMTPSID          off
SECMTPSNM          notify
SECSCCPSCMG       notify
CNVCGDA            yes
CNVCGDI            yes
CNVCGDN            yes
CNVCGDN24          yes
GTCNVDFLT         yes
ANSIGFLEX          yes
HSCLKSRC           RS422
HSCLKLL            LONGHAUL
ARCHBLDID          off

```

;

**Legend**

**MTPT31CTL**—MTP T31 congestion trigger level. The signaling link congestion level at which the system starts the level 3 t31 timer. When the level 3 t31 timer expires, the associated signaling link is removed from service for realignment.

**MTPLTI**—MTP loop test indicator. Specifies whether the MTP loop detection procedures are enabled or disabled at the system.

**MTPLTCTDPCQ**—MTP loop test congestion trigger DPC quantity. The number of most frequently occurring DPCs to which the MTP loop test messages are to be sent when the MTP loop test is triggered by congestion.

**MTPLTST**—MTP loop test supervision timer. The amount of time, in milliseconds, that the MTP loop test detection procedures run when started.

**MTPXLQ**—MTP x-list quantity. The number of dynamic status exception list (x-list) entries the system maintains.

**MTPXLET**—MTP x-list expiration time. The maximum amount of time the system maintains an unreferenced dynamic status exception list (x-list) entry.

**MTPXLOT**—MTP x-list occupancy threshold. The dynamic status exception list (x-list) occupancy threshold at which the system raises a minor alarm. The threshold is expressed as a percentage of space available.

**MTPDPCQ**—MTP destination point code quantity. The maximum number of DPCs that can be provisioned in the system.

**TFATFRPR**—TFA/TFR pacing rate. The amount of time, in milliseconds, between partial broadcasts of up to 20 percent increments of the number of TFAs/TCAs or TFRs/TCRs to be broadcast by the STP when an affected destination becomes accessible using its primary route rather than an alternate route. The STP uses this pacing to prevent congestion on the newly-recovered linksets.

**MTPRSIT**—MTP Restart isolation timer. The minimum duration of node isolation, in milliseconds, before the MTP Restart procedure is deemed necessary.

**MTPRSI**—MTP Restart indicator. Specifies whether ANSI or ITU MTP Restart procedures are enabled or disabled at the STP.

**MTPLPRST**—MTP low priority route set test. Specifies whether low priority route set polling is enabled or disabled at the STP.

**MTPT10ALT**—MTP T10 alternate timer. Specifies the interval at which the STP performs a route set test on low priority routes.

**SLSCNV**—Per node SLS conversion indicator. Specifies whether SLS conversion is on, off, or performed per linkset (perls).

**UIMRD**—Unsolicited Information Message (UIM) redirect. Specifies whether specific UIMs are redirected to this output group.

**CRITALMINH**—Indicates whether the option that allows the inhibiting of critical alarms is enabled (yes) or disabled (no).

**DISPACTALMS**—Indicates whether to display active or total alarms in the alarm status area of the VT320 screen.

**NPCFMTI**—Defines how the ITU national point code is entered into the database and how it is displayed in any outputs from the system.

**GSMDFLT**—Indicates whether the GSM MAP screening default action is set to pass or discard.

**GSMDECERR**—Indicates whether the GSM MAP screening decode error action is set to pass or discard.

**DEFCC**—Defines the default country code.

**DEFNDC**—Defines the default network destination code.

**DSMAUD**—Indicates whether the DSM audit is running (on) or disabled (off).

**RANDSLS**—Displays the Random SLS setting.

**RTPLNPMRSS**—Displays the setting for reporting or suppressing UIM 1049 for LNP MR with missing subsystems.

**RSTRDEV**—Allow or disable restoration of device states when an **init-sys** command is executed, an OAM role changes, or a card reload occurs.

**SECMTPMATE**—Indicates Network Security screening for MTP messages received by an STP on a non-C-Link, with an OPC equal to the SID (True, Adjacent, or Capability) point code of its mate.

**SECMTPSID**—Indicates Network Security screening for MTP messages received at MTP3 containing an OPC equal to its own SID (OPC that is the True, Secondary, or Capability point code entered in the **chg-sid** command) that is not a route-set-congestion-message. The EAGLE 5 ISS should not receive a message with its own OPC unless the message is a result of a circular route test or is an SLTM when the far end is in loopback. (SLTM messages are not checked.)

**SECMTPSNM**—Indicates Network Security screening for MTP SNM messages. The EAGLE 5 ISS should not receive an MTP network management message unless:

- The OPC is an adjacent point code. (For all link types, this rule does not apply to UPU, TFC, and RCT messages.)
- The EAGLE 5 ISS has a route to the OPC of the MTP network management message on the linkset which the message was received.
- The EAGLE 5 ISS has a route to the destination field in the message (if applicable to the concerned message) on the linkset which the message was received. (For all link types, this rule is not applicable to RST messages.)

**SECSCCPSCMG**—Indicates Network Security screening for SCCP SCMG messages. This value applies only to SSP and SOR messages. SSA, SST, SOG, SBR, SNR and SRT messages are not affected. The EAGLE 5 ISS should not receive an SCCP network management message unless:

- The EAGLE 5 ISS has a route to the OPC of the SCMG message on the linkset on which the message was received.
- The EAGLE 5 ISS has a route to the Affected Point Code (also called the Concerned Point Code in EAGLE 5 ISS) in the message on the linkset on which the message was received.

**CNVCGDA**—Indicates whether or not to discard the CGPA PC in SCCP messages if the destination network type is ANSI, and the PC or ALIAS PC of the destination network type is not defined.

**CNVCGDI**—Indicates whether or not to discard the CGPA PC in SCCP messages if the destination network type is ITU-I, and the PC or ALIAS PC of the destination network type is not defined.

**CNVCGDN**—Indicates whether or not to discard the CGPA PC in SCCP messages if the destination network type is ITU-N, and the PC or ALIAS PC of the destination network type is not defined.

**CNVCGDN24**—Indicates whether or not to discard the CGPA PC in SCCP messages if the destination network type is 24-bit ITU-N, and the PC or ALIAS PC of the destination network type is not defined.

**ANSIGFLEX**—Indicates enable or disable of ANSI G-Flex to execute at 1700 TPS per DSM card

**GTCNVDFLT**—Indicates enable or disable of routing of SCCP messages using system defaults when an appropriate entry is not found in the Default GT Conversion table.

**HSCLKLL**—High speed master clock line length option (SHORTHAUL, LONGHAUL)

**HSCLKSRC**—High speed master clock source

**ARCHBLDID**—Archive build ID

## rtrv-subnetid

## Retrieve Subnet ID

Use this command to retrieve a list of Subnet ID entries from the SUBNETID table, for the ISUP NP with EPAP feature.

**Keyword:** **rtrv-subnetid**

**Related Commands:** **dlt-subnetid**, **ent-subnetid**

**Command Class:** Database Administration



**Parameters**

**:subnetnum=** (optional)  
 Subnet Number  
**Range: 1-5**

**Example**

```
rtrv-subnetid
rtrv-subnetid : subnetnum = 1
```

**Dependencies**

The ISUP NP with EPAP feature must be enabled before this command can be entered.

**Notes**

None.

**Output**

When the command is entered with no parameter, the Subnet IDs for Subnet number 1 are listed in numerical order, followed by the Subnet IDs for Subnet number 2 in numerical order, and so on.

```
rtrv-subnetid
tekelecstp 04-09-21 16:11:21 EST EAGLE 31.11.0
      Subnet
      ID      Number
      -----
      886932      1
      886936      1
      886935      2
      886938      2
      886939      2

Subnetidlen = 6

SUBNETID table is (5 of 50) 3% full

;
```

When a Subnet number is specified, the Subnet IDs for the specified Subnet number are listed in numerical order. The table capacity line shows the total number of entries in use, not just the number of entries displayed.

```
rtrv-subnetid:subnetnum=2
tekelecstp 04-09-21 16:13:54 EST EAGLE 31.11.0
      Subnet
      ID      Number
      -----
      886935      2
      886938      2
      886939      2

Subnetidlen = 6

SUBNETID table is (5 of 50) 3% full

;
```

**rtrv-t1****Retrieve T1 Information**

Use this command to retrieve information for a specified T1 interface or for all T1 interfaces that have been defined by the **ent-t1** command for an E1/T1 MIM card or an HC-MIM or E5-E1T1 card that is used as a T1 or ST-HSL-A card.

**NOTE: The following information can be retrieved: card location, T1 port number, encoding/decoding, channel bridging, timing source, framing, line length, and link class with minimum signal unit rate for unchannelized links.**

**Keyword:** rtrv-t1

**Related Commands:** chg-t1, dlt-t1, ent-t1, tst-t1

**Command Class:** Database Administration

**Parameters**

**:loc=** (optional)

The card location as stenciled on the shelf of the system.

**Range:** 1101-1108, 1111-1112, 1201-1208, 1211-1218, 1301-1308, 1311-1318, 2101-2108, 2111-2118, 2201-2208, 2211-2218, 2301-2308, 2311-2318, 3101-3108, 3111-3118, 3201-3208, 3211-3218, 3301-3308, 3311-3318, 4101-4108, 4111-4118, 4201-4208, 4211-4218, 4301-4308, 4311-4318, 5101-5108, 5111-5118, 5201-5208, 5211-5218, 5301-5308, 5311-5318, 6101-6108, 6111-6118

**Default:** If not specified, all T1 card locations are listed.

**:t1port=** (optional)

T1 port number. The value must be a T1 port that has already been configured with a T1 interface on the specified T1 card (**loc** parameter).

**Range:** 1-8  
Ports 3-8 are valid only for HC-MIM and E5-E1T1 cards.

**Default:** If not specified, all T1 ports are listed.

**Example**

```
rtrv-t1
rtrv-t1:loc=1307:t1port=2
rtrv-t1:loc=1311:t1port=1
```

**Dependencies**

The **loc** and **t1port** parameters must be specified together, if any parameters are specified for the command.

The T1 interface of the T1 card specified by the **loc** parameter must already be defined (see the **ent-t1** command) before this command can be entered.

The card specified by the **loc** parameter must be a **limt1** card type.

The port specified by the **t1port** parameter on the card specified by the **loc** parameter must be already equipped with a T1 interface.

**Notes**

None.

Output

```

rtrv-t1
rlghncxa03w 09-03-20 09:07:58 EST EAGLE 41.0.0
      T1
      LINK MINSU
LOC  PORT ENCODE  T1TSEL  FRAMING  LL  CHANBRDG  CLASS  RATE
1211 1    ami     external esf     10  -----  CHAN  ----
1307 2    b8zs    line     sf      133  -----  CHAN  ----
1311 1    ami     external esf     500  -----  CHAN  ----
;

```

```

rtrv-t1:loc=1311:t1port=1
rlghncxa03w 09-03-20 09:07:58 EST EAGLE 41.0.0
      T1
      LINK MINSU
LOC  PORT ENCODE  T1TSEL  FRAMING  LL  CHANBRDG  CLASS  RATE
1211 1    ami     external esf     100  -----  CHAN  ----

TS1 1311,A    TS9 1313,B    TS17 -----
TS2 1311,A1  TS10 -----  TS18 -----
TS3 1311,B1  TS11 -----  TS19 -----
TS4 1311,B3  TS12 1313,B3  TS20 -----
TS5 1312,A    TS13 -----  TS21 -----
TS6 -----  TS14 -----  TS22 -----
TS7 1313.A   TS15 -----  TS23 -----
TS8 1313.A   TS16 -----  TS24 -----
;

```

The following example includes information for HC-MIM T1 cards. Ports 3 and 4, 5 and 6, and 7 and 8 on the card in location 1311 are channel-bridged pairs.

```

rtrv-t1
rlghncxa03w 09-04-04 09:07:58 EST EAGLE5 41.0.0
      T1
      LINK MINSU
LOC  PORT ENCODE  T1TSEL  FRAMING  LL  CHANBRDG  CLASS  RATE
1211 1    ami     external esf     10  -----  CHAN  ----
1307 2    b8zs    line     sf      133  -----  CHAN  ----
1307 6    b8zs    line     sf      133  -----  CHAN  ----
1311 1    ami     external esf     500  -----  CHAN  ----
1311 2    ami     external esf     500  -----  CHAN  ----
1311 3    ami     external esf     500  MASTER  CHAN  ----
1311 4    ami     external esf     500  SLAVE   CHAN  ----
1311 5    ami     RECOVERED esf     500  MASTER  CHAN  ----
1311 6    ami     RECOVERED esf     500  SLAVE   CHAN  ----
1311 7    ami     recovered sf      500  MASTER  CHAN  ----
1311 8    ami     recovered sf      500  SLAVE   CHAN  ----
;

```

The following example shows information for port 5 on the card in location 1311. Port 5 is the master port of a channel-bridged pair of ports (5 and 6) on the card.

```

rtrv-t1:loc=1311:t1port=5
rlghncxa03w 09-04-04 09:07:58 EST EAGLE5 41.0.0
      T1
      LINK MINSU
LOC  PORT ENCODE  T1TSEL  FRAMING  LL  CHANBRDG  CLASS  RATE
1311 5    ami     RECOVERED esf     500  MASTER  CHAN  ----

TS1 1311,A    TS9 1311,B18  TS17 -----
TS2 1311,A1  TS10 -----  TS18 -----
TS3 1311,B1  TS11 -----  TS19 -----
TS4 1311,B3  TS12 1311,B31  TS20 -----
TS5 1311,A12  TS13 -----  TS21 -----
TS6 -----  TS14 -----  TS22 -----
TS7 1311,A21  TS15 -----  TS23 -----
TS8 1311,A31  TS16 -----  TS24 -----
;

```

The following example shows information for port 6 on the card in location 1311. Port 6 is channel bridged with port 5 for data pass-through.

**rtrv-t1:loc=1311:t1port=6**

```
rlghncxa03w 09-04-02 09:07:58 EST EAGLE5 41.0.0
      T1
LOC  PORT ENCODE  T1TSEL   FRAMING  LL   CHANBRDG  CLASS  RATE
1311 6    B8ZS   recovered SF      135  SLAVE     CHAN   ----
```

Card 1311, port 6 is channel bridged with port 5 for data pass through.

;

The following example shows E5-E1T1 cards used as T1 cards. Cards with unchannelized linksets have ST-HSL-A links.

**rtrv-t1**

```
rlghncxa03w 09-04-02 09:07:58 EST EAGLE5 41.0.0
      T1
LOC  PORT ENCODE  T1TSEL   FRAMING  LL   CHANBRDG  CLASS  RATE
1211 1    ami    external esf      10  -----  UNCHAN 1000
1307 2    b8zs   line     sf      133  -----  UNCHAN 2000
1311 1    ami    external esf      500  -----  CHAN   ----
```

;

**Legend**

**LOC**—T1 card location in an EAGLE 5 ISS shelf.

**T1PORT**—T1 port number on a T1 card.

**ENCODE**—Indicator for use of B8ZS or AMI encoding/decoding.

**T1TSEL**—T1 timing source indicator (**external** = master timing source; **line** = slave timing source; **recovered** = the timing source for the even-numbered port in a channel bridged pair is recovered from the odd-numbered port of the pair).

**FRAMING**—Framing format (SF or ESF).

**LL**—Line length; T1 cable length in feet between the EAGLE 5 ISS and the connecting node

**CHANBRDG**—Indicates whether an odd numbered port is not channel bridged with its adjacent even numbered port for non-signaling data pass through (dashes), or the port is the odd-numbered channel bridged port on the card (MASTER), or the port is the even-numbered channel bridged port on the card (SLAVE) on an HC-MIM or E5-E1T1 card.

**LINKCLASS**—Indicates whether an HC-MIM or E5-E1T1 card is used as a "channelized" T1 Card (CHAN) or an "unchannelized" ST-HSL-A card (UNCHAN).

**MINSURATE**—Minimum number of signaling units present on a link uniformly distributed. A value appears in this field only when the LINKCLASS field value is UNCHAN.

**TSx**—Timeslot.

**rtrv-tatr-msg**

**Retrieve Configured TATR messages**

Use this command to display the configured Triggerless ANSI TCAP Relay message parameter values.

**Keyword:** rtrv-tatr-msg

**Related Commands:** chg-tatr-msg, tst-msg

**Command Class:** Database Administration

**Parameters**

**:msgn=** (optional)

Message number. This parameter specifies the number of the TATR message.

**Range: 1-10**

**Example**

```
rtrv-tatr-msg:msgn=1
```

**Dependencies**

None.

**Notes**

None.

**Output**

```
rtrv-tatr-msg:msgn=1
tekelecstp 09-06-26 13:46:01 EST 41.1.0
rtrv-tatr-msg:msgn=1
Command entered at terminal #4.
MSG = 1          ACTIVE = NO
      TRIGTYPE = h'25

      CGPA_GT = 2
      CGPA_GT_NAI = 4      CGPA = 0123456789abcde

      CDPA_GT = 2
      CDPA_GT_NAI = 4      CDPA = 0123456789abcde

      CGPN_NAI = 1          CGPN = 01234567890abcdef
      CDPN_NAI = 1          CDPN = 01234567890abcdef

;
```

**rtrv-tatropts****Retrieve TATR Options**

Use this command to display all of the Triggerless ANSI TCAP Relay options that are configured in the database.

**Keyword:** rtrv-tatropts

**Related Commands:** chg-tatropts

**Command Class:** Database Administration

**Parameters**

This command has no parameters.

**Example**

```
rtrv-tatropts
```

**Dependencies**

None.

**Notes**

None.

**Output**

```

rtrv-tatropts
tekelecstp 09-08-26 15:15:20 EST EAGLE 41.1.0

TATR OPTIONS
-----
CDNPTYPE      = rnspl
CGNPTYPE      = rnspl
CGPACCK       = nonintl
SPORTTYPE     = none
DFLTRN        = none

i

```

**rtrv-tbl-capacity****Retrieve Table Capacity**

Use this command to retrieve table use capacity summary information. For each table listed, the number of table entry elements in use and the total allowed number of table elements is presented, along with a percent (%) full value.

**Keyword:** rtrv-tbl-capacity

**Related Commands:** rept-stat-xlist, rtrv-appl-rtkey, rtrv-as, rtrv-assoc, rtrv-dstn, rtrv-gta, rtrv-gtt, rtrv-ip-host, rtrv-ip-lnk, rtrv-ls, rtrv-map, rtrv-scrset, rtrv-slk, rtrv-spc, rtrv-vflx-cd, rtrv-vflx-rn, rtrv-vflx-vmsid, rtrv-x25-dstn, rtrv-x25-slk

**Command Class:** Database Administration

**Parameters**

This command has no parameters.

**Example**

```
rtrv-tbl-capacity
```

**Dependencies**

None

**Notes**

This command can be canceled using the **F9** function key or the **canc-cmd** command. See **canc-cmd** for more information.

XLIST table information is shown only if the CRMD feature is ON.

Secondary Point Code (SPC) table information is shown only if the MPC feature is ON.

If the EGTT feature is ON then table name is GTA instead of GTT.

Additional information for each listed table can be displayed using the commands listed in Table 5-81.

Though the ASP table entries are now part of the IPAPSOCK table, EAGLE 5 ISS command entry and output still appear as though they are separate tables. The **rtrv-tbl-capacity** command shows the number of ASPs in the 4000-entry IPAPSOCK table.

**Table 5-81.** Retrieve Commands for Additional Table Information

| <b>Command</b>         | <b>Table name</b> | <b>Description of table</b>              |
|------------------------|-------------------|------------------------------------------|
| <b>rpt-stat-xlist</b>  | XLIST             | Destination - Routeset Extension         |
| <b>rtrv-appl-rtkey</b> | IPRTKEY           | IP Routing Key                           |
| <b>rtrv-as</b>         | AS                | Application Server                       |
| <b>rtrv-assoc</b>      | IPAPSOCK          | IP Socket/Association                    |
| <b>rtrv-dstn</b>       | DSTN              | Destination Routeset, Exception Routeset |
| <b>rtrv-gta</b>        | GTA               | Global Title Address                     |
| <b>rtrv-gtt</b>        | GTT               | Global Title Translation                 |
| <b>rtrv-ip-host</b>    | IP-HOST           | IP Host                                  |
| <b>rtrv-ip-lnk</b>     | IP-LNK            | Internet Process Link                    |
| <b>rtrv-ls</b>         | LS                | Link Set                                 |
| <b>rtrv-map</b>        | MAP               | Mated Application                        |
| <b>rtrv-mrn</b>        | MRN               | Mated Relay Node                         |
| <b>rtrv-npp-as</b>     | NPP-AS            | Numbering Plan Processor                 |
| <b>rtrv-npp-srs</b>    | NPP-SRS           | Numbering Plan Processor                 |
| <b>rtrv-scrset</b>     | SCRSET            | Gateway Screening Screen Set             |
| <b>rtrv-slk</b>        | SLK               | Signal Link                              |
| <b>rtrv-spc</b>        | SPC               | Secondary Point Code                     |
| <b>rtrv-vflx-cd</b>    | VFLXCD            | V-Flex Call Decision                     |
| <b>rtrv-vflx-rn</b>    | VFLXRN            | V-Flex Routing Number                    |
| <b>rtrv-vflx-vmsid</b> | VFLXVID           | V-Flex VMSID                             |
| <b>rtrv-x25-dstn</b>   | X25-DSTN          | X.25 Destination                         |
| <b>rtrv-x25-slk</b>    | X25-SLK           | X.25 Signal Link                         |

The MRN table capacity value is adjusted to subtract any point code values allocated to support the SCCP-SERV reroute service.

V-Flex Call Decision (VFLXCD), Routing Number (VFLXRN) and VMSID (VFLXVID) table information is shown only if the V-Flex feature is enabled.

**Output**

The following example shows the output for the minimum table sizes in the system when CRMD, MPC, EGTT and VFLEX features are off.

**rtrv-tbl-capacity**

```
tekelecstp 09-08-05 23:11:49 EST EAGLE 41.1.0

DSTN      table is (      8 of      2000)  1% full
X25-DSTN  table is (      0 of      1024)  0% full
LS        table is (      6 of      1024)  1% full
SLK       table is (     12 of      1200)  1% full
X25-SLK   table is (      0 of       256)  0% full
IP-LNK    table is (      0 of       512)  0% full
IP-HOST   table is (      2 of     2048)  1% full
MAP       table is (      8 of      1024)  1% full
MRN       table is (      0 of     3000)  0% full
SCCPSRV   table is (      0 of       384)  0% full
GTT       table is (      0 of    269999)  0% full
GTT-SET   table is (     21 of      2000)  2% full
SSNSELID  table is (      0 of    100000)  0% full
SCRSET    table is (      0 of       255)  0% full
RTEKEY    table is (      0 of      1000)  0% full
APPLSOCK  table is (      0 of      4000)  0% full
AS        table is (      0 of       250)  0% full
NPP-AS    table is (      0 of      1024)  0% full
NPP-SRS   table is (      0 of     8192)  0% full
```

;

The following example shows the output for the maximum table sizes in the system. For the DSTN, SLK, GTT, and MAP tables, maximum values depend on the enabled feature quantity value applicable to the table in the system. GTT, MPC, CRMD, VFLEX and FGTTLS features are turned on.

**rtrv-tbl-capacity**

```
tekelecstp 09-08-05 23:28:15 EST EAGLE 41.1.0

DSTN      table is (    600 of     8000)  10% full
XLIST     table is (      0 of       500)  0% full
X25-DSTN  table is (      0 of      1024)  0% full
SPC       table is (      0 of        40)  0% full
LS        table is (     512 of      1024)  50% full
SLK       table is (    1501 of      2800)  54% full
X25-SLK   table is (      0 of       256)  0% full
IP-LNK    table is (      0 of       512)  0% full
IP-HOST   table is (      0 of     2048)  0% full
MAP       table is (    1500 of    36000)  5% full
MRN       table is (      0 of     3000)  0% full
SCCPSRV   table is (      0 of       384)  0% full
GTA       table is (      0 of    269999)  0% full
GTT-SET   table is (     10 of      2000)  1% full
SSNSELID  table is (      0 of    100000)  0% full
SCRSET    table is (     25 of       255)  10% full
RTEKEY    table is (      0 of      1000)  0% full
APPLSOCK  table is (      0 of      4000)  0% full
AS        table is (      0 of       250)  0% full
VFLXCD    table is (      1 of      4950)  1% full
VFLXRN    table is (      1 of    10000)  1% full
VFLXVID   table is (      1 of      1000)  1% full
NPP-AS    table is (      0 of      1024)  0% full
NPP-SRS   table is (      0 of     8192)  0% full
```

;



In the following example, the MRN table limit is 3000 entries and 12 entries are used for SCCP-SERV reroute.

**rtrv-tbl-capacity**

```
tekelecstp 09-08-05 23:28:15 EST EAGLE 41.1.0

DSTN      table is (      5940 of      6000) 99% full
XLIST     table is (         0 of       500)  0% full
X25-DSTN  table is (         0 of     1024)  0% full
SPC       table is (         4 of       40) 10% full
LS        table is (       738 of     1024) 72% full
SLK       table is (       360 of     2000) 18% full
X25-SLK   table is (         0 of     256)  0% full
IP-LNK    table is (         6 of     512)  1% full
IP-HOST   table is (        58 of    2048)  3% full
MAP       table is (       336 of     1024) 33% full
MRN       table is (       768 of     2988) 26% full
SCCPSRV   table is (        12 of      96) 13% full
GTA       table is (  269999 of 269999) 100% full
GTT-SET   table is (        10 of     2000)  1% full
SSNSELID  table is (         0 of    10000)  0% full
SCRSET    table is (        40 of     255) 16% full
RTEKEY    table is (         0 of     1000)  0% full
APPLSOCK  table is (         0 of     4000)  0% full
AS        table is (         0 of     250)  0% full
VFLXRN    table is (         1 of    10000)  1% full
VFLXCD    table is (         1 of     4950)  1% full
VFLXVID   table is (         1 of     1000)  1% full
NPP-AS    table is (         6 of     1024)  1% full
NPP-SRS   table is (         0 of    8192)  0% full
```

;

**rtrv-th-alm**

**Retrieve Alarm Thresholds**

Use this command to retrieve the alarm thresholds and associated values. For additional information on these values, refer to the *Database Administration Manual - SS7* in your EAGLE 5 ISS documentation set.

**Keyword:** rtrv-th-alm

**Related Commands:** chg-th-alm, rept-stat-sccp

**Command Class:** Database Administration

**Parameters**

This command has no parameters.

**Example**

```
rtrv-th-alm
```

**Dependencies**

None

**Notes**

None

**Output****rtrv-th-alm**

```

tekelecstp 09-07-23 13:14:44 EST  EAGLE 41.1.0
Thermal Alarm Level 1:                92%
Thermal Alarm Level 2:                99%
SCCP TPS Threshold:                   80%
SCCP Calculation Method:              N
LNP TN  DB Alarm Level 1:             80%
LNP TN  DB Alarm Level 2:             95%
GTT SCCP Service Alarm Level 1:       10%
GTT SCCP Service Alarm Level 2:       20%
Non-GTT SCCP Service Alarm Level 1:   10%
Non-GTT SCCP Service Alarm Level 2:   20%
SCCP Service Alarm Level 1 Interval:   15
SCCP Service Alarm Level 2 Interval:   50
IMT Bus Combined Utilization Alarm Level 1: 70%
IMT Bus Combined Utilization Alarm Level 2: 80%
IMT Bus Congestion Alarm Level 1:     60%
IMT Bus Congestion Alarm Level 2:     75%
RTRV-TH-ALM: MASP A - COMPLTD.

```

;

**rtrv-tifopts****Retrieve TIF Options**

Use this command to retrieve the current values of the TIF option indicators from the TIFOPTS table.

**Keyword:** rtrv-tifopts

**Related Commands:** chg-tifopts

**Command Class:** Database Administration

**Parameters****Example**

```
rtrv-tifopts
```

**Dependencies**

None

**Notes**

The NSADDLDATA and NSPUBLIC options are displayed only when the TIF Number Substitution feature is enabled.

**Output**

**rtrv-tifopts**

```
tekelecstp 09-06-10 12:32:21 EST EAGLE 41.1.0
Command entered at terminal #4.
```

TIF OPTIONS

```
-----
IAMCGPN      = dn
NPFLAG       = none
RCAUSENP     = 0
RCAUSEPFX    = 0
NPTYPEPERLS  = sprn
NPTYPEPERLY  = sprn
NPTYPEPCGPN  = sprn
SPLITIAM     = none
CONDCGPN     = none
CRPREL       = 31
RNRQD        = yes
DFLTRN       = none
DLMA         = none
DLMB         = none
DLMC         = none
SNSCGPNDFLT = none
MATCHSEQ     = dn
SPORTRLS     = all
SPORTRELAY   = gsm
SPFILL       = on
RLCOPC       = off
NSADDLDATA   = yes
NSPUBLIC     = 5
```

;

**rtrv-tinpopts**

**Retrieve TINP Options**

Use this command to retrieve the current values of the TINP option indicators from the TINPOPTS table.

**NOTE: This command is obsolete.**

**Keyword:** rtrv-tinpopts

**Related Commands:** chg-tinpopts

**Command Class:** Database Administration

**Parameters**

None

**Example**

```
rtrv-tinpopts
```

**Dependencies**

None

**Notes**

None

**Output**

```

rtrv-tinpopts
tekelecstp 08-02-07 16:16:27 EST EAGLE 38.0.0
Command entered at terminal #4.

TINP OPTIONS

-----
IAMACT                relay
DNFMT                 rn
DNNAI                 none
IAMCGPN               none
NPTYPE                sprn
SNAI                  iamnai
NPFLG                 nm
RCAUSENP              127
RCAUSEPFX             0
DLTHOMERN             always
;

```

**rtrv-trbl****Retrieve Trouble**

Use this command to display detailed information for one or more troubles that are currently logged into the system.

**Keyword:** rtrv-trbl

**Related Commands:** act-alm-trns, dact-alm-trns, rept-stat-alm, rept-stat-clk, rept-stat-trbl, rls-alm, rtrv-obit

**Command Class:** System Maintenance

**Parameters**

**:loc=** (mandatory)

The address of the card that is running the OAM from which logged trouble reports are to be displayed.

**Range:** 1113, 1115

**:mode=** (optional)

Display mode

**Range:** c, m

**c**—Continuous mode; shows troubles already logged and new troubles as they occur.

**m**—Manual mode; shows troubles on demand only

**Default:** c

**:num=** (optional)

Indicates how many troubles to display.

**Range:** 1-99

**Example**

```
rtrv-trbl:loc=1113:num=2
```

**Dependencies**

At least one trouble must be in the trouble log, or the command is rejected.

Only one **rtrv-trbl** or **rtrv-obit** command can be in progress at a time.

If the **mode** parameter is specified without the **num** parameter, the entire log is displayed.

The card specified by the **loc** parameter must be **1113** or **1115**.

If the **loc** parameter specifies the card that is running the standby OAM, that card must be available. The **num** parameter must be between **1** and **99**.

### Notes

When a trouble is generated in the system, it is logged into the RAM storage area of the active OAM. Each OAM can store up to 99 troubles in a queue. If the OAM resets, logged troubles are lost.

### Output

The output from this command should be reviewed with a member of the Tekelec Technical Services Team. You can contact Tekelec Technical Services at (888) FOR-TKLC.

```
rtrv-trbl:loc=1113:num=2
rlghncxa03w 03-03-07 08:47:43 EST EAGLE 31.3.0
Card 1113 Module 0000 Mod_loc 0 Class 0000 Severity 0
Report Date:00-00-00 Time:00:00:00

rlghncxa03w 03-03-07 08:47:43 EST EAGLE 31.3.0
Card 1108 Module 8001 Mod_loc 6 Class 100A Severity 1
Report Date:03-03-04 Time:09:19:59
;
```

## rtrv-trbltx

## Retrieve Trouble Text Table Entries

Use this command to retrieve Alarm and UIM message information including MRN (message reference number), level (for Alarms), Output Group, and text.

The default report displays all Alarms (in numerical order) and then all UIMs.

The optional parameters can be used to:

- Display a range of Alarms or UIMs (ranges spanning both Alarms and UIMs are not supported)
- Search for Alarms, UIMs, or both message types matching a specific Output Group
- Sort all entries by Output Group

**Keyword:** rtrv-trbltx

**Related Commands:**

**Command Class:** Database Administration

### Parameters

**:enum=** (optional)

The ending Message Reference Number (MRN) when specifying a range.

**Range:** **1-1499**

**1-999** for Alarms (UAMs)

**1000-1499** for UIMs

**Default:** when **enum** is not specified,

If **snum** is specified, the **enum** value defaults to the specified **snum** value.

If **snum** is not specified and **type=all**, **type=uim**, or **type** not specified, the **enum** value defaults to **1499**

If **snum** is not specified and **type=alarm**, the **enum** value defaults to **999**

**:outgrp=** (optional)

The Output Group to sort or filter the Alarm/UIMs on.

**Range:** **appserv, appss, card, clk, db, dbg, gtt, gws, link, meas, mon, mps, pu, sa, seas, slan, sys, traf**

**appserv** — Application Server  
**appss** — Application Subsystem  
**card** — Card  
**clk** — Clock  
**db** — Database  
**dbg** — Debug  
**gtt** — GTT Maintenance  
**gws** — GWS Maintenance  
**link** — Link Maintenance  
**meas** — Measurements Maintenance  
**mon** — Monitoring (Sentinel or IMF) Maintenance  
**mps** — MPS Maintenance  
**pu** — Program Update  
**sa** — System Administration  
**seas** — SEAS (Sentinel or IMF)  
**slan** — SLAN Maintenance  
**sys** — System Maintenance  
**traf** — Traffic  
**all**—retrieve information for all Output Groups

**Default:** No sorting or filtering is done on Output Groups.

**:snum=** (optional)

A single Message Reference Number (MRN), or the starting MRN when specifying a range.

**Range:** **1-1499**

**1-999**—For Alarms (UAMs)

**1000-1499**—For UIMs

**Default:** All message entries for the specified **type** are displayed.  
 For **type=all**, **type=alarm**, or **type** not specified—**snum** Default: **1**  
 For **type=uim**—**snum** Default: **1000**

**:type=** (optional)

The type of trouble text entry—Alarm, UIM, or both types—to display.

**Range:** **all, alarm, uim**

**all** — Both types are displayed  
**alarm** — Only Alarm entries are displayed  
**uim** — Only UIM entries are displayed

**Default:** **all**

### Example

```
rtrv-trbltx
rtrv-trbltx:type=alarm
rtrv-trbltx:outgrp=sys
rtrv-trbltx:type=alarm:outgrp=all
rtrv-trbltx:snum=1002
```

### Dependencies

If **enum** is specified, **snum** must be specified in the command.

The specified **enum** value must be greater than or equal to the specified **snum** value.

The specified **enum** value must be in the same range as the specified **snum** value (**1-999** for Alarms and **1000-1499** for UIMs). The range cannot span both types.

The specified **snum** and **enum** values must be in the range of the specified **type** (**1-999** for Alarms and **1000-1499** for UIMs).

When the **outgrp** parameter is specified, the **snum** and **enum** parameters cannot be specified.

### Notes

This command can be canceled using the **F9** function key or the **canc-cmd** command. See **canc-cmd** for more information.

To display a single Alarm or UIM, enter the Alarm or UIM MRN as the value of the **snum** parameter. Either do not specify the **enum** parameter or specify the **enum** parameter with the same value as the **snum** value.

If an unused MRN is specified as an **snum** parameter value, the header information is displayed without any Output Group header or MRN information.

If an **snum/enum** range is specified, and there are unused MRNs within that range, only the used MRNs are displayed.

**Output**

The following example shows output when the command has no parameters. All entries are not shown; the list is long:

**rtrv-trbltx**

```
ncralstp00001 03-07-16 10:15:29 EST EAGLE 31.3.0
```

## Alarm Report

| MRN  | LEVEL | OUTPUT GROUP | TEXT                               |
|------|-------|--------------|------------------------------------|
| 0001 | MAJR  | SYS          | Card has reset                     |
| 0002 | MINR  | SYS          | Card is not running approved GPL   |
| 0003 | NONE  | SYS          | Alarm cleared for GPL              |
| .    | .     | .            | .                                  |
| 0912 | NONE  | SYS          | Dynamic database is now consistent |

## UIM Report

| MRN  | OUTPUT GROUP | TEXT                                 |
|------|--------------|--------------------------------------|
| 1000 | SYS          | MTP rcvd UPU - user part is not SCCP |
| 1001 | SYS          | MTP rcvd Transfer Controlled (TFC)   |
| 1002 | SYS          | MTP rcvd invalid TFC - status 0      |
| .    | .            | .                                    |
| 1499 | SYS          | Invalid MRN detected                 |

```
END OF RTRV-TRBLTX REPORT.
```

;

The following example shows the display with **type=alarm**. All entries are not shown; the list is long:

**rtrv-trbltx:type=alarm**

```
ncralstp00001 03-07-16 10:15:29 EST EAGLE 31.3.0
```

## Alarm Report

| MRN  | LEVEL | OUTPUT GROUP | TEXT                               |
|------|-------|--------------|------------------------------------|
| 0001 | MAJR  | SYS          | Card has reset                     |
| 0002 | MINR  | SYS          | Card is not running approved GPL   |
| 0003 | NONE  | SYS          | Alarm cleared for GPL              |
| .    | .     | .            | .                                  |
| 0912 | NONE  | SYS          | Dynamic database is now consistent |

```
END OF RTRV-TRBLTX REPORT.
```

;

The following example shows the display with **type=uim**. All entries are not shown; the list is long:

**rtrv-trbltx:type=uim**

```
ncralstp00001 03-07-16 10:15:29 EST EAGLE 31.3.0
```

## UIM Report

| MRN  | OUTPUT GROUP | TEXT                                 |
|------|--------------|--------------------------------------|
| 1000 | SYS          | MTP rcvd UPU - user part is not SCCP |
| 1001 | SYS          | MTP rcvd Transfer Controlled (TFC)   |



```

1002          SYS          MTP rcvd invalid TFC - status 0
.
.
.
1499          SYS          Invalid MRN detected
END OF RTRV-TRBLTX REPORT.
;

```

The following example shows the display with **outgrp=all**. The complete list of Alarms and UIMs is not shown; it is a long list; examples from each type and several Output Groups are shown.

**NOTE: The output for outgrp=all:type=alarm includes all Output Groups in the Alarm Report only; the output for outgrp=all:type=uim includes all Output Groups in the UIM Report only.**

**rtrv-trbltx:outgrp=all**

```
rlghncxa03w 06-05-27 08:15:10 EST EAGLE 35.0.0
```

Alarm Report

| MRN                 | LEVEL | OUTPUT GROUP | TEXT                               |
|---------------------|-------|--------------|------------------------------------|
| -----               |       |              |                                    |
| Output Group - SYS  |       |              |                                    |
| 0001                | MAJR  | SYS          | Card has reset                     |
| 0002                | MINR  | SYS          | Card is not running approved GPL   |
| .                   | .     | .            | .                                  |
| 0912                | NONE  | SYS          | Dynamic database is now consistent |
| .                   | .     | .            | .                                  |
| Output Group - LINK |       |              |                                    |
| 0155                | MINR  | LINK         | STPLAN connection unavailable      |
| 0156                | NONE  | LINK         | STPLAN connection available        |
| .                   | .     | .            | .                                  |
| 0479                | NONE  | LINK         | Link not Monitored                 |

UIM Report

| MRN                 | LEVEL | OUTPUT GROUP | TEXT                                 |
|---------------------|-------|--------------|--------------------------------------|
| -----               |       |              |                                      |
| Output Group - SYS  |       |              |                                      |
| 1000                |       | SYS          | MTP rcvd UPU - user part is not SCCP |
| 1001                |       | SYS          | MTP rcvd Transfer Controlled (TFC)   |
| .                   | .     | .            | .                                    |
| 1499                |       | SYS          | Invalid MRN detected                 |
| .                   | .     | .            | .                                    |
| Output Group - LINK |       |              |                                      |
| 13nn                |       | LINK         | Example text                         |

```
END OF RTRV-TRBLTX REPORT.
;

```

The following example shows the display for **outgrp=sys**. All entries are not shown; the list is long:

**rtrv-trbltx:type=alarm:outgrp=sys**

```
ncralstp00001 03-07-16 10:15:29 EST EAGLE 31.3.0
```

Alarm Report

```

          MRN      LEVEL  OUTPUT GROUP      TEXT
-----
Output Group - SYS
    0001  MAJR   SYS                Card has reset
    0002  MINR   SYS                Card is not running approved GPL
    .
    .
    .
    0912  NONE   SYS                Dynamic database is now consistent

END OF RTRV-TRBLTX REPORT.
;

```

The following example shows the display for only Alarm MRN 3:

```

rtrv-trbltx:snum=3
ncralstp00001 03-07-16 10:15:29 EST  EAGLE 31.3.0

Card 1113; SYS REL= 31.3.0; STP CLLI= ncralstp00001; Timezone= EST

Alarm Report
          MRN      LEVEL  OUTPUT GROUP      TEXT
-----
    0003  NONE   SYS                Alarm cleared for GPL

END OF RTRV-TRBLTX REPORT.
;

```

The following example shows the display for only UIM MRN 1002:

```

rtrv-trbltx:snum=1002
ncralstp00001 03-07-16 10:15:29 EST  EAGLE 31.3.0

UIM Report
          MRN                OUTPUT GROUP      TEXT
-----
    1002                SYS                MTP rcvd invalid TFC - status 0

END OF RTRV-TRBLTX REPORT.
;

```

## rtrv-trm

## Retrieve Terminal

Use this command to show the port configuration for all TDM terminals or a specified terminal. These ports are used to connect modems, printers, and terminals to the system. This command displays the following information: device type, data transmission rate, parity, type of flow control used, number of stop bits, number of data bits, and the type of unsolicited messages to be received.

**Keyword:** rtrv-trm

**Related Commands:** act-echo, canc-echo, chg-trm, dact-echo, inh-trm, rept-stat-trm, rmv-trm, rst-trm

**Command Class:** Database Administration

### Parameters

**:trm=** (optional)

Specifies the ID number of the terminal whose characteristics are to be retrieved and displayed.

**Range:** 1-40

**Default:** Display all

**Example**

```
rtrv-trm
rtrv-trm:trm=17
```

**Dependencies**

The IP User Interface feature must be enabled and turned on, and at least one IPSM card must be equipped, before **telnet** or **emsalm** type terminals with IDs 17 - 40 can be specified.

The specified terminal must be equipped.

**Notes**

None

**Output**

The following example shows the display of the terminal settings for 16 terminal ports (no IPSM cards are equipped):

**rtrv-trm**

```

rlghncxa03w 09-01-11 16:02:08 EST EAGLE 40.1.0
TRM  TYPE      COMM          FC      TMOUT  MXINV  DURAL
1    VT320     9600-7-E-1 SW      60      5      99:59:59
2    VT320     9600-7-E-1 BOTH   60      5      INDEF
3    KSR       9600-7-E-1 SW      60      0      00:00:00
4    NONE      9600-7-E-1 SW      60      5      00:30:00
5    NONE      9600-7-E-1 SW      60      5      00:00:30
6    OAP       19200-7-E-1 SW     0       5      INDEF
7    VT320     9600-7-E-1 SW      60      5      99:59:59
8    VT320     9600-7-E-1 SW      60      5      INDEF
9    VT320     9600-7-E-1 SW      60      0      00:00:00
10   VT320     9600-7-E-1 SW      60      5      00:30:00
11   VT320     9600-7-E-1 NONE    60      5      00:00:30
12   NONE      19200-7-E-1 SW     0       5      INDEF
13   VT320     9600-7-E-1 SW      60      5      99:59:59
14   VT320     9600-7-E-1 SW      60      5      INDEF
15   VT320     9600-7-E-1 SW      60      0      00:00:00
16   VT320     9600-7-E-1 SW      60      5      00:30:00

TRM  TRAF  LINK  SA  SYS  PU  DB  UIMRD
1    YES  YES  YES  YES  YES  YES  YES
2    YES  YES  YES  YES  YES  YES  YES
3    YES  YES  YES  YES  YES  YES  YES
4    YES  YES  YES  YES  NO  YES  YES
5    YES  YES  YES  YES  YES  YES  YES
6    NO   YES  YES  YES  YES  YES  YES
7    NO   YES  YES  YES  YES  YES  YES
8    YES  YES  YES  YES  YES  YES  YES
9    YES  YES  YES  YES  YES  YES  YES
10   NO   NO   NO   NO   NO   NO   NO
11   NO   NO   NO   NO   NO   NO   NO
12   NO   NO   NO   NO   NO   NO   NO
13   NO   NO   NO   NO   NO   NO   NO
14   NO   NO   NO   NO   NO   NO   NO
15   NO   NO   NO   NO   NO   NO   NO
16   NO   NO   NO   NO   NO   NO   NO

      APP  APP
TRM  SERV  SS  CARD  CLK  DBG  GTT  GWS  MEAS  MON  MPS  SEAS  SLAN
1    YES  YES  YES  YES  YES  YES  YES  YES  YES  YES  YES  NO  NO
2    YES  YES  YES  YES  YES  YES  YES  YES  YES  YES  YES  NO  NO
3    YES  YES  YES  YES  YES  YES  YES  YES  YES  YES  YES  NO  NO
4    YES  YES  YES  YES  YES  NO  YES  YES  YES  YES  YES  NO  NO
5    YES  YES  YES  YES  YES  YES  YES  YES  YES  YES  YES  NO  NO
6    YES  YES  YES  YES  YES  YES  YES  YES  YES  YES  YES  NO  NO
7    NO   YES  YES  YES  YES  YES  YES  YES  YES  YES  YES  NO  NO
8    YES  YES  YES  YES  YES  YES  YES  YES  YES  YES  YES  YES  YES
9    YES  YES  YES  YES  YES  YES  YES  YES  YES  YES  YES  YES  YES
10   NO   NO   NO   NO   NO   NO   NO   NO   NO   NO   NO  NO  NO
11   NO   NO   NO   NO   NO   NO   NO   NO   NO   NO   NO  NO  NO
12   NO   NO   NO   NO   NO   NO   NO   NO   NO   NO   NO  NO  NO
13   NO   NO   NO   NO   NO   NO   NO   NO   NO   NO   NO  NO  NO
14   NO   NO   NO   NO   NO   NO   NO   NO   NO   NO   NO  NO  NO
15   NO   NO   NO   NO   NO   NO   NO   NO   NO   NO   NO  NO  NO
16   NO   NO   NO   NO   NO   NO   NO   NO   NO   NO   NO  NO  NO

```

;

The following example shows the display of the terminal settings with the IP User Interface feature enabled and three IPSM cards equipped:

**rtrv-trm**

```

rlghncxa03w 09-01-11 16:02:08 EST EAGLE 40.1.0
TRM  TYPE      COMM      FC      TMOUT  MXINV  DURAL
1    VT320     9600 -7-E-1 SW    0      5      00:01:00
2    VT320     9600 -7-E-1 SW    0      5      00:01:00
3    VT320     9600 -7-E-1 SW    0      5      00:01:00
4    KSR       9600 -7-E-1 SW    0      5      00:01:00
5    NONE      9600 -7-E-1 SW   30     5      00:01:00
6    NONE      9600 -7-E-1 SW   30     5      00:01:00
7    NONE      9600 -7-E-1 SW   30     5      00:01:00
8    NONE      9600 -7-E-1 SW   30     5      00:01:00
9    VT320     9600 -7-E-1 SW    0      5      00:01:00
10   VT320     9600 -7-E-1 SW    0      5      00:01:00
11   VT320     9600 -7-E-1 SW    0      5      00:01:00
12   KSR       9600 -7-E-1 SW    0      5      00:01:00
13   NONE      9600 -7-E-1 SW   30     5      00:01:00
14   NONE      9600 -7-E-1 SW   30     5      00:01:00
15   NONE      9600 -7-E-1 SW   30     5      00:01:00
16   NONE      9600 -7-E-1 SW   30     5      00:01:00

TRM  TYPE      LOC      TMOUT  MXINV  DURAL
17   TELNET    1201     60     5      00:30:00
18   TELNET    1201     60     5      00:30:00
19   TELNET    1201     60     5      00:30:00
20   TELNET    1201     60     5      00:30:00
21   TELNET    1201     60     5      00:30:00
22   TELNET    1201     60     5      00:30:00
23   TELNET    1201     60     5      00:30:00
24   TELNET    1201     60     5      00:30:00
25   TELNET    1203     60     5      00:30:00
26   TELNET    1203     60     5      00:30:00
27   TELNET    1203     60     5      00:30:00
28   TELNET    1203     60     5      00:30:00
29   TELNET    1203     60     5      00:30:00
30   TELNET    1203     60     5      00:30:00
31   TELNET    1203     60     5      00:30:00
32   TELNET    1203     60     5      00:30:00
33   TELNET    1208     60     5      00:30:00
34   TELNET    1208     60     5      00:30:00
35   TELNET    1208     60     5      00:30:00
36   TELNET    1208     60     5      00:30:00
37   TELNET    1208     60     5      00:30:00
38   TELNET    1208     60     5      00:30:00
39   TELNET    1208     60     5      00:30:00
40   TELNET    1208     60     5      00:30:00

TRM  LOGINTMR  LOGOUTTMR  PNGTIMEINT  PNGFAILCNT
      (sec)   (sec)      (msec)
17   none    none       none        1
18   none    none       none        1
19   none    none       none        1
20   none    none       none        1
21   none    none       none        1
22   none    none       none        1
23   none    none       none        1
24   none    none       none        1
25   none    none       none        1
26   none    none       none        1
27   none    none       none        1
28   none    none       none        1
29   none    none       none        1

```

|    |      |      |      |   |
|----|------|------|------|---|
| 30 | none | none | none | 1 |
| 31 | none | none | none | 1 |
| 32 | none | none | none | 1 |
| 33 | none | none | none | 1 |
| 34 | none | none | none | 1 |
| 35 | none | none | none | 1 |
| 36 | none | none | none | 1 |
| 37 | none | none | none | 1 |
| 38 | none | none | none | 1 |
| 39 | none | none | none | 1 |
| 40 | none | none | none | 1 |

| TRM | TRAF | LINK | SA  | SYS | PU  | DB  | UIMRD |
|-----|------|------|-----|-----|-----|-----|-------|
| 1   | YES  | YES  | YES | YES | YES | YES | YES   |
| 2   | YES  | YES  | YES | YES | YES | YES | YES   |
| 3   | YES  | YES  | YES | YES | YES | YES | YES   |
| 4   | YES  | YES  | YES | YES | NO  | YES | YES   |
| 5   | YES  | YES  | YES | YES | YES | YES | YES   |
| 6   | NO   | YES  | YES | YES | YES | YES | YES   |
| 7   | NO   | YES  | YES | YES | YES | YES | YES   |
| 8   | YES  | YES  | YES | YES | YES | YES | YES   |
| 9   | YES  | YES  | YES | YES | YES | YES | YES   |
| 10  | NO   | NO   | NO  | NO  | NO  | NO  | NO    |
| 11  | NO   | NO   | NO  | NO  | NO  | NO  | NO    |
| 12  | NO   | NO   | NO  | NO  | NO  | NO  | NO    |
| 13  | NO   | NO   | NO  | NO  | NO  | NO  | NO    |
| 14  | NO   | NO   | NO  | NO  | NO  | NO  | NO    |
| 15  | NO   | NO   | NO  | NO  | NO  | NO  | NO    |
| 16  | NO   | NO   | NO  | NO  | NO  | NO  | NO    |
| 17  | NO   | NO   | NO  | NO  | NO  | NO  | NO    |
| 18  | NO   | NO   | NO  | NO  | NO  | NO  | NO    |
| 19  | NO   | NO   | NO  | NO  | NO  | NO  | NO    |
| 20  | NO   | NO   | NO  | NO  | NO  | NO  | NO    |
| 21  | NO   | NO   | NO  | NO  | NO  | NO  | NO    |
| 22  | NO   | NO   | NO  | NO  | NO  | NO  | NO    |
| 23  | NO   | NO   | NO  | NO  | NO  | NO  | NO    |
| 24  | NO   | NO   | NO  | NO  | NO  | NO  | NO    |
| 25  | NO   | NO   | NO  | NO  | NO  | NO  | NO    |
| 26  | NO   | NO   | NO  | NO  | NO  | NO  | NO    |
| 27  | NO   | NO   | NO  | NO  | NO  | NO  | NO    |
| 28  | NO   | NO   | NO  | NO  | NO  | NO  | NO    |
| 29  | NO   | NO   | NO  | NO  | NO  | NO  | NO    |
| 30  | NO   | NO   | NO  | NO  | NO  | NO  | NO    |
| 31  | NO   | NO   | NO  | NO  | NO  | NO  | NO    |
| 32  | NO   | NO   | NO  | NO  | NO  | NO  | NO    |
| 33  | NO   | NO   | NO  | NO  | NO  | NO  | NO    |
| 34  | NO   | NO   | NO  | NO  | NO  | NO  | NO    |
| 35  | NO   | NO   | NO  | NO  | NO  | NO  | NO    |
| 36  | NO   | NO   | NO  | NO  | NO  | NO  | NO    |
| 37  | NO   | NO   | NO  | NO  | NO  | NO  | NO    |
| 38  | NO   | NO   | NO  | NO  | NO  | NO  | NO    |
| 39  | NO   | NO   | NO  | NO  | NO  | NO  | NO    |
| 40  | NO   | NO   | NO  | NO  | NO  | NO  | NO    |

| TRM | SERV | SS  | CARD | CLK | DBG | GTT | GWS | MEAS | MON | MPS | SEAS | SLAN |
|-----|------|-----|------|-----|-----|-----|-----|------|-----|-----|------|------|
| 1   | YES  | YES | YES  | YES | YES | YES | YES | YES  | YES | YES | NO   | NO   |
| 2   | YES  | YES | YES  | YES | YES | YES | YES | YES  | YES | YES | NO   | NO   |
| 3   | YES  | YES | YES  | YES | YES | YES | YES | YES  | YES | YES | NO   | NO   |
| 4   | YES  | YES | YES  | YES | YES | NO  | YES | YES  | YES | YES | NO   | NO   |
| 5   | YES  | YES | YES  | YES | YES | YES | YES | YES  | YES | YES | NO   | NO   |
| 6   | YES  | YES | YES  | YES | YES | YES | YES | YES  | YES | YES | NO   | NO   |
| 7   | NO   | YES | YES  | YES | YES | YES | YES | YES  | YES | YES | NO   | NO   |
| 8   | YES  | YES | YES  | YES | YES | YES | YES | YES  | YES | YES | YES  | YES  |

```

9   YES YES YES YES YES YES YES YES YES YES YES YES YES
10  NO  NO NO NO NO NO NO NO NO NO NO NO NO NO
11  NO  NO NO NO NO NO NO NO NO NO NO NO NO NO
12  NO  NO NO NO NO NO NO NO NO NO NO NO NO NO
13  NO  NO NO NO NO NO NO NO NO NO NO NO NO NO
14  NO  NO NO NO NO NO NO NO NO NO NO NO NO NO
15  NO  NO NO NO NO NO NO NO NO NO NO NO NO NO
16  NO  NO NO NO NO NO NO NO NO NO NO NO NO NO
17  NO  NO NO NO NO NO NO NO NO NO NO NO NO NO
18  NO  NO NO NO NO NO NO NO NO NO NO NO NO NO
19  NO  NO NO NO NO NO NO NO NO NO NO NO NO NO
20  NO  NO NO NO NO NO NO NO NO NO NO NO NO NO
21  NO  NO NO NO NO NO NO NO NO NO NO NO NO NO
22  NO  NO NO NO NO NO NO NO NO NO NO NO NO NO
23  NO  NO NO NO NO NO NO NO NO NO NO NO NO NO
24  NO  NO NO NO NO NO NO NO NO NO NO NO NO NO
25  NO  NO NO NO NO NO NO NO NO NO NO NO NO NO
26  NO  NO NO NO NO NO NO NO NO NO NO NO NO NO
27  NO  NO NO NO NO NO NO NO NO NO NO NO NO NO
28  NO  NO NO NO NO NO NO NO NO NO NO NO NO NO
29  NO  NO NO NO NO NO NO NO NO NO NO NO NO NO
30  NO  NO NO NO NO NO NO NO NO NO NO NO NO NO
31  NO  NO NO NO NO NO NO NO NO NO NO NO NO NO
32  NO  NO NO NO NO NO NO NO NO NO NO NO NO NO
33  NO  NO NO NO NO NO NO NO NO NO NO NO NO NO
34  NO  NO NO NO NO NO NO NO NO NO NO NO NO NO
35  NO  NO NO NO NO NO NO NO NO NO NO NO NO NO
36  NO  NO NO NO NO NO NO NO NO NO NO NO NO NO
37  NO  NO NO NO NO NO NO NO NO NO NO NO NO NO
38  NO  NO NO NO NO NO NO NO NO NO NO NO NO NO
39  NO  NO NO NO NO NO NO NO NO NO NO NO NO NO
40  NO  NO NO NO NO NO NO NO NO NO NO NO NO NO

```

;

The following example shows the display of the terminal settings for Telnet terminal 30:

```

rtrv-trm:trm=30
rlghncxa03w 08-05-01 16:02:08 EST EAGLE 39.0.0
TRM  TYPE   LOC      TMOUT  MXINV  DURAL
30   TELNET 1204      60     0      00:00:00

TRM  LOGIN TMR  LOGOUT TMR  PNGTIMEINT  PNGFAILCNT
      (sec)   (sec)      (msec)
30   none   none      none      1

TRM  TRAF  LINK  SA   SYS  PU  DB  UIMRD
30   YES  YES  YES  YES  YES  YES  YES

APP  APP
TRM  SERV  SS  CARD  CLK  DBG  GTT  GWS  MEAS  MON  MPS  SEAS  SLAN
30   YES  YES  YES  YES  YES  YES  YES  YES  YES  YES  YES  NO  NO

```

;

The following example shows the display of the terminal settings with the IP User Interface feature enabled, one IPSM card equipped, and the OA&M IP Security Enhancements feature turned off:

```

rtrv-trm
rlghncxa03w 09-01-11 16:02:08 EST EAGLE 40.1.0
TRM  TYPE   COMM      FC      TMOUT  MXINV  DURAL
1    VT320   9600 -7-E-1 SW    0      5      00:01:00
2    VT320   9600 -7-E-1 SW    0      5      00:01:00
3    VT320   9600 -7-E-1 SW    0      5      00:01:00
4    KSR     9600 -7-E-1 SW    0      5      00:01:00
5    NONE    9600 -7-E-1 SW    30     5      00:01:00
6    NONE    9600 -7-E-1 SW    30     5      00:01:00
7    NONE    9600 -7-E-1 SW    30     5      00:01:00

```

|    |       |      |        |    |    |   |          |
|----|-------|------|--------|----|----|---|----------|
| 8  | NONE  | 9600 | -7-E-1 | SW | 30 | 5 | 00:01:00 |
| 9  | VT320 | 9600 | -7-E-1 | SW | 0  | 5 | 00:01:00 |
| 10 | VT320 | 9600 | -7-E-1 | SW | 0  | 5 | 00:01:00 |
| 11 | VT320 | 9600 | -7-E-1 | SW | 0  | 5 | 00:01:00 |
| 12 | KSR   | 9600 | -7-E-1 | SW | 0  | 5 | 00:01:00 |
| 13 | NONE  | 9600 | -7-E-1 | SW | 30 | 5 | 00:01:00 |
| 14 | NONE  | 9600 | -7-E-1 | SW | 30 | 5 | 00:01:00 |
| 15 | NONE  | 9600 | -7-E-1 | SW | 30 | 5 | 00:01:00 |
| 16 | NONE  | 9600 | -7-E-1 | SW | 30 | 5 | 00:01:00 |

| TRM | TYPE   | LOC  | TMOUT | MXINV | DURAL    | SECURE |
|-----|--------|------|-------|-------|----------|--------|
| 17  | TELNET | 1201 | 60    | 5     | 00:30:00 | no     |
| 18  | TELNET | 1201 | 60    | 5     | 00:30:00 | no     |
| 19  | TELNET | 1201 | 60    | 5     | 00:30:00 | no     |
| 20  | TELNET | 1201 | 60    | 5     | 00:30:00 | no     |
| 21  | TELNET | 1201 | 60    | 5     | 00:30:00 | no     |
| 22  | TELNET | 1201 | 60    | 5     | 00:30:00 | no     |
| 23  | TELNET | 1201 | 60    | 5     | 00:30:00 | no     |
| 24  | TELNET | 1201 | 60    | 5     | 00:30:00 | no     |

| TRM | LOGIN TMR<br>(sec) | LOGOUT TMR<br>(sec) | PNG TIME INT<br>(msec) | PNG FAIL CNT |
|-----|--------------------|---------------------|------------------------|--------------|
| 17  | none               | none                | none                   | 1            |
| 18  | none               | none                | none                   | 1            |
| 19  | none               | none                | none                   | 1            |
| 20  | none               | none                | none                   | 1            |
| 21  | none               | none                | none                   | 1            |
| 22  | none               | none                | none                   | 1            |
| 23  | none               | none                | none                   | 1            |
| 24  | none               | none                | none                   | 1            |

| TRM | TRAF | LINK | SA  | SYS | PU  | DB  | UIMRD |
|-----|------|------|-----|-----|-----|-----|-------|
| 1   | YES  | YES  | YES | YES | YES | YES | YES   |
| 2   | YES  | YES  | YES | YES | YES | YES | YES   |
| 3   | YES  | YES  | YES | YES | YES | YES | YES   |
| 4   | YES  | YES  | YES | YES | NO  | YES | YES   |
| 5   | YES  | YES  | YES | YES | YES | YES | YES   |
| 6   | NO   | YES  | YES | YES | YES | YES | YES   |
| 7   | NO   | YES  | YES | YES | YES | YES | YES   |
| 8   | YES  | YES  | YES | YES | YES | YES | YES   |
| 9   | YES  | YES  | YES | YES | YES | YES | YES   |
| 10  | NO   | NO   | NO  | NO  | NO  | NO  | NO    |
| 11  | NO   | NO   | NO  | NO  | NO  | NO  | NO    |
| 12  | NO   | NO   | NO  | NO  | NO  | NO  | NO    |
| 13  | NO   | NO   | NO  | NO  | NO  | NO  | NO    |
| 14  | NO   | NO   | NO  | NO  | NO  | NO  | NO    |
| 15  | NO   | NO   | NO  | NO  | NO  | NO  | NO    |
| 16  | NO   | NO   | NO  | NO  | NO  | NO  | NO    |
| 17  | NO   | NO   | NO  | NO  | NO  | NO  | NO    |
| 18  | NO   | NO   | NO  | NO  | NO  | NO  | NO    |
| 19  | NO   | NO   | NO  | NO  | NO  | NO  | NO    |
| 20  | NO   | NO   | NO  | NO  | NO  | NO  | NO    |
| 21  | NO   | NO   | NO  | NO  | NO  | NO  | NO    |
| 22  | NO   | NO   | NO  | NO  | NO  | NO  | NO    |
| 23  | NO   | NO   | NO  | NO  | NO  | NO  | NO    |
| 24  | NO   | NO   | NO  | NO  | NO  | NO  | NO    |

| TRM | SERV | SS  | CARD | CLK | DBG | GTT | GWS | MEAS | MON | MPS | SEAS | SLAN |
|-----|------|-----|------|-----|-----|-----|-----|------|-----|-----|------|------|
| 1   | YES  | YES | YES  | YES | YES | YES | YES | YES  | YES | YES | NO   | NO   |
| 2   | YES  | YES | YES  | YES | YES | YES | YES | YES  | YES | YES | NO   | NO   |
| 3   | YES  | YES | YES  | YES | YES | YES | YES | YES  | YES | YES | NO   | NO   |
| 4   | YES  | YES | YES  | YES | YES | NO  | YES | YES  | YES | YES | NO   | NO   |
| 5   | YES  | YES | YES  | YES | YES | YES | YES | YES  | YES | YES | NO   | NO   |



|    |     |     |     |     |     |     |     |     |     |     |     |     |
|----|-----|-----|-----|-----|-----|-----|-----|-----|-----|-----|-----|-----|
| 6  | YES | YES | YES | YES | YES | YES | YES | YES | YES | YES | NO  | NO  |
| 7  | NO  | YES | YES | YES | YES | YES | YES | YES | YES | YES | NO  | NO  |
| 8  | YES | YES | YES | YES | YES | YES | YES | YES | YES | YES | YES | YES |
| 9  | YES | YES | YES | YES | YES | YES | YES | YES | YES | YES | YES | YES |
| 10 | NO  | NO  | NO  | NO  | NO  | NO  | NO  | NO  | NO  | NO  | NO  | NO  |
| 11 | NO  | NO  | NO  | NO  | NO  | NO  | NO  | NO  | NO  | NO  | NO  | NO  |
| 12 | NO  | NO  | NO  | NO  | NO  | NO  | NO  | NO  | NO  | NO  | NO  | NO  |
| 13 | NO  | NO  | NO  | NO  | NO  | NO  | NO  | NO  | NO  | NO  | NO  | NO  |
| 14 | NO  | NO  | NO  | NO  | NO  | NO  | NO  | NO  | NO  | NO  | NO  | NO  |
| 15 | NO  | NO  | NO  | NO  | NO  | NO  | NO  | NO  | NO  | NO  | NO  | NO  |
| 16 | NO  | NO  | NO  | NO  | NO  | NO  | NO  | NO  | NO  | NO  | NO  | NO  |
| 17 | NO  | NO  | NO  | NO  | NO  | NO  | NO  | NO  | NO  | NO  | NO  | NO  |
| 18 | NO  | NO  | NO  | NO  | NO  | NO  | NO  | NO  | NO  | NO  | NO  | NO  |
| 19 | NO  | NO  | NO  | NO  | NO  | NO  | NO  | NO  | NO  | NO  | NO  | NO  |
| 20 | NO  | NO  | NO  | NO  | NO  | NO  | NO  | NO  | NO  | NO  | NO  | NO  |
| 21 | NO  | NO  | NO  | NO  | NO  | NO  | NO  | NO  | NO  | NO  | NO  | NO  |
| 22 | NO  | NO  | NO  | NO  | NO  | NO  | NO  | NO  | NO  | NO  | NO  | NO  |
| 23 | NO  | NO  | NO  | NO  | NO  | NO  | NO  | NO  | NO  | NO  | NO  | NO  |
| 24 | NO  | NO  | NO  | NO  | NO  | NO  | NO  | NO  | NO  | NO  | NO  | NO  |

;  
The following example displays terminal settings for a SEAS terminal.

```
rtrv-trm:trm=30
tekelecstp 07-12-16 22:37:01 IST EAGLE 37.5.0
TRM  TYPE  LOC          TMOUT MXINV DURAL      SECURE
30   SEAS   1102          30    5      00:01:00  no

TRM  TRAF  LINK  SA   SYS  PU  DB  UIMRD
30   NO   NO   NO   NO   NO  NO  NO

APP  APP
TRM  SERV  SS   CARD  CLK  DBG  GTT  GWS  MEAS  MON  MPS  SEAS  SLAN
30   NO   NO  NO   NO   NO  NO  NO  NO   NO  NO  YES  NO
```

;  
The following example shows the display of the terminal settings with the IP User Interface feature enabled, one IPSM card equipped, and the OA&M IP Security Enhancements feature turned on.

- Terminals 17,18 and 19 are of type TELNET.
- Terminals 20,21 and 22 are of type EMSALM.
- Terminal 23 is of type NONE.
- Terminal 24 is of type SEAS.

The *LOGINTMR* and *LOGOUTTMR* fields apply to terminals 17 - 19. The *PNGTIMEINT* and *PNG FAILCNT* fields apply to terminals 17 - 22. None of the fields apply to terminals 23 and 24.

```
rtrv-trm
tekelecstp 08-06-16 00:17:30 IST EAGLE 39.0.0
TRM  TYPE  COMM          FC          TMOUT MXINV DURAL
1    VT320  9600 -7-E-1 SW    30    5      00:01:00
2    VT320  9600 -7-E-1 SW    30    5      00:01:00
3    VT320  9600 -7-E-1 SW    30    5      00:01:00
4    VT320  9600 -7-E-1 SW    30    5      00:01:00
5    VT320  9600 -7-E-1 SW    30    5      00:01:00
6    VT320  9600 -7-E-1 SW    30    5      00:01:00
7    VT320  9600 -7-E-1 SW    30    5      00:01:00
8    VT320  9600 -7-E-1 SW    30    5      00:01:00
9    VT320  9600 -7-E-1 SW    30    5      00:01:00
10   VT320  9600 -7-E-1 SW    30    5      00:01:00
11   VT320  9600 -7-E-1 SW    30    5      00:01:00
12   VT320  9600 -7-E-1 SW    30    5      00:01:00
```

|    |       |      |        |    |    |   |          |
|----|-------|------|--------|----|----|---|----------|
| 13 | VT320 | 9600 | -7-E-1 | SW | 30 | 5 | 00:01:00 |
| 14 | VT320 | 9600 | -7-E-1 | SW | 30 | 5 | 00:01:00 |
| 15 | VT320 | 9600 | -7-E-1 | SW | 30 | 5 | 00:01:00 |
| 16 | VT320 | 9600 | -7-E-1 | SW | 30 | 5 | 00:01:00 |

| TRM | TYPE   | LOC  | TMOUT | MXINV | DURAL    | SECURE |
|-----|--------|------|-------|-------|----------|--------|
| 17  | TELNET | 1111 | 30    | 5     | 00:01:00 | yes    |
| 18  | TELNET | 1111 | 30    | 5     | 00:01:00 | yes    |
| 19  | TELNET | 1111 | 30    | 5     | 00:01:00 | yes    |
| 20  | EMSALM | 1111 | 30    | 5     | 00:01:00 | yes    |
| 21  | EMSALM | 1111 | 30    | 5     | 00:01:00 | yes    |
| 22  | EMSALM | 1111 | 30    | 5     | 00:01:00 | yes    |
| 23  | NONE   | 1111 | 30    | 5     | 00:01:00 | yes    |
| 24  | SEAS   | 1111 | 30    | 5     | 00:01:00 | yes    |

| TRM | LOGINTMR | LOGOUTTMR | PNGTIMEINT | PNGFAILCNT |
|-----|----------|-----------|------------|------------|
|     | (sec)    | (sec)     | (msec)     |            |
| 17  | 15       | 15        | none       | 1          |
| 18  | 15       | none      | none       | 1          |
| 19  | 15       | none      | none       | 1          |
| 20  | ----     | ----      | none       | 1          |
| 21  | ----     | ----      | none       | 1          |
| 22  | ----     | ----      | none       | 1          |

| TRM | TRAF | LINK | SA  | SYS | PU  | DB  | UIMRD |
|-----|------|------|-----|-----|-----|-----|-------|
| 1   | YES  | YES  | YES | YES | YES | YES | YES   |
| 2   | YES  | YES  | YES | YES | YES | YES | YES   |
| 3   | YES  | YES  | YES | YES | YES | YES | YES   |
| 4   | YES  | YES  | YES | YES | YES | YES | YES   |
| 5   | NO   | NO   | NO  | NO  | NO  | NO  | NO    |
| 6   | NO   | NO   | NO  | NO  | NO  | NO  | NO    |
| 7   | NO   | NO   | NO  | NO  | NO  | NO  | NO    |
| 8   | NO   | NO   | NO  | NO  | NO  | NO  | NO    |
| 9   | NO   | NO   | NO  | NO  | NO  | NO  | NO    |
| 10  | NO   | NO   | NO  | NO  | NO  | NO  | NO    |
| 11  | NO   | NO   | NO  | NO  | NO  | NO  | NO    |
| 12  | NO   | NO   | NO  | NO  | NO  | NO  | NO    |
| 13  | NO   | NO   | NO  | NO  | NO  | NO  | NO    |
| 14  | NO   | NO   | NO  | NO  | NO  | NO  | NO    |
| 15  | NO   | NO   | NO  | NO  | NO  | NO  | NO    |
| 16  | NO   | NO   | NO  | NO  | NO  | NO  | NO    |
| 17  | YES  | YES  | YES | YES | YES | YES | YES   |
| 18  | YES  | YES  | YES | YES | YES | YES | YES   |
| 19  | YES  | YES  | YES | YES | YES | YES | YES   |
| 20  | YES  | YES  | YES | YES | YES | YES | YES   |
| 21  | YES  | YES  | YES | YES | YES | YES | YES   |
| 22  | YES  | YES  | YES | YES | YES | YES | YES   |
| 23  | YES  | YES  | YES | YES | YES | YES | YES   |
| 24  | YES  | YES  | YES | YES | YES | YES | YES   |

| TRM | SERV | SS  | CARD | CLK | DBG | GTT | GWS | MEAS | MON | MPS | SEAS | SLAN |
|-----|------|-----|------|-----|-----|-----|-----|------|-----|-----|------|------|
| 1   | YES  | YES | YES  | YES | YES | YES | YES | YES  | YES | YES | YES  | YES  |
| 2   | YES  | YES | YES  | YES | YES | YES | YES | YES  | YES | YES | YES  | YES  |
| 3   | YES  | YES | YES  | YES | YES | YES | YES | YES  | YES | YES | YES  | YES  |
| 4   | YES  | YES | YES  | YES | YES | YES | YES | YES  | YES | YES | YES  | YES  |
| 5   | NO   | NO  | NO   | NO  | NO  | NO  | NO  | NO   | NO  | NO  | NO   | NO   |
| 6   | NO   | NO  | NO   | NO  | NO  | NO  | NO  | NO   | NO  | NO  | NO   | NO   |
| 7   | NO   | NO  | NO   | NO  | NO  | NO  | NO  | NO   | NO  | NO  | NO   | NO   |
| 8   | NO   | NO  | NO   | NO  | NO  | NO  | NO  | NO   | NO  | NO  | NO   | NO   |
| 9   | NO   | NO  | NO   | NO  | NO  | NO  | NO  | NO   | NO  | NO  | NO   | NO   |
| 10  | NO   | NO  | NO   | NO  | NO  | NO  | NO  | NO   | NO  | NO  | NO   | NO   |

|    |     |     |     |     |     |     |     |     |     |     |     |     |
|----|-----|-----|-----|-----|-----|-----|-----|-----|-----|-----|-----|-----|
| 11 | NO  | NO  | NO  | NO  | NO  | NO  | NO  | NO  | NO  | NO  | NO  | NO  |
| 12 | NO  | NO  | NO  | NO  | NO  | NO  | NO  | NO  | NO  | NO  | NO  | NO  |
| 13 | NO  | NO  | NO  | NO  | NO  | NO  | NO  | NO  | NO  | NO  | NO  | NO  |
| 14 | NO  | NO  | NO  | NO  | NO  | NO  | NO  | NO  | NO  | NO  | NO  | NO  |
| 15 | NO  | NO  | NO  | NO  | NO  | NO  | NO  | NO  | NO  | NO  | NO  | NO  |
| 16 | NO  | NO  | NO  | NO  | NO  | NO  | NO  | NO  | NO  | NO  | NO  | NO  |
| 17 | YES | YES | YES | YES | YES | YES | YES | YES | YES | YES | YES | YES |
| 18 | YES | YES | YES | YES | YES | YES | YES | YES | YES | YES | YES | YES |
| 19 | YES | YES | YES | YES | YES | YES | YES | YES | YES | YES | YES | YES |
| 20 | YES | YES | YES | YES | YES | YES | YES | YES | YES | YES | YES | YES |
| 21 | YES | YES | YES | YES | YES | YES | YES | YES | YES | YES | YES | YES |
| 22 | YES | YES | YES | YES | YES | YES | YES | YES | YES | YES | YES | YES |
| 23 | YES | YES | YES | YES | YES | YES | YES | YES | YES | YES | YES | YES |
| 24 | YES | YES | YES | YES | YES | YES | YES | YES | YES | YES | YES | YES |

;  
The following example displays terminal settings for an EMSALM terminal on an IPSM card.

**rtrv-trm:trm=22**

```
tekelecstp 08-06-16 01:29:28 EST EAGLE 39.0.0

TRM  TYPE      LOC              TMOUT MXINV DURAL      SECURE
22   EMSALM    1111                30    5      00:01:00  yes

TRM  PNGTIMEINT PNGFAILCNT
      (msec)
22   none          1

TRM  TRAF LINK SA  SYS PU  DB  UIMRD
22   YES  YES  YES YES YES YES YES

      APP  APP
TRM  SERV SS  CARD CLK DBG GTT GWS MEAS MON MPS SEAS SLAN
22   YES  YES YES  YES YES YES YES YES  YES YES YES  YES
```

;  
The following example displays terminal settings for a NONE terminal on an IPSM card.

**rtrv-trm:trm=23**

```
tekelecstp 08-06-16 01:28:03 EST EAGLE 39.0.0

TRM  TYPE      LOC              TMOUT MXINV DURAL      SECURE
23   NONE      1111                30    5      00:01:00  yes

TRM  TRAF LINK SA  SYS PU  DB  UIMRD
23   YES  YES  YES YES YES YES YES

      APP  APP
TRM  SERV SS  CARD CLK DBG GTT GWS MEAS MON MPS SEAS SLAN
23   YES  YES YES  YES YES YES YES YES  YES YES YES  YES
```

;  
**Legend**

Part one of the **rtrv-trm** report contains these fields:

**TRM**—The TDM terminal port number associated with the output device.

**TYPE**—The type of output device that is connected.

**COMM**—This field is composed of four communication attributes in the format *baud-dbts-prty-sb*. The parts are:

**BAUD**—The serial port baud rate of the output device

**DBTS**—The number of data bits used by the output device

**PRTY**—The parity of the output device

**SB**—The number of stop bits used in communications with the output device

**FC**—The type of protocol used between the system and the output devices.

**TMOUT**—Shows the maximum amount of time (in minutes) that a login session can remain idle.

**MXINV**—Shows the login/unlock failure threshold.

**DURAL**—Shows the length of time (in seconds, minutes, and hours) the terminal is disabled after each failed login/unlock attempt in excess of the threshold configured with the **mxinv** parameter.

**SECURE**—Indicates whether the OA&M IP Security Enhancements feature is turned on or off for Telnet terminals.

Part two of the **rtrv-trm** report contains these fields:

**LOGINTMR**—Shows the maximum time for logging on to the telnet terminal after selecting the terminal.

**LOGOUTTMR**—Shows the maximum time the telnet session remains open after the user manually or automatically logs out.

**PNGTIMEINT**—Shows the time period after which IPSM card initiates new ping cycle.

**PNGFAILCNT**—Shows the number of consecutive ping fails waited before dropping the telnet connection.

Part three of the **rtrv-trm** report contains these fields:

**TRM**—The TDM terminal associated with the output device.

**TRAF**—Shows whether traffic-related unsolicited messages are received by the output device.

**LINK**—Shows whether link-related unsolicited messages are received by the output device.

**SA**—Shows whether security administration-related unsolicited messages are received by the output device.

**SYS**—Shows whether system maintenance-related unsolicited messages are received by the output device.

**PU**—Shows whether program update-related unsolicited messages are received by the output device.

**DB**—Shows whether database-related unsolicited messages are received by the output device.

**UIMRD**—Shows whether Unsolicited Information Messages (UIMs) specific to the group are received by the output device.

Part four of the **rtrv-trm** report contains these fields:

**APP SERV**—Shows whether Application Server unsolicited messages are received by the output device.

**APP SS**—Shows whether Application Subsystem unsolicited messages are received by the output device.

**CARD**—Shows whether Card unsolicited messages are received by the output device.

**CLK**—Shows whether Clock unsolicited messages are received by the output device.

**DBG**—Shows whether Debug unsolicited messages are received by the output device.

**GTT**—Shows whether GTT unsolicited messages are received by the output device.

**GWS**—Shows whether GWS unsolicited messages are received by the output device.

**MEAS**—Shows whether Measurements Maintenance unsolicited messages are received by the output device.

**MON**—Shows whether Monitor unsolicited messages are received by the output device.

**MPS**—Shows whether MPS unsolicited messages are received by the output device.

**SEAS**—Shows whether SEAS Maintenance unsolicited messages are received by the output device.

**SLAN**—Shows whether STP LAN unsolicited messages are received by the output device.

**rtrv-tt****Retrieve Translation Type**

Use this command to show the translation types that are currently defined in the system database for global title translations.

**NOTE: If the EGTT (Enhanced Global Title Translation) feature is turned on in your system, the system will no longer accept GTT (Global Title Translation) and TT (Translation Type) commands. Refer to the new command sets that replace the GTT and TT commands: GTT Selector commands (ent/chg/dlt/rtrv-gttset), GTT Set commands (ent/dlt/rtrv-gttset), and GTA commands (ent/chg/dlt/rtrv-gta).**

**Keyword:** rtrv-tt  
**Related Commands:** dlt-tt, ent-tt  
**Command Class:** Database Administration

**Parameters**

**:alias=** (optional)

The alias of the global title translation type

**Range:** 0-255

**Default:** Display all

**:ttn=** (optional)

Translation type name.

**Range:** ayyyyyyyy

1 alphabetic character followed by up to 7 alphanumeric characters

**Default:** Display all

**:type/typea/typei/typen/typen24=** (optional)

A translation type numeric value may be entered as ANSI type (**type** or **typea**) and also as an ITU type (**typei** or **typen**). However, they are separate entities.

**Range:** 0-255

**Default:** No translation type is specified

**Example**

```
rtrv-tt
rtrv-tt:type=230
rtrv-tt:ttn=lidb
rtrv-tt:type=230:ttn=lidb
rtrv-tt:type=230:ttn=lidb:alias=012
```

**Dependencies**

This command is not valid when the EGTT feature is turned on.  
 Asterisk (\*) parameter values are not allowed for this command.

The translation type must exist in the translation table. If either or both parameters are given, they must be the same as the values entered with the **ent-tt** command. If the translation name is specified, it must be associated with a translation type.

If a translation type is specified, it must already exist in the database for the network type and cannot be an alias.

If both translation type and translation type name are specified, the translation type name must correspond to the specified translation type.

If an alias is specified with a translation type and/or translation type name, the alias must exist in the database for the specified network type, and it cannot be a translation type.

If an alias is specified without a translation type or translation type name, the alias must exist in the database for at least one of the network types. If it exists, the entries and the mapped translation type entries that exist in the database for all network types are displayed.

### Notes

If a translation type, translation type name, or both, are specified, the translation type entry and all aliases mapped to that translation type are displayed.

Output

**rtrv-tt**

tekelecstp 03-05-02 09:03:09 EST EAGLE 31.0.0

| TYPEA | TTN     | NDGT |
|-------|---------|------|
| 130   | lidb    | 5    |
| 180   | ansi180 | 9    |

| ALIAS | TYPEA |
|-------|-------|
| 1     | 130   |
| 7     | 130   |
| 10    | 180   |

| TYPEI | TTN     | NDGT |
|-------|---------|------|
| 105   | intlabc | 15   |
| 119   | intl119 | 18   |

| ALIAS | TYPEI |
|-------|-------|
| 29    | 119   |
| 33    | 105   |

| TYPEN | TTN     | NDGT |
|-------|---------|------|
| 204   | natlxyz | 8    |
| 210   | natl210 | 21   |

| ALIAS | TYPEN |
|-------|-------|
| 7     | 204   |

| TYPEN24 | TTN | NDGT |
|---------|-----|------|
|---------|-----|------|

;

**rtrv-tt:type=130:ttn=LIDB**

tekelecstp 03-11-02 09:06:38 EST EAGLE 30.0.0

| TYPEA | TTN  | NDGT |
|-------|------|------|
| 130   | lidb | 5    |

| ALIAS | TYPEA |
|-------|-------|
| 1     | 130   |
| 7     | 130   |

;

**rtrv-tt:ttn=intlabc**

tekelecstp 03-11-02 09:19:34 EST EAGLE 30.0.0

| TYPEI | TTN     | NDGT |
|-------|---------|------|
| 105   | intlabc | 15   |

| ALIAS | TYPEI |
|-------|-------|
| 33    | 105   |

;

**rtrv-tt:alias=7**

tekelecstp 03-11-02 09:19:34 EST EAGLE 30.0.0

| ALIAS | TYPEA |
|-------|-------|
| 7     | 130   |

| ALIAS | TYPEN |
|-------|-------|
| 7     | 204   |

;

```

rtrv-tt
tekelecstp 03-05-02 09:19:34 EST EAGLE 31.0.0
TYPEA      TTN      NDGT

TYPEI      TTN      NDGT

TYPEN      TTN      NDGT

TYPEN24    TTN      NDGT
2          - - - - - 6
4          first   6

;

```

### Legend

**TYPEA/TYPEI/TYPEN/TYPEN24**—The global title translation type.

**TTN**—The name of the global title translation type.

**NDGT**—The number of digits in the global title translation type

**ALIAS**—The alias global title translation type.

## rtrv-ttmap

### Display Translation Type Mapping

Use this command to display a mapped SS7 message translation type (TT) for a given gateway linkset name. This command can be used to display the identification of the type of allowed global title translation in the SS7 message before and after translation type mapping, see which linkset the mapping applies to, and see whether the mapping applies to incoming or outgoing messages.

**Keyword:** rtrv-ttmap

**Related Commands:** chg-ttmap, dlt-ttmap, ent-ttmap

**Command Class:** Database Administration

### Parameters

**:ett=** (optional)

Translation type before mapping. The identification of the type of allowed global title translation in the SS7 message *prior to* translation type mapping. This attribute is the decimal representation of the 1-octet binary field used by the SS7 protocol to identify the translation type.

**Range:** 0-255

**Default:** Display all types allowed

**:io=** (optional)

Incoming or outgoing. The system uses this parameter to indicate whether the translation type mapping data provisioned for the gateway linkset is for SS7 messages *received* or *sent* on the linkset.

**Range:** i, o

i— incoming

o— outgoing

**Default:** Both incoming and outgoing

**:lsn=** (optional)

Linkset name

**Range:** ayyyyyyyyy

1 alphabetic character followed by up to 9 alphanumeric characters

**Default:** Display all



**Example**

```
rtrv-ttmap
rtrv-ttmap:lsn=nc001
rtrv-ttmap:lsn=nc001:io=i:ett=128
rtrv-ttmap:io=i:ett=128
rtrv-ttmap:ett=128
rtrv-ttmap:ett=40
```

**Dependencies**

The linkset must be defined.

The memory space accounting report (MSAR) is not produced when the **io** parameter, **ett** parameter, or both are specified, because the statistics presented may be misleading.

**Notes**

The order of display is by linkset index + I/O + ETT.

## Output

```

rtrv-ttmap
  rlghncxa03w 03-11-22 11:39:44 EST  EAGLE 30.0.0
  LSN          IO  ETT  MTT
  nc001        I   047  032
  nc001        I   128  055
  nc001        I   238  128
  nc001        I   254  016
  nc001        O   016  254
  nc001        O   128  238

  TTMAP table for nc001 is (6 of 64) 9% full

  nc002        I   128  055
  nc002        I   238  128
  nc002        O   128  238
  TTMAP table for nc002 is (3 of 64) 5% full

  lsi1         I   001  142
  lsi1         O   142  001
  TTMAP table for lsi1 is (2 of 64) 3% full

  lsi2         I   238  128
  TTMAP table for lsi2 is (1 of 64) 2% full

  lsi3         I   254  016
  TTMAP table for lsi3 is (1 of 64) 2% full

  lsn1         O   016  254
  lsn1         O   128  238
  TTMAP table for lsn1 is (2 of 64) 3% full

  lsn2         I   128  055
  lsn2         I   238  128
  lsn2         O   128  238
  TTMAP table for lsn2 is (3 of 64) 5% full
;

rtrv-ttmap:lsn=nc001
  rlghncxa03w 03-11-22 12:02:36 EST  EAGLE 30.0.0
  LSN          IO  ETT  MTT
  nc001        I   047  032
  nc001        I   128  055
  nc001        I   238  128
  nc001        I   254  016
  nc001        O   016  254
  nc001        O   128  238
  TTMAP table for nc001 is (6 of 64) 9% full
;

rtrv-ttmap:lsn=nc001:io=i:ett=128
  rlghncxa03w 03-11-22 12:04:21 EST  EAGLE 30.0.0
  LSN          IO  ETT  MTT
  nc001        I   128  055
;

rtrv-ttmap:io=i:ett=128
  rlghncxa03w 03-11-22 12:06:13 EST  EAGLE 30.0.0
  LSN          IO  ETT  MTT
  nc001        I   128  055
  nc002        I   128  055
  lsn2         I   128  055
;

```

**rtrv-ttmap:ett=128**

```
rlghncxa03w 03-11-22 12:41:21 EST EAGLE 30.0.0
LSN          IO   ETT  MTT
nc001       I    128  055
nc001       O    128  238
nc002       I    128  055
nc002       O    128  238
lsn1        O    128  238
lsn2        I    128  055
lsn2        O    128  238
```

;

**rtrv-ttmap:ett=40**

```
rlghncxa03w 03-11-07 16:12:38 EST EAGLE 30.0.0
LSN          IO   ETT  MTT
No mapped translation types defined for ETT specified.
```

;

**Legend**

LSN—Linkset name

IO—Incoming or outgoing linkset

ETT—Translation type before mapping

MTT—Mapped translation type

**rtrv-ttr-msg****Retrieve Configured TTR messages**

Use this command to display the configured Triggerless TCAP Relay message parameter values.

**Keyword:** rtrv-ttr-msg**Related Commands:** chg-ttr-msg, tst-msg**Command Class:** Database Administration**Parameters****:msgn=** (mandatory)

Message number. This parameter specifies the number of the TTR message.

**Range:** 1-10**Default:** The values for all TTR messages are displayed.**Example**

```
rtrv-ttr-msg:msgn=1
```

**Dependencies**

The Prepaid IDP Query Relay feature must be enabled before this command is entered.

**Output**

```

rtrv-ttr-msg:msgn=1
tekelecstp 08-05-05 17:36:25 EST EAGLE 39.0.0

MSG = 1          TCAP_TYPE = CAP          ACTIVE = YES
SK = 00006b00   BCSM = 02

CGPA_GT = 2
CGPA_GT_NAI = 4      CGPA = 0123456789abcde

CDPA_GT = 2
CDPA_GT_NAI = 8      CDPA = 12457896

CGPN_NAI = 4        CGPN = 01234567890abcdef
CDPN_NAI = 9        CDPN = 8764321

LAC = abcdef

```

**rtrv-ttropts****Retrieve TTR Options**

Use this command to display all of the Triggerless TCAP Relay options that are configured in the database.

**Keyword:** rtrv-ttropts

**Related Commands:** chg-ttropts

**Command Class:** Database Administration

**Parameters**

This command has no parameters.

**Example**

```
rtrv-ttropts
```

**Dependencies**

The Prepaid IDP Query Relay feature must be enabled before this command can be entered.

**Notes**

None

**Output**

**rtrv-ttropts**

tekelecstp 09-06-09 13:34:22 EST EAGLE 41.1.0

TTR OPTIONS

```
-----
CDPN DETAILS                CGPN DETAILS
NPTYPE  rnspl              CGNPTYPE  rnspl
SNAI    incoming          CGSNAI    incoming
```

```
CGPAACCK      NONINTL
DLMA          1234567890123456
DLMB          1234567890abcdef
DLMC          1234567890abcdef
DFLTRN       1234567890abcde
SPORTTYPE    all
SPFILL       on
RNSPFILL     off
CGPNSKRTG    no
DRAFRMT      grn
DRANAI       3
```

;

**rtrv-uaps**

**Retrieve UA Parameter Set**

Use this command to retrieve one UA parameter set or all UA parameter sets.

**Keyword:** rtrv-uaps

**Related Commands:** chg-uaps

**Command Class:** Database Administration

**Parameters**

**:set=** (optional)

This parameter specifies the UA parameter set to be displayed.

**Range:** 1-10

**Default:** Display all

**Example**

```
rtrv-uaps
rtrv-uaps:set=1
```

**Dependencies**

None

**Notes**

This command can be canceled using the F9 function key or the **canc-cmd** command. See **canc-cmd** for more information.

## Output

**rtrv-uaps:set=1**

```
eagle10213 09-03-17 14:01:00 EST EAGLE 41.0.0
SET  TIMER      TVALUE  PARM      PVALUE
  1     1         0       1         3
  1     2        3000     2         0
  1     3       10000     3         0
  1     4         5000     4         0
  1     5          0       5         0
  1     6          0       6         0
  1     7          0       7         0
  1     8          0       8         0
  1     9          0       9         0
  1    10          0      10         0
```

TIMER 2: False IP Connection Congestion Timer, max time an association can be congested before failing due to false congestion. SS7IPGW and IPGWI applications enforce 0-30000(ms). Not supported on IPSP application.

TVALUE : Valid range = 32-bits

TIMER 3: UA HeartBeat Period Timer T(beat), time (ms) between sending of BEAT msgs by NE. IPSP, SS7IPGW and IPGWI applications enforce 100(ms)-60000(ms).

TVALUE : Valid range = 32-bits

TIMER 4: UA HeartBeat Received Timer T(beat ack), timeout period for response BEAT ACK msgs by NE. IPSP, SS7IPGW and IPGWI applications enforce 100(ms)-10000(ms).

TVALUE : Valid range = 32-bits

PARAM 1: ASP SNM options. Each bit is used as an enabled/disabled flag for a particular ASP SNM option. Not supported on IPSP application.

PVALUE : Valid range = 32-bits

| BIT                                  | BIT VALUE              |
|--------------------------------------|------------------------|
| 0=Broadcast                          | 0=Disabled , 1=Enabled |
| 1=Response Method                    | 0=Disabled , 1=Enabled |
| 2-5=Reserved                         |                        |
| 6=Broadcast Congestion Status Change | 0=Disabled , 1=Enabled |
| 7-31=Reserved                        |                        |

PARAM 2: ASP/AS Notification options. Each bit is used as an enabled/disabled flag for a particular ASP/AS Notification option. Not supported on IPSP application.

PVALUE : Valid range = 32-bits

| BIT                          | BIT VALUE              |
|------------------------------|------------------------|
| 0=ASP Active Notifications   | 0=Disabled , 1=Enabled |
| 1=ASP Inactive Notifications | 0=Disabled , 1=Enabled |
| 2=ASP AS State Query         | 0=Disabled , 1=Enabled |
| 3-31=Reserved                |                        |

PARAM 3: UA Serviceability Options. Each bit is used as an enabled/disabled flag for a particular UA Serviceability option. Supported on IPSP, SS7IPGW, and IPGWI applications. UA Graceful Shutdown supported on IPSP for M3UA only.

PVALUE : Valid range = 32-bits

| BIT                    | BIT VALUE              |
|------------------------|------------------------|
| 0=UA Heartbeats        | 0=Disabled , 1=Enabled |
| 1=UA Graceful Shutdown | 0=Disabled , 1=Enabled |
| 2-31=Reserved          |                        |

**rtrv-uim-acthresh****Retrieve Activity Level Threshold for STP UIM  
Activity Reporting**

Use this command to query the UIM number, limit, and interval period parameters that are used to report the thresholding of UIM messages.

**Keyword:** rtrv-uim-acthresh

**Related Commands:** dlt-uim-acthresh, set-uim-acthresh

**Command Class:** Database Administration

**Parameters**

**:uimn=** (optional)

The UIM number.

**Range:** 1000-1499

**Default:** Display all

**Example**

Display UIM number 1333 threshold:

```
rtrv-uim-acthresh:uimn=1333
```

Display the threshold for all UIMs that have been set:

```
rtrv-uim-acthresh
```

**Dependencies**

If specified, the **uimn** parameter value must be four numeric characters in the range **1000–1499**.

The **uimn** parameter value, if specified, must exist in the system Trouble Text Table.

**Notes**

None

**Output**

```
rtrv-uim-acthresh:uimn=1333
rlghncxa03w 03-11-01 08:50:12 EST EAGLE 31.3.0
UIMN    LIMIT    INTRVL
1333    100      5
The UIM Threshold Table is (1 of 499) 1% full.
```

```
rtrv-uim-acthresh
rlghncxa03w 03-11-01 08:50:12 EST EAGLE 31.3.0
UIMN    LIMIT    INTRVL
1333    100      5
1444    200      15
1155    50       30
The UIM Threshold Table is (3 of 499) 1% full.
```

**rtrv-user****Retrieve User**

Use this command to show the information about the user currently logged on to the terminal from which this command was entered.

**Keyword:** rtrv-user

**Related Commands:** act-user, chg-pid, chg-user, dact-user, dlt-user, ent-user, login, logout, rept-stat-user, rtrv-secu-user

**Command Class:** Basic

**Parameters**

This command has no parameters.

**Example**

```
rtrv-user
```

**Dependencies**

This command cannot be entered from a SEAS terminal, because a SEAS terminal has no user ID associated with it.

**Notes**

The password is not shown.

This command shows the command class privileges for the user logged onto the system. No other users are shown.

All users have access to this command.



**Output**

The following example shows the display when the Command Class Management feature is turned on:

```
rtrv-user
rlghncxca03w 09-01-07 09:50:17 EST EAGLE 40.1.0
user id      age page uout rev link sa  sys pu  db  dbg
manny       36  60  60  NO  YES  YES YES YES YES YES

          u01 u02 u03 u04 u05 u06 u07 u08 u09 u10 u11 u12 u13 u14 u15 u16
          NO  NO  NO  NO  YES YES YES YES YES YES YES YES YES YES YES YES YES

          u17 u18 u19 u20 u21 u22 u23 u24 u25 u26 u27 u28 u29 u30 u31 u32
          YES YES YES YES YES YES YES YES YES YES YES NO  NO  NO  NO  YES

;
```

The following example shows the display when the Command Class Management feature is not turned on:

```
rtrv-user
rlghncxca03w 09-01-07 09:50:17 EST EAGLE 40.1.0
USER ID      LINK  SA SYS  PU  DB DBG
eagle       YES YES YES YES YES YES

          USER ID      AGE PAGE UOUT REV
          eagle       750 0   0   NO

;
```

**Legend**

**USER ID**—The name of the user.

**AGE**—Shows the current age, in days, of the password associated with this user ID. If the password age is greater than 999 days, the value **999** is displayed.

**PAGE**—Shows the maximum password age established for this user ID. When AGE becomes greater than PAGE, the system forces the user to change the password at the next login. An asterisk (\*) displayed after the value indicates that the system-wide default page parameter value, as configured on the **chg-secu-dflt** command, is in effect for the user ID.

**UOUT**—Shows the user ID aging interval, in days. If the user ID is not used (that is, no successful login) for longer than this interval, the system does not allow a login. An asterisk (\*) displayed after the value indicates that the system-wide default uout parameter value, as configured on the **chg-secu-dflt** command, is in effect for the user ID.

**REV**—Shows whether the user ID is denied login (revoked). **YES** indicates that the user ID is revoked, **NO** indicates that the user ID is not revoked.

**LINK**—Shows whether the user has access to all commands in the Link Maintenance command class.

**SA**—Shows whether the user has access to all commands in the Security Administration command class.

**SYS**—Shows whether the user has access to all commands in the System Maintenance command class.

**PU**—Shows whether the user has access to all commands in the Program Update command class.

**DB**—Shows whether the user has access to all commands in the Database Administration command class.

**DBG**—Shows whether the user has access to all commands in the Debug command class.

If the Command Class Management feature is enabled and turned on, the following fields are displayed:

**U01 - U32**—Default configurable command class names. If user-defined names have been provisioned, they will appear instead of the default names.

If the LNP feature is turned on, the following field is displayed:

**LNPBAS**—Shows whether the user has access to all commands in the LNP Basic command class.

## rtrv-vendid

### Retrieve Vendor ID

Use this command to retrieve a list of Vendor ID entries from the VENDID table, for the GSM MAP SRI Redirect to Serving HLR feature.

**Keyword:** rtrv-vendid

**Related Commands:** dlt-vendid,

**Command Class:** Database Administration

#### Parameters

**:vendnum=** (optional)

Vendor Number

**Range:** 1-3

#### Example

```
rtrv-vendid
```

```
rtrv-vendid:vendnum=1
```

#### Dependencies

The GSM MAP SRI Redirect feature must be enabled before this command can be entered.

#### Notes

None.

**Output**

When the command is entered with no parameter, the Vendor Types are listed in numerical order. The Vendor Numbers for each Vendor Type are listed in numerical order, followed by the Vendor ID for each Vendor Number.

**rtrv-vendid**

```
tekelecstp 04-09-21 16:11:21 EST EAGLE 31.11.0
Vendor   Vendor   Vendor
Type     Number  ID
-----
1         1         123123123456789
1         1         1234567890abcde
1         2         112233445566778
1         2         214365870912543
2         3         098765432112345
2         3         098767890143251
```

VENDID table is (5 of 200) 3% full

;

When a Vendor number is specified, the Vendor Type and Vendor IDs for the specified Vendor number are listed in numerical order. The table capacity line shows the total number of entries in use, not just the number of entries displayed.

**rtrv-vendid:vendnum=2**

```
tekelecstp 04-09-21 16:13:54 EST EAGLE 31.11.0
Vendor   Vendor   Vendor
Type     Number  ID
-----
1         2         112233445566778
1         2         214365870912543
```

VENDID table is (5 of 200) 3% full

;

**rtrv-vflx-cd**

**Retrieve V-Flex Call Decision Entry**

Use this command to retrieve call decision information.

**NOTE: The V-Flex feature must be enabled before this command can be entered.**

**Keyword:** rtrv-vflx-cd

**Related Commands:** chg-vflx-cd, dlt-vflx-cd, ent-vflx-cd

**Command Class:** Database Administration

**Parameters**

**:cdn=** (optional)

Call decision name. This parameter specifies the name of the call decision entry.

**Range:** *ayyy*

1 alphabetic character followed by 3 alphanumeric characters

**:vmdig=** (optional)

Voice mail number or voice mail prefix digits. This parameter specifies a voice mail number or voice mail digits that is associated with the call decision entry.

**Range:** 1-15 digits

Valid digits are **0-9, A-F, a-f**.

**Example**

The following command retrieves all entries from the Call Decision table.

```
rtrv-vflx-cd
```

The following command retrieves a specific Call Decision entry.

```
rtrv-vflx-cd:cdn=cdn1
```

The following command retrieves all call decision entries with a specified voice mail number or voice mail prefix digits.

```
rtrv-vflx-cd:vmdig=123456789abcd2
```

**Dependencies**

The **cdn** and **vmdig** parameters cannot be specified together in the command.

The value specified for the **cdn** parameter cannot be a reserved word, such as **none**.

The value specified for the **cdn** parameter must already exist in the Call Decision table.

The V-Flex feature must be enabled before this command can be entered.

**Notes**

This command can be cancelled using the **F9** function key or the **canc-cmd** command.

Output

**rtrv-vflx-cd**

tekelecstp 08-05-01 09:36:55 EST EAGLE 39.0.0

| RDI   | DN Status | BCAP | VM Number/Prefix | VMRN Index | CD Name |
|-------|-----------|------|------------------|------------|---------|
| DIR   | NFND      | 0    | 1                | 9          | c100    |
| DIR   | NFND      | 0    | 12               | 9          | c101    |
| DIR   | NFND      | 0    | 123              | 9          | c102    |
| DIR   | NFND      | 0    | 1234             | 9          | c103    |
| DIR   | FND       | 0    | 1                | 9          | c200    |
| DIR   | *         | 1    | 123              | 9          | c201    |
| DIR   | *         | 2    | 2345678          | 9          | c203    |
| DIR   | *         | 3    | 456789a          | 9          | c204    |
| DIR   | *         | 4    | 56789ab          | 9          | c205    |
| REDIR | *         | 1    | 123456789abcdef  | 9          | c202    |

VFLEX Call Decision table is (10 of 4950) 1% full.

;

**rtrv-vflx-cd:cdn=c100**

tekelecstp 08-05-31 17:04:25 EST EAGLE 39.0.0

| RDI | DN Status | BCAP | VM Number/Prefix | VMRN Index | CD Name |
|-----|-----------|------|------------------|------------|---------|
| DIR | NFND      | 0    | 1                | 9          | c100    |

VFLEX Call Decision table is (7 of 4950) 1% full.

;

The following output example illustrates how all Call Decision Table entries whose digits match the starting digits of the specified **vmdig** will be displayed.

**rtrv-vflx-cd:vmdig=123456789abcdef**

tekelecstp 08-05-31 17:05:49 EST EAGLE 39.0.0

| RDI   | DN Status | BCAP | VM Number/Prefix | VMRN Index | CD Name |
|-------|-----------|------|------------------|------------|---------|
| DIR   | NFND      | 0    | 1                | 9          | c100    |
| DIR   | NFND      | 0    | 12               | 9          | c101    |
| DIR   | NFND      | 0    | 123              | 9          | c102    |
| DIR   | NFND      | 0    | 1234             | 9          | c103    |
| DIR   | FND       | 0    | 1                | 9          | c200    |
| DIR   | *         | 1    | 123              | 9          | c201    |
| REDIR | *         | 1    | 123456789abcdef  | 9          | c202    |

VFLEX Call Decision table is (7 of 4950) 1% full.

;

**Legend**

**RDI**—The Redirection Indicator - whether the call has been redirected or not (0 - Not redirected: VM retrieval or direct dial VM deposit, 1 - Redirected: VM deposit).

**DN STATUS**—The status of the DN lookup in the RTDB - found in the RTDB, not found in the RTDB, don't care whether found in the RTDB or not.

**BCAP**—The INAP/CAP Bearer Capabilities.

**VM NUMBER/PREFIX**—The Voice Mail Numer or Voice Mail Prefix associated with a Call Decision entry.

**VMRN INDEX**—Index into the list of Routing Numbers associated with a specific VMSID entry.

**CD NAME**—The name of the Call Decision entry.

## rtrv-vflx-opts

## Retrieve V-Flex Options

Use this command to retrieve the data that is used for number conditioning.

**NOTE: The V-Flex feature must be enabled before this command can be entered.**

**Keyword:** rtrv-vflx-opts

**Related Commands:** chg-vflx-opts

**Command Class:** Database Administration

### Parameters

This command has no parameters.

### Example

The following command displays V-Flex Options Table data.

```
rtrv-vflx-opts
```

### Dependencies

The V-Flex feature must be enabled before this command can be specified.

### Notes

If no DRANAI value or DRANAIV value has been provisioned, the command output displays the DRANAIV default value of 0.

If the DRANAIV value has a corresponding DRANAI mnemonic string mapped to it, then that mnemonic string is displayed, otherwise the provisioned numeric value is displayed. For DRANAI and DRANAIV mapping refer to Table 5-36 in the **chg-vflx-opts** command.

If no DRANP value or DRANPV value has been provisioned, the command output displays the DRANPV default value of 0.

If the DRANPV value has a corresponding DRANP mnemonic string mapped to it, then that mnemonic string is displayed, otherwise the provisioned numeric value is displayed. For DRANP and DRANPV mapping refer to Table 5-37 in the **chg-vflx-opts** command.

**Output**

The following example shows output with default V-Flex Options.

```
rtrv-vflx-opts
tekelecstp 08-05-04 07:53:46 EST EAGLE 39.0.0

VFLEX OPTIONS
-----
DRANPV      = 0
DRANAIV     = 0
DRA         = RN
NEQUERYONLY = OFF
NETYPE      = VMSID
;
```

The following example shows output with some V-Flex Options provisioned.

```
rtrv-vflx-opts
tekelecstp 08-05-04 07:55:30 EST EAGLE 39.0.0

VFLEX OPTIONS
-----
DRANP       = E164
DRANAI      = SUB
DRA         = RN
NEQUERYONLY = ON
NETYPE      = GRN
;
```

**Legend**

**DRANP**—The numbering plan for the destination routing address.

**DRANAI**—The nature of address indicator for the destination routing address.

**DRA**—The format of the destination routing address.

**NEQUERYONLY**—The Network Entity Query Only option.

**NETYPE**—The Network Entity Type for the NEQUERYONLY option.

**rtrv-vflx-rn****Retrieve V-Flex Routing Number**

Use this command to retrieve voice mail routing numbers and routing number names and to view the associated reference count.

**NOTE: The V-Flex feature must be enabled before this command can be entered.**

**Keyword:** rtrv-vflx-rn

**Related Commands:** chg-vflx-rn, dlt-vflx-rn, ent-vflx-rn

**Command Class:** Database Administration

**Parameters**

**:refcnt=** (optional)

Reference count. This parameter specifies whether to display the reference count.

**Range:**     **yes**  
              **yes** — display the reference count

**:rn=** (optional)

Routing number. This parameter specifies a voice mail routing number.

**Range:**     1-15 digits  
              Valid digits are **0-9, A-F, a-f**.

**:rname=** (optional)

Routing number name. This parameter specifies the name associated with a voice mail routing number.

**Range:** *ayyyyyyy*

1 alphabetic character followed by 7 alphanumeric characters.

### Example

```
rtrv-vflx-rn:rname=rn01
```

```
rtrv-vflx-rn:rn=123456789ABC
```

```
rtrv-vflx-rn
```

```
rtrv-vflx-rn:rname=rn01:refcnt=yes
```

```
rtrv-vflx-rn:rn=123456789ABC:refcnt=yes
```

### Dependencies

The V-Flex feature must be enabled before this command can be entered.

The value specified for the **rname** parameter must already exist in the Routing Number table.

The **rn** and **rname** parameters cannot be specified together in the command.

The value specified for the **rname** parameter cannot be a reserved word, such as **none**.

The value specified for the **rn** parameter must already exist in the Routing Number table.

### Notes

This command can be cancelled using the **F9** function key or the **canc-cmd** command. See **canc-cmd** for more information.



**Output**

The following command displays information for specified routing number name.

**rtrv-vflx-rn:rnname=rn01**

tekelecstp 08-05-29 15:07:01 EST EAGLE 39.0.0

| RN Name | Routing Number  |
|---------|-----------------|
| rn01    | 123456789abcdef |

VFLEX Routing Number table is (2 of 10000) 1% full.

;

The following command displays all of the entries in the Routing Number table.

**rtrv-vflx-rn**

tekelecstp 08-05-29 15:07:01 EST EAGLE 39.0.0

| RN Name | Routing Number  |
|---------|-----------------|
| rn01    | 123456789abcd01 |
| rn02    | 123456789abcd02 |
| rn03    | 123456789abcd03 |
| rn04    | 123456789abcd04 |
| rn05    | 123456789abcd05 |
| rn06    | 123456789abcd06 |
| rn07    | 123456789abcd07 |
| rn08    | 123456789abcd08 |
| rn09    | 123456789abcd09 |
| rn10    | 123456789abcd0A |
| rn11    | 123456789abcd0B |
| rn12    | 123456789abcd0C |
| rn13    | 123456789abcd0D |
| rn14    | 123456789abcd0E |
| rn15    | 123456789abcd0F |

|         |                 |
|---------|-----------------|
| .       | .               |
| .       | .               |
| .       | .               |
| .       | .               |
| rn10000 | 100000000abcdef |

VFLEX Routing Number table is (10000 of 10000) 100% full.

;

The following command displays information, including the reference count, for a specified routing number name.

**rtrv-vflx-rn:rnname=rn01:refcnt=yes**

tekelecstp 08-05-29 15:07:01 EST EAGLE 39.0.0

| RN Name | Routing Number  | Ref Count |
|---------|-----------------|-----------|
| rn01    | 123456789abcdef | 2         |

VFLEX Routing Number table is (2 of 10000) 1% full.

;

The following command displays information, including the reference count, for a specified routing number.

**rtrv-vflx-rn:rn=123456789ABC:refcnt=yes**

tekelecstp 08-05-29 15:07:01 EST EAGLE 39.0.0

| RN Name | Routing Number | Ref Count |
|---------|----------------|-----------|
|---------|----------------|-----------|

```

-----
rn02      123456789abc      3
-----
VFLEX Routing Number table is (2 of 10000) 1% full.
;

```

**Legend**

- **RN Name**—Voice mail routing number name
- **Routing Number**—Voice mail routing number digits
- **Ref Count**—Number of VMSID table entries that refer to an routing number entry

**rtrv-vflx-vmsid****Retrieve V-Flex VMSID Entry**

Use this command to retrieve information for voice mail server IDs.

**NOTE: The V-Flex feature must be enabled before this command can be entered.**

**Keyword:** rtrv-vflx-vmsid

**Related Commands:** chg-vflx-vmsid, dlt-vflx-vmsid, ent-vflx-vmsid

**Command Class:** Database Administration

**Parameters**

**:id=** (optional)

This parameter specifies the voice mail server ID.

**Range:** 1-15 digits, **dflt**

Valid digits are **0-9, A-F, a-f**.

**dflt**—a default set of routing numbers that is used when a query is received with an invalid MSISDN or an MSISDN that is not found in the RTDB

**:rname=** (optional)

This parameter specifies a routing number name associated with the voice mail server ID.

**Range:** *ayyyyyyy*

1 alphabetic character followed by up to 7 alphanumeric characters.

**Example**

```

rtrv-vflx-vmsid
rtrv-vflx-vmsid:id=123456789012345
rtrv-vflx-vmsid:rname=rn90

```

**Dependencies**

The value specified for the **rname** parameter cannot be a reserved word, such as **none**.

The V-Flex feature must be enabled before this command can be entered.

The value specified for the **rname** parameter must already exist in the Routing Number table.

The value specified for the **id** parameter must already exist in the VMSID table.

The **rname** and **id** parameters cannot be specified together in the command.

**Notes**

This command can be cancelled using the **F9** function key or the **canc-cmd** command. See **canc-cmd** for more information.

**Output**

The following command retrieves all of the entries from the VMSID table.

**rtrv-vflx-vmsid**

rlghncxa03w 08-05-07 11:11:28 EST EAGLE 39.0.0

| VMS ID          | IDX0     | IDX1     | IDX2     | IDX3     | IDX4     | IDX5     |
|-----------------|----------|----------|----------|----------|----------|----------|
| 123456789abcdef | RN000000 | RN000001 | RN000002 | RN000003 | RN000004 | RN000005 |
|                 | IDX6     | IDX7     | IDX8     | IDX9     |          |          |
|                 | RN000006 | RN000007 | RN000008 | RN000009 |          |          |

| VMS ID          | IDX0     | IDX1     | IDX2     | IDX3     | IDX4     | IDX5     |
|-----------------|----------|----------|----------|----------|----------|----------|
| 123456789012abc | RN000010 | RN000011 | RN000012 | RN000013 | RN000014 | RN000015 |
|                 | IDX6     | IDX7     | IDX8     | IDX9     |          |          |
|                 | RN000016 | RN000017 | RN000018 | RN000019 |          |          |

| VMS ID          | IDX0     | IDX1     | IDX2     | IDX3     | IDX4     | IDX5     |
|-----------------|----------|----------|----------|----------|----------|----------|
| a23456789012abc | RN000020 | RN000021 | RN000022 | RN000023 | RN000024 | RN000025 |
|                 | IDX6     | IDX7     | IDX8     | IDX9     |          |          |
|                 | RN000026 | RN000027 | RN000028 | RN000029 |          |          |

VFLEX VMSID table is (3 of 1000) 1% full.

;

The following command retrieves an entry with the default voice mail server ID.

**rtrv-vflx-vmsid:id=dflt**

tekelecstp 08-05-29 15:07:01 EST EAGLE 39.0.0

| VMS ID | IDX0     | IDX1     | IDX2     | IDX3     | IDX4     | IDX5     |
|--------|----------|----------|----------|----------|----------|----------|
| dflt   | RN000040 | RN000041 | RN000042 | RN000043 | RN000044 | RN000045 |
|        | IDX6     | IDX7     | IDX8     | IDX9     |          |          |
|        | RN000046 | RN000047 | RN000048 | RN000049 |          |          |

VFLEX VMSID table is (3 of 1000) 1% full.

;

**Legend**

- VMS ID**—Voice Mail Server ID.
- IDX0**—Routing Number Name for index 0.
- IDX1**—Routing Number Name for index 1.
- IDX2**—Routing Number Name for index 2.
- IDX3**—Routing Number Name for index 3.
- IDX4**—Routing Number Name for index 4.

**IDX5**—Routing Number Name for index 5.

**IDX6**—Routing Number Name for index 6.

**IDX7**—Routing Number Name for index 7.

**IDX8**—Routing Number Name for index 8.

**IDX9**—Routing Number Name for index 9.

## rtrv-x25-dstn

## Retrieve X.25 Destination

Use this command to show the associations between X.25 network addresses and SS7 point codes. If the node is actually in the X.25 domain, the X.25 address is a real network address and the point code is a dummy point code. If the node is in the SS7 domain, the point code is a real SS7 point code and the X.25 address is a dummy address. X.25 destinations are shown in order of entry.

**NOTE: This command is obsolete.**

**Keyword:** rtrv-x25-dstn

**Related Commands:** chg-x25-dstn, dlt-x25-dstn, ent-x25-dstn

**Command Class:** Database Administration

### Parameters

**:dpc=** (optional)

Specifies the value used to set the destination point code field in the routing label of the MSU. The point code is an ANSI point code in the format of *network indicator-network cluster-network cluster member (ni-nc-ncm)*.

**Synonym:** dpca

**Range:** 000-255

Specify a valid value for each subfield of the point code, and separate the subfields with a dash (-).

When **chg-sid:pctype=ansi** is specified, *ni = 000* is not valid.

When **chg-sid:pctype=ansi** is specified, *nc = 000* is not valid if *ni = 001-005*.

When **chg-sid:pctype=ansi** is specified, *nc = 000* is valid if *ni = 006-255*.

The point code **000-000-000** is not a valid point code.

**:xaddr=** (optional)

The X.25 network address of the X.25 destination entity or the SS7 node

**Range:** 1-15 digits

**Default:** Display all

### Example

```
rtrv-x25-dstn
rtrv-x25-dstn:xaddr=220525586456772
rtrv-x25-dstn:dpc=133-13-1
```

### Dependencies

If an X.25 address is specified, it must contain a minimum of four digits and must be in the X.25 destination table.

If a destination point code is specified, it must be assigned to at least one X.25 address.

The X.25 SS7 ANSI destination point code must be a full point code (ni-nc-ncm).

**Notes**

None

**Output****rtrv-x25-dstn**

```

tekelecstp 02-06-19 21:16:37 EST EAGLE 31.3.0
X25 ADDR          SS7 DPC      SSN  DOMAIN
220525586456772  133-013-001  002  X25
2342342325       251-001-004  236  SS7
23423423         251-001-001  112  SS7
423423045656767  251-001-003  112  X25
9342             251-001-004  234  X25

```

```
X.25 DSTN TABLE IS (5 of 1024) 1 % FULL
```

;

**rtrv-x25-dstn:xaddr=220525586456772**

```

tekelecstp 02-06-19 21:17:37 EST EAGLE 31.3.0
X25 ADDR          SS7 DPC      SSN  DOMAIN
220525586456772  133-013-001  002  X25

```

```
X.25 DSTN TABLE IS (5 of 1024) 1 % FULL
```

;

**Legend****X25 ADDR**—The X.25 address of the X.25 destination or the SS7 node**SS7 DPC**—The SS7 destination point code.**SSN**—The subsystem number associated with the SS7 DPC.**rtrv-x25-rte****Retrieve X.25 Route**

Use this command to show the routing parameters needed by the gateway portion of the LIMs with the **ss7gx25** application for establishing a virtual circuit that is permanently maintained by the system.

**NOTE: This command is obsolete.**

**Keyword:** **rtrv-x25-rte**

**Related Commands:** **chg-x25-rte, dlt-x25-rte, ent-x25-rte**

**Command Class:** Database Administration

**Parameters**

**:lc=** (optional)

The number of the logical channel on the X.25 signaling link that the PVC connection is assigned to. For automatic virtual circuits and remote virtual circuits, the logical channel number is arbitrary and cannot be specified.

**Range:** 1-255

**Default:** Display all

**:lc2nm=** (optional)

Generates network management for failures and recoveries of logical channels. When the logical channel being used to carry data fails, the Database Transport Access (DTA) feature requires that traffic be diverted to alternate routes. The Logical Channel to Network Management Mapping (LC2NM) feature handles this process.

**Range:** yes, no

**Default:** Display all

**:loc=** (optional)

The card location containing the X.25 signaling link that will sustain the connection. For an automatic virtual circuit, this link is the link on which the system initially attempts the connection. However, if this attempt fails, the connection may be established by the X.25 destination entity on any other link in this link's linkset.

**Range:** 1101-1108, 1111-1112, 1201-1208, 1211-1218, 1301-1308, 1311-1318, 2101-2108, 2111-2118, 2201-2208, 2211-2218, 2301-2308, 2311-2318, 3101-3108, 3111-3118, 3201-3208, 3211-3218, 3301-3308, 3311-3318, 4101-4108, 4111-4118, 4201-4208, 4211-4218, 4301-4308, 4311-4318, 5101-5108, 5111-5118, 5201-5208, 5211-5218, 5301-5308, 5311-5318, 6101-6108, 6111-6118

**Default:** All card locations are shown.

**:port=** (optional)

The port on the card containing the X.25 signaling link.

**Range:** a

**Default:** a

**:rt=** (optional)

The type of routing to perform for messages originating in the SS7 domain and destined for the X.25 domain. Two types of routing are available: (1) route on X.25 destination point code (XPC), and (2) route using X.25 origination and destination point code combinations (PC).

**Range:** xpc, pc

**Default:** Display all

**:saddr=** (optional)

The alias X.25 address assigned to the SS7 destination entity on the SS7 side of the circuit.

**Range:** 1-15 digits

**Default:** All X.25 addresses assigned to the SS7 destination entity are shown.

**:type=** (optional)

The type of X.25 connection that the link is expected to maintain.

**Range:** pvc, svca, svcr

**pvc** — Permanent virtual circuit

**svca** — Automatic virtual circuit

**svcr** — Remote virtual circuit

**Default:** Display all

**:xaddr=** (optional)

The X.25 address assigned to the X.25 destination entity on the X.25 side of the circuit.

**Range:** 1-15 digits

**Default:** All X.25 addresses assigned to the SS7 destination entity are shown.

### Example

```
rtrv-x25-rte
rtrv-x25-rte:xaddr=345454
rtrv-x25-rte:saddr=4545434
rtrv-x25-rte:xaddr=345454:saddr=4545434
rtrv-x25-rte:loc=1201:port=a:lc=2
rtrv-x25-rte:loc=1201:port=a
rtrv-x25-rte:type=avc
rtrv-x25-rte:rt=xpc
```

**rtrv-x25-rte:lc2nm=no**

### Dependencies

Each X.25 address must have at least four digits.

If the **port** parameter is specified, the **loc** parameter must be specified.

If the **lc** parameter is specified, both the **loc** and **port** parameters must be specified.

The **limds0**, **limocu**, and **limv35** card types are the only valid card types for this command. These card types must be running the ss7gx25 GPL type.

The shelf and card must be equipped.

If **lc2nm=yes** is specified, **rt=pc** cannot be specified.

### Notes

None

## Output

**rtrv-x25-rte**

```

rlghncxa03w 03-11-19 21:16:37 EST EAGLE 31.3.0
X25 ADDR          SS7 ADDR          TYPE LOC  PORT  LC  RT   LC2NM
2510010011234567 342342341234567 pvc 1201  a   02  XPC  YES
251001002         234234231         pvc 1201  a   04  PC   NO
51200105          34223422845       svca 1202  a   --  PC   NO
2510103           232330            pvc 1201  a   06  XPC  YES
2510103           232330            svcr ----  -   --  PC   NO
2516019002        24247235          svca 3205  a   --  PC   NO
345454            4545434           svca 1201  a   --  PC   NO
X.25 ROUTE TABLE IS 30 % FULL

```

;

**rtrv-x25-rte:xaddr=345454**

```

rlghncxa03w 03-11-19 21:16:37 EST EAGLE 31.3.0
X25 ADDR          SS7 ADDR          TYPE LOC  PORT  LC  RT   LC2NM
345454            4545434           svca 1201  a   --  PC   NO
X.25 ROUTE TABLE IS 30 % FULL

```

;

**rtrv-x25-rte:saddr=4545434**

```

rlghncxa03w 03-11-19 21:16:37 EST EAGLE 31.3.0
X25 ADDR          SS7 ADDR          TYPE LOC  PORT  LC  RT   LC2NM
345454            4545434           svca 1201  a   --  PC   NO
X.25 ROUTE TABLE IS 30 % FULL

```

;

**rtrv-x25-rte:xaddr=345454:saddr=4545434**

```

rlghncxa03w 03-11-19 21:17:04 EST EAGLE 31.3.0
X25 ADDR          SS7 ADDR          TYPE LOC  PORT  LC  RT   LC2NM
345454            4545434           svca 1201  a   --  PC   NO
X.25 ROUTE TABLE IS 30 % FULL

```

;

**rtrv-x25-rte:loc=1201:port=a:lc=2**

```

rlghncxa03w 03-11-19 21:17:04 EST EAGLE 31.3.0
X25 ADDR          SS7 ADDR          TYPE LOC  PORT  LC  RT   LC2NM
2510010011234567 342342341234567 pvc 1201  a   02  PC   NO
X.25 ROUTE TABLE IS 30 % FULL

```

;

**rtrv-x25-rte:loc=1201:port=a**

```

rlghncxa03w 03-11-19 21:17:04 EST EAGLE 31.3.0
X25 ADDR          SS7 ADDR          TYPE LOC  PORT  LC  RT   LC2NM
2510010011234567 342342341234567 pvc 1201  a   02  PC   NO
251001002         234234231         pvc 1201  a   04  XPC  YES
345454            4545434           svca 1201  a   --  PC   NO
X.25 ROUTE TABLE IS 30 % FULL

```

;

**rtrv-x25-rte:type=svca**

```

rlghncxa03w 03-11-19 21:16:37 EST EAGLE 31.3.0
X25 ADDR          SS7 ADDR          TYPE LOC  PORT  LC  RT   LC2NM
51200105          34223422845       svca 1202  a   --  PC   NO
2516019002        24247235          svca 3205  a   --  PC   NO
345454            4545434           svca 1201  a   --  PC   NO
X.25 ROUTE TABLE IS 30 % FULL

```

;

**rtrv-x25-rte:type=svcr**

```

rlghncxa03w 03-11-19 21:16:37 EST EAGLE 31.3.0
X25 ADDR          SS7 ADDR          TYPE LOC  PORT  LC  RT   LC2NM
2510103           232330            svcr ----  -   --  PC   NO
X.25 ROUTE TABLE IS 30 % FULL

```

;



*Legend*

**X25 ADDR**—The X.25 address assigned to the X.25 destination entity on the X.25 side of the circuit.

**SS7 ADDR**—The dummy X.25 address assigned to the SS7 destination entity on the SS7 side of the circuit.

**TYPE**—The X.25 connection type.

**LOC**—The card location of the X.25 signaling link.

**PORT**—The signaling link port on the card.

**LC**—The number of the logical channel on the X.25 signaling link that the PVC connection is assigned to.

**RT**—The type of routing to perform for messages originating in the SS7 domain and destined for the X.25 domain.

**LC2NM**—Whether the logical channel-to-network management function is enabled (**YES**) or disabled (**NO**).

**rtrv-x25-slk****Retrieve X.25 Signaling Link Parameters**

Use this command to display the X.25 signaling link parameters.

**NOTE: This command is obsolete.**

**Keyword:** rtrv-x25-slk

**Related Commands:** chg-x25-slk

**Command Class:** Database Administration

**Parameters**

**:loc=** (optional)

The card location containing the X.25 signaling link.

**Range:** 1101-1108, 1111-1112, 1201-1208, 1211-1218, 1301-1308, 1311-1318, 2101-2108, 2111-2118, 2201-2208, 2211-2218, 2301-2308, 2311-2318, 3101-3108, 3111-3118, 3201-3208, 3211-3218, 3301-3308, 3311-3318, 4101-4108, 4111-4118, 4201-4208, 4211-4218, 4301-4308, 4311-4318, 5101-5108, 5111-5118, 5201-5208, 5211-5218, 5301-5308, 5311-5318, 6101-6108, 6111-6118

**Default:** All card locations are displayed.

**:port=** (optional)

The port on the card containing the X.25 signaling link.

**Range:** a

**Example**

```
rtrv-x25-slk
```

```
rtrv-x25-slk:loc=1204
```

```
rtrv-x25-slk:loc=1204:port=a
```

**Dependencies**

The **limds0**, **limocu**, and **limv35** card types are the only valid card types for this command. These card types must be running the **ss7gx25** GPL.

The shelf and card must be equipped.

The **port** parameter and the **loc** parameter must be specified together in the command.

**Notes**

None

**Output****rtrv-x25-slk**

```

rlghncxa03w 02-06-10 11:43:04 EST EAGLE 29.0
LOC  PORT  T1  N1    N2  K  L3MODE  PVC  SVC  WIN  MPS
1201  A     10  2104  15  7  DCE     25  205  1   256
1202  A     9   1080  13  6  DTE    255  0    2   256
1203  A     8   2104  11  5  DCE    10   10   3   128
1204  A     7   1080  9   4  DTE     0   255  4   128
1205  A     6   2104  7   3  DCE    100  0    5   256
1206  A     5   1080  5   2  DTE     0   100  6   256
1207  A     4   2104  3   1  DCE    100  100  7   128
1208  A     3   1080  5   2  DTE     1    1    6   128

```

```
x25-slk table is (8 of 256) 3% full
```

;

**rtrv-x25-slk:loc=1204**

```

rlghncxa03w 03-11-19 21:16:37 EST EAGLE 31.3.0
LOC  PORT  T1  N1    N2  K  L3MODE  PVC  SVC  WIN  MPS
1204  A     7   1080  9   4  DTE     0   255  4   128

```

;

**rtrv-x25-slk:loc=1201:port=a**

```

rlghncxa03w 03-11-19 21:16:37 EST EAGLE 31.3.0
LOC  PORT  T1  N1    N2  K  L3MODE  PVC  SVC  WIN  MPS
1201  A     10  2104  15  7  DCE     25  205  1   256

```

;

**Legend**

**LOC**—The card location containing the X.25 signaling link.

**PORT**—The port on the card containing the X.25 signaling link.

**T1**—The amount of time to wait before retransmitting a frame.

**N1**—The maximum number of bits in a frame.

**N2**—The maximum number of retransmission attempts to complete a transmission.

**K**—The maximum number of outstanding I frames.

**L3MODE**—The logical layer 3 address of the connection

**PVC**—The total number of permanent virtual circuits (PVCs) available on this X.25 signaling link.

**SVC**—The total number of switched virtual circuits (automatic virtual circuits and remote virtual circuits) available on this X.25 signaling link.

**WIN**—The number of packets allowed for a window on this X.25 signaling link.

**MPS**—The maximum packet size (in bytes) allowed on this X.25 signaling link.

**set-date****Set Date**

Use this command to set the date in the system.

**Keyword:** set-date  
**Related Commands:** set-time  
**Command Class:** Security Administration

### Parameters

**:date=** (mandatory)  
 The system date, to be reflected on all reports and output messages.  
**Range:** 000101-991231  
 (in the form *yymmdd*, where *yy*=year, *mm*=month, *dd*=day)

### Example

```
set-date : date = 010307
```

### Dependencies

None

### Notes

None

### Output

```
set-date : date = 010307

rlghncxa03w 03-11-07 11:11:28 EST EAGLE 31.3.0
Date set complete.
;
```

## set-gtwy-acthresh

## Set Gateway Thresholds

Use this command to set or change the level of activity thresholds to be used when reporting gateway screening activity. The STP reports screening activity only if the threshold is set and only if the threshold is reached. The thresholds are set on a linkset basis.

**Keyword:** set-gtwy-acthresh  
**Related Commands:** rtrv-gtwy-acthresh  
**Command Class:** Database Administration

### Parameters

**:intrvl=** (mandatory)  
 Monitor interval. The examination period, in minutes, during which the gateway screening activity thresholds are to be tested.  
**Range:** 5, 10, 15, 20, 30  
**System**  
**Default:** 0 - Indicates that thresholds are not set

**:lsn=** (mandatory)  
 Linkset name  
**Range:** ayyyyyyyyy  
 1 alphabetic character followed by up to 9 alphanumeric characters

**:recv=** (optional)  
 Received message threshold. The threshold for MSUs received on the gateway linkset.  
**Range:** 0-999999  
**Default:** The current value

**System**  
**Default:** 0

**:rej=** (optional)

Reject threshold. The threshold for MSUs rejected on the gateway linkset because of screening.

**Range:** 0-999999

**Default:** The current value

**System**  
**Default:** 0

### Example

The following example shows how to set the linkset wy644368 rejection threshold to 100, with a 15 minute interval.

```
set-gtwy-acthresh:lsn=wy644368:rej=100:intrvl=15
```

The following example shows how to set the linkset wy644368 message threshold to 1000 and the rejection threshold to 300, with an interval of 20 minutes.

```
set-gtwy-acthresh:lsn=wy644368:intrv=20:rej=300:recv=1000
```

The following example shows how to set the linkset wy644368 so that no activity messages are produced.

```
set-gtwy-acthresh:lsn=wy644368:intrv=5:rej=0:recv=0
```

### Dependencies

At least one optional parameter must be specified.

The linkset specified must exist in the gateway linkset entity set of the requesting system.

The linkset specified must exist in the active database.

The value specified for INTRVL parameter is not one of **5, 10, 15, 20** or **30** minutes.

### Notes

None

### Output

```
set-gtwy-acthresh:lsn=wy644368:rej=100:intrvl=15
```

```
r1ghncxa03w 03-11-18 08:50:12 EST EAGLE 31.3.0
SET-GTWY-TRHSHLD: MASP A - COMPLTD
```

```
;
```

## set-scrrej-prmtrs

### Set Parameters for SS7 Message-Rejection Reporting

Use this command to change the STP values that limit the display of MSUs rejected because of gateway screening notification messages that could become excessive. The new values overwrite the existing values.

**Keyword:** set-scrrej-prmtrs

**Related Commands:** rtrv-gtwy-acthresh, rtrv-gtwy-prmtrs, set-gtwy-acthresh

**Command Class:** Database Administration

### Parameters

**:intrvl=** (mandatory)

Monitor interval. The examination period, in minutes, during which the gateway screening activity thresholds are to be tested.

**Range:** 5, 10, 15, 20, 30  
**System**  
**Default:** 5

**:limit=** (mandatory)  
 Threshold not to be exceeded.  
**Range:** 0-9999  
**System**  
**Default:** 9999

**Example**

```
set-scrrej-prmtrs:limit=200:intrvl=10
```

**Dependencies**

The value specified for INTRVL parameter is not one of 5, 10, 15, 20 or 30 minutes.

**Notes**

None

**Output**

```
set-scrrej-prmtrs:limit=200:intrvl=10

rlghncxa03w 03-11-18 08:50:12 EST EAGLE 31.3.0
SET-SCRREJ-PRMTRS: MASP A - COMPLTD
;
```

**set-time**

**Set Time**

Use this command to set the system clock. The clock is used to determine when measurements collection takes place as well as several other time-driven events.

**Keyword:** set-time  
**Related Commands:** set-date  
**Command Class:** Security Administration

**Parameters**

**:time=** (mandatory)  
 The system time that is to be reflected on all reports and output messages.  
**Range:** 0000-2359  
*hhmm* where *hh* = 00-23 (hour) and *mm* = 00-59 (minute)

**:tz=** (optional)  
 The time zone  
**Range:** est, edt, cst, cdt, mst, mdt, pst, pdt, hst, hdt, ast, adt, gmt, wet, west, utc, bst, cet, cest, met, mest, fwt, fst, eet, eest, sast, msk, msd, ist, idt, cct, awst, awdt, rok, acst, acdt, aest, aedt, nzst, nzdt, akst, akdt, nst, ndt, bra  
 The time zones are described in Table 5-82.  
**Default:** Current value

Table 5-82. Time Zones Set by the set-time command

| Abbreviation | Time Zone                        | Abbreviation | Time Zone                        |
|--------------|----------------------------------|--------------|----------------------------------|
| <b>est</b>   | Eastern Standard Time            | <b>edt</b>   | Eastern Daylight Time            |
| <b>cest</b>  | Central Standard Time            | <b>cdt</b>   | Central Daylight Time            |
| <b>mst</b>   | Mountain Standard Time           | <b>mdt</b>   | Mountain Daylight Time           |
| <b>pst</b>   | Pacific Standard Time            | <b>pdtd</b>  | Pacific Daylight Time            |
| <b>hst</b>   | Hawaiian Standard Time           | <b>hdt</b>   | Hawaiian Daylight Time           |
| <b>ast</b>   | Atlantic Standard Time           | <b>adt</b>   | Atlantic Daylight Time           |
| <b>gmt</b>   | Greenwich Mean Time              | <b>wet</b>   | Western European Time            |
| <b>west</b>  | Western European Summer Time     | <b>utc</b>   | Universal Time Coordinated       |
| <b>bst</b>   | British Summer Time              | <b>cet</b>   | Central European Time            |
| <b>cest</b>  | Central European Summer Time     | <b>met</b>   | Middle European Time             |
| <b>mest</b>  | Middle European Summer Time      | <b>fwtd</b>  | French Winter Time               |
| <b>fst</b>   | French Summer Time               | <b>eet</b>   | Eastern European Time            |
| <b>eest</b>  | Eastern European Summer Time     | <b>sast</b>  | South African Standard Time      |
| <b>msk</b>   | Moscow Time                      | <b>msdtd</b> | Moscow Summer Time               |
| <b>ist</b>   | India Standard Time              | <b>idt</b>   | India Daylight Time              |
| <b>cct</b>   | China Coast Time                 | <b>awstd</b> | Australian Western Standard Time |
| <b>awdtd</b> | Australian Western Daylight Time | <b>rok</b>   | Republic of Korea                |
| <b>acstd</b> | Australian Central Standard Time | <b>acdtd</b> | Australian Central Daylight Time |
| <b>aest</b>  | Australian Eastern Standard Time | <b>aedtd</b> | Australian Eastern Daylight Time |

**Table 5-82.** Time Zones Set by the **set-time** command

| Abbreviation | Time Zone                  | Abbreviation | Time Zone                  |
|--------------|----------------------------|--------------|----------------------------|
| <b>nzst</b>  | New Zealand Standard Time  | <b>nzdt</b>  | New Zealand Daylight Time  |
| <b>akst</b>  | Alaska Standard Time       | <b>akdt</b>  | Alaska Daylight Time       |
| <b>nst</b>   | Newfoundland Standard Time | <b>ndt</b>   | Newfoundland Daylight Time |
| <b>bra</b>   | Brazil Standard Time       |              |                            |

**Example**

```
set-time:time=1432:tz=est
```

**Dependencies**

None

**Notes**

None

**Output**

```
set-time:time=1432:tz=est
rlghncxa03w 02-11-07 14:32:28 EST EAGLE 30.0.0
Time set complete.
;
```

**set-uim-acthresh**

**Set Activity Level Thresholds for STP UIM Activity Reporting**

Use this command to set or change the level-of-activity threshold for reporting UIM messages. The system suppresses the generation of UIM messages when message generation exceeds the threshold that was defined for the interval period. The values are set within five seconds after the command was entered. Any previous count is cleared and the new or changed threshold and limit is enforced. Refer to “Configuring the UIM Threshold” in the *Database Administration Manual – System Management* for more information about UIM threshold configuration.

**Keyword:** set-uim-acthresh

**Related Commands:** dlt-uim-acthresh, rtrv-uim-acthresh

**Command Class:** Database Administration

**Parameters**

**:intrvl=** (mandatory)

The monitor interval in minutes.

**Range:** 5, 10, 15, 20, 25, 30

**Default:** Current value

**:uimn=** (mandatory)

The UIM number.

**Range:** 1000-1499

**:force=** (optional)

Required to set the **limit** parameter to 0 for a given interval.



**CAUTION:** Setting the limit to 0 turns off all occurrences of the specified UIM. Use this manner of creating thresholds only if you are certain you have specified the correct UIM.

CAUTION

**Range:** yes, no  
**Default:** no force specified

**:limit=** (optional)  
 The message threshold.



**CAUTION:** Setting the limit to 0 will turn off all occurrences of the specified UIM. This can be dangerous if the wrong UIM number is specified by mistake. It is highly recommended that thresholds for UIMs are not set in this manner, but the ability is provided for certain extreme cases. The force parameter must be specified to set the limit to 0, and an additional scroll area message is issued.

CAUTION

**Range:** 0-9999  
**Default:** Current value

### Example

Sets UIM number 1333 threshold to 100 in a 5-minute interval:

```
set-uim-acthresh:uimn=1333:limit=100:intrvl=5
```

Sets UIM number 1444 threshold to 200 in a 15-minute interval:

```
set-uim-acthresh:uimn=1444:limit=200:intrvl=15
```

### Dependencies

At least one optional parameter must be specified.

The **uimn** parameter value must be a numeric value in the range **1000–1499**.

The **limit** parameter value must be a numeric value in the range **0–9999**.

The **intrvl** parameter value must be one or two numeric characters with the following values: **5, 10, 15, 20, 25, 30**.

The **force=yes** parameter must be specified to set the **limit** parameter to **0** for a given interval. Setting the **limit** to **0** turns off all occurrences of the specified UIM. See the cautions under the **force** and **limit** parameters.

When creating a new UIM threshold, both the **limit** and **intrvl** parameters must be specified.

The specified **uimn** parameter value must exist in the system Trouble Text table.

### Notes

None

### Output

```
set-uim-acthresh:uimn=1333:limit=100:intrvl=5
```

```
rlghncxa03w 03-11-01 08:50:12 EST EAGLE 31.3.0
SET-UIM-ACTHRESH: MASP A - COMPLTD
```

```
;
```

## tst-bip

## Test Board Identification PROM

Use this command to test each byte of the specified board identification PROM (BIP) by reading and writing to the PROM. The test is performed for both the main assembly and applique BIPs.



**Keyword:** **tst-bip**

**Related Commands:** **chg-bip-fld, chg-bip-rec, rtrv-bip**

**Command Class:** System Maintenance

### Parameters

**:loc=** (mandatory)

The card location as stenciled on the shelf of the system.

**Range:** **1101-1112, 1201-1218, 1301-1318, 2101-2118, 2201-2218, 2301-2318, 3101-3118, 3201-3218, 3301-3318, 4101-4118, 4201-4218, 4301-4318, 5101-5118, 5201-5218, 5301-5318, 6101-6118**

**NOTE:** xy09 and xy10 locations are valid only if they are equipped with HIPR2 card.

### Example

```
tst-bip:loc=1211
```

### Dependencies

The card location, frame, shelf, or slot must be within the allowed range.

The card location must be valid for the command.

The board type **type=dbd** parameter is not valid for card type GPSM-II, HCAP, ATM or DCM. HMUX and HIPR cards do not contain BIP information.

The card specified by the **loc** parameter must be equipped in the database.

The card specified by the **loc** parameter must be in the OOS-MT-DSBLD state prior to BIP testing.

### Notes

The specified card must be inhibited.

The **tst-bip** command verifies that the PROM is good by writing and reading to the PROM. The **rtrv-bip** command show the level of the BIP, as well as the board part number, the revision number, and the serial number. If the **rtrv-bip** command fails, this indicates that communications to the card has failed, and the card should be replaced.

### Output

```
tst-bip:loc=1211
```

```
rlghncxa03w 03-11-07 16:19:08 EST EAGLE 31.3.0
Test Board Identification PROM Location: 1211 - MBD Packet: 1
```

```
-----
BIP Passed
```

```
rlghncxa03w 03-11-07 16:19:08 EST EAGLE 31.3.0
Test Board Identification PROM Location: 1211 - DBD Packet: 1
```

```
-----
BIP Passed
```

```
;
```

### tst-disk

### Test Disk

Use this command prior to an upgrade, or as a diagnostic tool, to test the integrity of an EAGLE 5 ISS fixed drive or removable cartridge or drive, at the specified location. The test is non-intrusive and non-destructive to the disk. A read-only test is executed for all logical blocks (LBAs) used on the specified target disk and a report identifying any bad or questionable LBAs is output.

**Keyword:** `tst-disk`  
**Related Commands:** `copy-disk`  
**Command Class:** System Maintenance

### Parameters

**:loc=** (mandatory)

The location of the disk to be tested.

**Range:** **1114, 1116, 1117, 1113, 1115**

**1114** — The TDM

**1116** — The TDM

**1117** — The removable cartridge drive

**1113** — The latched USB port

**1115** — The latched USB port

**:disk=** (optional)

This parameter specifies the disk that is being tested.

**Range:** **remove, fixed, usb**

**remove** — The removable drive

**fixed** — The fixed drive

**usb** — Argument to be used by Tekelec personnel only.

**:partition=** (optional)

Portion of disk to be tested. This parameter specifies the individual physical disk partition (1, 2, 3, or 4) or all defined partitions for a given disk size up to a maximum of 4 partitions.

**Range:** **1, 2, 3, 4, all**

**1, 2, 3, 4**—Tests the specified existing partition on the disk. Only the number or numbers for the partition or partitions that exist on the disk are valid. (For example, if the disk size allows only 2 partitions, **partition=3** and **partition=4** are invalid for that disk.)

**all**—Tests all existing partitions on the fixed disk or on one side of the removable cartridge or drive

**Default:** **all**

### Example

```
tst-disk:loc=1116
```

### Dependencies

The card in the specified location (**loc**) must be a TDM or MDAL card.

The disk to be tested must be in service.

If a TDM location is specified, the TDM cannot be reserved (as when a `copy-disk` command is running).

The target drive must have low level format.

The **tst-disk** command can be run simultaneously on both TDMs, if entered from different terminals.

The removable disk can be tested simultaneously with the standby TDM but not with the active TDM.

To test the removable cartridge when **loc=1117** is specified, the disk must be inserted in the removable cartridge drive on the MDAL card.

The **partition=3** and **partition=4** values are invalid for a 4GB fixed drive. The only valid value for the 2.3 GB and 4.1 GB removable disks is **partition=1**. An error message will be generated for a disk that has been Formatted (**format-disk** command) but does not yet contain a DOS directory structure (created with the **copy-disk** command) when **partition= 1, 2, 3, 4, or all** is specified.

If an E5-MCAP card is installed, then the **tst-disk** command cannot be entered when other database commands are running.

If an E5-TDM card is installed, then the **disk=fixed** parameter cannot be specified.

**Notes**

A physical fixed disk (TDM) or removable cartridge or drive is formatted and given a DOS directory structure to define the number of physical partitions that the disk size can accommodate. (The logical partitions that contain database, backup, GPL, and measurements files are placed in these physical partitions, with no correlation between the physical numbers and the logical contents.)

For a fixed TDM disk, the **partition** parameter specifies the individual partition (1, 2, 3, or 4) or all existing partitions to be tested.

- One partition = 2 GB.
- The 4 GB drive contains two 2 GB partitions.
- The 9 GB drive and the 18 GB drive each contain four 2 GB partitions.
- The 9 GB drive contains four 2 GB partitions.
- Any disk space beyond the four 2 GB partitions is unused disk space (and always has been due to EAGLE DISK FAT structure used).

For a removable cartridge or drive, each side of the disk will contain the maximum number of partitions (up to 4) that the disk size can accommodate. Only one side of the disk is tested with one **tst-disk** command. For example, a 2.3 GB removable disk has one partition on each side that is slightly larger than 1 GB. A 4.1 GB removable disk has one 2 GB partition on each side. Only **tst-disk:partition=1** is valid for either of these disks.

The **partition=all** value implies that testing starts with the first partition, then second, and so on, until the last existing disk partition is detected without skipping any non-existing or defined partitions.

Table 5-83 outlines execution time estimates based on disk capacity.

**Table 5-83.** Test Disk Execution Times

| Capacity                         | Nominal Execution Time                                                                                                                  | Maximum Execution Time for 100% Errors |
|----------------------------------|-----------------------------------------------------------------------------------------------------------------------------------------|----------------------------------------|
| 4.0 GB                           | 40 minutes                                                                                                                              | 27.5 hours                             |
| 9.0 GB                           | 1 hour 45 minutes                                                                                                                       | (Not determined)                       |
| 18 GB                            | 30 minutes (partition=1)<br>5 hours (partition=disk)<br>depending on amount of disk tested<br>and EAGLE 5 ISS provisioning/<br>activity | (Not determined)                       |
| 2.3 GB Magneto Optical Removable | 18 minutes                                                                                                                              | 7.4 hours                              |
| 4.1 GB Magneto Optical Removable | 25 minutes<br>(requires 806 MDAL)                                                                                                       | 7.4 hours                              |
| 507 MB                           | 5 minutes                                                                                                                               | 3.4 hours                              |

**Table 5-83.** Test Disk Execution Times

| <b>Capacity</b>           | <b>Nominal Execution Time</b> | <b>Maximum Execution Time for 100% Errors</b> |
|---------------------------|-------------------------------|-----------------------------------------------|
| 2.0 GB                    | 20 minutes                    | 13.5 hours                                    |
| 4.0 GB                    | 40 minutes                    | 27.5 hours                                    |
| Magneto Optical Removable | 20 minutes                    | 7.4 hours                                     |
| Removable Drive           | 30 seconds                    | Less than 1 minute                            |

Nominal times for **tst-disk** command execution depend on the capacity of the disk being tested and assume that few or no errors are found. Maximum execution times are based on disk capacity, retry count, and retry delay. Each read error and retry may cause a delay of up to three seconds. If a TDM has 100% error sectors, the MASP will likely reset, terminating the disk test. A termination and reset will not occur, however, when testing the removable cartridge or drive.

Because of the intense, sustained disk activity created when **tst-disk** is executed, concurrently performing other disk-based activities, such as prolonged LNP command entry or database backups, will result in performance degradation up to twice the usual execution time.

Because of the extended processing time required for large disks, a progress message is displayed every five minutes providing the current LBA and the total LBA count for the partition.

Specific errors are reported for the first 10 error occurrences. Thereafter, only the error count is tracked and summary results are reported upon completion.

**Output**

```

tst-disk:loc=1116
  rlghncxa03w 03-11-27 11:40:02 EST  EAGLE 31.3.0
  TST-DISK of all partitions initiated for TDM 1116
;

  rlghncxa03w 03-11-27 11:40:02 EST  EAGLE 31.3.0
  TST-DISK: TDM 1116 in progress 868680 of 4124735 LBA read
;

  rlghncxa03w 03-11-27 11:40:02 EST  EAGLE 31.3.0
  TST-DISK Error: TDM 1116 LBA range 4124706 - 4124960
  Check Condition: DISK_NOT_READY
  TST-DISK results for TDM 1116
  Total LBAs = 4124735    LBA size = 512
  Retries    = 1    Errors    = 1
  Command Completed
;

tst-disk:loc=1116:partition=2
  rlghncxa03w 03-11-27 11:40:02 EST  EAGLE 31.3.0
  TST-DISK on Partition 2 initiated for TDM 1116
;

  rlghncxa03w 03-11-27 11:40:02 EST  EAGLE 31.3.0
  TST-DISK: TDM 1116 in progress 1234567 of 4194304 LBA read
;

  rlghncxa03w 03-11-27 11:40:02 EST  EAGLE 31.3.0
  TST-DISK Error: TDM 1116 LBA range 4194304 - 4194558
  (NOTE: w/i 2nd disk partition)
  Check Condition: DISK_NOT_READY
  TST-DISK results for TDM 1116
  Total LBAs = 4194304    LBA size = 512
  Retries    = 1    Errors    = 1
  Command Completed
;

```

**tst-dlk****Test Data Link**

Use this command to test the specified TCP/IP data link. The TCP/IP data link is tested with an ethernet test that is an echo test type called ping.

**Keyword:** **tst-dlk**

**Related Commands:** **act-dlk, canc-dlk, dlt-dlk, ent-dlk, rept-stat-dlk, rtrv-dlk**

**Command Class:** Link Maintenance

**Parameters**

**:loc=** (mandatory)

The card location as stenciled on the shelf of the system.

**Range:** **1101-1108, 1111-1112, 1201-1208, 1211-1218, 1301-1308, 1311-1318, 2101-2108, 2111-2118, 2201-2208, 2211-2218, 2301-2308, 2311-2318, 3101-3108, 3111-3118, 3201-3208, 3211-3218, 3301-3308, 3311-3318, 4101-4108, 4111-4118, 4201-4208, 4211-4218, 4301-4308, 4311-4318, 5101-5108, 5111-5118, 5201-5208, 5211-5218, 5301-5308, 5311-5318, 6101-6108, 6111-6118**

**:type=** (mandatory)

The type of test to run.

**Range:** **ping**

**:ipaddr=** (optional)

The IP address of the remote host. This is a TCP/IP address expressed in standard dot notation. IP addresses consist of the system's network number and the machine's unique host number. An example IP address is **192.126.100.5**, where **192.126.100** is the network number and **5** is the machine's host number.

**Range:** 1-223, 0-255

4 numbers separated by dots

**1-223**—first number

**0-255**—the other three numbers

**Default:** Host IP

**:rc=** (optional)

The number of times the test is repeated.

**Range:** 1-15

**Default:** 1

**Example**

```
tst-dlk: loc=1206:type=ping
```

**Dependencies**

No other action command can be in progress when this command is entered.

The card location must contain an ACM card.

The shelf and card must be equipped.

The specified card must have a TCP/IP data link assigned to it.

If a test repeat count (**rc**) is not entered, the test is not repeated.

If a data link test is in progress, another data link test cannot be started.

The card location, frame, shelf, or slot must be within the allowed range.

A card location that is valid and defined in the database must be specified.

The **ipaddr** parameter must specify a valid IP address.

**Notes**

None

**Output**

```
tst-dlk:loc=1206:type=ping
```

```
rlghncxa03w 03-11-27 17:00:36 EST EAGLE 31.3.0
Command Accepted: Test Link message is sent.
```

```
rlghncxa03w 03-11-27 17:00:36 EST EAGLE 31.3.0
Command Completed.
```

```
rlghncxa03w 03-11-27 17:00:36 EST EAGLE 31.3.0
1310.1132 CARD 1206 INFO STPLAN DLK ping test completed
TESTS REQUESTED= 1 PASSED COUNT= 1 FAILED COUNT= 0
AVR RND TRIP= 10 MAX RND TRIP=10 MIN RND TRIP=10
HOST IPADDR=198.089.040.069
```

```
;
```

**tst-e1****Test E1 Port**

Use this command to test HC-MIM and E5-E1T1 E1 ports. The **tst-e1** command is rejected if a loopback test is not compatible with the port type.

**Keyword:** **tst-e1**

**Related Commands:** **chg-e1, dlt-e1, ent-e1, rtrv-e1**

**Command Class:** System Maintenance

## Parameters

**:e1port=** (mandatory)

E1 port number. The value must be an E1 port that has already been configured with an E1 interface on the specified HC-MIM or E5-E1T1 E1 card.

**Range:** **1-8**

Ports 3 - 8 can be specified only for HC-MIM and E5-E1T1 cards.

**:loc=** (mandatory)

Card location. The HC-MIM or E5-E1T1 card location as stenciled on the shelf of the system.

**Range:** **1101-1108, 1111-1112, 1201-1208, 1211-1218, 1301-1308, 1311-1318, 2101-2108, 2111-2118, 2201-2208, 2211-2218, 2301-2308, 2311-2318, 3101-3108, 3111-3118, 3201-3208, 3211-3218, 3301-3308, 3311-3318, 4101-4108, 4111-4118, 4201-4208, 4211-4218, 4301-4308, 4311-4318, 5101-5108, 5111-5118, 5201-5208, 5211-5218, 5301-5308, 5311-5318, 6101-6108, 6111-6118**

**:action=** (optional)

Indicator of command action to stop or start a test.

**Range:** **start, stop**

**Default:** **start**

**:loopback=** (optional)

Select loopback test type.

**Range:** **line, lxvr, payload**

**lxvr** — local transceiver

**Default:** **lxvr**

## Example

```
tst-e1:e1port=1:loc=1203:loopback=lxvr
```

```
tst-e1:e1port=1:loc=1203:action=stop
```

## Dependencies

This command cannot be entered during upgrade.

The card in the specified card location (**loc** parameter) must be an HC-MIM or E5-E1T1 card with card type **lime1**.

The card in the specified card location (**loc** parameter) must be equipped.

The card in the specified card location (**loc** parameter) must be in service.

The specified E1 port (**e1port** parameter) on the card (**loc** parameter) must have a defined E1 interface.

All signaling links that provide timeslots serviced by E1 interfaces on the specified card (**loc** parameter) must be deactivated before this command can be entered. None of the signaling links can be running link diagnostic tests (**tst-slk** and **act-cdl**) when this command is entered.

Only one port test can be running on an E1 port (**e1port** parameter) at one time.

When the **action=stop** parameter is specified, the **loopback** parameter cannot be specified.

The **action=stop** parameter can be specified only when a port test is running.

## Notes

This command can be used for only HC-MIM and E5-E1T1 card ports.

Only one port test can be performed at a time on an E1 port. When a port test is in progress on an E1 port, subsequent test requests are rejected.

### Output

```
tst-e1:elport=1:loc=1203:loopback=lxvr

rlghncxa03w 05-01-07 16:19:08 EST EAGLE5 33.0.0
Command Accepted: Test Port message is sent.
;
rlghncxa03w 05-01-07 16:19:08 EST EAGLE5 33.0.0
Command Completed.
;

tst-e1:elport=1:loc=1203:action=stop

rlghncxa03w 05-01-07 16:19:08 EST EAGLE5 33.0.0
Command Accepted: Stop Port test message is sent.
;

rlghncxa03w 05-01-07 16:19:08 EST EAGLE5 33.0.0
Command Completed.
;
```

### tst-imt

### Test IMT Bus

The interprocessor message transport bus (IMT bus) is the main communications artery between all subsystems in the system. Use this command to determine the location of faults on a failed or abnormal IMT bus. The alternate bus state must be IS-NR. The target bus state must be OOS-MT-DSBLD. Notice: IMT Fault test terminated. Non-Standard cabling or IMT Bus-X state change detected.

**NOTE: At least one card must be populated in each EAGLE 5 ISS shelf to allow tst-imt the opportunity to successfully execute. See the "Notes" section for this command for more information about executing the command.**

**Keyword:** tst-imt

**Related Commands:** clr-imt-stats, init-imt-gpl, rept-imt-lvl1, rept-imt-lvl2

**Command Class:** System Maintenance

### Parameters

**:bus=** (mandatory)  
The IMT bus to test.  
**Range:** a, b

### Example

```
tst-imt:bus=a
tst-imt:bus=b
```

### Dependencies

A related IMT command must not be in progress. Only one fault isolation test can be active at a time.

This command cannot be entered if the alternate bus is other than in-service normal (IS-NR).

This command cannot be entered if the target bus is other than out of service - maintenance disabled (OOS-MT-DSBLD).

This command cannot be entered during the IMT statistics collection period following an hourly boundary (IMT performance monitoring).



**Notes**

Probable causes are listed in order of most probable to least probable. The listed components should be replaced in order listed by the output of the **tst-imt** command.

Multiple, masking points of failure can occur in the same bus segment. Such faults are reported as a single bus segment fault. Because running this command on a system with no IMT bus faults prints an indication that no faults were found, you can iteratively replace components and run this test until all components in the segment are ruled out.

A detection of an IMT address mismatch indicates a faulty backplane or card.

A detection of an inconsistency with a particular card's IMT card list indicates an error of unknown origin, probably due to one or more lost messages.

When the **tst-imt** command completes, either through normal termination of the command or because the command was ended for another reason, you must administratively enable the target bus. If all faults have meanwhile been isolated and corrected, the target bus becomes operational.

When a fault is detected, the possible error sources are listed in order from the most likely to the least likely. This ordering is based on operational experience.

At least one card must be populated in each EAGLE 5 ISS shelf to allow the **tst-imt** command to execute successfully. The card does not need to be a provisioned card; the card must be in IS-NR state on both IMT busses before the **tst-imt** command is entered. If an empty shelf does exist in the EAGLE 5 ISS, the following text is displayed when the **tst-imt** command is entered:

```
Notice: IMT Fault test terminated.
```

```
.
```

```
Non-Standard cabling or IMT Bus-X state change detected.
```

**Output**

Connectivity test fails

**tst-imt:bus=a**

```
rlghncxa03w 09-06-27 12:47:07 EST EAGLE 41.1.0
IMT Fault Isolation Bus A
Fault Location    Probable Cause  Failure(s)
Bus 1218-1301    HIPR 1209
                   HIPR2 1309
                   Card 1218
                   Card 1301
                   Cable connecting Shelves 1200 and 1300 on Bus A
                   Backplane 1200
                   Backplane 1300
                                     Connectivity Test Failed
Bus 1304-1305    HIPR2 1309
                   Card 1304
                   Card 1305
                   Backplane 1300
                                     Connectivity Test Failed
;
```

Pass-through test fails.

**tst-imt:bus=a**

```
rlghncxa03w 03-11-27 12:47:07 EST EAGLE 31.3.0
IMT Fault Isolation Bus B
Fault Location    Probable Cause  Failure(s)
Card 1201         Card 1201
                                     Pass-through Test Failed
Card 1301         Card 1301
                                     Pass-through Test Failed
;
```

All tests pass.

**tst-imt:bus=b**

```
rlghncxa03w 03-11-27 12:47:07 EST EAGLE 31.3.0
IMT Fault Isolation Bus B
Fault Location    Probable Cause  Failure(s)
No Faults Found
                                     All Tests Passed.
;
```

**tst-msg****Test Tool Test message**

Use this command to invoke the Test Tool to test the feature call flow for the specified test message from the TESTMSG table.

The command sends the specified message from the TESTMSG table to an EAGLE 5 ISS Service Feature. The test message that is sent does not create a new raw MSU. The test message is used only to modify the internal data structures of the Service Feature to study the call flow behavior when a message with the specified parameters is injected into the call path. The test message is never sent out to the network.

**Keyword:** `tst-msg`

**Related Commands:** `chg-gsm-msg`, `chg-is41-msg`, `chg-isup-msg`, `chg-sccp-msg`, `chg-tatr-msg`, `chg-ttr-msg`, `rtrv-gsm-msg`, `rtrv-is41-msg`, `rtrv-isup-msg`, `rtrv-sccp-msg`, `rtrv-tatr-msg`, `rtrv-ttr-msg`

**Command Class:** Database Administration

## Parameters

### **:feat=** (mandatory)

Feature. This parameter specifies the EAGLE 5 ISS Service Feature where the message is processed on the network card.

**Range:** **ttr, tif, tif2, tif3, mosmsnpp, gtt, iar**

**ttr**— Service Feature for processing Prepaid IDP Query Relay test messages

**tif**— Service Feature for processing ISUP test messages when the provisioned Gateway Screening Stop Action is TIF.

**tif2**— Service Feature for processing ISUP test messages when the provisioned Gateway Screening Stop Action is TIF2.

**tif3**— Service Feature for processing ISUP test messages when the provisioned Gateway Screening Stop Action is TIF3.

**mosmsnpp**— Service Feature for processing MO SMS NPP test messages

**gtt**— Service feature for processing GTT test messages.

**iar**— Service Feature for processing IAR test messages

### **:loc=** (mandatory)

Card location. The location of the network card where the message is to be sent.

**Range:** **1101-1108, 1111-1112, 1201-1208, 1211-1218, 1301-1308, 1311-1318, 2101-2108, 2111-2118, 2201-2208, 2211-2218, 2301-2308, 2311-2318, 3101-3108, 3111-3118, 3201-3208, 3211-3218, 3301-3308, 3311-3318, 4101-4108, 4111-4118, 4201-4208, 4211-4218, 4301-4308, 4311-4318, 5101-5108, 5111-5118, 5201-5208, 5211-5218, 5301-5308, 5311-5318, 6101-6108, 6111-6118**

### **:msgn=** (mandatory)

Message number. This parameter specifies the message number of the test message to be sent for feature service processing.

**Range:** **1-10**

### **:prot=** (mandatory)

Protocol. This parameter specifies the protocol of the test message that is sent to the feature for processing.

**Range:** **ttr, isup, is41, gsm, sccp, tatr**

### **:mode=** (optional)

Output mode. This parameter specifies the mode in which output is shown while processing is performed on the specified test message.

**NOTE: The most complete and accurate test results are obtained when mode=debug is used.**

**Range:** **brief, full, debug**

**brief**— summary format

**full**— full format

**debug**— debug format

**Default:** **brief**

## Example

```
tst-msg:loc=1103:prot=is41:feat=mosmsnpp:msgn=1:mode=full
```

```
tst-msg:loc=1103:prot=ttr:feat=ttr:msgn=1:mode=full
```

```
tst-msg:loc=1103:prot=gsm:feat=mosmsnpp:msgn=1:mode=debug
```

```
tst-msg:msgn=1:prot=isup:loc=1215:feat=tif:mode=debug
```

```
tst-msg:loc=1103:prot=sccp:feat=gtt:msgn=1
```

## Dependencies

The Prepaid IDP Query Relay feature must be enabled before the **feat=ttr** parameter can be specified.

The card in the location that is specified in the **loc** parameter must be equipped in the system.

The card in the location specified by the **loc** parameter must be a Service Module card running the **vsccp** application (a DSM card or an E5-SM4G card).

The card in the location specified in the **loc** parameter must be in the Active state.

The values specified for the **prot** and **feat** parameters must be compatible. Valid combinations are shown in Table 5-84.

**Table 5-84.** Valid PROT and FEAT Combinations

| FEAT                   | Prot             |
|------------------------|------------------|
| <b>ttr</b>             | <b>ttr</b>       |
| <b>iar</b>             | <b>tatr</b>      |
| <b>tif, tif2, tif3</b> | <b>isup</b>      |
| <b>mosmsnpp</b>        | <b>gsm, is41</b> |
| <b>gtt</b>             | <b>sccp</b>      |

If the specified test message is defined with ACTIVE=YES (see the **chg-isup-msg** command), then the message is sent to the specified network card for test processing. (Test messages are never sent out to the live network.)

The MO SMS ASD, MO SMS GRN, MO SMS IS41-to-GSM Migration, or MO-based IS1 SMS NP feature must be enabled before the **feat=mosmsnpp** and **prot=is41** parameters can be specified.

The MO SMS ASD, MO SMS GRN, Prepaid SMS Intercept Ph1, MO-based GSM SMS NP, or Portability Check for MO SMS feature must be enabled before the **feat=mosmsnpp** and **prot=gsm** parameters can be specified.

At least one TIF feature must be enabled before a value of **tif**, **tif2**, or **tif3** can be specified for the **feat** parameter.

The FLOBR feature must be turned on before the **prot=sccp** and **feat=gtt** parameters can be specified.

For an ANSI message, the CDPA GTI must be **2** and the CGPA GTI must be **0** or **2** (see the **chg-sccp-msg** command). For an ITU message, the CDPA GTI must be **2** or **4** and the CGPA GTI must be **0**, **2**, or **4**.

The linkset specified by the **lsn** parameter must already exist.

The network domain of the values specified for the OPC, CGPA PC and CDPA PC must match.

The IAR Base feature must be enabled before the **feat=iar** parameter can be specified.

## Notes

None

## Output

When the **mode=full** or **mode=debug** parameter is specified, the **FORMAT** field indicates whether formatting actions are executed. If formatting actions are not executed, then the **OUTG DIGITS** field displays a value of **UNMODIFIED**. If any digit string is blank, then the associated field displays a value of **EMPTY**.

The following example displays the command output in brief format.

**tst-msg:feat=ttr:prot=ttr:msgn=1:mode=brief**

```
tekelecstp 09-08-05 18:20:46 EST EAGLE 41.1.0
tst-msg:feat=ttr:prot=ttr:msgn=1:mode=brief
Command Accepted: Test message is sent.
;
```

```
TST-MSG-RESULT
=====
```

```
MSG = 1          TCAP_TYPE = INAP
```

```
SCCP
```

```
CGPA_GT = 2
CGPA_GT_NAI = 4      CGPA = 9111111111
CDPA_GT = 2
CDPA_GT_NAI = 4      CDPA = 9818555001
```

```
TCAP
```

```
SK = 6balb1c1      BCSM = 02
CGPN_NAI = 4        CGPN = 919818000005
CDPN_NAI = 4        CDPN = 919818000001
```

```
CDPN NPP PROCESSING
```

```
SERVICE NAME = idprcdpn SERVICE STATUS = ON
INC DIGITS = 919818000001
NAI = 4 FNAI = intl FDL = 12
```

```
MATCHING RULE
```

```
FNAI = intl FDL = * FPFX = *
ACTION SET NAME = cdprintl
```

```
CONDITIONING RESULT
```

```
INC DIGITS = 919818000001
COND DIGITS = 919818000001
```

```
FORMATING RESULT
```

```
OUTG DIGITS = 00910123459818000001
OUTG FNAI = intl
```

```
tekelecstp 09-08-05 18:20:46 EST EAGLE 41.1.0
```

```
CGPN NPP PROCESSING
```

```
SERVICE NAME = idprcgnp SERVICE STATUS = ON
INC DIGITS = 919818000005
NAI = 4 FNAI = intl FDL = 12
```

```
MATCHING RULE
```

```
FNAI = intl FDL = 12 FPFX = *
ACTION SET NAME = cgpn1
```

```
CONDITIONING RESULT
```

```
INC DIGITS = 919818000005
```

```
COND DIGITS = 919818000005
```

```
FORMATING RESULT
```

```
OUTG DIGITS = 00915432109818000005
OUTG FNAI = intl
```

```
;
```

The following example displays the command output in full format.

```
tst-msg:feat=ttr:prot=ttr:msgn=1:mode=full
```

```
tekelecstp 09-08-05 18:20:46 EST EAGLE 41.1.0
tst-msg:feat=ttr:prot=ttr:msgn=1:mode=full
Command Accepted: Test message is sent.
```

```
;
```

```
TST-MSG-RESULT
```

```
=====
```

```
MSG = 1          TCAP_TYPE = INAP
```

```
SCCP
```

```
CGPA_GT = 2
CGPA_GT_NAI = 4      CGPA = 9111111111
CDPA_GT = 2
CDPA_GT_NAI = 4      CDPA = 9818555001
```

```
TCAP
```

```
SK = 6balb1c1      BCSM = 02
CGPN_NAI = 4        CGPN = 919818000005
CDPN_NAI = 4        CDPN = 919818000001
```

```
CDPN NPP PROCESSING
```

```
SERVICE NAME = idprcdpn SERVICE STATUS = ON
INC DIGITS = 919818000001
NAI = 4 FNAI = intl FDL = 12
```

```
MATCHING RULE
```

```
FNAI = intl FDL = * FPFX = *
ACTION SET NAME = cdpnintl
```

```
CONDITIONING RESULT
```

```
CA1 = cc2          EXECUTED = Y RESULT = PASS
CA2 = ac2          EXECUTED = Y RESULT = PASS
CA3 = snx          EXECUTED = Y RESULT = PASS
INC DIGITS = 919818000001
COND DIGITS = 919818000001
```

```
SERVICE APPLICATION
```

```
SA1 = ccncchk      EXECUTED = Y FORMAT = Y
SA2 = cdpnp        EXECUTED = Y FORMAT = Y
SA3 = cgpnpqrq     EXECUTED = Y FORMAT = Y
```

```
FORMATING RESULT
```

```
FA1 = dlma        EXECUTED = Y RESULT = PASS
FA2 = cc          EXECUTED = Y RESULT = PASS
FA3 = rn          EXECUTED = Y RESULT = PASS
FA4 = ac          EXECUTED = Y RESULT = PASS
FA5 = sn          EXECUTED = Y RESULT = PASS
OUTG DIGITS = 00910123459818000001
OUTG FNAI = intl
```

```
;
```

```
tekelecstp 09-08-05 18:20:46 EST EAGLE 41.1.0
```

```
CGPN NPP PROCESSING
```

```

SERVICE NAME = idprcgp SERVICE STATUS = ON
  INC DIGITS = 919818000005
  NAI = 4 FNAI = intl FDL = 12

MATCHING RULE
  FNAI = intl FDL = 12 FPFX = *
  ACTION SET NAME = cgpn1

CONDITIONING RESULT
  CA1 = cc2          EXECUTED = Y RESULT = PASS
  CA2 = ac2          EXECUTED = Y RESULT = PASS
  CA3 = sn8          EXECUTED = Y RESULT = PASS
  INC DIGITS = 919818000005
  COND DIGITS = 919818000005

SERVICE APPLICATION
  SA1 = cgpnnp      EXECUTED = Y FORMAT = Y

FORMATING RESULT
  FA1 = dlma        EXECUTED = Y RESULT = PASS
  FA2 = cc           EXECUTED = Y RESULT = PASS
  FA3 = rn           EXECUTED = Y RESULT = PASS
  FA4 = ac           EXECUTED = Y RESULT = PASS
  FA5 = sn           EXECUTED = Y RESULT = PASS
  OUTG DIGITS = 00915432109818000005
  OUTG FNAI = intl
;

```

The following example displays the command output in debug format for the TTR protocol.

**tst-msg:feat=ttr:prot=ttr:msgn=1:mode=debug**

```

tekelecstp 09-08-05 18:20:46 EST EAGLE 41.1.0
tst-msg:feat=ttr:prot=ttr:msgn=1:mode=debug
Command Accepted: Test message is sent.
;

```

```

TST-MSG-RESULT
=====

MSG = 2          TCAP_TYPE = INAP

SCCP
  CGPA_GT = 4
  CGPA_GT_NAI = 4      CGPA = 9111111111
  CDPA_GT = 4
  CDPA_GT_NAI = 4      CDPA = 9818555001

TCAP
  SK = 6balb1c1      BCSM = 02
  CGPN_NAI = 4        CGPN = 919818000005
  CDPN_NAI = 4        CDPN = 009090919818000001

CDPN NPP PROCESSING

SERVICE NAME = idprcdpn SERVICE STATUS = ON
  INC DIGITS = 009090919818000001
  NAI = 4 FNAI = intl FDL = 18

MATCHING RULE
  FNAI = intl FDL = 18 FPFX = 00
  ACTION SET NAME = cdpn6

CONDITIONING RESULT
  CA1 = fpx          EXECUTED = Y RESULT = PASS
  CA2 = pfxa4        EXECUTED = Y RESULT = PASS
  CA3 = cc2          EXECUTED = Y RESULT = PASS
  CA4 = ac2          EXECUTED = Y RESULT = PASS

```

```

CA5 = sn8          EXECUTED = Y RESULT = PASS
INC DIGITS = 009090919818000001
COND DIGITS = 919818000001

SERVICE APPLICATION
SA1 = ccncchk     EXECUTED = Y FORMAT = Y
CCNC Check Passed
SA2 = cdpnp       EXECUTED = Y FORMAT = Y
RTDB LKPSUCC Entity=1 Cdpn=919818000001
SA3 = lacck       EXECUTED = Y FORMAT = Y
FFPX & PFXA FAs set to None
SA4 = cgpnpqrq   EXECUTED = Y FORMAT = Y

FORMATING RESULT
FA1 = fpfx        EXECUTED = Y RESULT = PASS
FA2 = pfxa        EXECUTED = Y RESULT = PASS
FA3 = dlma        EXECUTED = Y RESULT = PASS
FA4 = cc          EXECUTED = Y RESULT = PASS
FA5 = rn          EXECUTED = Y RESULT = PASS
FA6 = ac          EXECUTED = Y RESULT = PASS
FA7 = sn          EXECUTED = Y RESULT = PASS
OUTG DIGITS = 00910123459818000001
OUTG FNAI = intl

```

;

tekelecstp 09-08-05 18:20:46 EST EAGLE 41.1.0

CGPN NPP PROCESSING

```

SERVICE NAME = idprcgpn SERVICE STATUS = ON
INC DIGITS = 919818000005
NAI = 4 FNAI = intl FDL = 12

```

MATCHING RULE

```

FNAI = intl FDL = 12 FPFX = *
ACTION SET NAME = cgpnl

```

CONDITIONING RESULT

```

CA1 = cc2        EXECUTED = Y RESULT = PASS
CA2 = ac2        EXECUTED = Y RESULT = PASS
CA3 = sn8        EXECUTED = Y RESULT = PASS
INC DIGITS = 919818000005
COND DIGITS = 919818000005

```

SERVICE APPLICATION

```

SA1 = cgpnp      EXECUTED = Y FORMAT = Y
RTDB LKPSUCC Entity=1 Cgpn=919818000005

```

FORMATING RESULT

```

FA1 = dlma       EXECUTED = Y RESULT = PASS
FA2 = cc         EXECUTED = Y RESULT = PASS

```

;

The following command displays the output in debug format when the ISUP protocol is used.

**tst-msg:msgn=1:loc=2217:prot=isup:feat=tif3:mode=debug**

tklc1191001 09-08-08 08:06:03 EST EAGLE5 41.1.0

```

SERVICE NAME = tif3 SERVICE STATUS = ON
INC DIGITS = 1970442001
NAI = 4 FNAI = intl FDL = 10

```

MATCHING RULE

```

FNAI = intl FDL = * FPFX = 1970
ACTION SET NAME = temp3

```



```

CONDITIONING RESULT
  CA1 = ccl          EXECUTED = Y RESULT = PASS
  CA2 = dnx          EXECUTED = Y RESULT = PASS
  INC DIGITS = 1970442001
  COND DIGITS = 1970442001

SERVICE APPLICATION
  SA1 = nprls        EXECUTED = Y FORMAT = Y
  INDIV RLS redir=1 cause=np(0) RN=ffffff SP=dd02001

FORMATING RESULT
  FA1 = rn           EXECUTED = Y RESULT = PASS
  FA2 = cc           EXECUTED = Y RESULT = PASS
  OUTG DIGITS = fffffff1
  OUTG FNAI = intl
    
```

;

The following command displays the output in brief format when the MO SMS NPP IS41 protocol is used.

**tst-msg:feat=mosmsnpp:loc=1101:prot=is41:msgn=1:mode=brief**

```

tekelecstp 09-08-02 10:46:51 EST EAGLE 41.1.0
tst-msg:feat=mosmsnpp:loc=1101:prot=is41:msgn=1:mode=brief
Command Accepted: Test message is sent.
    
```

;

```

TST-MSG-RESULT
=====
MSG = 1
    
```

```

CGPA_GT = 4
CGPA_GT_NAI = 4    CGPA = 0123456789abcde
    
```

```

CDPA_GT = 4
CDPA_GT_NAI = 4    CDPA = 0123456789abcde
    
```

```

CGPN_NAI = 1      CGPN_NP = 2
CGPN_ES = 1      CGPN = 919899999901
    
```

```

CDPN_NAI = 1      CDPN_NP = 2
CDPN_ES = 1      CDPN = 919918000004
    
```

MOSMSICGPN NPP PROCESSING

```

SERVICE NAME = mosmsicgpn SERVICE STATUS = ON
  INC DIGITS = 919899999901
  NAI = 1 FNAI = intl FDL = 12
    
```

```

MATCHING RULE
  FNAI = intl FDL = * FPFX = *
  ACTION SET NAME = asdgrn1
    
```

```

CONDITIONING RESULT
  INC DIGITS = 919899999901
  COND DIGITS = 919899999901
    
```

```

FORMATING RESULT
  OUTG DIGITS = 919899999901
  OUTG FNAI = intl
    
```

;

```

eagle1 09-08-02 08:45:05 EST EAGLE 41.1.0
    
```

MOSMSICDPN NPP PROCESSING

```

SERVICE NAME = mosmsicdpn SERVICE STATUS = ON
  INC DIGITS = 919918000004
  NAI = 1 FNAI = intl FDL = 12

MATCHING RULE
  FNAI = intl FDL = 12 FPFX = *
  ACTION SET NAME = cgpnasd1

CONDITIONING RESULT
  INC DIGITS = 919918000004
  COND DIGITS = 919918000004

FORMATING RESULT
  OUTG DIGITS = 917777444409918000004
  OUTG FNAI = intl

```

;

The following command displays the output in full format when the MO SMS NPP IS41 protocol is used.

**tst-msg:feat=mosmsnpp:loc=1101:prot=is41:msgn=1:mode=full**

```

tekelecstp 09-08-02 10:51:51 EST EAGLE 41.1.0
tst-msg:feat=mosmsnpp:loc=1101:prot=is41:msgn=1:mode=full
Command Accepted: Test message is sent.

```

;

```

TST-MSG-RESULT
=====
MSG = 1

CGPA_GT = 4
CGPA_GT_NAI = 4      CGPA = 0123456789abcde

CDPA_GT = 4
CDPA_GT_NAI = 4      CDPA = 0123456789abcde

CGPN_NAI = 1          CGPN_NP = 2
CGPN_ES = 1           CGPN = 919899999901

CDPN_NAI = 1          CDPN_NP = 2
CDPN_ES = 1           CDPN = 919918000004

MOSMSICGPN NPP PROCESSING

SERVICE NAME = mosmsicgpn SERVICE STATUS = ON
  INC DIGITS = 919899999901
  NAI = 1 FNAI = intl FDL = 12

MATCHING RULE
  FNAI = intl FDL = * FPFX = *
  ACTION SET NAME = asdgrn1

CONDITIONING RESULT
  CA1 = cc2           EXECUTED = Y RESULT = PASS
  CA2 = dnx           EXECUTED = Y RESULT = PASS
  INC DIGITS = 919899999901
  COND DIGITS = 919899999901

SERVICE APPLICATION
  SA1 = asdlkup       EXECUTED = Y FORMAT IND = N
  SA2 = grnlkup       EXECUTED = Y FORMAT IND = N

FORMATING RESULT
  FA1 = orig          EXECUTED = Y RESULT = PASS

```

```

        OUTG DIGITS = 919899999901
        OUTG FNAI = intl
;

eagle1 09-08-02 08:45:26 EST EAGLE 41.1.0

MOSMSICDPN NPP PROCESSING

SERVICE NAME = mosmsicdpn SERVICE STATUS = ON
    INC DIGITS = 919918000004
    NAI = 1 FNAI = intl FDL = 12

MATCHING RULE
    FNAI = intl FDL = 12 PPFX = *
    ACTION SET NAME = cgpnasd1

CONDITIONING RESULT
    CA1 = cc2          EXECUTED = Y RESULT = PASS
    CA2 = dn10        EXECUTED = Y RESULT = PASS
    INC DIGITS = 919918000004
    COND DIGITS = 919918000004

SERVICE APPLICATION
    SA1 = migrate     EXECUTED = Y FORMAT IND = N
    SA2 = cdpnp       EXECUTED = Y FORMAT IND = N
    SA3 = cgpnasdrqd EXECUTED = Y FORMAT IND = N
    SA4 = cgpngrnrqd EXECUTED = Y FORMAT IND = N

FORMATING RESULT
    FA1 = cc          EXECUTED = Y RESULT = PASS
    FA2 = rn          EXECUTED = Y RESULT = PASS
    FA3 = asd         EXECUTED = Y RESULT = PASS
    FA4 = grn         EXECUTED = Y RESULT = PASS
    FA5 = dn          EXECUTED = Y RESULT = PASS
    OUTG DIGITS = 917777444409918000004
    OUTG FNAI = intl
;

```

The following command displays the output in brief format when the MO SMS NPP GSM protocol is used.

```

tst-msg:feat=mosmsnpp:loc=1101:prot=gsm:msgn=1:mode=brief
tekelecstp 09-08-03 09:23:01 EST EAGLE 41.1.0
tst-msg:feat=mosmsnpp:loc=1101:prot=gsm:msgn=1:mode=brief
Command Accepted: Test message is sent.
;

```

```

TST-MSG-RESULT
=====
MSG = 1
CGPA_GT = 4
CGPA_GT_NAI = 4      CGPA = 0123456789abcde

CDPA_GT = 4
CDPA_GT_NAI = 4      CDPA = 123456789

CGPN_NAI = 1
CGPN_NP = 1          CGPN = 919899999901

CDPN_NAI = 1
CDPN_NP = 1          CDPN = 919918000004

MOSMSGCGPN NPP PROCESSING

SERVICE NAME = mosmsgcgpn SERVICE STATUS = ON

```

```

        INC DIGITS = 919899999901
        NAI = 1 FNAI = intl FDL = 12

MATCHING RULE
        FNAI = intl FDL = * FPFX = *
        ACTION SET NAME = gcgpn1

CONDITIONING RESULT
        INC DIGITS = 919899999901
        COND DIGITS = 919899999901

FORMATING RESULT
        OUTG DIGITS =
        OUTG FNAI = unkn
;

tekelecstp 09-08-03 09:23:01 EST EAGLE 41.1.0

MOSMSGCDPN NPP PROCESSING

SERVICE NAME = mosmsgcdpn SERVICE STATUS = ON
        INC DIGITS = 919918000004
        NAI = 1 FNAI = intl FDL = 12

MATCHING RULE
        FNAI = intl FDL = * FPFX = *
        ACTION SET NAME = gcdpn1

CONDITIONING RESULT
        INC DIGITS = 919918000004
        COND DIGITS = 919918000004

FORMATING RESULT
        OUTG DIGITS = 91777744409918000004
        OUTG FNAI = intl
;

```

The following command displays the output in full format when the MO SMS NPP GSM protocol is used.

```

tst-msg:feat=mosmsnpp:loc=1101:prot=gsm:msgn=1:mode=full
tekelecstp 09-08-03 09:50:01 EST EAGLE 41.1.0
tst-msg:feat=mosmsnpp:loc=1101:prot=gsm:msgn=1:mode=full
Command Accepted: Test message is sent.
;

```

```

TST-MSG-RESULT
=====
MSG = 1
CGPA_GT = 4
CGPA_GT_NAI = 4          CGPA = 0123456789abcde

CDPA_GT = 4
CDPA_GT_NAI = 4          CDPA = 123456789

CGPN_NAI = 1
CGPN_NP = 1              CGPN = 919899999901

CDPN_NAI = 1
CDPN_NP = 1              CDPN = 919918000004

MOSMSGCGPN NPP PROCESSING

SERVICE NAME = mosmsgcgpn SERVICE STATUS = ON
        INC DIGITS = 919899999901

```

```

        NAI = 1 FNAI = intl FDL = 12

MATCHING RULE
    FNAI = intl FDL = * FPFX = *
    ACTION SET NAME = gcgpn1

CONDITIONING RESULT
    CA1 = cc2          EXECUTED = Y RESULT = PASS
    CA2 = dnx          EXECUTED = Y RESULT = PASS
    INC DIGITS = 91989999901
    COND DIGITS = 91989999901

SERVICE APPLICATION
    SA1 = fraudchk    EXECUTED = Y FORMAT IND = N
    SA2 = pprelay     EXECUTED = Y FORMAT IND = Y
    SA3 = asdlkup     EXECUTED = Y FORMAT IND = N
    SA4 = grnlkup     EXECUTED = Y FORMAT IND = N

FORMATING RESULT
    OUTG DIGITS =
    OUTG FNAI = unkn
;

tekelecstp 09-08-03 09:50:01 EST EAGLE 41.1.0

MOSMSGCDPN NPP PROCESSING

SERVICE NAME = mosmsgcdpn SERVICE STATUS = ON
    INC DIGITS = 91991800004
    NAI = 1 FNAI = intl FDL = 12

MATCHING RULE
    FNAI = intl FDL = * FPFX = *
    ACTION SET NAME = gcdpn1

CONDITIONING RESULT
    CA1 = cc2          EXECUTED = Y RESULT = PASS
    CA2 = dnx          EXECUTED = Y RESULT = PASS
    INC DIGITS = 91991800004
    COND DIGITS = 91991800004

SERVICE APPLICATION
    SA1 = pprelay     EXECUTED = Y FORMAT IND = N
    SA2 = cdpnpn      EXECUTED = Y FORMAT IND = N
    SA3 = cgpnasdrqd  EXECUTED = Y FORMAT IND = N
    SA4 = cgpngrnrqd  EXECUTED = Y FORMAT IND = N

FORMATING RESULT
    FA1 = cc          EXECUTED = Y RESULT = PASS
    FA2 = rn          EXECUTED = Y RESULT = PASS
    FA3 = asd         EXECUTED = Y RESULT = PASS
    FA4 = grn         EXECUTED = Y RESULT = PASS
    FA5 = dn          EXECUTED = Y RESULT = PASS
    OUTG DIGITS = 9177774440991800004
    OUTG FNAI = intl
;

```

The following command displays the output in debug format when the MO SMS NPP IS41 protocol is used.

```

tst-msg:feat=mosmsnpp:loc=1101:prot=is41:msgn=1:mode=debug
tekelecstp 09-08-02 10:46:51 EST EAGLE 41.1.0
tst-msg:feat=mosmsnpp:loc=1101:prot=is41:msgn=1:mode=debug
Command Accepted: Test message is sent.
;

```

tekelecstp 09-08-02 10:46:51 EST EAGLE 41.1.0

TST-MSG-RESULT

=====

MSG = 1

CGPA\_GT = 4

CGPA\_GT\_NAI = 4 CGPA = 0123456789abcde

CDPA\_GT = 4

CDPA\_GT\_NAI = 4 CDPA = 0123456789abcde

CGPN\_NAI = 1

CGPN\_NP = 2

CGPN\_ES = 1

CGPN = 919899999901

CDPN\_NAI = 1

CDPN\_NP = 2

CDPN\_ES = 1

CDPN = 919918000004

MOSMSICGPN NPP PROCESSING

SERVICE NAME = mosmsicgpn SERVICE STATUS = ON

INC DIGITS = 919899999901

NAI = 1 FNAI = intl FDL = 12

MATCHING RULE

FNAI = intl FDL = \* FPFX = \*

ACTION SET NAME = asdgrn1

CONDITIONING RESULT

CA1 = cc2 EXECUTED = Y RESULT = PASS

CA2 = dnx EXECUTED = Y RESULT = PASS

INC DIGITS = 919899999901

COND DIGITS = 919899999901

SERVICE APPLICATION

SA1 = asdlkup EXECUTED = Y FORMAT IND = N

ASDLKUP: ASD Data Copied to NPPSTATE:ASD

RTDB LKPSUCC DN=919899999901

PT =5 ASD =444

SP =NONE SRFIMSI=NONE

RN =3000 SRFIMSI=NONE

VMSID=NONE SRFIMSI=NONE

GRN =40 SRFIMSI=NONE

SA2 = grnlkup EXECUTED = Y FORMAT IND = N

GRN Data Copied to NPPSTATE:GRN

FORMATING RESULT

FA1 = orig EXECUTED = Y RESULT = PASS

OUTG DIGITS = 919899999901

OUTG FNAI = intl

;

tekelecstp 09-08-02 10:46:51 EST EAGLE 41.1.0

MOSMSICDPN NPP PROCESSING

SERVICE NAME = mosmsicdpn SERVICE STATUS = ON

INC DIGITS = 919918000004

NAI = 1 FNAI = intl FDL = 12

MATCHING RULE

FNAI = intl FDL = 12 FPFX = \*

ACTION SET NAME = cgpnasd1

```

CONDITIONING RESULT
  CA1 = cc2          EXECUTED = Y RESULT = PASS
  CA2 = dn10        EXECUTED = Y RESULT = PASS
  INC DIGITS = 919918000004
  COND DIGITS = 919918000004

SERVICE APPLICATION
  SA1 = migrate     EXECUTED = Y FORMAT IND = N
  I2GM:Subscriber is not migrated
  RTDB LKPSUCC DN=919918000004
  PT = 255          ASD =56
  SP =NONE          SRFIMSI=NONE
  RN =7777          SRFIMSI=98989
  VMSID=NONE        SRFIMSI=NONE
  GRN =40           SRFIMSI=NONE
  SA2 = cdpnp       EXECUTED = Y FORMAT IND = N
  SMS NP:Validation Passed: NPPSTATE:RN=7777.
  SA3 = cgpnasdrqd EXECUTED = Y FORMAT IND = N
  CGPNASDRQD:CgPN ASD Data Copied to NPPSTATE:ASD
  SA4 = cgpngrnrqd EXECUTED = Y FORMAT IND = N
  CGPNGRNRQD:CgPN GRN Data Copied to NPPSTATE:GRN

FORMATING RESULT
  FA1 = cc          EXECUTED = Y RESULT = PASS
  FA2 = rn          EXECUTED = Y RESULT = PASS
  FA3 = asd         EXECUTED = Y RESULT = PASS
  FA4 = grn         EXECUTED = Y RESULT = PASS
  FA5 = dn          EXECUTED = Y RESULT = PASS
  OUTG DIGITS = 917777444409918000004
  OUTG FNAI = intl
;

```

The following command displays the output in debug format when the MO SMS NPP GSM protocol is used.

**tst-msg:feat=mosmsnpp:loc=1101:prot=gsm:msgn=1:mode=debug**

```

tekelecstp 09-08-02 10:46:51 EST EAGLE 41.1.0
tst-msg:feat=mosmsnpp:loc=1101:prot=gsm:msgn=1:mode=debug
Command Accepted: Test message is sent.
;

```

```

tekelecstp 09-08-02 10:46:51 EST EAGLE 41.1.0

```

```

TST-MSG-RESULT
=====
MSG = 1
CGPA_GT = 4
CGPA_GT_NAI = 4      CGPA = 0123456789abcde

CDPA_GT = 4
CDPA_GT_NAI = 4      CDPA = 123456789

CGPN_NAI = 1
CGPN_NP = 1          CGPN = 919899999901

CDPN_NAI = 1
CDPN_NP = 1          CDPN = 919918000004

```

MOSMSGCGPN NPP PROCESSING

```

SERVICE NAME = mosmsgcgpn SERVICE STATUS = ON
  INC DIGITS = 919899999901
  NAI = 1 FNAI = intl FDL = 12

```

```

MATCHING RULE
  FNAI = intl FDL = * FPFX = *

```

ACTION SET NAME = gcgpn1

## CONDITIONING RESULT

CA1 = cc2 EXECUTED = Y RESULT = PASS  
 CA2 = dnx EXECUTED = Y RESULT = PASS  
 INC DIGITS = 91989999901  
 COND DIGITS = 91989999901

## SERVICE APPLICATION

SA1 = fraudchk EXECUTED = Y FORMAT IND = N  
 FRAUDCHK:CgPN is not Ported/Migrated  
 RTDB LKPSUCC DN=91989999901  
 PT =5 ASD =44  
 SP =NONE SRFIMSI=NONE  
 RN =3000 SRFIMSI=NONE  
 VMSID=NONE SRFIMSI=NONE  
 GRN =40 SRFIMSI=NONE  
 SA2 = pprelay EXECUTED = Y FORMAT IND = Y  
 PPRELAY:DN is Prepaid  
 SA3 = asdlkup EXECUTED = Y FORMAT IND = N  
 ASDLKUP: ASD Data Copied to NPPSTATE:ASD  
 SA4 = grnlkup EXECUTED = Y FORMAT IND = N  
 GRN Data Copied to NPPSTATE:GRN

## FORMATING RESULT

OUTG DIGITS =  
 OUTG FNAI = unkn

;

tekelecstp 09-08-02 10:46:51 EST EAGLE 41.1.0

## MOSMSGCDPN NPP PROCESSING

SERVICE NAME = mosmsgcdpn SERVICE STATUS = ON  
 INC DIGITS = 919918000004  
 NAI = 1 FNAI = intl FDL = 12

## MATCHING RULE

FNAI = intl FDL = \* FPFX = \*  
 ACTION SET NAME = gcdpn1

## CONDITIONING RESULT

CA1 = cc2 EXECUTED = Y RESULT = PASS  
 CA2 = dnx EXECUTED = Y RESULT = PASS  
 INC DIGITS = 919918000004  
 COND DIGITS = 919918000004

## SERVICE APPLICATION

SA1 = pprelay EXECUTED = Y FORMAT IND = N  
 PPRELAY:CgPN is Prepaid, Do not check CdPN prepaid status  
 SA2 = cdpnp EXECUTED = Y FORMAT IND = N  
 SMS NP:Validation Passed: NPPSTATE:RN=7777.  
 RTDB LKPSUCC DN=919918000004  
 PT = 40 ASD =56  
 SP =NONE SRFIMSI=NONE  
 RN =7777 SRFIMSI=98989  
 VMSID=NONE SRFIMSI=NONE  
 GRN =40 SRFIMSI=NONE  
 SA3 = cgpnasdrqd EXECUTED = Y FORMAT IND = N  
 CGPNASDRQD:CgPN ASD Data Copied to NPPSTATE:ASD  
 SA4 = cgpngrnrqd EXECUTED = Y FORMAT IND = N  
 CGPNGRNRQD:CgPN GRN Data Copied to NPPSTATE:GRN

## FORMATING RESULT

FA1 = cc EXECUTED = Y RESULT = PASS



```

FA2 = rn          EXECUTED = Y RESULT = PASS
FA3 = asd        EXECUTED = Y RESULT = PASS
FA4 = grn        EXECUTED = Y RESULT = PASS
FA5 = dn         EXECUTED = Y RESULT = PASS
OUTG DIGITS = 91777744409918000004
OUTG FNAI = intl

```

;

The following command displays the output in debug mode for TIF Number Substitution.

**tst-msg:msgn=1:prot=isup:loc=1215:feat=tif:mode=debug**

tifstp 09-08-06 19:54:03 GMT EAGLE 41.1.0

```

SERVICE NAME = tif SERVICE STATUS = ON
INC DIGITS = 88123456
NAI = 4 FNAI = intl FDL = 8

```

```

MATCHING RULE
FNAI = intl FDL = 8 PPFX = 88
ACTION SET NAME = set1

```

```

CONDITIONING RESULT
CA1 = cc2          EXECUTED = Y RESULT = PASS
CA2 = ac1          EXECUTED = Y RESULT = PASS
CA3 = snx          EXECUTED = Y RESULT = PASS
INC DIGITS = 88123456
COND DIGITS = 88123456

```

```

SERVICE APPLICATION
SA1 = nscdpn       EXECUTED = Y FORMAT = Y
INDIV CC=91 AC=5 SN=46789
SA2 = nscgpn       EXECUTED = Y FORMAT = Y
INDIV InCat=244 InDN=91123456
OutCat=4 OutDN=741852

```

```

FORMATING RESULT
FA1 = cc          EXECUTED = Y RESULT = PASS
FA2 = ac          EXECUTED = Y RESULT = PASS
FA3 = sn          EXECUTED = Y RESULT = PASS
OUTG DIGITS = 91546789
OUTG FNAI = intl

```

;

The following command displays the output in debug mode for TIF Number Substitution.

**tst-msg:msgn=2:prot=isup:loc=1215:feat=tif:mode=debug**

tklc1071001 09-08-05 10:13:22 EDT EAGLE 41.1.0

```

SERVICE NAME = tif SERVICE STATUS = ON
INC DIGITS = 2345678197001
NAI = 4 FNAI = intl FDL = 20

```

```

MATCHING RULE
FNAI = intl FDL = 20 PPFX = 2345
ACTION SET NAME = tifasn1

```

```

CONDITIONING RESULT
CA1 = ign3          EXECUTED = Y RESULT = PASS
CA2 = znx           EXECUTED = Y RESULT = PASS
INC DIGITS = 2345678197001
COND DIGITS = 5678197001

```

```

SERVICE APPLICATION
SA1 = nscdpn       EXECUTED = Y FORMAT = Y
INDIV ZN=8474657346
SA2 = nscgpn       EXECUTED = Y FORMAT = Y

```

```

INDIV InCat=5      InDN=7463467238
      OutCat=7     OutDN=4736475834

```

```

FORMATING RESULT
  OUTG DIGITS = 8474657346
  OUTG FNAI = intl

```

;

The following command displays the output in debug mode for TIF Number Substitution when the Formatting Action for the outgoing CgPN is RN (**tifopts:iamecgn=rn**).

**tst-msg:msgn=3:prot=isup:loc=1103:feat=tif:mode=debug**

```
tifstp 09-08-06 19:52:42 GMT EAGLE 41.1.0
```

```

SERVICE NAME = tif SERVICE STATUS = ON
  INC DIGITS = 88123456
  NAI = 4 FNAI = intl FDL = 8

```

```

MATCHING RULE
  FNAI = intl FDL = 8 PPFX = 88
  ACTION SET NAME = set1

```

```

CONDITIONING RESULT
  CA1 = cc2      EXECUTED = Y RESULT = PASS
  CA2 = ac1      EXECUTED = Y RESULT = PASS
  CA3 = snx      EXECUTED = Y RESULT = PASS
  INC DIGITS = 88123456
  COND DIGITS = 88123456

```

```

SERVICE APPLICATION
  SA1 = nscdgn   EXECUTED = Y FORMAT = Y
  INDIV CC=91 AC=5 SN=46789
  SA2 = nscgpn   EXECUTED = Y FORMAT = Y
  No operation for IAMCGPN=RN

```

```

FORMATING RESULT
  FA1 = cc      EXECUTED = Y RESULT = PASS
  FA2 = ac      EXECUTED = Y RESULT = PASS
  FA3 = sn      EXECUTED = Y RESULT = PASS
  OUTG DIGITS = 91546789
  OUTG FNAI = intl

```

;

The following command displays the output in debug mode for TIF Number Substitution when no CgPN is present in the IAM message.

**tst-msg:msgn=4:prot=isup:loc=1215:feat=tif:mode=debug**

```
tifstp 09-08-06 19:50:08 GMT EAGLE 41.1.0
```

```

SERVICE NAME = tif SERVICE STATUS = ON
  INC DIGITS = 88123456
  NAI = 4 FNAI = intl FDL = 8

```

```

MATCHING RULE
  FNAI = intl FDL = 8 PPFX = 88
  ACTION SET NAME = set1

```

```

CONDITIONING RESULT
  CA1 = cc2      EXECUTED = Y RESULT = PASS
  CA2 = ac1      EXECUTED = Y RESULT = PASS
  CA3 = snx      EXECUTED = Y RESULT = PASS
  INC DIGITS = 88123456
  COND DIGITS = 88123456

```

```

SERVICE APPLICATION
  SA1 = nscdgn   EXECUTED = Y FORMAT = Y
  INDIV CC=91 AC=5 SN=46789

```

```

SA2 = nscgpn      EXECUTED = Y FORMAT = Y
no cgpn

FORMATING RESULT
FA1 = cc          EXECUTED = Y RESULT = PASS
FA2 = ac          EXECUTED = Y RESULT = PASS
FA3 = sn          EXECUTED = Y RESULT = PASS
OUTG DIGITS = 91546789
OUTG FNAI = intl
;

```

The following command displays the output in debug mode for TIF Number Substitution when the incoming Calling Party's Category value is the same as the TIFOPTS **nspublic** option value and the TIFOPTS **nsaddldata** option value is **yes**.

**tst-msg:msgn=5:prot=isup:loc=1103:feat=tif:mode=debug**

tifstp 09-08-06 20:16:09 GMT EAGLE 41.1.0

```

SERVICE NAME = tif SERVICE STATUS = ON
INC DIGITS = 88123456
NAI = 4 FNAI = intl FDL = 8

```

```

MATCHING RULE
FNAI = intl FDL = 8 PFFX = 88
ACTION SET NAME = set1

```

```

CONDITIONING RESULT
CA1 = cc2          EXECUTED = Y RESULT = PASS
CA2 = ac1          EXECUTED = Y RESULT = PASS
CA3 = snx          EXECUTED = Y RESULT = PASS
INC DIGITS = 88123456
COND DIGITS = 88123456

```

```

SERVICE APPLICATION
SA1 = nscdgn       EXECUTED = Y FORMAT = Y
INDIV CC=91 AC=5 SN=46789
SA2 = nscgpn       EXECUTED = Y FORMAT = Y
Incoming CgPN category is NSPublic

```

```

FORMATING RESULT
FA1 = cc          EXECUTED = Y RESULT = PASS
FA2 = ac          EXECUTED = Y RESULT = PASS
FA3 = sn          EXECUTED = Y RESULT = PASS
OUTG DIGITS = 91546789
OUTG FNAI = intl
;

```

The following command displays the output when the FLOBR feature is turned on.

**tst-msg:msgn=4:feat=gtt:prot=sccp:loc=1101**

tekelecstp 09-08-06 13:24:22 GMT EAGLE 41.0.0

FLOBR Trace Tool:

```

Input:
EAGLE-Generated? No
OPC = 004-001-001
LSN = ls222

```

```

CDPA: GTI=2
      TT=1
      NP=1 (e164)
      NAI=1 (sub)
      SSN=20
      PC=010-010-010
      ADDR=99

```

```

CGPA:  GTI=2
      TT=0
      NP=1 (e164)
      NAI=1 (sub)
      SSN=10
      PC=003-001-001
      ADDR=88
Family=9

Opcode=46

Pkgtype=bgn  (0x62)

Acn= 1-2-3-4-5

;
tekelecstp 09-08-06 13:24:22 GMT  EAGLE 41.0.0

GTT Search Results:

Search Hierarchy:  FLOBR CDPA

                        CgPA/CdPA

GTT Set Name      Set Type  SELID TestMode FallBack Found Matching Key
acdgta            CDPA GTA   --   OFF    Yes      Y   99
acggta            CGPA GTA   --   OFF    Yes      Y   88
acgpc             CGPA PC    --   OFF    Yes      Y   003-001-001
aopc             OPC      --   OFF    Yes      Y   004-001-001
acgssn           CGPA SSN   --   OFF    Yes      Y   10
aopcode          OPCODE   --   OFF    Yes      Y   pkg=bgn  (0x62)
                  acn=1-2-3 op=46
acdssn           CDPA SSN   --   OFF    Yes      Y   20

Search Depth = 7
Loop Detected = No

Translation Results:
Translation Found: Yes [GTT Set Name = acdssn]
DPC = 003-003-003
RI = GT
SSN = 17

Command Complete
;

```

The following command displays the output in brief mode for the Info Analyzed Relay Base feature.

**tst-msg:loc=1101:prot=tatr:feat=iar:mmsgn=1:mode=brief**

```

tekelecstp 09-07-24 18:20:46 EST  EAGLE 41.1.0
tst-msg:feat=iar:prot=tatr:mmsgn=1:mode=brief
Command Accepted: Test message is sent.
;

```

```

TST-MSG-RESULT
=====
IAR Decoding Successfull., (0)
TTR Preprocessing successful.
TTR CgPN Encoded

MSG = 1

SCCP
CGPA_GTI = 2
CGPA_GT_NAI = 4          CGPA = 9194605500
CDPA_GTI = 2

```

```

CDPA_GT_NAI = 3          CDPA = 404009246139988

TCAP
TRIG = 26
CGPN_NAI = 48          CGPN = 9246138610
CDPN_NAI = 48          CDPN = 9246138700

CDPN NPP PROCESSING
SERVICE NAME = iarcdpn SERVICE STATUS = ON
INC DIGITS = 9246138700
NAI = 48 FNAI = intl FDIGLEN = 10

MATCHING RULE
FNAI = intl FDIGLEN = 0 PPFX = *
ACTION SET NAME = DSET1

CONDITIONING RESULT
INC DIGITS = 9246138700
COND DIGITS = 19246138700

FORMATING RESULT
OUTG DIGITS = 198769246138700
OUTG FNAI = intl

CGPN NPP PROCESSING
SERVICE NAME = iarcgpn SERVICE STATUS = ON
INC DIGITS = 9246138610
NAI = 49 FNAI = natl FDIGLEN = 10

MATCHING RULE
FNAI = natl FDIGLEN = 0 PPFX = *
ACTION SET NAME = DSET2

CONDITIONING RESULT
INC DIGITS = 9246138610
COND DIGITS = 19246138610

FORMATING RESULT
OUTG DIGITS = 155555924613861044443333
OUTG FNAI = intl

```

The following command displays the output in full mode for the Info Analyzed Relay Base feature.

**tst-msg:loc=1101:prot=tatr:feat=iar:msgn=1:mode=full**

```

tekelecstp 09-07-24 18:20:46 EST EAGLE 41.1.0
tst-msg:feat=iar:prot=tatr:msgn=1:mode=full
Command Accepted: Test message is sent.
;

```

```

TST-MSG-RESULT
=====
IAR Decoding Successfull., (0)
TTR Preprocessing successful.
TTR CgPN Encoded

MSG = 1

SCCP
CGPA_GTI = 2
CGPA_GT_NAI = 4          CGPA = 9194605500
CDPA_GTI = 2
CDPA_GT_NAI = 3          CDPA = 404009246139988

TCAP
TRIG = 26
CGPN_NAI = 48          CGPN = 9246138610
CDPN_NAI = 48          CDPN = 9246138700

```

```

CDPN NPP PROCESSING
SERVICE NAME = iarcdpn SERVICE STATUS = ON
  INC DIGITS = 9246138700
  NAI = 48 FNAI = intl FDIGLEN = 10

MATCHING RULE
  FNAI = intl FDIGLEN = 0 FPFX = *
  ACTION SET NAME = DSET1

CONDITIONING RESULT
  CA1 = ccdef      EXECUTED = Y RESULT = PASS
  CA2 = dnx        EXECUTED = Y RESULT = PASS
  INC DIGITS = 9246138700
  COND DIGITS = 19246138700

SERVICE APPLICATION
  SA1 = cdpnp      EXECUTED = Y FORMAT = Y
  SA2 = cgpnasdrqd EXECUTED = Y FORMAT = Y
  SA3 = cgpngrnrqd EXECUTED = Y FORMAT = Y

FORMATING RESULT
  FA1 = cc          EXECUTED = Y RESULT = PASS
  FA2 = rn          EXECUTED = Y RESULT = PASS
  FA3 = sp          EXECUTED = Y RESULT = PASS
  FA4 = srfimsi     EXECUTED = Y RESULT = PASS
  FA5 = dn          EXECUTED = Y RESULT = PASS
  FA6 = asd         EXECUTED = Y RESULT = PASS
  FA7 = grn         EXECUTED = Y RESULT = PASS
  OUTG DIGITS = 198769246138700
  OUTG FNAI = intl

CGPN NPP PROCESSING
SERVICE NAME = iarcgpn SERVICE STATUS = ON
  INC DIGITS = 9246138610
  NAI = 49 FNAI = natl FDIGLEN = 10

MATCHING RULE
  FNAI = natl FDIGLEN = 0 FPFX = *
  ACTION SET NAME = DSET2

CONDITIONING RESULT
  CA1 = ccdef      EXECUTED = Y RESULT = PASS
  CA2 = dnx        EXECUTED = Y RESULT = PASS
  INC DIGITS = 9246138610
  COND DIGITS = 19246138610

SERVICE APPLICATION
  SA1 = cgpnp      EXECUTED = Y FORMAT = Y
  SA2 = asdlkup    EXECUTED = Y FORMAT = Y
  SA3 = grnlkup    EXECUTED = Y FORMAT = Y

FORMATING RESULT
  FA1 = cc          EXECUTED = Y RESULT = PASS
  FA2 = rn          EXECUTED = Y RESULT = PASS
  FA3 = sp          EXECUTED = Y RESULT = PASS
  FA4 = srfimsi     EXECUTED = Y RESULT = PASS
  FA5 = dn          EXECUTED = Y RESULT = PASS
  FA6 = asd         EXECUTED = Y RESULT = PASS
  FA7 = grn         EXECUTED = Y RESULT = PASS
  OUTG DIGITS = 15555924613861044443333
  OUTG FNAI = intl

```

The following command displays the output in debug mode for the Info Analyzed Relay Base feature.

```

tst-msg:loc=1101:prot=tatr:feat=iar:msgn=2:mode=debug
tekelecstp 09-07-24 18:20:46 EST EAGLE 41.1.0
tst-msg:feat=iar:prot=tatr:msgn=2:mode=debug
Command Accepted: Test message is sent.
;

TST-MSG-RESULT
=====
IAR DEST NUM decode error., (0)
TTR Preprocessing successful.
TTR CgPN Encoded

MSG = 2

SCCP
CGPA_GTI = 2
CGPA_GT_NAI = 4          CGPA = 9194605500
CDPA_GTI = 2
CDPA_GT_NAI = 3          CDPA = 404009246139988

TCAP
TRIG = 26
CGPN_NAI = 48           CGPN = 9876543210
CDPN_NAI = 49           CDPN = 135792468011223344

CDPN NPP PROCESSING
SERVICE NAME = iarcdpn SERVICE STATUS = ON
INC DIGITS = 135792468011223344
NAI = 48 FNAI = intl FDIGLEN = 18

MATCHING RULE
FNAI = intl FDIGLEN = 0 PPFX = *
ACTION SET NAME = DSET1

CONDITIONING RESULT
CA1 = ccdef             EXECUTED = Y RESULT = PASS
CA2 = dnx               EXECUTED = Y RESULT = PASS
INC DIGITS = 135792468011223344
COND DIGITS = 1135792468011223344

SERVICE APPLICATION
SA1 = cdpnnp           EXECUTED = Y FORMAT = Y
ENTITY = RN - SPORT APPLIED, RESULT = SUCCESS      SA2 = cgpnasdrqd EXECUTED
= Y FORMAT = Y
CgPN ASD will be made available during Cdpn FAE.
SA3 = cgpngrnrqd      EXECUTED = Y FORMAT = Y
CgPN GRN will be made available during Cdpn FAE.

FORMATING RESULT
FA1 = cc               EXECUTED = Y RESULT = PASS
FA2 = rn               EXECUTED = Y RESULT = PASS
FA3 = sp               EXECUTED = Y RESULT = PASS
FA4 = srfimsi          EXECUTED = Y RESULT = PASS
FA5 = dn               EXECUTED = Y RESULT = PASS
FA6 = asd              EXECUTED = Y RESULT = PASS
FA7 = grn              EXECUTED = Y RESULT = PASS
OUTG DIGITS = 19876135792468011223344
OUTG FNAI = natl

CGPN NPP PROCESSING
SERVICE NAME = iarcgpn SERVICE STATUS = ON
INC DIGITS = 9876543210
NAI = 48 FNAI = intl FDIGLEN = 10

```

```

MATCHING RULE
  FNAI = intl FDIGLEN = 0 FPFX = *
  ACTION SET NAME = DSET2

CONDITIONING RESULT
  CA1 = ccdef      EXECUTED = Y RESULT = PASS
  CA2 = dnx        EXECUTED = Y RESULT = PASS
  INC DIGITS = 9876543210
  COND DIGITS = 19876543210

SERVICE APPLICATION
  SA1 = cgpnp      EXECUTED = Y FORMAT = Y
  ENTITY = SP, RESULT = SUCCESS

  SA2 = asdlkup    EXECUTED = Y FORMAT = Y
  ASD lkup done
  SA3 = grnlkup    EXECUTED = Y FORMAT = Y
  GRN lkup done

FORMATING RESULT
  FA1 = cc         EXECUTED = Y RESULT = PASS
  FA2 = rn         EXECUTED = Y RESULT = PASS
  FA3 = sp         EXECUTED = Y RESULT = PASS
  FA4 = srfimsi   EXECUTED = Y RESULT = PASS
  FA5 = dn         EXECUTED = Y RESULT = PASS
  FA6 = asd       EXECUTED = Y RESULT = PASS
  FA7 = grn       EXECUTED = Y RESULT = PASS
  OUTG DIGITS = 155555987654321044443333
  OUTG FNAI = intl

```

**tst-npp-msg****Change NPP Test Service Parameters**

Use this command to provision and test the NPP provided service, NPPT. The NPP Test Service allows customers to provision NPP Action Sets and Rules associated with the NPPT Service Rule Set. Customers can inject test messages to a provisioned NPPT Service Rule to verify proper digit string processing.

**Keyword:** **tst-npp-msg**

**Command Class:** Database Administration

**Parameters**

**:digs=** (mandatory)

Digits. This parameter specifies the incoming digit string for NPP to process.

**Range:** 1-32 digits

**:loc=** (mandatory)

This parameter specifies the Service Module card to which the test message is issued.

**Range:** 1101-1108, 1111-1112, 1201-1208, 1211-1218, 1301-1308, 1311-1318, 2101-2108, 2111-2118, 2201-2208, 2211-2218, 2301-2308, 2311-2318, 3101-3108, 3111-3118, 3201-3208, 3211-3218, 3301-3308, 3311-3318, 4101-4108, 4111-4118, 4201-4208, 4211-4218, 4301-4308, 4311-4318, 5101-5108, 5111-5118, 5201-5208, 5211-5218, 5301-5308, 5311-5318, 6101-6108, 6111-6118

**:nai=** (mandatory)

Incoming digit string Nature of Address Indicator (NAI) mapping value.

**Range:** 0-255



**:srvn=** (mandatory)

Service name. This parameter specifies the name of the NPP service that should receive the NPP Test message.

**Range:**     **nppt**  
              **nppt** — NPP Test Service

**:mode=** (optional)

This parameter specifies the generated output format.

**Range:**     **brief, full, debug**  
              **brief** — summary format  
              **full** — full format  
              **debug** — debug format

**Default:**   **brief**

### Example

```
tst-npp-msg:loc=1101:mode=full:digs=0ab4041234567:nai=3
```

### Dependencies

None.

## Output

When the **mode=full** or **mode=debug** parameter is specified, the **FORMAT** field indicates whether formatting actions are executed. If formatting actions are not executed, then the **OUTG DIGITS** field displays a value of **UNMODIFIED**. If any digit string is blank, then the associated field displays a value of **EMPTY**.

The numbers shown to identify Conditioning Actions, Service Actions, and Formatting Actions are either the individual parameter numbers or the position of the value in the parameter list when the command was entered. For example, **CA2** identifies either the value for the **ca2** parameter or the second CA value in the **ca** parameter list in the command (such as **ac3** in the **ca=cc2, ac3** parameter).

**tst-npp-msg:loc=1101:digs=9090920292252645:nai=7:mode=full**

```
SERVICE NAME = nppt SERVICE STATUS = ON
  INC DIGITS = 9090920292252645
  NAI = 7 FNAI = intl FDL = 16
```

### MATCHING RULE

```
FNAI = intl FDL = 16 PFX = 9090
ACTION SET NAME = set1
```

### CONDITIONING RESULT

```
CA1 = ign4 EXECUTED = Y RESULT = PASS
CA2 = cc2 EXECUTED = Y RESULT = PASS
CA3 = dn10 EXECUTED = Y RESULT = PASS
INC DIGITS = 9090920292252645
COND DIGITS = 920292252645
```

### SERVICE APPLICATION

```
SA1 = rtbtrn EXECUTED = Y FORMAT = Y
```

### FORMATING RESULT

```
FA1 = cc EXECUTED = Y RESULT = PASS
FA2 = rn EXECUTED = Y RESULT = PASS
FA3 = dn EXECUTED = Y RESULT = PASS
OUTG DIGITS = 92abcd0292252645
OUTG FNAI = intl
```

**tst-npp-msg:loc=1101:digs=0609192252645:nai=5:mode=full**

```
SERVICE NAME = nppt SERVICE STATUS = ON
  INC DIGITS = 0609192252645
  NAI = 5 FNAI = natl FDL = 13
```

### MATCHING RULE

```
FNAI = natl FDL = 13 PFX = 060
ACTION SET NAME = set2
```

### CONDITIONING RESULT

```
CA1 = ccdef EXECUTED = Y RESULT = PASS
CA2 = ign3 EXECUTED = Y RESULT = PASS
CA3 = dn7 EXECUTED = Y RESULT = PASS
INC DIGITS = 0609192252645
COND DIGITS = 989192252
```

### SERVICE APPLICATION

```
SA1 = rtbtrnsp EXECUTED = Y FORMAT = Y
```

### FORMATING RESULT

```
FA1 = rn EXECUTED = Y RESULT = PASS
FA2 = sp EXECUTED = Y RESULT = PASS
FA3 = orig EXECUTED = Y RESULT = PASS
OUTG DIGITS = 1bce0609192252645
OUTG FNAI = natl
```

**tst-slk****Test Signaling Link**

Use this command for testing signaling links. The **loopback** parameter on the **tst-slk** command provides the ability to select from among the following loopback tests: local transceiver (**lxvr**), **oam**, **line**, **payload**, and either low-speed signaling links or ATM high-speed signaling links (**sltc**).

- The **tst-slk** command is not valid on TCP/IP point-to-multipoint links (SSEDCM cards or E5-ENET cards equipped as SS7IPGW and IPGWI links).
- For low-speed links, the **lxvr** and **sltc** tests are allowed.
- On LIM-ATM cards, the **lxvr**, **sltc**, **payload**, **line**, and **oam** tests are allowed.
- On TCP/IP point-to-point links (SSEDCM cards or E5-ENET cards equipped as IPLIM or IPLIMI links), **sltc** is the only supported test. The **sltc** test is allowed only for links configured with **ipliml2=m2pa**.
- On E1/T1 MIM cards, the **sltc** test is the only supported test.
- On E1 ATM cards (**atmitu** application), the **lxvr**, **oam**, and **sltc** tests are allowed.
- On E5-ENET cards running the **ipsg** application, the command is only supported for IPSPG-M2PA signaling links, and only the **sltc loopback** test is allowed.

See "Summary of Loopback Testing Commands and Functions" in Appendix A.

**Keyword:** **tst-slk**

**Related Commands:** **act-lpo**, **act-slk**, **blk-slk**, **canc-lpo**, **canc-slk**, **dact-slk**, **inh-slk**, **rept-stat-tstslk**, **rtrv-slk**, **ublk-slk**, **unhb-slk**

**Command Class:** Link Maintenance

**Parameters**

**:link=** (mandatory)

The signaling link on the card specified in the **loc** parameter. The links can be specified in any sequence or pattern.

**Synonym:** **port**

**Range:** **a, b, a1-a31, b1-b31**

Not all card types support all **link** parameter values.

See Table A-1 for valid **link** parameter range values for each type of card that can have a location specified in the **loc** parameter.

**:loc=** (mandatory)

The card location as stenciled on the shelf of the system.

**Range:** **1101-1108, 1111-1112, 1201-1208, 1211-1218, 1301-1308, 1311-1318, 2101-2108, 2111-2118, 2201-2208, 2211-2218, 2301-2308, 2311-2318, 3101-3108, 3111-3118, 3201-3208, 3211-3218, 3301-3308, 3311-3318, 4101-4108, 4111-4118, 4201-4208, 4211-4218, 4301-4308, 4311-4318, 5101-5108, 5111-5118, 5201-5208, 5211-5218, 5301-5308, 5311-5318, 6101-6108, 6111-6118**

**:action=** (optional)

Indicator of command action to stop or start a test.

**Range:** **start, stop**

**Default:** **start**

**:force=** (optional)

The **force=yes** parameter must be specified to start a test when there are 256 or more tests already running.

**Range:** yes, no

**Default:** no

**:loopback=** (optional)

Specifies the type of loopback test to run.

**Range:** line, lxvr, oam, payload, sltc

**line** — This test is similar to the payload loopback test, but the data transmitted to the remote system is received by the remote system's ATM driver. This test is prohibited for the E1 ATM card.

**lxvr** — Loopback at the local transceiver without involving the remote STP. For the ADS0, AINF, AOCU, and AV35 appliques, the MTP-2 protocol stack and ISCC hardware are tested. For AATM applique and DS1 interface, the AATM hardware, ATM level 2 protocol stack, and AAL5CP portion of ATM driver are tested,

**oam** — Messages are passed between local and remote systems to guarantee that the ATMM portion of ATM driver is functioning.

**payload** — This test is similar to the local transceiver loopback test. The wire is also tested because the loopback is at the remote's DS1 interface instead of the local's DS1 interface. This test is prohibited for the E1 ATM card.

**sltc** — This test can be run on either the low-speed signaling links or the ATM high-speed signaling links. This is the only test that is supported for links on the E1/T1 MIM card, and for **m2pa** links on IPLIMx cards.

**Default:** sltc

**:time=** (optional)

The time duration for testing the link.

**Range:** 1-240000

*hhmmss*—*hh*=hours (00-24), *mm*=minutes (00-59), *ss*=seconds (00-59)

For example, **time=1** or **time=000001** is one second; **time=240000** is 24 hours;

**time=200** or **time=000200** is 2 minutes.

**Default:** 1

### Example

```
tst-slk:loc=1203:link=a
```

```
tst-slk:loc=1203:link=a:loopback=lxvr
```

```
tst-slk:loc=1205:link=b:time=000200:force=yes:action=start
```

```
tst-slk:loc=1205:link=b:action=stop
```

```
tst-slk:loc=1205:link=b:time=200
```

### Dependencies

A card location that is valid and defined in the database must be specified.

The card must be equipped and in service, and must be one of the following cards:

- An E1 ATM card running the **atmitu** application
- An E1/T1 MIM, E5-E1T1, or HC MIM card running the **ss7ansi** or **ccs7itu** application
- An E5 ATM card running the **atmansi** or **atmitu** application
- An E5-ENET card running the **ipsg** application
- An E5-ENET card or SSEDCCM card running the **iplim** or **iplimi** application with links having **ipliml2=m2pa**
- A LIM card running the **ss7ansi**, **ss7gx25**, or **ccs7itu** application

- A LIM ATM card running the **atmansi** application

The following **link** parameter values can be specified for the following cards that support more than 2 links per card:

- **a1-a3, b1-b3**—Multi-port LIM (MPL), SSEDCCM card running the **iplim** or **iplimi** application with links having **ipliml2=m2pa**, E1/T1 MIM card
- **a1-a31, b1-b31**—HC-MIM card
- **a1-a15, b1-b15**—E5-E1T1 card
- **a1-a7, b1-b7**—E5-ENET card running the **iplim** or **iplimi** application that supports 16 links.
- **a1-a15, b1-b15**—E5-ENET card running the **ipsg** application.

If the signaling link is an ATM HSL signaling link, only the **link=a** parameter can be specified.

This command is not supported for cards running the **ss7ipgw** application.

If IPSEG-M2PA signaling links or IPLIMx signaling links are used, and the **ipliml2=m2pa** parameter is specified, then only the **loopback=sltc** test is allowed.

The **payload** and **line** values are not valid for the **loopback** parameter when the card is an E1 ATM.

Only the **sltc** test can be run on card types **lime1**, **limt1**, and **limch**.

The card must contain the specified signaling link.

The specified signaling link must be provisioned in the database.

The specified signaling link must be an SS7 signaling link.

The signaling link that is used for LFS (Link Fault Sectionalization) testing cannot be active.

A command is already in progress. The previously entered command for a link test must be accepted before another link test command can be entered.

This command cannot be entered if the LFS test is running on the specified link.

The specified link cannot be in Command Driven Loopback (CDL) when this command is entered. The link must be removed from CDL before this command can be entered for the link. (See the **act-cdl** and **dact-cdl** commands).

The **force=yes** parameter must be specified to start a test when 256 or more tests are already running in the system.

This command cannot be entered if the maximum number of LFS or link tests are already running in the system. At least one active test must complete before the command can be entered again.

Only one link test can be running on a signaling link at one time.

The **action=stop** parameter cannot be specified when there is no active link test running on the specified link.

When the **action=stop** parameter is specified, the **loopback**, **time**, and **force** parameters cannot be specified.

If an IPSEG-M3UA signaling link is used, then this command cannot be entered.

If an IPSEG-M2PA signaling link is used, the **loopback=sltc** parameter must be specified.

The card must be equipped and in service, and must be one of the following cards:

- An E1 ATM card running the **atmitu** application
- An E1/T1 MIM, E5-E1T1, or HC MIM card running the **ss7ansi** or **ccs7itu** application
- An E5 ATM card running the **atmansi** or **atmitu** application

- An E5-ENET card running the **ipsg** application
- An E5-ENET card or SSEDCEM card running the **iplim** or **iplimi** application with links having **ipliml2=m2pa**
- A LIM card running the **ss7ansi**, **ss7gx25**, or **ccs7itu** application
- A LIM ATM card running the **atmansi** application

### Notes

The **lxvr** and **sltc** loopback tests can be run on low-speed signaling links. All the loopback tests can be run on the ATM high-speed signaling links.

This command cannot be used with X.25 signaling links.

**Output**

If the card is inhibited, not in service, the following message appears when you try to test the links on the card:

```

tst-slk:loc=1203:link=a
  rlghncxa03w 03-11-07 16:19:08 EST  EAGLE 31.3.0
  Command Rejected : Card is not in service.
;

tst-slk:loc=1205:link=b:time=000200:force=yes:action=start
  tekelecstp 03-11-27 16:15:20 EST  EAGLE 31.3.0
  tst-slk:loc=1205:link=b:time=000200:force=yes:action=start
  Command Accepted: Test Link message is sent.
;

  tekelecstp 03-11-27 16:15:22 EST  EAGLE 31.3.0
  Command Completed.
;

  tekelecstp 03-11-27 16:22:25 EST  EAGLE 31.3.0
  LOC = 1205  Link = B  LSN = ls12345678  Start time = 16:22:25
  LOOPBACK = SLTC      TIME = 00:02:00
  TEST STATUS = Loopback success
;

tst-slk:loc=1205:link=b:action=stop
  tekelecstp 03-11-27 16:15:20 EST  EAGLE 31.3.0
  tst-slk:l oc=1205:link=b:action=stop
  Command Accepted: Stop Test Link message is sent.
;

  tekelecstp 03-11-27 16:15:22 EST  EAGLE 31.3.0
  Command Completed.
;

  tekelecstp 03-11-27 16:22:25 EST  EAGLE 31.3.0
  LOC = 1205  = B  LSN = ls12345678  Start time = 16:22:25
  LOOPBACK = LXVR      TIME = 00:01:00
  TEST STATUS = Loopback cleared
;

tst-slk:loc=1205:link=b:time=200
  tekelecstp 03-11-27 16:15:20 EST  EAGLE 31.3.0
  tst-slk:loc=1205:link=b:time=200
  Command Accepted: Stop Test Link message is sent.
;

  tekelecstp 03-11-27 16:15:22 EST  EAGLE 31.3.0
  Command Completed.
;

  tekelecstp 03-11-27 16:22:25 EST  EAGLE 31.3.0
  LOC = 1205  Link = B  LSN = ls12345678  Start time = 16:22:25
  LOOPBACK = SLTC      TIME = 00:00:53
  TEST STATUS = Loopback failed
;

```

**Legend**

**LOC**—Card location that contains the signaling being tested.

**LINK**—Signaling link being tested on the card.

**LSN**—Name of the linkset that contains the link being tested.

**START TIME**—Time that the test started.

**LOOPBACK**—Type of loopback test being run.

**TIME**—Length of time that the test ran. This value can exceed the value that was specified in the **time** parameter if the test requires more than the specified time to complete.

**TEST STATUS**—

- When a **tst-slk** command with **action=start** (specified or default) is entered, any one of the following *TEST STATUS* values can appear:
  - Loopback success
  - Loopback failed
  - Loopback aborted
  - Loopback in-progress
  - Loopback prevented
  - Loopback invalid
- When a **tst-slk** command with **action=stop** is entered, any one of the following *TEST STATUS* values can appear:
  - Loopback cleared
  - Loopback could not be cleared

## tst-t1

## Test T1 Port

Use this command to test T1 Ports on the HC-MIM and E5-E1T1 cards. The command is rejected if a loopback test is not compatible with the port type.

**Keyword:** **tst-t1**

**Related Commands:** **chg-t1, dlt-t1, ent-t1, rtrv-t1**

**Command Class:** System Maintenance

### Parameters

**:loc=** (mandatory)

Card location. The HC-MIM or E5-E1T1 card location as stenciled on the shelf of the system.

**Range:** **1101-1108, 1111-1112, 1201-1208, 1211-1218, 1301-1308, 1311-1318, 2101-2108, 2111-2118, 2201-2208, 2211-2218, 2301-2308, 2311-2318, 3101-3108, 3111-3118, 3201-3208, 3211-3218, 3301-3308, 3311-3318, 4101-4108, 4111-4118, 4201-4208, 4211-4218, 4301-4308, 4311-4318, 5101-5108, 5111-5118, 5201-5208, 5211-5218, 5301-5308, 5311-5318, 6101-6108, 6111-6118**

**:t1port=** (mandatory)

T1 port number. The value must be a T1 port that has already been configured with a T1 interface on the specified HC-MIM or E5-E1T1 T1 card.

**Range:** **1-8**

Ports 3 - 8 can be specified only for HC-MIM and E5-E1T1 cards.

**:action=** (optional)

Indicator of command action to stop or start a test.

**Range:** **start, stop**

**Default:** **start**



**:loopback=** (optional)  
 Select loopback test type.

**Range:**     **line**, **lxvr**, **payload**, **feline**, **fepayload**  
               **lxvr** — local transceiver  
               **feline** — far end line  
               **fepayload** — far end payload

**Default:**   **lxvr**

### Example

```
tst-t1:t1port=1:loc=1203:loopback=lxvr
tst-t1:t1port=1:loc=1203:action=stop
```

### Dependencies

This command cannot be entered during upgrade.

The card in the specified card location (**loc** parameter) must be an HC-MIM or E5-E1T1 card with card type **limt1**.

The card in the specified card location (**loc** parameter) must be equipped.

The card in the specified card location (**loc** parameter) must be in service.

The specified T1 port (**t1port** parameter) on the card (**loc** parameter) must have a defined T1 interface.

All signaling links that provide timeslots serviced by T1 interfaces on the specified card (**loc** parameter) must be deactivated before this command can be entered. None of the signaling links can be running link diagnostic tests (**tst-slk** and **act-cdl** commands) when this command is entered.

Only one port test can be running on a T1 port (**t1port** parameter) at one time.

The **action=stop** parameter can be specified only when a port test is running.

If the **action=stop** parameter is specified, a value of **feline** or **fepayload** must be specified for the loopback parameter.

If the **action=stop** parameter is specified, and a value of **feline** or **fepayload** is specified for the **loopback** parameter, then there cannot be an active loopback for the T1 span, or the active loopback must be the one specified in the **tst-t1:action=stop** command.

### Notes

This command can be used only for HC-MIM and E5-E1T1 card ports.

Only one port test can be performed at a time on a T1 port. When a port test is in progress on a T1 port, subsequent test requests are rejected.

If a loopback type of **feline** or **fepayload** is specified, then the loopback requests are sent to the far end. No response is given from the far end indicate if the request was acted upon or received. The local card which hosts the T1 span in the EAGLE 5 ISS does not instrument the loopback locally but maintains a knowledge of the far end loopback request. If the local card boots, this knowledge is lost by the card.

To maintain the far end loopback states, if the T1 card with an active **feline** or **fepayload** test boots, the card loses any knowledge of the Far End loopback request, but the OAM retains that knowledge. If the OAM boots, the T1 card updates the OAM with its last known loopback state. If both the T1 card and the active OAM card boots while a Far End Loopback is active, then there is no way of determining the T1 state: however, a **tst-t1:action=stop:action=(feline or fepayload)** command can still be sent.

**Output**

```

tst-t1:t1port=1:loc=1203:loopback=lxvr

    rlghncxa03w 05-01-07 16:19:08 EST  EAGLE5 33.0.0
    Command Accepted: Test Port message is sent.
;
    rlghncxa03w 05-01-07 16:19:08 EST  EAGLE5 33.0.0
    Command Completed.
;
tst-t1:t1port=1:loc=1203:action=stop

    rlghncxa03w 05-01-07 16:19:08 EST  EAGLE5 33.0.0
    Command Accepted: Stop Port test message is sent.
;

    tekelecstp 03-12-16 14:31:23 EST  EAGLE5 33.0.0
    Command Completed.
;

```

**ublk-slk****Unblock Signaling Link**

Use this command to cancel a local processor outage (LPO) and restore the link to its previous state. Link status signal units (LSSU) with status of processor outage are stopped, and the link begins sending MSUs again. IPSPG-M3UA signaling links are allowed to enter service by allowing received AS-ACTIVE messages to be accepted.

**NOTE: The blocked status of the signaling link is not preserved across a LIM reboot.**

**Keyword:** ublk-slk

**Related Commands:** act-lpo, blk-slk, canc-lpo

**Command Class:** Link Maintenance

**Parameters**

**:link=** (mandatory)

The signaling link on the card specified in the **loc** parameter. The signaling links can be specified in any sequence or pattern.

**Synonym:** port

**Range:** a, b, a1-a31, b1-b31

Not all card types support all **link** parameter values.

See Table A-1 for valid **link** parameter range values for each type of card that can have a location specified in the **loc** parameter.

**:loc=** (mandatory)

The card location as stenciled on the shelf of the system.

**Range:** 1101-1108, 1111-1112, 1201-1208, 1211-1218, 1301-1308, 1311-1318, 2101-2108, 2111-2118, 2201-2208, 2211-2218, 2301-2308, 2311-2318, 3101-3108, 3111-3118, 3201-3208, 3211-3218, 3301-3308, 3311-3318, 4101-4108, 4111-4118, 4201-4208, 4211-4218, 4301-4308, 4311-4318, 5101-5108, 5111-5118, 5201-5208, 5211-5218, 5301-5308, 5311-5318, 6101-6108, 6111-6118

**Example**

```
ublk-slk:loc=2311:link=b
```

**Dependencies**

A card location that is valid and defined in the database must be specified.

No other action command can be in progress when this command is entered.

The card must be equipped and must be one of the following cards:

- A LIM card running the **ss7ansi**, **ss7gx25**, **atmansi**, or **ccs7itu** application
- An E1 ATM card running the **atmitu** application
- An SSEDCCM card running the **iplim** or **iplimi** application with links having **ipliml2=m2pa**
- An E1/T1 MIM card or an HC-MIM card running the **ss7ansi** or **ccs7itu** application
- An E5-ENET card running the **iplim**, **iplimi**, or **ipsg** application
- An E1/T1 MIM, an HC-MIM or and E5-E1T1 card running the **ss7ansi** or **ccs7itu** application

This command can be entered only for IPLIMx signaling links that have an **ipliml2** parameter setting of **m2pa**.

The **ublk-slk** command is not valid for SSEDCCM cards or E5-ENET cards with **ss7ipgw** or **ipgwi** TCP/IP links.

The card must contain signaling links.

The signaling link must be equipped in the database.

The following **link** parameter values can be specified for the following cards that support more than 2 links per card:

- **a1-a3, b1-b3**—Multi-port LIM (MPL, MPL-T), SSEDCCM card running the **iplim** or **iplimi** application with links having **ipliml2=m2pa**, E1/T1 MIM card
- **a1-a31, b1-b31**—HC-MIM card
- **a1-a15, b1-b15**—E5-E1T1 card
- **a1-a7, b1-b7**—E5-ENET card running the **iplim** or **iplimi** application that supports 16 links.
- **a1-a15, b1-b15**—E5-ENET card running the **ipsg** application.

The card in the specified card location cannot be a TDM card, an MDAL card, an HMUX or HIPR card, or the cards running the OAM application.

This command is not valid for links belonging to proxy linksets.

## Notes

Unblocking a signaling link removes a Level 2 failure resulting from a **blk-slk** of an ATM high-speed signaling link.

The function of this command is the same as the **canc-lpo** command.

The *Installation Manual – EAGLE 5 ISS* provides an illustration of card locations.

## Output

```
ublk-slk:loc=2311:link=b
  rlgncxa03w 03-03-07 11:11:28 EST EAGLE 31.3.0
  Local processor outage being cleared.
;

ublk-slk:loc=1113:link=a
  rlgncxa03w 03-03-07 11:11:28 EST EAGLE 31.3.0
  Command Rejected : Location is not valid for command.
;
```

**unhb-alm****Restore Alarm Reporting**

Use this command to restore the reporting of alarms for the given device.

**Keyword:** unhb-alm

**Related Commands:** inh-alm, rept-stat-alm, rept-stat-card, rept-stat-cdt, rept-stat-dlk, rept-stat-dstn, rept-stat-ls,, rept-stat-rte, rept-stat-rtx, rept-stat-seas, rept-stat-slk, rept-stat-sys, rept-stat-trbl, rept-stat-trm, rtrv-log

**Command Class:** System Maintenance

**Parameters**

**NOTE:** See "Point Code Formats and Conversion" for a detailed description of point code formats, rules for specification, and examples.

**:dev=** (mandatory)

Device. This parameter specifies the device where the reporting of alarms is to be restored.

**Range:** **applsock, as, card, cdt, clock, dlk, e1port, ls, lmsconn, route, seasx25, slk, t1port, trm, rtx, rs**  
**applsock** — IP gateway application socket  
**as** — IP gateway application Application Server  
**card** — Cards in the database  
**cdt** — Customer defined troubles  
**clock** — System clock  
**dlk** — The IP ports on the VSCCP, EROUTE, SLAN, VXWSLAN and MCP application cards.  
**e1port** — E1 port on E1/T1 MIM or HC-MIM cards  
**ls** — Linksets  
**lmsconn** — Communication link between the LSMS and the EMS  
**route** — Route  
**seasx25** — SEAS X.25 links  
**slk** — Signaling links  
**t1port** — T1 port on E1/T1 MIM or HC-MIM cards  
**trm** — Terminals  
**rtx** — Exception Route  
**rs** — Routesets

**:asname=** (optional)

Gateway Application Server name. When used with the **dev=as** parameter, this parameter can be used to uninhibit alarms for the named Application Server.

**Range:** *ayyyyyyyyyyyyyyy*  
 Up to 15 alphanumeric characters; the first character must be a letter

**:cic=** (optional)

Starting Circuit Identification Code. This parameter is used alone or together with the **ecic** parameter to define the CIC range, which is used as an exception routing criterion for the specified exception route.

**Range:** **0-16383**

**:dpc=** (optional)

ANSI destination point code with subfields *network indicator-network cluster-network cluster member (ni-nc-ncm)*. The *prefix* subfield indicates a private point code (*prefix-ni-nc-ncm*).

**Synonym:** dpc

**Range:** **p-, 000-255, \***

Specify a valid value for each subfield of the point code, and separate the subfields with a dash (-).

*prefix*—**p**-

The asterisk value (\*) is not valid for the *ni* subfield.

When **chg-sid:pctype=ansi** is specified, *ni* = **000** is not valid.

When **chg-sid:pctype=ansi** is specified, *nc* = **000** is not valid if *ni* = **001–005**.

When **chg-sid:pctype=ansi** is specified, *nc* = **000** is valid if *ni* = **006–255**.

The point code **000-000-000** is not a valid point code.

**:dpc/dpca/dpci/dpcn/dpcn24=** (optional)

Destination point code for inhibiting alarms for routes.

**:dpci=** (optional)

ITU international destination point code with subfields *zone-area-id*. The *prefix* subfield indicates a spare point code, private point code, or private and spare point code (*prefix-zone-area-id*).

**Range:** **s-, p-, ps-, 0-255**

Specify a valid value for each subfield of the point code, and separate the subfields with a dash (-).

*prefix*—**s-, p-, ps-**

*zone*—**0-7**

*area*—**000-255**

*id*—**0-7**

The point code **0-000-0** is not a valid point code.

**:dpcn=** (optional)

ITU national destination point code in the format of a 5-digit number (*nnnnn*); or 2, 3, or 4 numbers (members) separated by dashes (*m1-m2-m3-m4*) as defined by the **chg-stpopts:npcfmti** flexible point code option. A group code must be specified when the ITUDUPPC feature is turned on (*nnnnn-gc*, *m1-m2-m3-m4-gc*). The *prefix* subfield indicates a spare point code, private point code, or private and spare point code (*prefix-nnnnn*, *prefix-nnnnn-gc*, *prefix-m1-m2-m3-m4*, *prefix-m1-m2-m3-m4-gc*).

**Range:** **s-, p-, ps-, 0-16383, aa-zz**

Specify a valid value for each subfield of the point code, and separate the subfields with a dash (-).

*prefix*—**s-, p-, ps-**

*nnnnn*—**0-16383**

*gc*—**aa-zz**

*m1-m2-m3-m4*—**0-14** for each member; values must sum to 14

**:dpcn24=** (optional)

24-bit ITU national destination point code with subfields *main signaling area-sub signaling area-signaling point*. The *prefix* subfield indicates a private point code.

**Range:** **p-, 000-255**

Specify a valid value for each subfield of the point code, and separate the subfields with a dash (-).

*prefix*—**p-**

*msa*—**000–255**

*ssa*—**000–255**

*sp*—**000–255**

**:e1port=** (optional)

Port ID. This parameter specifies the E1 port on the specified HC-MIM card. This parameter is mandatory if **dev=e1port** is specified.

**Range:** 1-8

Ports 3 through 8 can be specified only for HC-MIM cards.

**:ecic=** (optional)

Ending Circuit Identification Code. This parameter is used with the **cic** parameter to define the CIC range, which is used as an exception routing criterion for the specified exception route.

**Range:** 0-16383

**:id=** (optional)

Customer Defined Trouble (CDT) ID. Customer Defined Trouble IDs 1 through 4 are generated critical alarms. Because critical alarms cannot be turned off, Customer Defined Trouble IDs 1 through 4 cannot be specified as values for the **id** parameter. This parameter is mandatory if **dev=cdt** is specified.

**Range:** 5-16

**:ilsn=** (optional)

Incoming Link Set Name. This parameter contains the name of the originating linkset. The parameter value is used as part of the exception routing criteria for the specified exception route.

**Range:** ayyyyyyyy

1 alphabetic character followed by up to 9 alphanumeric characters

**:link=** (optional)

Signaling link on the card specified in the **loc** parameter.

**Synonym:** port

**Range:** a, b, a1-a31, b1-b31

a, b—For **dev=dlk**, **dev=slk** for a two-port LIM

a1, a2, b1, b2—For **dev=seasx25/lsmconn**

a, b, a1, b1, a2, b2, a3, b3—For **dev=slk** for a multi-port LIM

a, b, a1-a31, b1-b31—For **dev=slk** for an HC-MIM

**:loc=** (optional)

The card location as stenciled on the shelf of the system.

**Range:** 1101-1113, 1115, 1201-1218, 1301-1318, 2101-2118, 2201-2218, 2301-2318, 3101-3118, 3201-3218, 3301-3318, 4101-4118, 4201-4218, 4301-4318, 5101-5118, 5201-5218, 5301-5318, 6101-6118

**:lsn=** (optional)

Linkset name. The name of the linkset containing the device where alarm reporting is to be restored.

**Range:** ayyyyyyyy

1 alphabetic character followed by up to 9 alphanumeric characters

**:opc=** (optional)

ANSI point code with subfields *network indicator-network cluster-network cluster member (ni-nc-ncm)*. The *prefix* subfield indicates a private point code (*prefix-ni-nc-ncm*).

**Synonym:** opca

**Range:** 000-255

Specify a valid value for each subfield of the point code, and separate the subfields with a dash (-).

When **chg-sid:pctype=ansi** is specified, *ni* = 000 is not valid.

When **chg-sid:pctype=ansi** is specified, *nc* = 000 is not valid if *ni* = 001-005.

When **chg-sid:pctype=ansi** is specified, *nc* = 000 is valid if *ni* = 006-255.

The point code **000-000-000** is not a valid point code.

**:opc/opca/opci/opcn/opcn24=** (optional)

Origination point code

**:opci=** (optional)

ITU international origination point code with subfields *zone-area-id*. The *prefix* subfield indicates a spare point code, private point code, or private and spare point code (*prefix-zone-area-id*).

**Range:** **s-, p-, ps-, 0-255**

Specify a valid value for each subfield of the point code, and separate the subfields with a dash (-).

*prefix*—**s-, p-, ps-**

*zone*—**0-7**

*area*—**000-255**

*id*—**0-7**

The point code **0-000-0** is not a valid point code.

**:opcn=** (optional)

ITU national origination point code in the format of a 5-digit number (*nnnnn*); or 2, 3, or 4 numbers (members) separated by dashes (*m1-m2-m3-m4*) as defined by the **chg-stpopts:npcfnti** flexible point code option. A group code must be specified when the ITUDUPPC feature is turned on (*nnnnn-gc*, *m1-m2-m3-m4-gc*). The *prefix* subfield indicates a spare point code, private point code, or private and spare point code (*prefix-nnnnn*, *prefix-nnnnn-gc*, *prefix-m1-m2-m3-m4*, *prefix-m1-m2-m3-m4-gc*).

**Range:** **s-, p-, ps-, 0-16383, aa-zz**

Specify a valid value for each subfield of the point code, and separate the subfields with a dash (-).

*prefix*—**s-, p-, ps-**

*nnnnn*—**0-16383**

*gc*—**aa-zz**

*m1-m2-m3-m4*—**0-14** for each member; values must sum to 14

**:opcn24=** (optional)

24-bit ITU national destination point code with subfields *main signaling area-sub signaling area-signaling point* (*msa-ssa-sp*). The *prefix* subfield indicates a private point code (*prefix-msa-ssa-sp*).

**Range:** **p-, 000-255**

Specify a valid value for each subfield of the point code, and separate the subfields with a dash (-).

*prefix*—**p-**

*msa*—**000-255**

*ssa*—**000-255**

*sp*—**000-255**

**:si=** (optional)

Service Indicator. This parameter is used as the exception routing criterion for the specified exception route.

**Range:** **0-15**

**:sname=** (optional)

Gateway application socket. When used with the **dev=applsock** parameter, this parameter can be used to uninhibit alarms for the named IP<sup>7</sup> application socket.

**Range:**        ayyyyyyyyyyyyyy  
                   1 to 15 alphanumeric characters

**:t1port=** (optional)

Port ID. T1 port on the specified HC-MIM card. This parameter is mandatory if **dev=t1port** is specified.

**Range:**        1-8  
                   Ports 3 through 8 can be specified only for HC-MIM cards.

**:trm=** (optional)

Terminal ID. This parameter specifies the ID number of the terminal whose alarms are to be uninhibited.

**Range:**        1-40  
**Default:**      Report displays on the terminal where the command was issued.

### Example

```
unhb-alm:dev=route:dpc=1-1-1
```

```
unhb-alm:dpc=1-101-1:opc=4-4-4:dev=rtx
```

### Dependencies

This command is not allowed in the upgrade mode.

No other action command can be in progress when this command is entered.

When the **dev=card** parameter is specified, the **loc** parameter must be specified.

When the **dev=dlk** parameter is specified, the **loc** parameter must be specified.

When the **dev=slk** parameter is specified, the **loc** parameter and the **link** parameter must be specified.

When the **dev=e1port** parameter is specified, the **loc** parameter and the **e1port** parameter must be specified.

When the **dev=t1port** parameter is specified, the **loc** parameter and the **t1port** parameter must be specified.

When the **dev=ls** parameter is specified, the **lsn** parameter must be specified.

When the **dev=trm** parameter is specified, the **trm** parameter must be specified.

When the **dev=cdt** parameter is specified, the **id** parameter must be specified.

When the **dev=seasx25** parameter is specified, the **link** parameter must be specified.

When the **dev=lsmsconn** parameter is specified, the **link** parameter must be specified.

When the **dev=route** parameter is specified, a **dpc/dpca/dpci/dpcn/dpcn24** parameter must be specified.

When the **dev=applsock** parameter is specified, the **sname** parameter must be specified.

When the **dev=as** parameter is specified, the **asname** parameter must be specified.

The linkset specified by the **lsn** parameter must be equipped in the database.

If the **dev=slk** parameter or **dev=dlk** parameter is specified, the specified **link** must exist in the database.

The STP Options table must be accessible.

The Device Alarm Inhibit table must be accessible.

Table 5-85 shows the valid parameter combinations for the **unhb-alm** command.



Table 5-85. Parameter Combinations for the **unhb-alm** command

| Value (:dev)                       | a | a | c | c | d | e | l | l | n | n | r | s | s | t | t | r |
|------------------------------------|---|---|---|---|---|---|---|---|---|---|---|---|---|---|---|---|
| Device Parameter                   | p | s | a | d | l | l | s | s | d | d | o | e | l | l | r | s |
|                                    | p | r | t | o | k | p | m | c | c | u | a | k | p | m |   |   |
|                                    | l | d | c | o | s | l | q | t | s | o | r |   |   |   |   |   |
|                                    | s |   | k | r | c | k | 3 | e | x | 2 |   |   |   |   |   |   |
|                                    | o |   |   | t | o |   |   |   | 5 |   |   |   |   |   |   |   |
|                                    | c |   |   |   | n |   |   |   |   |   |   |   |   |   |   |   |
|                                    | k |   |   |   | n |   |   |   |   |   |   |   |   |   |   |   |
| No Parameters                      |   |   |   | X |   |   |   |   |   | X |   |   |   |   |   |   |
| :asname                            | X |   |   |   |   |   |   |   |   |   |   |   |   |   |   |   |
| :dpc/dpca/dpci/dpcn/dpcn24         |   |   |   |   |   |   |   |   |   |   | X |   |   |   |   |   |
| :id                                |   |   | X |   |   |   |   |   |   |   |   |   |   |   |   |   |
| :loc                               |   | X |   |   | X | X |   |   |   |   |   |   | X | X |   |   |
| :lsn                               |   |   |   |   |   |   | X |   |   |   |   |   |   |   |   |   |
| :e1port=1-8                        |   |   |   |   | X |   |   |   |   |   |   |   |   |   |   |   |
| :link=a, b                         |   |   |   |   | X |   |   |   |   |   |   |   | X |   |   |   |
| :link=a, b, a1, a2, b1, b2, a3, a3 |   |   |   |   |   |   |   |   |   |   |   |   | X |   |   |   |
| :link=a1, a2, b1, b2               |   |   |   |   |   |   | X | X |   | X |   |   |   |   |   |   |
| :link=a, b, a1-a31, b1-b31         |   |   |   |   |   | X |   |   |   |   |   |   |   | X |   |   |
| :sname                             | X |   |   |   |   |   |   |   |   |   |   |   |   |   |   |   |
| :t1port=1-8                        |   |   |   |   |   |   |   |   |   |   |   |   |   | X |   |   |
| :trm                               |   |   |   |   |   |   |   |   |   |   |   |   |   |   |   | X |

If the **sname** parameter is specified, the socket name must exist in the IPAPSOCK table.

If a point code parameter is specified, the point code must exist in the Routing table.

The card location that is specified in the **loc** parameter must be equipped.

The specified device type must be supported by the card in the specified card location.

The Origin-Based MTP Routing feature must be enabled and turned on before specifying the **dev=rtx** parameter.

When the **dev=ndclk** parameter is specified, the **link** parameter must be specified.

The **link** parameter must be valid for the selected device type.

**Notes**

In this command, only ITU-international and ITU national point codes support the spare point code subtype prefix (s-) and the private and spare point code subtype prefix (ps-). All of the point code types support the private (internal) point code subtype prefix (p-).

**Output**

```
unhb-alm:dev=route:dpc=1-1-1
rlghncxa03w 03-03-23 13:20:59 EST EAGLE 31.3.0
Alarms are inhibited.

rlghncxa03w 03-03-23 13:20:59 EST EAGLE 31.3.0
Command Completed.
;

unhb-alm:dpc=1-101-1:opc=4-4-4:dev=rtx
stdcfg2b 06-05-27 20:22:02 EST EAGLE 35.0.0
Alarms are enabled
Command Completed.
;
```

**unhb-slk****Uninhibit Signaling Link**

Use this command to return an inhibited signaling link to service. If the link was aligned when it was inhibited, a changeover occurred. This command causes a changeback on the specified link. MSUs are transmitted on the link after the changeback is issued.

**NOTE: The inhibited status of the signaling link is not preserved across a LIM reboot.**

**Keyword:** unhb-slk

**Related Commands:** act-slk, blk-slk, dact-slk, dlt-slk, ent-slk, inh-slk, rept-stat-slk, rtrv-slk, tst-slk, ublk-slk

**Command Class:** Link Maintenance

**Parameters**

**:link=** (mandatory)

The signaling link on the card specified in the **loc** parameter. The signaling links can be specified in any sequence or pattern.

**Synonym:** port

**Range:** a, b, a1-a31, b1-b31

Not all card types support all **link** parameter values.

See Table A-1 for valid **link** parameter range values for each type of card that can have a location specified in the **loc** parameter.

**:loc=** (mandatory)

The card location as stenciled on the shelf of the system.

**Range:** 1101-1108, 1111-1112, 1201-1208, 1211-1218, 1301-1308, 1311-1318, 2101-2108, 2111-2118, 2201-2208, 2211-2218, 2301-2308, 2311-2318, 3101-3108, 3111-3118, 3201-3208, 3211-3218, 3301-3308, 3311-3318, 4101-4108, 4111-4118, 4201-4208, 4211-4218, 4301-4308, 4311-4318, 5101-5108, 5111-5118, 5201-5208, 5211-5218, 5301-5308, 5311-5318, 6101-6108, 6111-6118

**Example**

```
unhb-slk:loc=1301:link=a
```

**Dependencies**

A card location that is valid and defined in the database must be specified.

No other action command can be in progress when this command is entered.

The card must be equipped and must be one of the following cards:

- An E1 ATM card running the **atmitu** application
- An E1/T1 MIM, E5-E1T1, or HC MIM card running the **ss7ansi** or **ccs7itu** application
- An E5 ATM card running the **atmansi** or **atmitu** application
- An E5-ENET card running the **ipsg** application
- An E5-ENET card or SSEDCCM card running the **iplim** or **iplimi** application with links having **ipliml2=m2pa**
- A LIM card running the **ss7ansi**, **ss7gx25**, or **ccs7itu** application
- A LIM ATM card running the **atmansi** application

The card must contain signaling links.

The signaling link must be equipped in the database.

The inhibit and uninhibit actions are valid for links on IPLIMx SSEDCCMs that have **ipliml2=m2pa**.

The following **link** parameter values can be specified for the following cards that support more than 2 links per card:

- **a1-a3, b1-b3**—Multi-port LIM (MPL),
- An SSEDCCM card running the **iplim** or **iplimi** application with links having **ipliml2=m2pa**
- **a1-a31, b1-b31**—HC-MIM card
- **a1-a15, b1-b15**—E5-E1T1 card
- **a1-a7, b1-b7**—E5-ENET card running the **iplim** or **iplimi** application that supports 16 links.
- **a1-a15, b1-b15**—E5-ENET card running the **ipsg** application.

The card in the specified card location cannot be a TDM card, an MDAL card, an HMUX or HIPR card, or the cards running the OAM application.

This command is not valid on TCP/IP point to multipoint links (DCM cards equipped as SS7IPGW links).

If an IPSPG-M3UA signaling link is used, then this command cannot be entered.

The card must be equipped and must be one of the following cards:

- An E1 ATM card running the **atmitu** application
- An E1/T1 MIM, E5-E1T1, or HC MIM card running the **ss7ansi** or **ccs7itu** application
- An E5 ATM card running the **atmansi** or **atmitu** application
- An E5-ENET card running the **ipsg** application
- An E5-ENET card or SSEDCCM card running the **iplim** or **iplimi** application with links having **ipliml2=m2pa**
- A LIM card running the **ss7ansi**, **ss7gx25**, or **ccs7itu** application
- A LIM ATM card running the **atmansi** application

### Notes

This command is not valid on TCP/IP point to multipoint links (SSEDCM cards or E5-ENET cards equipped as SS7IPGW or IPGWI links or E5-ENET cards equipped as IPGS-M3UA links). TCP/IP point to point links (IPLIM and IPLIMI) can be uninhibited.

The function of this command is the same as the **canc-lpo** command.

The *Installation Manual – EAGLE 5 ISS* provides an illustration of card locations.

### Output

```
unhb-slk:loc=1301:link=a
  rlghncxa03w 03-03-23 13:20:59 EST  EAGLE 31.3.0
  Allow Link message sent to card
;
```

## unlock

### Unlock Keyboard

Use this command to unlock a previously locked terminal keyboard. Anyone attempting to use the keyboard is prompted to enter the password of the currently logged-in user.

**Keyword:** unlock

**Related Commands:** lock

**Command Class:** Basic

### Parameters

This command has no parameters.

### Example

```
unlock
```

### Dependencies

You must enter the password of the logged in user to unlock the keyboard.

This command is valid only if the keyboard is locked.

The port must not be in an unlock disabled state because of excessive successive unlock failures.

### Notes

None

### Output

```
unlock
  Enter LOGIN password to unlock keyboard :
```

# Debug Commands

## Introduction

This chapter contains information about debug commands used in troubleshooting and debugging the system. These commands are intended only for Tekelec Technical Services personnel and authorized engineering personnel in the operating companies. The use of these commands is restricted to personnel who have access to the command class Debug.



CAUTION

**CAUTION: These commands are to be used precisely as they are described in this chapter, and only under the direction of Tekelec Technical Services personnel. Any other use of these commands can result in a system failure.**

This chapter contains the debug commands in alphabetical order.

## act-upgrade

## Activate Upgrade

Use this command to perform a software upgrade from a source release to the target release on an in-service system.



CAUTION

**CAUTION: It is strongly recommended that this command be used only in conjunction with the system Upgrade Procedure for your target release. The Upgrade Procedure provides step-by-step information on performing an upgrade.**

**Keyword:** act-upgrade

**Related Commands:** rept-stat-db

**Command Class:** Debug

### Parameters

**:action=** (mandatory)

This parameter specifies the action to be performed for the upgrade process.



CAUTION

**CAUTION: The converttoam, convertnet, and netcomplete actions should be used only under the direction of Tekelec personnel.**

**Range:** yyyyyyyyyy

Up to 10 alphabetic characters. Valid actions are:

- **chkrel**—Validates the stored upgrade target release on the physical disk as specified by the **src** parameter with the software access key.
- **converttoam**—Converts the standby OAM database.
- **convertnet**—Performs an inhibit/allow sequence for each network card. This sequence effects the controlled loading of the new release generic program load (GPL) and of the converted database. Requires upgrade phase indicator of 3.
- **convertstp**—Performs all OAM and network conversions necessary for an upgrade. This command transitions through all of the upgrade phases to upgrade completion. If measurement collection is turned on, this command automatically inhibits measurements during the upgrade. Upon completion of the upgrade, this command returns the MASP's to full-function mode with measurement collection turned back on.
- **dbstatus**—Reports the status of all database partitions on the TDM fixed disks and the removable drive(s) (similar to the **rept-stat-db:display=version** command).
- **getrel**—Retrieves the upgrade target release file from either the EAGLE 5 ISS software release distribution server or the credit card USB. It then expands the data on the inactive partition group of the hard disks.
- **netcomplete**—Indicates upgrade completion and places the system in a fully functional mode.
- **oamcomplete**—Sets the upgrade phase number to 3, enables the beginning of controlled card loading, and allows OAP terminals to be attached.

**:appl=** (optional)

This parameter specifies the name of the GPL on which to perform the network upgrade.

**Range:** *ayyyyyyy*

1 alphabetic character followed by up to 7 alphanumeric characters. Use the **rept-stat-gpl** command or the **rtrv-gpl** command to obtain the valid GPLs.

**Default:** All GPLs

**:dest=** (optional)

This parameter specifies the disk that is used as the physical work area for the conversion of the database.

**Range:** **fixed**, **remove**

**fixed**— Convert the database on the fixed disk

**remove**— Convert the database on the removable cartridge

This parameter cannot be specified for E5-MDAL or E5-MCAP cards.

**:force=** (optional)

This parameter forces a command to be executed if the **action=convertnet** parameter is specified.

If the **action=convertnet** parameter is specified, and if all cards of the specified GPL type are not in the In-Service Normal state or Out-Of-Service Maintenance-Disabled state, then the **force** parameter must be specified. In this case, minimum service may not be maintained when the command is executed with the **force** parameter.

If the **action=convertnet** parameter is not specified, then the **force** parameter is ignored.

**Range:** **yes**, **no**

**Default:** **no**

**:release=** (optional)

This parameter specifies the name of the EAGLE 5 ISS software release file to be downloaded.

This file contains the upgrade target release on the EAGLE 5 ISS software release distribution server or credit card USB.

**Range:** `xxxxxxxxxxxxxxxxxxxxxxxxxxxxxxxxxxxxxxxx`  
 1 alphabetic character followed by up to 29 alphanumeric characters. One or more periods can be used.

**:src=** (optional)

This parameter specifies the physical disk that contains the upgrade target release.

**Range:** **fixed, remove, usb, server**  
**fixed** — The upgrade target release is on the fixed disk  
**remove** — The upgrade target release is on the removable cartridge  
**usb** — The upgrade target release is on the credit card drive  
**server** — The upgrade target release is on the remote server  
 The **src=remove** parameter cannot be specified for E5-MDAL or E5-MCAP cards.

**:thres=** (optional)

Network Threshold value. This parameter specifies the percentage of signaling links that are to remain in service (IS) during the network conversion phase and enables SCCP thresholding and flashing on non-provisioned cards during the upgrade.

**Range:** **50 - 90**  
**Default:** The network cards are updated serially.

**Example**

```
act-upgrade:action=convertstp
act-upgrade:action=dbstatus
act-upgrade:action=convertstp:dest=remove
```

The following shows a variation of the getrel option that finds the release on the credit card usb instead of through the E5-IPSM card.

```
act-upgrade:action=getrel:release="37.5.2-58.41.2.tar.gz":src=usb
act-upgrade:action=chkrel:src=fixed
```

**Dependencies**

Table 6-1 lists the actions (**action** parameter values) that correspond to a given upgrade mode. An action is accepted only when the system is in the corresponding upgrade mode.

**Table 6-1.** Actions with Corresponding Upgrade Phase

| Action                    | Corresponding Upgrade Phase |
|---------------------------|-----------------------------|
| <b>action=converttoam</b> | 0 and 1                     |
| <b>action=oamcomplete</b> | 2                           |
| <b>action=convertnet</b>  | 3                           |
| <b>action=netcomplete</b> | 3                           |
| <b>action=convertstp</b>  | 0 through 3                 |

If measurement collection is enabled, the **act-upgrade:action=convertstp** command automatically inhibits measurement collection during the upgrade. Before returning to full function mode, measurements are turned back on. The following actions require that you manually inhibit measurements: **converttoam, oamcomplete, convertnet, and netcomplete.**

A valid upgrade release must reside on the removable cartridge, credit card drive, or the inactive partition of the fixed disk.

The standby OAM database must be the source release.

The current OAM database must be the source release.

The database partition must be coherent.

The database partition must be in the correct functional mode.

If the **appl** parameter is specified, then the **action=convertnet** parameter must be specified. If the **action=convertnet** parameter is specified, then the **appl** parameter must be specified.

If the **force** parameter is specified, then the **action=convertnet** parameter must be specified.

If the **action=convertnet** parameter is specified, and if all cards of the specified GPL type are not in the In-Service Normal state or Out-Of-Service Maintenance-Disabled state, then the **force** parameter must be specified. In such cases, minimum service may not be maintained.

If the **thres** parameter is specified, then the **action=convertnet** and **action=convertstp** parameters must be specified.

The destination of a static IP route or the local interface network address of an IP card cannot be the same as the EAGLE 5 ISS PVN, FCNA, or FCNB network address.

Upgrade conversion cannot be initiated from a telnet-type terminal (terminal IDs 17-40).

TALI sockets cannot be configured in the system.

ISUP Normalization feature-related configuration cannot be present in the system.

The dual-slot DCM card (card type **dcm**) is obsolete for **ss7ipgw**, **ipgwi**, **iplim**, and **iplimi** applications.

TALI links cannot be configured in the system.

The **action=getrel** parameter and the **release** parameter must be specified together in the command.

An E5-IPSM card must be provisioned and in service before a value of **getrel** or **chkrel** can be specified for the **action** parameter.

The **ent-ftp-serv:app=dist** command must be entered before a value of **getrel** or **chkrel** can be specified for the **action** parameter.

If the **dest=remove** parameter is specified, then the **src=fixed** and **src=usb** parameters cannot be specified.

An E5-MCAP card must be provisioned in the system before the **src=usb** parameter can be specified.

If the **src=fixed** parameter is specified, then a removable cartridge or credit card drive cannot be inserted.

If the **src=remove** parameter is specified, then a removable cartridge must be inserted in the system.

If an E5-MCAP or E5-MDAL card is used, then the **src=remove** parameter cannot be specified.

Invalid hardware configuration alarms are set or an HMUX alarm must be addressed.

All cards that are in the auto-inhibited state must be removed before this command can be entered.

Cards that prevent the IMT buses from being inhibited during the upgrade cannot exist in the system.

The specified source drive is not at the correct database version for the upgrade to proceed.

The removable cartridge cannot contain an EAGLE 5 ISS backup image.

If the **src=usb** parameter is selected, then the credit card USB upgrade media must be inserted in the Active OAMs flush mount USB slot.

The internal ramdisk is not available for the credit card USB upgrade image to be unpackaged.

The disk that contains the upgrade target release is in an unknown upgrade mode.



If the **src=usb** or **src=server** parameter is specified, then the **action=getrel** parameter must be specified. If the **src=remove** or **src=fixed** parameter is specified, then the **action=getrel** parameter cannot be specified.

The EAGLE 5 ISS PVN address in the source database cannot be identical to the EAGLE 5 ISS FCNA or FCNB network address in the target database.

The **icdpnunknX** and **icdpnunknX** and the **gcdpnunknX** and **gcdpnunknX** NPP Action Sets cannot co-exist in the source release.

This command cannot be entered if an IMT Rate Change sequence is in progress.

## Notes

For the **appl** parameter, the list of valid GPLs varies from release to release. The **rtrv-gpl** command can be used (when in full function mode) to obtain a list of the GPLs currently resident on the TDMs. The **rept-stat-gpl** command can be used to obtain a list of the GPLs currently active on provisioned network cards.

The **act-upgrade:action=convertstp** command executes all four upgrade phases consecutively.

If the **act-upgrade:action=convertstp** command is entered following a command abort, the upgrade processing determines the last upgrade phase that was successfully completed. The upgrade processing then attempts to restart from that point to successful completion. Re-entering the **act-upgrade:action=convertstp** command following a command abort is the recommended method for recovery.

The TDMs and removable cartridge have upgrade phase indicators. The upgrade command expects the disks to be in certain phases before executing a specific action. If the disks are not in the correct phases, an error is generated.

The command **act-upgrade:action=dbstatus** generates output similar to that provided by the command **rept-stat-db:display=version**.

The **thres** parameter is used for the following purposes:

- Allows for multiple cards to be upgraded together, as long as the specified percentage of links remain in service. If no **thres** parameter is specified, the cards are upgraded serially. The value is applied to groups of links based upon the link-supporting GPL being upgraded.
- Enables SCCP thresholding, which allows multiple Service Module cards to be upgraded together. The specified **thres** parameter value is not used to determine the number of Service Module cards to upgrade. The peak SCCP load since the last OAM boot is used to determine the number of cards that must remain in service (at least half of the cards must remain in service).
- Enables the non-provisioned flash function, which flash-downloads any boot-prom type card if the card is in the system but not provisioned.

The **act-upgrade:action=getrel** action defaults to getting the release from the provisioned E5-IPSM card using the provisioned FTP Server. If the **src=usb** parameter is specified, and an E5-MCAP card is used, then the release is obtained from the credit card USB upgrade media.

Output

**NOTE: The act-upgrade:action=convertstp command performs the OAM conversion and the network conversion. During the conversion, this command broadcasts the current activity in the scroll area. Refer to Appendix B of the EAGLE 5 ISS Release Software Upgrade Procedure for a sample of message output.**

The action **dbstatus** reports the current database status.

**act-upgrade:action=dbstatus**

tekelecstp 03-08-01 08:30:00 EST Rel 31.3.0 Upg Phase 2

DATABASE STATUS: >> OK <<

| TDM 1114 (STDBY) |       |                  |                   | TDM 1116 (ACTV) |       |                  |                      |
|------------------|-------|------------------|-------------------|-----------------|-------|------------------|----------------------|
| C                | LEVEL | TIME LAST BACKUP |                   | C               | LEVEL | TIME LAST BACKUP |                      |
| FD BKUP          | Y     | 1                | 03-08-01 08:30:00 | EST             | Y     | 1                | 03-08-01 08:30:00EST |
| FD CRNT          | Y     | 1                |                   |                 | Y     | 1                |                      |

MDAL 1117

|         |   |   |  |  |  |  |  |
|---------|---|---|--|--|--|--|--|
| RD BKUP | Y | 1 |  |  |  |  |  |
|---------|---|---|--|--|--|--|--|

| CARD/APPL | LOC  | C | T | LEVEL | TIME LAST UPDATE  | VERSION STATUS     |
|-----------|------|---|---|-------|-------------------|--------------------|
| TDM-CRNT  | 1114 | Y | N | 1     | 03-08-01 08:30:00 | 123-001123-000-000 |
| UPG 2     |      |   |   |       |                   |                    |
| TDM-BKUP  | 1114 | Y | - | 1     | 03-08-01 08:30:00 | 123-001123-000-000 |
| UPG 2     |      |   |   |       |                   |                    |
| TDM-CRNT  | 1116 | Y | N | 1     | 03-08-01 08:30:00 | 123-001123-000-000 |
| UPG 2     |      |   |   |       |                   |                    |
| TDM-BKUP  | 1116 | Y | - | 1     | 03-08-01 08:30:00 | 123-001123-000-000 |
| UPG 2     |      |   |   |       |                   |                    |
| MDAL      | 1117 | Y | - | 1     |                   | 123-001123-000-000 |
| UPG 2     |      |   |   |       |                   |                    |

| INACTIVE | PARTITION | GROUP | CARD/APPL | LOC  | C | T | LEVEL | TIME LAST UPDATE  | VERSION STATUS     |
|----------|-----------|-------|-----------|------|---|---|-------|-------------------|--------------------|
|          |           |       | TDM-CRNT  | 1114 | Y | N | 1     | 03-08-01 08:30:00 | 118-000-000 NORMAL |
|          |           |       | TDM-BKUP  | 1114 | Y | - | 1     | 03-08-01 08:30:00 | 118-000-000 NORMAL |
|          |           |       | TDM-CRNT  | 1116 | Y | N | 1     | 03-08-01 08:30:00 | 118-000-000 NORMAL |
|          |           |       | TDM-BKUP  | 1116 | Y | - | 1     | 03-08-01 08:30:00 | 118-000-000 NORMAL |

;

cdu

CAP Downloadable Utility

The CAP Downloadable Utility (CDU) is a diagnostic program that can be downloaded to any card including the DSM/DCM cards on the system by entering the **alw/rst-card:loc= xxxx :code=utility** command.

This command is used to enter commands to perform diagnostic functions. The command syntax is as follows:

**cdu:loc=xxxx:cmd="command string"**

where the **loc** and **cmd** parameters are mandatory parameters for the **cdu** command. The command string, which is enclosed in double quotes (“ ”), specifies the diagnostic function to perform and includes any optional or mandatory parameters for the specified **cmd** keyword.



- **act-cachetst**—Starts the cache test on the specified memory range.
- **dump-cachetst**—Displays the results of the cache test. This command has no parameters.
- **act-pingtst**—Implements a network test in the VCDU utility only. The ping test is applicable to DCM/DSM cards only and will not work in the other cards.
- **canc-pingtst**—Aborts the ping test. This command has no parameters.
- **rtrv-pingtst**—Displays the results of the ping test. This command has no parameters.

Subrange: The keywords used in the command strings use the following parameters.

**Table 6-2.** Subrange Parameters for cmd Keywords

|                                                                                                                                                                                                                                                                                                                                                                                                                                                                                                                                                                                                                                                                                                                                                                                                                                                                                                  |
|--------------------------------------------------------------------------------------------------------------------------------------------------------------------------------------------------------------------------------------------------------------------------------------------------------------------------------------------------------------------------------------------------------------------------------------------------------------------------------------------------------------------------------------------------------------------------------------------------------------------------------------------------------------------------------------------------------------------------------------------------------------------------------------------------------------------------------------------------------------------------------------------------|
| <p><b>:beg</b>=(mandatory)</p> <p>The start address of the physical memory range to be tested. The value is a hexadecimal number. This parameter is used with the keywords <b>act-cachetst</b>, <b>act-checkbit</b>, <b>act-memtst</b> , <b>fill-mempat</b>, and <b>tst-mempat</b>.</p> <p>Range:</p> <ul style="list-style-type: none"> <li>• For cards other than the DSM—<b>h'00100000–h'bffffffc</b></li> <li>• For act-checkbit only—<b>h'80000000–h'bffffffc</b></li> <li>• For act-cachetst only—<b>h'01400000–h'ffd40000</b></li> <li>• For 1GB DSM card only—<b>h'01400000–h'3ffffffc</b></li> <li>• For 2GB DSM card only—<b>h'01400000–h'7ffffffc</b></li> <li>• For 3GB DSM card only—<b>h'01400000–h'bffffffc</b></li> <li>• For 4GB DSM card only—<b>h'01400000–h'ffdffffc</b></li> </ul>                                                                                          |
| <p><b>:end</b>= (mandatory)</p> <p>The first address beyond the last address of the physical memory range to be tested. The value is a hexadecimal number. This parameter is used with the following keywords: <b>act-checkbit</b>, <b>actcachetst</b>,<b>act-memtst</b>, <b>fill-mempat</b>, and <b>tst=mempat</b>.</p> <p>Range:</p> <ul style="list-style-type: none"> <li>• For cards other than the DSM—<b>h'00100002–h'c0000000</b></li> <li>• For act-checkbit only—<b>h'80000004–h'c0000000</b></li> <li>• For act-cachetst only—<b>h'01440000–h'ffdfffff</b></li> <li>• For act-memtst on 1GB DSM card only—<b>h'01400000–h'40000000</b></li> <li>• For act-memtst on 2GB DSM card only—<b>h'01400000–h'80000000</b></li> <li>• For act-memtst on 3GB DSM card only—<b>h'01400000–h'c0000000</b></li> <li>• For act-memtst on 4GB DSM card only—<b>h'01400000–h'ffe00000</b></li> </ul> |

Table 6-2. Subrange Parameters for cmd Keywords

|                                                                                                                                                                                                                                                                                                                                                                                                                                                                                                                                             |
|---------------------------------------------------------------------------------------------------------------------------------------------------------------------------------------------------------------------------------------------------------------------------------------------------------------------------------------------------------------------------------------------------------------------------------------------------------------------------------------------------------------------------------------------|
| <p><b>:loop=</b> (optional)</p> <p>The number of times a test is performed. The value is a hexadecimal or a decimal number. This parameter is used with the following keywords: <b>act-memtst</b>, <b>act-cachetst</b>, <b>act-memflt</b>, <b>actcheckbit</b>, <b>act-qcktst</b>, and <b>act-pingtst</b>.</p> <p>Range: <b>h'0–h'ffff</b></p> <p>The value <b>h'0</b> indicates that an infinite number of tests is performed.</p> <p>Default: <b>h'1</b></p>                                                                               |
| <p><b>:data=</b> (mandatory)</p> <p>The hexadecimal of the data pattern. This parameter is used only with the keywords <b>act-cachetst</b>, <b>fill-mempat</b>, and <b>tst-mempat</b>.</p> <p>Range: <b>h'0000–h'ffff</b></p>                                                                                                                                                                                                                                                                                                               |
| <p><b>:port=</b>(mandatory)</p> <p>The port address from which to start the ping. This parameter is used only with the keyword <b>act-pingtst</b>.</p> <p>Range: <b>a, b</b></p>                                                                                                                                                                                                                                                                                                                                                            |
| <p><b>:dest=</b> (mandatory)</p> <p>The destination IP address to be pinged. This is a TCP/IP address expressed in standard dot notation. IP addresses consist of the system's network number and the machine's unique host number. An example IP address is 192.126.100.5, where 192.126.100 is the network number and 5 is the machine's host number. This parameter is used only with the keyword <b>act-pingtst</b>.</p> <p>Range: 4 numbers separated by dots, with each number in the range of <b>0–255</b>.</p>                      |
| <p><b>:router=</b>(optional)</p> <p>The router through which the network interface can be tested. This is a TCP/IP address expressed in standard dot notation. IP addresses consist of the system's network number and the machine's unique host number. An example IP address is 192.126.100.5, where 192.126.100 is the network number and 5 is the machine's host number. This parameter is used only with the keyword <b>act-pingtst</b>.</p> <p>Range: 4 numbers separated by dots, with each number in the range of <b>0–255</b>.</p> |
| <p><b>:type=</b>(optional)</p> <p>Indicates the type of memory test to perform: a comprehensive high-memory test or a fast high-memory test. The fast test performs two tests: the Write/Read block and the Address Write/Read. The comprehensive test performs the fast</p>                                                                                                                                                                                                                                                                |

Table 6-2. Subrange Parameters for cmd Keywords

|                                                                                                                                                                                                                                                                                                               |
|---------------------------------------------------------------------------------------------------------------------------------------------------------------------------------------------------------------------------------------------------------------------------------------------------------------|
| <p>test as well as a Write/Read Walking 1/0s. This parameter is used only with the <b>act-memtst</b> keyword.</p> <p>Range: <b>full, fast</b></p> <p>Default: <b>full</b></p>                                                                                                                                 |
| <p><b>:addr=</b> (mandatory)</p> <p>Indicates the physical address to test. This parameter must be dword aligned and must not be the first or last dword of the installed M256 expansion DRAM. This parameter is used only with the <b>act-memflt</b> keyword.</p> <p>Range: <b>h'80000004–h'bffffff8</b></p> |

**:loc=** (mandatory)

The card location of the card as stenciled on the shelf of the system.

Range: **1101-1108, 1111-1113, 1201-1208, 1211-1218, 1301-1308, 1311-1318, 2101-2108, 2111-2118, 2201-2208, 2211-2218, 2301-2308, 2311-2318, 3101-3108, 3111-3118, 3201-3208, 3211-3218, 3301-3308, 3311-3318, 4101-4108, 4111-4118, 4201-4208, 4211-4218, 4301-4308, 4311-4318, 5101-5108, 5111-5118, 5201-5208, 5211-5218, 5301-5308, 5311-5318, 6101-6108, 6111-6118, 1115**

### Example

```

cdu:loc=1215:cmd="act-
memtst:beg=h'00100000:end=h'00100002:loop=3:type=fast"
cdu:loc=1215:cmd="canc-memtst"
cdu:loc=1215:cmd="rtrv-memtst"
cdu:loc=1215:cmd="fill-
mempat:beg=h'00100000:end=h'c0000000:data=h'ffff"
cdu:loc=1215:cmd="tst-
mempat:beg=h'00100000:end=h'c0000000:data=h'ffff"
cdu:loc=1215:cmd="act-qcktst:loop=h'2"
cdu:loc=1215:cmd="canc-qcktst"
cdu:loc=1215:cmd="rtrv-qcktst"
cdu:loc=1215:cmd="act-
pingtst:port=a:dest=215:200:100.6:router=150.1.1.105:loop=h'2"
cdu:loc=1215:cmd="canc-pingtst"
cdu:loc=1215:cmd="rtrv-pingtst"
cdu:loc=1107:cmd="act-
cachetst:beg=h'01400000:end=h'01440000:data=h'ffff"
cdu:loc=1107:cmd="dump-cachetst"
cdu:loc=1215:cmd="act-
checkbit:beg=h'80000000:end=h'80000004:loop=h'2"
cdu:loc=1215:cmd="rtrv-checkbit"
cdu:loc=1215:cmd="act-memflt:addr=h'80000004:loop=h'3"
cdu:loc=1215:cmd="rtrv-memflt"

```

### Dependencies

If the **act-cachetst** keyword is entered, the address range should not be less than 256 KB.

The **fill-mempat** keyword must be entered before the **act-cachetst** keyword can be entered.

The quick memory test commands can be entered only on DSM cards.

The ping test commands can be entered only on DSM or DCM cards.

### Notes

The **act-memtst:type=full** test takes approximately 21 hours to run on a 1 GB TSM. The **actmemtst:type=fast** test takes approximately 1 hour. The VCDU utility has the capability to test the 4 GB of memory in 4 hours if the **act-memtst** command is entered with the **type** parameter set to **fast**.

## Output

```
cdu:loc=1107:cmd="dump-memtst"
cdu: paced memtst output begins
  address          written read  address          written read
bad: h'01400000, h'5a5a, h'ffff h'01400002, h'5a5a, h'ffff
bad: h'01400004, h'5a5a, h'ffff h'01400006, h'5a5a, h'ffff
bad: h'01400008, h'5a5a, h'ffff h'0140000a, h'5a5a, h'ffff
bad: h'0140000c, h'5a5a, h'ffff h'0140000e, h'5a5a, h'ffff
bad: h'01400010, h'5a5a, h'ffff h'01400012, h'5a5a, h'ffff
bad: h'01400014, h'5a5a, h'ffff h'01400016, h'5a5a, h'ffff
bad: h'01400018, h'5a5a, h'ffff h'0140001a, h'5a5a, h'ffff
```

```
cdu:loc=1107:cmd="dump-mempat"
cdu: paced mempat output begins
  address          written read  address          written read
bad: h'01400000, h'1234, h'ffff h'01400002, h'1234, h'ffff
bad: h'01400004, h'1234, h'ffff h'01400006, h'1234, h'ffff
bad: h'01400008, h'1234, h'ffff h'0140000a, h'1234, h'ffff
bad: h'0140000c, h'1234, h'ffff h'0140000e, h'1234, h'ffff
bad: h'01400010, h'1234, h'ffff h'01400012, h'1234, h'ffff
bad: h'01400014, h'1234, h'ffff h'01400016, h'1234, h'ffff
bad: h'01400018, h'1234, h'ffff h'0140001a, h'1234, h'ffff
bad: h'0140001c, h'1234, h'ffff h'0140001e, h'1234, h'ffff
bad: h'01400020, h'1234, h'ffff h'01400022, h'1234, h'ffff
bad: h'01400024, h'1234, h'ffff h'01400026, h'1234, h'ffff
bad: h'01400028, h'1234, h'ffff h'0140002a, h'1234, h'ffff
```

**NOTE: The fill-mempat keyword must be specified before the act-cachetst keyword is specified.**

```
cdu:loc=1107:cmd="fill-mempat:beg=h'11000000:end=h'11001000:data=h'1234"
```

```
cdu:loc=1107:cmd="act-
cachetst:beg=h'11000000:end=h'11001000:data=h'1234"
```

```
CARD : 1107 CDU: Cache Test Strt Loop 0x1
CARD : 1107 CDU: Cache Test Pass Loop 0x1
```

or

```
CARD : 1107 CDU: Cache Test Strt Loop 0x2
CARD : 1107 CDU: Cache Test Fail Loop 0x2
```

or

```
CARD : 1107 CDU: Cache write back may not occur w/ address range less than 256KB
```

or

```
CARD : 1107 CDU: Cache Test Already Running
```

```
cdu:loc=1107:cmd="dump-cachetst"
CARD 1107 CDU: PACED CACHETST OUTPUT BEGINS
CARD 1107 B:11000004,1234,55aa
```

```
cdu:loc=1107:cmd="act-qcktst"
CARD: 1107 CDU: Quick Test Started: Loop 0x1
CARD: 1107 CDU: Quick Test Passed: Loop 0x1
```

or

```
CARD: 1107 CDU: Quick Test Already In progress
```

or

```
CARD: 1107 CDU: Quick Test Started: Loop 0x1
CARD: 1107 CDU: Quick Test Failed: Loop 0x1
```





**:type=** (mandatory)

This parameter specifies the type of board.

**Range:** **mbd, dbd**

**mbd** — main assembly

**dbd** — applique

**:dbdloc=** (optional)

Applique location. This parameter specifies the location of the applique.

This parameter is valid only with cards that support multiple appliques.

**Range:** **1-2**

**Default:** **1**

### Example

The following example changes the rev field in the BIP data for the first applique of a card that supports multiple appliques.

```
chg-bip-fld:loc=1106:type=dbd:fld=rev:data="B":dbdloc=1
```

The following example changes the rev field in the BIP data for the applique of a card that supports only one applique.

```
chg-bip-fld:loc=1103:type=dbd:fld=rev:data="C"
```

The following example shows changing of sm (Software MatchID) field in BIP data of Main assembly.

```
chg-bip-fld:loc=1102:type=mbd:fld=sm:data="001"
```

The following example changes the rev field in the BIP data for the first applique of a card that supports multiple appliques, without specifying the dbdloc parameter.

```
chg-bip-fld:loc=1206:type=dbd:fld=rev:data="B"
```

### Dependencies

The value of the **loc** parameter cannot specify a location for a fixed disk or removable cartridge.

The **type=dbd** parameter cannot be specified for card type GPSM-II, HCAP, ATM or DCM. HMUX and HIPR cards do not contain BIP information.

If the **type=mbd** parameter is specified, then the **dbdloc** parameter cannot be specified.

The card at the location specified by the **loc** parameter must support multiple appliques before the **dbdloc** parameter can be specified.

### Notes

The card in the specified location must be inhibited.

### Output

```
chg-bip-fld:loc=1103:type=mbd:fld=rev:data="B"
tekelecstp 07-01-01 12:05:44 IST EAGLE 37.0.0
Board ID Prom updated.
;
```

## chg-bip-rec

### Change Board Identification PROMs Record

Use this command to manually update the Board Identification PROM (BIP) data during an upgrade in the field.



The following example displays the programming of the DCM Ethernet Addresses for Port A (ENT01).

```
chg-bip-rec:loc=1102:type=mbd:data="ENT01,AD00001704000D,cs104"
```

The following example displays the programming of the BIP data for the first applique of a card that supports multiple appliques, without specifying the dbdloc parameter.

```
chg-bip-rec:loc=1206:type=dbd:data="BID01,PN850-0666-04.A,SMEG.001,DS2007.11 .C.10207115240,CS157"
```

### Dependencies

The value of the **loc** parameter cannot specify a location for a fixed disk or removable cartridge.

The **type=dbd** parameter cannot be specified for card type GPSM-II, HCAP, ATM or DCM. HMUX and HIPR cards do not contain BIP information.

If the **type=mbd** parameter is specified, then the **dbdloc** parameter cannot be specified.

If the card at the location specified by the **loc** parameter does not support multiple appliques, then the **dbdloc** parameter cannot be specified.

If the **init=yes** parameter is specified, then the value of the **data** parameter must be a Board Identification (BID) record.

### Notes

The card in the specified location must be inhibited.

### Output

```
chg-bip-rec:loc=1107:type=mbd:data=xxx:init=yes
tekelecstp 07-01-01 12:05:44 IST EAGLE 37.0.0
Board ID Prom updated.
;
```

## chg-tbl

### Change Table

Use this command to create, rename, or reset any table on a fixed disk, removable cartridge, or removable drive.



CAUTION

**CAUTION: Before entering the chg-tbl command, contact the Customer Care Center.**

**Keyword:** chg-tbl

**Related Commands:** disp-disk-dir

**Command Class:** Debug

### Parameters

**:action=** (mandatory)

This parameter specifies the desired action to perform on the table.

**Range:** create, rename, reset

**create**— Creates a DOS entry in the FAT table and updates the DOS directory table.

**rename**— Changes the name of an existing system table to a new DOS file name (does not update the **dms.cfg** file).

**reset**— Initializes an existing table to the value designated by the **resetchar** parameter.

**:disk=** (mandatory)

Target disk. This parameter specifies the disk that contains the file.

**Range:** remove, fixed, usb

**remove** — Removable cartridge or drive  
**fixed** — Fixed disk  
**usb** — Argument to be used by Tekelec personnel only.

**:ext=** (optional)

Extension. This parameter specifies the three character DOS filename extension.

**Range:** *azz*  
 0–3 ASCII characters

**Default:** No file name extension is specified

**:filelength=** (optional)

This parameter specifies the amount of space the file occupies on the disk.

**Range:** **1-32505856**

**Default:** The file length is not specified

**:id=** (optional)

This parameter specifies the table identification number.

**Range:** **0-499**

**Default:** No table identification number is specified

**:name=** (optional)

This parameter specifies the name of the file.

**Range:** *azzzzzzz*  
 1–8 ASCII characters.

**Default:** No file name is specified

**:prtnggrp=** (optional)

Partition group. This parameter specifies the disk partition group to be changed.

**Range:** **active, inactive**

**Default:** **active**

**:resetchar=** (optional)

Reset character. This parameter specifies the table reset character that is written to every byte of the table.

**Range:** **0-255**

**Example**

```
chg-
tbl:action=create:disk=remove:name=test:ext=sys:filelength=150000
chg-tbl:action=reset:disk=remove:id=0
chg-tbl:action=rename:disk=remove:id=0:name=dms:ext=old
```

**Dependencies**

If the **action=create** parameter is specified, then the **name**, **ext**, and **filelength** parameters must be specified.

If the file type is a directory, the **filelength** parameter is not required. The directory entry file length is always 1 cluster in length.

The attributes used during file creation are: current date and time of the active MASP, readable/writable, files are allocated contiguously from the last free FAT cluster.

If the **action=reset** parameter is specified, then the **id** parameter must be specified.

If the **action=rename** parameter is specified, then the **id**, **name**, and **ext** parameters must be specified.

This command cannot be used to modify the security log.

**Notes**

None

**Output**

```

chg-
tbl:action=create:disk=remove:name=test:ext=sys:filelength=150000

chg-tbl: CREATE OK : filename = test.sys, byte length = 150000
chg-tbl: command complete
;

chg-tbl:action=reset:disk=remove:id=0

chg-tbl: RESET OK : Table 0, DMS.CFG
chg-tbl: command complete
;

chg-tbl:action=rename:disk=remove:id=0:name=dms:ext=old

chg-tbl: RENAME OK : Table 0, DMS.CFG to DMS.OLD
chg-tbl: command complete
;

```

**chg-upgrade-config****Change Upgrade Configuration**

Use this command to configure data used by the upgrade software during an upgrade of an in-service EAGLE 5 ISS from a source release to the target release.

**NOTE: This command does not start the software upgrade; it stores data that will be used during the software upgrade. The data will be cleared when the OAM boots.**

**Keyword:** chg-upgrade-config

**Related Commands:** act-upgrade, rtrv-upgrade-config

**Command Class:** Debug

**Parameters**

**:sak=** (optional)

Software access key. This parameter specifies the software access key that is used to allow the EAGLE 5 ISS to upgrade to the target release.

**Range:** *zzzzzzzzzzzzzz*  
13-character alphanumeric text

**:src=** (optional)

Source. This parameter specifies the disk that physically contains the upgrade target release.

**Range:** **fixed, remove**  
**fixed** — The upgrade target release is on the fixed disk  
**remove** — The upgrade target release is on the removable cartridge

**Example**

```

chg-upgrade-config:addtblcnv=327
chg-upgrade-config:deltblcnv=327
chg-upgrade-config:sak=vbjyapdpbtejb:src=fixed

```

**Dependencies**

The **addtblcnv** parameter and the **deltblcnv** parameter cannot be specified together in the same command.

One, but not both, of the optional parameters must be specified in the command.

### Output

```
chg-upgrade-config:addtblcnv=327
rlghncxa03w 07-03-13 08:15:45 EST EAGLE 37.5.0
Command Completed.
;
```

## clr-disk-stats

### Clear Disk Statistics

Use this command to clear the disk performance statistics. All associated disk statistics are zeroed.

**Keyword:** clr-disk-stats

**Related Commands:** disp-disk-stats

**Command Class:** Debug

### Parameters

**:loc=** (mandatory)

Location. This parameter specifies the location of the card.

**Range:** 1113, 1115

**Default:** None

### Example

```
clr-disk-stats:loc=1113
```

### Dependencies

The specified card location must contain a card that is running an OAM (1113 or 1115).

A related command must not be in progress.

### Notes

None

### Output

```
clr-disk-stats:loc=1113

rlghncxa03w 01-03-01 14:14:05 EST Rel 28.1.0
Disk performance statistics cleared.
;
```

## copy-tbl

### Copy Table

Use this command to copy a single table from one source to another. A table can be copied to any verifiable location in the system; however, the source and destination tables must have identical configurations (same number of entries, same entry size, both 1- dimensional and 2-dimensional).

**NOTE: A table cannot be copied onto itself.**

**Keyword:** copy-tbl

**Related Commands:**

**Command Class:** Debug

### Parameters

**:dloc=** (mandatory)

Destination location. This parameter specifies the location of the destination table.

**Range:** 1101-1108, 1111-1112, 1201-1208, 1211-1218, 1301-1308, 1311-1318, 2101-2108, 2111-2118, 2201-2208, 2211-2218, 2301-2308, 2311-2318, 3101-3108, 3111-3118, 3201-3208, 3211-3218, 3301-3308, 3311-3318, 4101-4108, 4111-4118, 4201-4208, 4211-4218, 4301-4308, 4311-4318, 5101-5108, 5111-5118, 5201-5208, 5211-5218, 5301-5308, 5311-5318, 6101-6108, 6111-6118

1114—The TDM

1116—The TDM

1117—The removable cartridge drive

1113—The latched USB port

1115—The latched USB port

**:sloc=** (mandatory)

Source location. This parameter specifies the location of the source table.

**Range:** 1101-1108, 1111-1112, 1201-1208, 1211-1218, 1301-1308, 1311-1318, 2101-2108, 2111-2118, 2201-2208, 2211-2218, 2301-2308, 2311-2318, 3101-3108, 3111-3118, 3201-3208, 3211-3218, 3301-3308, 3311-3318, 4101-4108, 4111-4118, 4201-4208, 4211-4218, 4301-4308, 4311-4318, 5101-5108, 5111-5118, 5201-5208, 5211-5218, 5301-5308, 5311-5318, 6101-6108, 6111-6118

1114—The TDM

1116—The TDM

1117—The removable cartridge drive

1113—The latched USB port

1115—The latched USB port

**:stbl=** (mandatory)

Source table. This parameter specifies the identifying number of the source table.

**Range:** 0-1023

**:ddrv=** (optional)

Destination drive. This parameter specifies the identification of the disk to which the table is copied.

**Range:** **fixed, remove, usb**

**fixed**— The fixed disk

**remove**— The removable cartridge or drive

**usb**— Argument to be used by Tekelec personnel only.

**Default:** **fixed**

**:dprtgrp=** (optional)

Disk partition group. This parameter specifies the disk partition group of the destination table.

**Range:** **active, inactive**

**Default:** **active**

**:dtbl=** (optional)

Destination table. This parameter specifies the identifying number of the destination table.

**Range:** 0-1023

**Default:** The **stbl** parameter value

**:sdrv=** (optional)

Source drive. This parameter specifies the identification of the disk from which the table is copied.

**Range:** **fixed, remove, usb**

**fixed**— The fixed disk



**remove** — The removable cartridge or drive  
**usb** — Argument to be used by Tekelec personnel only.

**Default:** **fixed**

**:sprtngrp=** (optional)

Source partition group. This parameter specifies the disk partition group of the source table.

**Range:** **active, inactive**

**Default:** **active**

### Example

```
copy-tbl:stbl=25:dtbl=24:sloc=1114:dloc=1116:sdrv=fixed
```

### Dependencies

Only one table copy command can be executed at a time.

The source and destination tables must exist and be compatible.

This command cannot be used to modify the security log.

The same value cannot be specified for the **sloc** and **dloc** or the **stbl** and **dtbl** parameters.

If a value of **fixed** is specified for the **sdrv** or **ddrv** parameter, then a value of **1114** or **1116** must be specified for the **sloc** or **dloc** parameter, respectively.

### Notes

None

### Output

```
copy-tbl:stbl=25:dtbl=24:sloc=1114:dloc=1116:sdrv=fixed
```

```
rlghncxa03w 01-03-04 16:11:53 EST Rel 28.1.0
Table copy command complete.
;
```

## dbg-ddb

## Debug Dynamic Database

Use this command to display the checksum, statistics, and wild write audit (WWA) updates of dynamic database (DDB) table entries, audit a specific table, and reset the DDB statistics on the cards.

**Keyword:** **dbg-ddb**

**Related Commands:** **rept-stat-ddb**

**Command Class:** Debug

### Parameters

**:action=** (mandatory)

This parameter specifies the action taken by the **dbg-ddb** command.

**Range:** **stats, aud, disp, wwa, rststat**

**stats** — display dynamic database statistics

**aud** — audit a specific table

**disp** — display a table entry

**wwa** — display any entries updated by WWA task

**rststat** — reset following DDB audit statistics:

- Number of DDB updates
- Number of consecutive DDB update in progress
- Maximum DDB updates in 100 msec

- Idle period
- Maximum and minimum idle period

**:audtype=** (optional)

Audit type. This parameter specifies whether a unicast or multicast audit is performed.

**Range:**     **mc, uc**  
                   **mc** — multicast  
                   **uc** — unicast

**Default:**   **mc**

**:dpc=** (optional)

This parameter specifies the destination point code value.

The Route table entry corresponding to the **dpc** value is displayed.

**Range:**     **p-, 000-255, \***  
 Specify a valid value for each subfield of the point code, and separate the subfields with a dash (-).

*prefix*—**p-**

The asterisk value (\*) is not valid for the *ni* subfield.

When **chg-sid:pctype=ansi** is specified, *ni* = **000** is not valid.

When **chg-sid:pctype=ansi** is specified, *nc* = **000** is not valid if *ni* = **001-005**.

When **chg-sid:pctype=ansi** is specified, *nc* = **000** is valid if *ni* = **006-255**.

The point code **000-000-000** is not a valid point code.

**:dpc/dpca/dpci/dpcn/dpcn24=** (optional)**:dpci=** (optional)

ITU international destination point code with subfields *zone-area-id*. The prefix subfield indicates a spare point code, private point code, or private and spare point code (*prefix-zone-area-id*).

**Range:**     **s-, p-, ps-, 0-255, none**  
 Specify a valid value for each subfield of the point code, and separate the subfields with a dash (-).

*prefix*—**s-, p-, ps-**

*zone*—**0-7**

*area*—**000-255**

*id*—**0-7**

The point code **0-000-0** is not a valid point code.

Enter **none** to delete the point code.

**:dpcn=** (optional)

ITU national destination point code in the format of a 5-digit number (*nnnnn*); or 2, 3, or 4 numbers (*members*) separated by dashes (*m1-m2-m3-m4*) as defined by the **chg-stpopts:npcfmti** flexible point code option. A group code must be specified when the ITUDUPPC feature is turned on (*nnnnn-gc*, *m1-m2-m3-m4-gc*). The *prefix* subfield indicates a spare point code, private point code, or private and spare point code (*prefix-nnnnn*, *prefix-nnnnn-gc*, *prefix-m1-m2-m3-m4*, *prefix-m1-m2-m3-m4-gc*).

**Range:**     **s-, p-, ps-, 0-16383, aa-zz**

Specify a valid value for each subfield of the point code, and separate the subfields with a dash (-).

*prefix*—**s-, p-, ps-**

*nnnnn*—**0-16383**

*gc*—**aa-zz**

*m1-m2-m3-m4*—**0-14** for each member; values must sum to 14

**:dpcn24=** (optional)

24-bit ITU national destination point code with subfields *main signaling area-sub signaling area-signaling point (msa-ssa-sp)*. The *prefix* subfield indicates a private point code (*prefix-msa-ssa-sp*).

**Range:** **p-**, **000-255**

Specify a valid value for each subfield of the point code, and separate the subfields with a dash (-).

*prefix*—**p-**

*msa*—**000-255**

*ssa*—**000-255**

*sp*—**000-255**

**Default:** No change to current value.

**:link=** (optional)

This parameter displays the entry in the Link table that corresponds to the specified link value.

**Range:** **a, b, a1, b1, a2, b2, a3, b3, a4, b4, a5, b5, a6, b6, a7, b7, a8, b8, a9, b9, a10, b10, a11, b11, a12, b12, a13, b13, a14, b14, a15, b15, a16, b16, a17, b17, a18, b18, a19, b19, a20, b20, a21, b21, a22, b22, a23, b23, a24, b24, a25, b25, a26, b26, a27, b27, a28, b28, a29, b29, a30, b30, a31, b31**

**:loc=** (optional)

This parameter specifies the location of the MTP card that is being debugged.

**Range:** **1101-1108, 1111-1112, 1201-1208, 1211-1218, 1301-1308, 1311-1318, 2101-2108, 2111-2118, 2201-2208, 2211-2218, 2301-2308, 2311-2318, 3101-3108, 3111-3118, 3201-3208, 3211-3218, 3301-3308, 3311-3318, 4101-4108, 4111-4118, 4201-4208, 4211-4218, 4301-4308, 4311-4318, 5101-5108, 5111-5118, 5201-5208, 5211-5218, 5301-5308, 5311-5318, 6101-6108, 6111-6118**

**:lsn=** (optional)

Linkset name. This parameter displays the entry in the Linkset table that corresponds to the specified linkset name.

**Range:** *ayyyyyyyy*

**:rloc=** (optional)

Reference card location. This parameter audits the table where the reference card is located.

**Range:** **1101-1108, 1111-1112, 1201-1208, 1211-1218, 1301-1308, 1311-1318, 2101-2108, 2111-2118, 2201-2208, 2211-2218, 2301-2308, 2311-2318, 3101-3108, 3111-3118, 3201-3208, 3211-3218, 3301-3308, 3311-3318, 4101-4108, 4111-4118, 4201-4208, 4211-4218, 4301-4308, 4311-4318, 5101-5108, 5111-5118, 5201-5208, 5211-5218, 5301-5308, 5311-5318, 6101-6108, 6111-6118**

**:tbl=** (optional)

This parameter specifies the table that is used as the source of the audit data.

**Range:** **lnk, ls, rte**

**lnk**— Link table

**ls**— Linkset table

**rte**— Route table

**:tidx=** (optional)

Table index. This parameter displays the corresponding table entry.

**Range:** **0-16000**

**System****Default: 0****Example**

This command displays the 126th entry in the Link table.

```
dbg-ddb:loc=1105:tbl=lnk:action=disp:tidx=126
```

This command displays the entry in the Link table corresponding to link=a and rloc=1107.

```
dbg-ddb:loc=1105:tbl=lnk:action=disp:rloc=1107:link=a
```

This command audits the Link table in multicast mode.

```
dbg-ddb:loc=1105:tbl=lnk:action=aud:audtype=mc
```

This command audits the Link table in unicast mode.

```
dbg-ddb:loc=1105:tbl=lnk:action=aud:audtype=uc
```

This command audits the Link table at the card location 1105 using the reference card 1107.

```
dbg-ddb:loc=1105:tbl=lnk:action=aud:audtype=uc:rloc=1107
```

This command displays the statistics of a specified card.

```
dbg-ddb:loc=1201:action=stats
```

This command displays the WWA entries on a specified card.

```
dbg-ddb:action=wwa:loc=1201
```

This command resets the statistics of a specified card.

```
dbg-ddb:action=rststat:loc=2100
```

This command resets the statistics of all active MTP cards.

```
dbg-ddb:action=rststat
```

**Dependencies**

The **dpc**, **tidx**, **lsn**, and **rloc** parameters cannot be specified together in the command. The **dpc**, **tidx**, **lsn**, and **link** parameters cannot be specified together in the command. The **action=disp** and **tbl=rte** parameters must be specified before the **dpc** parameter can be specified. The **action=disp** and **tbl=ls** parameters must be specified before the **lsn** parameter can be specified. The **action=disp** and **tbl=lnk** parameters must be specified before the **link** parameter can be specified. The **action=disp** parameter must be specified before the **tidx** parameter can be specified. The **action=aud** parameter must be specified before the **audtype** parameter can be specified. The **action=disp** and **tbl=lnk** parameters or the **action=aud** and **audtype=uc** parameters must be specified before the **rloc** parameter can be specified. If the **action** parameter has a value of **wwa**, **stats**, or **rststat**, then the **loc** parameter is the only other parameter that can be specified.

If the **action=disp** and **tbl=lnk** parameters are specified, then the **rloc** and **link** parameters must be specified together in the command.

The card location specified by the **loc** or **rloc** parameter must be equipped.

The value specified for the **loc** or **rloc** parameter must indicate an MTP card.

The status of the card at the location specified by the **loc** or **rloc** parameter must be active.

The linkset specified by the **lsn** parameter must already exist in the Linkset table.

The link specified by the **link** parameter must already be equipped.

The value specified for the **dpc** parameter must already exist in the Route table.

The value specified for the **dpc** parameter must be a full point code, network point code, or a cluster point code.

Values of **1113 - 1118** cannot be specified for the **loc** or **rloc** parameters.

If the **action** parameter has a value of **disp**, **aud**, **stats**, or **wwa**, then the **loc** parameter must be specified. If the **action=aud** parameter and the **rloc** parameter are specified, then the **audtype** parameter must be specified. If the **action** parameter has a value of **disp** or **aud**, then the **tbl** parameter must be specified.

**Notes**

For a multicast audit, the card that receives the message sends the audit request to all other MTP cards simultaneously. For a unicast audit, the card that receives the message sends the audit request to another MTP card, which sends the request to next MTP card, etc. This process continues until the last MTP card in the system receives the request.

A maximum of the last 10 entries of WWA updates are displayed.

## Output

```

dbg-ddb:loc=1104:action=disp:tbl=ls:tidx=1
tekelecstp 09-10-15 12:37:37 EST EAGLE5 41.1.0
dbg-ddb:loc=1104:action=disp:tbl=ls:tidx=1
Command entered at terminal #4.
;
tekelecstp 09-10-15 12:37:37 EST EAGLE5 41.1.0
User Message sent to location 1104.
;
tekelecstp 09-10-15 12:37:37 EST EAGLE5 41.1.0
[SeqNo: 0] [1104] [Linkset:1] Chksum h'1624 at h'28e84a (138 bytes)
Assign:1 Avail:0 APC: 001-001-002 ITUNVar:0
;
dbg-ddb:loc=1104:action=disp:tbl=lnk:tidx=1
tekelecstp 09-10-15 12:37:37 GMT EAGLE5 41.1.0
dbg-ddb:loc=1104:action=disp:tbl=lnk:tidx=1
Command entered at terminal #4.
;
tekelecstp 09-10-15 12:37:37 GMT EAGLE5 41.1.0
User Message sent to location 1104.
;
tekelecstp 09-10-15 12:37:37 GMT EAGLE5 41.1.0
[SeqNo: 0] [1104] [Link:x1] Chksum h'da8d at h'2877ce (14 bytes)
PortId:h'1e6 (Card:1104 Link h'0)
Slc:0 Stat:h'2 LsId:h'0 Class:0
Status:Fail
;
dbg-ddb:loc=1104:action=aud:tbl=lnk:audtype=mc
tekelecstp 09-10-15 13:40:38 GMT EAGLE5 41.1.0
dbg-ddb:loc=1104:action=aud:tbl=lnk:audtype=mc
Command entered at terminal #4.
;
tekelecstp 09-10-15 13:40:38 GMT EAGLE5 41.1.0
User Message sent to location 1104.
;
tekelecstp 09-10-15 13:40:38 GMT EAGLE5 41.1.0
[1104] Bcast:Card->Sys (Tbl 0) MTPCards:h'2 Reply:h'2 Mismatch:h'0
;
dbg-ddb:loc=1104:action=aud:tbl=lnk:audtype=uc
tekelecstp 09-10-15 16:37:11 GMT EAGLE5 41.1.0
dbg-ddb:loc=1104:action=aud:tbl=lnk:audtype=uc
Command entered at terminal #4.
;
tekelecstp 09-10-15 16:37:11 GMT EAGLE5 41.1.0
User Message sent to location 1104.
;
tekelecstp 09-10-15 16:37:11 GMT EAGLE5 41.1.0
[1104]Card->System (Tbl:0) Successful System Audit Completed
;
dbg-ddb:action=wwa:loc=1301
tekelecstp 09-10-12 17:37:11 GMT EAGLE5 41.1.0
dbg-ddb:action=wwa:loc=1301
Command entered at terminal #10.
;

```

```

tekelecstp 09-10-12 17:37:11 GMT EAGLE5 41.1.0
User Message sent to location 1301.
;

tekelecstp 09-10-12 17:37:11 GMT EAGLE5 41.1.0
DDB WWA REPORT (LOC = 1301)
    WILD WRITE AUDIT UPDATED (1) ENTRIES:

        TIME STAMP          TABLE      ENTRY_IDX  ORIG CHKSUM  UPD CHKSUM
    1.  09-10-12 17:35:02:586  RTE              0          H'41880000  H'00000000
;

dbg-ddb:action=stats:loc=1201
tekelecstp 09-10-03 17:37:11 GMT EAGLE5 41.1.0
dbg-ddb:action=stats:loc=1201
Command entered at terminal #10.
;

tekelecstp 09-10-03 17:37:11 GMT EAGLE5 41.1.0
User Message sent to location 1201.
;

tekelecstp 09-10-03 17:37:11 GMT EAGLE5 41.1.0
DDB STATISTICS
LOC                                     : 1201
CARD STATUS          (DDL)              : [CROSSLOADED]
                                      (DDB)              : [INITIALIZED]
IN UPDATE STATUS    (DDB CHECKSUM)      : [FALSE]
                                      (TSRC)              : [IDLE]
SUCCESIVE TIMES CARD REPORTED (IN UPDATE) : 0
DDB UPDATES                                                 : 2000
MAXIMUM UPDATES PER 100ms                                  : 900
DDB IDLE PERIOD:                                          : 03:12:30:20:50
MAXIMUM IDLE PERIOD                                       : 02:12:30:20:50
MINIMUM IDLE PERIOD                                       : 01:04:40:10:80
NUMBER OF WWA UPDATED ENTRIES                          : 4
;

dbg-ddb:action=wwa:loc=1201
tekelecstp 09-10-21 17:37:11 GMT EAGLE5 41.1.0
dbg-ddb:action=wwa:loc=1201
Command entered at terminal #10.
;

tekelecstp 09-10-21 17:37:11 GMT EAGLE5 41.1.0
User Message sent to location 1201.
;

tekelecstp 09-10-21 17:37:11 GMT EAGLE5 41.1.0
DDB WWA REPORT (LOC = 1201)
    WILD WRITE AUDIT UPDATED (NO) ENTRIES:
;

```

**Legend**

- **WWA**—Wild Write Audit
- **DDB**—Dynamic Database
- **TIME STAMP**—Card time stamp when the checksum was detected and updated by wild write audit. The time stamp is in *YY-MM-DD hh:mm:ss:msec* format.
- **TABLE**—Table where the checksum is being performed

- **ENTRY IDX**—Index of entry that is updated by wild write audit
- **ORIG CHKSUM**—Original Checksum
- **UPD CHKSUM**—Checksum after update by wild write audit
- **IDLE PERIOD**—The time elapsed, in milliseconds, since the last DDB update was received by this card. All idle periods are displayed in *dd:hh:mm:ss:msec* format.
- **NUMBER OF WWA UPDATED ENTRIES**—Number of entries updated by the WWA

## disp-bip

### Display Board Identification PROM

Use this command to display the Board Identification PROM (BIP) hex and ASCII data for the specified card type and location. The PROM data consists of the board ID, part number, revision, date of manufacture, power, serial number, software match ID, and check sums.

**Keyword:** **disp-bip**

**Related Commands:** **chg-bip-fld, chg-bip-rec, rtrv-bip, tst-bip**

**Command Class:** Debug

### Parameters

**:loc=** (mandatory)

The card location as stenciled on the shelf of the system.

**Range:** **1101-1112, 1201-1218, 1301-1318, 2101-2118, 2201-2218, 2301-2318, 3101-3118, 3201-3218, 3301-3318, 4101-4118, 4201-4218, 4301-4318, 5101-5118, 5201-5218, 5301-5318, 6101-6118**

**NOTE:** xy09 and xy10 locations are valid only if they are equipped with HIPR2 card.

**:dbdloc=** (optional)

Applique location. This parameter specifies the location of the applique.

This parameter is valid only with the cards that support multiple appliques.

**Range:** **1-2**

**:type=** (optional)

This parameter specifies the board type to be displayed.

**Range:** **mdb, dbd, both**

**mdb** — Displays the main assembly.

**dbd** — Displays the applique.

**both** — Displays the main assembly and the applique.

**Default:** **both**

### Example

The following example displays the BIP data for all appliques that are supported by the card.

```
disp-bip:loc=1105:type=dbd
```

The following example displays the BIP data for the second applique.

```
disp-bip:loc=1103:type=dbd:dbdloc=2
```

### Dependencies

The value of the **loc** parameter cannot specify the location of a fixed disk or removable cartridge.

The **type=dbd** parameter cannot be specified for card type GPSM-II, HCAP, ATM or DCM. HMUX and HIPR cards do not contain BIP information.

If the **type=mdb** parameter is specified, then the **dbdloc** parameter cannot be specified.



If the card at the location specified by the **loc** parameter does not support multiple appliques, then the **dbdloc** parameter cannot be specified,

## Output

The following example displays the BIP data for the main assembly.

### disp-bip:loc=1105:type=mbd

```
tekelecstp 12-12-30 20:24:41 IST EAGLE 37.0.0
Board Identification PROM Dump Location: 1105 - Motherboard Packet: 1
-----
0000 42 49 44 30 31 2c 50 4e 38 35 30 2d 30 31 34 35 BID01,PN850-0145
0010 2d 30 31 2e 31 41 42 2c 53 4d 45 47 2e 30 30 31 -01.1AB,SMEG.001
0020 2c 44 53 39 32 2e 31 30 2e 43 2e 32 31 30 30 31 ,DS92.10.C.21001
0030 38 32 2c 43 53 32 32 35 00 00 00 00 00 00 00 00 82,CS225.....
0040 00 00 00 00 00 00 00 00 00 00 00 00 00 00 00 .....
0050 00 00 00 00 00 00 00 00 00 00 00 00 00 00 00 .....
0060 00 00 00 00 00 00 00 00 00 00 00 00 00 00 00 .....
0070 00 00 00 00 00 00 00 00 00 00 00 00 00 00 00
```

;

The following example displays the BIP data for the second applique.

### disp-bip:loc=1104:type=dbd:dbdloc=2

```
tekelecstp 12-12-30 20:24:41 IST EAGLE 37.0.0
Board Identification PROM Dump Location: 1104 - DBD - 2 Packet: 1
-----
0000 42 49 44 30 31 2c 50 4e 38 35 30 2d 30 36 34 36 BID01,PN850-0646
0010 2d 30 32 2e 41 2c 53 4d 45 47 2e 30 30 31 2c 44 -02.A,SMEG.001,D
0020 53 32 30 30 36 2e 32 35 2e 43 2e 31 30 32 30 36 S2006.25.C.10206
0030 32 35 35 34 32 30 2c 43 53 31 36 33 00 42 42 54 255420,CS163.BBT
0040 30 31 2c 45 47 2e 30 30 36 2c 43 53 31 34 34 00 01,EG.006,CS144.
0050 00 00 00 00 00 00 00 00 00 00 00 00 00 00 00 .....
0060 00 00 00 00 00 00 00 00 00 00 00 00 00 00 00 .....
0070 00 00 00 00 00 00 00 00 00 00 00 00 00 00 00
```

;

The following example displays the BIP data for all appliques that are supported by the card.

### disp-bip:loc=1102:type=dbd

```
tekelecstp 12-12-30 20:24:41 IST EAGLE 37.0.0
Board Identification PROM Dump Location: 1102 - DBD - 1 Packet: 1
-----
0000 42 49 44 30 31 2c 50 4e 38 37 30 2d 32 32 31 32 BID01,PN870-2212
0010 2d 30 32 2e 41 2c 53 4d 45 47 2e 30 30 31 2c 44 -02.A,SMEG.001,D
0020 53 32 30 30 36 2e 32 35 2e 43 2e 31 30 32 30 36 S2006.25.C.10206
0030 32 35 35 34 36 31 2c 43 53 31 37 35 00 42 42 54 255461,CS175.BBT
0040 30 31 2c 45 47 2e 30 30 32 2c 43 53 31 34 30 00 01,EG.002,CS140.
0050 00 00 00 00 00 00 00 00 00 00 00 00 00 00 00 .....
0060 00 00 00 00 00 00 00 00 00 00 00 00 00 00 00 .....
0070 00 00 00 00 00 00 00 00 00 00 00 00 10 3d 0f .....=.
```

;

```
tekelecstp 12-12-30 20:24:41 IST EAGLE 37.0.0
Board Identification PROM Dump Location: 1102 - DBD - 2 Packet: 1
-----
0000 42 49 44 30 31 2c 50 4e 38 37 30 2d 32 32 31 32 BID01,PN870-2212
0010 2d 30 32 2e 41 2c 53 4d 45 47 2e 30 30 31 2c 44 -02.A,SMEG.001,D
0020 53 32 30 30 36 2e 32 35 2e 43 2e 31 30 32 30 36 S2006.25.C.10206
0030 32 35 35 34 36 31 2c 43 53 31 37 35 00 42 42 54 255461,CS175.BBT
0040 30 31 2c 45 47 2e 30 30 32 2c 43 53 31 34 30 00 01,EG.002,CS140.
0050 00 00 00 00 00 00 00 00 00 00 00 00 00 00 00 .....
0060 00 00 00 00 00 00 00 00 00 00 00 00 00 00 00 .....
0070 00 00 00 00 00 00 00 00 00 00 00 00 10 3d 0f .....=.
```

;

**disp-bp****Display Breakpoint**

Use this command to display currently active breakpoints in the communication and application processors.

**Keyword:** `disp-bp`

**Related Commands:** `dlt-bp`, `ent-bp`

**Command Class:** Debug

**Parameters**

**:card=** (optional)

This parameter specifies the card location, in the form of *GPLID-Subsystem ID*.

**Range:** *GPLID-Subsystem ID*

*GPLID*—`atmansi`, `atmitu`, `atmhc`, `bpdcn`, `bpdcn2`, `bphcap`, `bphcapt`, `bpmpl`, `bpmplt`, `eoam`, `eroute`, `erthc`, `gls`, `hipr`, `hipr2`, `ipghc`, `ipgwi`, `iplhc`, `iplim`, `iplimi`, `ips`, `ipsg`, `ipshc`, `mcp`, `pktgen`, `sccphc`, `slanhc`, `ss7epm`, `ss7hc`, `ss7ipgw`, `ss7ml`, `utility`, `vsccp`, `vxutil`, `vxwslan`

*Subsystem ID*—`a`, `b`, `act`, `stby`, `all`

The `oam` GPL can be specified with any of the subsystem IDs. For all other GPLs, only the `all` subsystem ID is valid.

**:imt=** (optional)

This parameter specifies the IMT address of the card.

**Range:** `0-255`

**:loc=** (optional)

Location. This parameter specifies the card location as stenciled on the shelf of the system.

**Range:** `1101-1113`, `1201-1218`, `1301-1318`, `2101-2118`, `2201-2218`, `2301-2318`, `3101-3118`, `3111-3118`, `3201-3218`, `3301-3318`, `4101-4118`, `4201-4218`, `4301-4318`, `5101-5118`, `5201-5218`, `5301-5318`, `6101-6118`, `1115`

The command is not valid for HMUX cards in locations `xy 09` and `xy 10` (`x` = the frame, `y` = the shelf).

**:proc=** (optional)

This parameter specifies the processor type.

**Range:** `appl`, `com`

`appl`— Application processor

`com`— Communication processor

**Default:** `appl`

**:ueng=** (optional)

This parameter specifies the microengine number.

This parameter is valid only on IXP-based cards. If this parameter is not specified, the card processor type is assumed to be ARM.

**Range:** `0-5`

**Example**

```
disp-bp:card=atmansi-all
```

```
disp-bp:loc=1214
```

```
disp-bp:loc=1109
```

```
disp-bp:loc=1109:ueng=3
```

### Dependencies

The **loc**, **imt**, or **card** parameter must be specified.

Only one of the **loc**, **imt**, and **card** parameters can be specified in the command.

The **imt** parameter allows this command to be entered for a card that has not been configured in the system.

The **ueng** parameter can be specified only for IXP-based cards.

The **eoam** GPLID accepts all subsystem values; all other GPLIDs accept only the **all** subsystem value.

The card location specified by the **loc** parameter must be in the database.

Card locations **1114**, **1116**, **1117**, **1118**, and the HMUX locations (xy **09** and xy **10** where x is the frame and y is the shelf) (**loc** parameter) are not valid for break point commands. Or, the GPL specified in the **card** parameter is not supported.

### Notes

Card locations (**loc** parameter) xy09 and xy10 (x is the frame and y is the shelf) for HMUX cards are not valid for break point commands.

**Output**

The following examples are for x86-based cards:

**disp-bp:card=ss7ansi-all**

```
rlghncxa03w 01-03-22 21:14:58 EST EAGLE5 31.3.0
SDS Installed Breakpoint Report from IMT Address H'00f4
Brkpoint-Addr Memory-Dump-Addr Condition-1 Condition-2 Repeat-Count
-----
H'003a-H'0001 ANY ANY 0
```

```
rlghncxa03w 01-03-22 21:14:58 EST EAGLE5 31.3.0
SDS Installed Breakpoint Report from IMT Address H'000a
BP Address Memory-Dump Address Conditions Rpt Ct Ind
-----
H'0000a974 H'000c030c 1- ANY 3 1
Code Breakpoint 2- ANY
H'0000a975 1- ANY PERM 0
Data Write - WORD 2- ANY
H'0000a976 1- ANY 15 0
Any Access - DWORD 2- ANY
H'0000a977 1- ANY PERM 0
Data Read - BYTE 2- ANY
```

```
rlghncxa03w 01-03-22 21:14:58 EST EAGLE5 31.3.0
80386/80486 Debug Registers in Use: DR0 DR2 DR3
;
```

**disp-bp:card=vsccp-all:**

```
rlghncxa03w 01-03-22 21:14:58 EST EAGLE5 31.3.0
SDS Installed Breakpoint Report from IMT Address H'0005
BP Address Memory-Dump Address Conditions Rpt Ct Ind
-----
H'0000a974 1- ANY 1 0
Code Breakpoint 2- ANY
;
```

The following output examples are for IXP-based cards.

**disp-bp:loc=1109**

```
tekelecstp 05-01-10 13:58:45 GMT EAGLE5 33.0.0
SDS Installed Breakpoint Report from IMT Address H'00ff
BP Address Memory-Dump Address Conditions Rep Ind CPU
-----
H'000401000 R11+H'0000ffff 1- R15 > H'ffffffff 2 0 ARM
Any Access - 2- R0 <= H'0000ffff
Data value: H'00000000 Data Mask: H'ffffffff
```

**disp-bp:loc=1109:ueng=3**

```
tekelecstp 05-01-10 13:58:45 GMT EAGLE 33.0.0
SDS Installed Breakpoint Report from IMT Address H'00ff
BP Address Memory-Dump Address Conditions Rep Ind CPU
-----
H'00235000 H'00020044 1- ANY PERM 1 UENG 3
CODESW Breakpoint 2- ANY CTX 2
;
```

**disp-disk-dir****Display Disk Directory**

Use this command to display the DOS directory on the specified disk. This command can display the creation date for each file or for selected files and applies to fixed disks and removable cartridges or drives.

**NOTE:** This command can be used to verify that the correct version of a file is on the disk.

**Keyword:** disp-disk-dir

**Related Commands:** act-gpl, chg-db, chg-gpl, copy-gpl, copy-meas, init-sys, rept-stat-db

**Command Class:** Debug

## Parameters

**:file=** (optional)

This parameter specifies the name of the file to be displayed.

**Range:**       zzzzzzzzzzzz  
                  1–12 ASCII characters

**Default:**     All files are displayed

**:loc=** (optional)

This parameter specifies the card location in the system.

**Range:**     **1114 , 1116, 1117, 1113, 1115**  
              **1114** — The TDM  
              **1116** — The TDM  
              **1117** — The removable cartridge drive  
              **1113** — The latched USB port  
              **1115** — The latched USB port

**:prtnggrp=** (optional)

Partition group. This parameter specifies the disk partition group to be displayed.

**Range:**     **active, inactive**  
**Default:**   **active**

**:src=** (optional)

Source. This parameter specifies the identification of the disk containing the files to be displayed.

**Range:**     **fixed, remove, usb**  
              **fixed** — The fixed disk  
              **remove** — The removable cartridge or drive  
              **usb** — The credit card drive  
**Default:**   The fixed disk

## Example

```
disp-disk-dir:loc=1117:file="dms.cfg"
disp-disk-dir:src=remove:file="fta"
disp-disk-dir:src=remove:file="*.*"
```

## Dependencies

Valid filenames must be in the format, *filename.extension*, with the following requirements:

File name—1–8 ASCII Characters  
Extension—0–3 ASCII Characters

Wildcards (asterisks) are allowed when the wildcard pattern is enclosed in parentheses.

\*—Matches all characters in either filename or extension  
?—Matches one character in either filename or extension  
file="\*.\*"—Matches all files on disk  
file="\*.tbl"—Matches all files on disk with **.tbl** as a extension

An E5-MCAP card must be installed before the **src=usb** parameter can be specified.

The **src** parameter must be specified.

The **1117** location is used by MDAL cards. The **1113** and **1115** locations are used by E5-MCAP cards. The **1114** and **1116** locations are used by TDM or E5-TDM cards.

A removable cartridge or drive must be inserted in the slot indicated by the value specified for the **loc** or **src** parameter.

The card specified by the **loc** parameter must be connected to at least one IMT bus.

**Notes**

None

## Output

**disp-disk-dir**

```
lnpstp 01-03-30 15:52:04 EST Rel 28.1.0
DISP-DISK-DIR, Loc=1116, Device = FIXED, Dir = :\  

Filename Ext          Length Last Modified      Cluster      LBA  

DMS      CFG          16384 00-08-01 18:45      2            573  

:
```

```
File(s) : 175  Bytes : 457956761  

Volume : FIXED DISK  

Bytes free : 73654887  

Disk Size (MB) : 2014  

;
```

**disp-disk-dir:loc=1117**

```
lnpstp 01-03-30 15:52:46 EST Rel 28.1.0  

disk-disk-dir:loc=1117:file="dms1024.cfg"  

DISP-DISK-DIR, Loc=1117, Device = REMOVE, Dir = :\  

Filename Ext          Length Last Modified      Cluster      LBA  

DMS1024  CFG          16384 00-08-01 15:48      2            339  

:
```

```
File(s) : 72  Bytes : 192883124  

Volume : SYSTEM DISK  

Bytes free : 956339788  

Disk Size (MB) : 1096  

;
```

**disp-disk-dir:file=ttserv.tbl**

```
lnpstp 01-03-30 15:53:09 EST Rel 28.1.0  

DISP-DISK-DIR, Loc=1116, Device = FIXED, Dir = :\  

Filename Ext          Length Last Modified      Cluster      LBA  

TTSERV   TBL          8192 00-08-01 18:45      2731         44237
```

```
File(s) : 1  Bytes : 8192  

Volume : FIXED DISK  

Bytes free : 73654887  

Disk Size (MB): 2014  

;
```

**disp-disk-dir:loc=1116**

```
eaglestp 05-03-30 15:53:09 EST TTTT PPP EAGLE5 34.0.0  

DISP-DISK-DIR, Loc=1116, Device = FIXED, Dir = :\  

Filename Ext          Length Last Modified      Cluster      LBA  

DMS      CFG          16384 08-07-97 11:00      2            573  

OAM      ELF          3145728 08-07-97 11:00      4            605  

TOAM     ELF          3145728 08-07-97 11:00     388          6749  

SS7      ELF          1048576 08-07-97 11:00     772          12893  

TSS7     ELF          1048576 08-07-97 11:00     900          14941  

GX25     ELF          1048576 08-07-97 11:00    1028         16989  

TGX25    ELF          1048576 08-07-97 11:00    1156         19037  

CCS7ITU  ELF          1048576 08-07-97 11:00    1284         21085  

.  

.  

.  

LNP_LRN  BKP          3072096 08-07-97 11:00    38963        623949  

LNP_MR   BKP          1679392 08-07-97 11:00    39339        629965  

LNP_NPA  BKP          5120096 08-07-97 11:00    39545        633261  

LNP_4DIG BKP         12800064 08-07-97 11:00    40171        643277  

ACG_MIC  BKP          187712 08-07-97 11:00    55797        893293  

LNP_CHK  BKP          197378 08-07-97 11:00    55820        893661
```

```

LNP_DBMM  BKP          801600  08-07-97 11:00          55845          894061
TRBLTX    BKP          63980   08-07-97 11:00          55943          895629
MTT       BKP          384000  08-07-97 11:00          55951          895757
2201800   REL           2048    08-07-97 11:00          55998          896509

```

```

File(s) : 175  Bytes : 457956761
Volume : FIXED DISK
Bytes free : 73654887
Disk Size (MB) : 507
Largest Free Space : 73654887

```

;

The following example displays the output when an E5-MCAP card is used.

**disp-disk-dir:loc=1113:src=remove**

```

e5oam 09-01-20 22:24:12 EST  EAGLE 40.1.0
DISP-DISK-DIR  Loc=1113  Dev = REMOVE
Filename  Ext          Length
DMS1024   CFG          32768
TATMANSI  ELF          3145728
TATMHC    ELF          5242880
TATMITU   ELF          3145728
TBLBEPM   ELF          3145728
TBLBIOS   ELF          3145728
TBLBSMG   ELF          3145728
TBLCPLD   ELF          3145728
TBLDIAG   ELF          3145728
TBLDIAG6  ELF          3145728
...

SMEAS_ST  SYS           12228
UIMLOG    SYS        11263947
SYSREL    SYS           949
MTT       BKP          384000
TRBLTX    BKP          96000
FEATCTRL  BKP          128000
ASSYPWR   BKP           8016
TS30100   REL           5120
BLMCAP    TAR        13721600
File(s) : 178  Bytes : 437596655  Disk Size (MB) : 1972;

```

**Legend**

**FILENAME**—The name of the file in the directory

**EXT**—The extension of the file name (for example, for the file MFC.BIN, MFC is the file name and BIN is the extension of the file name).

**LENGTH**—The amount of space, in bytes, the file occupies on the disk.

**LAST MODIFIED**—The data and time the file was changed.

**CLUSTER**—A 2-byte, 16-digit binary number that represents the first section of the disk occupied by the file.

**LBA**—The starting logical block address that corresponds to the **CLUSTER**.

**FILE(S)**—The number of files on the disk that match the search criteria.

**BYTES**—The amount of space, in bytes, the displayed files occupy on the disk

**VOLUME**—An 11-character name for the disk.

**BYTES FREE**—The number of bytes that are available on the disk for file storage.

**DISK SIZE**—The total capacity of the specified disk.



## disp-disk-stats

### Display Disk Performance Statistics

Use this command to display the disk performance statistics.

**NOTE: The OAMs maintain disk read/writer access times as well as per table and per application statistics on the number of disk accesses and cache accesses. Per application and per table statistics that have zero values are not displayed if an application ID or table ID is not specified; only nonzero statistics are displayed in the default report.**

**Keyword:** disp-disk-stats

**Related Commands:** clr-disk-stats

**Command Class:** Debug

#### Parameters

**:loc=** (mandatory)

Location. This parameter specifies the card location in the system.

**Range:** 1113, 1115

**:applid=** (optional)

Application ID. This parameter specifies the application IDs that are used to define tasks.

**Range:** 0-255

**Default:** all

**:tblid=** (optional)

Table ID. This parameter specifies the table IDs that are used to define tables.

**Range:** 0-511

**Default:** all

#### Example

```
disp-disk-stats:loc=1113:applid=29
```

```
disp-disk-stats:loc=1113:applid=93
```

```
disp-disk-stats:loc=1113
```

#### Dependencies

The specified card location must contain a card that is running an OAM (1113 or 1115).

GPSM-II and E5-MCAP cards cannot co-exist in the system.

#### Notes

None

## Output

**disp-disk-stats:loc=1113:applid=29**

rlghncxa03w 01-03-01 14:14:05 EST Rel 28.1.0

Disk Performance Statistics Report:

| Appl Id | Cache Read Hits | Disk Read Accesses | Cache Write Hits | Disk Write Accesses |
|---------|-----------------|--------------------|------------------|---------------------|
| 29      | 113             | 23                 | 25               | 40                  |

Command Completed.

**disp-disk-stats:loc=1113:applid=93**

tekelecstp 01-06-01 14:14:05 EST Rel 28.1.0

Disk Performance Statistics Report:

| Appl Id | Cache Read Hits | Disk Read Accesses | Cache Write Hits | Disk Write Accesses |
|---------|-----------------|--------------------|------------------|---------------------|
| 93      | 0               | 0                  | 0                | 0                   |

Command Completed.

;

**disp-disk-stat:loc=1113**

rlghncxa03w 01-03-01 14:14:05 EST Rel 28.1.0

Disk Performance Statistics Report:

| Appl Id | Cache Read Hits | Disk Read Accesses | Cache Write Hits | Disk Write Accesses |
|---------|-----------------|--------------------|------------------|---------------------|
| 29      | 113             | 23                 | 25               | 40                  |
| 120     | 12              | 223                | 225              | 361                 |

| Table Id | Cache Read Hits | Disk Read Accesses | Cache Write Hits | Disk Write Accesses |
|----------|-----------------|--------------------|------------------|---------------------|
| 185      | 12              | 223                | 225              | 361                 |
| 201      | 113             | 23                 | 25               | 40                  |

| Total Cache Read Hits | Total Disk Reads | Total Cache Write Hits | Total Disk Writes |
|-----------------------|------------------|------------------------|-------------------|
| 125                   | 246              | 250                    | 401               |

| Disk Access Times (microseconds) |         |         |             |
|----------------------------------|---------|---------|-------------|
| Minimum                          | Maximum | Average | Access Type |
| 1260                             | 31121   | 6380    | Read        |
| 1215                             | 31090   | 6350    | Write       |

Command Completed.

;

**disp-lba****Display Logical Block Access**

Use this command to display the contents of a logical block of data at a specified logical block address of a fixed disk or removable cartridge.

**Keyword:** disp-lba  
**Related Commands:**  
**Command Class:** Debug

### Parameters

**:lba=** (mandatory)

This parameter specifies the logical block address.

**Range:** 0-1953125

**:loc=** (mandatory)

Location. This parameter specifies the card location in the system. A fixed disk or removable cartridge location must be specified.

**Range:** 1114, 1116, 1117

1114 — The standby TDM

1116 — The standby TDM

1117 — The removable cartridge

**Default:** Active fixed disk

### Example

```
disp-lba:lba=676:loc=1117
```

### Dependencies

The requested disk must be available.

The logical block address specified must be within the valid range for the disk specified.

If E5-MCAP, E5-MDAL, or E5-TDM cards are installed, then this command cannot be entered.

### Notes

None

## Output

**disp-lba:lba=676:loc=1117**

```

rlghncxa03w 01-03-02 16:21:12 EST Rel 28.1.0
0504 DISP-LBA DEVICE ID=H'0021, LBA=H'000002a4, LOC=1117
0000 ff 44 4d 53 2e 43 46 47 00 00 00 00 00 00 00 00 .DMS.CFG.....
0010 20 00 01 00 00 02 00 00 00 00 00 00 00 03 00 00 .....
0020 00 55 4e 55 53 45 44 54 41 42 4c 45 00 00 00 00 .UNUSEDTABLE....
0030 00 00 00 00 00 00 00 00 00 00 00 00 00 00 00 00 .....
0040 ff 64 62 73 74 61 74 2e 62 6b 70 00 00 00 02 00 .dbstat.bkp.....
0050 2e 00 01 00 01 00 00 00 00 00 00 00 01 00 00 00 .....
0060 ff 64 62 73 74 61 74 2e 74 62 6c 00 00 00 03 00 .dbstat.tbl.....
0070 2e 00 01 00 01 00 00 00 00 00 00 00 03 00 00 00 .....
0080 00 55 4e 55 53 45 44 54 41 42 4c 45 00 00 00 00 .UNUSEDTABLE....
0090 00 00 00 00 00 00 00 00 00 00 00 00 00 00 00 00 .....
00a0 ff 6d 63 66 67 2e 62 6b 70 00 00 00 00 05 00 .mcfg.bkp.....
00b0 9c 00 01 00 01 00 00 00 00 00 00 00 01 00 00 00 .....
00c0 ff 6d 63 66 67 2e 74 62 6c 00 00 00 00 06 00 .mcfg.tbl.....
00d0 9c 00 01 00 01 00 00 00 00 00 00 00 03 00 00 00 .....
00e0 ff 69 6d 74 61 2e 62 6b 70 00 00 00 00 07 00 .imta.bkp.....
00f0 28 00 01 00 00 01 00 00 00 00 00 00 01 00 00 00 (.
0100 ff 69 6d 74 61 2e 74 62 6c 00 00 00 00 08 00 .imta.tbl.....
0110 28 00 01 00 00 01 00 00 00 00 00 00 03 00 00 00 (.
0120 00 55 4e 55 53 45 44 54 41 42 4c 45 00 00 00 00 .UNUSEDTABLE....
0130 00 00 00 00 00 00 00 00 00 00 00 00 00 00 00 00 .....
0140 ff 6c 64 74 62 6c 2e 73 79 73 00 00 00 00 0a 00 .ldtbl.sys.....
0150 b8 00 01 00 14 00 00 00 00 00 00 00 03 00 00 00 .....
0160 ff 73 68 65 6c 66 2e 62 6b 70 00 00 00 00 0b 00 .shelf.bkp.....
0170 03 00 02 00 03 00 00 00 03 00 00 00 01 00 00 00 .....
0180 ff 73 68 65 6c 66 2e 74 62 6c 00 00 00 00 0c 00 .shelf.tbl.....
0190 03 00 02 00 03 00 00 00 03 00 00 00 03 00 00 00 .....
01a0 ff 6c 69 6e 6b 2e 62 6b 70 00 00 00 00 0d 00 .link.bkp.....
01b0 10 00 01 00 00 02 00 00 00 00 00 00 01 00 00 00 .....
01c0 ff 6c 69 6e 6b 2e 74 62 6c 00 00 00 00 0e 00 .link.tbl.....
01d0 10 00 01 00 00 02 00 00 00 00 00 00 03 00 00 00 .....
01e0 00 55 4e 55 53 45 44 54 41 42 4c 45 00 00 00 00 .UNUSEDTABLE....
01f0 00 00 00 00 00 00 00 00 00 00 00 00 00 00 00 00 .....
;

```

## disp-mem

## Display Memory

Use this command to display memory in communication and application processors. This display is in byte format.

**Keyword:** disp-mem

**Related Commands:** set-mem

**Command Class:** Debug

## Parameters

**:addr=** (optional)

This parameter specifies the address in the form of *segment-offset*.

**Range:** *segment-offset*  
*segment—h'00—h'ffff*  
*offset—h'00—h'ffff*

**:bc=** (optional)

Byte count. This parameter specifies the number of data bytes to display.

**Range:** 0-65535

**Default:** 96

**:card=** (optional)

Card location. This parameter specifies the card location in the form of *GPLID-Subsystem ID*.

**Range:** *GPLID-Subsystem ID*

*GPLID*—**atmansi, atmitu, atmhc, bpdcm, bpdcm2, bphcap, bphcapt, bpmpl, bpmplt, eoam, eroute, erthc, gls, hipr, hipr2, ipghc, ipgwi, iplhc, iplim, iplimi, ips, ipsg, ipshc, mcp, pktgen, sccphc, slanhc, ss7epm, ss7hc, ss7ipgw, ss7ml, utility, vsccp, vxutil, vxwslan**

*Subsystem ID*—**a, b, act, stby, all**

The **oam** GPL can be specified with any of the subsystem IDs.

For all other GPLs, only the **all** subsystem ID is valid.

**:dformat=** (optional)

This parameter specifies the memory dump format.

**Range:** **byte, word, dword**

**Default:** **byte**

**:imt=** (optional)

This parameter specifies the IMT address.

**Range:** **0-255**

**:loc=** (optional)

Location. This parameter specifies the card location as stenciled on the shelf of the system.

**Range:** **1101-1113, 1201-1218, 1301-1318, 2101-2118, 2201-2218, 2301-2318, 3101-3118, 3201-3218, 3301-3318, 4101-4118, 4201-4218, 4301-4318, 5101-5118, 5201-5218, 5301-5318, 6101-6118, 1115**

**:paddr=** (optional)

This parameter specifies the physical offset of the memory address.

**Range:** **h'00-h'ffffff**

**:proc=** (optional)

This parameter specifies the processor type.

**Range:** **appl, com**

**appl**— Application processor

**com**— Communication processor

**Default:** **appl**

**Example**

```
disp-mem:card=ss7ansi-all:addr=h'03a-h'001:bc=8
```

```
disp-mem:loc=1204:paddr=h'103abc:bc=8:dformat=word
```

```
disp-mem:loc=1204:paddr=h'103abc:bc=8:dformat=dword
```

**Dependencies**

Either the **loc**, **imt**, or **card** parameter must be specified.

Only one of the **loc**, **imt**, and **card** parameters can be specified in the command.

The **addr** and **paddr** parameters cannot be specified together in the command.

The value of the **bc** parameter cannot exceed **2000**.

The card location specified by the **loc** parameter must be in the database.

All of the subsystem values can be specified with the **oam** GPLID. The other GPLID values can be specified only with the **all** subsystem value.

Card locations **1114**, **1116**, **1117**, and **1118** are not valid for memory commands. The GPL specified in the **card** parameter is not supported.

### Notes

The **imt** parameter allows this command to be entered for a card that has not been configured in the system.

### Output

```

disp-mem:card=psm-a:addr=h'03a-h'001:bc=8
rlghncxa03w 01-03-22 21:13:50 EST Rel 28.1.0
SDS Memory Dump from IMT Address H'00f6
Source-Address = H'003a0001      Length = 8 bytes
0000 04 0d 3d 1c 04 0d 3d 1c      ..=...=.
;

disp-mem:loc=1204:paddr=h'103abc:bc=8:dformat=word
rlghncxa03w 01-03-22 21:13:50 EST Rel 28.1.0
SDS Memory Dump from IMT Address H'000a
Source-Address = H'00103abc      Length = 8 bytes
0000 ffff 00ff 00ff 0000      .....
;

disp-mem:loc=1204:paddr=h'103abc:bc=8:dformat=dword
rlghncxa03w 01-03-22 21:13:50 EST Rel 28.1.0
SDS Memory Dump from IMT Address H'000a
Source-Address = H'00103abc      Length = 8 bytes
0000 00ffffff 000000ff      .....
;

```

## disp-trace

## Display Trace

Use this command to display trace entries.

**Keyword:** disp-trace

**Related Commands:** dlt-trace, ent-trace

**Command Class:** Debug

### Parameters

**:traceid=** (optional)  
Trace ID. Identifier of the trace entry to be displayed.  
**Range:** 1-10

### Example

```

disp-trace
disp-trace:traceid=5

```

### Dependencies

None

### Output

```

disp-trace
stdcfg2b 07-10-05 12:55:32 EST EAGLE 37.5.0
Trace Request 1:
CARD=          SS7ANSI      OPC=          001-001-001
TRACE DISPLAY COMPLETE.
;

```

**dlt-bp****Delete Breakpoint**

Use this command to delete breakpoints in the communication or application processors.

**Keyword:** **dlt-bp**

**Related Commands:** **disp-bp, ent-bp**

**Command Class:** Debug

**Parameters**

**:addr=** (optional)

This parameter specifies the address in the form of *segment–offset*.

**Range:** *segment–offset*  
*segment—h'00–h'ffff*  
*offset—h'00–h'ffff*

**:card=** (optional)

Card location. This parameter specifies the card location in the form of *GPLID–Subsystem ID*.

**Range:** *GPLID–Subsystem ID*  
*GPLID—atmansi, atmitu, atmhc, bpdcm, bpdcm2, bphcap, bphcapt, bpmpl, bpmplt, eoam, eroute, erthc, gls, hipr, hipr2, ipghc, ipgwi, iplhc, iplim, iplimi, ips, ipsg, ipshc, mcp, pktgen, sccphc, slanhc, ss7epm, ss7hc, ss7ipgw, ss7ml, utility, vsccp, vxutil, vxwslan*  
*Subsystem ID—a, b, act, stby, all*

The **oam** GPL can be specified with any of the subsystem IDs. For all other GPLs, only the **all** subsystem ID is valid.

**:imt=** (optional)

This parameter specifies the IMT address of the card.

**Range:** **0-255**

**:loc=** (optional)

Location. This parameter specifies the card location as stenciled on the shelf of the system.

**Range:** **1101-1113, 1201-1218, 1301-1318, 2101-2118, 2201-2218, 2301-2318, 3101-3118, 3111-3118, 3201-3218, 3301-3318, 4101-4118, 4201-4218, 4301-4318, 5101-5118, 5201-5218, 5301-5318, 6101-6118, 1115**

The command is not valid for HMUX cards in locations *xy09* and *xy10* (*x* = the frame, *y* = the shelf).

**:paddr=** (optional)

This parameter specifies the physical offset of the memory address.

**Range:** **h'00–h'ffffff**

**:proc=** (optional)

This parameter specifies the processor type.

**Range:** **appl, com**  
**appl** — Application processor  
**com** — Communication processor

**Default:** **appl**

**:ueng=** (optional)

This parameter specifies the microengine number.

This parameter is valid only on IXP-based cards. If this parameter is not specified, the card processor type is assumed to be ARM.

**Range:** **0-5**

**Example**

```
dlt-bp:card=ss7gx25-all
dlt-bp:loc=1109
dlt-bp:loc=1209:ueng=2
dlt-bp:card=hipr-all
```

**Dependencies**

The **loc**, **imt**, or **card** parameter must be specified.

Only one of the **loc**, **imt**, and **card** parameters can be specified in the command.

Either the **addr** or **paddr** parameter, but not both, must be specified in the command.

The **ueng** parameter can be specified only for IXP-based cards.

The card location specified by the **loc** parameter must be in the database.

Card locations (**loc** parameter) **1114**, **1116**, **1117**, **1118**, and the HMUX locations (*xy* **09** and *xy* **10** where *x* is the frame and *y* is the shelf) are not valid for break point commands. Or, **gpl** (**card** parameter) is not supported.

All of the subsystem values can be specified with the **oam** GPLID. The other GPLID values can be specified only with the **all** subsystem value.

**Notes**

The **imt** parameter allows this command to be entered for a card that has not been configured in the system.

**Output**

```
dlt-bp:card=oam-all:proc=com
Command Accepted - Processing

tekelecstp 97-01-20 19:21:10 EST Rel 37.0.0
dlt-bp:card=oam-all:proc=com
Command entered at terminal #1.
;
```

**dlt-trace****Delete Trace**

Use this command to delete provisioned MSU tracing criteria from the database.

**Keyword:** **dlt-trace**

**Related Commands:** **disp-trace**, **ent-trace**

**Command Class:** Debug

**Parameters**

**:traceid=** (optional)  
Trace ID. Identifier of the trace entry to be deleted.  
**Range:** **1-10**

**Example**

```
dlt-trace:traceid=5
dlt-trace
```

**Dependencies**

None



**Output**

```

dlt-trace:traceid=1
stdcfg2b 07-10-05 13:03:29 EST EAGLE 37.5.0
dlt-trace:traceid=1
Command entered at terminal #4.

;

```

**ent-bp****Enter Breakpoint**

Use this command to add breakpoints in communications and application processors in the system.

**Keyword:** ent-bp

**Related Commands:** disp-bp, dlt-bp

**Command Class:** Debug

**Parameters**

**:access=** (optional)

This parameter specifies the access type, in the form of *access type-format*.

Use the **data** parameter to set the format on IXP-based cards.

**Range:** *access type-format*  
*access type*—**r, w, rw** (read, write, read-write)  
*format*—**byte, word, dword, any**

**Default:** For x86-based cards—**rw-byte**  
 For IXP-based cards—**rw-any**

**:addr=** (optional)

This parameter specifies the memory location in the form of *segment-offset*.

**Range:** *segment-offset*  
*segment*—**h'00-h'ffff**  
*offset*—**h'00-h'ffff**

**:bc=** (optional)

This parameter specifies the number of data bytes to display.

For IXP-based cards, **bc** represents the number of bytes of memory. The number of bytes of stack to be displayed will be 256 – **bc**. For example, if **bc=128**, 128 bytes of memory and 128 bytes of stack will be displayed. If **bc=0**, 0 bytes of memory and 256 bytes of stack will be displayed. The exception to this rule is that 1 byte of stack will never be displayed.

**Range:** **0-256**  
 For x86-based cards, the maximum number of bytes is **96**.  
 For IXP-based cards, the maximum number of bytes is **256**.

**:ca=** (optional)

This parameter specifies condition “a” in the form of *register-condition-integer*.

The value *register* is the CPU internal register.

The value *condition* is the comparison condition (equal, not equal, less than, greater than, greater than or equal, less than or equal).

The value *integer* is the value for comparison.

**Range:** *register-condition-integer*  
*register*—**sp, bp, ds, ss, es, cs, fl, ax, ah, al, bx, bh, bl, cx, ch, cl, dx, dh, dl, di, si, ip, fs, gs, esi, edi, ebp, esp, eip, efl, eax, ebx, ecx, edx, lr, pc, r1-r15**  
*condition*—**eq, neq, gt, lt, gte, lte**  
*integer*—**h'00-h'ffffff**

**:card=** (optional)

This parameter specifies the card location, in the form of *GPLID-Subsystem ID*.

**Range:** *GPLID-Subsystem ID*  
*GPLID*—**atmansi, atmitu, atmhc, bpdcm, bpdcm2, bphcap, bphcapt, bpmpl, bpmplt, eoam, eroute, erthc, gls, hipr, hipr2, ipghc, ipgwi, iplhc, iplim, iplimi, ips, ipsg, ipshc, mcp, pktgen, sccphc, slanhc, ss7epm, ss7hc, ss7ipgw, ss7ml, utility, vsccp, vxutil, vxwslan**  
*Subsystem ID*—**a, b, act, stby, all**

The **oam** GPL can be specified with any of the subsystem IDs.

For all other GPLs, only the **all** subsystem ID is valid.

**:cb=** (optional)

This parameter specifies condition “b” in the form of *register-condition-integer*.

The value *register* is the CPU internal register.

The value *condition* is the comparison condition (equal, not equal, less than, greater than, greater than or equal, less than or equal).

The value *integer* is the value for comparison.

**Range:** *register-condition-integer*  
*register*—**sp, bp, ds, ss, es, cs, fl, ax, ah, al, bx, bh, bl, cx, ch, cl, dx, dh, dl, di, si, ip, fs, gs, esi, edi, ebp, esp, eip, efl, eax, ebx, ecx, edx, lr, pc, r0-r15**  
*condition*—**eq, neq, gt, lt, gte, lte**  
*integer*—**h'00-h'ffffff**

**:ctx=** (optional)

This parameter specifies the bit-mapped microengine context mask.

**Range:** **1-15**

**:da=** (optional)

This parameter specifies the dump address, in the form of *segment-offset*.

**Range:** *segment-offset*  
*segment*—**h'00-h'ffff**  
*offset*—**h'00-h'ffff**

**:data=** (optional)

This parameter instructs a data breakpoint to qualify on a match of the data.

This parameter is valid only on IXP-based cards.

**Range:** *value-mask*  
*value*—**0-0xFFFFFFFF**  
*mask*—**0-0xFFFFFFFF**

**Default:** **0-0**

**:dformat=** (optional)

Memory dump format (byte, doubleword, word).

**Range:** byte, dword, word  
**Default:** byte

**:dpaddr=** (optional)

Memory dump address (physical offset).

**Range:** h'00–h'ffffff

**:dr=** (optional)

The data register indirect memory dump, in the form *register-register-integer*.

The *register-register* value is the CPU internal register.

The *integer* value is the offset value.

**Range:** *register-register-integer*

*register*—sp, bp, ss, ds, es, cs, fl, ax, ah, al, bx, bh, bl, cx, ch, cl, dx, dh, dl, di, si, ip, fs, gs, esi, edi, ebp, esp, eip, efl, eax, ebx, ecx, edx

*register*—sp, bp, ds, ss, es, cs, fl, ax, ah, al, bx, bh, bl, cx, ch, cl, dx, dh, dl, di, si, ip, fs, gs, esi, edi, ebp, esp, eip, efl, eax, ebx, ecx, edx

*integer*—h'00–h'ffffff

**:drarm=** (optional)

ARM register indirect memory dump.

**Range:** *ARM register-integer*

*ARM register*—r0-r15, sp, lr, pc

*mask*—0-65535

The value *ARM register* is the CPU internal register.

The value *integer* is the offset value.

The value *ARM register* is the CPU internal register.

The value *integer* is the offset value.

**Default:** 0-0

**:dur=** (optional)

Breakpoint duration.

**Range:** temp, perm

**Default:** temp

**:imt=** (optional)

IMT address of the card.

**Range:** 0-255

**:ind=** (optional)

Indirection count.

**Range:** 0-3

**Default:** 0

**:loc=** (optional)

The card location as stenciled on the shelf of the system.

**Range:** 1101-1113, 1115, 1201-1218, 1301-1318, 2101-2118, 2201-2218, 2301-2318, 3101-3118, 3201-3218, 3301-3318, 4101-4118, 4201-4218, 4301-4318, 5101-5118, 5201-5218, 5301-5318, 6101-6118

The command is not valid for HMUX cards in locations *xy09* and *xy10* (*x* = the frame, *y* = the shelf).

**:paddr=** (optional)

The physical offset of the memory address.

**Range:** h'00–h'ffffff

**:proc=** (optional)

Processor type.

**Range:** **appl, com**

**appl** — Application processor

**com** — Communication processor

**Default:** **appl**

**:rep=** (optional)

Repetitions for this breakpoint.

**Range:** **0-255**

**Default:** **0**

**:type=** (optional)

Breakpoint type in the form of processor type-breakpoint type

**Range:** *processor type-breakpoint type*

*processor type*—**p186, p286, p486, arm, ixp**

*breakpoint type*—**code, codehw, codesw, data**

**Default:** For x46-based cards—**p486-code**

For IXP-based cards—**arm-codesw**

**:ueng=** (optional)

Microengine number. This parameter is valid only on IXP-based cards. If this parameter is not specified, the card processor type is assumed to be ARM.

**Range:** **0-5**

### Example

```
ent-bp:loc=1113:addr=h'03a-0001
```

```
ent-bp:loc=1204:paddr=h'27c3c:type=p486-data:access=rw-word
```

```
ent-bp:loc=1109:paddr=h'401000:type=arm-codesw:access=rw-
any:ca=r7-eq-0
```

```
ent-bp:loc=1209:paddr=h'402000:type=arm-data:access=w-
any:data=h'1111-h'ff
```

```
ent-bp:loc=1309:paddr=h'403000:type=ixp-codesw:ueng=2:ctx=1
```

```
ent-bp:card=hipr-all:paddr=h'404000:type=arm-
codehw:drarm=r3-0:bc=64
```

### Dependencies

All of the subsystem values can be specified with the **oam** GPLID. The other GPLID values can be specified only with the **all** subsystem value.

Card locations (**loc** parameter) **1114**, **1116**, **1117**, and **1118** are not valid for break point commands. Or, the GPL specified in the **card** parameter is not supported.

The **loc** parameter, the **imt** parameter, or the **card** parameter must be specified.

Only one of the **loc**, **imt**, and **card** parameters can be specified in the command.

The **dr** parameter and the **da** parameter cannot be specified together in the command.

The **dur=perm** parameter and the **rep** parameter cannot be specified together in the command.

The **dur=perm** parameter cannot be specified when the value of the processor type portion of the **type** parameter is **p186** or **p286**.

Either the **addr** parameter or the **paddr** parameter, but not both, must be specified in the command.

When the **da** parameter, the **dr** parameter, or the **drarm** parameter is specified, the **dpaddr** parameter cannot be specified.

When the **paddr** parameter and the **bc** parameter are specified, either the **dpaddr** or **dr** parameter must be specified in the command.

The **access** parameter can be specified only when the **type** parameter value is **p486-data** or **arm-data**.

The **bc** parameter value cannot be greater than **96** for x86-based cards.

The **ind** parameter value cannot be greater than **3**.

The specified card must be in use.

For 80286 processors, registers for 80386 processors cannot be specified.

For 80286 processors, **integer** values for registers and conditions must be less than **65535**.

The **ueng** parameter is valid only on IXP-based cards (the value **ixp** is specified for the processor type portion of the **type** parameter).

The **cts** parameter is valid only on IXP-based cards (the value **ixp** is specified for the processor type portion of the **type** parameter).

The **data** parameter is valid only on IXP-based cards.

The **data** parameter is valid only when the value is **data** for the breakpoint type portion of the **type** parameter.

The register values **sp**, **lr**, **pc**, and **r0-r15** for the **ca**, **cb**, and **drarm** parameters are valid on an IXP-based card ARM processor.

The **ca** and **cb** parameters cannot be specified when the value **ixp** is specified for the processor type portion of the **type** parameter.

The **drarm** parameter can be specified only on IXP-based cards.

The **drarm** parameter can be specified only when the value **arm** is specified for the processor type portion of the **type** parameter.

The **dr** parameter cannot be specified for IXP-based cards.

The **data** and **codesw** values for the breakpoint type portion of the **type** parameter cannot be specified when the value **ixp** is specified for the processor type portion of the **type** parameter.

The **arm** and **ixp** values for the processor type portion of the **type** parameter are valid only on IXP-based cards.

The value **any** for the format portion of the **access** parameter can be specified only on IXP-based cards. The format value must be set to **any** on IXP-based cards.

When the value **ixp** is specified for the processor type portion of the **type** parameter, the **ueng** and **cts** parameters must be specified.

The **addr** parameter can be specified only when the **proc=com** parameter is specified for DS0 cards with PROM-based COM processors (such as TSMs).

When the **ca**, **cb**, and **dr** parameters are used with 80186 and 80286 processors, the register values **ip**, **fs**, **gs**, **esi**, **edi**, **ebp**, **esp**, **eip**, **epl**, **eax**, **ebx**, **ecx**, and **edx** cannot be specified. These registers can be used only with 80486 processors. The integer values for these parameters when used with 80186 and 80286 processors must be less than **h'ffff (65535)**.

The **data** value for the breakpoint type portion of the **type** parameter cannot be specified with the values **p186**, **p286**, and **ixp** for the processor type portion of the **type** parameter.

The **da** parameter cannot be specified for IXP-based cards.

An ARM register value must be specified for an IXP-based card with an ARM processor.

**Notes**

The **imt** parameter allows this command to be entered for a card that has not been configured in the system.

**Output**

```
ent-bp:loc=1113:addr=h'03a-0001
rlghncxa03w 04-08-22 21:14:41 EST EAGLE 33.0.0
SDS Response Code 22 from IMT Address H'00f6 - command complete.

rlghncxa03w 04-08-22 21:14:41 EST EAGLE 33.0.0
SDS Response from IMT Address H'000a - command complete.
;
```

**ent-trace****Enter Trace**

Use this debug command to trace MSUs sent to Service Module cards (DSM or E5-SM4G), or LIM cards running the **ss7ansi**, **ccs7itu**, **vsccp**, **atmitu**, **atmans**, **iplim**, **iplimi**, **ss7ipgw** or **ipgwi** applications.

The EAGLE 5 ISS traps MSUs that meet the provisioned tracing criteria, and the MSU remains in the trapped state for the life span of that MSU. The life span varies depending on the type of MSU. For MTP-Routed or GTT MSUs, the life span lasts until the MSU travels out of the EAGLE 5 ISS or is discarded. For LNP MSUs, the life span lasts until the request is processed. The response is not part of the LNP MSU. Trapping a response requires the provisioning of another MSU trace.

Table 6-3 lists by card type the parameters that can be used to filter an MSU.

**Table 6-3.** Parameter/Card Type Filters for MSUs

| An MSU for this card type...       | Can be filtered using one or more of the following parameters...                                                                               |
|------------------------------------|------------------------------------------------------------------------------------------------------------------------------------------------|
| Service Module                     | <b>error</b> , <b>gt</b> , <b>lrn</b> , <b>tn</b> , <b>ssp/sspa/sspi/sspn/sspn24</b> , <b>dn</b> , <b>entityid</b> , <b>imei</b> , <b>imsi</b> |
| LIM card running ANSI applications | <b>error</b> , <b>ssp/sspa</b> , <b>opc/opca</b> , <b>dpc/dpca</b> , <b>tlnpisuptype</b> , <b>gt</b>                                           |
| LIM card running ITU applications  | <b>error</b> , <b>sspi/sspn/sspn24</b> , <b>opci/opcn/opcn24</b> , <b>dpci/dpcn/dpcn24</b> , <b>gt</b>                                         |

The following parameters are mutually exclusive: **lrn**, **tn**, **dn**, **entityid**, **imsi**, **imei**, **error**.

The following parameters can be used once in a single MSU trace request with ONE of the mutually exclusive parameters specified above: **opc**, **dpc**, **ilsn**, **si**, **gt**, **ssp**, **h0h1**, **cpc**, **cic/ecic**.

The **cic/ecic** parameters can be used only for ISUP traffic. The **ecic** parameter must be specified with the **cic** parameter.

For all cards supported by the **ent-trace** command, the **error** parameter can be provisioned as the only optional parameter or in addition to any other optional parameter to trace any messages that fail verification or processing. If the **error** parameter not specified, the default value is **error=no**.



**CAUTION:** If the system configuration approaches the maximum number of provisioned Service Module cards (DSM and E5-SM4G cards), entering this command might cause an OAM to reset because of the amount of information that may be returned.

**Keyword:** ent-trace

**Related Commands:**

**Command Class:** Debug

### Parameters

**:card=** (mandatory)

This parameter specifies the card location in the form of *APPL CLASS-Subsystem ID*.

**Range:** *APPL CLASS-Subsystem ID*

*APPL CLASS—atmansi, atmitu, ccs7itu, iplim, iplimi, ss7ansi, ss7ipgw, ipgwi, vsccp*  
*Subsystem ID—all*

**:brief=** (optional)

This parameter specifies whether all information is provided for each MSU as it moves through the EAGLE 5 ISS.

**Range:** **no, yes**

**no** — All information, including data sections for the MSU, is displayed.  
**yes** — The data sections for the MSU are not displayed.

**:cic=** (optional)

This parameter specifies the beginning value for a CIC range.

**Range:** **0-16383**

**:cpc=** (optional)

ANSI destination point code with subfields *network indicator-network cluster-network cluster member (ni-nc-ncm)*.

**Synonym:** **cpc**

**Range:** **000-255**

Specify a valid value for each subfield of the point code, and separate the subfields with a dash (-).

When **chg-sid:pctype=ansi** is specified, *ni = 000* is not valid.

When **chg-sid:pctype=ansi** is specified, *nc = 000* is not valid if *ni = 001-005*.

When **chg-sid:pctype=ansi** is specified, *nc = 000* is valid if *ni = 006-255*.

The point code **000-000-000** is not a valid point code.

**:cpci=** (optional)

ITU international destination point code with subfields *zone-area-id*. The *prefix* subfield indicates a spare point code (*prefix-zone-area-id*).

**Range:** **0-255**

Specify a valid value for each subfield of the point code, and separate the subfields with a dash (-).

The point code **0-000-0** is not a valid point code.

*zone—0-7*

*area—000-255*

*id—0-7*

**:cpcn=** (optional)

ITU national destination point code in the format of a 5-digit number (*nnnnn*); or 2, 3, or 4 numbers (members) separated by dashes (*m1-m2-m3-m4*) as defined by the **chg-stpopts:npfnti** flexible point code option. A group code must be specified when the ITUDUPPC feature is turned on (*nnnnngc, m1-m2-m3-m4-gc*). The *prefix* subfield indicates a spare point code (*prefix-nnnnn, prefix-nnnnngc, prefix-m1-m2-m3-m4, prefix-m1-m2-m3-m4-gc*).

**Range:** **s-, 0-16383, aa-zz**

Specify a valid value for each subfield of the point code, and separate the subfields with a dash (-).

*prefix*—**s-**

*nnnnn*—**0-16383**

*gc*—**aa-zz**

*m1-m2-m3-m4*—**0-14** for each member; values must sum to 14

**:cpcn24=** (optional)

24-bit ITU national destination point code with subfields *main signaling area-sub signaling area-signaling point* (*msa-ssa-sp*).

**Range:** **000-255**

Specify a valid value for each subfield of the point code, and separate the subfields with a dash (-).

*msa*—**000-255**

*ssa*—**000-255**

*sp*—**000-255**

**:dn=** (optional)

Directory Number. The **dn** parameter is used for ATINP, G-Flex, G-Port, INP, PPSMS, and V-Flex. The **tn** parameter is used as the directory number for LNP.

**Range:** 5-15 digits

Valid digits are **0-9, a-f, A-F**

**:dpc=** (optional)

ANSI destination point code with subfields *network indicator-network cluster-network cluster member* (*ni-nc-nm*)

**Synonym:** **dpca**

**Range:** **000-255**

Specify a valid value for each subfield of the point code, and separate the subfields with a dash (-).

When **chg-sid:pctype=ansi** is specified, *ni* = **000** is not valid.

When **chg-sid:pctype=ansi** is specified, *nc* = **000** is not valid if *ni* = **001-005**.

When **chg-sid:pctype=ansi** is specified, *nc* = **000** is valid if *ni* = **006-255**.

The point code **000-000-000** is not a valid point code.

**:dpci=** (optional)

ITU international destination point code with subfields *zone-area-id*. The *prefix* subfield indicates a spare point code (*prefix-zone-area-id*).

**Range:** **s-, 0-255**

Specify a valid value for each subfield of the point code, and separate the subfields with a dash (-).

*prefix*—**s-**



*zone*—**0-7**

*area*—**000-255**

*id*—**0-7**

The point code **0-000-0** is not a valid point code.

**:dpcn=** (optional)

ITU national destination point code in the format of a 5-digit number (*nnnnn*); or 2, 3, or 4 numbers (members) separated by dashes (*m1-m2-m3-m4*) as defined by the **chg-stpopts:npcfnti** flexible point code option. A group code must be specified when the ITUDUPPC feature is turned on (*nnnnn-gc*, *m1-m2-m3-m4-gc*). The *prefix* subfield indicates a spare point code (*prefix-nnnnn*, *prefix-nnnnn-gc*, *prefix-m1-m2-m3-m4*, *prefix-m1-m2-m3-m4-gc*).

**Range:** **s-, 0-16383, aa-zz**

Specify a valid value for each subfield of the point code, and separate the subfields with a dash (-).

*prefix*—**s-**

*nnnnn*—**0-16383**

*gc*—**aa-zz**

*m1-m2-m3-m4*—**0-14** for each member; values must sum to 14

**:dpcn24=** (optional)

24-bit ITU national destination point code with subfields *main signaling area-sub signaling area-signaling point* (*msa-ssa-sp*).

**Range:** **000-255**

Specify a valid value for each subfield of the point code, and separate the subfields with a dash (-).

*msa*—**000-255**

*ssa*—**000-255**

*sp*—**000-255**

**:ecic=** (optional)

This parameter specifies the end value for a CIC range.

**Range:** **0-16383**

**:entityid=** (optional)

This parameter specifies the entity ID.

**Range:** 1-15 digits

1-15 digits; valid digits are **0-9, a-f, A-F**

**:error=** (optional)

This parameter specifies whether to perform a trace on any message verification error and message processing error

**Range:** **yes, no**

**Default:** **no**

**:gt=** (optional)

Global title. This parameter specifies the global title digits.

**Range:** 1-21 digits

Valid digits are **0-9, a-f, A-F**

**:h0h1=** (optional)

This parameter specifies a combination of values contained in some MSUs. The **h0** value is the code for a message group, and **h1** is the code for a message within that group.

**Range:** **0-255**

**:ilsn=** (optional)

This parameter specifies the incoming linkset name.

**Range:** *ayyyyyyyyy*  
1 alphabetic character followed by up to 9 alphanumeric characters.

**:imei=** (optional)

This parameter specifies the International Equipment Identifier.

**Range:** 14 digits  
Exactly 14 digits; valid digits are **0-9, a-f, A-F**.

**:imsi=** (optional)

This parameter specifies the International Mobile Station Identifier.

**Range:** 5-15 digits  
Valid digits are **0-9, a-f, A-F**.

**:loc=** (optional)

Location. This parameter specifies the card location of the card as stenciled on the shelf of the system.

**Range:** **1101-1108, 1111-1112, 1201-1208, 1211-1218, 1301-1308, 1311-1318, 2101-2108, 2111-2118, 2201-2208, 2211-2218, 2301-2308, 2311-2318, 3101-3108, 3111-3118, 3201-3208, 3211-3218, 3301-3308, 3311-3318, 4101-4108, 4111-4118, 4201-4208, 4211-4218, 4301-4308, 4311-4318, 5101-5108, 5111-5118, 5201-5208, 5211-5218, 5301-5308, 5311-5318, 6101-6108, 6111-6118**

**:lrn=** (optional)

The local routing number.

**Range:** *Exactly 14 digits*  
Valid digits are **0-9**.

**:mode=** (optional)

This parameter specifies the type of output that is displayed.

**Range:** **brief, default, detail, debug**  
**brief** — Abbreviated information is displayed when an MSU matches the request.  
**default** — The default value of this parameter.  
**detail** — Detailed information is displayed when an MSU matches the request.  
**debug** — Complete information is displayed when an MSU matches the request.

**:opc= or :opca=** (optional)

ANSI point code with subfields *network indicator-network cluster-network cluster member (ni-ncnm)*. The *prefix* subfield indicates a private point code (*prefix-ni-nc-ncm*).

**Range:** **000-255**  
Specify a valid value for each subfield of the point code, and separate the subfields with a dash (-).  
When **chg-sid:pctype=ansi** is specified, **ni = 000** is not valid.  
When **chg-sid:pctype=ansi** is specified, **nc = 000** is not valid if **ni = 001-005**.  
When **chg-sid:pctype=ansi** is specified, **nc = 000** is valid if **ni = 006-255**.  
The point code **000-000-000** is not a valid point code.

**:opci=** (optional)

ITU international origination point code with subfields *zone-area-id*. The *prefix subfield* indicates a spare point code, private point code, or private and spare point code (*prefix-zone-area-id*).

**Range:** **s-, p-, ps-, 0-255**

Specify a valid value for each subfield of the point code, and separate the subfields with a dash (-).

*prefix*—**s-, p-, ps-**

*zone*—**0-7**

*area*—**000-255**

*id*—**0-7**

The point code **0-000-0** is not a valid point code.

**:open=** (optional)

ITU national destination point code in the format of a 5-digit number (*nnnnn*); or 2, 3, or 4 numbers (members) separated by dashes (*m1-m2-m3-m4*) as defined by the **chg-stpopts:npfnti** flexible point code option. A group code must be specified when the ITUDUPPC feature is turned on (*nnnnngc, m1-m2-m3-m4-gc*). The *prefix* subfield indicates a spare point code (*prefix-nnnnn, prefix-nnnnngc, prefix-m1-m2-m3-m4, prefix-m1-m2-m3-m4-gc*).

**Range:** **s-, 0-16383, aa-zz**

Specify a valid value for each subfield of the point code, and separate the subfields with a dash (-).

*prefix*—**s-**

*nnnnn*—**0-16383**

*gc*—**aa-zz**

*m1-m2-m3-m4*—**0-14** for each member; values must sum to 14

**:open24=** (optional)

24-bit ITU national destination point code with subfields *main signaling area-sub signaling area-signaling point* (*msa-ssa-sp*).

**Range:** **000-255**

Specify a valid value for each subfield of the point code, and separate the subfields with a dash (-).

*msa*—**000-255**

*ssa*—**000-255**

*sp*—**000-255**

**:rep=** (optional)

The number of MSUs to trap.

**Range:** **0-255**

**:service=** (optional)

This parameter specifies the service that is offered by the EAGLE 5 ISS.

**Range:** **gflex, gport, inpmr, inpq, smsmr, mnpsms, eir, idpr, idps, tif, tif2, tif3, tobr, none**

**:si=** (optional)

Service indicator.

**Range:** **0-15**

**:sls=** (optional)

Signaling link selector.

**Range:** **0-255**

**:ssp= or :sspa=** (optional)

ANSI destination point code with subfields *network indicator-network cluster-network cluster member* (*ni-nc-ncm*).

**Range: 000-255**

Specify a valid value for each subfield of the point code, and separate the subfields with a dash (-).

When **chg-sid:pctype=ansi** is specified, *ni* = **000** is not valid.

When **chg-sid:pctype=ansi** is specified, *nc* = **000** is not valid if *ni* = **001-005**.

When **chg-sid:pctype=ansi** is specified, *nc* = **000** is valid if *ni* = **006-255**.

The point code **000-000-000** is not a valid point code.

**:sspi=** (optional)

ITU international destination point code with subfields *zone-area-id*. The *prefix* subfield indicates a spare point code (*prefix-zone-area-id*).

**Range: s-, 0-255**

Specify a valid value for each subfield of the point code, and separate the subfields with a dash (-).

*prefix*—**s-**

*zone*—**0-7**

*area*—**000-255**

*id*—**0-7**

The point code **0-000-0** is not a valid point code.

**:sspn=** (optional)

ITU national destination point code in the format of a 5-digit number (*nnnnn*); or 2, 3, or 4 numbers (members) separated by dashes (*m1-m2-m3-m4*) as defined by the **chg-stpopts:npfmtti** flexible point code option. A group code must be specified when the ITUDUPPC feature is turned on (*nnnnngc, m1-m2-m3-m4-gc*). The *prefix* subfield indicates a spare point code (*prefix-nnnnn, prefix-nnnnngc, prefix-m1-m2-m3-m4, prefix-m1-m2-m3-m4-gc*).

**Range: s-, 0-16383, aa-zz**

Specify a valid value for each subfield of the point code, and separate the subfields with a dash (-).

*prefix*—**s-**

*nnnnn*—**0-16383**

*gc*—**aa-zz**

*m1-m2-m3-m4*—**0-14** for each member; values must sum to 14

**:sspn24=** (optional)

24-bit ITU national destination point code with subfields *main signaling area-sub signaling area-signaling point* (*msa-ssa-sp*).

**Range: 000-255**

Specify a valid value for each subfield of the point code, and separate the subfields with a dash (-).

*msa*—**000-255**

*ssa*—**000-255**

*sp*—**000-255**

**:tlnpisuptype=** (optional)

The ISUP message type.

**Range: 0-255**

**:tn=** (optional)  
 The directory number.  
**Range:** 10 digits  
 Exactly 10 digits. Valid digits are **0-9**.

### Example

```
ent-trace:opc=1-1-1:card=SS7ANSI-ALL:rep=2
ent-trace:tlnpisuptype=01:card=SS7ANSI-ALL
ent-trace:dn=12345:card=VSCCP-ALL
ent-trace:imsi=c122d:card=VSCCP-ALL
ent-trace:card=ccs7itu-all:dpc=2-7-5:error=no
ent-trace:card=vsccp-all:error=yes
ent-trace:card=ccs7itu-
all:sspn24=10-11-12:opc24=10-10-10:dpc24=10-101-11
ent-trace:imei=123456789101234:card=VSCCP-ALL
ent-trace:entityid=c123:card=VSCCP-ALL
ent-trace:loc=1305:si=5:brief=yes
```

### Dependencies

The **card** parameter or the **loc** parameter must be specified.

At least one optional parameter must be specified. The **error** parameter can be specified as the only optional parameter or with any of the other optional parameters in the command.

The following parameters cannot have a value of **none**: **gt**, **entityid**, **dn**, **imei**, and **imsi**.

For the **card** parameter, only the following values are allowed: **vsccp**, **ss7ansi**, **atmitu**, **atmansi**, **iplim**, **iplimi**, **ss7ipgw**, or **ccs7itu**.

The only qualifier allowed for the **card** parameter is **-all**.

The following parameters are invalid for LIM cards running the **ss7ansi**, **atmansi**, **iplim**, or **ss7ipgw** GPLs: **gt**, **entityid**, **dn**, **imei**, **imsi**, **lrn**, and **tn**.

The following ITU point code parameters are invalid for LIM cards running the **ss7ansi**, **atmansi**, **iplim**, or **ss7ipgw** GPLs: **opci**, **open**, **open24**, **dpci**, **dpcn**, **dpcn24**, **sspi**, **sspn**, and **sspn24**.

The following parameters are invalid for LIM cards running the **atmitu** or **iplimi** GPLs: **gt**, **entityid**, **dn**, **imei**, **imsi**, **lrn**, **tn**, and **tlnpisuptype**.

The following ANSI point code parameters are invalid for LIM cards running the **iplimi** GPL: **opc**, **opca**, **dpc**, **dPCA**, **ssp**, and **sspa**.

The following parameters are invalid for Service Module cards running the **vsccp** application: **opc**, **dpc**, and **tlnpisuptype**.

The G-Flex feature or the Equipment Identity Register feature must be turned on before the **imsi** parameter can be specified.

If the ITU Duplicate Point Code (ITUDUPPC) feature is turned on, the ITU national point code must be specified as a full point code.

The Equipment Identity Register (EIR) feature must be turned on before the **imei** parameter can be specified.

The G-Flex, G-Port, INP, AINPQ, PPSMS, IDP Relay, or V-Flex feature must be turned on, or the ATINP feature must be enabled before the **dn** parameter can be specified. The G-Flex, G-Port, INP, or V-Flex feature must be turned on, or the ATINP, IDP Relay or any TIF feature must be enabled before the **entityid** parameter can be specified.

The **loc** and **card** parameters are mutually exclusive. Only one of the following parameters can be specified in a single MSU trace request: **lrn**, **tn**, **dn**, **entityid**, **imsi**, **imei**, or **error**.

A maximum of 10 traces can be entered in the system at a time.

Values **1113** - **1118** cannot be specified for the **loc** parameter. These values are not supported by the **ent-trace** command.

**Output**

The following example displays output for an MTP trace.

**ent-trace:loc=1101:dpc=7-1-0**

```
stdcfg1b 07-08-10 15:51:33 EST EAGLE 37.5.0
```

```
MSU TRACE H'00e1: Card=1101 RX - Link B0
```

```
Trace Condition:
```

```
LOC= 1101
```

```
DPC= 007-001-000
```

```
MSU info:
```

```
TOTAL MSU SIZE= 12 Bytes
```

```
MSU DATA SIZE = 4 Bytes
```

```
      0 1 2 3 4 5 6 7 8 9 0 1 2 3 4 5 6 7 8 9
MTP: 85 00 01 07 01 65 01 16
```

```
DATA: 00 00 09 00
```

```
TRACE OUTPUT COMPLETE.
```

```
;
```

```
stdcfg1b 07-08-10 15:51:33 EST EAGLE 37.5.0
```

```
MSU TRACE H'00e1: Card=1101 Use RTE: 007-001-000:H'0001
```

```
Trace Condition:
```

```
LOC= 1101
```

```
DPC= 007-001-000
```

```
MSU info:
```

```
TOTAL MSU SIZE= 12 Bytes
```

```
MSU DATA SIZE = 4 Bytes
```

```
      0 1 2 3 4 5 6 7 8 9 0 1 2 3 4 5 6 7 8 9
MTP: 85 00 01 07 01 65 01 16
```

```
DATA: 00 00 09 00
```

```
TRACE OUTPUT COMPLETE.
```

```
;
```

```
stdcfg1b 07-08-10 15:51:33 EST EAGLE 37.5.0
```

```
MSU TRACE H'00e1: Card=1101 Sending to 1103:B1
```

```
Trace Condition:
```

```
LOC= 1101
```

```
DPC= 007-001-000
```

```
MSU info:
```

```
TOTAL MSU SIZE= 12 Bytes
```

```
MSU DATA SIZE = 4 Bytes
```

```
      0 1 2 3 4 5 6 7 8 9 0 1 2 3 4 5 6 7 8 9
MTP: 85 00 01 07 01 65 01 0b
```

```
DATA: 00 00 09 00
```

```
TRACE OUTPUT COMPLETE.
```

```
;
```

```
stdcfg1b 07-08-10 15:51:33 EST EAGLE 37.5.0
```

```
MSU TRACE H'00e1: Card=1103 MSU Received from 1101
```

```
Trace Condition:
```

```
LOC= 1101
```

```
DPC= 007-001-000
```

```
MSU info:
```

```
TOTAL MSU SIZE= 12 Bytes
```

```
MSU DATA SIZE = 4 Bytes
```

```

      0 1 2 3 4 5 6 7 8 9 0 1 2 3 4 5 6 7 8 9
MTP:  85 00 01 07 01 65 01 0b

```

```

DATA: 00 00 09 00
TRACE OUTPUT COMPLETE.

```

;

```

stdcfg1b 07-08-10 15:51:33 EST  EAGLE 37.5.0
MSU TRACE H'00e1:  Card=1103  MSU sent to L2 - B1
Trace Condition:
LOC=          1101
DPC=          007-001-000

```

```

MSU info:
TOTAL MSU SIZE= 12 Bytes
MSU DATA SIZE = 4 Bytes

```

```

      0 1 2 3 4 5 6 7 8 9 0 1 2 3 4 5 6 7 8 9
MTP:  85 00 01 07 01 65 01 0b

```

```

DATA: 00 00 09 00
TRACE OUTPUT COMPLETE.

```

;

The following example displays output for an SCCP trace.

**ent-trace:loc=1101:gt=9194605500**

```

stdcfg1b 07-08-10 15:51:33 EST  EAGLE 37.5.0
MSU TRACE H'00e2:  Card=1101  RX - Link B0
Trace Condition:
LOC=          1101
GT=          9194605500

```

```

MSU info:
TOTAL MSU SIZE= 90 Bytes
MSU DATA SIZE = 82 Bytes

```

```

      0 1 2 3 4 5 6 7 8 9 0 1 2 3 4 5 6 7 8 9
MTP:  83 00 01 01 01 65 01 02

```

```

SCCP: 09 80 03 0e 13 0b 8b 8c 28 04 01 0a 19 49 06 55 00 05 c3 0a
      04 05 06

```

```

TCAP: 3a e2 38 c7 04 e5 04 61 80 e8 30 e9 2e cf 01 00 d0 02 83 01
      f2 25 aa 0b 84 09 01 00 11 0a 19 49 06 12 19 84 09 02 00 11
      0a 19 39 88 41 63 84 07 07 00 01 03 21 03 00 df 45 01 00
TRACE OUTPUT COMPLETE.

```

;

```

stdcfg1b 07-08-10 15:51:33 EST  EAGLE 37.5.0
MSU TRACE H'00e2:  Card=1101  TVG: Sending to SCCP 1107
Trace Condition:
LOC=          1101
GT=          9194605500

```

```

MSU info:
TOTAL MSU SIZE= 90 Bytes
MSU DATA SIZE = 82 Bytes

```

```

      0 1 2 3 4 5 6 7 8 9 0 1 2 3 4 5 6 7 8 9
MTP:  83 00 01 01 01 65 01 02

```

```

SCCP: 09 80 03 0e 13 0b 8b 8c 28 04 01 0a 19 49 06 55 00 05 c3 0a
      04 05 06

```

```

TCAP: 3a e2 38 c7 04 e5 04 61 80 e8 30 e9 2e cf 01 00 d0 02 83 01

```



```

f2 25 aa 0b 84 09 01 00 11 0a 19 49 06 12 19 84 09 02 00 11
0a 19 39 88 41 63 84 07 07 00 01 03 21 03 00 df 45 01 00
TRACE OUTPUT COMPLETE.

```

;

```

stdcfg1b 07-08-10 15:51:33 EST EAGLE 37.5.0
MSU TRACE H'00e2: Card=1107 MSU Received from 1101
Trace Condition:
LOC= 1101
GT= 9194605500

```

```

MSU info:
TOTAL MSU SIZE= 90 Bytes
MSU DATA SIZE = 82 Bytes

```

```

0 1 2 3 4 5 6 7 8 9 0 1 2 3 4 5 6 7 8 9
MTP: 83 00 01 01 01 65 01 02

```

```

SCCP: 09 80 03 0e 13 0b 8b 8c 28 04 01 0a 19 49 06 55 00 05 c3 0a
04 05 06

```

```

TCAP: 3a e2 38 c7 04 e5 04 61 80 e8 30 e9 2e cf 01 00 d0 02 83 01
f2 25 aa 0b 84 09 01 00 11 0a 19 49 06 12 19 84 09 02 00 11
0a 19 39 88 41 63 84 07 07 00 01 03 21 03 00 df 45 01 00
TRACE OUTPUT COMPLETE.

```

;

```

stdcfg1b 07-08-10 15:51:33 EST EAGLE 37.5.0
MSU TRACE H'00e2: Card=1107 SCCP: Before SS7 Trans Encod
Trace Condition:
LOC= 1101
GT= 9194605500

```

```

MSU info:
TOTAL MSU SIZE= 97 Bytes
MSU DATA SIZE = 89 Bytes

```

```

0 1 2 3 4 5 6 7 8 9 0 1 2 3 4 5 6 7 8 9
MTP: 83 00 01 01 01 65 01 02

```

```

SCCP: 09 80 03 0e 13 0b 8b 8c 28 04 01 0a 19 49 06 55 00 05 c3 0a
04 05 06

```

```

TCAP: 3a e2 38 c7 04 e5 04 61 80 e8 30 e9 2e cf 01 00 d0 02 83 01
f2 25 aa 0b 84 09 01 00 11 0a 19 49 06 12 19 84 09 02 00 11
0a 19 39 88 41 63 84 07 07 00 01 03 21 03 00 df 45 01 00 02
08 01 65 01 00 04
TRACE OUTPUT COMPLETE.

```

;

```

stdcfg1b 07-08-10 15:51:33 EST EAGLE 37.5.0
MSU TRACE H'00e2: Card=1107 SCCP: After SS7 Trans Encode
Trace Condition:
LOC= 1101
GT= 9194605500

```

```

MSU info:
TOTAL MSU SIZE= 97 Bytes
MSU DATA SIZE = 89 Bytes

```

```

0 1 2 3 4 5 6 7 8 9 0 1 2 3 4 5 6 7 8 9
MTP: 83 00 01 07 00 01 01 02

```

```

SCCP: 09 80 03 0e 13 0b cb 10 00 01 07 0a 19 49 06 55 00 05 c3 0a
04 05 06

```

```
TCAP: 3a e2 38 c7 04 e5 04 61 80 e8 30 e9 2e cf 01 00 d0 02 83 01
      f2 25 aa 0b 84 09 01 00 11 0a 19 49 06 12 19 84 09 02 00 11
      0a 19 39 88 41 63 84 07 07 00 01 03 21 03 00 df 45 01 00 02
      08 01 65 01 00 04
TRACE OUTPUT COMPLETE.
```

;

```
stdcfg1b 07-08-10 15:51:33 EST EAGLE 37.5.0
MSU TRACE H'00e2: Card=1107 Use RTE 007-001-000:H'0009
Trace Condition:
LOC=          1101
GT=           9194605500
```

```
MSU info:
TOTAL MSU SIZE= 97 Bytes
MSU DATA SIZE = 89 Bytes
```

```
      0 1 2 3 4 5 6 7 8 9 0 1 2 3 4 5 6 7 8 9
MTP: 83 00 01 07 00 01 01 02
```

```
SCCP: 09 80 03 0e 13 0b cb 10 00 01 07 0a 19 49 06 55 00 05 c3 0a
      04 05 06
```

```
TCAP: 3a e2 38 c7 04 e5 04 61 80 e8 30 e9 2e cf 01 00 d0 02 83 01
      f2 25 aa 0b 84 09 01 00 11 0a 19 49 06 12 19 84 09 02 00 11
      0a 19 39 88 41 63 84 07 07 00 01 03 21 03 00 df 45 01 00 02
      08 01 65 01 00 04
TRACE OUTPUT COMPLETE.
```

;

```
stdcfg1b 07-08-10 15:51:33 EST EAGLE 37.5.0
MSU TRACE H'00e2: Card=1107 Sending to 1103:B1
Trace Condition:
LOC=          1101
GT=           9194605500
```

```
MSU info:
TOTAL MSU SIZE= 97 Bytes
MSU DATA SIZE = 89 Bytes
```

```
      0 1 2 3 4 5 6 7 8 9 0 1 2 3 4 5 6 7 8 9
MTP: 83 00 01 07 00 01 01 01
```

```
SCCP: 09 80 03 0e 13 0b cb 10 00 01 07 0a 19 49 06 55 00 05 c3 0a
      04 05 06
```

```
TCAP: 3a e2 38 c7 04 e5 04 61 80 e8 30 e9 2e cf 01 00 d0 02 83 01
      f2 25 aa 0b 84 09 01 00 11 0a 19 49 06 12 19 84 09 02 00 11
      0a 19 39 88 41 63 84 07 07 00 01 03 21 03 00 df 45 01 00 02
      08 01 65 01 00 04
TRACE OUTPUT COMPLETE.
```

;

```
stdcfg1b 07-08-10 15:51:33 EST EAGLE 37.5.0
MSU TRACE H'0000: Card=1103 MSU Received from 1107
Trace Condition:
LOC=          1101
GT=           9194605500
```

```
MSU info:
TOTAL MSU SIZE= 97 Bytes
MSU DATA SIZE = 89 Bytes
```

```
      0 1 2 3 4 5 6 7 8 9 0 1 2 3 4 5 6 7 8 9
```

```

MTP: 83 00 01 07 00 01 01 01

SCCP: 09 80 03 0e 13 0b cb 10 00 01 07 0a 19 49 06 55 00 05 c3 0a
      04 05 06

TCAP: 3a e2 38 c7 04 e5 04 61 80 e8 30 e9 2e cf 01 00 d0 02 83 01
      f2 25 aa 0b 84 09 01 00 11 0a 19 49 06 12 19 84 09 02 00 11
      0a 19 39 88 41 63 84 07 07 00 01 03 21 03 00 df 45 01 00 02
      08 01 65 01 00 04

TRACE OUTPUT COMPLETE.

```

;

```

stdcfg1b 07-08-10 15:51:33 EST EAGLE 37.5.0
MSU TRACE H'0000: Card=1103 MSU sent to L2 - B1
Trace Condition:
LOC=          1101
GT=           9194605500

```

```

MSU info:
TOTAL MSU SIZE= 90 Bytes
MSU DATA SIZE = 82 Bytes

```

```

      0 1 2 3 4 5 6 7 8 9 0 1 2 3 4 5 6 7 8 9
MTP: 83 00 01 07 00 01 01 01

```

```

SCCP: 09 80 03 0e 13 0b cb 10 00 01 07 0a 19 49 06 55 00 05 c3 0a
      04 05 06

```

```

TCAP: 3a e2 38 c7 04 e5 04 61 80 e8 30 e9 2e cf 01 00 d0 02 83 01
      f2 25 aa 0b 84 09 01 00 11 0a 19 49 06 12 19 84 09 02 00 11
      0a 19 39 88 41 63 84 07 07 00 01 03 21 03 00 df 45 01 00

TRACE OUTPUT COMPLETE.

```

;

The following example displays output for a trace when truncated output is requested. Only the filters that are specified in the command are displayed.

**ent-**

**trace:loc=1305:si=0:hoh1=20:sls=255:cpc=001-002-003:mode=debug:br  
ief=yes**

```

tklc1071501 08-09-22 10:49:00 EST EAGLE5 39.2.0

```

;

```

tklc1071501 08-09-22 10:49:00 EST EAGLE5 39.2.0
MSU TRACE H'0081: Card=1305
Trace ID 1 Condition:
LOC=          1305
SI=           0
H0H1=         20
SLS=          255
CPC=          001-002-003
MODE=         DEBUG

```

```

Info: RX - Link A0

```

```

TRACE OUTPUT COMPLETE.

```

;

```

tklc1071501 08-09-22 10:49:00 EST EAGLE5 39.2.0
MSU TRACE H'0081: Card=1305
Trace ID 1 Condition:
LOC=          1305
SI=           0
H0H1=         20
SLS=          255
CPC=          001-002-003

```

```
MODE=          DEBUG

Info: TIF Stop Action: OK

TRACE OUTPUT COMPLETE.
;

tklcl071501 08-09-22 10:49:00 EST  EAGLE5 39.2.0
MSU TRACE H'0081: Card=1305
Trace ID 1 Condition:
LOC=           1305
SI=            0
H0H1=         20
SLS=          255
CPC=          001-002-003
MODE=         DEBUG

Info: TVG: Sending to SCCP 1317

TRACE OUTPUT COMPLETE.
;

tklcl071501 08-09-22 10:49:00 EST  EAGLE5 39.2.0
MSU TRACE H'0081: Card=1317
Trace ID 1 Condition:
LOC=           1305
SI=            0
H0H1=         20
SLS=          255
CPC=          001-002-003
MODE=         DEBUG

Info: SCCP: MSU RX from 1305

TRACE OUTPUT COMPLETE.
;

tklcl071501 08-09-22 10:49:00 EST  EAGLE5 39.2.0
MSU TRACE H'0081: Card=1317
Trace ID 1 Condition:
LOC=           1305
SI=            0
H0H1=         20
SLS=          255
CPC=          001-002-003
MODE=         DEBUG

Info: TIF Process Msg: Ruleset TIF1

TRACE OUTPUT COMPLETE.
;

tklcl071501 08-09-22 10:49:00 EST  EAGLE5 39.2.0
MSU TRACE H'0081: Card=1317
Trace ID 1 Condition:
LOC=           1305
SI=            0
H0H1=         20
SLS=          255
CPC=          001-002-003
MODE=         DEBUG

Info: TIF: No Error CdPN:111111119703819111100

TRACE OUTPUT COMPLETE.
```

```
;

tklcl071501 08-09-22 10:49:00 EST EAGLE5 39.2.0
MSU TRACE H'0081: Card=1305
Trace ID 1 Condition:
LOC=          1305
SI=           0
H0H1=         20
SLS=          255
CPC=          001-002-003
MODE=         DEBUG

Info: Use RTE (16) DPCa:  023-172-011, OPCa:  013-159-005

TRACE OUTPUT COMPLETE.

;

tklcl071501 08-09-22 10:49:00 EST EAGLE5 39.2.0
MSU TRACE H'0081: Card=1305
Trace ID 1 Condition:
LOC=          1305
SI=           0
H0H1=         20
SLS=          255
CPC=          001-002-003
MODE=         DEBUG

Info: Sending to 2311:B3

TRACE OUTPUT COMPLETE.

;

tklcl071501 08-09-22 10:49:00 EST EAGLE5 39.2.0
MSU TRACE H'0081: Card=2311
Trace ID 1 Condition:
LOC=          1305
SI=           0
H0H1=         20
SLS=          255
CPC=          001-002-003
MODE=         DEBUG

Info: MSU Received from 1305

TRACE OUTPUT COMPLETE.

;

tklcl071501 08-09-22 10:49:00 EST EAGLE5 39.2.0
MSU TRACE H'0081: Card=2311
Trace ID 1 Condition:
LOC=          1305
SI=           0
H0H1=         20
SLS=          255
CPC=          001-002-003
MODE=         DEBUG

Info: MSU sent to L2 - B3: DPCa=  023-172-011, OPCa=  013-159-005

TRACE OUTPUT COMPLETE.

;

tklcl071501 08-09-22 10:49:00 EST EAGLE5 39.2.0
MSU TRACE H'0081: Card=2311
Trace ID 1 Condition:
```

```

LOC=          1305
SI=           0
H0H1=        20
SLS=         255
CPC=         001-002-003
MODE=        DEBUG

Info: Transmitted and ACK'd on B3

TRACE OUTPUT COMPLETE.
;

```

## rtrv-upgrade-config

## Retrieve Upgrade Configuration

Use this command to retrieve provisioned data used by the upgrade software during an upgrade of an in-service EAGLE 5 ISS from a source release to the target release.

**Keyword:** `rtrv-upgrade-config`

**Related Commands:** `act-upgrade`, `chg-upgrade-config`

**Command Class:** Debug

### Parameters

**:display=** (optional)

Display Indicator. This parameter indicates what type of output is to be displayed.

**Range:** `tblcnv`, `prtntstat`, `all`

**tblcnv** — Displays a list of DMS tables that will be converted during the next upgrade.

These tables are selected for conversion using the `chg-upgrade-config` command.

**prtntstat** — This parameter is not implemented at this time.

**all** — Display all upgrade configuration data.

**Default:** `all`

### Example

Display a list of DMS tables that will be converted during the next upgrade.

```

rtrv-upgrade-config:display=tblcnv
rtrv-upgrade-config

```

### Dependencies

None

### Output

```

rtrv-upgrade-config:display=tblcnv
rlghncxa03w 07-03-13 08:15:45 EST EAGLE 37.5.0
The following tables will be converted:
FEAT_CTRL Table, ID=327
Command Completed.
;

rtrv-upgrade-config
rlghncxa03w 08-09-13 08:15:45 EST EAGLE 39.2.0
Software Access Key entered on system: VBJYAPDPBTEJB
Command Completed.
;

```

## send-msg

## Send Message

Use this debug command to manually simulate a system generated message from a user terminal. The parameters (not entered by the user) are defaulted to:

- Origination subsystem = **cam\_active**
- Destination subsystem = **orig application ID=appl\_ID\_ui**
- Violation= **no report**
- Bus = **imt choice**
- Message length = **computed**

**Keyword:** send-msg

**Related Commands:**

**Command Class:** Debug

### Parameters

**:da=** (mandatory)

This parameter specifies the destination application ID.

**Range:** 0-255

**:ds=** (mandatory)

This parameter specifies the destination subsystem.

**Range:** 0-255

**:f=** (mandatory)

This parameter specifies the function ID.

**Range:** 0-255

**:loc=** (mandatory)

Location. This parameter specifies the card location as stenciled on the shelf of the system.

**Range:** 1101-1108, 1111-1113, 1115, 1201-1208, 1211-1218, 1301-1308, 1311-1318, 2101-2108, 2111-2118, 2201-2208, 2211-2218, 2301-2308, 2311-2318, 3101-3108, 3111-3118, 3201-3208, 3211-3218, 3301-3308, 3311-3318, 4101-4108, 4111-4118, 4201-4208, 4211-4218, 4301-4308, 4311-4318, 5101-5108, 5111-5118, 5201-5208, 5211-5218, 5301-5308, 5311-5318, 6101-6108, 6111-6118

**:alt=** (optional)

This parameter specifies whether to use the alternate bus bit.

**Range:** on, off

**Default:** on

**:bus=** (optional)

This parameter specifies the IMT bus.

**Range:** a, b

**Default:** a

**:d0=** (optional)

This parameter specifies the application data.

**Range:** 0-255

**:d1=** (optional)

This parameter specifies the application data.

**Range:** 0-255

**:d2=** (optional)

Application Data.

**Range:** 0-255

- :d3=** (optional)  
This parameter specifies the application data.  
**Range: 0-255**
- :d4=** (optional)  
This parameter specifies the application data.  
**Range: 0-255**
- :d5=** (optional)  
This parameter specifies the application data.  
**Range: 0-255**
- :d6=** (optional)  
This parameter specifies the application data.  
**Range: 0-255**
- :d7=** (optional)  
This parameter specifies the application data.  
**Range: 0-255**
- :d8=** (optional)  
This parameter specifies the application data.  
**Range: 0-255**
- :d9=** (optional)  
This parameter specifies the application data.  
**Range: 0-255**
- :len=** (optional)  
This parameter specifies the message length in bytes.  
**Range: 0-65535**  
**Default: Calculated**
- :oa=** (optional)  
This parameter specifies the originating application ID.  
**Range: 0-255**  
**Default: 2**
- :os=** (optional)  
This parameter specifies the originating subsystem.  
**Range: 0-255**  
**Default: 0**
- :sut=** (optional)  
This parameter specifies the signal unit type.  
**Range: 0-9**  
**Default: 2**

### Example

```
send-msg:loc=1113:os=2:oa=h'28:ds=2:da=h'28:f=7  
send-msg:loc=1113:ds=2:oa=h'17:da=h'30:f=11  
send-msg:loc=1116:ds=2:oa=h'17::da=h'30:f=12
```

### Dependencies

The value of the **da** parameter must be valid.



The destination location must be equipped to receive messages.

Card locations *xy 09* and *xy 10* cannot be used with bus *b* and bus *a*, respectively.

The value of the *ds* parameter must be valid.

### Notes

Both the *bus* and *sut* parameters must be used when sending a message to an HMUX or HIPR card.

If the *bus* parameter is not specified with an HMUX or HIPR card location on *imt b* (such as *xy 10*), the bus *b* parameter value is used instead of the bus *a* parameter value.

### Output

```

send-msg:loc=1113:os=2:oa=h'28:ds=2:da=h'28:f=7
rlghncxa03w 01-03-13 15:01:02 EST
0061.0019     CARD 1113 PSM     ADMIN     PSM became active
;

send-msg:loc=1113:ds=2:oa=h'17:da=h'30:f=11
rlghncxa03w 01-03-13 15:02:34 EST
System Buffer sent has following attributes :
  Msg Length = H'0006
  Dest Card = H'00f4
  Orig Subsys = H'0002           Dest Subsys = H'0002
  Orig Appl ID = H'0017         Dest Appl ID = H'0030
  Func ID = H'000b             Bus/Alt/SUT = H'000b
  Violation Ind = H'0000
User Message sent to location 1113.
;

send-msg:sut=7:loc=1110:ds=0:da=h'40:f=h'a3:d0=0:bus=b
tekelecstp 06-01-11 11:39:15 EST  EAGLE 35.1.0
  System Buffer sent has following attributes :
  Msg Length = H'0010
  Dest Card = H'00ff
  Orig Subsys = H'0001           Dest Subsys = H'0000
  Orig Appl ID = H'0030         Dest Appl ID = H'0040
  Func ID = H'00a3             Bus/Ret/Sut = H'0087
  Violation Ind = H'0000
User Message sent to location 1110.
;

```

## set-mem

## Set Memory

Use this command to set values in memory in the communication and application processors. If a card is reloaded, these memory changes are lost.

**Keyword:** set-mem

**Related Commands:** disp-mem

**Command Class:** Debug

### Parameters

**:addr=** (optional)

This parameter specifies the address, in the form of *segment–offset*.

**Range:**     *segment–offset*  
               *segment—h'00–h'ffff*  
               *offset—h'00–h'ffff*

**:byte=** (optional)

This parameter specifies the byte value to write to the specified memory location(s).

**Range:** 0-h'00-h'ff

**:card=** (optional)

This parameter specifies the card location, in the form of *GPLID-Subsystem ID*.

**Range:** *GPLID-Subsystem ID*

*GPLID*—atmansi, atmitu, atmhc, bphcap, bpdcm, bpdcm2, ccs7itu, eoam, eroute, erthc, gls, hipr, hipr2, ipghc, ipgwi, iplhc, iplim, iplimi, ips, ipsg, ipshc, mcp, mplga, mplgi, pktgen, sccphc, slanhc, ss7ansi, ss7epm, ss7gx25, ss7hc, ss7ipgw, ss7ml, stplan, utility, vsccp, vxutil, vxwslan  
*Subsystem ID*—a, b, act, stby, all

The **oam** GPL can be specified with any of the subsystem IDs.

For all other GPLs, only the **all** subsystem ID is valid.

**:dword=** (optional)

This parameter specifies a double word value to write to the specified memory location(s).

**Range:** 0-h'00-h'ffffff

**:fill=** (optional)

This parameter specifies the number of times that the value is to be written to successive addresses.

**Range:** 0-65535

**Default:** 1

**:imt=** (optional)

This parameter specifies the IMT address.

**Range:** 0-254

**:loc=** (optional)

Location. This parameter specifies the card location as stenciled on the shelf of the system.

**Range:** 1101-1113, 1201-1218, 1301-1318, 2101-2118, 2201-2218, 2301-2318, 3101-3118, 3201-3218, 3301-3318, 4101-4118, 4201-4218, 4301-4318, 5101-5118, 5201-5218, 5301-5318, 6101-6118, 1115

**:mask=** (optional)

This parameter specifies the mask that selects the bits that are to be included in the operation (op).

**Range:** 0-0xFFFFFFFF

**Default:** 0xFFFFFFFF

**:op=** (optional)

Operation. This parameter specifies the operation that is performed in order to arrive at the final value in the memory location.

**Range:** replace, and, or, x

**Default:** replace

**:paddr=** (optional)

This parameter specifies the physical offset of the memory address.

**Range:** h'00-h'ffffff

**:proc=** (optional)

This parameter specifies the processor type.

**Range:** appl, com

**appl**—Application processor

**com**—Communication processor

**Default:** appl

**:word=** (optional)

This parameter specifies a word value to write to the specified memory location(s).

**Range:**     **h'00–h'ffff**

### Example

```
set-mem:card=ss7ansi-all:addr=h'03a-h'001:byte=4
```

```
set-mem:loc=1109:paddr=h'201000:byte=0:fill=1024
```

```
set-mem:card=hipr-all:paddr=h'202000:word=h'2a:op=and:mask=h'fff
```

### Dependencies

Either the **loc**, **imt**, or **card** parameter must be specified.

Only one of the **loc**, **imt**, and **card** parameters can be specified in the command.

Either the **addr** or **paddr** parameter can be specified, but not both, in the command.

The value of the **bc** parameter must not exceed 2000.

The card location specified by the **loc** parameter must be in the database.

All of the subsystem values can be specified with the **oam** GPLID. The other GPLID values can be specified only with the **all** subsystem value.

Card locations (**loc** parameter) **1114**, **1116**, **1117**, and **1118** are not valid for memory commands.

The GPL specified by the **card** parameter is not supported.

Either the **byte**, **word**, or **dword** parameter must be specified.

Only one of the **byte**, **word**, and **dword** parameters can be specified in the command.

The **paddr** parameter cannot be specified for an SS7 LIM card.

### Notes

The **imt** parameter allows this command to be entered for a card that has not been configured in the system.

### Output

```
set-mem:card=ss7ansi-all:addr=h'03a-h'001:byte=4
```

```
rlghncxa03w 01-03-22 21:14:03 EST Rel 28.1.0
```

```
SDS Response Code 22 from IMT Address H'00f6 - command complete.
```

```
;
```



# Pass-Through Commands

This chapter introduces the pass-through commands and describes the command conventions. The pass-through commands are listed in alphabetical order starting on page 7-2.

## Introduction

The pass-through commands are used within the **pass** command (see Chapter 5). Pass-through commands are passed through the OAM and sent to individual cards for processing. Pass-through commands reduce the need to add card-specific and application-specific code to the OAM build.

## Command Conventions

The following is an example of a **pass** command:

```
pass:loc=1201:cmd="connmgr -c"
```

The **cmd** parameter contains the pass-through command (**connmgr -c**) within the double quotes.

Pass-through commands consist of two types of tokens: command name and command options. Tokens are whitespace-delimited and null-terminated. The generalized format of a pass-through command is:

```
command_name option1 option2....option n-1.... option n
```

In the example, the **command\_name** is '**connmgr**' and the option is '-c'.

Options and option parameters are made up of a specific character string or a variable. The variable is to be replaced with a value selected from a range of values. Option variables and option parameter variables are underlined. For example, the **arp** command option **-d** has the parameter variable **IP address**. Specify the IP address as in the command **arp -d 192.9.200.44**. Do not enter the underlined text; enter a value instead.

Help information for each pass-through command can be obtained by using the option **-h** on any command.

## arp

## Address Resolution Protocol

This command is used to display and modify the internet to ethernet address translation tables used by the address resolution protocol.

**Keyword:** arp

**Command Class:** IP Stack Maintenance

**Options**

Options and option parameters that are underlined indicate that a value must be specified for that option or parameter. For example, the arp command option **-d** has the parameter IP address. The IP address must be specified for which an ARP entry will be deleted, as in the command **arp -d 192.9.200.44**. Do not enter the underlined option or parameter; enter a value for the information represented by the underlined option or parameter.

**-a**

This option displays all entries in the ARP table.

**-d IP address**

This option deletes an ARP entry for the specified IP address.

The IP address is a TCP/IP address expressed in standard “dot notation.” IP addresses consist of the system’s network number and the machine’s unique host number. An example IP address is **192.9.200.44**, where **192.9.200** is the network number and **44** is the machine’s host number.

**Range:**

4 numbers separated by dots, with each number in the range of **0-255**.

**-f**

This option flushes all entries from the ARP table.

**-h**

This option displays help (usage) information for the command.

**-s IP address MAC address**

This option creates an ARP entry for the specified IP address and ethernet address.

**Range:**

4 numbers separated by dots, with each number in the range of **0-255**.

The IP address is a TCP/IP address expressed in standard “dot notation.” IP addresses consist of the system’s network number and the machine’s unique host number. For example, **192.9.200.44**, where **192.9.200** is the network number and **44** is the machine’s host number.

**Range:**

6 hexadecimal numbers separated by colons; each number in the range **0 - FF**.

The MAC (media access control) address is an ethernet address with the format *x:x:x:x:x:x*, where *x* is a hexadecimal integer from **0** to **FF**. For example, **08:00:20:1b:0f:f2**.

**Example**

```
arp -a
```

```
arp -s 192.9.200.44 08:00:20:1b:0f:f2
```

```
arp -d 192.9.200.44
```

```
arp -f
```

**Dependencies**

Only one of the options can be specified at a time.

The **arp** command with no options displays all of the current ARP cache entries.

### Notes

The **arp** command is executed through the **pass** command.

### Output

**pass:loc=1105:cmd="arp" or**

**pass:loc=1105:cmd="arp -h"**

```

Command Accepted - Processing

rlghncxa03w 04-07-27 08:10:00 EST  EAGLE5 31.6.0
pass:loc=1105:cmd="arp"
Command entered at terminal #1.
;

rlghncxa03w 04-07-27 08:10:00 EST  EAGLE5 31.6.0
PASS: Command sent to card
;

rlghncxa03w 04-07-27 08:10:00 EST  EAGLE5 31.6.0

Usage: arp [-a] [-d ipaddr] [-f] [-h] [-s ipaddr enetaddr]

Options:
-a      Display All entries in ARP table
-d      Delete specified entry (ipaddr) from ARP table
-f      Flush all entries from ARP table
-h      Displays this message
-s      Set ARP table entry to associate ipaddr with enetaddr
enetaddr x:x:x:x:x:x
ipaddr   d.d.d.d
;

rlghncxa03w 04-07-27 08:10:01 EST  EAGLE5 31.6.0

ARP command complete
;

```

**pass:loc=1105:cmd="arp -s 192.168.100.234 11:22:33:44:55:66"**

```

Command Accepted - Processing

rlghncxa03w 04-07-27 08:11:08 EST  EAGLE5 31.6.0
pass:loc=1105:cmd="arp -s 192.168.100.234 11:22:33:44:55:66"
Command entered at terminal #1.
;

rlghncxa03w 04-07-27 08:11:08 EST  EAGLE5 31.6.0
PASS: Command sent to card
;

rlghncxa03w 04-07-27 08:11:08 EST  EAGLE5 31.6.0

ARP: 192.168.100.234 (11:22:33:44:55:66) added
;

rlghncxa03w 04-07-27 08:11:09 EST  EAGLE5 31.6.0

ARP command complete
;

```

**pass:loc=1105:cmd="arp -a"**

Command Accepted - Processing

```

rlghncxa03w 04-07-27 08:11:18 EST  EAGLE5 31.6.0
pass:loc=1105:cmd="arp -a"
Command entered at terminal #1.
;
rlghncxa03w 04-07-27 08:11:18 EST  EAGLE5 31.6.0
PASS: Command sent to card
;
RLGHNCXA03WRLGHNCXA03W 04-07-27 08:11:18 EST  EAGLE5 31.6.0

LINK LEVEL ARP TABLE
destination      gateway                flags  Refcnt  Use      Interface
-----
192.168.55.250   00:e0:16:9b:0d:86     405    1       0       seeq1
192.168.100.234 11:22:33:44:55:66    c05    0       0       seeq0
-----
;
rlghncxa03w 04-07-27 08:11:19 EST  EAGLE5 31.6.0
ARP command complete
;

```

**pass:loc=1105:cmd="arp -f"**

Command Accepted - Processing

```

rlghncxa03w 04-07-27 08:11:38 EST  EAGLE5 31.6.0
pass:loc=1105:cmd="arp -f"
Command entered at terminal #1.
;
rlghncxa03w 04-07-27 08:11:38 EST  EAGLE5 31.6.0
PASS: Command sent to card
;
rlghncxa03w 04-07-27 08:11:38 EST  EAGLE5 31.6.0
ARP: ARP table flushed
;
rlghncxa03w 04-07-27 08:11:38 EST  EAGLE5 31.6.0

ARP command complete
;

```



**pass:loc=1105:cmd="arp -d 192.111.111.222"**

```
E3780 Cmd Rej: Syntax Error Found

    rlghncxa03w 04-07-27 08:26:37 EST  EAGLE5 31.6.0
    pass:loc=1105:cmd="arp -d 192.111.111.222"
    Command entered at terminal #1.
;
    rlghncxa03w 04-07-27 08:26:37 EST  EAGLE5 31.6.0
    PASS: Command sent to card
;
    rlghncxa03w 04-07-27 08:26:37 EST  EAGLE5 31.6.0
    ARP: entry not deleted
;
    rlghncxa03w 04-07-27 08:26:37 EST  EAGLE5 31.6.0

    ARP command complete
;
```

## aslog

## SCTP Application Server Log

This command is used to display the state changes for a specified Application Server (AS).

**Keyword:** aslog

**Command Class:** Application Maintenance

### Options

Options and option parameters that are underlined indicate that a value must be specified for that option or parameter. For example, the **aslog** command has the parameter asname. The Application Server name must be specified for which the log will be displayed, as in the command **aslog as1**. Do not enter the underlined option or parameter; enter a value for the information represented by the underlined option or parameter.

asname

This option specifies the Association Server name for the display.

**-h**

This option displays help (usage) information for the command.

### Example

```
aslog as1
```

### Dependencies

None

### Notes

None

**Output****pass:loc=1105:cmd="aslog as1"**

```

Command Accepted - Processing

    rlgncxa03w 00-01-27 08:10:00 EST  EAGLE5 31.6.0
    pass:loc=1105:cmd="aslog as1"
    Command entered at terminal #3.
;
    rlgncxa03w 00-01-27 08:10:00 EST  EAGLE5 31.6.0
    PASS: Command sent to card
;
    rlgncxa03w 00-01-27 08:10:00 EST  EAGLE5 31.6.0
    ASLOG command in progress
;
    rlgncxa03w 00-01-27 08:10:00 EST  EAGLE5 31.6.0

ASLOG: AS history log

ASLOG: AS state history log

Date          Time          AS Event
-----
65-05-31  22:27:29.075  Transition to AS-Down
65-05-31  22:27:29.080  Transition to AS-Active Override
65-05-31  22:38:24.050  Transition to AS-Active Override

ASLOG command complete
;

```

**asplog****SCTP Application Server Process Log**

**NOTE: This command is obsolete. The functions have been updated and moved to the ualog command.**

This command is used to display the UA state history for a specified Application Server Process (ASP).

**Keyword:** **asplog**

**Command Class:** Application Maintenance

**Options**

Options and option parameters that are underlined indicate that a value must be specified for that option or parameter. For example, the **asplog** command has the parameter asp name. The Application Server Process must be specified for which the log will be displayed, as in the command **asplog s7000**. Do not enter the underlined option or parameter; enter a value for the information represented by the underlined option or parameter.

asp name

This option specifies the Application Server Process name for the display.

**-h**

This option displays help (usage) information for the command.

**-i event group**

This option includes groups of events in the state machine history.

**Range:** **service, ua**

**-x event group**

This option excludes groups of events from the state machine history.

**Range:** service, ua

### Example

**asplog s7000**

### Dependencies

None

### Notes

None

### Output

In this example, transmitted notification, ASP Inactivation (RFC Extension) , ASP Activation (RFC Extension) and ASP Failure Notification events are shown.

**pass:loc=1105:cmd="asplog s7000"**

```
Command entered at terminal #3.
;
rlghncxa03w 02-09-27 08:10:00 EST EAGLE5 31.6.0
PASS: Command sent to card
;
rlghncxa03w 02-09-27 08:10:00 EST EAGLE5 31.6.0
ASPLOG command in progress
;
```

```
rlghncxa03w 02-09-27 08:10:00 EST EAGLE5 31.6.0
```

```
ASPLOG: ASP history log
```

```
ASPLOG: ASP state history log
      UA version: 01
      ASP ID:0x00000002
      UA Adapter Implemented: M3UA RFC
      Current settings: -i service ua
```

| Date     | Time         | ASP Event                                            |
|----------|--------------|------------------------------------------------------|
| 02-08-01 | 17:17:46.700 | ASP Created                                          |
| 02-08-01 | 17:17:46.780 | AS Created                                           |
| 02-08-01 | 17:17:46.820 | Transition to OOS                                    |
| 02-08-01 | 17:17:46.940 | Management Socket Open                               |
| 02-08-01 | 17:17:46.940 | Transition to Connecting                             |
| 02-08-01 | 17:17:47.500 | Socket Allowed for Traffic                           |
| 02-08-01 | 17:17:49.375 | Socket Connection Established                        |
| 02-08-01 | 17:17:49.375 | Transition to ASP-DOWN                               |
| 02-08-01 | 17:17:49.390 | ASPUP PDU Received (ASP ID = 0x00000002)             |
| 02-08-01 | 17:17:49.390 | ASPUPACK PDU Transmitted                             |
| 02-08-01 | 17:17:49.390 | Transition to ASP-INACTIVE LOADSHARE                 |
| 02-08-01 | 17:17:49.390 | AS INACTIVE NTFY PDU Transmitted                     |
| 02-08-01 | 17:17:49.405 | ASPACTIVE PDU Received                               |
| 02-08-01 | 17:17:49.405 | ASPACTIVEACK PDU Transmitted                         |
| 02-08-01 | 17:17:49.405 | Transition to ASP-ACTIVE LOADSHARE                   |
| 02-08-01 | 17:17:49.405 | AS ACTIVE NTFY PDU Transmitted                       |
| 02-08-01 | 17:17:50.405 | ASP INACT NTFY PDU Transmitted (ASP ID =0x00000005)  |
| 02-08-01 | 17:17:50.405 | ASP ACT NTFY PDU Transmitted (ASP ID =0x00000005)    |
| 02-08-01 | 17:17:52.730 | ASP FAILURE NFY PDU Transmitted (ASP ID =0x00000003) |

```
ASPLOG command complete
```

```
;
```

The following output example shows output when User Adapter SUA RFC is implemented:

```
pass:loc=1303:cmd="asplog s7000"
```

```

rlghncxa03w 04-10-19 08:10:00 EST  EAGLE5 31.10.0
PASS: Command sent to card
;

rlghncxa03w 04-10-19 08:10:00 EST  EAGLE5 31.10.0

ASPLOG command in progress

;

rlghncxa03w 04-10-19 08:10:00 EST  EAGLE5 31.10.0
ASPLOG: ASP state history log
        UA Version: 01
        ASP ID: 0x00000007
        User Adapter Implemented: SUA RFC
        Current settings: -i service ua

Date      Time      Event
-----
04-11-09  18:56:06.515  IP Conn Established
04-11-09  18:56:06.515  Transition to ASP-DOWN
04-11-09  18:56:41.595  ASPUP PDU Received (ASP ID=0x00000007)
04-11-09  18:56:41.595  ASPUPACK PDU Transmitted
04-11-09  18:56:41.595  Transition to ASP-INACTIVE LOADSHARE
04-11-09  18:56:41.595  AS INACTIVE NTFY PDU Transmitted (RC=0000000023)
04-11-09  18:56:41.595  ASPACTIVE PDU Received (RC=none)
04-11-09  18:56:41.595  ASPACTIVEACK PDU Transmitted (RC=0000000023)
04-11-09  18:56:41.595  Transition to ASP-ACTIVE LOADSHARE
04-11-09  18:56:41.595  AS ACTIVE NTFY PDU Transmitted (RC=0000000023)

ASPLOG: command complete
;

```

When a received M3UA or SUA PDU contains errors, a response error message is transmitted containing an error code. Error codes are recorded to and displayed in the **asplog** output only when the UA peer-to-peer message logging option (**-i ua**) is enabled.

The following output example shows error code 0x0000015:

```
pass:loc=1303:cmd="asplog asp1303a"
```

```

rlghncxa03w 00-01-27 08:10:00 EST  EAGLE5 31.6.0
PASS: Command sent to card
;

rlghncxa03w 00-01-27 08:10:00 EST  EAGLE5 31.6.0

ASPLOG command in progress
;

rlghncxa03w 00-01-27 08:10:00 EST  EAGLE5 31.6.0

ASPLOG: ASP state history log
        UA Version: 01
        ASP ID:undefined
        UA Adapter Implemented: M3UA_RFC
        Current settings: -i service ua

Date           Time           Socket Event
-----
02-08-01  17:17:46.940  Management Socket Open
02-08-01  17:17:46.940  Transition to Connecting
02-08-01  17:17:49.375  Socket Connection Established
02-08-01  17:17:49.375  Transition to ASP-DOWN
02-08-01  17:17:49.390  ASPUP PDU Received (ASP ID = undefined)
02-08-01  17:17:49.390  ASPUPACK PDU Transmitted
02-08-01  17:17:49.390  Transition to ASP-INACTIVE LOADSHARE
02-08-01  17:17:49.390  AS INACTIVE NTFY PDU Transmitted
02-08-01  17:17:49.405  ASPACTIVE PDU Received
02-08-01  17:17:49.405  ASPACTIVEACK PDU Transmitted
02-08-01  17:17:49.405  Transition to ASP-ACTIVE LOADSHARE
02-08-01  17:17:49.405  AS ACTIVE NTFY PDU Transmitted
02-08-01  17:17:49.450  DAUD PDU Received
02-08-01  17:17:49.480  ERR PDU Transmitted (0x00000015)

ASPLOG command complete
;

```

## Error Codes

**NOTE: The following error codes are not used in M3UA: 0x02, 0x08, 0x1a, 0x1b, 0x1c, 0x10, 0x17, and 0x18**

The following error codes can appear in the error messages:

### 0x01—Invalid Version

A message was received with an invalid or unsupported version. The error message contains the supported version in the Common Header.

### 0x03—Unsupported Message Class

A message was received with an unexpected or unsupported Message Class.

### 0x04—Unsupported Message Type

A message was received with an unexpected or unsupported Message Type.

### 0x05—Unsupported Traffic Handling Mode

This error is sent by a Signaling Gateway Process (SGP) if an Application Server Process (ASP) sends an ASP Active message with an unsupported Traffic Mode Type or a Traffic

Mode Type that is inconsistent with the currently configured mode for the Application Server (AS).

**0x06**—Unexpected Message

This error message can be sent if a defined and recognized message is received that is not expected in the current state. In some cases the ASP might silently discard the message and not send an error message. Silent discard is used by an ASP if it received a DATA message from a signaling point while the ASP is in the ASP-INACTIVE state. If the unexpected message contains Routing Context, the Routing Context can be included in the error message.

**0x07**—Protocol Error

This error message is sent for any protocol anomaly, such as reception of a parameter that is syntactically correct but unexpected in the current situation.

**0x09**—Invalid Stream Identifier

A message is received on an unexpected SCTP stream (for example, a Management message was received on a stream other than 0).

**0x0d**—Refused - Management Blocking

An ASP Up or ASP Active message is received and the request is refused for management reasons (such as management lockout). If this error is in response to an ASP Active message, the Routing Context in the ASP Active message can be included in the error message.

**0x0e**—ASP Identifier Required

This error message is sent by an SGP in response to an ASP Up message that does not contain an ASP Identifier parameter when the SGP requires one. The ASP should resend the ASP Up message with an ASP Identifier.

**0x0f**—Invalid ASP Identifier

This error message is sent by an SGP in response to an ASP Up message with an invalid (for example, non-unique) ASP Identifier

**0x11**—Invalid Parameter Value

A message is received with an invalid parameter value (for example, a DUPU message was received with a Mask value other than 0).

**0x12**—Parameter Field Error

A message is received with a parameter that has a wrong length field.

**0x13**—Unexpected Parameter

A message contains an invalid parameter.

**0x14**—Destination Status Unknown

This error message can be sent if a DAUD is received at a Signaling Gateway (SG) asking for the availability/congestion status of a destination, and the SG does not provide the status (as in the case when the sender is not authorized to know the status). For this error, each invalid or unauthorized Point Code is included along with the Network Appearance and/or Routing Context associated with the Point Code.

**0x15**—Invalid Network Appearance

This error message is sent by an SGP if an ASP sends a message with an invalid (unconfigured) Network Appearance value. For this error, the invalid (unconfigured) Network Appearance is included in the Network Appearance parameter.

**0x16**—Missing Parameter

A message is received, and a mandatory parameter is not included in the message.

**0x19**—Invalid Routing Context

A message is received from a peer with an invalid (unconfigured) Routing Context value. The invalid Routing Context is included in the error message.

**0x1a**—No Configured AS for ASP

A message is received from a peer without a Routing Context parameter, and it is not known by configuration data which Application Servers are referenced.

**assocrtt****SCTP Association Round Trip Time**

This command is used to display the SCTP round trip times for a specified association. Minimum, maximum, and average times are kept for each open association. The Retransmission Mode (RFC or LIN) and the configured Minimum and Maximum Retransmission Timeout limits are also displayed.

**Keyword:** **assocrtt**

**Command Class:** Application Maintenance

**Options**

Options and option parameters that are underlined indicate that a value must be specified for that option or parameter. For example, the **assocrtt** command has the parameter aname. The association name must be specified for which the information will be displayed, as in the command **assocrtt c7000**. Do not enter the underlined option or parameter; enter a value for the information represented by the underlined option or parameter.

aname

This option specifies the association name for the display.

**-r**

This option resets all statistics for the specified association name.

**Example**

```
assocrtt c7000
```

```
assocrtt c7000 -r
```

**Dependencies**

None

**Notes**

This command does not indicate whether or not the socket is congested.



**Output****pass:loc=1105:cmd="assocrtt" or****pass:loc=1105:cmd="assocrtt -h"**

```

Command entered at terminal #1.
;
rlghncxa03w 00-01-27 08:10:00 EST  EAGLE5 31.6.0
PASS: Command sent to card
;
rlghncxa03w 00-01-27 08:10:00 EST  EAGLE5 31.6.0

Usage: ASOCRRTT sockname [-r] [-h]
Options:
  -r          Resets rtt data for specified association
  -h          Displays this message
;
rlghncxa03w 00-01-27 08:10:00 EST  EAGLE5 31.6.0
ASSocrtt command complete
;

```

**pass:loc=1105:cmd="assocrtt c7000"**

Command Accepted - Processing

```

rlghncxa03w 00-01-27 08:10:00 EST  EAGLE5 31.6.0
pass:loc=1105:cmd="assocrtt c7000"
Command entered at terminal #1.
;
rlghncxa03w 00-01-27 08:10:00 EST  EAGLE5 31.6.0
PASS: Command sent to card
;
rlghncxa03w 00-01-27 08:10:00 EST  EAGLE5 31.6.0

ASSOCRRTT: Association round trip time report (in milliseconds)

Retransmission Configuration
  Retransmission Mode           : LIN
  Minimum RTO      : 120
  Maximum RTO      : 800

Traffic Round-Trip Times

  Minimum round-trip time      : 5
  Maximum round-trip time      : 120
  Weighted Average round-trip time : 10
  Last recorded round-trip time  : 10
;
Measured Congested Traffic Round-Trip Times

  Minimum round-trip time      : 0
  Maximum round-trip time      : 0
  Weighted Average round-trip time : 0
  Last recorded round-trip time  : 0
;
rlghncxa03w 00-01-27 08:10:01 EST  EAGLE5 31.6.0
ASSOCRRTT command complete
;

```

**pass:loc=1105:cmd="assocrtt c7000 -r"**

```

Command entered at terminal #1.
;
rlghncxa03w 00-01-27 08:10:01 EST  EAGLE5 31.6.0
PASS: Command sent to card
;
rlghncxa03w 00-01-27 08:10:01 EST  EAGLE5 31.6.0

ASSocrtt: Association round-trip time report (in milliseconds)

Retransmission Configuration
  Retransmission Mode           : RFC
  Minimum RTO                   : 120
  Maximum RTO                   : 800

Traffic Round-Trip Times

  Minimum round-trip time       : 5
  Maximum round-trip time       : 120
  Weighted Average round-trip time : 10
  Last recorded round-trip time  : 10

Measured Congested Traffic Round-Trip Times

  Minimum round-trip time       : 0
  Maximum round-trip time       : 0
  Weighted Average round-trip time : 0
  Last recorded round-trip time  : 0
;
rlghncxa03w 00-01-27 08:10:01 EST  EAGLE5 31.6.0
ASSocrtt command complete
;

```

## connmgr

## Connection Manager

This command is used to generate reports about the status of the connection manager.

**Keyword:** connmgr

**Command Class:** Application Maintenance

### Options

**-d**

This option displays a connection manager data summary. For IPSG cards, this report contains summary information and does not contain information for individual signaling links.

**-h**

This option displays help (usage) information for the command.

**-i**

This option displays SCTP instance and association data.

**-l**

This option displays the connection manager event log.

**-n**

This option displays the SCTP notification log.

**-r**

This option resets the connection manager event log.

**Example****connmgr -r****connmgr -c****connmgr -s****Dependencies**

Only one of the options can be specified at a time.

If no options are specified, usage information is displayed.

**Notes**

The **connmgr** command is executed through the **pass** command.

**Output****pass:loc=1107:cmd="connmgr" or****pass:loc=1304:cmd="connmgr -h"**

```
Command Accepted - Processing

    rlgncxa03w 08-01-21 15:29:46 EST  EAGLE5 38.0.0
    pass:loc=1304:cmd="connmgr -h"
    Command entered at terminal #1.
;
    rlgncxa03w 08-01-21 15:29:46 EST  EAGLE5 38.0.0
    PASS: Command sent to card
;
    rlgncxa03w 04-07-02 15:29:46 EST  EAGLE5 31.6.0
    Usage: CONNMGR [-d] [-h] [-i] [-l] [-n] [-r]
    Options:
        -d    Display connection manager data summary
        -h    Displays this message
        -i    Displays instance data
        -l    Display the connection manager event log
        -n    Display the SCTP notification log
        -r    Reset the connection manager event log
;

```

**pass:loc=1107:cmd="connmgr -d"**

The Connection Manager Data Summary displays all provisioned signaling link ports.

In the following example, signaling link port (slk) B is valid only for IPLIMx cards.

```

Command Accepted - Processing

    rlghncxa03w 04-07-02 15:37:12 EST  EAGLE5 31.6.0
    pass:loc=1107:cmd="connmgr -d"
    Command entered at terminal #1.
;
    rlghncxa03w 04-07-02 15:37:12 EST  EAGLE5 31.6.0
    PASS: Command sent to card
;
    rlghncxa03w 04-07-02 15:37:12 EST  EAGLE5 31.6.0
    CONNMGR: command being processed
;
    rlghncxa03w 04-07-02 15:37:12 EST  EAGLE5 31.6.0
    CONNMGR: Connection Manager Data Summary
    slk link state  srv  cli  opn sock  inst  opn assoc
    ---  -
    A  active      1   0      1   0      0
    B  active      0   0      0   1      1

    CONNMGR command complete
;

```

In the following example, a summary data report is requested for an IPSG card.

**pass:loc=1304:cmd="connmgr -d"**

Command Accepted - Processing

```
eagle10110 08-01-15 16:09:24 EST EAGLE 38.0.0
pass:loc=1304:cmd="connmgr -d"
Command entered at terminal #3.
```

;

```
eagle10110 08-01-15 16:09:24 EST EAGLE 38.0.0
PASS: Command sent to card
```

;

```
eagle10110 08-01-15 16:09:24 EST EAGLE 38.0.0
CONNMGR: Connection Manager Data Summary
```

```
num_instances:                1
num_assocs:                    1
num_established_assocs:       0
num_cli_assocs:                0
num_established_cli_assocs:   0
num_assocs_with_tx_data:      0
num_full_assocs:              0
num_assoc_with_rcv_data:      0
num_times_tx_q_full:          0
num_assoc_down_notif:         0
num_assoc_aborted_notif:      0
num_assoc_restart_notif:      0
num_intf_up_notif:            0
num_intf_down_notif:          0
num_hb_resp_notif:            0
num_dg_fail_notif:            0
num_rd_errors:                 0
num_wt_errors:                 0
num_wt_shutdown:              0
num_wt_empty:                  0
```

CONNMGR: command complete

;

```
eagle10110 08-01-15 16:09:24 EST EAGLE 38.0.0
```

;

**pass:loc=1301:cmd="connmgr -i"**

Command Accepted - Processing

```
eagle10213 04-07-22 08:49:37 GMT EAGLE5 31.6.0
pass:loc=1301:cmd="connmgr -i"
Command entered at terminal #4.
;

eagle10213 04-07-22 08:49:37 GMT EAGLE5 31.6.0
PASS: Command sent to card
;

eagle10213 04-07-22 08:49:37 GMT EAGLE5 31.6.0

CONNMGR command being processed
;

eagle10213 04-07-22 08:49:37 GMT EAGLE5 31.6.0
CONNMGR: Connection Manager Instance Data
inst id  lport  cfg  est  tot  grntd  tot  rfsd
-----  -
021B7880  1301    2    2      0      0
;

CONNMGR command complete
;
```

**pass:loc=1107:cmd="connmgr -l"**

Command Accepted - Processing

```
rlghncxa03w 04-07-02 15:35:28 EST EAGLE5 31.6.0
pass:loc=1107:cmd="connmgr -l"
Command entered at terminal #1.
;

rlghncxa03w 04-07-02 15:35:28 EST EAGLE5 31.6.0
PASS: Command sent to card
;

rlghncxa03w 04-07-02 15:35:28 EST EAGLE5 31.6.0
CONNMGR: command being processed
;

rlghncxa03w 04-07-02 15:35:28 EST EAGLE5 31.6.0
CONNMGR: Connection Manager Event Log
04-07-03 13:17:40.730 conn-rcvd 5005 from 192.168.100.174:5005
04-07-03 13:17:40.735 conn-rfsd lnk-not-actv 5005 192.168.100.174
04-07-03 13:17:40.850 conn-rcvd 5006 from 192.168.100.174:5006
04-07-03 13:17:40.855 conn-rfsd lnk-not-actv 5006 192.168.100.174
04-07-03 13:17:40.910 conn-rcvd 5002 from 192.168.100.174:5002
04-07-03 13:17:40.915 conn-rfsd lnk-not-actv 5002 192.168.100.174
04-07-03 13:17:40.950 conn-rcvd 5004 from 192.168.100.174:5004
04-07-03 13:17:40.955 conn-rfsd lnk-not-actv 5004 192.168.100.174
;

CONNMGR command complete
;
```

**pass:loc=1103:cmd="connmgr -l"**

```
Command Accepted - Processing

    rlghncxa03w 04-07-02 15:35:28 EST  EAGLE5 31.6.0
    pass:loc=1103:cmd="connmgr -l"
    Command entered at terminal #4.
;
    rlghncxa03w 04-07-02 15:35:28 EST  EAGLE5 31.6.0
    PASS: Command sent to card
;
    rlghncxa03w 04-07-02 15:35:28 EST  EAGLE5 31.6.0
    CONNMGR: command being processed
;
    rlghncxa03w 04-07-02 15:35:28 EST  EAGLE5 31.6.0
    CONNMGR: Connection Manager Event Log
    00-01-13 13:17:40.170 sock-add  ip11103
    00-01-13 13:17:40.885 lnk-act   Port A
    00-01-13 13:17:40.080 conn-made ip11101

    CONNMGR command complete
;
```

The following example displays output when a remote host mismatch occurs.

**pass:loc=1107:cmd="connmgr -l"**

```
Command Accepted - Processing

    eagle10110 09-05-15 16:09:24 EST  EAGLE 41.0.0
    pass:loc=1304:cmd="connmgr -d"
    Command entered at terminal #3.
;
    eagle10110 09-05-15 16:09:24 EST  EAGLE 41.0.0
    PASS: Command sent to card
;
    eagle10110 09-05-15 16:09:24 EST  EAGLE 41.0.0
    CONNMGR: Connection Manager Event Log

    07-05-03 13:17:40.730 conn-rcvd  5005 from 192.168.100.174:5005
    07-05-03 13:17:40.735 conn-rfsd  lnk-not-actv  5005 192.168.100.174
    07-05-03 13:17:40.950 conn-rcvd  5004 from 192.168.100.174:5004
    07-05-03 13:17:40.955 conn-rfsd  host-unreslvd 5004 192.168.100.174
    07-05-03 13:17:40.960 conn-rcvd  5003 from 192.168.100.174:5003
    07-05-03 13:17:40.965 conn-rfsd  host-mismatch 5003 192.168.100.174

    CONNMGR: command complete
```

**pass:loc=1301:cmd="connmgr -n"**

Command Accepted - Processing

```
eagle10213 04-07-22 08:50:04 GMT EAGLE5 31.6.0
pass:loc=1301:cmd="connmgr -n"
Command entered at terminal #4.
```

;

```
eagle10213 04-07-22 08:50:04 GMT EAGLE5 31.6.0
PASS: Command sent to card
```

;

```
eagle10213 04-07-22 08:50:04 GMT EAGLE5 31.6.0
```

```
CONNMGR command being processed
```

;

```
eagle10213 04-07-22 08:50:04 GMT EAGLE5 31.6.0
CONNMGR: Connection Manager SCTP Notification Log
04-07-21 18:06:34.860 assoc-up   ipl1301a from 192.168.110.17:1301
04-07-21 18:06:49.620 assoc-up   ipl1301b from 192.168.110.18:1303
04-07-21 18:07:54.185 assoc-down ipl1301b from 192.168.110.18:1303
04-07-21 18:09:21.990 assoc-up   ipl1301b from 192.168.110.18:1303
```

```
CONNMGR command complete
```

;

**pass:loc=1107:cmd="connmgr -r"**

Command Accepted - Processing

```
rlghncxa03w 04-07-02 15:36:18 EST  EAGLE5 31.6.0
pass:loc=1107:cmd="connmgr -r"
Command entered at terminal #1.
```

;

```
rlghncxa03w 04-07-02 15:36:18 EST  EAGLE5 31.6.0
PASS: Command sent to card
```

;

```
rlghncxa03w 04-07-02 15:36:18 EST  EAGLE5 31.6.0
CONNMGR: command being processed
```

;

```
rlghncxa03w 04-07-02 15:36:18 EST  EAGLE5 31.6.0
CONNMGR command complete
```

;



pass:loc=1107:cmd="connmgr -s"

Command Accepted - Processing

```

rlghncxa03w 04-07-02 15:39:54 EST EAGLE5 31.6.0
pass:loc=1107:cmd="connmgr -s"
Command entered at terminal #1.
;
rlghncxa03w 04-07-02 15:39:54 EST EAGLE5 31.6.0
PASS: Command sent to card
;
rlghncxa03w 04-07-02 15:40:02 EST EAGLE5 31.6.0
CONNMGR: command being processed
;
rlghncxa03w 04-07-02 15:40:03 EST EAGLE5 31.6.0
CONNMGR: Connection Manager Server Data
task_id server state lport cfg opn cn_grntd cn_rfsd
-----
0114FEE8 listening 5001 1 1 2 546
0114ED40 listening 5002 1 1 2 434
0114DB98 listening 5003 1 1 2 539
0114C9F0 listening 5004 1 1 2 542
0114B848 listening 5005 1 1 2 539
0114A6A0 listening 5006 1 1 2 549
011494F8 listening 5007 1 0 0 548
01148350 listening 5008 1 1 2 560
011471A8 listening 5009 1 1 2 523
01146000 listening 5010 1 1 2 532
01144E58 listening 5011 1 1 2 534
01143CB0 listening 5012 1 1 2 481
01142B08 listening 5013 1 1 2 474
01141960 listening 5014 1 1 2 521
011407B8 listening 5015 1 0 2 515
0113F610 listening 5016 5 0 14 2741
0113E468 listening 5017 5 0 11 2723

CONNMGR command complete
;

```

```
pass:loc=1103:cmd="connmgr -s"
```

```
Command Accepted - Processing

    rlghncxa03w 04-07-02 15:39:54 EST  EAGLE5 31.6.0
    pass:loc=1103:cmd="connmgr -s"
    Command entered at terminal #4.
;
    rlghncxa03w 04-07-02 15:39:54 EST  EAGLE5 31.6.0
    PASS: Command sent to card
;
    rlghncxa03w 04-07-02 15:40:02 EST  EAGLE5 31.6.0
    CONNMGR: command being processed
;
    rlghncxa03w 04-07-02 15:40:03 EST  EAGLE5 31.6.0
    CONNMGR: Connection Manager Server Data
    task_id  server state slk lport cfg  opn  cn_grntd  cn_rfsd
    -----
;
    CONNMGR command complete
;
```

## ftptest

## FTP Test

Use this command to send a test file to a configured FTP server that is used for the Measurements Platform feature

**Keyword:** **ftptest**

**Command Class:** System Maintenance

### Options

Options and option parameters that are underlined indicate that a value must be specified for that option or parameter. For example, the **ftptest** command option **-a** has the parameter appl. The FTP registered application to be tested can be specified, as in the command **ftptest -a meas**. Do not enter the underlined option or parameter; enter a value for the information represented by the underlined option or parameter.

#### **-h**

This option provides help information for the command.

#### **-a appl**

This option specifies the FTP registered application to be tested.

#### **Range: meas**

**meas**—The Measurements Platform application

### Example

```
ftptest
```

```
ftptest -h
```

```
ftptest -a meas
```

### Dependencies

None

### Notes

The **ftptest** command is executed through the **pass** command.

The specified card location must have an IP port configured to an FTP server using the **ent-ftp-serv** command, and the card must have its IP port configured using the **chg-ip-lnk** command.

### Output

```
pass:loc=1105:cmd="ftptest-h"
```

or

```
pass:loc=1105:cmd="ftptest"
```

```
Command Accepted - Processing
```

```
rlghncxa03w 04-07-29 11:31:09 EST EAGLE5 31.6.0
pass:loc=1215:cmd="ftptest -h"
Command entered at terminal #3.
```

```
;
```

```
rlghncxa03w 04-07-29 11:31:09 EST EAGLE5 31.6.0
PASS: Command sent to card
```

```
;
```

```
rlghncxa03w 04-07-29 11:31:09 EST EAGLE5 31.6.0
```

```
Usage: ftptest -a appl [-h]
```

```
Options:
```

```
-a appl  FTP client application name
-h       Displays this message
```

```
;
```

```
rlghncxa03w 04-07-29 11:31:09 EST EAGLE5 31.6.0
```

```
FTPTEST: Command Complete
```

```
;
```

```
pass:loc=1105:cmd="ftptest -a meas"
```

```
PASS: Command sent to card
```

```
;
```

```
rlghncxa03w 04-07-29 11:31:09 EST EAGLE5 31.6.0
```

```
FTPTEST: Command In Progress
```

```
;
```

```
rlghncxa03w 04-07-29 11:31:09 EST EAGLE5 31.6.0
```

```
FTP Interface Test
Test Results: PASS
Server IP:    10.25.61.71
FTP Error:    0
File Error:   0
Segment:      190004a2
Diag Msg:
```

```
FTPTEST: Command Complete
```

```
;
```

The following example shows the error occurs if the wrong password is specified in the **ent-ftp-serv** command for the application specified in the **ftptest** command.

**pass:loc=1215:cmd="ftpctest -a meas"**

```

rlghncxa03w 04-07-29 11:31:09 EST  EAGLE5 31.6.0
PASS: Command sent to card
;

rlghncxa03w 04-07-29 11:31:09 EST  EAGLE5 31.6.0

FTPTEST: Command In Progress

;

rlghncxa03w 04-07-29 11:31:09 EST  EAGLE5 31.6.0
FTP Interface Test
  Test Results: FAIL
  Server IP:    0.0.0.0
  FTP Error:   530
  Segment:     190004dd
  Diag Msg:    Server Connection Error

FTPTEST: Command Complete

;

```

## linkinfo

## Link State and Event Log

This command is used to display the state of a signaling link and to retrieve/clear a specified event log for a signaling link. The signaling link is any valid signaling link provisioned for the card. For IPLIMx cards, the following signaling links are supported: **a, a1, a2, a3, b, b1, b2, or b3**. For the IPSPG cards, the following signaling links are supported: **a:a15-b:b15**

**Keyword:** linkinfo

**Command Class:** Application Maintenance

### Options

Options and option parameters that are underlined indicate that a value must be specified for that option or parameter. For example, the **linkinfo** command option **-i** has the parameter event. The event to be included in the report can be specified, as in the command **linkinfo a -a -i m2pa**. Do not enter the underlined option or parameter; enter a value for the information represented by the underlined option or parameter.

#### **-h**

This option provides help information for the command.

#### **port**

This option specifies the signaling link port.

**Range:** a, b, a1, b1, a2, b2, a3, b3

#### **-a**

This option displays the adapter layer interface (ALI) log for the specified signaling link. For M3UA associations the **link -a** option is used to display the UA event log. This command logs information on an association basis. The **link** parameter is used to obtain this report on IPSPG instead of the association name. This information is currently provided by the ualog command on IPGWx cards.

#### **-c**

This option displays congestion tuning parameters for M3UA and M2PA links. The report is enhanced to include card level congestion thresholds and the high-water mark for IPSPG cards.

#### **-i event**

This option includes (does not filter) a link event in the log. For IPSP cards, this option may be used to include or exclude events for the ali and link logs. Valid events for the ALI event log are **ua, service**

**Range:** **ali, all, data, l2l3, l3l2, m2pa, state, ua, service**

**all**—include all events

**-l**

This option displays the IPLIM ALI event log for the specified signaling link

**-m**

This option displays acknowledgment times on an M2PA connection (minimum, maximum, weighted average, last recorded). For IPSP cards, this measurement is supported for only IPSP-M2PA links.

**-r**

This option resets (clears) the event log for the specified signaling link. This option is valid only with the **-a** option or **-l** option.

**-s**

This option displays the state information for the specified signaling link. For the IPSP cards, this option is enhanced to display M3UA signaling link status.

**-v**

This option displays the link event filter configuration.

**-x event**

This option excludes (filters) a link event in the log. For IPSP cards, this option may be used to include or exclude events for the ali and link logs. Valid events for the ALI event log are **ua, service**

**Range:** **ali, all, data, l2l3, l3l2, m2pa, state, ua, service**

**all**—exclude all events

### Example

Provide help information for the command.

```
pass:loc=1301:cmd="linkinfo -h"
```

Set the filter to include ua events in the ua log report.

```
pass:loc=1304:cmd="linkinfo a -i ua"
```

Set the filter to include service events in the ua log report.

```
pass:loc=1304:cmd="linkinfo a -i service"
```

Display the ua log report for signaling link a.

```
pass:loc=1304:cmd="linkinfo a -a"
```

Display the ALI event log for signaling link a1.

```
pass:loc=1301:cmd="linkinfo a1 -a"
```

Display the IPLIM application event log for signaling link a1.

```
pass:loc=1301:cmd="linkinfo a1 -l"
```

Reset/clear the link event log for signaling link a1.

```
pass:loc=1301:cmd="linkinfo a1 -l -r"
```

Clear the ua log report for signaling link a.

```
pass:loc=1304:cmd="linkinfo a -a -r"
```

Display the state information for signaling link a1.

**pass:loc=1301:cmd="linkinfo a1 -s"**

Display acknowledgement times for an M2PA connection on signaling link **b1**.

**pass:loc=3315:cmd="linkinfo b1 -m"**

Display congestion tuning information for an IPSPG-M3UA signaling link.

**pass:loc=1301:cmd="linkinfo a -c "**

## Dependencies

None

## Notes

None

## Output

Example of help for using the command:

**pass:loc=1301:cmd="linkinfo" or**

**pass:loc=1301:cmd="linkinfo -h"**

```

rlghncxa03w 04-07-29 11:31:09 EST  EAGLE5 31.6.0

PASS: Command sent to card
;

rlghncxa03w 04-07-29 11:31:09 EST  EAGLE5 31.6.0

Usage: LINKINFO port [-a [-r]] [-h] [-l [-r]] [-m [-r]] [-s] [-v]
Options:

link      Signaling link port: a, b, a1, b1, a2, b2, a3, b3
-a        Display the ALI event log for a signaling link
-c        Display Congestion Tuning Information for a signaling link
-h        Displays this message
-i event  Include (do not filter) a link event type in the log
           where 'event' is: ali, all, data, l2l3, l3l2,
                           m2pa, state
-l        Displays the event log for a signaling link
-m        Display Link Measurements
-r        Resets the specified event log for a signaling link
-s        Displays the state information for a signaling link
-v        View the link event filter configuration
-x event  Exclude (filter) a link event type from the log
           where 'event' is: ali, all, data, l2l3, l3l2,
                           m2pa, state
;

rlghncxa03w 04-07-29 11:31:09 EST  EAGLE5 31.6.0

LINKINFO command complete
;

```

The following example illustrates a request to display the adapter layer interface (ALI) event log for signaling link **a1** and association **ipl1301a** that has been provisioned with signaling link **a1**.

**pass:loc=1301:cmd="linkinfo a1 -a"**

```

rlghncxa03w 04-07-29 11:31:09 EST EAGLE5 31.6.0
PASS: Command sent to card
;

rlghncxa03w 04-07-29 11:31:09 EST EAGLE5 31.6.0

LINKINFO command being processed

;

rlghncxa03w 04-07-29 11:31:09 EST EAGLE5 31.6.0
IPLIM Adapter Layer Events for Port a1:
04-07-29 10:23:48.525 IP_CONN_OPENED
04-07-29 10:36:09.465 IP_CONN_CONNECTED
04-07-29 10:36:09.465 IP_CONN_ALLOWED

end of report

;

```

The following example illustrates a request to display the **iplim** ALI event log for signaling link **a1** and the association **ipl1301a** that has been provisioned with signaling link **a1**.

**pass:loc=1301:cmd="linkinfo a1 -l"**

```

rlghncxa03w 04-07-29 11:31:09 EST EAGLE5 31.6.0
PASS: Command sent to card
;

rlghncxa03w 04-07-29 11:31:09 EST EAGLE5 31.6.0

LINKINFO command being processed

;

rlghncxa03w 04-07-29 11:31:09 EST EAGLE5 31.6.0
IPLIM Adapter Layer Events for Port a1:
04-07-29 10:36:40.240 IP_CONN_ALLOWED
04-07-29 10:36:40.240 IP_CONN_OPENED
04-07-29 10:36:40.240 LINK_STATE_OOS
04-07-29 10:36:50.935 L3_L2_START
04-07-29 10:37:18.890 IP_CONN_CONNECTED
04-07-29 10:37:18.900 LINK_STATE_AIP
04-07-29 10:37:18.900 M2PA_LSA_RCVD
04-07-29 10:37:18.915 LINK_STATE_PROVING
04-07-29 10:37:18.915 M2PA_LSPN_RCVD
04-07-29 10:37:19.453 M2PA_T4_EXPD
04-07-29 10:37:20.565 M2PA_LSPN_RCVD
04-07-29 10:37:21.785 M2PA_T4_EXPD
04-07-29 10:37:22.565 M2PA_LSPN_RCVD
04-07-29 10:37:23.785 M2PA_T4_EXPD
04-07-29 10:37:24.565 M2PA_LSPN_RCVD
04-07-29 10:37:25.785 M2PA_T4_EXPD
04-07-29 10:37:26.385 M2PA_LSPN_RCVD
04-07-29 10:37:27.576 M2PA_T2_EXPD
04-07-29 10:37:27.585 LINK_STATE_READY
04-07-29 10:37:30.123 M2PA_LSR_RCVD
04-07-29 10:36:32.095 LINK_STATE_INS

end of report

;

```

The following example illustrates a **linkinfo** request to reset/clear the link event log for signaling link **a1**

**pass:loc=1301:cmd="linkinfo a1 -l -r"**

```

rlghncxa03w 04-07-29 11:31:09 EST  EAGLE5 31.6.0
PASS: Command sent to card
;

rlghncxa03w 04-07-29 11:31:09 EST  EAGLE5 31.6.0

LINKINFO command being processed

;

rlghncxa03w 04-07-29 11:31:09 EST  EAGLE5 31.6.0
LINKINFO command complete

;

```

The following example illustrates a **linkinfo** request to display acknowledgement times for an IPLIMx M2PA connection on signaling link **b1**.

**pass:loc=1301:cmd="linkinfo b1 -m"**

```

rlghncxa03w 04-07-29 11:31:09 EST  EAGLE5 31.6.0
PASS: Command sent to card
;

rlghncxa03w 04-07-29 11:31:09 EST  EAGLE5 31.6.0

LINKINFO: Command In Progress

;

rlghncxa03w 04-07-29 11:31:09 EST  EAGLE5 31.6.0
IPLIMx M2PA Measurements Information for Port B1

Measured M2PA Traffic Acknowledgement Times

    Minimum acknowledge time      : 14
    Maximum acknowledge time      : 35
    Weighted Average acknowledge time: 17
    Last recorded acknowledge time : 20

end of report

;

rlghncxa03w 04-07-29 11:31:09 EST  EAGLE5 31.6.0
;

```

The following example illustrates a **linkinfo** request to display the state information for signaling link **a1**.



**pass:loc=1301:cmd="linkinfo a1 -s"**

```

rlghncxa03w 03-07-29 11:31:09 EST  EAGLE5 30.0.0
PASS: Command sent to card
;

rlghncxa03w 03-07-29 11:31:09 EST  EAGLE5 30.0.0

LINKINFO command being processed
;

rlghncxa03w 03-07-29 11:31:09 EST  EAGLE5 30.0.0
SLK      LINKINFO STATE
1301,A1  OOS      CONNECTING

end of report
;

rlghncxa03w 03-07-29 11:31:09 EST  EAGLE5 30.0.0
LINKINFO command complete
;

```

#### Output for IPSP Card

The following example illustrates a **linkinfo** request to display the signaling link event log for an IPSP-M3UA link.

**pass:loc=1304:cmd="linkinfo a -l"**

```

Command Accepted - Processing

eagle10110 08-01-16 16:52:59 EST  EAGLE 38.0.0
pass:loc=1304:cmd="linkinfo a -l"
Command entered at terminal #3.
;

eagle10110 08-01-16 16:52:59 EST  EAGLE 38.0.0
PASS: Command sent to card
;

eagle10110 08-01-16 16:52:59 EST  EAGLE 38.0.0

IP7 Layer 2 Link Events for Link A

08-01-16 15:03:37.080 LINK_STATE_INHIBITED
08-01-16 15:05:23.510 L3_L2_EMERGENCY_CEASE
08-01-16 15:05:23.510 L3_L2_START
08-01-16 15:05:23.510 LINK_STATE_NOT_ALIGNED
08-01-16 15:53:02.660 ASP_UP
08-01-16 15:53:02.660 LINK_STATE_ALIGNED_READY
08-01-16 16:19:45.755 ASP_ACTIVE
08-01-16 16:19:45.755 LINK_STATE_INS
08-01-16 16:19:45.755 L2_L3_IN_SERVICE
08-01-16 16:19:45.780 L3_L2_LINKSET_ALLOWED

end of report
;

```

The following example illustrates a **linkinfo** request to display the signaling link event for an IPSP-M2PA link.

**pass:loc=1314:cmd="linkinfo b2 -l"**

```
eagle10110 08-01-16 16:46:05 EST EAGLE 38.0.0
```

```
IP7 Layer 2 Link Events for Link B2
```

```
08-01-16 16:45:26.050 L3_L2_START
08-01-16 16:45:26.050 L2_L3_OUT_OF_SERVICE
08-01-16 16:45:26.060 RETRIEVAL_COMPLETE
08-01-16 16:45:26.860 L3_L2_EMERGENCY
08-01-16 16:45:26.860 L3_L2_START
08-01-16 16:45:26.860 L2_L3_OUT_OF_SERVICE
08-01-16 16:45:26.870 RETRIEVAL_COMPLETE
08-01-16 16:45:27.215 IP_CONN_OPENED
08-01-16 16:45:27.215 LINK_STATE_CONNECTING
08-01-16 16:45:27.215 IP_CONN_ALLOWED
08-01-16 16:45:27.225 IP_CONN_CONNECTED
08-01-16 16:45:27.225 M2PA_LSO_TRANSMITTED
08-01-16 16:45:27.225 LINK_STATE_CONNECTED
08-01-16 16:45:27.230 M2PA_LSO_RECEIVED
08-01-16 16:45:27.670 L3_L2_EMERGENCY
08-01-16 16:45:27.670 L3_L2_START
08-01-16 16:45:27.670 M2PA_LSA_TRANSMITTED
08-01-16 16:45:27.670 LINK_STATE_NOT_ALIGNED
08-01-16 16:45:27.680 M2PA_LSA_RECEIVED
08-01-16 16:45:27.680 M2PA_LSPE_TRANSMITTED
08-01-16 16:45:27.680 LINK_STATE_ALIGNED
08-01-16 16:45:27.685 M2PA_LSPE_RECEIVED
08-01-16 16:45:27.685 LINK_STATE_PROVING
08-01-16 16:45:27.890 M2PA_T16_EXPIRED
08-01-16 16:45:28.085 M2PA_T16_EXPIRED
08-01-16 16:45:28.185 M2PA_T4_EXPIRED
08-01-16 16:45:28.185 M2PA_LSR_TRANSMITTED
08-01-16 16:45:28.185 LINK_STATE_ALIGNED_READY
08-01-16 16:45:28.195 M2PA_LSR_RECEIVED
08-01-16 16:45:28.195 L2_L3_IN_SERVICE
08-01-16 16:45:28.195 M2PA_LSR_TRANSMITTED
08-01-16 16:45:28.195 LINK_STATE_INS
08-01-16 16:45:28.200 M2PA_LSR_RECEIVED
```

```
end of report
```

```
;
```

```
eagle10110 08-01-16 16:46:05 EST EAGLE 38.0.0
```

```
LINKINFO: Command Complete
```

```
;
```

The following example illustrates a **linkinfo** request to set the filter to include ua events in the ua log report for signaling link a.

**pass:loc=1304:cmd="linkinfo a -i ua"**

```
rlghncxa03w 08-01-29 11:31:09 EST EAGLE 38.0.0
```

```
Link event type (ua) is logged for link A
```

```
end of report
```

```
;
```

The following example illustrates a **linkinfo** request to set the filter to include service events in the ua log report for signaling link a.

**pass:loc=1304:cmd="linkinfo a -i service"**

```
rlghncxa03w 08-01-29 11:31:09 EST EAGLE 38.0.0

Link event type (service) is logged for link A

end of report
```

;

The following example illustrates a **linkinfo** request to display the ua log report for signaling link **a**.

**pass:loc=1304:cmd="linkinfo a -a"**

```
rlghncxa03w 08-01-29 11:31:09 EST EAGLE 38.0.0

Adapter Layer Events for Link A

UALOG: UA event history log
       UA Version: 01
       ASP ID: undefined
       User Adapter Implemented: M3UA RFC
       Current settings: -i service ua

Date      Time          Event
-----
08-01-16  15:51:45.890    IP Conn Established
08-01-16  15:51:45.890    Transition to SERVER_DOWN
              (RC=0000000004)
08-01-16  15:53:02.660    ASPUP PDU Received (ASP ID=undefined)
08-01-16  15:53:02.660    Transition to SERVER_INACTIVE
              (RC=0000000004)
08-01-16  15:53:02.660    ASP to SLK Up
08-01-16  15:53:02.660    Link Activated
08-01-16  15:53:02.660    ASPUPACK PDU Transmitted
08-01-16  15:53:02.660    AS INACTIVE NTFY PDU Transmitted (RC=0000000004)
08-01-16  16:19:45.755    ASPACTIVE PDU Received (RC=none)
08-01-16  16:19:45.755    ASPACTIVEACK PDU Transmitted (RC=0000000004)
08-01-16  16:19:45.755    Transition to SERVER_ACTIVE    LOADSHARE
              (RC=0000000004)
08-01-16  16:19:45.755    ASP to SLK Active
08-01-16  16:19:45.780    AS Active
08-01-16  16:19:45.780    AS ACTIVE NTFY PDU Transmitted (RC=0000000004)

end of report
```

;

The following example illustrates a **linkinfo** request to clear the ua log report for signaling link **a**.

**pass:loc=1304:cmd="linkinfo a -a -r"**

```
rlghncxa03w 08-01-29 11:31:09 EST EAGLE 38.0.0

LINKINFO: Command Complete
```

;

The following example illustrates a **linkinfo** request to display the link measurement information for an IPSG-M2PA signaling link.

**pass:loc=1301:cmd="linkinfo b2 -m "**

```
rlghncxa03w 08-01-29 11:31:09 EST EAGLE5 38.0.0
M2PA Measurements Information for Link B2
```

```
Measured M2PA Traffic Acknowledgement Times
```

```
Minimum acknowledge time      : 16
Maximum acknowledge time      : 44
Weighted Average acknowledge time: 16
Last recorded acknowledge time : 16
```

```
end of report
```

```
;
```

The following example illustrates a **linkinfo** request to display state information for an IPSPG-M3UA signaling link.

**pass:loc=1301:cmd="linkinfo a -s "**

```
rlghncxa03w 08-01-29 11:31:09 EST EAGLE 38.0.0
```

```
IP7 Layer 2 Link State Information for Link A
```

```
LINK_STATE_ALIGNED          ASP_STATE_SERVER_DOWN
```

```
end of report
```

```
;
```

The following example illustrates a **linkinfo** request to display state information for an IPSPG-M2PA signaling link.

**pass:loc=1314:cmd="linkinfo b2 -s"**

```
rlghncxa03w 08-01-29 11:31:09 EST EAGLE 38.0.0
```

```
IP7 Layer 2 Link State Information for Link B2
```

```
LINK_STATE_INS              IP_CONN_STATE_ESTABLISHED
```

```
end of report
```

```
;
```

The following example illustrates the **linkinfo** request to display congestion tuning information for an IPSPG-M3UA signaling link.

```
pass:loc=1301:cmd="linkinfo a -c "
```

```
rlghncxa03w 08-01-29 11:31:09 EST EAGLE 38.0.0

Congestion Tuning Information for Link A

High-Water Mark                : 0

High-Water Mark Date & Time : 00-00-00 00:00:00.000

HMCG SLK Congestion Threshold Values

  Danger of Congestion Onset : 240
  Abatement Level-1         : 241
  Onset Level-1             : 480
  Abatement Level-2         : 481
  Discard Level-1           : 600
  Onset Level-2             : 605
  Abatement Level-3         : 606
  Discard Level-2           : 720
  Onset Level-3             : 725
  Discard Level-3           : 840
  Maximum Buffers for L2    : 960

HMCG Card-Level Congestion Threshold Values

  Danger of Congestion Onset : 2500
  Abatement Level-1         : 2501
  Onset Level-1             : 5000
  Abatement Level-2         : 5001
  Discard Level-1           : 7601
  Onset Level-2             : 6251
  Abatement Level-3         : 6252
  Discard Level-2           : 7601
  Onset Level-3             : 7501
  Discard Level-3           : 7601
  Maximum Buffers for L2    : 10000
  High Water Mark           : 0

end of report

;

rlghncxa03w 08-01-29 11:31:09 EST EAGLE 38.0.0

LINKINFO: Command Complete

;
```

The following example illustrates the **linkinfo** request to display congestion tuning information for an IPSPG-M2PA signaling link.

**pass:loc=1301:cmd="linkinfo b2 -c "**

```
rlghncxa03w 08-01-29 11:31:09 EST EAGLE 38.0.0
  Congestion Tuning Information for Link B2
```

```
RETX Queue Depth threshold : 240
```

```
High-Water Mark           : 0
```

```
High-Water Mark Date & Time : 00-00-00 00:00:00.000
```

```
HMCG SLK Congestion Threshold Values
```

```
Danger of Congestion Onset : 120
Abatement Level-1         : 121
Onset Level-1             : 240
Abatement Level-2         : 241
Discard Level-1           : 300
Onset Level-2             : 305
Abatement Level-3         : 306
Discard Level-2           : 360
Onset Level-3             : 365
Discard Level-3           : 420
Maximum Buffers for L2    : 480
```

```
HMCG Card-Level Congestion Threshold Values
```

```
Danger of Congestion Onset : 2500
Abatement Level-1         : 2501
Onset Level-1             : 5000
Abatement Level-2         : 5001
Discard Level-1           : 7601
Onset Level-2             : 6251
Abatement Level-3         : 6252
Discard Level-2           : 7601
Onset Level-3             : 7501
Discard Level-3           : 7601
Maximum Buffers for L2    : 10000
High Water Mark           : 2
```

```
end of report
```

```
;
```

```
rlghncxa03w 08-01-29 11:31:09 EST EAGLE 38.0.0
```

```
LINKINFO: Command Complete
```

```
;
```

The following example illustrates a **linkinfo** request to display state information when graceful shutdown has occurred.

```
pass:loc=1305:cmd="linkinfo -a a"
```

```
rlghncxa03w 09-04-29 11:31:09 EST EAGLE 41.0.0
```

```
Adapter Layer Events for Link A
```

```
UALOG: UA event history log
UA Version: 01
ASP ID: undefined
User Adapter Implemented: M3UA RFC
Current settings: -i ua
                  -x service
```

| Date     | Time         | Event                                            |
|----------|--------------|--------------------------------------------------|
| 08-10-08 | 09:29:15.705 | Management IP Conn Close                         |
| 08-10-08 | 09:29:15.705 | Transition to SERVER_SHUTDOWN<br>(RC=0000000002) |
| 08-10-08 | 09:29:15.705 | ASP to SLK Down                                  |
| 08-10-08 | 09:29:15.705 | Link Not Aligned                                 |
| 08-10-08 | 09:29:15.705 | UA Graceful Shutdown                             |
| 08-10-08 | 09:29:15.710 | UA Shutdown Complete                             |
| 08-10-08 | 09:29:15.710 | Transition to IDLE<br>(RC=0000000002)            |

```
end of report
```

## msucount

## Message Signaling Unit (MSU) Count

This command is used to report the count of SS7 MSUs and bytes that pass through links, routing keys, and IP connections. These counts can be reported and reset at the same time to get accurate counts for longer periods of time. In addition to MSUs transmitted and received, the **msucount** command also reports statistics on packets related to MTP Primitives and on discarded transmit and receive data.

**Keyword:** **msucount**

**Command Class:** Application Maintenance

### Options

Options and option parameters that are underlined indicate that a value must be specified for that option or parameter. For example, the **msucount** command option **-l** has the parameter port. The link for which counts will be displayed can be specified, as in the command **msucount -l a1**. Do not enter the underlined option or parameter; enter a value for the information represented by the underlined option or parameter.

#### **-a**

This option is used to display IP connection statistics for a specific association. When **-a aname** is specified on the same line as **-k rtkey**, the output is assumed to be routing key output. When **-a aname** is specified on the command line without **-k rtkey**, association statistics output is generated. For IPSPG cards, this option is enhanced to include receive and transmit counts for M3UA SSNMs (DAUD messages and M3UA SSNM PDUs) and replicated M3UA PDUs.

#### **-b**

This option is used to display signaling link bytes statistics. The signaling link bytes report displays data for measurements on a per-signaling-link basis for both the transmit and receive directions. The report can display link statistics for a specified signaling link number. If a link is not specified, the report displays link statistics for signaling link A for IPGWx cards and for all equipped signaling

links for IPLIMx and IPSPG cards. If a signaling link is valid for the card and application type, but is unequipped, then the report displays all zeros.

**-h**

This option is used to provide help information for the command.

**-d**

This option is used to report dynamic routing keys (IPGWx application only). This option is not supported for the IPSPG application.

**Default: Static**

**-f**

This option is used to display a full report (IPGWx application only).

**-k rtkey**

This option is used to specify the routing key for which the counts will be displayed. The routing key is specified as a single parameter with up to five colon-separated fields. The subsystem is not specified when SI is not equal to 3.

This option is not supported for the IPSPG cards.

The **-p** modifier can be specified to identify the point code type of the routing key that follows the **-k** option in the command.

The **rtkey** variable is optional when used with **-t default**, and mandatory for all other cases.

If the same routing key exists as both a static and dynamic routing key, the **-k** option will report the counts associated with the dynamic entry in the Routing Key table only.

The following formats are valid for the routing key that follows the **-k** option in the command:

- n-c-m:s:n—For DPC, SI, SSN type routing keys. The network, cluster and member (*n-c-m*) are in the range **0-255**. The service indicator (*s*) is **3** or **sccp**. The subsystem (*n*) is in the range **0-255**.
- n-c-m:s—For DPC, SI, type routing keys. The network, cluster and member (*n-c-m*) are in the range **0-255**. The service indicator (*s*) is in the range **0-2**, **4**, or **6-15**. There is no subsystem. As a default, counts for all routing keys within the option combination are displayed.
- n-c-m:s:no-co-mo:cs:ce—For DPC, SI, CIC type routing keys. The DPC network, cluster and member (*n-c-m*) are in the range **0-255**. The service indicator (*s*) is **5** or **isup**. There is no subsystem. The OPC network, cluster and member (*no-co-mo*) are in the range **0-255**. The starting circuit identification code (*cs*) and ending circuit identification code (*ce*) are in the range **0** to **16363**.

**-l**

For IPSPG cards, this option displays the link report for all equipped signaling links on the card.

**-l link**

This option is used to display counts for links. The link report optionally allows display of link statistics for a specified port.

The link report contains data, per link, for MSUs (tx/rcv), MSU bytes (tx/rcv), MGMT msgs (tx/rcv), and discarded data (tx/rcv).

For the IPSPG card, the M2PA link report is the same as the IPLIMx M2PA report. The M3UA link report contains an additional detail line for non-discard pegs for SS7 SNM and Replicated M3UA PDU counts.

**Range: a, b, a1, b1, a2, b2, a3, b3 a:a15-b:b15**

Ports **a1**, **b1**, **a2**, **b2**, **a3**, and **b3** are allowed only on SSEDCEM IPLIMx cards.

If a port is not specified, **msucount** displays link statistics for port **a** for IPGWx links, and port **a** and port **b** for IPLIMx links.

The **msucount** link statistics report contains all zeros for a port that is valid for the card and application type but is unequipped.



The range a:a15-b:b15 is valid for IPSP cards.

**-l**

link -f

This option displays the full link report. For IPSP-M2PA links, this option displays the same report as the **-l <link>** option. For IPSP-M3UA links the report includes the data from the **-l <link>** report and includes an additional detail line displaying tx/rx discards counts and discard data.

**-p point code type**

This option modifier can be specified along with the **-k** option to identify the point code type (ANSI, ITU international, ITU-national, 24-bit ITU national, ITU international spare, and ITU national spare) in the routing key that follows the **-k** option in the command.

**Range:** ansi, itui, itun, itun24, ituis, ituns

**-r**

This option is used with other options to reset counts at the same time of reporting them.

**-s name**

This option is used to display socket reports for the specified IP connection. This option is not supported for IPSP cards.

**Range:**

Up to 15 alphanumeric characters

**Default:** Counts for all IP connections within the option combination

**-t keytype**

This option is used to display the routing key type (IPGWx only).

**-x**

The routing context is an index that uniquely defines a routing key associated with an SUA or M3UA AS. For the IPSP card, the option displays a link report for all signaling links on the card that are members of the linkset that contains the specified routing context value (equivalent to the **msucount -lreport -x** option is used as an alternative to the **-k** option to identify the routing key by specifying its routing context in the command line.

**NOTE: The -x rc option can only be used to specify routing keys containing M3UA/SUA associations.**

**Example**

Link counts only. Displays brief count for signaling link a for IPGWx. Displays counts for all equipped signaling links for IPLIMx.

**msucount -l**

Link counts only, for signaling link port a1.

**msucount -l a1**

Full/detail report for signaling link a for IPGWx.

**msucount -l -f**

Counts for the specified socket only.

**msucount -s socyellow**

Counts for the specified association only.

**msucount -a association name**

Counts for first matching routing key

**msucount -k 10-10-10:3:16**

Counts for matching dynamic routing key

**msucount -k 10-10-10:3:16 -d**

Counts for the routing key report using the routing context.

**msucount -x 5**

Counts for the first matching routing key and an associated socket

**msucount -s socket name -k rtkey**

Counts for first matching routing key and an associated association.

**msucount -a association name -k rtkey**

Counts for the default routing key

**msucount -k -t default**

Counts for a matching partial routing key.

**msucount -k 3-3-3 -t partial**

Counts for counts for link only. Displays brief report for signaling link a for IPGWx. Displays counts for all equipped signaling links for IPLIMx.

**msucount**

Full/detail report for signaling link A for IPGWx.

**msucount -h full**

Resets the signaling link count measurements.

**msucount -r**

Brief version of help text.

**msucount -h**

Full version of help text.

**msucount -h full**

Counts for link and first matching routing key

**msucount -b**

Byte report for signaling link A for IPGWx cards. Byte report for all equipped signaling links for IPLIMx cards.

**msucount -b -link**

Byte report for specified signaling link.

**msucount -l -k 10-10-10:3:16**

Counts for first matching routing key and an associated IP connection

**msucount -s socyellow -k 10-10-10:3:16**

Use with other parameters to display and reset counts. Valid with the above combinations.

**msucount -l -r**

**msucount -r**

**msucount -s sock1 -r**

**msucount -x 5 -r**

The following examples provide a correct syntax to specify partial or default keys, or to specify a key by routing context.

```
pass:loc=1105:cmd="msucount -k 5-5-1:5:6-6-6 -t partial
```

```
pass:loc=1105:cmd="msucount -k 5-5-1:5 -t partial"
```

```
pass:loc=1105:cmd="msucount -k 5-5-1:3 -t partial
```

```
pass:loc=1105:cmd="msucount -p ITUI -t partial -k 1-235-1"
```

```
pass:loc=1105:cmd="msucount -p ITUN -t partial -k 2351"
```

```
pass:loc=1105:cmd="msucount -p ITUN -t partial -k 2351-gr
```

```
pass:loc=1105:cmd="msucount -t partial -k :2 "
```

```
pass:loc=1105:cmd="msucount -k -t default"
```

```
pass:loc=1105:cmd="msucount -d -k -t default "
```

```
pass:loc=1105:cmd="msucount -p ITUN24 -t partial -k 10-235-1"
```

```
pass:loc=1105:cmd="msucount -p ITUN24 -t partial -k 10-235-1"
```

Examples of other valid routing key inputs:

```
pass:loc=1105:cmd="msucount -r -k 5-5-6:5:5-5-7:1:1000"
```

```
pass:loc=1105:cmd="msucount -r -p ITUI -k 5-5-6:4:5-5-7:1:1000"
```

```
pass:loc=1105:cmd="msucount -r -p ITUI -k 5-5-6:5:5-5-7:1:1000"
```

```
pass:loc=1105:cmd="msucount -p ITUI -k 5-5-1:3:5 -s c7000 -r"
```

```
pass:loc=1105:cmd="msucount -r -s c7050 -p ITUN -k 2860:3:5 -l"
```

```
pass:loc=1105:cmd="msucount -k 5-5-1:3:5 -a assoc1"
```

```
pass:loc=1105:cmd="msucount -p ITUN -k 3838:3:5 -s c7000"
```

```
pass:loc=1105:cmd="msucount -p ITUI -k 1-34-4:3:105 -s c7001"
```

```
pass:loc=1105:cmd="msucount -r -p ITUN24 -k 15-105-16:5:15-105-17:1:1000"
```

**Dependencies**

At least one option must be specified.

**Notes**

The **msucount** command is executed through the **pass** command.

Combinations of the **-l**, **-a**, **-s**, **-k**, **-t**, **-x** and **-b** options provide count information based on the entered combination.

If no parameters are specified, then the **-l** brief report is output.

Multiple reports are not supported with the IP Signaling Serviceability feature.

For the SS7IPGW and IPGWI GPLs, 4 types of reports can be generated: the link report, the routing key report, the IP connection statistics report, and the signaling link bytes report. For the IPLIM/ IPLIMI card, the routing key report is not supported.

The 4 reports are the following:

1. The link report (**-l** option) contains statistics per link—data about MSUs (transmit/receive), MSU bytes (transmit/receive), MGMT messages (transmit/receive), and discarded data (transmit/receive).
2. The routing key report (**-k** option) contains statistics for a specific routing key—data about MSUs (transmit), MSU bytes (transmit), and discards on the transmit path for the routing key. A list of one or more IP connections associated with the routing key, with the MSU and MSU bytes counts for each connection, is also displayed. If **-s sname** or **-a aname** is in the same input command with **-k rtkey**, only the connection association data for the specified connection is displayed. When **-s sname** and **-a aname** is not specified with **-k rtkey**, all connection associations are listed. If **-x rc** is specified, only the connection association data for the specified routing context is displayed.  
The **-p** (point code type) modifier option can be used with the **-k** option to specify the point code type of the routing key that follows the **-k** option in the command.  
For the **-k** options, the routing key must be an exact match of a routing key that exists in the static or dynamic Routing Key tables. If the same routing key exists in both the static and dynamic Routing Key tables, the **-k** option displays the counts associated with the entry in the dynamic Routing Key table only.
3. The IP connection statistic report (**-s sname** or **-a aname** option) contains statistics for a specified IP connection—data about MSUs (transmit/receive), MSU bytes (transmit/receive), and discarded data (transmit/receive).  
When the **-s sname** or **-a aname** option is specified in the command with the **-k** option, the output type is assumed to be routing key output.  
When the **-s sname** option is specified in the command without the **-k** option, the IP connection statistic report is generated.  
When **-a aname** is specified on the command line without **-k**, association statistics output is generated.
4. The signaling link bytes report (**-b** option) provides the following information for both IPGWx and IPLIMx cards: bytes/sec for the last second, average MSU size during the last second, and maximum one-second average MSU size since card load time or reset. For the IPLIMx cards, the report also provides the following information: sum of bytes/sec for the last second for all signaling link, average MSU size for last second for all signaling links, maximum average MSU size since load time or reset for all signaling links, and maximum MSU size since load time or reset for all signaling links.

The link report, routing key report, and IP connection statistic report (IPGWx only) can display individual transmit MSUs that were discarded at layer 2. The first 32 bytes of the MSU transmit data that is discarded is stored beginning at the SIO bytes. If the MSU is not 32 bytes long, the remaining bytes are set to 0.

The signaling link bytes report optionally allows display of link statistics for a specified signaling link number. If a link is not specified for the bytes report, the *msucount* command displays link statistics for signaling link A for IPGWx cards and for all equipped signaling links for IPLIMx cards.

The signalling link bytes report contains all zeros for a signaling link that is valid for the card and application type but that is unequipped.

The link and IP connection statistics reports can display individual receive packets that were discarded at layer 2. Portions of the TALI packets for the receive MSUs that the SS7IPGW application discards are stored beginning with the 12 bytes of the TALI header., and followed by the service data. If the storage space is larger than the service data, the extra bytes are set to 0. The TALI packet is stored instead of the MSU so that it is not necessary to construct an MTP3 header for packets that are discarded for reasons such as bad link state, bad SCCP message type, no calling or called party, or bad SIO for an ISUP message.

The reset option (-r) resets the specified measurements. This option can be added to any command.

## Output

In the examples that follow, the hexadecimal output for discarded *transmit* data represents data stored beginning at the SIO bytes through the first 32 bytes of the MSU. If the MSU was less than 32 bytes, the remaining bytes are represented by zeros.

Hexadecimal output for discarded *receive* data represents data stored beginning at the TALI header. (A TALI header can have a sync code of either TALI or SASI). This data is used to store portions of the TALI packets for received MSUs that the SS7IPGW APPL layer decides to discard.

Stored *receive* data takes the following format:

First 12 bytes = TALI header.

Bytes 13-x = Service data, beginning with the first byte of service data based on the received TALI operations code. If the storage space is greater than the size of the service data, the remaining bytes are zeroed.

## Output Specific to SS7IPGW and IPGWI

Either brief or full help reports can be displayed. A full help report is generated by adding the **full** (-f) option to the command line.

Example of a brief help report:

**pass:loc=1105:cmd="msucount -h"**

```
Usage: msucount [ [-l [link]] | [-b [link] ] |
                [[-a aname] | [-s sname]]
                [[-x rc] | [-k [rtkey] [-p pctype] [-t keytype] [-d]] ]
                [-f] [-r] [-h [full]]
```

```
Options: -l display signaling link report
         -b display signaling link bytes report
         -a display association report
         -s display socket report
         -x routing key report using routing context
         -k routing key report using MTP3 parameters
           rtkey :: ([dpc][:si][:opc | :ssn][:cics][:cice])
         -p pctype :: (ANSI, ITUI, ITUN, ITUN24, ITUIS, ITUNS)
         -t routing key type
           keytype :: (<full>, partial, default)
         -d display dynamic routing key
         -f display full report
         -r resets the specified counts
         -h display command help (brief or full)
```

Example of a full help report.

**pass:loc=1105:cmd="msucount -h full"**

```
Usage: msucount [ [-l [link]] | [-b [link]] ] |
              [[-a aname] | [-s sname]]
              [[-x rc] | [-k [rtkey] [-p pctype] [-t keytype] [-d]] ]
              [-f] [-r] [-h [full]]
```

```
Options: -l display signaling link report
         -b display signaling link bytes report
         -a display association report
         -s display socket report
         -x routing key report using routing context
         -k routing key report using MTP3 parameters
           rtkey :: ([dpc][:si][:opc | :ssn][:cics][:cice])
         -p pctype :: (ANSI, ITUI, ITUN, ITUN24, ITUIS, ITUNS)
         -t routing key type
           keytype :: (<full>, partial, default)
         -d display dynamic routing key
         -f display full report
         -r resets the specified counts
         -h display command help (brief or full)
```

#### -k option details:

Use the -p option along with -k to specify the SS7 network domain and point code format for the network. The SS7IPGW default pctype is ANSI. The IPGW default pctype is ITUI.

| Network | PC Format | Notes                                  |
|---------|-----------|----------------------------------------|
| ANSI    | N-C-M     |                                        |
| ITUN    | N         | Non-Spare ITU National, no group code  |
| ITUN    | N-GC      | Non-Spare ITU National with group code |
| ITUI    | Z-A-I     | Non-Spare ITU International            |
| ITUN24  | N-C-M     | Non-Spare ITU National, 24-bits        |
| ITUNS   | N         | Spare ITU National, no group code      |
| ITUNS   | N-GC      | Spare ITU National with group code     |
| ITUIS   | Z-A-I     | Spare ITU International                |

Use the -t option along with -k to specify certain MTP3 and user part MSU fields as wildcards for the routing key.

| SS7 Traffic Partition             | RTKEY Parameter       | Example    |
|-----------------------------------|-----------------------|------------|
| Any User Part to DPC 1-1-1        | -k 1-1-1              | -t partial |
| SCCP to DPC 1-1-1                 | -k 1-1-1:3            | -t partial |
| ISUP to DPC 1-1-1                 | -k 1-1-1:5            | -t partial |
| TUP to DPC 1-1-1                  | -k 1-1-1:4            | -t partial |
| QBICC to DPC 1-1-1                | -k 1-1-1:13           | -t partial |
| SI [0-2,6-12,14,15] to DPC 1-1-1  | -k 1-1-1:SI           |            |
| SCCP SSN 5 to DPC 1-1-1           | -k 1-1-1:3:5          |            |
| ISUP to DPC 1-1-1 from OPC 2-2-2  | -k 1-1-1:5:2-2-2      | -t partial |
| TUP to DPC 1-1-1 from OPC 2-2-2   | -k 1-1-1:4:2-2-2      | -t partial |
| QBICC to DPC 1-1-1 from OPC 2-2-2 | -k 1-1-1:13:2-2-2     | -t partial |
| ISUP CIC 1 to 1-1-1 from 2-2-2    | -k 1-1-1:5:2-2-2:1    |            |
| TUP CIC 1 to 1-1-1 from 2-2-2     | -k 1-1-1:4:2-2-2:1    |            |
| QBICC CIC 1 to 1-1-1 from 2-2-2   | -k 1-1-1:13:2-2-2:1   |            |
| ISUP CIC 0-5 to 1-1-1 from 2-2-2  | -k 1-1-1:5:2-2-2:0:5  |            |
| TUP CIC 0-5 to 1-1-1 from 2-2-2   | -k 1-1-1:4:2-2-2:0:5  |            |
| QBICC CIC 0-5 to 1-1-1 from 2-2-2 | -k 1-1-1:13:2-2-2:0:5 |            |
| Default Routing Key               | -k                    | -t default |

A brief version for the link measurement report can be specified for IPGWx. If no parameters are specified for a link measurements report, then a brief report is displayed. The brief report does not display the transmit/receive discard counts.

Example of a brief link measurements report:

**pass:loc=1305:cmd="msucount"**

or

**pass:loc=1305:cmd="msucount -l"**

```

MSUCOUNT: MSU Count Report
-----
Link Measurements (Link A)
-----

Transmit Counts                                Receive Counts
-----
rate  msus      bytes          rate  msus      bytes
-----
2000  4294967295  4294967295    2000  4294967295  4294967295

MTP Primitive (MTPP) counts                    Reroute Counts
-----
sent pdus   rcvd pdus   dscrd pdus   sent msus   rcvd msus
-----
4294967295  4294967295  4294967295   4294967295  4294967295

END of Report

```

Example of a full link measurements report:

**pass:loc=1305:cmd="msucount -f"**

or

**pass:loc=1305:cmd="msucount -l -f"**

MSUCOUNT: MSU Count Report

-----  
 Link Measurements (Link A)  
 -----

Transmit Counts

-----  
 rate msus bytes  
 -----  
 2000 4294967295 4294967295

Receive Counts

-----  
 rate msus bytes  
 -----  
 2000 4294967295 4294967295

MTP Primitive (MTPP) Counts

-----  
 sent pdus rcvd pdus dscrd pdus  
 -----  
 4294967295 4294967295 4294967295

Reroute Counts

-----  
 sent msus rcvd msus  
 -----  
 4294967295 4294967295

Dynamic Rtkey (RKRK) Counts

-----  
 rcvd pdus dscrd pdus updates  
 -----  
 4294967295 4294967295 4294967295

Transmit Discard Counts

-----  
 reason count  
 -----  
 no ss7 rtbl entry 4294967295  
 no ss7 rtkey 4294967295  
 no conn avail to pc 4294967295  
 no conn avail to rtkey 4294967295  
 congested connection 4294967295  
 sccp msg type 4294967295  
 sccp class 4294967295  
 circular rte 4294967295  
 normalization error 4294967295  
 invalid traffic type 4294967295  
 M3UA conversion error 4294967295  
 SUA conversion error 4294967295  
 AS-Pending overflow 4294967295  
 AS timer Tr expiry 4294967295  
 reroute failure 4294967295  
 unexpected for APC 4294967295  
 lrg BICC not supported 4294967295

Receive Discard Counts

-----  
 reason count  
 -----  
 link state 4294967295  
 sccp msg type 4294967295  
 sccp class 4294967295  
 sccp called party 4294967295  
 sccp calling party 4294967295  
 isup sio 4294967295  
 normalization error 4294967295  
 error in XSRV packet 4294967295  
 M3UA PDU error 4294967295  
 SUA PDU error 4294967295  
 invalid rcontext 4294967295  
 lrg BICC not supported 4294967295

Stored Transmit Discard Data

-----  
 83 01 05 05 0a 01 03 bf 09 80 03 08 0d 05 c3 07  
 01 05 05 05 c3 07 0a 01 03 08 e2 06 c7 04 13 10

Stored Receive Discard Data

-----  
 53 41 53 49 73 63 63 70 1a 00 09 01 03 08 0d 05  
 c3 05 0a 01 03 05 c3 05 01 05 05 08 e2 06 c7 04

MSUCOUNT: command complete

;



Example of an output report when all counts are zero:

```
pass:loc=1305:cmd="msucount -f"
```

or

```
pass:loc=1305:cmd="msucount -l -f"
```

```
MSUCOUNT: MSU Count Report
-----
Link Measurements (Link A)
-----
Transmit Counts                                Receive Counts
-----
rate  msus      bytes                                rate  msus      bytes
-----
00000 00000      00000                                00000 00000      00000

MTP Primitive (MTPP) Counts                    Reroute Counts
-----
sent pdus  rcvd pdus  dscrd pdus  sent msus  rcvd msus
-----
00000      00000      00000      00000      00000

Dynamic Rtkey (RKRP) Counts
-----
rcvd pdus  dscrd pdus  updates
-----
00000      00000      00000

Transmit Discard Counts                        Receive Discard Counts
-----
reason                                count                                reason                                count
-----
no transmit discard counts              no receive discard counts

Stored Transmit Discard Data
-----
no stored transmit discard data
Stored Receive Discard Data
-----
no stored receive discard data

MSUCOUNT: command complete
```

## Routing Key Report Output Examples

The routing key report contains data about MSUs (tx), MSU bytes (tx), and discards on the transmit path for the routing key. A list of one or more connections associated with the routing key, with the MSU and MSU bytes counts for each connection, is also presented. If **-s sname** or **-a aname** is in the same input command with **-k rtkey**, only the connection association data for the specified connection is displayed. When **-s sname** and **-a aname** is not specified with **-k rtkey**, all connection associations are listed. If **-x rc** is specified, only the connection association data for the specified routing context is displayed.

**NOTE: For IPGWx, -k rtkey is optional when used with -t default, and mandatory for all other cases.**

The report output itself does not display the routing key that was entered, other than an exact copy of the command line being generated as part of the output. The only indication in the output as to which key was found is the indication as to whether the key was in the dynamic Routing Key table or the static Routing Key table.

Partial routing keys (where some fields in the MSU are ignored with respect to finding a routing key to use for the MSU) and default keys can be specified in the command. The output does not change for these key types; the only difference is the routing key syntax (**-p**, **-d**) that must be processed as part of identifying the partial and default keys. (See the Example section of this command description for syntax examples.)

Example of a routing key report for an ANSI routing key that specifies the dynamic Routing Key table:

**pass:loc=1105:cmd="msucount -k 5-5-1:3: -t partial -d"**

or

**pass:loc=1105:cmd="msucount -k 5-5-1:3 -p ANSI -t partial -d"**

```

MSUCOUNT: MSU Count Report
-----
Routing Key Measurements for Dynamic Routing Key
-----
Transmit Counts
-----
tx bytes                4294967295
tx msus                 4294967295

Transmit Discard Counts
-----
sccp msg type          4294967295
sccp class             4294967295
normalization error    4294967295
invalid traffic type    4294967295

Associated IP Connection      tx bytes      tx msus
-----
c7000                       4294967295    4294967295
c7050                       4294967295    4294967295
c7052                       4294967295    4294967295
c7054                       4294967295    4294967295

Stored Transmit Discard Data
-----
83 01 05 05 0a 01 03 94 09 01 03 08 0d 05 c3 05
01 05 05 05 c3 05 0a 01 03 08 e2 06 c7 04 28 10

MSUCOUNT: command complete

```

;

Example of an ITU-I routing key report (only 1 specific socket association or socket is displayed):

**pass:loc=1105:cmd="msucount -p ITUI -k 5-5-1:3:5 -a c7000"**

or

**pass:loc=1105:cmd="msucount -p ITUI -k 5-5-1:3:5 -s c7000"**

```

MSUCOUNT: MSU Count Report

-----
Routing Key Measurements for Static Routing Key
-----

Transmit Counts
-----
tx bytes:                4294967295
tx msus:                 4294967295

Transmit Discard Counts
-----
sccp msg type           4294967295
sccp class              4294967295
normalization error     4294967295
invalid traffic type    4294967295

Associated IP Connection      tx bytes      tx msus
-----
c7000                        4294967295  4294967295

Stored Transmit Discard Data
-----
83 01 05 05 0a 01 03 94 09 01 03 08 0d 05 c3 05
01 05 05 05 c3 05 0a 01 03 08 e2 06 c7 04 28 10

MSUCOUNT: command complete
;

```

Example of a routing key report when the routing context =5 (because a table is not specified, the key is searched for in the Static table).

**pass:loc=1105:cmd="msucount -x 5"**

MSUCOUNT: MSU Count Report

-----  
 Routing Key Measurements for Static Routing Key  
 -----

Transmit Counts  
 -----

|          |            |
|----------|------------|
| tx bytes | 4294967295 |
| tx msus  | 4294967295 |

Transmit Discard Counts  
 -----

|                      |            |
|----------------------|------------|
| sccp msg type        | 4294967295 |
| sccp class           | 4294967295 |
| normalization error  | 4294967295 |
| invalid traffic type | 4294967295 |

| Associated IP Connection | tx bytes   | tx msus    |
|--------------------------|------------|------------|
| -----                    | -----      | -----      |
| c7000                    | 4294967295 | 4294967295 |
| c7050                    | 4294967295 | 4294967295 |
| c7052                    | 4294967295 | 4294967295 |
| c7054                    | 4294967295 | 4294967295 |

Stored Transmit Discard Data  
 -----

```
83 01 05 05 0a 01 03 94 09 01 03 08 0d 05 c3 05
01 05 05 05 c3 05 0a 01 03 08 e2 06 c7 04 28 10
```

MSUCOUNT: command complete

;

Example of an ITU-N routing key report:

- Command when the ITUDUPPC feature is OFF (default)  
**pass:loc=1105:cmd="msucount -p ITUN -k 2860:3:5"**

Command Accepted - Processing

```
rlghncxa03w 06-06-01 11:33:40 EST EAGLE5 35.0.0
pass:loc=1105:cmd="msucount -p ITUN -k 2860:3:5"
Command entered at terminal #1.
```

;

- Command when the ITUDUPPC feature is ON (a 2-letter group code must be specified)  
**pass:loc=1105:cmd="msucount -p ITUN -k 2860-gr:3:5"**

Command Accepted - Processing

```
rlghncxa03w 06-06-01 11:33:40 EST EAGLE5 35.0.0
pass:loc=1105:cmd="msucount -p ITUN -k 2860-gr:3:5"
Command entered at terminal #1.
```

;

- The remainder of the ITUN routing key report is the same for both the **on** and **off** settings of the ITUDUPPC feature:

```
rlghncxa03w 06-06-01 11:33:40 EST EAGLE5 35.0.0
```

```

PASS: Command sent to card
;

rlghncxa03w 06-06-01 11:33:40 EST EAGLE5 35.0.0
MSUCOUNT: Command In Progress

;

rlghncxa03w 06-06-01 11:33:40 EST EAGLE5 35.0.0
MSUCOUNT: MSU Count Report

-----
Routing Key Measurements for Static Routing Key
-----

Transmit Counts
-----
tx bytes:                00000
tx msus:                 00000

Transmit Discard Counts
-----
discarded tx due to sccp msg type:    00000
discarded tx due to sccp class:       00000
discarded tx due to normalization error: 00000
discarded tx due to invalid traffic type: 00000

Associated IP Connection          tx bytes      tx msus
-----
c7000                            00000000     00000000
c7050                            00000000     00000000
c7052                            00000000     00000000
c7054                            00000000     00000000

Stored Transmit Discard Data
-----
no stored transmit discard data

MSUCOUNT: command complete

;

```

## IP Connection Report

Example of an IP Connection report for an association or a socket (both share the same report output).

**pass:loc=1105:cmd="msucount -s c7050"**

or

**pass:loc=1105:cmd="msucount -a c7050"**

MSUCOUNT: MSU Count Report

-----  
IP Connection Measurements  
-----

| Receive Counts |            | Transmit Counts |            |
|----------------|------------|-----------------|------------|
| msus           | bytes      | msus            | bytes      |
| 4294967295     | 4294967295 | 4294967295      | 4294967295 |

| Receive Discard Counts |            | Transmit Discard Counts |            |
|------------------------|------------|-------------------------|------------|
| reason                 | count      | reason                  | count      |
| link state             | 4294967295 | sccp msg type           | 4294967295 |
| sccp msg type          | 4294967295 | sccp class              | 4294967295 |
| sccp class             | 4294967295 | normalization error     | 4294967295 |
| sccp called party      | 4294967295 | invalid traffic type    | 4294967295 |
| sccp calling party     | 4294967295 | M3UA conversion error   | 4294967295 |
| isup sio               | 4294967295 | SUA conversion error    | 4294967295 |
| normalization error    | 4294967295 |                         |            |
| error in XSRV packet   | 4294967295 |                         |            |
| M3UA PDU error         | 4294967295 |                         |            |
| SUA PDU error          | 4294967295 |                         |            |
| invalid rcontext       | 4294967295 |                         |            |

Stored Transmit Discard Data  
-----  
no stored transmit discard data

Stored Receive Discard Data  
-----  
53 41 53 49 69 73 6f 74 11 00 87 0a 01 03 01 05  
05 00 01 02 03 04 05 06 07 08 09 00 00 00 00 00

MSUCOUNT: command complete

;

### Signaling Link Bytes Report

Example of a signaling link bytes report for an IPGWx card.

**pass:loc=1305:cmd="msucount -b"**

or

**pass:loc=1305:cmd="msucount -b a"**

MSUCOUNT: MSU Count Report

```

-----
Link Byte Measurements (Link A)
-----

SLK Transmit counts                SLK Receive counts
-----
bytes/      avg      max      max      bytes/      avg      max      max
sec         msu     avg msu  msu     sec         msu     avg msu  msu
-----
444400      2020   2020   2020   444400      2020   2020   2020
    
```

MSUCOUNT: command complete

**Output Specific to IPLIM and IPLIMI**

**NOTE: The routing key report is not supported for IPLIMx applications. The -k, -t, -p, -d, -x options are not supported because the IPLIMx card does not use routing keys and does not support dynamic routing key registration.**

**NOTE: The IPLIMx reports include all equipped signaling links instead of just ports A and B. These reports include the transmit/receive counts alongside each other for the link case.**

Example of help for using the command:

**pass:loc=1103:cmd="msucount -h" or**

**pass:loc=1103:cmd="msucount"**

```

Usage: msucount [ [-l [link]] | [-b [link]] |
                [[-a aname] | [-s sname]] ]
                [-r] [-h]
    
```

```

Options: -l  display signaling link report
         -b  display signaling link bytes report
         -a  display association report
         -s  display socket report
         -r  resets the specified counts
         -h  display command help
    
```

MSUCOUNT command complete

;

Example of a link report for an IPLIMx card with 2 SAALTALI or M2PA links:

The report does not contain MTPP or RKRP MGMT statistics, because those capabilities are not supported on the IPLIMx applications. The report also does not contain tx/rcv discard data, because there are no discards performed at layer 2 of the IPLIMx applications. The IPLIMx card can also contain 2 links per card; the output contains link data for each link.

**pass:loc=1301:cmd="msucount"**

or

**pass:loc=1301:cmd="msucount -l"**

MSUCOUNT: MSU Count Report

| SLK Transmit counts |      |            |            | SLK Receive counts |            |            |
|---------------------|------|------------|------------|--------------------|------------|------------|
| slk                 | rate | msus       | bytes      | rate               | msus       | bytes      |
| A                   | 2000 | 4294967295 | 4294967295 | 2000               | 4294967295 | 4294967295 |
| B                   | 2000 | 4294967295 | 4294967295 | 2000               | 4294967295 | 4294967295 |
| A1                  | 2000 | 4294967295 | 4294967295 | 2000               | 4294967295 | 4294967295 |
| B1                  | 2000 | 4294967295 | 4294967295 | 2000               | 4294967295 | 4294967295 |
| A2                  | 0000 | 0000000000 | 0000000000 | 0000               | 0000000000 | 0000000000 |

MSUCOUNT: command complete

The following is an output example for signaling link **a1** on an IPLIMx card:

**pass:loc=1103:cmd="msucount -l a1"**

MSUCOUNT: MSU Count Report

| SLK Transmit counts |      |            |            | SLK Receive counts |            |            |
|---------------------|------|------------|------------|--------------------|------------|------------|
| slk                 | rate | msus       | bytes      | rate               | msus       | bytes      |
| A1                  | 2000 | 4294967295 | 4294967295 | 2000               | 4294967295 | 4294967295 |

MSUCOUNT: command complete

Example of an IP connection statistics report. The IPLIMx IP connection report does not contain **tx/rev** discard data, because there are no discards performed at layer 2 of the IPLIMx applications.

**pass:loc=1105:cmd="msucount -s c7050"**

or

**pass:loc=1105:cmd="msucount -a c7050"**

MSUCOUNT: Command In Progress

MSUCOUNT: MSU Count Report

-----  
IP Connection Measurements  
-----

| Transmit Counts |            | Receive Counts |            |
|-----------------|------------|----------------|------------|
| msus            | bytes      | msus           | bytes      |
| 4294967295      | 4294967295 | 4294967295     | 4294967295 |

MSUCOUNT: command complete

## Signalling Link Bytes Report

Example of a signaling link bytes report for an IPLIMx card.

**pass:loc=1303:cmd="msucount -b"**



MSUCOUNT: SLK Bytes Report

| SLK Transmit |           |           |      |      | SLK Receive |       |      |           |           |     |      |      |     |
|--------------|-----------|-----------|------|------|-------------|-------|------|-----------|-----------|-----|------|------|-----|
| max          | avg       | avg       | max  | msu  | msu         | msu   | max  | avg       | avg       | max | msu  | msu  | msu |
| slk          | bytes/sec | bytes/sec | msu  | msu  | msu         | msu   | slk  | bytes/sec | bytes/sec | msu | msu  | msu  | msu |
| A            | 35000     | 140       | 273  | 273  | A           | 35000 | 140  | 273       | 273       |     |      |      |     |
| B            | 35000     | 140       | 273  | 273  | B           | 35000 | 140  | 273       | 273       |     |      |      |     |
| A1           | 35000     | 140       | 578  | 578  | A1          | 35000 | 140  | 578       | 578       |     |      |      |     |
| B1           | 35000     | 140       | 273  | 273  | B1          | 35000 | 140  | 273       | 273       |     |      |      |     |
| A2           | 35000     | 140       | 140  | 140  | A2          | 35000 | 140  | 140       | 140       |     |      |      |     |
| B2           | 35000     | 140       | 169  | 169  | B2          | 35000 | 140  | 169       | 169       |     |      |      |     |
| A3           | 35000     | 2048      | 2048 | 2048 | A3          | 35000 | 2048 | 2048      | 2048      |     |      |      |     |
| B3           | 35000     | 140       | 166  | 166  | B3          | 35000 | 140  | 166       | 166       |     |      |      |     |
| 280000       |           |           |      |      | 140         | 2048  | 2048 | total     | 280000    | 140 | 2048 | 2048 |     |

MSUCOUNT: command complete

Example signaling link bytes report for a specified link on an IPLIMx card.

**pass:loc=1303:cmd="msucount -b a"**

MSUCOUNT: SLK Bytes Report

| SLK Transmit |           |           |     |     | SLK Receive |       |     |           |           |     |     |     |     |
|--------------|-----------|-----------|-----|-----|-------------|-------|-----|-----------|-----------|-----|-----|-----|-----|
| max          | avg       | avg       | max | msu | msu         | msu   | max | avg       | avg       | max | msu | msu | msu |
| slk          | bytes/sec | bytes/sec | msu | msu | msu         | msu   | slk | bytes/sec | bytes/sec | msu | msu | msu | msu |
| A            | 35000     | 140       | 273 | 273 | A           | 35000 | 140 | 273       | 273       |     |     |     |     |

MSUCOUNT: command complete

### Enhanced Reset Option

The reset option resets the specified measurements without displaying **msucount** output. The default is to reset the link measurements report.

Example displays resetting link measurements:

**pass:loc=1305:cmd="msucount -l -r"**

or

**pass:loc=1305:cmd="msucount -r"**

eagle10212 06-06-01 08:50:47 EST EAGLE 35.0.0

MSUCOUNT: MSU Count Report

Link measurements have been reset.

MSUCOUNT: command complete

Example displays resetting IP connections:

**pass:loc=1305:cmd="msucount -s - sock1 -r"**

```
eagle10212 07-05-05 08:50:47 EST EAGLE 37.0.0
MSUCOUNT: MSU Count Report
IP Connection measurements have been reset.
MSUCOUNT: command complete
```

Example displays resetting Routing Key measurements:

**pass:loc=1305:cmd="msucount -x -5 -r"**

```
eagle10212 06-01-05 08:50:47 EST EAGLE 35.0.0
MSUCOUNT: MSU Count Report
Routing Key measurements have been reset.
MSUCOUNT: command complete
```

Example displays resetting link byte measurements

**pass:loc=1305:cmd="msucount -b -r"**

```
eagle10212 07-05-01 08:50:47 EST EAGLE 37.0.0
MSUCOUNT: MSU Count Report
Link byte measurements have been reset.
MSUCOUNT: command complete
```

### Output specific to IPSP Cards

The option to display a full help report is not supported for IPSP cards.

**pass:loc=1304:cmd="msucount -h**

```

Command Accepted - Processing

rlghncxa03w 08-01-29 11:31:09 EST  EAGLE 38.0.0
pass:loc=1304:cmd="msucount -h"
Command entered at terminal #3.
;

rlghncxa03w 08-01-29 11:31:09 EST  EAGLE 38.0.0
PASS: Command sent to card
;

rlghncxa03w 08-01-29 11:31:09 EST  EAGLE 38.0.0

Usage: msucount [ [-l [link]] | [-b [link]] | [-l link -f] ] |
               [ [-a aname] ]
               [ [-x rc] ]
               [-r] [-h]

Options: -l  display signaling link report
         -b  display signaling link bytes report
         -a  display association report
         -x  display routing context report
         -f  display full report
         -r  resets the specified counts
         -h  display command help
;

rlghncxa03w 08-01-29 11:31:09 EST  EAGLE 38.0.0

MSUCOUNT: command complete
    
```

For link reports on IPSP signaling links, if a specific link is not requested, then counts for all equipped signaling links on the card are displayed. The report includes counts for up to 32 links per card. The **-l <link>** report adds counts for *Replicated M3UA PDU sent*, *Replicated M3UA PDU rcvd*, and *SS7 SNM Counts sent* for M3UA links.

Example of a brief measurements report:

**pass:loc=1303:cmd="msucount -l"**

```

rlghncxa03w 08-01-29 11:31:09 EST  EAGLE 38.0.0
pass:loc=1303:cmd="msucount -l"

MSUCOUNT: MSU Count Report

SLK Transmit counts
-----
slk  rate  msus      bytes
---  -
A    0      3         72
B    0     62       1916
A1   0      2         48
A2   0      1         24
A3   0      0          0
A4   0      0          0
-----
          0      68       2060
-----

SLK Receive counts
-----
rate  msus      bytes
---  -
0     0         0
0     62       1916
0     0         0
0     0         0
0     0         0
-----
0     62       1916
-----

MSUCOUNT: command complete
    
```

Example of a measurement report for an IPSP-M3UA signaling link:

□ **pass:loc=1303:cmd="msucount -l a"**

```
rlghncxa03w 08-01-29 11:31:09 EST EAGLE 38.0.0
MSUCOUNT: MSU Count Report
```

| SLK Transmit counts |      |      |       | SLK Receive counts |      |       |
|---------------------|------|------|-------|--------------------|------|-------|
| slk                 | rate | msus | bytes | rate               | msus | bytes |
| A                   | 0    | 3    | 72    | 0                  | 0    | 0     |

| Replicated M3UA PDU counts |      | SS7 SNM counts |
|----------------------------|------|----------------|
| sent                       | rcvd | sent           |
| 0                          | 0    | 3              |

Example of a measurement report for an IPSP-M2PA signaling link:

**pass:loc=1303:cmd="msucount -l b"**

```
rlghncxa03w 08-01-29 11:31:09 EST EAGLE 38.0.0
MSUCOUNT: MSU Count Report
```

| SLK Transmit counts |      |      |       | SLK Receive counts |      |       |
|---------------------|------|------|-------|--------------------|------|-------|
| slk                 | rate | msus | bytes | rate               | msus | bytes |
| B                   | 0    | 62   | 1916  | 0                  | 62   | 1916  |

```
MSUCOUNT: command complete
```

The **msucount -l <link> f** report displays the same information as the brief report (**msucount -l <link>**) for IPSP-M2PA links. For IPSP-M3UA links, the **msucount -l <link> -f** report displays both the information from the brief report and the *discarded tx due to M3UA Conversion Error*, *discarded rcv due to M3UA PDU Error*, *discarded rcv due to Management Blocking*, and *discarded rcv due to Lrg BICC not supported* discard counts.

Example of a full report for an IPSP-M3UA signaling link when discard counts are not received:

**Pass:loc=1303:cmd="msucount -l a -f"**

rlghncxa03w 08-01-29 11:31:09 EST EAGLE 38.0.0  
 MSUCOUNT: MSU Count Report

| SLK Transmit counts |      |      |       | SLK Receive counts |      |       |
|---------------------|------|------|-------|--------------------|------|-------|
| slk                 | rate | msus | bytes | rate               | msus | bytes |
| A                   | 0    | 3    | 72    | 0                  | 0    | 0     |

| Replicated M3UA PDU counts |      | SS7 SNM counts |
|----------------------------|------|----------------|
| sent                       | rcvd | sent           |
| 0                          | 0    | 3              |

| Transmit Discard Counts |       | Receive Discard Counts    |       |
|-------------------------|-------|---------------------------|-------|
| reason                  | count | reason                    | count |
| M3UA conversion error   | 2     | no receive discard counts |       |

Stored Transmit Discard Data

```

b0 04 04 04 00 d4 01 1b 61 00 00 bb a9 02 00 00
00 00 00 00 00 00 00 00 00 00 00 00 00 00 00
b0 04 04 04 00 d4 01 16 61 00 00 27 b8 02 00 00
00 00 00 00 00 00 00 00 00 00 00 00 00 00 00
  
```

Stored Receive Discard Data

```

no stored receive discard data
  
```

MSUCOUNT: command complete

Example of a full report for an IPSG-M3UA signaling link when discard counts are received:

**pass:loc=1304:cmd="msucount -l a -f"**

Command Accepted - Processing

rlghncxa03w 08-01-29 11:31:09 EST EAGLE 38.0.0

MSUCOUNT: MSU Count Report

| SLK Transmit counts |      |      |       | SLK Receive counts |      |       |
|---------------------|------|------|-------|--------------------|------|-------|
| slk                 | rate | msus | bytes | rate               | msus | bytes |
| A                   | 0    | 58   | 3380  | 0                  | 5    | 292   |

| Replicated M3UA PDU counts |      | SS7 SNM counts |
|----------------------------|------|----------------|
| sent                       | rcvd | sent           |
| 1                          | 1    | 13             |

| Transmit Discard Counts |       | Receive Discard Counts |       |
|-------------------------|-------|------------------------|-------|
| reason                  | count | reason                 | count |
| M3UA conversion error   | 3     | M3UA PDU Error         | 1     |
|                         |       | management blocking    | 1     |
|                         |       | lrg BICC not supported | 1     |

Stored Transmit Discard Data

```

b0 04 04 04 00 6e 01 18 51 01 00 0f 49 02 00 00
00 00 00 00 00 00 00 00 00 00 00 00 00 00 00 00

80 04 04 04 00 d2 01 00 23 05 05 05 02 1f 61 02
00 00 00 00 00 00 00 00 00 00 00 00 00 00 00 00

80 04 04 04 00 d2 01 00 13 20 19 02 00 00 00 00
00 00 00 00 00 00 00 00 00 00 00 00 00 00 00 00

```

Stored Receive Discard Data

```

01 00 04 01 00 00 00 18 00 0b 00 08 02 00 00 00
00 06 00 08 00 00 00 04 00 00 00 00 00 00 00 00

01 00 01 01 00 00 00 3c 00 06 00 08 00 00 00 04
02 10 00 2b 00 04 04 04 00 05 05 05 0d 02 00 96

01 00 00 10 00 00 00 1c 00 0c 00 08 00 00 00 06
00 07 00 0c 01 00 02 02 00 00 00 18 00 00 00 00

```

MSUCOUNT: command complete

;

Example of a link report for an IPSG-M2PA signaling link:

pass:loc=1303:cmd="msucount -l b"

```
rlghncxa03w 08-01-29 11:31:09 EST EAGLE 38.0.0
MSUCOUNT: MSU Count Report
```

| SLK Transmit counts |      |      |       | SLK Receive counts |      |       |
|---------------------|------|------|-------|--------------------|------|-------|
| slk                 | rate | msus | bytes | rate               | msus | bytes |
| B                   | 0    | 62   | 1916  | 0                  | 62   | 1916  |

MSUCOUNT: command complete

Example of a full link report for an IPSP-M3UA link where discard counts are not received:

**pass:loc=1303:cmd="msucount -l a -f"**

```
rlghncxa03w 08-01-29 11:31:09 EST EAGLE 38.0.0
MSUCOUNT: MSU Count Report
```

| SLK Transmit counts |      |      |       | SLK Receive counts |      |       |
|---------------------|------|------|-------|--------------------|------|-------|
| slk                 | rate | msus | bytes | rate               | msus | bytes |
| A                   | 0    | 3    | 72    | 0                  | 0    | 0     |

| Replicated M3UA PDU counts |      | SS7 SNM counts |
|----------------------------|------|----------------|
| sent                       | rcvd | sent           |
| 0                          | 0    | 3              |

| Transmit Discard Counts |       | Receive Discard Counts    |       |
|-------------------------|-------|---------------------------|-------|
| reason                  | count | reason                    | count |
| M3UA conversion error   | 2     | no receive discard counts |       |

```
Stored Transmit Discard Data
-----
b0 04 04 04 00 d4 01 1b 61 00 00 bb a9 02 00 00
00 00 00 00 00 00 00 00 00 00 00 00 00 00 00

b0 04 04 04 00 d4 01 16 61 00 00 27 b8 02 00 00
00 00 00 00 00 00 00 00 00 00 00 00 00 00 00
```

```
Stored Receive Discard Data
-----
no stored receive discard data
```

MSUCOUNT: command complete

Example of a full link report that contains discard counts for an IPSP-M3UA link:

**pass:loc=1304:cmd="msucount -l a -f"**

Command Accepted - Processing

rlghncxa03w 08-01-29 11:31:09 EST EAGLE 38.0.0

MSUCOUNT: MSU Count Report

| SLK Transmit counts |      |      |       | SLK Receive counts |      |       |
|---------------------|------|------|-------|--------------------|------|-------|
| slk                 | rate | msus | bytes | rate               | msus | bytes |
| A                   | 0    | 58   | 3380  | 0                  | 5    | 292   |

| Replicated M3UA PDU counts |      | SS7 SNM counts |
|----------------------------|------|----------------|
| sent                       | rcvd | sent           |
| 1                          | 1    | 13             |

| Transmit Discard Counts |       | Receive Discard Counts |       |
|-------------------------|-------|------------------------|-------|
| reason                  | count | reason                 | count |
| M3UA conversion error   | 3     | M3UA PDU Error         | 1     |
|                         |       | management blocking    | 1     |
|                         |       | lrg BICC not supported | 1     |

Stored Transmit Discard Data

```

b0 04 04 04 00 6e 01 18 51 01 00 0f 49 02 00 00
00 00 00 00 00 00 00 00 00 00 00 00 00 00 00

80 04 04 04 00 d2 01 00 23 05 05 05 02 1f 61 02
00 00 00 00 00 00 00 00 00 00 00 00 00 00 00

80 04 04 04 00 d2 01 00 13 20 19 02 00 00 00 00
00 00 00 00 00 00 00 00 00 00 00 00 00 00 00
    
```

Stored Receive Discard Data

```

01 00 04 01 00 00 00 18 00 0b 00 08 02 00 00 00
00 06 00 08 00 00 00 04 00 00 00 00 00 00 00 00

01 00 01 01 00 00 00 3c 00 06 00 08 00 00 00 04
02 10 00 2b 00 04 04 04 00 05 05 05 0d 02 00 96

01 00 00 10 00 00 00 1c 00 0c 00 08 00 00 00 06
00 07 00 0c 01 00 02 02 00 00 00 18 00 00 00 00
    
```

MSUCOUNT: command complete

;

**Signaling Link Bytes Report**

The IPSG signaling link bytes report is the same as the IPLIMx link bytes report.

Example of a signaling link bytes report for an IPSG card:



**pass:loc=1303:cmd="msucount -b"**

rlghncxa03w 08-01-29 11:31:09 EST EAGLE 38.0.0  
 MSUCOUNT: MSU Count Report

| SLK Transmit counts |               |            |                |            | SLK Receive counts |            |                |            |  |
|---------------------|---------------|------------|----------------|------------|--------------------|------------|----------------|------------|--|
| slk                 | bytes/<br>sec | avg<br>msu | max<br>avg msu | max<br>msu | bytes/<br>sec      | avg<br>msu | max<br>avg msu | max<br>msu |  |
| A                   | 0             | 0          | 24             | 24         | 0                  | 0          | 0              | 0          |  |
| B                   | 62            | 31         | 31             | 31         | 62                 | 31         | 31             | 31         |  |
| A1                  | 0             | 0          | 24             | 24         | 0                  | 0          | 0              | 0          |  |
| A2                  | 0             | 0          | 24             | 24         | 0                  | 0          | 0              | 0          |  |
| A3                  | 0             | 0          | 0              | 0          | 0                  | 0          | 0              | 0          |  |
| A4                  | 0             | 0          | 0              | 0          | 0                  | 0          | 0              | 0          |  |
| -----               |               |            |                |            | -----              |            |                |            |  |
|                     | 62            | 31         | 31             | 31         | 62                 | 31         | 31             | 31         |  |
| -----               |               |            |                |            | -----              |            |                |            |  |

Example of the '-b' link report:

**pass:loc=1305:cmd="msucount -b a"**

rlghncxa03w 08-01-29 11:31:09 EST EAGLE 38.0.0  
 MSUCOUNT: MSU Count Report

| SLK Transmit counts |               |            |                |            | SLK Receive counts |            |                |            |  |
|---------------------|---------------|------------|----------------|------------|--------------------|------------|----------------|------------|--|
| slk                 | bytes/<br>sec | avg<br>msu | max<br>avg msu | max<br>msu | bytes/<br>sec      | avg<br>msu | max<br>avg msu | max<br>msu |  |
| A                   | 0             | 0          | 24             | 24         | 0                  | 0          | 0              | 0          |  |
| -----               |               |            |                |            | -----              |            |                |            |  |
|                     | 0             | 0          | 24             | 24         | 0                  | 0          | 0              | 0          |  |
| -----               |               |            |                |            | -----              |            |                |            |  |

MSUCOUNT: MSU Count Report

### Routing Context Report

The **msucount -x <routing context>** report for an IPSG card displays the equivalent of the **msucount -l** report for all signaling links on the card that are members of the linkset containing the specified routing context.

Example of a routing context report:

**pass:loc=1303:cmd="msucount -x 74565"**

```
rlghncxa03w 08-01-29 11:31:09 EST EAGLE 38.0.0
MSUCOUNT: MSU Count Report
```

```
-----
Routing Context Measurements
-----
```

| SLK Transmit counts |      |      |       | SLK Receive counts |      |       |
|---------------------|------|------|-------|--------------------|------|-------|
| slk                 | rate | msus | bytes | rate               | msus | bytes |
| A                   | 0    | 3    | 72    | 0                  | 0    | 0     |
|                     | 0    | 3    | 72    | 0                  | 0    | 0     |

```
MSUCOUNT: command complete
```

```
;
```

## IP Connection Report

The IP connection statistic report for an IPSPG card contains data regarding MSUs (tx/rcv), MSU bytes (tx/rcv), and discarded data (tx/rcv) for a specific socket or an association. The **-a <aname>** report for M3UA links adds the *Replicated M3UA PDU sent*, *Replicated M3UA PDU rcvd*, *SS7 SNM sent*, *Discarded rcv due to SS7 SNM not supported*, and *Discarded rcv due to no SS7 SNM capacity*.

The existing *Discarded rcv due to M3UA PDU error* and *Invalid rcontext counts* are also supported.

Example of an aname report:

```
pass:loc=1303:cmd="msucount -a a1303a"
```

rlghncxa03w 08-01-29 11:31:09 EST EAGLE 38.0.0

MSUCOUNT: MSU Count Report

-----  
 IP Association Measurements  
 -----

| Transmit PDUs |       | Receive PDUs |       |
|---------------|-------|--------------|-------|
| pdus          | bytes | pdus         | bytes |
| 3             | 72    | 0            | 0     |

SS7 SNM counts

| sent | rcvd |
|------|------|
| 0    | 0    |

Receive Discard Counts

| reason         | count |
|----------------|-------|
| M3UA PDU error | 3     |

Stored Receive Discard Data

```

-----
01 00 00 00 00 00 00 1c 00 0c 00 08 00 00 00 06
00 07 00 0c 01 00 02 02 00 00 00 18 00 00 00 00

01 00 00 00 00 00 00 1c 00 0c 00 08 00 00 00 06
00 07 00 0c 01 00 02 02 00 00 00 18 00 00 00 00

01 00 00 00 00 00 00 1c 00 0c 00 08 00 00 00 06
00 07 00 0c 01 00 02 02 00 00 00 18 00 00 00 00
  
```

MSUCOUNT: command complete  
 ;

**pass:loc=1304:cmd="msucount -a a1304m3ua1"**

Command Accepted - Processing

<CLLI> <date> <time> <timezone> <product> <release ID>

MSUCOUNT: MSU Count Report

IP Association Measurements

| Transmit PDUs |       | Receive PDUs |       |
|---------------|-------|--------------|-------|
| pdu           | bytes | pdu          | bytes |
| 58            | 3380  | 5            | 292   |

SS7 SNM counts

| sent | rcvd |
|------|------|
| 8    | 7    |

Receive Discard Counts

| reason                | count |
|-----------------------|-------|
| SS7 SNM not supported | 1     |
| SS7 SNM no capacity   | 1     |
| M3UA PDU error        | 13    |
| invalid rcontext      | 5     |

Stored Receive Discard Data

```

01 00 01 01 00 00 00 3c 00 06 00 08 00 00 00 01
02 10 00 2b 00 04 04 04 00 05 05 05 05 00 00 9a

01 00 03 01 00 00 00 08 00 00 00 00 00 00 00 00
00 00 00 00 00 00 00 00 00 00 00 00 00 00 00 00

01 00 01 01 00 00 00 3c 00 06 00 08 00 00 00 04
02 10 00 2b 00 04 04 04 00 05 05 05 85 02 00 9a

01 00 01 01 00 00 00 3c 00 06 00 08 00 00 00 04
02 10 00 2b 00 04 04 04 00 05 05 05 85 02 00 9a

01 00 04 01 00 00 00 18 00 0b 00 08 02 00 00 00
00 06 00 08 00 00 00 04 00 00 00 00 00 00 00 00

01 00 01 01 00 00 00 3c 00 06 00 08 00 00 00 04
02 10 00 2b 00 04 04 04 00 05 05 05 85 02 00 9a

01 00 01 01 00 00 00 3c 00 06 00 08 00 00 00 04
02 10 00 2b 00 04 04 04 00 05 05 05 85 02 00 9a

01 00 01 01 00 00 0a fc 00 06 00 08 00 00 00 0a
02 10 0a eb 00 04 32 01 00 04 32 01 0d 02 00 99

01 00 01 01 00 00 00 08 00 00 00 00 00 00 00 00
00 00 00 00 00 00 00 00 00 00 00 00 00 00 00 00

01 00 07 01 00 00 00 70 00 06 00 08 00 00 00 02

```

```
01 15 00 08 00 00 00 80 01 02 00 18 00 02 00 03
```

```
MSUCOUNT: command complete
```

```
;
```

## msuroute

## Message Signaling Unit (MSU) Routing Information

This command is used to provide a list of all routing keys currently configured on an SS7IPGW/IPGWI card that could be used to route a particular MSU. With 3 types of routing keys (fully specified, partial and default) and 2 types of routing key tables (static and dynamic) the complexity associated with figuring out how a particular MSU would be routed at any point in time is not trivial. This command provides output to help determine how MSUs will be routed based on current conditions.

**Keyword:** **msuroute**

**Command Class:** Application Maintenance

### Options

Options and option parameters that are underlined indicate that a value must be specified for that option or parameter. For example, the **msuroute** command option **-k** has the parameter **rtkey**. The *full routing key* must be specified for the MSU for which the summary will be displayed, as in the command **msuroute -k 5-5-5:5:6-6-6:1100**. Do not enter the underlined option or parameter; enter a value for the information represented by the underlined option or parameter.

#### **-d**

This option is used to report dynamic routing keys.

#### **-h**

This option is used to provide help information for the command.

#### **-k rtkey**

This option is mandatory in the command to specify the full routing key for the MSU for which the summary will be displayed. The routing key is specified as a single parameter with up to five colon-separated fields. The subsystem is not specified when SI is not equal to **3**.

The **-p point code type** modifier is used to identify the format of the routing key that follows the **-k** option in the command.

The following are valid formats for the routing key that follows the **-k** option in the command:

- **n-c-m:s:n**—For DPC, SI, SSN type routing keys. The network, cluster and member (n-c-m) are in the range **0-255**. The service indicator (s) is **3** or **sccp**. The subsystem (n) is in the range **0-255**.
- **n-c-m:s**—For DPC, SI, type routing keys. The network, cluster and member (n-c-m) are in the range **0-255**. The service indicator (s) is in the range **0-2**, **4**, or **6-15**. There is no subsystem.
- **n-c-m:s:no-co-mo:cs:ce**—For DPC, SI, CIC type routing keys. The DPC network, cluster and member (n-c-m) are in the range **0-255**. The service indicator (s) is **5** or **isup**. There is no subsystem. The OPC network, cluster and member (no-co-mo) are in the range **0-255**. The starting circuit identification code (cs) and ending circuit identification code (ce) are in the range **0** to **16363**.

#### **-p point code type**

This option modifier is used to identify the point code type (ANSI, ITU international, ITU national, ITU international spare, ITU national spare) in the routing key that follows the **-k** option in the command.

**Range:** ansi, itui, itun, itun24, ituis, ituns

**Default:** ansi

**-x routing context**

This option modifier is used to display the routing key report using routing context.

### Example

**msuroute -h**

**msuroute -p ansi -k 5-5-5:5:6-6-6:1100**

**msuroute -p ansi -k 5-5-5:5:6-6-6:1100:1100**

**msuroute -k 5-5-5:5:6-6-6:1100**

**msuroute -k 5-5-5:5:6-6-6:1100:1100**

**msuroute -p ansi -k 5-5-5:8**

**msuroute -p itun -k 345:5:678:100:200**

**msuroute -p itun -k 345-gr:5:678-gr:100:200**

**msuroute -p itun24 -k 10-200-10:5:10-200-1:1:100**

### Dependencies

The **-k** option must be specified in the command, and must specify a full routing key.

This command is not supported for IPLIM/IPLIMI cards.

### Notes

The **msuroute** command is executed through the pass command.

The **-p point code type** modifier option can be used with the **-k** option to specify the format of the routing key that follows the **-k** option in the command.

### Output

The output for each **msuroute** command consists of a list of all of the routing keys that exist on the IPGWx card that could be used to route the MSU. The list of routing keys is presented in the hierarchical search order in which the keys would be used. The list of routing keys indicates keys that have IP connections available for traffic, and indicates which routing key would currently be used to route the MSU (marked with \*\*\*).

For the routing key that is selected to route the MSU, the list of IP connections associated with the key is also displayed.

**NOTE: Most of the following output examples show command entries for ANSI MSUs. Because, other than echoing the input command back to the screen, there is nothing in the output that contains specific fields from any configured keys. The output would not be different if the user entered ITUI MSUs instead of ANSI MSUs.**

Either brief or full help reports can be displayed. A full help report is generated by adding the **-h full** option to the command line.

Example of a brief help report:

**pass:loc=1105:cmd="msuroute -h"**

Command Accepted - Processing

```
Usage: msuroute [ [-x rc] | [-k [rtkey] [-p pctype] [-d]] ]
        [-h [full]]
```

```
Options: -x routing key report using routing context
        -k routing key report using MTP3 parameters
           rtkey :: ([dpc][:si][:opc | :ssn][:cics][:cice])
        -p pctype :: (ANSI, ITUI, ITUN, ITUN24, ITUIS, ITUNS)
        -d display dynamic routing key
        -h display command help (brief or full)
```

;

Example of a full help report:

**pass:loc=1305:cmd="msuroute -h full"**

```
0          1          2          3          4          5          6          7
123456789012345678901234567890123456789012345678901234567890123456789012345678
Usage: msuroute [ [-x rc] | [-k [rtkey] [-p pctype] [-d]] ]
        [-h [full]]
```

```
Options: -x routing key report using routing context
        -k routing key report using MTP3 parameters
           rtkey :: dpc:si:opc:cics:cice | dpc:si:ssn | dpc:si
        -p pctype :: (ANSI, ITUI, ITUN, ITUN24, ITUIS, ITUNS)
        -d display dynamic routing key
        -h display command help (brief or full)
```

-k option details:

Use the -p option along with -k to specify the SS7 network domain and point code format for the network. The SS7IPGW default pctype is ANSI. The IPGWI default pctype is ITUI.

| Network | PC Format | Notes                                  |
|---------|-----------|----------------------------------------|
| ANSI    | N-C-M     |                                        |
| ITUN    | N         | Non-Spare ITU National, no group code  |
| ITUN    | N-GC      | Non-Spare ITU National with group code |
| ITUI    | Z-A-I     | Non-Spare ITU International            |
| ITUN24  | N-C-M     | Non-Spare ITU National, 24-bits        |
| ITUNS   | N         | Spare ITU National, no group code      |
| ITUNS   | N-GC      | Spare ITU National with group code     |
| ITUIS   | Z-A-I     | Spare ITU International                |

| SS7 Traffic Partition             | RTKEY Parameter Example |
|-----------------------------------|-------------------------|
| SCCP SSN 5 to DPC 1-1-1           | -k 1-1-1:3:5            |
| ISUP CIC 1 to 1-1-1 from 2-2-2    | -k 1-1-1:5:2-2-2:1      |
| TUP CIC 1 to 1-1-1 from 2-2-2     | -k 1-1-1:4:2-2-2:1      |
| QBICC CIC 1 to 1-1-1 from 2-2-2   | -k 1-1-1:13:2-2-2:1     |
| ISUP CIC 0-5 to 1-1-1 from 2-2-2  | -k 1-1-1:5:2-2-2:0:5    |
| TUP CIC 0-5 to 1-1-1 from 2-2-2   | -k 1-1-1:4:2-2-2:0:5    |
| QBICC CIC 0-5 to 1-1-1 from 2-2-2 | -k 1-1-1:13:2-2-2:0:5   |

;

```
eagle10212 06-06-01 12:56:46 EST EAGLE 35.0.0
MSURROUTE command complete
```

Example of **msuroute** output for an ANSI CIC-based MSU, showing at least 1 routing key of every key type in the search hierarchy configured on the 1105 card. Only key types that are configured on the card will be listed in the display.

**pass:loc=1105:cmd="msuroute -p ANSI -k 5-5-5:5:6-6-6:1100"**

Command Accepted - Processing

```

rlghncxa03w 06-06-01 11:31:09 EST  EAGLE5 35.0.0
pass:loc=1105:cmd="msuroute -x ANSI -k 5-5-5:5:6-6-6:1100"
Command entered at terminal #1.
;

rlghncxa03w 06-06-01 11:31:09 EST  EAGLE5 35.0.0
PASS: Command sent to card
;

rlghncxa03w 06-06-01 11:31:09 EST  EAGLE5 35.0.0
MSURROUTE command in progress
;

rlghncxa03w 04-04-29 11:31:09 EST  EAGLE5 31.6.0

TABLE  KEYTYPE                #ConnCfgd  #ConnAvail  RTKEY USED
DYN    FULL                    1           0           no
DYN    PARTIAL: IGNORE-CIC     2           0           no
DYN    PARTIAL: IGNORE-CIC+OPC 1           0           no
DYN    PARTIAL: DPC-SI ONLY    3           3           yes
DYN    PARTIAL: DPC ONLY       2           2           no
DYN    PARTIAL: SI ONLY        4           0           no
DYN    DEFAULT                 4           4           no
STATIC FULL                    12          4           no
STATIC PARTIAL: IGNORE-CIC     3           0           no
STATIC PARTIAL: IGNORE-CIC+OPC 2           0           no
STATIC PARTIAL: DPC-SI ONLY    3           2           no
STATIC PARTIAL: DPC ONLY       2           2           no
STATIC PARTIAL: SI ONLY        1           0           no
STATIC DEFAULT                 2           0           no

IP Connections Associated with the RTKEY USED
Name           Avail?
Vox1           yes
Mgc2           yes
Mgc24          yes

MSURROUTE command complete
;

```

Example of **msuroute** output for an ANSI SCCP MSU. Several of the key types in the search hierarchy are not configured on the 1105 card, and therefore are not part of the output (for example, dynamic or static full key and dynamic or static partial SI only). Only key types that are configured on the card will be listed in the display.

**pass:loc=1105:cmd="msuroute -p ANSI -k 5-5-5:3:34"**



Command Accepted - Processing

```
rlghncxa03w 06-06-01 11:31:09 EST EAGLE5 35.0.0
pass:loc=1105:cmd="msuroute -p ANSI -k 5-5-5:3:34"
Command entered at terminal #1.
```

;

```
rlghncxa03w 06-06-01 11:31:09 EST EAGLE5 35.0.0
PASS: Command sent to card
```

;

```
rlghncxa03w 06-06-01 11:31:09 EST EAGLE5 35.0.0
MSURROUTE command in progress
```

;

```
rlghncxa03w 06-06-01 11:31:09 EST EAGLE5 35.0.0
TABLE  KEYTYPE                #ConnCfgd  #ConnAvail  RTKEY USED
DYN     PARTIAL: DPC-SI ONLY    3           2           yes
DYN     PARTIAL: DPC ONLY      2           2           no
DYN     DEFAULT                4           4           no
STATIC  PARTIAL: DPC-SI ONLY    3           2           no
STATIC  PARTIAL: DPC ONLY      2           2           no
STATIC  DEFAULT                2           0           no
```

SocketsIP Connections Associated with the RTKEY USED

| Name          | Avail? |
|---------------|--------|
| Scpsandiego   | no     |
| scpdenver     | yes    |
| scpkansascity | yes    |

MSURROUTE command complete

;

Example of **msuroute** output for an ANSI MSU with SI=8:

**pass:loc=1105:cmd="msuroute -p ANSI -k 5-5-5:8"**

```

Command Accepted - Processing

rlghncxa03w 06-06-01 11:31:09 EST EAGLE5 35.0.0
pass:loc=1105:cmd="msuroute -p ANSI -k 5-5-5:8"
Command entered at terminal #1.
;

rlghncxa03w 06-06-01 11:31:09 EST EAGLE5 35.0.0
PASS: Command sent to card
;

rlghncxa03w 06-06-01 11:31:09 EST EAGLE5 35.0.0
MSURROUTE command in progress
;

rlghncxa03w 06-06-01 11:31:09 EST EAGLE5 35.0.0

TABLE   KEYTYPE                #ConnCfgd  #ConnAvail  RTKEY USED
DYN     FULL                    7          0           no
DYN     PARTIAL: DPC ONLY       2          2           yes
DYN     PARTIAL: SI ONLY        2          0           no
DYN     DEFAULT                 4          4           no
STATIC  FULL                    11         0           no
STATIC  PARTIAL: DPC ONLY       2          2           no
STATIC  PARTIAL: SI ONLY        1          0           no
STATIC  DEFAULT                 2          0           no

IP Connections Associated with the RTKEY USED
Name                Avail?
SI8sock1            yes
SI8sock2            yes

MSURROUTE command complete
;

```

Examples of **msuroute** output for an ITUN and an ITUN24 MSU with SI=5. The output format is the same for all four commands.

The ITUDUPPC feature is OFF (default):

**pass:loc=1105:cmd="msuroute -p itun -k 345:5:678:100:200"**

The ITUDUPPC feature is ON (the 2-letter group code must be specified with the DPC and OPC)

**pass:loc=1105:cmd="msuroute -p itun -k 345-gr:5:678-gr:100:200"**

An ITUN24 MSU with SI=5:

**pass:loc=1105:cmd="msuroute -p itun24 -k 10-200-10:5:10-200-1:1:100"**

An ITU-I Spare MSU with SI=5:

**msuroute -p ituis -k 3-11-1:5:4-11-1:5:5**

```

Command Accepted - Processing

rlghncxa03w 06-06-01 11:31:09 EST EAGLE5 35.0.0
pass:loc=1105:cmd="msuroute -p ITUN -k 345:678:100:200"
Command entered at terminal #1.
;

rlghncxa03w 06-06-01 11:31:09 EST EAGLE5 35.0.0
PASS: Command sent to card
;

rlghncxa03w 06-06-01 11:31:09 EST EAGLE5 35.0.0
MSURROUTE command in progress
;

rlghncxa03w 06-06-01 11:31:09 EST EAGLE5 35.0.0
TABLE  KEYTYPE                #ConnCfgd  #ConnAvail  RTKEY USED
DYN     FULL                    1           0           no
DYN     PARTIAL: IGNORE CIC     2           0           no
DYN     PARTIAL: IGNORE CIC+OPC 1           0           no
DYN     PARTIAL: DPC-SI ONLY    3           3           yes
DYN     PARTIAL: DPC ONLY       2           2           no
DYN     PARTIAL: SI ONLY        4           0           no
DYN     DEFAULT                 4           4           no
STATIC  FULL                    12          4           no
STATIC  PARTIAL: IGNORE-CIC     3           0           no
STATIC  PARTIAL: IGNORE-CIC+OPC 2           0           no
STATIC  PARTIAL: DPC-SI ONLY    3           2           no
STATIC  PARTIAL: DPC ONLY       2           2           no
STATIC  PARTIAL: SI ONLY        1           0           no
STATIC  DEFAULT                 2           0           no

IP Connections Associated with the RTKEY USED
Name                               Avail?
Vox1                                yes
Mgc2                                yes
Mgc24                              yes

MSURROUTE command complete
;

```

**msutrace****MSU Trace**

This command provides filter and trace capability for MSUs passing through the IP<sup>7</sup> GPLs. This command provides a view of MSU data as it exists in the PSTN network and its corresponding format as it exists in the IP network.

**Keyword:** **msutrace**

**Command Class:** Application Maintenance

**Options**

Options and option parameters that are underlined indicate that a value must be specified for that option or parameter. For example, the **msutrace** command option **-a** has the parameter action. The action that the command is to take can be specified, as in the command **msutrace -a acttrace**. Do not enter the underlined option or parameter; enter a value for the information represented by the underlined option or parameter.

**-a action**

Action option.

**Range: acttrace, clrtrace, dacttrace, chgfilter****acttrace**—Activate (turn on) MSU tracing**clrtrace**—Clear all data from trace buffers**dacttrace**—Deactivate (turn off) MSU tracing**chgfilter**—Change filter used to indicate which MSUs are placed in the trace buffers**-g get option**

The get option.

**Range: config, trace****config**—Displays the current **msutrace** settings: trace ON/OFF status, filter settings, and trace buffers used/available**trace**—Displays contents of trace buffers containing captured MSU data**-h help**

This option is used to display help information about this command.

**Range: full**If **full** is specified, the detailed version of the help information is displayed.If **full** is not specified (just **-h**), the simple version of the help information is displayed.**-m mode**

This option is used to indicate which MSUs are captured.

**Range: normerr, all****normerr**—trace only MSUs with normalization errors**all**—trace all MSUs regardless of MSU contents**-p point code type**

This option is used to specify which type of point code (ANSI, ITU international, ITU national, 24-bit ITU national, ITU-I spare, or ITU-N spare) is contained in the filter key, when the key contains a DPC or OPC.

**Range: ansi, itui, itun, itun24, ituis, ituns****Default: ansi****-k filter key**The **-k**, **-c**, and **-p** options are used to specify the filter key used to determine which MSUs will have data placed in the trace buffers.**Range:****-k filter key [-p] [-c pcType]**The syntax for the **filter key** portion of the **-k filter key** option is specified as a single string parameter with up to five colon-separated fields. The **filter key** can contain one or more of the following fields:*n-c-m*—represents an ANSI DPC in the format *network-cluster-member**no-co-mo*—represents an ANSI OPC in the format *network-cluster-member**z-a-i*—represents an ITU-I DPC in the format *zone-area-id**zo-ao-io zone-area-id*—represents an ITU-I OPC in the format*msa-ssa-sp*—represents a 24-bit ITU-N DPC in the format *main sigaling area-sub signaling area-signaling point**nnnnn*—represents an ITU-N DPC*nnnnn-gc*—represents an ITU-N DPC with Group Code when the Duplicate Point Code feature is ON*no*—represents an ITU-N OPC*no-gc*—represents an ITU-N OPC with Group Code when the Duplicate Point Code feature is ON*s*—represents an SI (Service Indicator)*cs*—represents a CIC Start value (start of the CIC range)*ce*—represents a CIC End value (end of the CIC range)

*n*—represents an SSN (Subsystem Number)

The following examples show valid formats:

- *n-c-m:s:n*—For DPC, SI, SSN type routing keys. The network, cluster and member (*n-c-m*) are in the range **0-255**. The service indicator (*s*) is **3** or **sccp**. The subsystem (*n*) is in the range **0-255**.
- *n-c-m:s*—For DPC, SI type routing keys. The network, cluster and member (*n-c-m*) are in the range **0-255**. The service indicator (*s*) is in the range **0-2**, **4**, or **6-15**. There is no subsystem number. As a default, counts for all routing keys within the option combination are displayed.
- *n-c-m:s:no-co-mo:cs:ce*—For DPC, SI, CIC type routing keys. The DPC network, cluster and member (*n-c-m*) are in the range **0-255**. The service indicator (*s*) is **5** or **isup**. There is no subsystem. The OPC network, cluster and member (*no-co-mo*) are in the range **0-255**. The starting circuit identification code (*cs*) and ending circuit identification code (*ce*) are in the range **0** to **16363**.
- *z-a-i*—For DPCN and DPCI routing keys, the zone, area and ID (*z-a-i*) are in the range of **000-007** (zone and ID) and **000-255** (area).
- *msa-ssa-sp*—For 24-bit DPCN routing keys, the main signaling area, sub signaling area and signaling point (*msa-ssa-sp*) are in the range of **000-255**.

#### **-t**

This option is used to denote the routing key type (IPGWx only).

#### **-x rc**

This option is used to generate a routing key report using routing context.

### **Example**

```
pass:loc=1105:cmd="msutrace -h"
```

```
pass:loc=1105:cmd="msutrace -h full"
```

```
pass:loc=1105:cmd="msutrace -g config"
```

```
pass:loc=1315:cmd="msutrace -g trace"
```

```
pass:loc=1105:cmd="msutrace -a clrtrace"
```

```
pass:loc=1105:cmd="msutrace -a acttrace"
```

```
pass:loc=1105:cmd="msutrace -a chgfilter -p ansi -k 3-3-3:5:4-4-4:10:1000"
```

```
pass:loc=1105:cmd="msutrace -a chgfilter -p itui -t partial -k 1-3-3:5:2-4-4"
```

```
pass:loc=1105:cmd="msutrace -a chgfilter -p itun -t partial -k 1536:5"
```

```
pass:loc=1105:cmd="msutrace -a chgfilter -m normerr"
```

```
pass:loc=1105:cmd="msutrace -a chgfilter -m all"
```

### **Dependencies**

If no options are specified, the simple version of the help information is displayed.

The point code type defaults to ANSI when the **-p** option is not specified.

The **-p** option is allowed only on key types that contain a DPC or OPC.

### **Notes**

The **msutrace** command is executed through the **pass** command.

The **msutrace** command captures the data portion of the PSTN packet, starting at the SIO bytes.

The **msutrace** command captures the entire TALI, M3UA, or SUA packet. This includes the TALI, M3UA, or SUA header and additional data stored inside system buffer chain elements. The **msutrace** command currently does not support the trace and capture of TALI MTP Primitives or M3UA / SUA SSNM (Class 2) messages.

The **msutrace** command captures data in trace buffers. If the set of trace buffers becomes full with captured MSU data after MSU tracing is activated, no more data capturing will take place. The **-a clrtrace** option must be specified to reset (clear) the content of the trace buffers. After the trace buffers are empty again, **msutrace** will restart capturing qualified MSUs.

If MSU tracing is activated with the **-a acttrace** option before a properly formatted filter key is entered, **msutrace** will not capture any data due to lack of a proper filter. When the **-a chgfilter** option is specified to enter a properly formatted filter; **msutrace** will start capturing qualified MSUs.

## Output

**NOTE: The msutrace pass command exists on the IPLIM/IPLIMI cards as a debug-only pass command. All command syntax and output are identical to the SS7IPGW and IPGWI commands described in this section.**

Both brief and full versions of IPGW reports can be requested. A full report is requested by including the **-f** in the command line.

Example of a brief help report:

pass:loc=1305:cmd="msutrace -h"

```

0          1          2          3          4          5          6          7
12345678901234567890123456789012345678901234567890123456789012345678
Usage: msutrace [-a action_cmd] [-g get_cmd]
               [ [-x rc] | [-k [rtkey] [-p pctype] [-t keytype]] ]
               [-m mode] [-h [full]]

Options:
-a  action_cmd: an Action Command
-g  get_cmd: a Get Command
-x  routing key report using routing context
-k  routing key report using MTP3 parameters
    rtkey :: ([dpc][[:si]][[:opc] | :ssn][[:cics][[:cice]])
-p  pctype :: (ANSI, ITUI, ITUN, ITUN24, ITUIS, ITUNS)
-t  routing key type
    keytype :: (<full>, partial, default)
-m  mode: mode for qualifying MSUs captured=[normerr | all]
-h  displays this message (brief or full)

get_cmd:      [config | trace]
config        config
trace         trace

action_cmd:   [acttrace | chgfilter | clrtrace | dacttrace]
acttrace      acttrace
chgfilter     chgfilter [<fltrkey>] | [-m mode] (at least 1 required)
              (valid fltrkey should be present either before
              specifying mode or in the same command)

clrtrace      clrtrace
dacttrace     dacttrace

<fltrkey>:   [ [-x rc] | [-k [rtkey] [-p pctype] [-t keytype]] ]
              (see 'msutrace -h full' for complete description)

MSUTRACE command complete

;
```

Example of a full help report:

pass:loc=1305:cmd="msutrace -h full"

```

0          1          2          3          4          5          6          7
12345678901234567890123456789012345678901234567890123456789012345678
  Usage: msutrace [-a action_cmd] [-g get_cmd]
                [ [-x rc] | [-k [rtkey] [-p pctype] [-t keytype]] ]
                [-m mode] [-h [full]]

```

Options:

```

-a  action_cmd: an Action Command
-g  get_cmd: a Get Command
-x  routing key report using routing context
-k  routing key report using MTP3 parameters
    rtkey :: ([dpc][:si][:opc | :ssn][:cics][:cice])
-p  pctype :: (ANSI, ITUI, ITUN, ITUN24, ITUIS, ITUNS)
-t  routing key type
    keytype :: (<full>, partial, default)
-m  mode: mode for qualifying MSUs captured=[normerr | all]
-h  displays this message (brief or full)

```

```

get_cmd:      [config | trace]
  config      Display the current MSUTRACE settings:
              trace On/Off status, filter settings, and
              trace buffers used/available.
              ex: msutrace -g config

  trace       Display content of trace buffers containing captured
              MSU data
              ex: msutrace -g trace

action_cmd:   [acttrace | chgfilter | clrtrace | dacttrace]
  acttrace    Activate (turn-on) MSU-tracing.
              ex: msutrace -a acttrace

  chgfilter   chgfilter [<filtkey>] | [-m mode] at least 1 required)
              (valid fltrkey should be present either before
              specifying mode or in the same command)
              Change filter used to qualify which MSUs are placed in
              trace buffers:
              Flow of command should be
              Either entering filter key before specifying mode:
              ex: To trace MSUs based on MSU content:
                  msutrace -a chgfilter <filtkey>
              ex: To only trace MSUs with Normalization errors.
                  msutrace -a chgfilter -m normerr
              ex: To trace all MSUs regardless of error conditions:
                  msutrace -a chgfilter -m all
              Or entering filter key along with mode:
              ex: To trace MSUs based on MSU content:
                  with Normalization errors:
                  msutrace -a chgfilter <fltrkey> -m normerr
              ex: To trace MSUs based on MSU content
                  regardless of error conditions:
                  msutrace -a chgfilter <filtkey> -m all

  clrtrace    Clear all data from trace buffers.
              ex: msutrace -a clrtrace

  dacttrace   Deactivate (turn-off) MSU-tracing.
              ex: msutrace -a dacttrace

```

-k option details:

Use the -p option along with -k to specify the SS7 network domain and point code format for the network. The SS7IPGW



default pctype is ANSI. The IPGWI and IPLIMI default pctype is ITUI.

| Network | PC Format | Notes                                  |
|---------|-----------|----------------------------------------|
| ANSI    | N-C-M     |                                        |
| ITUN    | N         | Non-Spare ITU National, no group code  |
| ITUN    | N-GC      | Non-Spare ITU National with group code |
| ITUI    | Z-A-I     | Non-Spare ITU International            |
| ITUN24  | N-C-M     | Non-Spare ITU National, 24-bits        |
| ITUNS   | N         | Spare ITU National, no group code      |
| ITUNS   | N-GC      | Spare ITU National with group code     |
| ITUIS   | Z-A-I     | Spare ITU International                |

Use the -t option along with -k to specify certain MTP3 and user part MSU fields as wildcards for the routing key.

| SS7 Traffic Partition             | RTKEY Parameter Example      |
|-----------------------------------|------------------------------|
| Any User Part to DPC 1-1-1        | -k 1-1-1 -t partial          |
| SCCP to DPC 1-1-1                 | -k 1-1-1:3 -t partial        |
| ISUP to DPC 1-1-1                 | -k 1-1-1:5 -t partial        |
| TUP to DPC 1-1-1                  | -k 1-1-1:4 -t partial        |
| QBICC to DPC 1-1-1                | -k 1-1-1:13 -t partial       |
| SI [0-2,6-12,14,15] to DPC 1-1-1  | -k 1-1-1:SI                  |
| SCCP SSN 5 to DPC 1-1-1           | -k 1-1-1:3:5                 |
| ISUP to DPC 1-1-1 from OPC 2-2-2  | -k 1-1-1:5:2-2-2 -t partial  |
| TUP to DPC 1-1-1 from OPC 2-2-2   | -k 1-1-1:4:2-2-2 -t partial  |
| QBICC to DPC 1-1-1 from OPC 2-2-2 | -k 1-1-1:13:2-2-2 -t partial |
| ISUP CIC 1 to 1-1-1 from 2-2-2    | -k 1-1-1:5:2-2-2:1           |
| TUP CIC 1 to 1-1-1 from 2-2-2     | -k 1-1-1:4:2-2-2:1           |
| QBICC CIC 1 to 1-1-1 from 2-2-2   | -k 1-1-1:13:2-2-2:1          |
| ISUP CIC 0-5 to 1-1-1 from 2-2-2  | -k 1-1-1:5:2-2-2:0:5         |
| TUP CIC 0-5 to 1-1-1 from 2-2-2   | -k 1-1-1:4:2-2-2:0:5         |
| QBICC CIC 0-5 to 1-1-1 from 2-2-2 | -k 1-1-1:13:2-2-2:0:5        |
| Default Routing Key               | -k -t default                |

eagle10212 06-01-16 11:01:02 EST EAGLE 35.0.0

MSUTRACE command complete

Example of a full help report for the IPSP card:

pass:loc=1304:cmd="msutrace -h full"

```
0          1          2          3          4          5          6          7
1234567890123456789012345678901234567890123456789012345678901234567890123456789012345678
```

```
Usage: msutrace [-a action_cmd] [-g get_cmd]
           [ [-x rc] | [-k [rtkey] [-p pctype] [-t keytype]] ]
           [-m mode] [-h [full]]
```

Options:

```
-a  action_cmd: an Action Command
-g  get_cmd: a Get Command
-x  routing key report using routing context
-k  routing key report using MTP3 parameters
    rtkey :: ([dpc][[:si]][[:opc] | :ssn][[:cics]][[:cice]])
-p  pctype :: (ANSI, ITUI, ITUN, ITUN24, ITUIS, ITUNS)
-t  routing key type
    keytype :: (<full>, partial, default)
-m  mode: mode for qualifying MSUs captured = [normerr | all]
-h  displays this message (brief or full)
```

```
get_cmd:      [config | trace]
```

```
config       Display the current MSUTRACE settings:
              trace On/Off status, filter settings, and
              trace buffers used/available.
              ex: msutrace -g config
```

```
trace        Display content of trace buffers containing captured
              MSU data
              ex: msutrace -g trace
```

```
action_cmd:  [acttrace | chgfilter | clrtrace | dacttrace ]
```

```
acttrace     Activate (turn-on) MSU-tracing.
              ex: msutrace -a acttrace
```

```
chgfilter    chgfilter [<fltrkey>] | [-m mode] at least 1 required)
              (valid fltrkey should be present either before
              specifying mode or in the same command)
```

```
Change filter used to qualify which MSUs are placed in
trace buffers:
```

```
Flow of command should be
```

```
Either entering filter key before specifying mode:
```

```
ex: To trace MSUs based on MSU content:
```

```
msutrace -a chgfilter <fltrkey>
```

```
ex: To only trace MSUs with Normalization errors.
```

```
msutrace -a chgfilter -m normerr
```

```
ex: To trace all MSUs regardless of error conditions:
```

```
msutrace -a chgfilter -m all
```

```
Or entering filter key along with mode:
```

```
ex: To trace MSUs based on MSU content:
```

```
with Normalization errors:
```

```
msutrace -a chgfilter <fltrkey> -m normerr
```

```
ex: To trace MSUs based on MSU content
```

```
regardless of error conditions:
```

```
msutrace -a chgfilter <fltrkey> -m all
```

```
clrtrace     Clear all data from trace buffers.
```

```
ex: msutrace -a clrtrace
```

```
dacttrace    Deactivate (turn-off) MSU-tracing.
```

```
ex: msutrace -a dacttrace
```

-k option details:

```
Use the -p option along with -k to specify the SS7 network
domain and point code format for the network. The SS7IPGW
and IPLIM default pctype is ANSI. The IPGWI and IPLIMI
```

default pctype is ITUI.

For IPSP both ANSI and ITU network point code formats are eligible for trace when the default filter or an SI only filter is specified. The IPSP default pctype is ANSI when the filter contains OPC or DPC and the -p option is not specified.

| Network | PC Format | Notes                                  |
|---------|-----------|----------------------------------------|
| ANSI    | N-C-M     |                                        |
| ITUN    | N         | Non-Spare ITU National, no group code  |
| ITUN    | N-GC      | Non-Spare ITU National with group code |
| ITUI    | Z-A-I     | Non-Spare ITU International            |
| ITUN24  | N-C-M     | Non-Spare ITU National, 24-bits        |
| ITUNS   | N         | Spare ITU National, no group code      |
| ITUNS   | N-GC      | Spare ITU National with group code     |
| ITUIS   | Z-A-I     | Spare ITU International                |

Use the -t option along with -k to specify certain MTP3 and user part MSU fields as wildcards for the routing key or LS.

| SS7 Traffic Partition             | RTKEY/MTP3 Parameter Example |
|-----------------------------------|------------------------------|
| Any User Part to DPC 1-1-1        | -k 1-1-1 -t partial          |
| SCCP to DPC 1-1-1                 | -k 1-1-1:3 -t partial        |
| ISUP to DPC 1-1-1                 | -k 1-1-1:5 -t partial        |
| TUP to DPC 1-1-1                  | -k 1-1-1:4 -t partial        |
| QBICC to DPC 1-1-1                | -k 1-1-1:13 -t partial       |
| SI [0-2,6-12,14,15] to DPC 1-1-1  | -k 1-1-1:SI                  |
| SCCP SSN 5 to DPC 1-1-1           | -k 1-1-1:3:5                 |
| ISUP to DPC 1-1-1 from OPC 2-2-2  | -k 1-1-1:5:2-2-2 -t partial  |
| TUP to DPC 1-1-1 from OPC 2-2-2   | -k 1-1-1:4:2-2-2 -t partial  |
| QBICC to DPC 1-1-1 from OPC 2-2-2 | -k 1-1-1:13:2-2-2 -t partial |
| ISUP CIC 1 to 1-1-1 from 2-2-2    | -k 1-1-1:5:2-2-2:1           |
| TUP CIC 1 to 1-1-1 from 2-2-2     | -k 1-1-1:4:2-2-2:1           |
| QBICC CIC 1 to 1-1-1 from 2-2-2   | -k 1-1-1:13:2-2-2:1          |
| ISUP CIC 0-5 to 1-1-1 from 2-2-2  | -k 1-1-1:5:2-2-2:0:5         |
| TUP CIC 0-5 to 1-1-1 from 2-2-2   | -k 1-1-1:4:2-2-2:0:5         |
| QBICC CIC 0-5 to 1-1-1 from 2-2-2 | -k 1-1-1:13:2-2-2:0:5        |
| Default Routing Key               | -k -t default                |
| Any User Part to DPC=LS APC       | -x LS RCONTEXT (IPSP Only)   |

;

MSUTRACE command complete

;

Get the current settings of the **msutrace** command options: trace ON/OFF status, filter settings, and trace buffers that are used and available.

**pass:loc=1105:cmd="msutrace -g config"**

Command Accepted - Processing

```

eagle20003 99-11-27 10:16:57 EST EAGLE5 31.6.0
pass:loc=1105:cmd="msutrace -g config"
Command entered at terminal #1.
;
eagle20003 99-11-27 10:16:57 EST EAGLE5 31.6.0
PASS: Command sent to card
;
eagle20003 99-11-27 10:16:57 EST EAGLE5 31.6.0
MSUTRACE command in progress
;
eagle20003 99-11-27 10:16:57 EST EAGLE5 31.6.0
MSUTRACE configurations

Trace = On

Trace buffers: 2 of 3 contain captured MSU data

MSUTRACE: filter settings
DPCA      SI SSN OPCA      CICS      CICE      MODE
055-055-055 13 *** 016-006-006 1234567890 1234567890 normerr
;
eagle20003 99-11-27 10:16:57 EST EAGLE5 31.6.0
MSUTRACE command complete
;

```

Get the current settings of the **msutrace** command options: trace ON/OFF status, filter settings, and trace buffers that are used and available, when the filter key specifies an ITU-I spare point code.

**pass:loc=1105:cmd="msutrace -g config"**

Command Accepted - Processing

```

eagle20003 05-01-27 10:16:03 EST EAGLE5 31.12.0
pass:loc=1105:cmd="msutrace -g config"
Command entered at terminal #1.
;
eagle20003 05-01-27 10:16:03 EST EAGLE5 31.12.0
PASS: Command sent to card
;
eagle20003 05-01-27 10:16:03 EST EAGLE5 31.12.0
MSUTRACE command in progress
;
eagle20003 05-01-27 10:16:03 EST EAGLE5 31.12.0
MSUTRACE configurations

Trace = On

Trace buffers: 3 of 3 USED

MSUTRACE: filter settings
  DPCI      SI SSN  OPCI      CICS      CICE      MODE
s-2-011-1   2 ***    ****     ****     ****     all
;
eagle20003 05-01-27 10:16:03 EST EAGLE5 31.12.0
MSUTRACE command complete
;

```

Get the current settings of the **msutrace** command when an IPSG card is used.

**pass:loc=1304:cmd="msutrace -g config"**

```
rlghncxa03w 08-01-29 11:31:09 EST EAGLE 38.0.0
```

```
MSUTRACE: Configurations
```

```
MSU Tracing is off
```

```
Trace buffers: 0 of 3 USED
```

```
MSUTRACE: filter settings
```

| DPCA        | SI | SSN | OPCA | CICS | CICE | MODE |
|-------------|----|-----|------|------|------|------|
| 004-004-004 | ** | *** | **** | **** | **** | all  |

```
;
```

Activate trace with a DPC-only filter key specified via the **-x <rcontext>** option:

**pass:loc=1304:cmd="msutrace -a acttrace"**

```
rlghncxa03w 08-01-29 11:31:09 EST EAGLE 38.0.0
```

```
MSUTRACE command complete
```

```
;
```

Retrieve the captured trace buffer for an IPSG card:

pass:loc=1304:cmd="msutrace -g trace"

rlghncxa03w 08-01-29 11:31:09 EST EAGLE 38.0.0

-----  
BUFFER: 0  
-----

Filter used:

| DPCA        | SI | SSN | OPCA | CICS | CICE | MODE |
|-------------|----|-----|------|------|------|------|
| 004-004-004 | ** | *** | **** | **** | **** | all  |

Timestamp: 08-01-21 16:06:17.420  
Direction: Tx  
Error Code: 0

PSTN DATA

```

-----
85 04 04 04 05 05 05 00 00 00 00 6e 01 00 f9 e3 .....n....
33 c7 00 00 1d 00 00 00 00 10 00 12 00 14 00 16 3.....
00 18 00 1a 00 1c 00 1e 00 .....

```

IP DATA

```

-----
01 00 01 01 00 00 00 44 00 06 00 08 00 00 00 04 .....D.....
02 10 00 31 00 05 05 05 00 04 04 04 05 02 00 00 ...1.....
00 00 00 6e 01 00 f9 e3 33 c7 00 00 1d 00 00 00 ...n...3.....
00 10 00 12 00 14 00 16 00 18 00 1a 00 1c 00 1e .....
00 00 00 00 .....

```

MSUTRACE command complete

;

Retrieve contents of the trace buffers. In this TALI example, there are 2 stored trace buffers:

pass:loc=1315:cmd="msutrace -g trace"

Command Accepted - Processing

eagle10202 01-01-19 10:20:56 GMT EAGLE5 31.6.0
pass:loc=1315:cmd="msutrace -g trace"
Command entered at terminal #4.

;

eagle10202 01-01-19 10:20:56 GMT EAGLE5 31.6.0
PASS: Command sent to card

;

eagle10202 01-01-19 10:20:56 GMT EAGLE5 31.6.0
MSUTRACE command in progress

;

eagle10202 01-01-19 10:20:56 GMT EAGLE5 31.6.0

-----
BUFFER: 0
-----

Filter used:

DPCN SI SSN OPCN CICS CICE MODE
02137 \*\* \*\*\* \*\*\*\* \*\*\*\* any

Timestamp: 01-01-19 10:19:14.520
Direction: Rx
Error Code: 19

PSTN DATA
-----

IP DATA
-----

54 41 4c 49 78 73 72 76 ac 00 78 6e 72 6d 00 00 TALIXsrv..xnrm..
02 61 61 04 00 01 00 00 00 00 00 00 00 00 00 02 .aa.....
85 00 85 59 48 16 a4 00 00 41 00 00 00 00 00 02 ...YH...A.....
0e 0c 00 00 00 00 00 00 00 00 00 00 00 00 0a 0a .....
00 00 00 00 00 00 00 00 00 00 08 01 00 1a 04 00 .....
00 00 00 0b 0a 00 00 00 00 00 00 00 00 00 00 13 .....
02 00 01 28 0a 00 00 00 00 00 00 00 00 00 00 2a ...(.\*\*\*\*\*
01 00 20 03 7e 01 00 03 01 00 1d 02 00 80 c0 0b .....~.....
00 00 00 00 00 00 00 00 00 00 00 00 c1 09 00 00 .....
00 00 00 00 00 00 39 02 00 00 3f 0a 00 00 00 .....9...?.....
00 00 00 00 00 00 03 0c 00 04 00 01 00 fc 00 .....
04 00 0e 02 00 00 .....

-----
BUFFER: 1
-----

Filter used:

DPCN SI SSN OPCN CICS CICE MODE
02137 05 \*\*\* 04185 0 100 any

Timestamp: 01-01-19 10:19:32.470
Direction: Rx
Error Code: 0

PSTN DATA
-----

```

85 59 48 16 64 00 00 01 00 00 00 00 02 0e 0c .YH.d.....
00 00 00 00 00 00 00 00 00 00 00 00 0a 0a 00 00 .....
00 00 00 00 00 00 00 00 08 01 00 1a 04 00 00 00 .....
00 0b 0a 00 00 00 00 00 00 00 00 00 00 00 13 02 00 .....
01 28 0a 00 00 00 00 00 00 00 00 00 00 2a 01 00 .(.....*..
20 03 7e 01 00 03 01 00 1d 02 00 80 c0 0b 00 00 ..~.....
00 00 00 00 00 00 00 00 00 00 c1 09 00 00 00 00 .....
00 00 00 00 39 02 00 00 3f 0a 00 00 00 00 00 00 .....9...?.....
00 00 00 00 fc 02 00 00 00 .....

```

IP DATA

```

-----
54 41 4c 49 78 73 72 76 ac 00 78 6e 72 6d 00 00 TALIXsrv..xnm..
02 61 61 04 00 01 00 00 00 00 00 00 00 00 00 02 .aa.....
85 00 85 59 48 16 64 00 00 01 00 00 00 00 00 02 ...YH.d.....
0e 0c 00 00 00 00 00 00 00 00 00 00 00 0a 0a .....
00 00 00 00 00 00 00 00 00 00 08 01 00 1a 04 00 .....
00 00 00 0b 0a 00 00 00 00 00 00 00 00 00 00 13 .....
02 00 01 28 0a 00 00 00 00 00 00 00 00 00 00 2a ...(......*
01 00 20 03 7e 01 00 03 01 00 1d 02 00 80 c0 0b .....~.....
00 00 00 00 00 00 00 00 00 00 00 c1 09 00 00 00 .....
00 00 00 00 00 00 39 02 00 00 3f 0a 00 00 00 00 .....9...?.....
00 00 00 00 00 00 03 0c 00 04 00 01 00 fc 00 .....
04 00 0e 02 00 00 .....

```

-----  
BUFFER: 2  
-----

Filter used:

| DPCN  | SI | SSN | OPCN  | CICS | CICE | MODE    |
|-------|----|-----|-------|------|------|---------|
| 02137 | 05 | *** | 04185 | 0    | 100  | normerr |

Timestamp: 01-01-19 10:20:53.305  
Direction: Rx  
Error Code: 19

PSTN DATA

```

-----
IP DATA
-----
54 41 4c 49 78 73 72 76 ac 00 78 6e 72 6d 00 00 TALIXsrv..xnm..
02 61 61 04 00 01 00 00 00 00 00 00 00 00 00 02 .aa.....
85 00 85 59 48 16 a4 00 00 41 00 00 00 00 00 02 ...YH...A.....
0e 0c 00 00 00 00 00 00 00 00 00 00 00 0a 0a .....
00 00 00 00 00 00 00 00 00 00 08 01 00 1a 04 00 .....
00 00 00 0b 0a 00 00 00 00 00 00 00 00 00 00 13 .....
02 00 01 28 0a 00 00 00 00 00 00 00 00 00 00 2a ...(......*
01 00 20 03 7e 01 00 03 01 00 1d 02 00 80 c0 0b .....~.....
00 00 00 00 00 00 00 00 00 00 00 c1 09 00 00 00 .....
00 00 00 00 00 00 39 02 00 00 3f 0a 00 00 00 00 .....9...?.....
00 00 00 00 00 00 03 0c 00 04 00 01 00 fc 00 .....
04 00 0e 02 00 00 .....

```

MSUTRACE command complete

;

Retrieve contents of the trace buffers. The following example contains 1 stored trace buffer for a transmitted M3UA PDU.



**pass:loc=1303:cmd="msutrace -g trace"**

Command Accepted - Processing

```

eagle10202 01-01-19 10:20:56 GMT EAGLE5 31.6.0
pass:loc=1303:cmd="msutrace -g trace"
Command entered at terminal #4.
;

eagle10202 01-01-19 10:20:56 GMT EAGLE5 31.6.0
PASS: Command sent to card
;

eagle10202 01-01-19 10:20:56 GMT EAGLE5 31.6.0

MSUTRACE command in progress
;

eagle10202 01-01-19 10:20:56 GMT EAGLE5 31.6.0

-----
BUFFER: 0
-----
Filter used:

DPCA      SI SSN OPCA      CICS      CICE      MODE
001-001-001 5  *** 001-001-002 0      100      all

Timestamp: 02-06-07 08:40:29.435
Direction: Tx
Error Code: 0

PSTN DATA
-----
85 01 01 01 02 01 01 b2 00 00 01 00 00 00 03      .....
05 00 02 80 80 0d 00 00 21 43 65 87 09 21 43 65      .....!Ce..!Ce
87 09 01      ...

IP DATA
-----
01 00 01 01 00 00 00 3c 02 00 00 08 00 00 00 01      .....<.....
02 10 00 2b 00 01 01 02 00 01 01 01 05 02 00 b2      ...+.....
00 00 01 00 00 00 00 03 05 00 02 80 80 0d 00 00      .....
21 43 65 87 09 21 43 65 87 09 01 00      !Ce..!Ce....

MSUTRACE command complete
;

```

Retrieve contents of the trace buffers with ITU-I spare point codes. The following example contains 3 stored trace buffers.

pass:loc=1317:cmd="msutrace -g trace"

Command Accepted - Processing

eagle20003 05-01-27 10:16:03 EST EAGLE5 31.12.0
pass:loc=1317:cmd="msutrace -g trace"
Command entered at terminal #4.

;

eagle20003 05-01-27 10:16:03 EST EAGLE5 31.12.0
PASS: Command sent to card

;

eagle20003 05-01-27 10:16:03 EST EAGLE5 31.12.0

MSUTRACE command in progress

;

eagle20003 05-01-27 10:16:03 EST EAGLE5 31.12.0

-----
BUFFER: 0
-----

Filter used:

DPCI SI SSN OPCI CICS CICE MODE
s-2-011-1 2 \*\*\* \*\*\*\* \*\*\*\* \*\*\*\* all

Timestamp: 05-01-26 10:33:14.330
Direction: Tx
Error Code: 0

PSTN DATA
-----

02 59 50 16 a2 80 03 83 ce 46 0a 00 00 00 .YP.....F....

IP DATA
-----

54 41 4c 49 6d 74 70 33 0e 00 02 59 50 16 a2 80 TALImtp3...YP...
03 83 ce 46 0a 00 00 00 ...F....

-----
BUFFER: 1
-----

Filter used:

DPCI SI SSN OPCI CICS CICE MODE
s-2-011-1 2 \*\*\* \*\*\*\* \*\*\*\* \*\*\*\* all

Timestamp: 05-01-26 10:33:14.335
Direction: Tx
Error Code: 0

PSTN DATA
-----

02 59 50 16 a2 80 84 04 c8 46 0a 00 00 00 .YP.....F....

IP DATA
-----

54 41 4c 49 6d 74 70 33 0e 00 02 59 50 16 a2 80 TALImtp3...YP...
84 04 c8 46 0a 00 00 00 ...F....

-----
BUFFER: 2

```

-----
Filter used:

      DPCI      SI SSN      OPCI      CICS      CICE      MODE
s-2-011-1      2   ***      ****      ****      ****      all

Timestamp: 05-01-26 10:33:14.340
Direction: Tx
Error Code: 0

PSTN DATA
-----
02 59 50 16 f2 80 01 81 c1 46 0f 00 00 00      .YP.....F....

IP DATA
-----
54 41 4c 49 6d 74 70 33 0e 00 02 59 50 16 f2 80      TALImtp3...YP...
01 81 c1 46 0f 00 00 00      ...F....

MSUTRACE command complete

```

;

Clear the contents of the trace buffers:

**pass:loc=1105:cmd="msutrace -a clrtrace"**

Command Accepted - Processing

```

eagle20003 99-11-27 10:16:57 EST EAGLE5 31.6.0
pass:loc=1105:cmd="msutrace -a clrtrace"
Command entered at terminal #1.
;
eagle20003 99-11-27 10:16:57 EST EAGLE5 31.6.0
PASS: Command sent to card
;
eagle20003 99-11-27 10:16:57 EST EAGLE5 31.6.0
MSUTRACE command in progress
;
eagle20003 99-11-27 10:16:57 EST EAGLE5 31.6.0
MSUTRACE command completed
;

```

Activate MSU tracing:

**pass:loc=1105:cmd="msutrace -a acttrace"**

Command Accepted - Processing

```

eagle20003 99-11-27 10:16:57 EST EAGLE5 31.6.0
pass:loc=1105:cmd="msutrace -a acttrace"
Command entered at terminal #1.
;
eagle20003 99-11-27 10:16:57 EST EAGLE5 31.6.0
PASS: Command sent to card
;
eagle20003 99-11-27 10:16:57 EST EAGLE5 31.6.0
MSUTRACE command in progress
;
eagle20003 99-11-27 10:16:57 EST EAGLE5 31.6.0
MSUTRACE command completed
;

```

Deactivate MSU tracing:

**pass:loc=1105:cmd="msutrace -a dacttrace"**

Command Accepted - Processing

```

eagle20003 99-11-27 10:16:57 EST EAGLE5 31.6.0
pass:loc=1105:cmd="msutrace -a dacttrace"
Command entered at terminal #1.
;
eagle20003 99-11-27 10:16:57 EST EAGLE5 31.6.0
PASS: Command sent to card
;
eagle20003 99-11-27 10:16:57 EST EAGLE5 31.6.0
MSUTRACE command in progress
;
4.0.0
eagle20003 99-11-27 10:16:57 EST EAGLE5 31.6.0
MSUTRACE command completed
;

```

#### Examples for Entering a Filter Key

The output shown at the end of the following command examples is the same for each example, except for the echo of the entered command.

Command with the **-a chgfilter** option to insert a fully specified ANSI PC CIC filter key.

This filter key qualifies for capture MSUs with the following properties:

- DPC = 3-3-3 (ANSI)
- SI = 5
- OPC = 4-4-4 (ANSI)
- CIC = [10..1000]

**pass:loc=1105:cmd="msutrace -a chgfilter -p ansi -k 3-3-3:5:4-4-4:10:1000"**

Command with the **-a chgfilter** option to insert a fully specified ANSI SCCP filter.

This filter key qualifies for capture MSUs with the following properties:

- DPC = 3-3-3 (ANSI)
- SI = 3
- SSN = 230

**pass:loc=1105:cmd="msutrace -a chgfilter -k 3-3-3:3:230"**

Command with the **-a chgfilter** option to insert a fully specified ANSI DPC SI filter key.

This filter key qualifies for capture MSUs with the following properties:

- DPC = 3-3-3 (ANSI)
- SI = 6

**pass:loc=1105:cmd="msutrace -a chgfilter -k 3-3-3:6"**

Command with the **-a chgfilter** option to insert a fully specified ITUN24 PC CIC filter key.

This filter key qualifies for capture MSUs with the following properties:

- DPC = 13-103-3 (ITUN24)

- SI = 5
- OPC = 14-104-4 (ITUN24)
- CIC = [10..1000]

**pass:loc=1105:cmd="msutrace -a chgfilter -p itun24 -k 13-103-3:5:14-104-4:10:1000"**

Command with the **-a chgfilter** option to insert a partial ITUI DPC SI OPC filter key.

This filter key qualifies for capture MSUs with the following properties:

- DPC = 1-3-3 (ITUI)
- SI = 5
- OPC = 2-4-4 (ITUI)

**pass:loc=1105:cmd="msutrace -a chgfilter -p itui -k 1-3-3:5:2-4-4"**

Command with the **-a chgfilter** option to insert a partial DPC SI ITUN PC filter key, with the Duplicate Point Code feature turned off:

This filter key qualifies for capture MSUs with the following properties:

- DPC = 1536 (ITUN)
- SI = 5

**pass:loc=1105:cmd="msutrace -a chgfilter -p itun -k 1536:5"**

Command with the **-a chgfilter** option to insert a partial DPC SI ITUN PC filter key, with the Duplicate Point Code feature turned on:

This filter key qualifies for capture MSUs with the following properties:

- DPC = 1536-bb (ITUN)
- SI = 5

**pass:loc=1105:cmd="msutrace -a chgfilter -p itun -k 1536-bb:5"**

Command with the **-a chgfilter** option to insert a partial ANSI DPC filter key.

This filter key qualifies for capture MSUs with the following properties:

- DPC = 3-3-3 (ANSI)

**pass:loc=1105:cmd="msutrace -a chgfilter -k 3-3-3"**

Command with the **-a chgfilter** option to insert a partial SI filter key. Because no DPC or OPC field is specified, point code type does not have to be indicated.

This filter key qualifies for capture MSUs with the following properties:

- SI = 5

This filter key qualifies for capture MSUs with the following properties:

- DPC = 13-113-3 (ITUN24)

**pass:loc=1105:cmd="msutrace -a chgfilter -p itun24 -k 13-113-3"**

Command Accepted - Processing

```
eagle20003 06-06-01 10:16:57 EST EAGLE5 35.0.0
pass:loc=1105:cmd="msutrace -a chgfilter -p ansi -k 3-3-3:5:4-4-4:10:1000"
Command entered at terminal #1.
;
eagle20003 99-11-27 10:16:57 EST EAGLE5 31.6.0
PASS: Command sent to card
;
eagle20003 99-11-27 10:16:57 EST EAGLE5 31.6.0
MSUTRACE command in progress
;
eagle20003 99-11-27 10:16:57 EST EAGLE5 31.6.0
MSUTRACE command completed
;
```

The following commands include the **-m mode** option to change the trace capture mode.

Mode to have a 'capture-on-normalization error' property such that only MSUs with normalization processing errors are traced:

**pass:loc=1105:cmd="msutrace -a chgfilter -m normerr"**

Set a default filter key and the filter's mode at the same time:

**pass:loc=1105:cmd="msutrace -a chgfilter -k -t default -m all"**

Command Accepted - Processing

```
eagle20003 99-11-27 10:16:57 EST EAGLE5 31.6.0
pass:loc=1105:cmd="msutrace -a chgfilter -k -t default -m all"
Command entered at terminal #1.
;
eagle20003 99-11-27 10:16:57 EST EAGLE5 31.6.0
PASS: Command sent to card
;
eagle20003 99-11-27 10:16:57 EST EAGLE5 31.6.0
MSUTRACE command in progress
;
eagle20003 99-11-27 10:16:57 EST EAGLE5 31.6.0
MSUTRACE command completed
;
```

The following commands insert a partial DPC-SI filter key with ITU-I spare point code and show the **msutrace getfilter** command output with the filter key after the **chgfilter** command is processed to completion.

This filter key will qualify MSUs with at least the following properties:

- DPCI = (ITU-I Spare) 2-11-1
- SI=5

**pass:loc=1317:cmd="msutrace -a chgfilter -p ituis -k 2-11-1:5"**

Command Accepted - Processing

```
eagle20003 06-06-01 10:16:03 EST EAGLE5 35.5.0
pass:loc=1317:cmd="msutrace -a chgfilter -p ituis -k 2-11-1:5"
Command entered at terminal #1.
;
eagle20003 06-06-01 10:16:03 EST EAGLE5 35.5.0
PASS: Command sent to card
;
eagle20003 06-06-01 10:16:03 EST EAGLE5 35.5.0
MSUTRACE command in progress
;
eagle20003 06-06-01 10:16:03 EST EAGLE5 35.5.0
MSUTRACE command completed
;
```

**pass:loc=1317:cmd="msutrace -g config"**

Command Accepted - Processing

```
eagle20003 05-01-27 10:16:03 EST EAGLE5 31.12.0
pass:loc=1317:cmd="msutrace -g config"
;
eagle20003 05-01-27 10:16:03 EST EAGLE5 31.12.0
PASS: Command sent to card
;
eagle20003 05-01-27 10:16:03 EST EAGLE5 31.12.0
MSUTRACE command in progress
;
eagle20003 05-01-27 10:16:03 EST EAGLE5 31.12.0
MSUTRACE configurations

Trace = On

Trace buffers: 3 of 3 USED

MSUTRACE: filter settings
   DPCI      SI SSN   OPC1      CICS      CICE      MODE
s-2-011-1   5   ***   ****     ****     ****     all
;
eagle20003 05-01-27 10:16:03 EST EAGLE5 31.12.0
MSUTRACE command complete
;
```

The following commands insert a full DPC-SI-OPC filter key with an ITU-N spare point code when the Duplicate Point Code feature is on, and show the **msutrace getfilter** command output with the filter key after the **chgfilter** command is processed to completion.

This filter key will qualify MSUs with at least the following properties:

- DPC = (ITU-N Spare) 6234-aa
- SI=5
- OPC=(ITU-N Spare) 6233-aa
- CICS=1
- CICE=200

**pass:loc=1315:cmd="msutrace -a chgfilter -p ITUNS -k 6234-aa:5:6233-aa:1:200"**

Command Accepted - Processing

```
eagle20003 06-06-01 10:16:03 EST EAGLE5 35.0.0
pass:loc=1315:cmd="msutrace -a chgfilter -p ITUNS -k
6234-aa:5:6233-aa:1:200"
Command entered at terminal #1.
;
eagle20003 06-06-01 10:16:03 EST EAGLE5 35.0.0
PASS: Command sent to card
;
eagle20003 06-06-01 10:16:03 EST EAGLE5 35.0.0
MSUTRACE command in progress
;
eagle20003 06-06-01 10:16:03 EST EAGLE5 35.0.0
MSUTRACE command completed
;
```

**pass:loc=1317:cmd="msutrace -g config"**

Command Accepted - Processing

```
eagle20003 05-01-27 10:16:03 EST EAGLE5 31.12.0
pass:loc=1317:cmd="msutrace -g config"
Command entered at terminal #1.
;
eagle20003 05-01-27 10:16:03 EST EAGLE5 31.12.0
PASS: Command sent to card
;
eagle20003 05-01-27 10:16:03 EST EAGLE5 31.12.0
MSUTRACE command in progress
;
eagle20003 05-01-27 10:16:03 EST EAGLE5 31.12.0
MSUTRACE configurations

Trace = On

Trace buffers: 0 of 3 USED

MSUTRACE: filter settings
  DPCN      SI SSN      OPC1      CICS      CICE      MODE
s-6234-aa   5  ***   s-6233-aa  ****     ****     all
;
eagle20003 05-01-27 10:16:03 EST EAGLE5 31.12.0
MSUTRACE command complete
;
```

## netstat

## Network Statistics

This command is used to display network statistics from the TCP/IP stack. This command allows troubleshooting of network interface and routing configuration problems within the private EPAP-DSM IP network.

**Keyword:** netstat

**Command Class:** IP Stack Maintenance

### Options



Options and option parameters that are underlined indicate that a value must be specified for that option or parameter. For example, the **netstat** command option **-m** has the parameter **buffer pool**. The pool for which information will be displayed can be specified, as in the command **netstat -m sys**. Do not enter the underlined option or parameter; enter a value for the information represented by the underlined option or parameter.

**-a**

This option displays socket information for all protocols.

**-d**

This option displays driver measurement data.

The *-m* modifier displays multicast information. The *-p* modifier displays PHY registers. The *-z* modifier clears driver measurements. The *-h* modifier displays history measurements for the past 24 hours or the measurements collected a user defined hour ago. The *-f* modifier displays driver measurement data in full format (for GPLs that are loaded on E5-based cards only).

The *-m*, *-p*, and *-h* modifiers are not supported for GPLs that are loaded on E5-based cards.

**-e**

This option displays DPL driver measurement data. This option is supported only for GPLs that are loaded on E5-based cards.

**-f****-h**

This options provides help information for the command.

**-i**

This option displays interface information for all interfaces.

**-m buffer pool**

This option displays buffer pool information for the specified pool.

**Range: data, sys, dd**

**data**—SENS protocol stack data buffer pool

**sys**—system buffer pool

**dd**—Ethernet device driver buffer pool

**Default:** All three buffer pools are displayed.

**-p protocol**

This option displays information for the specified protocol.

**Range: tcp, udp, ip, icmp, sctp**

**tcp**—transmission control protocol

**udp**—user datagram protocol

**ip**—internet protocol

**icmp**—internet control message protocol

**sctp**—stream control transmission protocol

**Default:** None

**-r**

This option displays the Route table.

**Example**

```
pass:cmd="netstat -i":loc=1105
```

```
pass:cmd="netstat -a":loc=1111
```

```
pass:cmd="netstat -p tcp":loc=1111
```

```
pass:cmd="netstat -m data":loc=1105
```

**pass:cmd="netstat -r":loc=1105**

**pass:cmd="netstat -e":loc=1111**

**pass:cmd="netstat -d 0 -f":loc=1111**

### Dependencies

Only one of the options can be specified at a time.

### Notes

The **netstat** command is executed through the **pass** command.

The options {-m,-p,-h} are not supported for GPLs that are loaded on E5-based cards.

### Output for GPLs that are NOT loaded on E5-based cards

**pass:loc=1107:cmd="netstat"**

or

**pass:loc=1107:cmd="netstat -h"**

```
Command Accepted - Processing
```

```
tekelecstp 08-02-02 12:16:34 EST EAGLE 38.0.0
PASS: Command sent to card
```

```
Usage: netstat [-a] [-h] [-m data|sys|dd] [-p icmp|igmp|ip|sctp|tcp|udp]
        [-i] [-r] [-d 0|1 [-m] [-p] [-z] [-h 1..24]]
```

```
Options:
```

```
-a      display socket information for all protocols
-h      Displays this message
-m      display buffer pool information for 1 of the system pools
-p      display socket information for 1 of the protocols
-i      display interface information for all interfaces
-r      display the route table information
-d      display driver measurement data
```

```
;
```

```
tekelecstp 08-02-02 12:16:34 EST EAGLE 38.0.0
```

```
NETSTAT command complete
```

```
;
```

pass: loc=1105: cmd="netstat -a"

Command Accepted - Processing

tekelecstp 08-02-07 07:59:12 EST EAGLE 38.0.0  
PASS: Command sent to card

;

tekelecstp 08-02-07 07:59:12 EST EAGLE 38.0.0

Active Internet connections (including servers)

| PCB     | Proto | Recv-Q | Send-Q | Local Address   |  | (state) |
|---------|-------|--------|--------|-----------------|--|---------|
|         |       |        |        | Foreign Address |  |         |
| 11df510 | TCP   | 0      | 0      | 0.0.0.0.111     |  | LISTEN  |
|         |       |        |        | 0.0.0.0.0       |  |         |
| 11df384 | UDP   | 0      | 0      | 0.0.0.0.1008    |  |         |
|         |       |        |        | 0.0.0.0.0       |  |         |
| 11df48c | UDP   | 0      | 0      | 0.0.0.0.111     |  |         |
|         |       |        |        | 0.0.0.0.0       |  |         |

;

tekelecstp 08-02-07 07:59:12 EST EAGLE 38.0.0

NETSTAT command complete

pass: loc=1105: cmd="netstat -i"

```

tekelecstp 08-02-07 07:59:20 EST EAGLE 38.0.0
PASS: Command sent to card
;

tekelecstp 08-02-07 07:59:20 EST EAGLE 38.0.0
lo (unit number 0):
  Flags: (0x8069) UP LOOPBACK MULTICAST ARP RUNNING 10MB HDX DIX
  Type: SOFTWARE_LOOPBACK
  Internet address: 127.0.0.1
  Netmask 0xff000000 Subnetmask 0xff000000
  Metric is 0
  Maximum Transfer Unit size is 32768
  6 packets received; 6 packets sent
  0 multicast packets received
  0 multicast packets sent
  0 input errors; 0 output errors
  0 collisions; 0 dropped
seeq (unit number 0):
  Flags: (0x63) UP BROADCAST ARP RUNNING 10MB HDX DIX
  Type: ETHERNET_CSMACD
  Internet address: 192.168.100.112
  Broadcast address: 192.168.100.255
  Netmask 0xffffffff00 Subnetmask 0xffffffff00
  Ethernet address is 00:00:17:04:00:61
  Metric is 0
  Maximum Transfer Unit size is 1500
  5 packets received; 1 packets sent
  5 multicast packets received
  0 multicast packets sent
  0 input errors; 0 output errors
  0 collisions; 0 dropped
seeq (unit number 1):
  Flags: (0x63) UP BROADCAST ARP RUNNING 10MB HDX DIX
  Type: ETHERNET_CSMACD
  Internet address: 192.168.55.112
  Broadcast address: 192.168.55.255
  Netmask 0xffffffff00 Subnetmask 0xffffffff00
  Ethernet address is 00:00:17:04:00:62
  Metric is 0
  Maximum Transfer Unit size is 1500
  28 packets received; 16 packets sent
  13 multicast packets received
  0 multicast packets sent
  0 input errors; 0 output errors
  0 collisions; 0 dropped
;

eagle20004 08-02-07 07:59:20 EST EAGLE 38.0.0

NETSTAT command complete

```

pass: loc=1105: cmd="netstat -m data"

Command Accepted - Processing

tekelecstp 08-02-07 07:59:56 EST EAGLE 38.0.0  
PASS: Command sent to card

;

eagle20004 08-02-07 07:59:56 EST EAGLE 38.0.0

type number

-----

FREE : 9553

DATA : 0

HEADER : 0

SOCKET : 0

PCB : 0

RTABLE : 0

HTABLE : 0

ATABLE : 0

SONAME : 0

ZOMBIE : 0

SOOPTS : 0

FTABLE : 0

RIGHTS : 0

IFADDR : 0

CONTROL : 0

OOBDATA : 0

IPMOPTS : 0

IPMADDR : 0

IFMADDR : 0

MRTABLE : 0

TOTAL : 9553

number of mbufs: 9553

number of times failed to find space: 0

number of times waited for space: 0

number of times drained protocols for space: 0

-----

CLUSTER POOL TABLE

-----

| size | clusters | free | usage |
|------|----------|------|-------|
| 64   | 1000     | 1000 | 41    |
| 128  | 1250     | 1250 | 848   |
| 256  | 1250     | 1250 | 0     |
| 512  | 200      | 200  | 0     |
| 1024 | 100      | 100  | 0     |
| 2048 | 20       | 20   | 0     |

-----

64 1000 1000 41

128 1250 1250 848

256 1250 1250 0

512 200 200 0

1024 100 100 0

2048 20 20 0

-----

;

tekelecstp 08-02-07 07:59:56 EST EAGLE 38.0.0

NETSTAT command complete

pass: loc=1105: cmd="netstat -m sys"

Command Accepted - Processing

tekelecstp 08-02-07 08:00:14 EST EAGLE 38.0.0  
PASS: Command sent to card

;

eagle20004 08-02-07 08:00:14 EST EAGLE 38.0.0

type            number  
-----

```

FREE      :      3069
DATA      :         0
HEADER    :         0
SOCKET    :         3
PCB       :         4
RTABLE    :        17
HTABLE    :         0
ATABLE    :         0
SONAME    :         0
ZOMBIE    :         0
SOOPTS    :         0
FTABLE    :         0
RIGHTS    :         0
IFADDR    :         6
CONTROL   :         0
OOBDATA   :         0
IPMOPTS   :         0
IPMADDR   :         1
IFMADDR   :         0
MRTABLE   :         0
TOTAL     :        3100

```

number of mbufs: 3100

number of times failed to find space: 0

number of times waited for space: 0

number of times drained protocols for space: 0

-----  
CLUSTER POOL TABLE

```

size      clusters  free      usage
-----
64        650        640        12
128       200        188        33
256       500        494         6
512       200        197        24
-----

```

;

tekelecstp 08-02-07 08:00:14 EST EAGLE 38.0.0

NETSTAT command complete

**pass: loc=1105: cmd="netstat -m dd"**

Command Accepted - Processing

tekelecstp 08-02-07 08:00:24 EST EAGLE 38.0.0  
PASS: Command sent to card

;

tekelecstp 08-02-07 08:00:24 EST EAGLE 38.0.0

END-0 Buffer Pool

-----  
CLUSTER POOL TABLE  
-----

| size | clusters | free | usage |
|------|----------|------|-------|
| 1528 | 80       | 77   | 10    |

END-1 Buffer Pool

-----  
CLUSTER POOL TABLE  
-----

| size | clusters | free | usage |
|------|----------|------|-------|
| 1528 | 80       | 72   | 58    |

;

tekelecstp 08-02-07 08:00:24 EST EAGLE 38.0.0

NETSTAT command complete

**pass: loc=1105: cmd="netstat -p icmp"**

```
Command Accepted - Processing
;
tekelecstp 08-02-07 08:00:29 EST EAGLE 38.0.0
0966.1083 SYSTEM INFO REPT COND: system alive
Report Date:08-02-27 Time:08:00:29
;
tekelecstp 08-02-27 08:00:29 EST EAGLE 38.0.0
PASS: Command sent to card
;
tekelecstp 08-02-27 08:00:29 EST EAGLE 38.0.0
ICMP:
  1 call to icmp_error
  0 error not generated because old message was icmp
  Output histogram:
    destination unreachable: 1
  0 message with bad code fields
  0 message < minimum length
  0 bad checksum
  0 message with bad length
  Input histogram:
    echo reply: 6
    destination unreachable: 1
  0 message response generated
;
tekelecstp 08-02-07 08:00:29 EST EAGLE 38.0.0
NETSTAT command complete
```



**pass: loc=1105: cmd="netstat -p ip"**

Command Accepted - Processing

tekelecstp 08-02-07 08:00:44 EST EAGLE 38.0.0  
PASS: Command sent to card

;

tekelecstp 08-02-07 08:00:44 EST EAGLE 38.0.0  
IP:

```
48 total
0 badsum
0 tooshort
0 toosmall
0 badhlen
0 badlen
0 infragments
0 fragdropped
0 fragtimeout
0 forward
14 cantforward
0 redirectsent
1 unknownprotocol
0 nobuffers
0 reassembled
0 outfragments
0 noroute
```

;

tekelecstp 08-02-07 08:00:44 EST EAGLE 38.0.0

NETSTAT command complete

**pass: loc=1105: cmd="netstat -p tcp"**

Command Accepted - Processing

tekelecstp 08-02-07 08:00:54 EST EAGLE 38.0.0  
PASS: Command sent to card

;

tekelecstp 08-02-07 08:00:54 EST EAGLE 38.0.0

TCP:

```

0 packet sent
    0 data packet (0 byte)
    0 data packet (0 byte) retransmitted
    0 ack-only packet (0 delayed)
    0 URG only packet
    0 window probe packet
    0 window update packet
    0 control packet
0 packet received
    0 ack (for 0 byte)
    0 duplicate ack
    0 ack for unsent data
    0 packet (0 byte) received in-sequence
    0 completely duplicate packet (0 byte)
    0 packet with some dup. data (0 byte duped)
    0 out-of-order packet (0 byte)
    0 packet (0 byte) of data after window
    0 window probe
    0 window update packet
    0 packet received after close
    0 discarded for bad checksum
    0 discarded for bad header offset field
    0 discarded because packet too short
0 connection request
0 connection accept
0 connection established (including accepts)
0 connection closed (including 0 drop)
0 embryonic connection dropped
0 segment updated rtt (of 0 attempt)
0 retransmit timeout
    0 connection dropped by rexmit timeout
0 persist timeout
0 keepalive timeout
    0 keepalive probe sent
    0 connection dropped by keepalive
0 pcb cache lookup failed

```

;

tekelecstp 08-01-07 08:00:54 EST EAGLE 38.0.0

NETSTAT command complete

pass:loc=1305:cmd="netstat -p sctp"

Command Accepted - Processing

tekelecstp 08-01-25 11:20:41 EST EAGLE 38.0.0
PASS: Command sent to card

;

tekelecstp 08-01-25 11:20:41 EST EAGLE 38.0.0
ip packets sent..... 1474882
ip packets sent with data chunk..... 306354
control chunks (excluding retransmissions)..... 1172759
ordered data chunks (excluding retransmissions).. 1534350
unordered data chunks (excluding retransmissions) 0
user messages fragmented due to MTU..... 0
retransmit data chunks sent..... 4
sacks sent..... 496302
send failed..... 0
ip packets received..... 1816035
ip packets received with data chunk..... 989957
control chunks (excluding duplicates)..... 833141
ordered data chunks (excluding duplicates)..... 989968
unordered data chunks (excluding duplicates).... 0
user messages reassembled..... 0
data chunks read..... 988601
duplicate tsns received..... 0
sacks received..... 153763
gap ack blocks received..... 0
out of the blue..... 4
with invalid checksum..... 0
connections established..... 2954
by upper layer..... 0
by remote endpoint..... 2958
connections terminated..... 4
ungracefully..... 2952
gracefully..... 0
associations dropped due to retransmits..... 0
consecutive retransmit timeouts..... 4
retransmit timer count..... 6
fast retransmit count..... 0
heartbeat requests received..... 330275
heartbeat acks received..... 340239
heartbeat requests sent..... 340258
associations supported..... 50
milliseconds cookie life at 4-way start-up handshake. 5000
retransmission attempts allowed at start-up phase.... 8

;

tekelecstp 08-01-25 11:20:41 EST EAGLE 38.0.0

NETSTAT command complete

**pass: loc=1105: cmd="netstat -p udp"**

```

Command Accepted - Processing

tekelecstp 08-02-10 08:01:05 EST  EAGLE 38.0.0
PASS: Command sent to card
;

tekelecstp 08-02-10 08:01:05 EST  EAGLE 38.0.0
UDP:
  42 total packets
  29 input packets
  13 output packets
  0 incomplete header
  0 bad data length field
  0 bad checksum
  16 broadcasts received with no ports
  0 full socket
  13 pcb cache lookups failed
  1 pcb hash lookup failed
;

tekelecstp 08-02-10 08:01:05 EST  EAGLE 38.0.0

NETSTAT command complete

```

**pass: loc=1105: cmd="netstat -r"**

```

Command Accepted - Processing

tekelecstp 08-02-07 08:01:14 EST  EAGLE 38.0.0
PASS: Command sent to card
;

tekelecstp 08-02-07 08:01:14 EST  EAGLE 38.0.0

ROUTE NET TABLE
destination      gateway          flags  Refcnt  Use      Interface
-----
0.0.0.0          192.168.55.250  3      0       14      seeq1
192.168.55.0    192.168.55.112  101    0       0       seeq1
192.168.100.0   192.168.100.112 101    0       0       seeq0
-----

ROUTE HOST TABLE
destination      gateway          flags  Refcnt  Use      Interface
-----
127.0.0.1       127.0.0.1       5      1       6       lo0
-----

;

tekelecstp 08-02-07 08:01:14 EST  EAGLE 38.0.0

NETSTAT command complete

```

pass:loc=1107:cmd="netstat -d 0"

Command Accepted - Processing

```
tekelecstp 08-01-30 09:49:57 EST EAGLE 38.0.0
6734.1083 SYSTEM INFO REPT COND: system alive
Report Date:08-01-30 Time:09:49:57
```

;

```
tekelecstp 08-01-30 09:49:57 EST EAGLE 38.0.0
PASS: Command sent to card
```

;

```
tekelecstp 08-01-30 09:49:57 EST EAGLE 38.0.0
```

```
Report Time      = 05-11-30 09:50:01.435
Card Load Time   = 05-11-29 16:46:49.775
Last Reset Time  = 05-11-29 16:46:49.775
```

```
overflow = 0          excess coll. = 0          align. error = 0
crc = 0              underflow = 0            rx collision = 0
dribble = 0          late coll. = 0           very long = 0
short fr = 0         coll. = 0              exc defer = 0
oversize = 0         cs error = 0            rxerror = 132
rxabort = 0          tx bytes = 60          rx broadcast = 104853
read err = 0         tx frames = 1           tx broadcast = 1
rx bytes = 6385476  tx frames = 1           tx multicast = 0
rx frames = 104856
bit bucket = 0
term count = 0
runts = 0
```

;

**pass:loc=1107:cmd="netstat -d 0 -m"**

Command Accepted - Processing

```
tekelecstp 08-02-02 10:34:59 EST EAGLE 38.0.0
6734.1083   SYSTEM          INFO   REPT COND: system alive
          Report Date:08-02-02   Time:10:34:59
```

;

```
tekelecstp 08-02-02 10:34:59 EST EAGLE 38.0.0
PASS: Command sent to card
```

;

```
tekelecstp 08-02-02 10:34:59 EST EAGLE 38.0.0
```

```
Report Time      = 05-12-02 10:35:01.755
Card Load Time   = 05-11-30 16:14:26.590
Last Reset Time  = 05-11-30 16:14:26.590
```

IP Multicast Reference Table

| Bit    | 0 | 1 | 2 | 3 | 4 | 5 | 6 | 7 |
|--------|---|---|---|---|---|---|---|---|
| Byte-0 | 0 | 0 | 0 | 0 | 0 | 0 | 0 | 0 |
| Byte-1 | 0 | 0 | 0 | 0 | 0 | 0 | 0 | 0 |
| Byte-2 | 0 | 0 | 0 | 0 | 0 | 0 | 0 | 0 |
| Byte-3 | 0 | 0 | 0 | 0 | 0 | 0 | 0 | 0 |
| Byte-4 | 0 | 0 | 0 | 0 | 0 | 0 | 0 | 0 |
| Byte-5 | 0 | 0 | 0 | 0 | 0 | 0 | 0 | 0 |
| Byte-6 | 0 | 0 | 0 | 0 | 0 | 0 | 1 | 0 |
| Byte-7 | 0 | 0 | 0 | 0 | 0 | 0 | 0 | 0 |

Multicast MAC Address List

| MAC Addr          | Ref-Cnt | Byte | Bit |
|-------------------|---------|------|-----|
| 01:00:5e:00:00:01 | 01      | 6    | 6   |

```
Hardware Multicast Filter Register (unit=0)
00 00 00 00 00 00 40 00
```

;

```
tekelecstp 08-02-02 10:34:59 EST EAGLE 38.0.0
```

```
NETSTAT command complete
```

;

**pass:loc=1107:cmd="netstat -d 1 -m"**

Command Accepted - Processing

tekelecstp 08-01-30 09:51:07 EST EAGLE 38.0.0  
PASS: Command sent to card

;

tekelecstp 08-01-30 09:51:07 EST EAGLE 38.0.0

Report Time = 05-11-30 09:51:07.745  
Card Load Time = 05-11-29 16:46:49.775  
Last Reset Time = 05-11-30 09:50:43.510

Multicast is NOT enabled for unit=1

;

tekelecstp 08-01-30 09:51:07 EST EAGLE 38.0.0

NETSTAT command complete

;

**pass:loc=1107:cmd="netstat -d 0 -p"**

Command Accepted - Processing

tekelecstp 08-01-30 09:50:55 EST EAGLE 38.0.0  
PASS: Command sent to card

;

tekelecstp 08-01-30 09:50:55 EST EAGLE 38.0.0

| Register      | Value    |
|---------------|----------|
| -----         | -----    |
| Control       | = 0x2100 |
| Status        | = 0x7809 |
| PHY ID #1     | = 0x0016 |
| PHY ID #2     | = 0xf831 |
| AN Adv.       | = 0x01e1 |
| AN REC        | = 0x0000 |
| Config #1     | = 0x0022 |
| Config #2     | = 0xff00 |
| Status Output | = 0x02c0 |
| Mask          | = 0xfff0 |

;

tekelecstp 08-01-30 09:50:55 EST EAGLE 38.0.0

NETSTAT command complete

;

**pass:loc=1107:cmd="netstat -d 0 -z"**

```
Command Accepted - Processing

tekelecstp 08-01-30 09:50:43 EST EAGLE 38.0.0
PASS: Command sent to card
;

tekelecstp 08-01-30 09:50:43 EST EAGLE 38.0.0

Report Time      = 05-11-30 09:50:43.510
Card Load Time   = 05-11-29 16:46:49.775
Last Reset Time  = 05-11-30 09:50:43.510

overflow = 0          excess coll. = 0          align. error = 0
crc = 0              underflow = 0          rx collision = 0
dribble = 0          late coll. = 0         very long = 0
short fr = 0         coll. = 0              exc defer = 0
oversize = 0         cs error = 0           rxerror = 0
rxabort = 0          tx bytes = 0           rx broadcast = 0
read err = 0         tx frames = 0          tx broadcast = 0
rx bytes = 0                                     tx multicast = 0
rx frames = 0
bit bucket = 0
term count = 0
runts = 0

Driver measurements for unit=0 cleared
;

tekelecstp 08-01-30 09:50:43 EST EAGLE 38.0.0

NETSTAT command complete
;
```



pass:loc=1107:cmd="netstat -d 0 -h"

Command Accepted - Processing

tekelecstp 08-01-30 09:50:12 EST EAGLE 38.0.0  
 PASS: Command sent to card

;

tekelecstp 08-01-30 09:50:12 EST EAGLE 38.0.0

Report Time = 05-11-30 09:50:12.500  
 Card Load Time = 05-11-29 16:46:49.775  
 Last Reset Time = 05-11-29 16:46:49.775

| Hours Ago | Tx Frames | Tx Errors | Rx Frames | Rx Errors |
|-----------|-----------|-----------|-----------|-----------|
| 1         | 0         | 0         | 6298      | 0         |
| 2         | 0         | 0         | 6295      | 0         |
| 3         | 0         | 0         | 6295      | 0         |
| 4         | 0         | 0         | 6295      | 0         |
| 5         | 0         | 0         | 6295      | 0         |
| 6         | 0         | 0         | 6295      | 0         |
| 7         | 0         | 0         | 6296      | 0         |
| 8         | 0         | 0         | 6296      | 0         |
| 9         | 0         | 0         | 6294      | 0         |
| 10        | 0         | 0         | 6294      | 0         |
| 11        | 0         | 0         | 6295      | 0         |
| 12        | 0         | 0         | 6296      | 0         |
| 13        | 0         | 0         | 6294      | 0         |
| 14        | 0         | 0         | 6295      | 0         |
| 15        | 0         | 0         | 6294      | 0         |
| 16        | 0         | 0         | 5248      | 0         |
| 17        | 1         | 0         | 4852      | 0         |
| 18        | --        | --        | --        | --        |
| 19        | --        | --        | --        | --        |
| 20        | --        | --        | --        | --        |
| 21        | --        | --        | --        | --        |
| 22        | --        | --        | --        | --        |
| 23        | --        | --        | --        | --        |
| 24        | --        | --        | --        | --        |

;

tekelecstp 08-01-30 09:50:12 EST EAGLE 38.0.0

NETSTAT command complete

;

**pass:loc=1107:cmd="netstat -d 0 -h 18"**

Command Accepted - Processing

tekelecstp 08-01-30 10:20:57 EST EAGLE 38.0.0  
PASS: Command sent to card

;

tekelecstp 08-01-30 10:20:57 EST EAGLE 38.0.0

Report Time = 05-11-30 10:20:57.735  
Card Load Time = 05-11-29 16:46:49.775  
Last Reset Time = 05-11-30 09:51:22.480

NETSTAT: Invalid hour number, cannot display 18 hour(s) ago.  
Stats have only been saved for 17 hour(s).

;

tekelecstp 08-01-30 10:20:57 EST EAGLE 38.0.0

NETSTAT command complete

;

**pass:loc=1107:cmd="netstat -d 0 -h 15"**

Command Accepted - Processing

;

tekelecstp 08-01-30 09:50:24 EST EAGLE 38.0.0  
PASS: Command sent to card

;

tekelecstp 08-01-30 09:50:24 EST EAGLE 38.0.0

Report Time = 05-11-30 09:50:24.080  
Card Load Time = 05-11-29 16:46:49.775  
Last Reset Time = 05-11-29 16:46:49.775

|                   |                  |                     |
|-------------------|------------------|---------------------|
| overflow = 0      | excess coll. = 0 | align. error = 0    |
| crc = 0           | underflow = 0    | rx collision = 0    |
| dribble = 0       | late coll. = 0   | very long = 0       |
| short fr = 0      | coll. = 0        | exc defer = 0       |
| oversize = 0      | cs error = 0     | rxerror = 0         |
| rxabort = 0       | tx bytes = 0     | rx broadcast = 6296 |
| read err = 0      | tx frames = 0    | tx broadcast = 0    |
| rx bytes = 383160 |                  | tx multicast = 0    |
| rx frames = 6294  |                  |                     |
| bit bucket = 0    |                  |                     |
| term count = 0    |                  |                     |
| runts = 0         |                  |                     |

;

tekelecstp 08-01-30 09:50:24 EST EAGLE 38.0.0

NETSTAT command complete

;

**Output for GPLs on E5-based Cards**

```
pass:cmd="netstat":loc=1111
```

or

```
pass:cmd="netstat -h":loc=1111
```

```
Command Accepted - Processing

tekelecstp 08-01-19 04:43:47 EST EAGLE 38.0.0
PASS: Command sent to card
;

tekelecstp 08-01-19 04:43:47 EST EAGLE 38.0.0

Usage: netstat [-a] [-e] [-h] [-m data|sys|dd] [-p icmp|igmp|ip|sctp|tcp|udp
]
                [-i] [-r] [-d 0|1 [-m] [-p] [-z] [-h 1..24] [-f]]

Options:
-a             display socket information for all protocols
-e             display DPL driver measurement data
-d             display Ethernet driver measurement data
-h             display this message
-m             display buffer pool information for 1 of the system pools
-p             display socket information for 1 of the protocols
-i             display interface information for all interfaces
-r             display the route table information
;

tekelecstp 08-01-19 04:43:47 IST EAGLE 38.0.0

NETSTAT command complete
;
```

**pass:cmd="netstat -a":loc=1111**

Command Accepted - Processing

```
tekelecstp 08-06-21 16:26:30 IST EAGLE5 39.0.0
pass:cmd="netstat -a":loc=1105
Command entered at terminal #3.
```

;

```
tekelecstp 08-06-21 16:26:30 IST EAGLE5 39.0.0
PASS: Command sent to card
```

;

```
tekelecstp 08-06-21 16:26:30 IST EAGLE5 39.0.0
SDS Shell Output
```

```
-> tklc_inetstatShow
PCB      Proto Recv-Q   Send-Q   Local Address   (state)
          Foreign Address
-----
2354720  TCP          0         0  0.0.0.0.23     LISTEN
          0.0.0.0.0
232cd60  UDP    16921935     0  0.0.0.0.161
          0.0.0.0.0
232cc20  UDP          0         0  127.0.0.1.1026
          127.0.0.1.17185
232cae0  UDP    16921930     0  0.0.0.0.17185
          0.0.0.0.0
232c9a0  UDP    16921922     0  0.0.0.0.68
          0.0.0.0.0
232c5e0  UDP    16921912     0  127.0.0.1.1024
          0.0.0.0.0
232c220  UDP          0         0  127.0.0.1.1025
          127.0.0.1.1024

value = 1 = 0x1
```

;

```
tekelecstp 08-06-21 16:26:30 IST EAGLE5 39.0.0
```

;

```
tekelecstp 08-06-21 16:26:30 IST EAGLE5 39.0.0
NETSTAT command complete
```

;

pass:cmd="netstat -e":loc=1111

Command Accepted - Processing

tekelecstp 08-01-19 04:45:51 EST EAGLE 38.0.0  
PASS: Command sent to card

;

tekelecstp 08-01-19 04:45:51 EST EAGLE 38.0.0

Dual Port Link Statistics

|                           |                          |
|---------------------------|--------------------------|
| In Ucast Octets = 0       | In Ucast Pkts = 0        |
| Out Ucast Octet = 0       | Out Ucast Pkts = 0       |
| Out Bcast Octets = 0      | Out Bcast Pkts = 0       |
| Out Ucast Octets Err = 0  | Out Ucast Pkts Err = 0   |
| Out Bcast Octet Err = 0   | Out Bcast Pkts Err = 0   |
| Invalied copy lenthns = 0 | IP Frame too big = 0     |
| No Mbufs Avail = 0        | No System bufs Avail = 0 |
| TVG Func Err = 0          | System buf Err = 0       |
| Inbound too big = 0       |                          |

;

tekelecstp 08-01-19 04:45:51 EST EAGLE 38.0.0

NETSTAT command complete

;

**pass:cmd="netstat -i":loc=1111**

```

Command Accepted - Processing

tekelecstp 08-01-19 04:46:02 EST EAGLE 38.0.0
PASS: Command sent to card
;

tekelecstp 08-01-19 04:46:02 EST EAGLE 38.0.0
SDS Shell Output

-> tklc_ifShow
lo (unit number 0):
  Flags: (0x48049) UP LOOPBACK MULTICAST TRAILERS ARP RUNNING INET_UP
  Type: SOFTWARE_LOOPBACK
  inet: 127.0.0.1
  Netmask 0xff000000 Subnetmask 0xff000000
  Metric is 0
  Maximum Transfer Unit size is 1536
  0 packets received; 1 packets sent
  0 multicast packets received
  0 multicast packets sent
  0 input errors; 0 output errors
  0 collisions; 0 dropped
  0 output queue drops
DPLend (unit number 0):
  Flags: (0x20043) UP BROADCAST ARP RUNNING
  Type: ETHERNET_CSMACD
  Ethernet address is 00:00:00:00:00:00
  Metric is 0
  Maximum Transfer Unit size is 485
  0 octets received
  0 octets sent
  0 unicast packets received
  0 unicast packets sent
  0 non-unicast packets received
  0 non-unicast packets sent
  0 incoming packets discarded
  0 outgoing packets discarded
  0 incoming errors
  0 outgoing errors
  0 unknown protos
  0 collisions; 0 dropped
  0 output queue drops
gei (unit number 2):
  Flags: (0x70043) UP BROADCAST ARP RUNNING INET_UP AUTONEG 100MB FDX DIX

  Type: ETHERNET_CSMACD
  inet: 192.168.55.203
  Broadcast address: 192.168.55.255
  Netmask 0xffffffff Subnetmask 0xffffffff00
  Ethernet address is 00:00:17:0c:dd:e0
  Metric is 0
  Maximum Transfer Unit size is 1500
  1708790504 octets received
  989333197 octets sent
  392089485 unicast packets received
  712715002 unicast packets sent
  0 multicast packets received
  0 multicast packets sent
  514480 broadcast packets received
  7 broadcast packets sent
  0 incoming packets discarded
  0 outgoing packets discarded
  0 incoming errors
  0 outgoing errors
  0 unknown protos

```

```
        0 collisions; 0 dropped
        0 output queue drops
value = 26 = 0x1a
;
tekelecstp 08-01-19 04:46:02 EST EAGLE 38.0.0
NETSTAT command complete
;
```

The following example displays BOND interfaces. These interfaces are supported by only E5-SM4G cards.

**pass:cmd="netstat -i":loc=1111**

Command Accepted - Processing

```
tekelecstp 08-06-21 03:10:00 IST EAGLE 39.0.0
pass:cmd="netstat -i":loc=1107
Command entered at terminal #2.
```

;

```
tekelecstp 08-06-21 03:10:00 IST EAGLE 39.0.0
PASS: Command sent to card
```

;

```
tekelecstp 08-06-21 03:10:00 IST EAGLE 39.0.0
SDS Shell Output
```

-&gt; tklc\_ifShow

lo (unit number 0):

```
Flags: (0x48049) UP LOOPBACK MULTICAST TRAILERS ARP RUNNING INET_UP
Type: SOFTWARE_LOOPBACK
inet: 127.0.0.1
Netmask 0xff000000 Subnetmask 0xff000000
Metric is 0
Maximum Transfer Unit size is 1536
0 packets received; 1 packets sent
0 multicast packets received
0 multicast packets sent
0 input errors; 0 output errors
0 collisions; 0 dropped
0 output queue drops
```

DPLend (unit number 0):

```
Flags: (0x20043) UP BROADCAST ARP RUNNING
Type: ETHERNET_CSMACD
Ethernet address is 00:00:00:00:00:00
Metric is 0
Maximum Transfer Unit size is 485
0 octets received
0 octets sent
0 unicast packets received
0 unicast packets sent
0 non-unicast packets received
0 non-unicast packets sent
0 incoming packets discarded
0 outgoing packets discarded
0 incoming errors
0 outgoing errors
0 unknown protos
0 collisions; 0 dropped
0 output queue drops
```

gei (unit number 0):

```
Flags: (0x78042) DOWN BROADCAST MULTICAST ARP RUNNING INET_UP 100MB HDX
```

DIX

```
Type: ETHERNET_CSMACD
inet: 192.168.122.4
Broadcast address: 192.168.122.255
Netmask 0xffffffff00 Subnetmask 0xffffffff00
Ethernet address is 00:00:17:0d:0f:3a
Metric is 0
Maximum Transfer Unit size is 1500
0 octets received
0 octets sent
0 unicast packets received
0 unicast packets sent
0 multicast packets received
0 multicast packets sent
0 broadcast packets received
0 broadcast packets sent
```



```

    0 incoming packets discarded
    0 outgoing packets discarded
    0 incoming errors
    0 outgoing errors
    0 unknown protos
    0 collisions; 0 dropped
    0 output queue drops
gei (unit number 1):
  Flags: (0x78042) DOWN BROADCAST MULTICAST ARP RUNNING INET_UP 10MB HDX
DIX
  Type: ETHERNET_CSMACD
  inet: 192.168.121.4
  Broadcast address: 192.168.121.255
  Netmask 0xffffffff00 Subnetmask 0xffffffff00
  Ethernet address is 00:00:17:0d:0f:3b
  Metric is 0
  Maximum Transfer Unit size is 1500
  0 octets received
  0 octets sent
  0 unicast packets received
  0 unicast packets sent
  0 multicast packets received
  0 multicast packets sent
  0 broadcast packets received
  0 broadcast packets sent
  0 incoming packets discarded
  0 outgoing packets discarded
  0 incoming errors
  0 outgoing errors
  0 unknown protos
  0 collisions; 0 dropped
  0 output queue drops
Bond (unit number 0):
  Flags: (0x60043) UP BROADCAST ARP RUNNING INET_UP
  Type: ETHERNET_CSMACD
  inet: 192.168.123.4
  Broadcast address: 192.168.123.255
  Netmask 0xffffffff00 Subnetmask 0xffffffff00
  Ethernet address is 00:00:00:00:00:00
  Metric is 0
  Maximum Transfer Unit size is 485
  0 octets received
  0 octets sent
  0 unicast packets received
  0 unicast packets sent
  0 non-unicast packets received
  0 non-unicast packets sent
  0 incoming packets discarded
  0 outgoing packets discarded
  0 incoming errors
  0 outgoing errors
  0 unknown protos
  0 collisions; 0 dropped
  0 output queue drops
value = 26 = 0x1a
;
tekelecstp 08-06-21 03:10:00 IST EAGLE 39.0.0
;
tekelecstp 08-06-21 03:10:00 IST EAGLE 39.0.0
NETSTAT command complete

```

```

;

pass:cmd="netstat -m data":loc=1111

Command Accepted - Processing

tekelecstp 08-01-19 04:46:24 EST EAGLE5 38.0.0
PASS: Command sent to card
;

tekelecstp 08-01-19 04:46:24 EST EAGLE5 38.0.0
SDS Shell Output

-> netStackDataPoolShow
type          number
-----
FREE          :    37587
DATA          :      23
HEADER        :     22
SOCKET        :      0
PCB           :      0
RTABLE        :      0
HTABLE        :      0
ATABLE        :      0
SONAME        :      0
ZOMBIE        :      0
SOOPTS        :      0
FTABLE        :      0
RIGHTS        :      0
IFADDR        :      0
CONTROL       :      0
OOBDATA       :      0
IPMOPTS       :      0
IPMADDR       :      0
IFMADDR       :      0
MRTABLE       :      0
TAG           :      0
TOTAL         :   37632
number of mbufs: 37632
number of times failed to find space: 0
number of times waited for space: 0
number of times drained protocols for space: 0

-----
CLUSTER POOL TABLE
-----
size      clusters  free      usage      minsize  maxsize  avgsize
-----
---
64         6336      6336      33          4         56        13
128        6336      6313      712952418  128       128        1
256        6336      6336      0            0         0          0
512        10240     10218     712654339  293       293        3
1024       1024      1024      0            0         0          0
2048       1024      1024      0            0         0          0
-----
---
value = 80 = 0x50 = 'P'
;

tekelecstp 08-01-19 04:46:24 EST EAGLE5 38.0.0

NETSTAT command complete
;

```

pass:cmd="netstat -m sys":loc=1111

Command Accepted - Processing

tekelecstp 08-01-19 04:46:44 EST EAGLE 38.0.0  
PASS: Command sent to card

;

tekelecstp 08-01-19 04:46:44 EST EAGLE 38.0.0  
SDS Shell Output

-> netStackSysPoolShow

type            number

-----

```

FREE      :      3696
DATA      :         4
HEADER    :         0
SOCKET    :         0
PCB       :         0
RTABLE    :         0
HTABLE    :         0
ATABLE    :         0
SONAME    :         0
ZOMBIE    :         0
SOOPTS    :         0
FTABLE    :         0
RIGHTS    :         0
IFADDR    :         0
CONTROL   :         0
OOBDATA   :         0
IPMOPTS   :         0
IPMADDR   :         0
IFMADDR   :         0
MRTABLE   :         0
TAG       :         0
TOTAL     :      3700
number of mbufs: 3700
number of times failed to find space: 0
number of times waited for space: 0
number of times drained protocols for space: 0

```

CLUSTER POOL TABLE

| size | clusters | free | usage | minsize | maxsize | avgsz |
|------|----------|------|-------|---------|---------|-------|
| 20   | 500      | 477  | 28    | 8       | 20      | 16    |
| 44   | 500      | 495  | 5     | 24      | 32      | 35    |
| 96   | 500      | 487  | 13    | 48      | 96      | 65    |
| 172  | 500      | 490  | 10    | 116     | 160     | 150   |
| 292  | 500      | 487  | 1059  | 176     | 256     | 0     |
| 664  | 500      | 486  | 1064  | 384     | 592     | 1     |
| 1144 | 100      | 95   | 5     | 1144    | 1144    | 228   |

-----

---

|      |     |     |      |      |      |     |
|------|-----|-----|------|------|------|-----|
| 20   | 500 | 477 | 28   | 8    | 20   | 16  |
| 44   | 500 | 495 | 5    | 24   | 32   | 35  |
| 96   | 500 | 487 | 13   | 48   | 96   | 65  |
| 172  | 500 | 490 | 10   | 116  | 160  | 150 |
| 292  | 500 | 487 | 1059 | 176  | 256  | 0   |
| 664  | 500 | 486 | 1064 | 384  | 592  | 1   |
| 1144 | 100 | 95  | 5    | 1144 | 1144 | 228 |

-----

---

value = 80 = 0x50 = 'P'

;

tekelecstp 08-01-19 04:46:47 EST EAGLE 38.0.0

NETSTAT command complete

;

pass:cmd="netstat -m dd":loc=1111

Command Accepted - Processing

tekelecstp 08-01-19 04:47:03 EST EAGLE 38.0.0  
PASS: Command sent to card

;

tekelecstp 08-01-19 04:47:03 EST EAGLE 38.0.0

END-0 Buffer Pool

-----  
CLUSTER POOL TABLE  
-----

| size | clusters | free | usage |
|------|----------|------|-------|
| 1536 | 800      | 480  | 0     |

END-1 Buffer Pool

-----  
CLUSTER POOL TABLE  
-----

| size | clusters | free | usage |
|------|----------|------|-------|
| 1536 | 800      | 640  | 0     |

;

tekelecstp 08-01-19 04:47:05 EST EAGLE 38.0.0

NETSTAT command complete

;

**pass:cmd="netstat -p icmp":loc=1111**

```
Command Accepted - Processing

tekelecstp 08-01-19 04:47:13 EST  EAGLE 38.0.0
PASS: Command sent to card
;

tekelecstp 08-01-19 04:47:13 EST  EAGLE 38.0.0
SDS Shell Output

-> icmpstatShow
ICMP:
  0 call to icmp_error
  0 error not generated because old message was icmp
Output histogram:
  echo: 1042
  0 message with bad code fields
  0 message < minimum length
  0 bad checksum
  0 message with bad length
Input histogram:
  echo reply: 1042
  0 message response generated
value = 30 = 0x1e
;

tekelecstp 08-01-19 04:47:13 EST  EAGLE 38.0.0

NETSTAT command complete
;
```

**pass:cmd="netstat -p igmp":loc=1111**

```
Command Accepted - Processing

tekelecstp 08-01-19 04:47:31 EST  EAGLE 38.0.0
PASS: Command sent to card
;

tekelecstp 08-01-19 04:47:31 EST  EAGLE 38.0.0
SDS Shell Output

-> igmpstatShow
IGMP:
  0 invalid queries received
  0 invalid reports received
  0 bad checksums received
  0 reports for local groups received
  0 membership queries received
  0 membership reports received
  0 short packets received
  0 total messages received
  0 membership reports sent
value = 27 = 0x1b
;

tekelecstp 08-01-19 04:47:31 EST  EAGLE 38.0.0

NETSTAT command complete
;
```

**pass:cmd="netstat -p ip":loc=1111**

```
Command Accepted - Processing

tekelecstp 08-01-19 04:47:50 EST EAGLE 38.0.0
PASS: Command sent to card
;

tekelecstp 08-01-19 04:47:50 EST EAGLE 38.0.0
SDS Shell Output

-> ipstatShow
      total 392695394
      badsum 0
      tooshort 0
      toosmall 0
      badhlen 0
      badlen 0
      infragments 0
      fragdropped 0
      fragtimeout 0
      forward 0
      fastforward 0
      cantforward 0
      redirectsent 0
      unknownprotocol 0
      delivered 392695394
      localout 712875071
      nobuffers 0
      reassembled 0
      fragmented 0
      outfragments 0
      cantfrag 0
      badoptions 0
      noroute 0
      badvers 0
      rawout 0
      toolong 0
      notmember 0
      nogif 0
      badaddr 0

value = 1 = 0x1

;

tekelecstp 08-01-19 04:47:50 EST EAGLE 38.0.0

NETSTAT command complete

;
```

```
pass:cmd="netstat -p tcp":loc=1111
```

```
Command Accepted - Processing
```

```
tekelecstp 08-01-19 04:48:10 EST EAGLE 38.0.0  
PASS: Command sent to card
```

```
;
```

```
tekelecstp 08-01-19 04:48:10 EST EAGLE 38.0.0  
SDS Shell Output
```

```
-> tcpstatShow
```

```
TCP:
```

```
712802525 packets sent  
712802521 data packets (-1599247397 bytes)  
0 data packet (0 byte) retransmitted  
2 ack-only packets (0 delayed)  
0 URG only packet  
0 window probe packet  
0 window update packet  
3 control packets  
392101363 packets received  
392101363 acks (for -1599247397 bytes)  
0 duplicate ack  
0 ack for unsent data  
0 packet (0 byte) received in-sequence  
0 completely duplicate packet (0 byte)  
0 packet with some dup. data (0 byte duped)  
0 out-of-order packet (0 byte)  
0 packet (0 byte) of data after window  
0 window probe  
0 window update packet  
0 packet received after close  
0 discarded for bad checksum  
0 discarded for bad header offset field  
0 discarded because packet too short  
3 connection requests  
0 connection accept  
1 connection established (including accepts)  
2 connections closed (including 0 drop)  
0 embryonic connection dropped  
392101363 segments updated rtt (of 44575243 attempts)  
1 retransmit timeout  
0 connection dropped by retransmit timeout  
0 persist timeout  
7 keepalive timeouts  
0 keepalive probe sent  
0 connection dropped by keepalive  
0 pcb cache lookup failed  
value = 27 = 0x1b
```

```
;
```

```
tekelecstp 08-01-19 04:48:10 EST EAGLE 38.0.0
```

```
NETSTAT command complete
```

```
;
```

pass:cmd="netstat -p sctp":loc=1106

Command Accepted - Processing

tekelecstp 08-01-24 05:41:04 EST EAGLE 38.0.0  
PASS: Command sent to card

;

```
tekelecstp 08-01-24 05:41:04 EST EAGLE 38.0.0
ip packets sent..... 214
  ip packets sent with data chunk..... 8
  control chunks (excluding retransmissions)..... 211
  ordered data chunks (excluding retransmissions).. 8
  unordered data chunks (excluding retransmissions) 0
  user messages fragmented due to MTU..... 0
  retransmit data chunks sent..... 0
  sacks sent..... 9
  send failed..... 0
ip packets received..... 215
  ip packets received with data chunk..... 8
  control chunks (excluding duplicates)..... 211
  ordered data chunks (excluding duplicates)..... 8
  unordered data chunks (excluding duplicates).... 0
  user messages reassembled..... 0
  data chunks read..... 8
  duplicate tsns received..... 0
  sacks received..... 9
  gap ack blocks received..... 0
  out of the blue..... 0
  with invalid checksum..... 0
connections established..... 1
  by upper layer..... 0
  by remote endpoint..... 1
connections terminated..... 0
  ungracefully..... 0
  gracefully..... 0
associations dropped due to retransmits..... 0
consecutive retransmit timeouts..... 0
retransmit timer count..... 0
fast retransmit count..... 0
heartbeat requests received..... 99
heartbeat acks received..... 99
heartbeat requests sent..... 99
associations supported..... 16
milliseconds cookie life at 4-way start-up handshake. 5000
retransmission attempts allowed at start-up phase.... 10
```

;

tekelecstp 08-01-24 05:41:04 EST EAGLE 38.0.0

NETSTAT command complete

;



**pass:cmd="netstat -p udp":loc=1111**

```

Command Accepted - Processing

tekelecstp 08-01-19 04:48:40 EST  EAGLE 38.0.0
PASS: Command sent to card
;

tekelecstp 08-01-19 04:48:40 EST  EAGLE 38.0.0
SDS Shell Output

-> udpstatShow
UDP:
    714029 total packets
    612012 input packets
    102017 output packets
    0 incomplete header
    0 bad data length field
    0 bad checksum
    510042 broadcasts received with no ports
    0 full socket
    0 pcb cache lookup failed
    0 pcb hash lookup failed
value = 26 = 0x1a
;

tekelecstp 08-01-19 04:48:40 EST  EAGLE 38.0.0

NETSTAT command complete
;

```

**pass:cmd="netstat -r":loc=1112**

```

Command Accepted - Processing

tekelecstp 08-02-19 05:58:13 EST  EAGLE 38.0.0
PASS: Command sent to card
;

tekelecstp 08-02-19 05:58:13 EST  EAGLE 38.0.0
SDS Shell Output

-> tklc_routeShow

ROUTE NET TABLE
destination      gateway          flags  Refcnt  Use      Interface
-----
172.20.48.0      172.20.48.250   33554689  0      0        DPLend0
192.168.55.0     192.168.55.252  33554689  2      0        gei2
-----

ROUTE HOST TABLE
destination      gateway          flags  Refcnt  Use      Interface
-----
127.0.0.1        127.0.0.1        35651589  3      15       lo0
192.168.99.100   192.168.55.211  33554439  0      0        gei2
-----

value = 0 = 0x0
;

tekelecstp 08-02-19 05:58:13 EST  EAGLE 38.0.0

NETSTAT command

```

**pass:cmd="netstat -d 0":loc=1111**

Command Accepted - Processing

```
tekelecstp 08-01-19 04:49:16 EST EAGLE 38.0.0
PASS: Command sent to card
```

;

```
tekelecstp 08-01-19 04:49:16 EST EAGLE 38.0.0
```

```
Report Time      = 00-00-00 00:00:59.001
Card Load Time   = 00-00-00 00:00:09.905
Last Reset Time  = 00-00-00 00:00:09.905
```

```

crc err = 0          align err = 0          symbol err = 0
rx err = 0          missed pkt = 0        sequence err = 0
cr ex er = 0       rx len err = 0        rx no buf = 0
rx total = 243721  rx undersz = 0        rx frag = 0
good pkt rx= 243721 rx bcast = 11652      rx mcast = 0
rx oversz = 0      rx jabber = 0        collision = 0
tx total = 381079  late coln = 0        tx underun = 0
good pkt tx= 381079 tx bcast = 0        tx mcast = 0
defer count = 0
good octets rx = 16988038 total octets rx = 16988038
good octets tx = 137538057 total octets tx = 137538057

```

;

```
tekelecstp 08-01-19 04:49:16 EST EAGLE 38.0.0
```

NETSTAT command complete

;

**pass:cmd="netstat -d 0 -z":loc=1111**

```
tekelecstp 08-01-19 04:50:07 EST EAGLE 38.0.0
PASS: Command sent to card
```

;

```
tekelecstp 08-01-19 04:50:07 EST EAGLE 38.0.0
```

Driver measurements for unit 0 cleared

;

```
tekelecstp 08-01-19 04:50:07 EST EAGLE 38.0.0
```

NETSTAT command complete

;

```
pass:cmd="netstat -d 0 -f":loc=1111
```

```
Command Accepted - Processing
```

```
tekelecstp 08-01-19 04:50:22 EST EAGLE 38.0.0
PASS: Command sent to card
```

```
;
```

```
tekelecstp 08-01-19 04:50:22 EST EAGLE 38.0.0
```

```
Report Time      = 00-00-00 00:01:01.335
Card Load Time   = 00-00-00 00:00:09.905
Last Reset Time  = 00-00-00 00:00:46.665
```

```

crc err = 0          align err = 0          symbol err = 0
rx err = 0          missed pkt = 0        sequence err = 0
cr ex er = 0       rx len err = 0       rx no buf = 0
rx total = 13562   rx undersz = 0       rx frag = 0
good pkt rx= 13562 rx bcast = 149       rx mcast = 0
rx oversz = 0      rx jabber = 0        collision = 0
tx total = 22019   late coln = 0        tx underun = 0
good pkt tx= 22019 tx bcast = 0          tx mcast = 0
single col = 0     excess coln = 0      multi colsn = 0
pkt rx 64 = 179   pkt rx 127 = 13383  pkt rx 255 = 0
pkt rx 511 = 0    pkt rx 1023 = 0     pkt rx 1522 = 0
pkt tx 64 = 30    pkt tx 127 = 0      pkt tx 255 = 0
pkt tx 511 = 21989 pkt tx 1023 = 0     pkt tx 1522 = 0
tcp cxt tx = 0    rx FIFO head = 0x00000caf rx FIFO tail = 0x00000caf
rx FIFO pc = 0   rx FIFO hs = 0x00000caf rx FIFO ts = 0x00000caf
tcp tx fc = 0    tx FIFO head = 0x00001f30 tx FIFO tail = 0x00001f30
tx FIFO pc = 0   tx FIFO hs = 0x00001f30 tx FIFO ts = 0x00001f30
XON rcv = 0      XON xmit = 0        XOFF rcv = 0
XOFF tx = 0      unsupport FC = 0
defer count = 0  tx no crs = 0
good octets rx = 948266 total octets rx = 948266
good octets tx = 7983927 total octets tx = 7983927

```

```
;
```

```
tekelecstp 08-01-19 04:50:22 EST EAGLE 38.0.0
5463.1083   SYSTEM      INFO      REPT COND: system alive
           Report Date:02-01-19 Time:04:50:24
```

```
;
```

```
tekelecstp 08-01-19 04:50:22 EST EAGLE 38.0.0
```

```
NETSTAT command complete
```

```
;
```

## nslookup

## Nameserver Lookup

This command returns the IP address for a given hostname, or returns a hostname for a given IP address.

**Keyword:** nslookup

**Command Class:** IP Stack Maintenance

### Options

Options and option parameters that are underlined indicate that a value must be specified for that option or parameter. For example, the **nslookup** command has the option destination. An IP address

or hostname can be specified for the destination, as in the commands **nslookup 192.168.100.3** and **nslookup dcm1107a**. Do not enter the underlined option or parameter; enter a value for the information represented by the underlined option or parameter.

destination

The destination can be either an IP address or hostname.

IP address

The IP address is a TCP/IP address expressed in standard “dot notation.” IP addresses consist of the system’s network number and the machine’s unique host number. An example IP address is **192.9.200.44**, where **192.9.200** is the network number and **44** is the machine’s host number.

**Range:**

4 numbers separated by dots, with each number in the range of **0-255**.

hostname

Hostname. This parameter identifies the logical name assigned to the device with the IP address indicated.

**Range:**

**a-z, A-Z, 0-9, -, .** (any string of characters beginning with a letter and comprising up to 60 characters in length)

**-h**

This options provides help information for the command.

### Example

```
nslookup 192.9.200.44
```

```
nslookup nc.tekelec.com
```

### Dependencies

The actual **nslookup** text string must be followed by a destination (either a hostname or IP address).

Whether a host is found depends on the configuration of the host table and domain name servers.

### Notes

The **nslookup** command is executed through the **pass** command.

### Output

```
pass:loc=1105:cmd="nslookup"
```

or

**pass:loc=1105:cmd="nslookup -h"**

```
Command Accepted - Processing
  rlghncxa03w 04-07-27 08:43:21 EST  EAGLE5 31.6.0
  pass:loc=1105:cmd="nslookup"
  Command entered at terminal #1.
;
  rlghncxa03w 04-07-27 08:43:21 EST  EAGLE5 31.6.0
  PASS: Command sent to card
;
  rlghncxa03w 04-07-27 08:43:21 EST  EAGLE5 31.6.0

  Usage: nslookup [hostname|ipaddr]
  Options:
    hostname  String name
    ipaddr    d.d.d.d
;
  rlghncxa03w 04-07-27 08:43:22 EST  EAGLE5 31.6.0
  NSLOOKUP command complete
;
```

**pass:loc=1105:cmd="nslookup dcm1107a"**

```
Command Accepted - Processing
  rlghncxa03w 04-07-27 08:43:46 EST  EAGLE5 31.6.0
  pass:loc=1105:cmd="nslookup dcm1107a"
  Command entered at terminal #1.
;
  rlghncxa03w 04-07-27 08:43:46 EST  EAGLE5 31.6.0
  PASS: Command sent to card
;
  rlghncxa03w 04-07-27 08:43:46 EST  EAGLE5 31.6.0

  NSLOOKUP command in progress
;
  rlghncxa03w 04-07-27 08:43:46 EST  EAGLE5 31.6.0

  Configured Domain Name Data

  DNSA = 192.168.100.3
  DNSB = 0.0.0.0
  Domain Name = nc.tekelec.com
  Search Order = LOCAL First

  Resolving host name - dcm1107a

  Host Table entry
    dcm1107a - 192.168.100.113
  DNS Server - No entry exists

  Currently using Host Table entry

  NSLOOKUP command complete
;
```

```
pass:loc=1105:cmd="nslookup 192.168.100.3"
```

```
Command Accepted - Processing

rlghncxa03w 04-07-27 13:21:49 EST EAGLE5 31.6.0
pass:loc=1105:cmd="nslookup 192.168.100.3"
Command entered at terminal #1.
;
rlghncxa03w 04-07-27 13:21:49 EST EAGLE5 31.6.0
PASS: Command sent to card
;
rlghncxa03w 04-07-27 13:21:49 EST EAGLE5 31.6.0

NSLOOKUP command in progress
;
rlghncxa03w 04-07-27 13:21:49 EST EAGLE5 31.6.0

Configured Domain Name Data

DNSA = 192.168.100.3
DNSB = 0.0.0.0
Domain Name = nc.tekelec.com
Search Order = LOCAL First

Resolving IP address - 192.168.100.3

Host Table - No entry exists
DNS Server
    tekral.nc.tekelec.com - 192.168.100.3

Currently using DNS Server entry

NSLOOKUP command complete
;
```

## ping

## Packet Internetwork Groper

This command is used to test for the presence of hosts on the network. This command is invoked with a destination (either a hostname or IP address).

**Keyword:** ping

**Command Class:** IP Stack Maintenance

### Options

Options and option parameters that are underlined indicate that a value must be specified for that option or parameter. For example, the **ping** command has the option destination. An IP address or hostname can be specified for the destination, as in the commands **ping 192.9.200.44** and **ping nc.tekelec.com**. Do not enter the underlined option or parameter; enter a value for the information represented by the underlined option or parameter.

destination

The destination can be either an IP address or hostname.

IP address

The IP address is a TCP/IP address expressed in standard “dot notation.” IP addresses consist of the system’s network number and the machine’s unique host number. An example IP address is **192.9.200.44**, where **192.9.200** is the network number and **44** is the machine’s host number.

**Range:**

4 numbers separated by dots, with each number in the range of **0-255**.

hostname

Hostname. This parameter identifies the logical name assigned to the device with the IP address indicated.

**Range:**

any string of characters beginning with a letter and comprising ('a'..'z', 'A'..'Z', '0'..'9', '-', '.') up to 120 characters in length.

**-i**

This option specifies the number of ping requests to send.

**Range: 1 - 5**

**Default: 3**

**-n**

This option specifies the size of message to use in test.

**Range: 12 - 2048**

**Default: 64**

**-h**

This options provides help information for the command.

**Example**

```
ping 192.9.200.44
```

```
ping nc.tekelec.com
```

```
ping 192.9.200.44 -i 5 -n 2048
```

**Dependencies**

The actual **ping** text string must be followed by a destination (either a hostname or IP address) prior to the options.

**Notes**

The **ping** command is executed through the **pass** command.

**Output****pass:loc=1105:cmd="ping" or****pass:loc=1105:cmd="ping -h"**

Command Accepted - Processing

```

rlghncxa03w 04-07-27 08:29:35 EST  EAGLE5 31.6.0
pass:loc=1105:cmd="ping"
Command entered at terminal #1.
;
rlghncxa03w 04-07-27 08:29:35 EST  EAGLE5 31.6.0
PASS: Command sent to card
;
rlghncxa03w 04-07-27 08:29:35 EST  EAGLE5 31.6.0

Usage: ping <hostname | ipaddr> [-h] [-i size] [-n count]
Options:
  -h           Displays this message
  -i count    Number of pings to send. Range=1..5. Default=3.
  -n sizet    Sets size of ICMP echo packet. Range=12..2048. Default=64.
  hostname    Name of machine to ping
  ipaddr      IP Address of machine to ping (d.d.d.d)
;
rlghncxa03w 04-07-27 08:29:36 EST  EAGLE5 31.6.0

PING command complete
;

```

**pass:loc=1105:cmd="ping tekral"**

Command Accepted - Processing

```

rlghncxa03w 04-07-27 08:30:16 EST  EAGLE5 31.6.0
pass:loc=1105:cmd="ping tekral"
Command entered at terminal #1.
;
rlghncxa03w 04-07-27 08:30:16 EST  EAGLE5 31.6.0
PASS: Command sent to card
;
rlghncxa03w 04-07-27 08:30:16 EST  EAGLE5 31.6.0
PING command in progress
;
rlghncxa03w 04-07-27 08:30:18 EST  EAGLE5 31.6.0
PING tekral (192.168.100.3): 56 data bytes
64 bytes from tekral.nc.tekelec.com (192.168.100.3):icmp_seq=0.time=5. ms
64 bytes from tekral.nc.tekelec.com (192.168.100.3):icmp_seq=1.time=0. ms
64 bytes from tekral.nc.tekelec.com (192.168.100.3):icmp_seq=2.time=0. ms
----tekral PING Statistics----
 3 packets transmitted, 3 packets received, 0% packet loss
round-trip (ms)  min/avg/max = 0/1/5
PING command complete
;

```



**pass:loc=1105:cmd="ping 192.168.100.3"**

Command Accepted - Processing

```
rlghncxa03w 04-07-27 08:30:44 EST EAGLE5 31.6.0
pass:loc=1105:cmd="ping 192.168.100.3"
Command entered at terminal #1.
;
rlghncxa03w 04-07-27 08:30:44 EST EAGLE5 31.6.0
PASS: Command sent to card
;
rlghncxa03w 04-07-27 08:30:44 EST EAGLE5 31.6.0

PING command in progress
;
rlghncxa03w 04-07-27 08:30:46 EST EAGLE5 31.6.0
PING 192.168.100.3: 56 data bytes
64 bytes from tekral.nc.tekelec.com (192.168.100.3):icmp_seq=0.time=5. ms
64 bytes from tekral.nc.tekelec.com (192.168.100.3):icmp_seq=1.time=0. ms
64 bytes from tekral.nc.tekelec.com (192.168.100.3):icmp_seq=2.time=0. ms
----192.168.100.3 PING Statistics----
3 packets transmitted, 3 packets received, 0% packet loss
round-trip (ms) min/avg/max = 0/1/5

PING command complete
;
```

**pass:loc=1105:cmd="ping tekral -i 2"**

Command Accepted - Processing

```
rlghncxa03w 04-07-27 08:31:46 EST EAGLE5 31.6.0
pass:loc=1105:cmd="ping tekral -i 2"
Command entered at terminal #1.
;
rlghncxa03w 04-07-27 08:31:46 EST EAGLE5 31.6.0
PASS: Command sent to card
;
rlghncxa03w 04-07-27 08:31:46 EST EAGLE5 31.6.0

PING command in progress
;
rlghncxa03w 04-07-27 08:31:47 EST EAGLE5 31.6.0
PING tekral (192.168.100.3): 56 data bytes
64 bytes from tekral.nc.tekelec.com(192.168.100.3):icmp_seq=0.time=10. ms
64 bytes from tekral.nc.tekelec.com(192.168.100.3):icmp_seq=1.time=0. ms
----tekral PING Statistics----
2 packets transmitted, 2 packets received, 0% packet loss
round-trip (ms) min/avg/max = 0/5/10

PING command complete
;
```

**pass:loc=1105:cmd="ping tekral -i 1"**

```
Command Accepted - Processing

    rlghncxa03w 04-07-27 08:31:55 EST  EAGLE5 31.6.0
    pass:loc=1105:cmd="ping tekral -i 1"
    Command entered at terminal #1.
;
    rlghncxa03w 04-07-27 08:31:55 EST  EAGLE5 31.6.0
    PASS: Command sent to card
;
    rlghncxa03w 04-07-27 08:31:55 EST  EAGLE5 31.6.0

    PING command in progress
;
    rlghncxa03w 04-07-27 08:31:55 EST  EAGLE5 31.6.0

    PING: tekral is alive

    PING command complete
;
```

**pass:loc=1105:cmd="ping tekral -i 2 -n 200"**

```
    rlghncxa03w 04-07-27 08:32:09 EST  EAGLE5 31.6.0
    pass:loc=1105:cmd="ping tekral -i 2 -n 200"
    Command entered at terminal #1.
;
    rlghncxa03w 04-07-27 08:32:09 EST  EAGLE5 31.6.0

    PING command in progress
;
    rlghncxa03w 04-07-27 08:32:10 EST  EAGLE5 31.6.0
    PING tekral (192.168.100.3): 192 data bytes
    200 bytes from tekral.nc.tekelec.com(192.168.100.3):icmp_seq=0.time=5. ms
    200 bytes from tekral.nc.tekelec.com(192.168.100.3):icmp_seq=1.time=0. ms
    ----tekral PING Statistics----
    2 packets transmitted, 2 packets received, 0% packet loss
    round-trip (ms)  min/avg/max = 0/2/5

    PING command complete
;
```

**NOTE: In the above example, the response shows eight bytes less than the entry (192 as opposed to 200) because the ping command may use eight bytes automatically.**

## sctp

### Stream Control Transmission Protocol

This command is used to provide a view of Sctp instance and association information.

**Keyword:** sctp

**Command Class:** Sctp Stack Maintenance

#### Options

Options and option parameters that are underlined indicate that a value must be specified for that option or parameter. Do not enter the underlined option or parameter; enter a value for the information represented by the underlined option or parameter.

**-a aname**

This option is used to retrieve the measurements and information for a specific association.

**-l**

This option is used to display logging details for associations. The logging details are independent of the association state (close or open).

**-p <port>**

This option is used to retrieve the measurements for a specified SCTP port.

**-r**

This option is used to reset specified measurements. The associated report is not displayed.

**-h**

This option is used to display help information for the command. Either brief or full help reports can be generated.

**-m**

This option is used to display SCTP incoming/outgoing (IO) header audit reports for common and dedicated IO header pools. The IO header is a transmission sequence number (TSN) control block used in processing SCTP chunks. The report shows total, currently available, and minimum IO header counts for the IO header pool shared by all associations (common pool) and the IO header pool for each association (dedicated pool).

### Example

```
pass:cmd="sctp -a aname":loc=1307
```

```
pass:cmd="sctp -l":loc=1307
```

```
pass:cmd="sctp -l aname":loc=1307
```

```
pass:cmd="sctp -p port":loc=1307
```

```
pass:cmd="sctp -r -a aname":loc=1307
```

```
pass:cmd="sctp -r -l aname":loc=1307
```

```
pass:cmd="sctp -m"
```

```
pass:cmd="sctp"
```

### Dependencies

The **-r** option can be specified in the same command as the **-a**, **-p**, or **-l** options. Otherwise, only one option can be specified at a time.

### Notes

None

### Output

Either brief or full help reports can be displayed. A full help report is generated by adding the **-h full** option to the command line.

Example brief help report:

**pass:loc=1305:cmd="sctp -h"**

```
Usage: [ [[[-a aname] | [-p port] | [-l [aname]]] [-r [-s]]] | [-m] | [-h  
[full]] ]
```

Options:

|                 |                                       |
|-----------------|---------------------------------------|
| (no parameters) | display list of SCTP ports            |
| -a aname        | display association report            |
| -p port         | display SCTP port report              |
| -r              | reset specified SCTP measurements     |
| -m              | display IO header usage report        |
| -l aname        | display association event log         |
| -l              | display all event logs                |
| -r -l           | reset all SCTP event logs             |
| -r -s           | reset all SCTP measurements and pegs  |
| -h              | displays command help (brief or full) |

;

```
rlghncxa03w 08-02-01 08:32:09 EST EAGLE5 38.0.0
```

```
SCTP command complete
```

;

Example of a full help report:

**pass:loc=1307:cmd="sctp -h full"**

Usage: sctp [[[-a aname] | [-p port] | [-l [aname]]] [-r [-s]]] | [-m] | [-h [full]]]

Options:

|                 |                                       |
|-----------------|---------------------------------------|
| (no parameters) | display list of SCTP ports            |
| -a aname        | display association report            |
| -p port         | display SCTP port report              |
| -r              | reset specified SCTP measurements     |
| -m              | display IO header usage report        |
| -l aname        | display association event log         |
| -l              | display all event logs                |
| -r -l           | reset all SCTP event logs             |
| -r -s           | reset all SCTP measurements and pegs  |
| -h              | displays command help (brief or full) |

no parameters option

Summary list of all SCTP instances. To list all the SCTP ports issue the following command:  
 sctp

-a aname option details

Retrieves detailed information and measurements for a specific association. For example the following SCTP command will get the measurements and detailed information for the association with association name = assoc1.

```
sctp -a assoc1
```

In remote address field of output configured RHOST or ARHOST or both IP address will be displayed based on the presence in association remote network array

-p port option details

Retrieves detailed information for a specified SCTP port. For example the following SCTP command will get the detailed information for the SCTP port with a local port of 200.

```
sctp -p 200
```

In remote address field of output configured RHOST or ARHOST or both IP address will be displayed based on the presence in association remote network array

-r option details

Resets specified SCTP Measurements. See examples below.

Resets measurements for specified association:

```
sctp -r -a assoc
```

Resets measurements for all associations on port 2000:

```
sctp -r -p 2000
```

Resets measurements and event logs for all ports/associations:

```
sctp -r
```

Resets event logs for specified association:

```
sctp -r -l assoc
```

Resets event logs for all associations:

```
sctp -r -l
```

Resets measurements for all associations:

```
sctp -r -s
```

-m

This option displays SCTP IO header audit report for common and dedicated IO header pools. The report shows total, currently available and minimum (low water mark) IO header counts for common and each association's dedicated pool.

IO header is a TSN control block used in processing SCTP chunks.

Common pool is IO header pool shared by all associations.

Dedicated pool is a per-association IO header pool.

```
sctp -m;
```

```
-l option details
  This option displays logging details for associations. The logging
  details are independent of the association state (close or open).
  See examples below:
  The following SCTP command will get the logging details
  for all associations on the specified card.
      sctp -l
  The following SCTP command will get the logging
  details for the association with association name = assoc1.
      sctp -l assoc1
```

```
;

rlghncxa03w 08-02-01 08:32:09 EST  EAGLE5 38.0.0

SCTP command complete
```

```
;

Example summary list of all SCTP ports. All SCTP ports and number of associations associated with
each port is displayed.
```

**pass:loc=1307:cmd="sctp"**

```
rlghncxa03w 08-02-01 08:32:09 EST  EAGLE5 38.0.0
Local   Local IP      Num of
Port    Address         Assoc
7001    192.168.110.35  1
2222    192.168.110.12  3
        192.168.112.12

;

rlghncxa03w 08-02-01 08:32:09 EST  EAGLE5 38.0.0

SCTP command complete
```

```
;

Example specific SCTP association information and measurements:
```

pass:loc=1307:cmd="sctp -a assoc1"

```
e1090203 09-05-03 12:52:56 EST EAGLE 41.0.0
Aname      Local      Local      Remote      Remote
           Address    Port      Address    Port
assoc1     192.168.110.12 2222     192.168.112.4 5555
           192.168.112.12      192.168.110.2
```

```
Configuration                               State
Retransmission Mode = LIN                   State = OPEN
Min. Retransmission Timeout = 10            ULP association id = 18
Max. Retransmission Timeout = 800          Number of nets = 2
Max. Number of Retries = 10                Inbound Streams = 1
Min. Congestion Window = 3000              Outbound Streams = 2
Inbound Streams = 2
Outbound Streams = 2
Checksum Algorithm = crc32c
Send/Rcv Buffer Size = 204800
```

## Nets Data

```
IP Address 192.168.112.4      State Reachable
Port       5555                       Primary YES
MTU        1500                     cwnd  16384
ssthresh   16384              RTO   120

IP Address 192.168.112.5      State Reachable
Port       5555                       Primary NO
MTU        1500                     cwnd  16384
ssthresh   16384              RTO   120

IP Address 192.168.110.2      State Reachable
Port       5555                       Primary NO
MTU        1500                     cwnd  16384
ssthresh   16384              RTO   120
```

```
Last Net Sent To = 192.168.112.4
Last Net Rcvd From = 192.168.112.4
Over All Error Count = 0
Peers Rwnd = 13880
My Rwnd = 16384
Max Window = 16384
Initial Seq Number = 24130
Next Sending Seq Number = 124686
Last Acked Seq Number = 124669
Maximum Outbound Char Count = 16384
Current Outbound Char Count = 2112
Number Unsent Char Count = 0
Outbound Data Chunk Count = 16
Number Unsent = 0
Number To Retransmit = 0
```

```
ip datagrams rcvd = 155402
ip datagrams with data chunks rcvd = 120844
data chunks rcvd = 367908
data chunks read = 367900
dup tsns rcvd = 8
sacks rcvd = 38734
gap ack blocks rcvd = 3
heartbeat requests rcvd = 135
heartbeat acks rcvd = 52
heartbeat requests sent = 52
ip datagrams sent = 129254
ip datagrams with data chunks sent = 73084
data chunks sent = 396330
```

```
retransmit data chunks sent = 135
      sacks sent = 64872
      send failed = 0
retransmit timer count = 0
consecutive retransmit timeouts = 0
RTT between RMIN and RMAX inclusive = 6
      RTT greater than RMAX = 0
fast retransmit count = 135
      recv timer count = 0
heartbeat timer count = 244
      none left tosend = 0
      none left rwnd gate = 5
      none left cwnd gate = 8
      UNKNOWN = 0
```

;

```
e1090203 09-05-03 12:52:56 EST EAGLE 41.0.0
```

```
SCTP command complete
```

;

Example SCTP port measurements:



**pass:loc=1307:cmd="sctp -p 2222"**

```
rlghncxa03w 09-05-01 08:32:09 EST EAGLE5 41.0.0
Local   Local IP      Num of
Port   Address        Assoc
2222   192.168.110.12  3
       192.168.112.12
```

```
Assoc   Local          Local   Remote        Remote
ID      IP Address     Port    Address       Port
1       192.168.110.12 2222    192.168.112.4 5555
        192.168.112.12          192.168.110.2
2       192.168.110.12 2222    192.168.112.4 5555
        192.168.112.12          192.168.110.3
3       192.168.110.12 2222    192.168.112.4 7777
        192.168.112.12          192.168.110.4
```

```
no.of inqueued msgs = 0
max mtu = 1500
max init times = 8
max size reassembly = 1048576
default rwnd value = 16384
pre-open streams = 1
ip datagram counter = 2781
```

```
Timer Values:      seconds      millisecs
INIT               1             0
RECV               0             200
SEND               1             0
SHUTDOWN           0             300
HEARTBEAT          0             500
PMTU               600           0
```

;

```
rlghncxa03w 09-05-01 08:32:09 EST EAGLE5 41.0.0
```

```
SCTP command complete
```

;

;

Example displays all event logs for an association:

**pass:loc=1307:cmd="sctp -l assoc1"**

rlghncxa03w 08-02-01 08:32:09 EST EAGLE 38.0.0

SCTP Event Log

| Time         | Event                | Reason         | Ripaddr        | Rport |
|--------------|----------------------|----------------|----------------|-------|
| 01:19:04.165 | SACK send fail       | None           | 192.168.63.235 | 10001 |
| 01:19:04.175 | Ck echo ack snd fail | None           | 192.168.63.235 | 10001 |
| 01:19:04.180 | Assoc UP             | Unknown        | 192.168.63.235 | 10001 |
| 01:19:04.180 | Assoc Down           | Shutdown Rcv   | 192.168.63.235 | 10001 |
| 01:19:04.180 | Shutdown ack send    | None           | 192.168.63.235 | 10001 |
| 01:19:06.425 | INIT Rcv             | None           | 192.168.63.142 | 10002 |
| 01:19:06.425 | Datagram Ignored     | No Assoc Found | 192.168.63.142 | 10002 |
| 01:19:16.500 | INIT tmr expr        | None           | 192.168.63.235 | 10001 |
| 01:19:16.500 | SACK send fail       | None           | 192.168.63.235 | 10001 |
| 01:19:17.500 | INIT tmr expr        | None           | 192.168.63.235 | 10001 |
| 01:19:17.500 | SACK send fail       | None           | 192.168.63.235 | 10001 |

SCTP: command complete

;

rlghncxa03w 08-02-01 08:32:09 EST EAGLE 38.0.0

SCTP command complete

;

Example displays event logs for all associations on a given card location:

**pass:loc=1307:cmd="sctp -l"**

rlghncxa03w 08-02-01 08:32:09 EST EAGLE 38.0.0

SCTP Event Log

| Time         | Event                | Reason         | Ripaddr        | Rport |
|--------------|----------------------|----------------|----------------|-------|
| 01:19:04.165 | SACK send fail       | None           | 192.168.63.235 | 10001 |
| 01:19:04.175 | Ck echo ack snd fail | None           | 192.168.63.235 | 10001 |
| 01:19:04.180 | Assoc UP             | Unknown        | 192.168.63.235 | 10001 |
| 01:19:04.180 | Assoc Down           | Shutdown Rcv   | 192.168.63.235 | 10001 |
| 01:19:04.180 | Shutdown ack send    | None           | 192.168.63.235 | 10001 |
| 01:19:06.425 | INIT Rcv             | None           | 192.168.63.142 | 10002 |
| 01:19:06.425 | Datagram Ignored     | No Assoc Found | 192.168.63.142 | 10002 |
| 01:19:16.500 | INIT tmr expr        | None           | 192.168.63.235 | 10001 |
| 01:19:16.500 | SACK send fail       | None           | 192.168.63.235 | 10001 |
| 01:19:17.500 | INIT tmr expr        | None           | 192.168.63.235 | 10001 |
| 01:19:17.500 | SACK send fail       | None           | 192.168.63.235 | 10001 |

SCTP: command complete

;

Example clears the logged events for an association:

**pass:loc=1307:cmd="sctp -r -l assoc1"**

Command Accepted - Processing

rlghncxa03w 08-02-01 08:32:09 EST EAGLE 38.0.0

All event logs for specified association have been reset.

;

rlghncxa03w 08-02-01 08:32:09 EST EAGLE 38.0.0

SCTP command complete

;

Example resets association measurements:

**pass:loc=1307:cmd="sctp -r -a assoc1"**

rlghncxa03w 08-02-01 08:32:09 EST EAGLE5 38.0.0  
PASS: Command sent to card

Association measurements have been reset.

SCTP command complete

Example resets port measurements:

**pass:loc=1307:cmd="sctp -r -p 4001"**

rlghncxa03w 08-02-01 08:32:09 EST EAGLE5 38.0.0  
PASS: Command sent to card

Port measurements have been reset.

SCTP command complete

Example resets all measurements and event logs:

**pass:loc=1307:cmd="sctp -r"**

rlghncxa03w 08-02-01 08:32:09 EST EAGLE5 38.0.0  
PASS: Command sent to card

All measurements and logs have been reset.

SCTP command complete

Example resets measurements for all ports/associations

**pass:loc=1307:cmd="sctp -r -s"**

Command Accepted - Processing

```
rlghncxa03w 08-02-01 08:32:09 EST EAGLE5 38.0.0
```

All measurements have been reset.

;

```
rlghncxa03w 08-02-01 08:32:09 EST EAGLE5 38.0.0
```

SCTP command complete

;

Example IO header audit report:

**sctp -m**

```
rlghncxa03w 08-02-01 08:32:09 EST EAGLE5 38.0.0
```

IO Headers in Common Pool (Total/CurrentFree/Min):  
20494/20494/20494

| Inst ID | Sock Idx | Assoc ID | IO Headers(Total/CurrentFree/Min) |
|---------|----------|----------|-----------------------------------|
| 2       | 0        | 1        | 400/400/398                       |

;

## sockrftt

## Socket Round Trip Time

This command is used to report and reset the round-trip time statistics for application sockets. Minimum, maximum, and average times are kept for each open socket. The Retransmission Mode (BSD, FIXED, or MOD) and the Fixed Round Trip Time are also displayed.

**Keyword:** sockrftt

**Command Class:** Application Maintenance

### Options

Options and option parameters that are underlined indicate that a value must be specified for that option or parameter. For example, the **sockrftt** command has the option socket name. The socket name must be specified for which statistics will be displayed, as in the command **sockrftt socyellow**. Do not enter the underlined option or parameter; enter a value for the information represented by the underlined option or parameter.

socket name

This option is **mandatory** and specifies the socket name for which statistics are to be displayed.

### Range:

up to 15 alphanumeric characters.

**-r**

This option resets all statistics for the given socket name.

**-h**

This option provides help information for the command.

### Example

**sockrftt**

```
sockrftt -h
sockrftt socyellow
sockrftt socyellow -r
```

### Dependencies

None

### Notes

The **sockrftt** command is executed through the **pass** command.

### Output

```
pass:loc=1105:cmd="sockrftt" or
```

```
pass:loc=1105:cmd="sockrftt -h"
```

```
Command Accepted - Processing

    rlghncxa03w 04-07-27 08:32:34 EST  EAGLE5 31.6.0
    PASS: Command sent to card
;
    rlghncxa03w 04-07-27 08:32:34 EST  EAGLE5 31.6.0
    Usage: SOCKRFTT sockname [-r] [-h]
    Options:
        -r          Resets rtt data for specified socket
        -h          Displays this message
;
    rlghncxa03w 04-07-27 08:32:34 EST  EAGLE5 31.6.0

    SOCKRFTT command complete
;
```

**pass:loc=1105:cmd="sockrtt c7000"**

```
Command Accepted - Processing

rlghncxa03w 04-07-27 08:32:34 EST EAGLE5 31.6.0
PASS: Command sent to card
;
rlghncxa03w 04-07-27 08:32:34 EST EAGLE5 31.6.0

SOCKRTT: Socket round-trip time report (in milliseconds)

Configured Traffic Round-Trip Time
  Retransmission Mode           : FIXED
  Fixed Round Trip Time         : 250

Measured Normal Traffic Round-Trip Times

  Minimum round-trip time       : 5
  Maximum round-trip time       : 195
  Weighted Average round-trip time : 10
  Last recorded round-trip time  : 10

Measured Congested Traffic Round-Trip Times

  Minimum round-trip time       : 0
  Maximum round-trip time       : 0
  Weighted Average round-trip time : 0
  Last recorded round-trip time  : 0
;
rlghncxa03w 04-07-27 08:32:34 EST EAGLE5 31.6.0
SOCKRTT command complete
;
```

**pass:loc=1105:cmd="sockrtt c7000 -r"**

```

Command Accepted - Processing

    rlghncxa03w 04-07-27 08:32:34 EST  EAGLE5 31.6.0
    pass:loc=1105:cmd="sockrtt c7000 -r"
    Command entered at terminal #1.
;
    rlghncxa03w 04-07-27 08:32:34 EST  EAGLE5 31.6.0
    PASS: Command sent to card
;
    rlghncxa03w 04-07-27 08:32:34 EST  EAGLE5 31.6.0

SOCKRTT: Socket round-trip time report (in milliseconds)

Configured Traffic Round-Trip Time
    Retransmission Mode           : FIXED
    Fixed Round Trip Time         : 250

Measured Normal Traffic Round-Trip Times

    Minimum round-trip time       : 0
    Maximum round-trip time       : 0
    Weighted Average round-trip time : 0
    Last recorded round-trip time  : 0

Measured Congested Traffic Round-Trip Times

    Minimum round-trip time       : 0
    Maximum round-trip time       : 0
    Weighted Average round-trip time : 0
    Last recorded round-trip time  : 0
;
    rlghncxa03w 04-07-27 08:32:34 EST  EAGLE5 31.6.0
    SOCKRTT command complete
;

```

## soipdata

## SEAS Over IP Data

This command is used to display the SOIP operational data captured for the last 24 hours.

**Keyword:** soipdata

**Command Class:** Application Maintenance

### Options

Options and option parameters that are underlined indicate that a value must be specified for that option or parameter.

**-f**

This option displays full operational data (all counts).

**-s**

This option is used to display the number of errors received with error type Bad Source.

**-d**

This option is used to display the number of of errors received with error type Bad Destination.

**-v**

This option is used to display the number of errors received with error type Bad Version.

**-g**

This option is used to display the number of Good Day messages received.

**-e**

This option is used to display the number of error messages sent (Sum of Bad Version, Bad Source and Bad Destination).

**-u**

This option is used to display the number of UPL messages received.

**-t**

This option is used to display the number of UPL messages transmitted.

**-r**

This option is used to reset the specified error count.

**-h**

This option is used to display help for the command.

**Example**

**soipdata -h**

**soipdata -f**

**soipdata -r**

**soipdata -u**

**Dependencies**

None

**Notes**

None

**Output**

**pass:loc=1305:cmd= "soipdata -h"**

```
Usage: soipdata [[-f ] |
                [[-s] [-d] [-v] [-g] [-e] [-u] [-t]
                [-r]][-h]]
```

## Options:

```
-f Display Full Operational data (all the counts)
-s Display number of SR-5129 Messages received with Bad Source
-d Display number of SR-5129 Messages received with Bad Destination
-v Display number of SR-5129 Messages received with Bad Version
-g Display number of Good Day Messages Received.
-e Display number of error messages sent (Sum of BadVersion, BadSource and
BadDestination)
-u Display number of Number of UPL messages received
-t Display number of Number of UPL messages transmitted.
-r Reset the Specified Error Count
-h display command help
```



**pass:loc=1305:cmd="soipdata -f"**

SOIPDATA: SR-5129 Operational Data Report

Operational Data

| reason                                | count |
|---------------------------------------|-------|
| Message Received with Bad Source      | 1     |
| Message Received with Bad Destination | 2     |
| Message Received with Bad Version     | 0     |
| Number of Goodday Messages Received   | 1     |
| Number of Error Messages Sent         | 10    |
| Number of UPL Messages Received       | 12000 |
| Number of UPL Messages Sent           | 19000 |

**pass:loc=1105:cmd=pass:loc=1305:cmd="soipdata -r"**

SOIPDATA : All SOIP Operational data has been reset

**pass:loc=1305:cmd="soipdata -r -u"**

SOIPDATA: Number of UPL Messages Received has been reset.

**pass:loc=1305:cmd="soipdata -u"**

SOIP Operational Data

| reason                          | count |
|---------------------------------|-------|
| Number of UPL Messages Received | 0     |

**soiplog**

**SEAS Over IP Log**

This command is used to display the logs for the SR-5129 messages for a particular SEAS terminal.

**Keyword:** soiplog

**Command Class:** Application Maintenance

**Options**

Options and option parameters that are underlined indicate that a value must be specified for that option or parameter.

**-l**

This option is used to enable and disable logging.

**-d**

This option is used to display live message logs

**-n X**

This option is used to display the last X number of messages.

**-h**

This option is used to display the help for this command.

### Example

**soiplog -h**

**soiplog -l enable":loc=XXXX**

### Dependencies

None

### Notes

With two active connections to the CCS MR, logging must be enabled on each E5-IPSM card that has an active SEAS terminal in order to properly log all SR-5129 communication data.

Assuming a message size of 500 bytes, each E5-IPSM card can log approximately 2000 messages.

If an attempt is made to enable logging on a terminal when logging is already enabled on a different terminal, then the following warning message appears in the previously enabled terminal.

*Warning: SOIP Logging Enabled from Terminal: <New logging enabled terminal>*

If an attempt is made to disable logging on a terminal when logging is already enabled on a different terminal, then the following warning message appears in the previously enabled terminal

*"Warning: SOIP Logging disabled from Terminal: <New logging enabled terminal>"*

If an attempt is made to turn on logging on a terminal when it is already enabled on a different terminal, then the following warning message appears in the previously enabled terminal.

*"Warning: SOIPLOG Started on Terminal: <New logging enabled terminal>"*

### Output

**pass:loc=1305:cmd= "soiplog -h"**

```
Usage: SOIPLOG [[-l option] | [-d] [-n] [-h]]

Options:
  -l <enable/disable>    Enable/Disable the logs
  -d                      Display live message logs
  -n <num>               Display last <num> number of messages.
Range=1..2000
  -h                      Display Command Help
```

To Enable Real time logging and display, the following commands must be entered one after the other:

**pass:cmd="soiplog -l enable":loc=XXXX**

**pass:cmd="soiplog -d":loc=XXXX**

To enable logging and to display the last N number of logged messages, the following commands must be entered one after the other:

pass:cmd="soiplog -l enable":loc=XXXX

pass:cmd="soiplog -n N":loc=XXXX

[mm/dd/yy:hour:min:sec ] Message Received.

```

0353 SR5129 Rcvd 064 bytes, trm=17
7E 7E 7E 7E 00 00 00 38      02 01 01 02 01 50 04 0A      *~~~~ 8      P *
41 42 43 44 45 46 47 48      49 50 04 0B 53 45 41 53      *ABCDEFGHJIJ SEAS*
4E 4A 43 43 53 4D 31 04      11 50 49 53 43 4E 4A 53      *NJCCSM1 PISCNJS*
4E 44 38 31 58 49 46 30      31 41 02 01 00 02 01 01      *ND81XIF01A      *
```

[mm/dd/yy:hour:min:sec ] Message Received.

```

0354 SR5129 Rcvd 133 bytes, trm=17
7E 7E 7E 7E 00 00 00 7D      02 01 01 02 01 50 04 0A      *~~~~ }
P
*
41 42 43 44 45 46 47 48      49 50 04 0B 53 45 41 53      *ABCDEFGHJIJ SEAS*
4E 4A 43 43 53 4D 31 04      11 50 49 53 43 4E 4A 53      *NJCCSM1 PISCNJS*
4E 44 38 31 58 49 46 30      31 41 02 01 00 02 01 13      *ND81XIF01A
*
04 43 03 41 41 42 44 45      46 47 48 49 50 51 53 45      * ABCDEFGHIJKSE      *
41 53 4E 4A 43 43 53 4D      31 00 56 52 46 00 2A 56      *ASNJCCSM1 VFY *V*
46 59 2D 47 54 54 3A 3A      30 31 30 2C 2A 2A 2D 2A      *FY-GTT::010,      ***
**
2A 2D 2A 2A 2C 2A 2A 3A      31 32 33 34 35 36 3A 35      **-* , **:123456:5
*
30 2C 56 52 46
*0,VRF      *
```

traceroute

IP Tracing Utility

This command is used to determine the path taken by a UDP message to a specified remote host. The command can be invoked with either a hostname or IP address.

**Keyword:** traceroute

**Command Class:** IP Stack Maintenance

**Options**

Options and option parameters that are underlined indicate that a value must be specified for that option or parameter. For example, the **traceroute** command has the option IP address. The IP address can be specified for the remote host to which the UDP message is sent, as in the command **traceroute 208.55.20.177**. Do not enter the underlined option or parameter; enter a value for the information represented by the underlined option or parameter.

**IP address**

The IP address is a TCP/IP address expressed in standard “dot notation.” IP addresses consist of the system’s network number and the machine’s unique host number. An example IP address is **192.9.200.44**, where **192.9.200** is the network number and **44** is the machine’s host number.

**Range:**

4 numbers separated by dots, with each number in the range of **0-255**.

**hostname**

Hostname. This parameter identifies the logical name assigned to the device with the IP address indicated.

**Range:**

String of characters, beginning with a letter, up to 120 characters in length. Valid characters are **a-z, A-Z, 0-9, - (hyphen), . (period)**

**-h**

This option provides help information for the command.

**-m maximum hops**

This option specifies the maximum number of hops before the trace is terminated.

**Range: 1-30**

**Default: 10**

**-n**

This option specifies that only the IP Address of each host will be displayed (not the hostname).

**-p port**

This option provides the user port number.

**Range: 1-65535**

**Default: 33434**

**Example**

```
tracert
```

```
tracert www.remotedest.com
```

```
tracert www.remotedest.com -m 20
```

```
tracert www.remotedest.com -m 20 -n
```

```
tracert 208.55.20.177
```

```
tracert 208.55.20.177 -m 20 -p 40000
```

**Dependencies**

If a Domain Name is specified, either the Domain Name must exist in the IP Host table or the Domain Name Server A or B must be provisioned.

**Notes**

The **tracert** command is executed through the **pass** command.

**Output**

The following example illustrates the help information for the command.

**pass:loc=1103:cmd="traceroute" or**

**pass:loc=1103:cmd="traceroute -h"**

```

Command entered at terminal #1.
;

rlghncxa03w 04-07-27 08:32:34 EST EAGLE5 31.6.0
PASS: Command sent to card
;

rlghncxa03w 04-07-27 08:32:34 EST EAGLE5 31.6.0

Usage: traceroute <hostname | ipaddr> [-h] [-m maxhops] [-n] [-p port]
Options:
-h           Displays this message
-m maxhops  Maximum number of hops to destination. Range=1..30. Default= 10.
-n names    Inhibits the display of intermediate host names
-p port     Port number. Range=1..65535. Default=33434.
hostname    Name of machine to trace
ipaddr     IP Address of machine to trace (d.d.d.d)
Errors:
*          Timeout
!N         Unreachable Network
!H         Unreachable Host
!?nn      Unknown Failure (nn = ICMP Code)
;

rlghncxa03w 04-07-27 08:32:34 EST EAGLE5 31.6.0

TRACEROUTE command complete

```

The following example illustrates a **traceroute** request to host **www.remotedest.com**. A maximum of 20 hops has been specified. Three packets are sent to each hop, with the time for each sample displayed. Intermediate host names are also displayed.

**pass:loc=1103:cmd="tracert www.remotedest.com -m 20"**

```

Command entered at terminal #1.
;

rlghncxa03w 04-07-27 08:32:34 EST  EAGLE5 31.6.0
PASS: Command sent to card
;

rlghncxa03w 04-07-27 08:32:34 EST  EAGLE5 31.6.0

TRACEROUTE command in progress
;

rlghncxa03w 04-07-27 08:32:34 EST  EAGLE5 31.6.0
;

rlghncxa03w 04-07-27 08:32:34 EST  EAGLE5 31.6.0
Tracert to www.remotedest.com (208.55.20.177),
  20 hops max, 100 byte packets
 1    5ms    5ms    5ms 216-187-242-57.ded.btitelecom.net (216.187.242.57)
 2   25ms   25ms   85ms 216-187-251-74.ded.btitelecom.net (216.187.251.74)
 3   25ms   25ms   25ms bti-rdu-c1-rtr.btitelecom.net (208.216.228.254)
 4   30ms   25ms   25ms Serial4-1-0.GW2.RDU1.ALTER.NET (157.130.34.93)
 5   35ms   35ms   40ms 178.ATM2-0.XR1.DCA1.ALTER.NET (146.188.162.50)
 6   40ms   40ms   35ms 195.at-2-0-0.XR1.DCA6.ALTER.NET (152.63.33.22)
 7   40ms   40ms   40ms 0.so-1-3-0.XL1.DCA6.ALTER.NET (152.63.35.114)
 8   40ms   40ms   40ms POS6-0.BR3.DCA6.ALTER.NET (152.63.38.117)
 9   40ms   40ms   40ms a3-0.uunet.mclnva02.us.bb.verio.net (204.255.169.90)
10   75ms   75ms   75ms p16-0-0-0.r00.atlnga03.us.bb.verio.net (129.250.2.49)
11   95ms   95ms   95ms p4-0-2-0.r01.bcrf101.us.bb.verio.net (129.250.4.54)
12   95ms   95ms   95ms ge-1-1.r01.border.boca.verio.net (129.250.28.52)
13   95ms   95ms   95ms ge-8-1.r01.edge.boca.verio.net (208.55.254.9)
14   95ms   95ms   95ms www.remotedest.com (208.55.20.177)

TRACEROUTE command complete
;

```

The following example illustrates a **tracert** request to host **www.remotedest.com**. No maximum number of hops has been specified. Intermediate host names are displayed. The display terminates after 10 hops.

```
pass:loc=1103:cmd="traceroute www.remotedest.com"
```

```

Command entered at terminal #1.
;

rlghncxa03w 04-07-27 08:32:34 EST  EAGLE5 31.6.0
PASS: Command sent to card
;

rlghncxa03w 04-07-27 08:32:34 EST  EAGLE5 31.6.0

TRACEROUTE command in progress
;

rlghncxa03w 04-07-27 08:32:34 EST  EAGLE5 31.6.0
;

rlghncxa03w 04-07-27 08:32:34 EST  EAGLE5 31.6.0
Traceroute to www.remotedest.com (208.55.20.177),
  10 hops max, 100 byte packets
 1   5ms   5ms   5ms 216-187-242-57.ded.btitelecom.net (216.187.242.57)
 2  25ms  25ms  25ms 216-187-251-74.ded.btitelecom.net (216.187.251.74)
 3  25ms  25ms  25ms bti-rdu-cl-rtr.btitelecom.net (208.216.228.254)
 4  25ms  25ms  25ms 157.130.34.93 (157.130.34.93)
 5  35ms  40ms  40ms 178.ATM2-0.XR1.DCA1.ALTER.NET (146.188.162.50)
 6  40ms  35ms  45ms 195.at-2-0-0.XR1.DCA6.ALTER.NET (152.63.33.22)
 7  45ms  40ms  40ms 0.so-1-3-0.XL1.DCA6.ALTER.NET (152.63.35.114)
 8  40ms  35ms  35ms POS6-0.BR3.DCA6.ALTER.NET (152.63.38.117)
 9  40ms  40ms  40ms a3-0.uunet.mclnva02.us.bb.verio.net (204.255.169.90)
10  75ms  75ms  80ms p16-0-0-0.r00.atlnga03.us.bb.verio.net (129.250.2.49)
Maximum number of hops reached

TRACEROUTE command complete
;

```

The following example illustrates a **traceroute** request to host IP address **208.55.20.177**. No maximum number of hops has been specified. Intermediate host names are displayed. The display terminates after 10 hops.

**pass:loc=1103:cmd="tracert 208.55.20.177"**

```

Command entered at terminal #1.
;

rlghncxa03w 04-07-27 08:32:34 EST  EAGLE5 31.6.0
PASS: Command sent to card
;

rlghncxa03w 04-07-27 08:32:34 EST  EAGLE5 31.6.0

TRACEROUTE command in progress
;

rlghncxa03w 04-07-27 08:32:34 EST  EAGLE5 31.6.0
Tracert to www.remotedest.com (208.55.20.177),
    10 hops max, 100 byte packets
 1    5ms    5ms    5ms  216-187-242-57.ded.btitelecom.net (216.187.242.57)
 2   55ms   260ms  300ms 216-187-251-74.ded.btitelecom.net (216.187.251.74)
 3   25ms   25ms   25ms bti-rdu-cl-rtr.btitelecom.net (208.216.228.254)
 4   25ms   25ms   25ms Serial4-1-0.GW2.RDU1.ALTER.NET (157.130.34.93)
 5   40ms   35ms   35ms 178.ATM2-0.XR1.DCA1.ALTER.NET (146.188.162.50)
 6   40ms   35ms   40ms 195.at-2-0-0.XR1.DCA6.ALTER.NET (152.63.33.22)
 7   35ms   40ms   40ms 0.so-1-3-0.XL1.DCA6.ALTER.NET (152.63.35.114)
 8   40ms   35ms   40ms POS6-0.BR3.DCA6.ALTER.NET (152.63.38.117)
 9   40ms   40ms   40ms a3-0.uunet.mclnva02.us.bb.verio.net (204.255.169.90)
10   75ms   75ms   75ms p16-0-0-0.r00.atlnga03.us.bb.verio.net (129.250.2.49)
)
Maximum number of hops reached

TRACEROUTE command complete
;

```

The following example illustrates a **tracert** request to host IP address **208.55.20.177**. A maximum of 20 hops has been specified. Intermediate host names are displayed.



```
pass:loc=1103:cmd="traceroute 208.55.20.177 -m 20"
```

```

Command entered at terminal #1.
;

rlghncxa03w 04-07-27 08:32:34 EST EAGLE5 31.6.0
PASS: Command sent to card
;

rlghncxa03w 04-07-27 08:32:34 EST EAGLE5 31.6.0

TRACEROUTE command in progress
;

rlghncxa03w 04-07-27 08:32:34 EST EAGLE5 31.6.0
;

rlghncxa03w 05-07-27 08:32:34 EST EAGLE5 31.6.0
Traceroute to www.remotedest.com (208.55.20.177),
  20 hops max, 100 byte packets
 1   5ms   5ms   5ms  216-187-242-57.ded.btitelecom.net (216.187.242.57)
 2  25ms  25ms  25ms  216-187-251-74.ded.btitelecom.net (216.187.251.74)
 3  25ms  25ms  25ms  bti-rdu-cl-rtr.btitelecom.net (208.216.228.254)
 4  25ms  25ms  25ms  Serial4-1-0.GW2.RDU1.ALTER.NET (157.130.34.93)
 5  35ms  35ms  35ms  178.ATM2-0.XR1.DCA1.ALTER.NET (146.188.162.50)
 6  35ms  40ms  35ms  195.at-2-0-0.XR1.DCA6.ALTER.NET (152.63.33.22)
 7  35ms  35ms  35ms  0.so-1-3-0.XL1.DCA6.ALTER.NET (152.63.35.114)
 8  40ms  35ms  35ms  POS6-0.BR3.DCA6.ALTER.NET (152.63.38.117)
 9  40ms  40ms  40ms  a3-0.uunet.mclnva02.us.bb.verio.net (204.255.169.90)
10  75ms  75ms  75ms  p16-0-0-0.r00.atlnga03.us.bb.verio.net(129.250.2.49)
11  95ms  95ms  95ms  p4-0-2-0.r01.bcrftf101.us.bb.verio.net (129.250.4.54)
12  95ms  95ms  95ms  ge-1-1.r01.border.boca.verio.net (129.250.28.52)
13  95ms  95ms  95ms  ge-8-1.r01.edge.boca.verio.net (208.55.254.9)
14  95ms  95ms  95ms  www.remotedest.com (208.55.20.177)

TRACEROUTE command complete
;

```

The following example illustrates a **traceroute** request to host IP address **208.55.20.177**. A maximum of 20 hops has been specified. Intermediate host names are not displayed because the **-n** option is specified.

**pass:loc=1103:cmd="tracert 208.55.20.177 -m 20 -n"**

```

Command entered at terminal #1.
;
  rlghncxa03w 04-07-27 08:32:34 EST  EAGLE5 31.6.0
PASS: Command sent to card
;

  rlghncxa03w 04-07-27 08:32:34 EST  EAGLE5 31.6.0

TRACEROUTE command in progress
;

  rlghncxa03w 04-07-27 08:32:34 EST  EAGLE5 31.6.0

;

  rlghncxa03w 04-07-27 08:32:34 EST  EAGLE5 31.6.0
Traceroute to www.remotedest.com (208.55.20.177),
  20 hops max, 100 byte packets
  1    5ms    5ms    5ms  216.187.242.57
  2   25ms   25ms   25ms  216.187.251.74
  3   25ms   25ms   25ms  208.216.228.254
  4   30ms   30ms   30ms  157.130.34.93
  5   35ms   40ms   40ms  146.188.162.50
  6   40ms   40ms   40ms  152.63.33.22
  7   40ms   45ms   40ms  152.63.35.114
  8   40ms   40ms   35ms  152.63.38.117
  9   40ms   40ms   40ms  204.255.169.90
 10  75ms   75ms   75ms  129.250.2.49
 11  95ms   95ms   95ms  129.250.4.54
 12  95ms   95ms   95ms  129.250.28.52
 13  95ms   95ms   95ms  208.55.254.9
 14 110ms  100ms   95ms  208.55.20.177

TRACEROUTE command complete
;

```

The following example illustrates a **tracert** request to host IP address **www.remotedest.com**. A maximum of 20 hops has been specified. Intermediate host names are not displayed because the **-n** option is specified.

**pass:loc=1103:cmd="traceroute www.remotedest.com -m 20 -n"**

```

Command entered at terminal #1.
;
  rlghncxa03w 04-07-27 08:32:34 EST  EAGLE5 31.6.0
PASS: Command sent to card
;

  rlghncxa03w 04-07-27 08:32:34 EST  EAGLE5 31.6.0

TRACEROUTE command in progress
;

  rlghncxa03w 04-07-27 08:32:34 EST  EAGLE5 31.6.0

;

  rlghncxa03w 05-07-27 08:32:34 EST  EAGLE5 31.6.0
Traceroute to www.remotedest.com (208.55.20.177),
  20 hops max, 100 byte packets
  1    5ms    5ms    5ms  216.187.242.57
  2   25ms   25ms   25ms  216.187.251.74
  3   25ms   25ms   25ms  208.216.228.254
  4   30ms   30ms   30ms  157.130.34.93
  5   35ms   40ms   40ms  146.188.162.50
  6   40ms   40ms   40ms  152.63.33.22
  7   40ms   45ms   40ms  152.63.35.114
  8   40ms   40ms   35ms  152.63.38.117
  9   40ms   40ms   40ms  204.255.169.90
 10  75ms   75ms   75ms  129.250.2.49
 11  95ms   95ms   95ms  129.250.4.54
 12  95ms   95ms   95ms  129.250.28.52
 13  95ms   95ms   95ms  208.55.254.9
 14 110ms  100ms  95ms  208.55.20.177

TRACEROUTE command complete
;

```

The following example illustrates a **traceroute** request to host IP address **208.55.20.177**. A maximum of 20 hops has been specified. Intermediate host names are displayed. Application Port 40000 is used.

**pass:loc=1103:cmd="traceroute 208.55.20.177 -m 20 -p 40000"**

```

Command entered at terminal #1.
;

  rlghncxa03w 04-07-27 08:32:34 EST  EAGLE5 31.6.0
PASS: Command sent to card
;

  rlghncxa03w 04-07-27 08:32:34 EST  EAGLE5 31.6.0

TRACEROUTE command in progress
;

  rlghncxa03w 04-07-27 08:32:34 EST  EAGLE5 31.6.0

;

```

```

rlghncxa03w 04-07-27 08:32:34 EST  EAGLE5 31.6.0
Tracert to www.remotedest.com (208.55.20.177),
    20 hops max, 100 byte packets
 1   5ms    5ms    5ms  216-187-242-57.ded.btitelecom.net (216.187.242.57)
 2  25ms   25ms   25ms  216-187-251-74.ded.btitelecom.net (216.187.251.74)
 3  25ms   25ms   25ms  208.216.228.254 (208.216.228.254)
 4  25ms   25ms   25ms  157.130.34.93 (157.130.34.93)
 5  35ms   40ms   40ms  178.ATM2-0.XR1.DCA1.ALTER.NET (146.188.162.50)
 6  45ms   35ms   40ms  195.at-2-0-0.XR1.DCA6.ALTER.NET (152.63.33.22)
 7  35ms   40ms   40ms  0.so-1-3-0.XL1.DCA6.ALTER.NET (152.63.35.114)
 8  40ms   35ms   40ms  POS6-0.BR3.DCA6.ALTER.NET (152.63.38.117)
 9  40ms   40ms   40ms  a3-0.uunet.mclnva02.us.bb.verio.net (204.255.169.90)
10  75ms   75ms   75ms  p16-0-0-0.r00.atlnga03.us.bb.verio.net(129.250.2.49)
11  95ms   95ms   95ms  p4-0-2-0.r01.bcrftl01.us.bb.verio.net (129.250.4.54)
12  95ms   95ms   95ms  ge-1-1.r01.border.boca.verio.net (129.250.28.52)
13  95ms   95ms   95ms  ge-8-1.r01.edge.boca.verio.net (208.55.254.9)
14  95ms   95ms   95ms  www.remotedest.com (208.55.20.177)

TRACEROUTE command complete
;

```

The following example illustrates a tracert request to host IP address 204.202.136.31. A maximum of 20 hops has been specified. Intermediate host names are displayed. Several timeouts occur. Finally, an ICMP error is received (in this case, an unknown response with an ICMP code = 13), and the command is terminated immediately.

**pass:loc=1103:cmd="tracert 204.202.136.31 -m 20"**

```

Command entered at terminal #1.
;

rlghncxa03w 04-07-27 08:32:34 EST  EAGLE5 31.6.0
PASS: Command sent to card
;

rlghncxa03w 04-07-27 08:32:34 EST  EAGLE5 31.6.0

TRACEROUTE command in progress
;

rlghncxa03w 04-07-27 08:32:34 EST  EAGLE5 31.6.0
;

```

```

rlghncxa03w 04-07-27 08:32:34 EST EAGLE 31.6.0
Traceroute to 204.202.136.31 (204.202.136.31),
  20 hops max, 100 byte packets
 1  5ms  5ms  5ms 216-187-242-57.ded.btitelecom.net (216.187.242.57)
 2  25ms 25ms 25ms 216-187-251-74.ded.btitelecom.net (216.187.251.74)
 3  25ms 25ms 25ms bti-rdu-c1-rtr.btitelecom.net (208.216.228.254)
 4  25ms 25ms 25ms Serial4-1-0.GW2.RDU1.ALTER.NET (157.130.34.93)
 5  35ms 40ms 35ms 178.ATM2-0.XR1.DCA1.ALTER.NET (146.188.162.50)
 6  40ms 35ms 35ms 195.at-1-0-0.TR1.DCA6.ALTER.NET (152.63.33.206)
 7  110ms 115ms 115ms 121.at-1-1-0.TR1.SEA1.ALTER.NET (146.188.140.74)
 8  110ms 115ms 115ms 299.ATM7-0.XR1.SEA1.ALTER.NET (146.188.200.109)
 9  115ms 115ms 115ms 195.ATM5-0.GW5.SEA1.ALTER.NET (146.188.201.57)
10  110ms 110ms 110ms waltdisney1-OC12-gw.customer.alter.net(157.130.182.30)
11  110ms 115ms 110ms 204.202.138.71 (204.202.138.71)
12  *      *      *      Request timed out
13  !?13   Unreachable

TRACEROUTE command complete

```

;

## ualog

## User Adapter Log

Use this command to report on the user adapter (UA) state machine history for a specified association name. State machine history is kept in a circular buffer in memory. The **-i** and **-x** options are used to include or exclude groups of events from the state machine history.

**Keyword:** ualog

**Command Class:** Application Maintenance

### Options

Options and option parameters that are underlined indicate that a value must be specified for that option or parameter. For example, the **ualog** command has the parameter aname. The association name must be specified for which the user adapter log will be displayed, as in the command **ualog s7000**. Do not enter the underlined option or parameter; enter a value for the information represented by the underlined option or parameter.

aname

This option specifies the association name for the display.

**-h**

This option displays help (usage) information for the command.

**-i event group**

This option includes groups of events in the state machine history.

**Range:** service, ua

**-x event group**

This option excludes groups of events from the state machine history.

**Range:** service, ua

### Example

```
pass:loc=1105:cmd="ualog s7000"
```

### Dependencies

None

**Notes**

None

**Output****pass:loc=1105:cmd="ualog s7000"**

```

rlghncxa03w 05-07-27 08:10:00 EST  EAGLE5 34.0.0
PASS: Command sent to card
;
rlghncxa03w 05-07-27 08:10:00 EST  EAGLE5 34.0.0
UALOG command in progress
;
rlghncxa03w 05-07-27 08:10:00 EST  EAGLE5 34.0.0
Date      Time          ASP Event
-----
05-07-27  17:17:46.940  Management Socket Open
05-07-27  17:17:46.940  Transition to Connecting
05-07-27  17:17:47.500  Socket Allowed for Traffic
05-07-27  17:17:49.375  Socket Connection Established
05-07-27  17:17:49.375  Transition to ASP-DOWN
05-07-27  17:17:49.390  ASPUP PDU Received (ASP ID = 0x00000002)
05-07-27  17:17:49.390  ASPUPACK PDU Transmitted
05-07-27  17:17:49.390  Transition to ASP-INACTIVE LOADSHARE (RC=none)
05-07-27  17:17:49.390  AS INACTIVE NTFY PDU Transmitted (RC=none)
05-07-27  17:17:49.405  ASPACTIVE PDU Received (RC=none)
05-07-27  17:17:49.405  ASPACTIVEACK PDU Transmitted (RC=none)
05-07-27  17:17:49.405  Transition to ASP-ACTIVE LOADSHARE (RC=none)
05-07-27  17:17:49.405  AS ACTIVE NTFY PDU Transmitted (RC=none)
05-07-27  17:17:50.405  ASP INACT NTFY PDU Transmitted (ASP ID = 0x00000005)
05-07-27  17:17:50.405  ASP ACT NTFY PDU Transmitted (ASP ID = 0x00000005)
05-07-27  17:17:52.730  ASP FAILURE NTFY PDU Transmitted (ASP ID = 0x00000003)

UALOG command complete
;

```

**pass:loc=1105:cmd="ualog s7000"**

Command Accepted - Processing

```
rlghncxa03w 05-07-27 08:10:00 EST EAGLE5 34.0.0
pass:loc=1105:cmd="ualog s7000"
```

;

```
rlghncxa03w 05-07-27 08:10:00 EST EAGLE5 34.0.0
PASS: Command sent to card
```

;

```
rlghncxa03w 05-07-27 08:10:00 EST EAGLE5 34.0.0
```

UALOG command in progress

;

```
rlghncxa03w 05-07-27 08:10:00 EST EAGLE5 34.0.0
```

```
UALOG: User Adapter state history log
      UA Version: 01
      ASP ID: 0x00000007
      User Adapter Implemented: SUA RFC
      Current settings: -i service ua
```

| Date     | Time         | Event                                               |
|----------|--------------|-----------------------------------------------------|
| 05-07-27 | 19:45:33.265 | CLDT PDU Transmitted(RC=0000000001)                 |
| 05-07-27 | 19:48:07.490 | ASPINACTIVE PDU Received(RC=none)                   |
| 05-07-27 | 19:48:07.490 | ASPINACTIVEACK PDU Transmitted(RC=0000000002)       |
| 05-07-27 | 19:48:07.490 | Transition to ASP-INACTIVE LOADSHARE(RC=0000000002) |
| 05-07-27 | 19:48:07.490 | AS PENDING NTFY PDU Transmitted(RC=0000000002)      |
| 05-07-27 | 19:48:07.500 | AS INACTIVE NTFY PDU Transmitted(RC=0000000002)     |
| 05-07-27 | 19:48:19.730 | ASPACTIVE PDU Received(RC=0000000001)               |
| 05-07-27 | 19:48:19.730 | ASPACTIVEACK PDU Transmitted(RC=0000000001)         |
| 05-07-27 | 19:48:19.730 | Transition to ASP-ACTIVE LOADSHARE(RC=0000000001)   |
| 05-07-27 | 19:48:19.730 | AS ACTIVE NTFY PDU Transmitted(RC=0000000001)       |

UALOG: command complete

;

When a M3UA or SUA PDU is received that contains one or more errors, a response error message is transmitted containing an error code. Error codes are recorded to and displayed in the UALOG only when the UA peer-to-peer message logging option is enabled (**-i ua**), as shown in the following example.:

**pass:loc=1315:cmd="ualog assoc1315a1"**

Command Accepted - Processing

```

rlghncxa03w 05-07-27 08:10:00 EST  EAGLE5 34.0.0
pass:loc=1315:cmd="ualog assoc1315a1"
Command entered at terminal #3.
;

rlghncxa03w 05-07-27 08:10:00 EST  EAGLE5 34.0.0
PASS: Command sent to card
;

rlghncxa03w 05-07-27 08:10:00 EST  EAGLE5 34.0.0

UALOG command in progress
;

rlghncxa03w 05-07-27 08:10:00 EST  EAGLE5 34.0.0

UALOG: User Adapter state history log
      UA Version: 01
      ASP ID:undefined
      User Adapter Implemented: M3UA RFC
      Current settings: -i service ua

Date      Time      Socket Event
-----
05-07-27  17:17:46.940  Management Socket Open
05-07-27  17:17:46.940  Transition to Connecting
05-07-27  17:17:49.375  Socket Connection Established
05-07-27  17:17:49.375  Transition to ASP-DOWN
05-07-27  17:17:49.390  ASPUP PDU Received (ASP ID = undefined)
05-07-27  17:17:49.390  ASPUPACK PDU Transmitted
05-07-27  17:17:49.390  Transition to ASP-INACTIVE LOADSHARE
05-07-27  17:17:49.390  AS INACTIVE NTFY PDU Transmitted
05-07-27  17:17:49.405  ASPACTIVE PDU Received
05-07-27  17:17:49.405  ASPACTIVEACK PDU Transmitted
05-07-27  17:17:49.405  Transition to ASP-ACTIVE LOADSHARE
05-07-27  17:17:49.405  AS ACTIVE NTFY PDU Transmitted
05-07-27  17:17:49.450  DAUD PDU Received
05-07-27  17:17:49.480  ERR PDU Transmitted (0x00000015)

UALOG command complete
;

```

**Error Codes**

**NOTE: The following error codes are not used in M3UA: 0x02, 0x08, 0x1a, 0x1b, 0x1c, 0x10, 0x17, and 0x18**

The following error codes can appear in the error messages:

**0x01—Invalid Version**

A message was received with an invalid or unsupported version. The error message contains the supported version in the Common Header.

**0x03—Unsupported Message Class**



A message was received with an unexpected or unsupported Message Class.

**0x04**—Unsupported Message Type

A message was received with an unexpected or unsupported Message Type.

**0x05**—Unsupported Traffic Handling Mode

This error is sent by a Signaling Gateway Process (SGP) if an Application Server Process (ASP) sends an ASP Active message with an unsupported Traffic Mode Type or a Traffic Mode Type that is inconsistent with the currently configured mode for the Application Server (AS).

**0x06**—Unexpected Message

This error message can be sent if a defined and recognized message is received that is not expected in the current state. In some cases the ASP might silently discard the message and not send an error message. Silent discard is used by an ASP if it received a DATA message from a signaling point while the ASP is in the ASP-INACTIVE state. If the unexpected message contains Routing Context, the Routing Context can be included in the error message.

**0x07**—Protocol Error

This error message is sent for any protocol anomaly, such as reception of a parameter that is syntactically correct but unexpected in the current situation.

**0x09**—Invalid Stream Identifier

A message is received on an unexpected SCTP stream (for example, a Management message was received on a stream other than 0).

**0x0d**—Refused - Management Blocking

An ASP Up or ASP Active message is received and the request is refused for management reasons (such as management lockout). If this error is in response to an ASP Active message, the Routing Context in the ASP Active message can be included in the error message.

**0x0e**—ASP Identifier Required

This error message is sent by an SGP in response to an ASP Up message that does not contain an ASP Identifier parameter when the SGP requires one. The ASP should resend the ASP Up message with an ASP Identifier.

**0x0f**—Invalid ASP Identifier

This error message is sent by an SGP in response to an ASP Up message with an invalid (for example, non-unique) ASP Identifier

**0x11**—Invalid Parameter Value

A message is received with an invalid parameter value (for example, a DUPU message was received with a Mask value other than 0).

**0x12**—Parameter Field Error

A message is received with a parameter that has a wrong length field.

**0x13**—Unexpected Parameter

A message contains an invalid parameter.

**0x14**—Destination Status Unknown

This error message can be sent if a DAUD is received at a Signaling Gateway (SG) asking for the availability/congestion status of a destination, and the SG does not provide the status (as in the case when the sender is not authorized to know the status). For this error, each invalid or unauthorized Point Code is included along with the Network Appearance and/or Routing Context associated with the Point Code.

**0x15**—Invalid Network Appearance

This error message is sent by an SGP if an ASP sends a message with an invalid (unconfigured) Network Appearance value. For this error, the invalid (unconfigured) Network Appearance is included in the Network Appearance parameter.

**0x16**—Missing Parameter

A message is received, and a mandatory parameter is not included in the message.

**0x19**—Invalid Routing Context

A message is received from a peer with an invalid (unconfigured) Routing Context value. The invalid Routing Context is included in the error message.

**0x1a**—No Configured AS for ASP

A message is received from a peer without a Routing Context parameter, and it is not known by configuration data which Application Servers are referenced.



# Reference Information

Summary of Range Values for :link Parameter..... A-1

Possible Values for PST/SST/AST..... A-3

    PST..... A-3

    SST..... A-3

    AST..... A-4

Point Code Formats and Conversion..... A-5

    ANSI Point Codes..... A-5

    ITU International Point Codes..... A-7

    ITU National Point Codes..... A-7

    Converting ITU National Point Code Formats..... A-8

        Introduction..... A-8

        Converting Single Number ITU National Point Codes..... A-8

        Converting Multiple-Part ITU National Point Codes..... A-9

    24-bit ITU-National Point Codes..... A-10

    Spare and Private Point Code Subtype Prefixes..... A-10

Valid CIC Ranges for SI and MSU Types in Routing Key Static Entries..... A-13

NAIV/NAI Mapping..... A-13

NPV/NP Mapping..... A-14

Cards that use the ent-card Command..... A-15

Summary of Loopback Testing Commands and Functions..... A-18

## Summary of Range Values for :link Parameter

Table A-1 lists the valid **link** parameter range values signaling links assigned to each type of card for which a location can be specified in the command **loc** parameter. The commands that use these values refer to this table in their **link** parameter description.

**NOTE: The link parameter is a synonym for the port parameter in signaling link definitions for a few EAGLE 5 ISS releases. Then the port parameter will be removed.**

**Table A-1.** Summary of Ranges for **link** Parameter

| Card | Link | Supported Application                               |
|------|------|-----------------------------------------------------|
| DCM  | A    | Runs the <b>ss7ipgworipgwi</b> application.         |
| DCM  | A, B | Runs the <b>iplim</b> or <b>iplimi</b> application. |

Table A-1. Summary of Ranges for link Parameter

| Card                          | Link                                      | Supported Application                                                                                                                                                                                                     |
|-------------------------------|-------------------------------------------|---------------------------------------------------------------------------------------------------------------------------------------------------------------------------------------------------------------------------|
| Multi-port LIM                | <b>A, B, A1, B1, A2, B2, A3, B3</b>       | The <b>ss7ml</b> GPL with DS0 interface at 56 Kb running the <b>ss7ansi</b> application only.                                                                                                                             |
| E1/T1 MIM                     | <b>A, B, A1, B1, A2, B2, A3, B3</b>       | The <b>ss7ml</b> GPL running the <b>ss7ansi</b> or <b>ccs7itu</b> application.                                                                                                                                            |
| IPLIMx with 8 Points (SSEDCM) | <b>A, B, A1, B1, A2, B2, A3, B3</b>       | The <b>iplim</b> and <b>iplimi</b> GPLs running the <b>iplim</b> and <b>iplimi</b> applications with M2PA/SCTP associations or M3UA/SCTP associations.                                                                    |
| HC-MIM                        | <b>A, B, A1-A31, B1-B31</b>               | Runs the <b>ss7ansi</b> or <b>ccs7itu</b> application. A maximum of 64 links can be assigned to each HC-MIM card.                                                                                                         |
| HC-MIM for SE-HSL             | <b>A, B</b>                               | Runs the <b>ss7ansi</b> or <b>ccs7itu</b> application. A maximum of 2 SE-HSL links can be assigned to a card.                                                                                                             |
| HC-MIM for ST-HSL-A           | <b>A, B</b>                               | Runs the <b>ss7ansi</b> application. The card can support up to 2 signaling links.                                                                                                                                        |
| EDCM (SSEDCM)                 | <b>A</b>                                  | Runs the <b>ss7ipgw</b> or <b>ipgwi</b> application.                                                                                                                                                                      |
| LIM-ATM                       | <b>A</b>                                  | Runs the <b>atmansi</b> application for ANSI ATM high-speed signaling links.                                                                                                                                              |
| E5-ATM                        | <b>A, B</b>                               | Runs the <b>atmansi</b> or <b>atmitu</b> application. The card can support up to 2 signaling links.                                                                                                                       |
| E5-ENET                       | <b>A, B, A1-A7, B1-B7, A1-A15, B1-B15</b> | The <b>iplim</b> and <b>iplimi</b> GPLs running the <b>iplim</b> and <b>iplimi</b> applications with sockets, M2PA/SCTP associations, or M3UA/SCTP associations. The <b>ipsggpl</b> running the <b>ipsg</b> applications. |
| E5-E1T1                       | <b>A, B, A1-A15, B1-B15</b>               | Runs the <b>ss7ansi</b> or <b>ccs7itu</b> application. A maximum of 32 links can be assigned to each E5-E1T1 card.                                                                                                        |
| E5-E1T1 for SE-HSL            | <b>A</b>                                  | Runs the <b>ss7ansi</b> or <b>ccs7itu</b> application. Only 1 SE-HSL link can be assigned to a card.                                                                                                                      |
| E5-E1T1 for ST-HSL-A          | <b>A</b>                                  | Runs the <b>ss7ansi</b> application. Only 1 ST-HSL-A link can be assigned to a card.                                                                                                                                      |

## Possible Values for PST/SST/AST

This section lists the possible values for the primary state (PST), secondary state (SST), and associated state (AST) shown in the output of Report Status (rept-stat-) and Retrieve (rtrv-) commands.

Status can apply to the following types of entities (not all values are possible for every entity type):

|                                 |               |
|---------------------------------|---------------|
| card                            | terminal port |
| clock                           | serial port   |
| cluster                         | but           |
| TCP/IP data link signaling link |               |
| subsystem                       | linkset       |
| EPAP/ELAP                       | ACM           |

### PST

Primary state possible values are the following:

**IS-ANR**—(In Service - Abnormal) The entity is in service but only able to perform a limited subset of its normal service functions.

**IS-NR**—(In Service - Normal) The entity is in service and handling all its normal service functions.

**OOS-MA**—(Out Of Service - Memory Administration) The entity is out of service because it has not been equipped.

**OOS-MT**—(Out Of Service - Maintenance) The entity is out of service and is not available to perform its normal service function. The maintenance system is actively working to restore the entity to service.

**OOS-MT-DSBLD**—(Out Of Service - Maintenance -Disabled) The entity is out of service and the maintenance system is preventing the entity from performing its normal service function.

### SST

Secondary state possible values are the following:

**ACTIVE**—(Active) The entity is currently in use and is handling its normal service function as the primary service provider. (Master) The entity is currently in a master state in relation to its redundant unit.

**ALLOWED**—(Allowed) The entity is handling its normal service function.

**AVAIL**—(Available) Entity service is available to another entity.

**BLOCKED**—(Blocked) The entity has been manually prohibited from handling traffic.

**BUSY**—(Busy) The entity is handling the maximum traffic capacity and has no spare capacity for new service requests.

**CONN**—(Connect) The card's entity status is in connected state.

**DISC**—(Disconnect) The card's entity status is in disconnected state.

**FAULT**—(Fault) The entity has failed.

**IDLE**—(Idle) The entity is in use and has spare capacity for service. For a telnet terminal, this indicates a "ready for connection" status.

**INHIBITED**—(Inhibited) The entity has been manually prevented from performing its normal service function.

**ISOLATED**—(Isolated) The entity cannot be detected through software or hardware.

**LPBK**—(Loopback) The entity status of the card is in the Loopback state.

**MANUAL**—(Manual) The entity has manually been removed from service and is not carrying any traffic.

**MEA**—(Mismatch of Equipment and Attributes) A B link is provisioned for a card other than a LIMATM or a LIME1ATM card.

**OVFLW-1**—(Overflow) One entity cannot provide service to another entity due to service denial.

**PROHIBIT**—(Prohibited) The entity is not handling traffic because of a failure in the network.

**RESTRICT**—(Restricted) The traffic the entity is handling is restricted. The normal capacity or configuration is not being used because of a failure in the network. The normal capacity, functionality or configuration of an entity may be restricted during loading or synching of data. This can occur when the Measurements Platform has not yet been enabled.

**STANDBY**—(Standby) The entity is currently in use and is handling its normal service function as an alternate service provider if the primary service provider failed. For an IPSM card, Standby is the state just prior to Ready, while the card completes initializations.

**STANDBY**—(Slave) The entity is currently in a slave state in relation to its redundant unit.

**TEST**—(Test) The entity is currently in a test state.

**UNAVAIL**—(Unavailable) Entity service is unavailable to another entity.

**UEQ**—(Unequipped) The entity is not equipped.

**UNBLOCKED**—(Unblocked) The entity is handling its normal service function.

## AST

Associated state possible values are the following:

---- (Blank)—The field may be left blank.

**ACCESS**—(Accessible) Traffic is being carried between the local entity and an adjacent, or remote, service provider. A full connection has been completed.

**ACTIVE**—(Active) The entity is currently in use and is handling its normal service function as the primary service provider. (This appears as an AST for the MPS when there is an alarm on it.)

**ALMINH**—(Alarm Inhibited) The alarm has been inhibited.

**BIP ERROR**—(Board Identity Prom) The entity has both daughterboard and motherboard prom error.

**DB DIFF**—(Database Different) The entity has a database difference.

**D BIP ERR**—(Daughterboard Identity Prom) The entity has a daughterboard prom error.

**ENET FLT**—(Ethernet fault) An Ethernet fault exists.

**FEwLINE**—(Far End Line) Far End loopback state.

**FEwPAYLO**—(Far End Payload) Far End Payload loopback state.

**GWS**—(Gateway Screening) Linkset has gateway screening. See the **rept-stat-ls** command.

**INACCESS**—(Inaccessible) Traffic is not being carried from the local entity to another service provider. A breakdown in a complete circuit has been detected.

**LINE**—(Local Line) Local Line loopback state

**LOCAL**—(Local) Entity has become locally isolated.

**LXVR**—(Local Transceiver) Local Transceiver loopback state

**M BIP ERR**—(Motherboard Identity Prom) The entity has a motherboard prom error.

**MPS UNAVL**—The DSM card cannot communicate to an MPS.

**PAYLOAD**—(Local Payload) Local Payload loopback state

**STANDBY**—(Standby) The entity is currently in use and is handling its normal service function as an alternate service provider if the primary service provider failed. (This appears as an AST for the MPS when there is an alarm on it.)

**XX%**—(Progress indicator for cards that are performing a warm restart and are currently data loading. Shows the percentage of tables that have been downloaded for GPLs that support a persistent LNP database (**sccp**).

## Point Code Formats and Conversion

Many of the commands used for database configuration use point codes. This section describes the point code formats that the system supports. If you need additional information or procedural information, refer to the *Database Administration Manual - SS7*.

The system supports four different point code formats:

- ANSI point codes
- ITU International point codes
- ITU National point codes
- ITU National 24-bit point codes

Each format is described in further detail in the following sections.

### ANSI Point Codes

ANSI point codes are made up of three groups of digits called the network indicator (*ni*), network cluster (*nc*), and network cluster member (*ncm*). The values for ANSI point codes depend on the value of the **pctype** parameter of the **chg-sid** command, either **ansi** or **other**.

If the **chg-sid:pctype** parameter is set to **ansi**, the range of values for an ANSI point code is as follows:

*ni*—**001-255**

*nc*—**001-255** (if *ni* = **001-005**)

—**000-255**, \* (if *ni* = **006-255**)

*ncm*—**000-255**

The following rules apply to provisioning ANSI point codes if the **chg-sid:pctype=ansi** parameter is specified:

- An *ni* value of **0** is not allowed (for example, **dpc=0-1-1** and **dpc=0-0-0** are not valid point codes).
- If the *ni* value is **1, 2, 3, 4, or 5**, then the *nc* value cannot be **0** (for example, **dpc=5-0-1** is rejected).
- If the *ni* value is **1, 2, 3, 4, or 5**, then network routing point codes are not allowed (for example, **dpc=4-\*-\*** is rejected).

If the **chg-sid:pctype** parameter is set to **other**, the ANSI point codes do not meet ANSI standards. The range of values for these ANSI point codes is as follows:

*ni*—**000-255**  
*nc*—**000-255, \***  
*ncm*—**000-255, \***

The following rules apply to provisioning ANSI point code if the **chg-sid:pctype=other** parameter is specified:

- An *ni* value of **0** is allowed, however **dpc=0-0-0** is rejected (for example, **dpc=0-1-1** is accepted).
- The *nc* value can be **0** for all values of *ni* (for example, **dpc=5-0-1** is accepted).
- Network routing point codes are allowed for all values of *ni* (for example, **dpc=4-\*-\*** is accepted).

An ANSI point code containing all zeros (**0-0-0**) is not a valid point code and cannot be entered into the database.

ANSI point codes support the Private (Internal) Point Code subtype prefix (**p-**). The prefix can be specified before the point code subfield values to indicate a Private Point Code (**p-5-0-1**, for example). See "Spare and Private Point Code Subtype Prefixes".

**NOTE: Point codes specified by many commands, including those for site identification, routing keys, and LNP, are required to be full point codes. The asterisk values are not valid in the commands that specify these point codes. The command Dependencies sections identify the point codes that must be full point codes in the commands.**

A range of values for a subfield is specified by separating the values that define the range by two ampersands (&&); for example, **ni=025&&100** specifies all network indicators for ANSI point codes from **25** through **100**.

The asterisk (\*) point code value indicates a single cluster address for a cluster point code (for example, **20-2-\***) or a network routing destination (**20-\*-\***). If \* is used for the *nc* subfield, then \* must be also be used for the *ncm* subfield.

A double asterisk (\*\*) and a triple asterisk (\*\*\*) can also be used for the *nc* and *ncm* subfields of the ANSI point code, but only for the **rtrv-dstn**, **rept-stat-dstn**, **rtrv-rte**, and **rept-stat-rte** commands. If \*, \*\*, or \*\*\* is used for the *nc* subfield, then \*, \*\*, or \*\*\* must be used for the *ncm* field

For examples of all of these point code values, see the **rtrv-dstn** command output in Chapter 5 of the *Commands Manual*.



## ITU International Point Codes

The ITU international point codes are made up of three groups of digits called *zone*, *area*, and *id*. The range of values for ITU International point codes are:

*zone*—**0-7**

*area*—**000-255**

*id*—**0-7**

An ITU international point code containing all zeros (**0-000-0**) is not a valid point code and cannot be entered into the database.

ITU international point codes support the Spare Point Code subtype prefix (**s-**). The prefix can be specified before the point code subfield values to indicate a Spare Point Code (**s-5-222-1**, for example). See "Spare and Private Point Code Subtype Prefixes".

## ITU National Point Codes

The ITU national point code is a 14-bit integer. The point codes can be a single number up to five digits, or two, three, or four numbers (members) separated by dashes.

If the ITU National Duplicate Point Code (ITUDUPPC) feature is on, ITU national point codes can have group codes assigned to them. The point code is a 1- to 5-digit number. The group code is a two-character field ranging from **aa** to **zz** that is entered as the last subfield of the point code and is separated by a dash from the rest of the point code. An example is **12345-az**.

If the flexible point codes option is enabled (see the **chg-stpopts** command, **:npcfmtl parameter**), an ITU national point code format consists of 2, 3, or 4 numbers separated by dashes (formatted as *m1-m2-m3-m4*). When the ITUDUPPC feature is also on, the format is *m1-m2-m3-m4-gc* with a group code. If one of the *m1*, *m2*, *m3*, *m4* members is set to zero bits, no value is entered for that position in the point code. For example, if the **npcfmtl** parameter value is set to **3-8-3-0**, valid point codes would be **1-100-1-aa** with a group code, or **7-255-7** with no group code. See the tables in the **chg-stpopts** command description for valid member values and additional examples.

The following ranges of values are valid:

*nnnnn*—**0-16383**

*nnnnn-gc*—**0-16363**; group code is *aa-zz* (the ITUDUPPC feature must be on)

*m1-m2-m3-m4*—Each member represents the number of bits allowed in the corresponding position for a flexible ITU national point code. The range of each member is from **0** to **14**. Each member must be specified; the member value of **0** indicates that the position is not specified in the flexible point code. The sum of the member values must equal 14.

*m1-m2-m3-m4-gc*—Each member represents the number of bits allowed in the corresponding position for a flexible ITU national point code. The range of each member is from **0** to **14**. Each member must be specified; the member value of **0** indicates that the position is not specified in the flexible point code. The sum of the member values must equal 14. Group code is *aa-zz* (the ITUDUPPC feature must be on).

An asterisk value (\*) is allowed only for for the **rtrv-dstn** and **rtrv-rte** commands to retrieve ITU-N DPCs if the ITUDUPPC feature is on (for point codes with group codes). The node and group code cannot both be \*. For example, **dpcn=12345-\*** and **dpcn=\*aa** are allowed, but **dpcn=\*-\*** is not allowed.

If flexible point codes are also used, all valid *m1*, *m2*, *m3*, and *m4* must all be either a number or an \*. For example, **1-100-1-aa** and **\*-\*-\*aa** are allowed, but **1-\*-\*aa** is not allowed.

ITU national point codes support the Spare Point Code subtype prefix (**s-**). The prefix can be specified before the point code subfield values to indicate a Spare Point Code (**s-12345** or **s-1-3-5-5-gc**, for example). See "Spare and Private Point Code Subtype Prefixes".

## **Converting ITU National Point Code Formats**

### **Introduction**

Gateway screening only allows ITU national point codes to be provisioned in the database by the enter, delete, or change gateway screening commands, and displayed by the gateway screening retrieve commands as a single number. If a format other than a single number (**14-0-0-0**) for the ITU national point code has been defined by the **npcfmti** parameter of the **chg-stpopts** command, the ITU national point code must be converted into a single number so that it can be used by gateway screening.

For example, the format of the ITU national point code is **4-4-4-2** and you would like to add point code **7-7-7-1** into the allowed OPC screen. The point code **7-7-7-1** would have to be converted to a single number so that the point code can be added to the allowed OPC screen. To determine what multiple-part ITU national point code is represented by the single number ITU national point code in the gateway screening table, the single number point code must be converted to a multiple-part point code.

To convert a single number ITU national point code to a multiple-part point code, go to "Converting Single Number ITU National Point Codes".

To convert a multiple-part ITU national point code to a single number point code, go to "Converting Multiple-Part ITU National Point Codes".

For a definition of the different formats that can be used for ITU national point codes, see "ITU National Point Codes".

### **Converting Single Number ITU National Point Codes**

To make this conversion, you will need to know the format of the ITU national point code. This can be verified in the NPCFMTI field of the **rtrv-stpopts** command output. For this example, the ITU national point codes **14781** and **695** are converted to point codes using the **3-8-3-0** format.

Convert a single number ITU national point code to a multiple-part ITU national point code as follows.

#### **Procedure - Converting a Single Number ITU national point code to a multiple-part ITU national point code**

- 1** Convert the point code to a binary number. This can be done with most scientific calculators.

The number **14781** converts to the binary number 11100110111101.

The number **695** converts to the binary number 1010110111.

**NOTE: Make sure the binary number contains 14 digits. If it does not, add leading zeros to the binary number to bring the total number of digits in the number to 14.**

In this example, the binary equivalent for the decimal number 695 (1010110111) contains 10 digits; four zeros must be added to the beginning of the binary number. The resulting binary number is now 00001010110111.

- 
- 2** Divide the binary number into the number of parts required by the format of the ITU national point code. For this example, the format is **3-8-3-0**. Because the last part of the point code format is **0**, the point code format contains only three parts. Divide the point code into three parts, the first part of the point code contains the first three digits of the 14-digit binary number, the second part of the point code contains the next eight digits of the 14-digit binary number, and the third part of the point code contains the last three digits of the 14-digit binary number. For this example, the binary numbers would be divided like this:

11100110111101 = 111 00110111 101

00001010110111 = 000 01010110 111

- 
- 3** Convert each part of the point code into a decimal number using the same scientific calculator used in step 1 and separate each part of the point code with dashes. The results are as follows.
- 111 00110111 101 = **7-55-5**
- 000 01010110 111 = **0-86-7**

---

When the ITU national point codes are converted from single numbers to multiple-part point codes, the resulting value of the multiple-part point code depends on the point code format specified by the **npcfmti** parameter of the **chg-stpopts** command. When converting the single number point code **14781** to the point code format **3-8-3-0**, the resulting point code value is **7-55-5**. If point code **14781** is converted to the point code format **4-4-4-2**, the resulting point code value is **14-6-15-1**.

### Converting Multiple-Part ITU National Point Codes

To make this conversion, you will need to know the format of the ITU national point code. This can be verified in the **npcfmti** field of the **rtrv-stpopts** command output. For this example, the ITU national point codes **7-55-5** and **0-86-7**, using the **3-8-3-0** point code format, are converted into a single number.

Convert multiple-part ITU national point codes to a single number as follows.

#### **Procedure - Converting Multiple-Part ITU National Point Codes to a Single Number**

---

- 1** Convert each part of the point code into a binary number using a scientific calculator. The results are as follows.
- 7-55-5** = 111 00110111 101
- 0-86-7** = 000 01010110 111
- 
- 2** Combine each part of the point code into a single binary number as follows.

111 00110111 101 = 11100110111101  
 000 01010110 111 = 00001010110111

**NOTE: If the binary number has any zeros at the beginning of the number, remove these zeros as they are not necessary.**

In this example, the binary equivalent for the point code **0-86-7** (00001010110111) contains four zeros at the beginning of the binary number. When the leading zeros are removed from the binary number, the resulting binary number is now 1010110111.

- 
- 3** Convert the binary number to a decimal number using the same scientific calculator used in step 1.  
 The binary number 11100110111101 converts to the decimal number **14781**.  
 The binary number 1010110111 converts to the decimal number **695**.
- 

## 24-bit ITU-National Point Codes

The 24-bit ITU national point codes are made up of three groups of digits called *main signaling area*, *sub signaling area*, and *signaling point*. The valid values for 24-bit ITU national point codes are:

*main signaling area* —**000-255**  
*sub signaling area* —**000-255**  
*signaling point*—**000-255**

24-bit ITU national point codes support the Private (Internal) Point Code subtype prefix (**p-**). The prefix can be specified before the point code field values to indicate a Private Point Code (**p-2055-222-2011**, for example). See "Spare and Private Point Code Subtype Prefixes".

## Spare and Private Point Code Subtype Prefixes

The Spare Point Code Support feature and the Internal Point Code Support feature provide optional point code subtype prefixes. The Spare Point Code feature must be enabled before a point code subtype prefix can be specified for a point code.

**NOTE: The SEAS interface does not support point code subtype prefixes.**

The values **p-**, **s-**, and **ps-** are valid point code subtype prefixes. The dash "-" separates the point code subtype prefix from the remainder of the point code. The prefixes are displayed in lower case. The syntax for the remainder of the point code remains the same.

The Spare Point Code prefix (**s-**) applies only to ITU-I and ITU-N point code domains (ITU-N24 point codes do not support the Spare Point Code prefix), to allow the EAGLE 5 ISS to fully support ITU National and International Spare Point Codes. Table A-2 lists the commands that support the Spare Point Code subtype prefix.

The Private (Internal) Point Code prefix (**p-**) applies to all point code domain types (including ITU-N24 point codes), to allow messages destined to the End Office Node to be routed from the inbound LIM to the outbound IPGWx. Table A-3 lists the commands that support the Private Point Code subtype prefix.

The subtype prefix **ps-** can be specified when the point code parameter supports both the spare and private point code prefixes.

**Table A-2.** Commands that support the Spare Point Code Prefix

| <b>Command</b>     | <b>Description</b>                                              | <b>Applicable Point Code Parameters</b>                                                                                                           |
|--------------------|-----------------------------------------------------------------|---------------------------------------------------------------------------------------------------------------------------------------------------|
| <b>alm</b>         | Alarm                                                           | <b>dpci</b> and <b>dpcn</b>                                                                                                                       |
| <b>appl-rtkey</b>  | Application Route Key                                           | <b>dpci</b> and <b>dpcn</b> ; <b>opci</b> and <b>open</b>                                                                                         |
| <b>cspc</b>        | Concerned Signaling Point Code                                  | <b>pci</b> and <b>pcn</b>                                                                                                                         |
| <b>dstn</b>        | Destination                                                     | <b>spci</b> and <b>spcn</b> ; <b>dpci</b> and <b>dpcn</b> ; and to Alias combinations, as shown in Figure 1.                                      |
| <b>ent-trace</b>   | Enter Trace                                                     | <b>dpci</b> and <b>dpcn</b> ; <b>opci</b> and <b>open</b>                                                                                         |
| <b>gsmmap-scrn</b> | GSM MAP Screening                                               | <b>npci</b> and <b>npcn</b>                                                                                                                       |
| <b>gsmopts</b>     | GSM Options                                                     | <b>ppmspci1</b> , <b>ppmspci2</b> ,<br><b>ppmspcn1</b> , <b>ppmspcn2</b>                                                                          |
| <b>gsms-opcode</b> | GSM Short Message Services OP-Code                              | <b>pci</b> and <b>pcn</b>                                                                                                                         |
| <b>gtt/gta</b>     | Global Title Translation/Global Title Address                   | <b>pci</b> and <b>pcn</b>                                                                                                                         |
| <b>ls</b>          | Linkset                                                         | <b>apci</b> and <b>apcn</b>                                                                                                                       |
| <b>map</b>         | Mated Application                                               | <b>pci</b> and <b>pcn</b> ; <b>mpci</b> and <b>mpcn</b>                                                                                           |
| <b>mrn</b>         | Mated Relay Node                                                | <b>pci</b> and <b>pcn</b> ; <b>pci1</b> and <b>pcn1</b> ; <b>pci2</b> and <b>pcn2</b> ; <b>pci3</b> and <b>pcn3</b> ; <b>pci4</b> and <b>pcn4</b> |
| <b>na</b>          | Network Appearance                                              | <b>type=ituis</b> , <b>type=ituns</b>                                                                                                             |
| <b>pass</b>        | Pass Commands                                                   | Syntax for routing keys                                                                                                                           |
| <b>rmt-appl</b>    | Remote Application                                              | <b>ipci</b> and <b>ipcn</b>                                                                                                                       |
| <b>rte</b>         | Route                                                           | <b>dpci</b> and <b>dpcn</b>                                                                                                                       |
| <b>scr-aftpc</b>   | Gateway Screening Allowed Affected Point Code                   | <b>pcst</b> and <b>pctype</b>                                                                                                                     |
| <b>scr-blkdpc</b>  | Gateway Screening Blocked Destination Point Code                | <b>pcst</b> and <b>pctype</b>                                                                                                                     |
| <b>scr-blkopc</b>  | Gateway Screening Blocked Origination Point Code                | <b>pcst</b> and <b>pctype</b>                                                                                                                     |
| <b>scr-cdpa</b>    | Gateway Screening Called Party (CDPA PC Destination) Point Code | <b>pcst</b> and <b>pctype</b>                                                                                                                     |
| <b>scr-cgpa</b>    | Gateway Screening Calling Party (Origination) Point Code        | <b>pcst</b> and <b>pctype</b>                                                                                                                     |

**Table A-2.** Commands that support the Spare Point Code Prefix

| <b>Command</b>     | <b>Description</b>                                            | <b>Applicable Point Code Parameters</b>                                                        |
|--------------------|---------------------------------------------------------------|------------------------------------------------------------------------------------------------|
| <b>scr-destfld</b> | Gateway Screening Affected Destination (Concerned) Point Code | <b>pcst</b> and <b>pctype</b>                                                                  |
| <b>scr-dpc</b>     | Gateway Screening Destination Point Code                      | <b>pcst</b> and <b>pctype</b>                                                                  |
| <b>scr-opc</b>     | Gateway Screening Origination Point Code                      | <b>pcst</b> and <b>pctype</b>                                                                  |
| <b>sid</b>         | Site ID                                                       | True <b>pci</b> and <b>pcn</b> ; <b>cpci</b> and <b>cpcn</b> ; <b>ncpci</b> and <b>ncpcn</b> . |
| <b>spc</b>         | Secondary Point Code                                          | <b>spci</b> and <b>spcn</b>                                                                    |

**Table A-3.** Commands that support the Private Point Code Prefix

| <b>Command</b>           | <b>Description</b>        | <b>Applicable Point Code Parameters</b>                                                                             |
|--------------------------|---------------------------|---------------------------------------------------------------------------------------------------------------------|
| <b>dstn</b>              | Destination               | <b>spci</b> and <b>spcn</b> ; <b>dpc</b> , <b>dpca</b> , <b>dpci</b> , and <b>dpcn</b><br>Does not apply to Aliases |
| <b>ls</b>                | Linkset                   | If <b>ipgwapc= yes</b> , <b>apc</b> , <b>apcn</b> , <b>apci</b> , and <b>apcn</b>                                   |
| <b>gtt/gta</b>           | Global Title Translation  | <b>pc</b> , <b>pca</b> , <b>pci</b> , and <b>pcn</b>                                                                |
| <b>inh/unhb-alm</b>      | Destination alarm inhibit | <b>dpc</b> , <b>dpca</b> , <b>dpci</b> , and <b>dpcn</b>                                                            |
| <b>rept-stat-cluster</b> | Report Cluster Status     | <b>dpc</b> and <b>dpca</b>                                                                                          |
| <b>rept-stat-dstn</b>    | Report Destination Status | <b>dpc</b> , <b>dpca</b> , <b>dpci</b> , and <b>dpcn</b>                                                            |
| <b>rmt-appl</b>          | Remote Application        | <b>ipc</b> , <b>ipca</b> , <b>ipci</b> , and <b>ipcn</b>                                                            |
| <b>rst-dstn</b>          | Restore Destination       | <b>dpc</b> and <b>dpca</b>                                                                                          |
| <b>rte</b>               | Route                     | <b>dpc</b> , <b>dpca</b> , <b>dpci</b> , and <b>dpcn</b>                                                            |

**Valid CIC Ranges for SI and MSU Types in Routing Key Static Entries**

Table A-4 lists the valid CIC ranges for use with SI and MSU types in Routing Key table static entries.

**Table A-4.** Valid CIC Ranges for SI and MSU Types

| SI         | MSU for ANSI DPC                          | MSU for ITU DPC                     | Comments                                       |
|------------|-------------------------------------------|-------------------------------------|------------------------------------------------|
| 4 (TUP)    | N/A                                       | CIC is 12 bits.<br>Range is 0-4095. | The TUP protocol is used only in ITU networks. |
| 5 (ISUP)   | CIC is 14 bits.<br>Range is 0-16383.      | CIC is 12 bits.<br>Range is 0-4095. |                                                |
| 13 (QBICC) | CIC is 32 bits.<br>Range is 0-4294967295. |                                     |                                                |

**NAIV/NAI Mapping**

Table A-5 shows the mapping between the **naiv** and the **nai** parameters.

**Table A-5.** NAIV/NAI Mapping

| NAIV  | NAI  | Description                 |
|-------|------|-----------------------------|
| 0     | –    | Unknown                     |
| 1     | Sub  | Subscriber Number           |
| 2     | Rsvd | Reserved for national use   |
| 3     | Natl | National significant number |
| 4     | Intl | International number        |
| 5–127 | –    | Spare                       |

## NPV/NP Mapping

Table A-6 shows the mapping between the **npv** and the **np** parameters.

**Table A-6.** NPV/NP Mapping

| <b>NPV</b> | <b>NP</b> | <b>Description</b>                                 |
|------------|-----------|----------------------------------------------------|
| 0          | –         | Unknown                                            |
| 1          | E164      | ISDN/telephony numbering plan                      |
| 2          | Generic   | Generic numbering plan                             |
| 3          | X121      | Data numbering plan                                |
| 4          | F69       | Telex numbering plan                               |
| 5          | E210      | Maritime mobile numbering plan                     |
| 6          | E212      | Land mobile numbering plan                         |
| 7          | E214      | ISDN/mobile numbering plan                         |
| 8          | Private   | Private network or network-specific numbering plan |
| 9–15       | –         | Spare                                              |



## Cards that use the ent-card Command

Table A-7 contains information about cards that use the **ent-card** command for provisioning.

**Table A-7.** Valid **ent-card** Applications (**appl**) and Card Types (**type**)

| Card Name<br>(as shown on<br>card label) | Part Number                                                                                                                                                                           | Card Type<br>(:type)     | Application<br>Type (:appl)                                                                       | Maximum Cards in<br>the Database                                                                                                                                                           |
|------------------------------------------|---------------------------------------------------------------------------------------------------------------------------------------------------------------------------------------|--------------------------|---------------------------------------------------------------------------------------------------|--------------------------------------------------------------------------------------------------------------------------------------------------------------------------------------------|
| DCM                                      | 870-1945-01<br>870-1945-02<br>870-1945-03<br>870-1984-01                                                                                                                              | <b>dcm</b><br><b>stc</b> | <b>stplan</b><br><b>eroute</b>                                                                    | 32 for <b>stplan</b><br>32 for <b>eroute</b><br>(minimum of 17 for 500<br>links)                                                                                                           |
| EDCM<br>(SSEDCM)                         | 870-2372-01<br>870-2372-08 /<br>870-2372-13 (R)                                                                                                                                       | <b>dcm</b><br><b>stc</b> | <b>stplan</b><br><b>iplim</b><br><b>iplimi</b><br><b>ss7ipgw</b><br><b>ipgwi</b><br><b>eroute</b> | 32 for <b>stplan</b><br>100 for <b>iplim</b> or <b>iplimi</b><br>Total of 64 <b>ss7ipgw</b> ,<br><b>ipgwi</b> , or combination<br>32 for <b>eroute</b><br>(minimum of 14 for 500<br>links) |
| EDCM-A<br>(SSEDCM)                       | 870-2508-01 /<br>870-2508-02 (R)                                                                                                                                                      | <b>dcm</b><br><b>stc</b> | <b>stplan</b><br><b>eroute</b>                                                                    | 32 for <b>stplan</b><br>32 for <b>eroute</b><br>(minimum of 14 for 500<br>links)                                                                                                           |
| DSM***                                   | 870-1984-02<br>870-1984-03<br>870-1984-05<br>870-1984-06<br>870-1984-08<br>870-1984-07 /<br>870-1984-13 (R)<br>870-1984-16 (R)<br>870-1984-09 /<br>870-1984-15 (R)<br>870-1984-17 (R) | <b>dsm</b>               | <b>vsccp</b><br><b>gls</b>                                                                        | 25 for <b>vsccp</b><br>32 for 50,000 GTT (no<br>MPS-based features<br>on)<br>8 for <b>gls</b>                                                                                              |
| DSM-1G                                   | 870-2371-02<br>870-2371-06<br>870-2371-08 /<br>870-2371-13 (R)                                                                                                                        | <b>ipsm</b>              | <b>ips</b>                                                                                        | 3                                                                                                                                                                                          |

Table A-7. Valid ent-card Applications (**appl**) and Card Types (**type**)

| Card Name<br>(as shown on<br>card label) | Part Number                                                                       | Card Type<br>(:type)                         | Application<br>Type (:appl)                                                                                      | Maximum Cards in<br>the Database                                                                                                 |
|------------------------------------------|-----------------------------------------------------------------------------------|----------------------------------------------|------------------------------------------------------------------------------------------------------------------|----------------------------------------------------------------------------------------------------------------------------------|
| EDSM-2G*                                 | 870-2372-03<br>870-2372-07<br>870-2372-09 /<br>870-2372-14 (R)<br>870-2372-15 (R) | <b>mcpm</b>                                  | <b>mcp</b>                                                                                                       | 250                                                                                                                              |
| E1/T1 MIM††                              | 870-2198-01<br>870-2198-02<br>870-2198-03<br>870-2198-04 /<br>870-2198-07 (R)     | <b>lime1</b><br><b>limt1</b><br><b>limch</b> | <b>ss7ansi</b><br><b>ccs7itu</b>                                                                                 | 250 for each<br>application                                                                                                      |
| E1-ATM                                   | 870-2455-01<br>870-2455-02<br>870-2455-03 /<br>870-2455-05 (R)                    | <b>lime1atm</b>                              | <b>atmitu</b>                                                                                                    | 115                                                                                                                              |
| E5-ATM                                   | 870-1872-01 (R)<br>870-1872-02 (R)                                                | <b>limatm</b><br><b>lime1atm</b>             | <b>atmansi</b><br><b>atmitu</b>                                                                                  | 180 if only one link is<br>provisioned per card. A<br>maximum of 180 links<br>for either application<br>can exist in the system. |
| E5-E1T1††                                | 870-1873-02<br>870-1873-03 (R)<br>870-1873-04 (R)                                 | <b>lime1</b><br><b>limt1</b>                 | <b>ss7ansi</b><br><b>ccs7itu</b>                                                                                 | 250 for each<br>application                                                                                                      |
| E5-ENET                                  | 870-2212-02<br>870-2212-03 (R)<br>870-2212-04 (R)<br>870-2212-05 (R)              | <b>dcm</b><br><b>enet</b><br><b>stc</b>      | <b>ss7ipgw</b><br><b>ipgwi</b><br><b>iplim</b><br><b>iplimi</b><br><b>stplan</b><br><b>eroute</b><br><b>ipsg</b> | 64 for IPGWx<br>100 for IPLIMx<br>100 for <b>ipsg</b><br>32 for <b>stplan</b><br>32 for <b>eroute</b>                            |
| E5-IPSM                                  | 870-2877-01 (R)<br>870-2877-02 (R)                                                | <b>ipsm</b>                                  | <b>ips</b>                                                                                                       | 3                                                                                                                                |

Table A-7. Valid ent-card Applications (appl) and Card Types (type)

| Card Name<br>(as shown on<br>card label) | Part Number                                                                                                 | Card Type<br>(:type)         | Application<br>Type (:appl)      | Maximum Cards in<br>the Database                                                                                                                       |
|------------------------------------------|-------------------------------------------------------------------------------------------------------------|------------------------------|----------------------------------|--------------------------------------------------------------------------------------------------------------------------------------------------------|
| E5-SM4G                                  | 870-2860-01 (R)<br>870-2860-02 (R)                                                                          | <b>dsm</b>                   | <b>vsccp</b>                     | 32 when no MPS-based<br>features are on<br>25 when one or more<br>MPS-based features are<br>on<br>9 when an LNP<br>quantity greater than<br>228M is on |
| E5-TSM                                   | 870-2943-03 (R)                                                                                             | <b>tsm</b>                   | <b>gls</b>                       | 8                                                                                                                                                      |
| HC-MIM††                                 | 870-2671-01<br>870-2671-02<br>870-2671-03 (R)                                                               | <b>lime1</b><br><b>limt1</b> | <b>ss7ansi</b><br><b>ccs7itu</b> | 125 for each<br>application                                                                                                                            |
| LIM-ATM                                  | 870-1293-02<br>870-1293-03<br>870-1293-06<br>870-1293-07<br>870-1293-08<br>870-1293-10 /<br>870-1293-13 (R) | <b>limatm</b>                | <b>atmansi</b>                   | 115                                                                                                                                                    |
| MPL                                      | 870-2061-01<br>870-2061-03<br>870-2061-04 /<br>870-2061-06 (R)                                              | <b>limds0</b>                | <b>ss7ansi</b>                   | 250 for <b>ss7ansi</b>                                                                                                                                 |
| TSM-256†                                 | 870-1289-02<br>870-1289-03<br>870-1289-04 /<br>870-1289-06 (R)<br>870-1289-07 (R)                           | <b>tsm</b>                   | <b>gls</b>                       | 8                                                                                                                                                      |
| TSM-512                                  | 870-1290-02<br>870-1290-03<br>870-1290-04                                                                   | <b>tsm</b>                   | <b>gls</b>                       | 8                                                                                                                                                      |
| TSM-768                                  | 870-1291-02<br>870-1291-03<br>870-1291-04                                                                   | <b>tsm</b>                   | <b>gls</b>                       | 8                                                                                                                                                      |

Table A-7. Valid ent-card Applications (**appl**) and Card Types (**type**)

| Card Name<br>(as shown on<br>card label)                                                                                                                                                                                                                                                                                                                                                                                                                                                                                                                                                                                                                                                                                                                                                                                                                                               | Part Number                               | Card Type<br>(:type) | Application<br>Type (:appl) | Maximum Cards in<br>the Database |
|----------------------------------------------------------------------------------------------------------------------------------------------------------------------------------------------------------------------------------------------------------------------------------------------------------------------------------------------------------------------------------------------------------------------------------------------------------------------------------------------------------------------------------------------------------------------------------------------------------------------------------------------------------------------------------------------------------------------------------------------------------------------------------------------------------------------------------------------------------------------------------------|-------------------------------------------|----------------------|-----------------------------|----------------------------------|
| TSM-1024                                                                                                                                                                                                                                                                                                                                                                                                                                                                                                                                                                                                                                                                                                                                                                                                                                                                               | 870-1292-02<br>870-1292-03<br>870-1292-04 | tsm                  | gls                         | 8                                |
| <p>* Though the system allows 250 MCPM cards, practical usage is 2.</p> <p>*** If any MPS-based features are running in the system, up to 25 DSMs are allowed in the system. If only GTT is running, up to 32 DSMs can be used in the system with the 50,000 GTT feature.</p> <p>† DSM cards or E5-SM4G cards are required for the LNP feature. For more information about turning the LNP feature on, refer to the <i>LNP Feature Activation Guide</i> .</p> <p>† † For the E1 or T1 interface, either SS7 application (SS7ANSI or CCS7ITU) can be assigned to these cards. For more information on the E1 or T1 interface go to Appendix A "E1 Interface" or Appendix B "T1 Interface" in the <i>Database Administration Manual - SS7</i>.</p> <p>Part numbers followed by (R) are ROHS numbers. These numbers are equivalent to the non-ROHS numbers that they are paired with.</p> |                                           |                      |                             |                                  |

## Summary of Loopback Testing Commands and Functions

Table A-8 and Figure A-1 summarize the loopback testing commands and functions in the system.

The **tst-slk** command provides several methods for testing signaling links. The **loopback** parameter on the **tst-slk** command provides the ability to select **lxvr** (local transceiver), **oam**, **line**, **payload**, and **sltc** loopback tests. The **tst-slk** command will be rejected if a loopback test is not compatible with the link type.

- For low-speed links, the **lxvr** and **sltc** tests are allowed.
- For high-speed links (ATM and E5-ATM), the **lxvr**, **oam**, **line**, **payload**, and **sltc** tests are allowed.
- For SS7IPGW and IPGWI DCMs, the **tst-slk** command is not supported.
- For IPLIMx DCMs, only the **loopback=sltc** test is allowed, and is allowed only for links having IPLIML2 type of M2PA.
- For LIME1, LIMT1, or LIMCH cards, or for the E5-ENET card running the IPSP application, only the **loopback=sltc** test is allowed.
- The E5-E1T1 and HC-MIM cards can function as either an E1 MIM card or a T1 MIM card, depending on how the card is provisioned. **loopback=sltc** test is allowed.

The **act-lbp** command activates test on one or more loopback points for testing data signaling link elements in one CCS7 transmission path. The maximum number of loopback points is 32.

For a single loopback point test, the parameters can be entered on the command line. If the parameters are not entered at the command line, the LFS database is used. For multiple loopback point tests, the LFS database must be used.

The **ent-lbp** command is used to create the loopback points in the LFS database. The LBPs may be entered in any order.

See the command descriptions in this manual for details on entering parameters and using the commands.

**Table A-8.** Loopback Testing Commands and Functions

| Command/Function                                                                                                                                                                                                                                                                                                                                                                                                                                                                    | Card Supported                                                                                                                                                                  | Testing limits                               |
|-------------------------------------------------------------------------------------------------------------------------------------------------------------------------------------------------------------------------------------------------------------------------------------------------------------------------------------------------------------------------------------------------------------------------------------------------------------------------------------|---------------------------------------------------------------------------------------------------------------------------------------------------------------------------------|----------------------------------------------|
| <p><b>act/dact-cdl</b> <i>NETWORK payload low-level loopback test.</i><br/>           Link State—Down<br/>           Equipment tested—All links on the T1 port<br/>           Purpose—tests connectivity between 2 nodes at the T1 level with some isolation for the LIU and/or framer<br/>           Description—Tests near-end card for line, lxr, and network payload loopback and far-end card for line and payload loopback.<br/>           Typical use—Tests connectivity</p> | <ul style="list-style-type: none"> <li>• HC-MIM</li> <li>• E5-E1T1</li> <li>• E1-ATM</li> <li>• LIM-ATM</li> <li>• E5-ATM</li> <li>• E1/T1 MIM</li> </ul>                       | 1024 concurrent tests per system             |
| <p><b>ent-lbp</b> <i>OAM Database for Multiple LFS points per LFS tests</i><br/>           No impact on link behavior other than allowing multiple points</p>                                                                                                                                                                                                                                                                                                                       | <ul style="list-style-type: none"> <li>• E1/T1 MIM (T1 Mode)</li> <li>• HC-MIM (T1 mode) (channelized)</li> <li>• E5-E1T1 (T1 mode) (channelized)</li> <li>• DS0 MPL</li> </ul> | 32 points per card<br>no limit on # of cards |
| <p><b>act/dact-lbp</b><br/> <i>EAGLE initiated Level 1 DS0 LFS tests</i><br/>           Link State—Down<br/>           Equipment tested—Level 1 element(s) in a signaling path<br/>           Purpose—Test the error rates of a signaling path<br/>           Description—Sends loopback code to establish loopback, then performs BERT test for a specified period of time<br/>           Typical use—Validates signaling path has acceptable error rate</p>                       | <ul style="list-style-type: none"> <li>• E1/T1 MIM (T1 mode)</li> <li>• HC-MIM (T1 mode) (channelized)</li> <li>• E5-E1T1 (T1 mode) (channelized)</li> <li>• DS0 MPL</li> </ul> | 1024 concurrent tests per system             |

Table A-8. Loopback Testing Commands and Functions

| Command/Function                                                                                                                                                                                                                                                                                                                                                                                                                                                                                                                                                                            | Card Supported                                                                                                                                                                                                           | Testing limits                        |
|---------------------------------------------------------------------------------------------------------------------------------------------------------------------------------------------------------------------------------------------------------------------------------------------------------------------------------------------------------------------------------------------------------------------------------------------------------------------------------------------------------------------------------------------------------------------------------------------|--------------------------------------------------------------------------------------------------------------------------------------------------------------------------------------------------------------------------|---------------------------------------|
| <p><b>Remote Loopback</b> <i>FAR END initiated DS0 LFS Test</i><br/>                     Link State—Up or down<br/>                     Equipment tested—Near end hardware up to level 2 and far end hardware level 1 interface<br/>                     Purpose—Auto—Loopback a BERT test to the far end<br/>                     Description—When receiving a loopback code, deactivate the link and go into loopback<br/>                     Typical use—Remotely tests the far end with standard DS0 BERT tests</p>                                                                    | <ul style="list-style-type: none"> <li>• E1/T1 MIM</li> <li>• HC-MIM (T1 mode) (channelized)</li> <li>• DS0 MPL</li> <li>• E5-E1T1 (channelized)</li> </ul>                                                              | no limit on # of cards                |
| <p><b>tst-slk</b> <i>SLTC EAGLE initiated Level 3 SS7 SLT</i><br/>                     Link State—Up<br/>                     Equipment tested—Near and far end up to Level 3<br/>                     Purpose—Test the entire path to the far end at Level 3<br/>                     Description—Sends an SLTM out and expects an SLTA back<br/>                     Typical use—Validates connectivity of a signaling path</p>                                                                                                                                                           | <ul style="list-style-type: none"> <li>• E1/T1 MIM</li> <li>• HC-MIM</li> <li>• E5-E1T1</li> <li>• DS0 MPL</li> <li>• E1-ATM</li> <li>• LIM-ATM</li> <li>• IPLIM (not M3UA)</li> <li>• IPGW</li> <li>• E5-ATM</li> </ul> | 1024 concurrent link tests per system |
| <p><b>tst-slk</b> <i>OAM EAGLE initiated Level 1 ATM test</i><br/>                     Link State—Down<br/>                     Equipment tested—Near and far end level 1 software and hardware including all hardware on the cards<br/>                     Purpose—Test the entire near and far end level 1 hardware by exchanging ATM cells<br/>                     Description—Sends OAM cells out to far end for 60 seconds if no errors, or 2 minutes if errors are received<br/>                     Typical use—Verifies ATM cells can be exchanged between 2 signaling points</p> | <ul style="list-style-type: none"> <li>• E1-ATM</li> <li>• T1-ATM</li> <li>• E5-ATM</li> </ul>                                                                                                                           | 1024 concurrent link tests per system |

Table A-8. Loopback Testing Commands and Functions

| Command/Function                                                                                                                                                                                                                                                                                                                                                                                                                                                                                                                                                                                                                                                                                                                                                                                                                                                                                                                                                                                                                                   | Card Supported                                                                          | Testing limits                               |
|----------------------------------------------------------------------------------------------------------------------------------------------------------------------------------------------------------------------------------------------------------------------------------------------------------------------------------------------------------------------------------------------------------------------------------------------------------------------------------------------------------------------------------------------------------------------------------------------------------------------------------------------------------------------------------------------------------------------------------------------------------------------------------------------------------------------------------------------------------------------------------------------------------------------------------------------------------------------------------------------------------------------------------------------------|-----------------------------------------------------------------------------------------|----------------------------------------------|
| <p><b>tst-slk</b> LINE <i>EAGLE initiated Level 1-2 ATM test</i><br/>Link State—Down<br/>Equipment tested—Near end hardware up to level 2 and far end hardware level 1 interface<br/>Purpose—Hardware continuity check between near and far end<br/>Description—The following steps occur:</p> <ol style="list-style-type: none"> <li>1. Device under test (DUT) sends T1 Payload bit-oriented code (BOC) to remote device</li> <li>2. Remote device receives BOC and programs hardware</li> <li>3. DUT attempts level 2 alignment</li> <li>4. If link aligns (level 2), test passes, else test fails</li> <li>5. DUT sends BOC to remote device to remove loopback</li> <li>6. Remote device receives BOC and re-programs hardware</li> </ol> <p><b>NOTE:</b> If the DUT boots in the middle of sequence, activate or de-activate the link, and the remote device returns to the original programming.<br/>Typical use—Checks continuity from the near end level 2 hardware to the level 1 interface at the far end for a link in line timing</p> | <p>LIM-ATM<br/>E5-ATM (T1 mode)</p>                                                     | <p>1024 concurrent link tests per system</p> |
| <p><b>tst-slk</b> PAYLOAD <i>EAGLE initiated Level 1-2 ATM test</i><br/>Link State-Down<br/>Equipment tested—Near end hardware up to level 2 and far end hardware level 1 interface<br/>Purpose—Hardware continuity check between near and far end<br/>Description—The following steps occur:</p> <ol style="list-style-type: none"> <li>1. Device under test (DUT) sends T1 Payload bit oriented code (BOC) to remote device</li> <li>2. Remote device receives BOC and programs hardware</li> <li>3. DUT attempts level 2 alignment</li> </ol>                                                                                                                                                                                                                                                                                                                                                                                                                                                                                                   | <ul style="list-style-type: none"> <li>• LIM-ATM</li> <li>• E5-ATM (T1 mode)</li> </ul> | <p>1024 concurrent link tests per system</p> |

Table A-8. Loopback Testing Commands and Functions

| Command/Function                                                                                                                                                                                                                                                                                                                                                                                                                                                                                    | Card Supported                                                                                  | Testing limits                               |
|-----------------------------------------------------------------------------------------------------------------------------------------------------------------------------------------------------------------------------------------------------------------------------------------------------------------------------------------------------------------------------------------------------------------------------------------------------------------------------------------------------|-------------------------------------------------------------------------------------------------|----------------------------------------------|
| <p>4. If link aligns (level 2), test passes, else test fails</p> <p>5. DUT sends BOC to remote device to remove loopback</p> <p>6. Remote device receives BOC and re-programs hardware</p> <p><b>NOTE:</b> If the DUT boots in the middle of sequence, activate or de-activate the link, and the remote device returns to the original programming.</p> <p>Typical use—Checks continuity from the near end level 2 hardware to the level 1 interface at the far end for a link in master timing</p> |                                                                                                 |                                              |
| <p><b>tst-slk</b> LXVR (DS1 loop) <i>EAGLE initiated Level 1 Internal card loopback</i></p> <p><b>NOTE:</b> A DS1 loop is not supported for MPL cards.</p> <p>Link State—Down</p> <p>Equipment tested—Local card</p> <p>Purpose—Test the near end card only</p> <p>Description—Test the near end card up through level 2.</p> <p>Typical use—Validates the card on the Eagle as good</p>                                                                                                            | <ul style="list-style-type: none"> <li>• DS0 MPL</li> <li>• E1-ATM</li> <li>• T1-ATM</li> </ul> | <p>1024 concurrent link tests per system</p> |
| <p><b>tst-e1</b> LINE, LXVR (DS1 loop), PAYLOAD <i>EAGLE Initiated E1 Port test</i></p> <p>Link State—Down</p> <p>Equipment tested—All links on the E1 port</p> <p>Purpose—Tests connectivity between 2 nodes at the E1 level with some isolation for the LIU and/or framer</p> <p>Description—Tests near-end card for line, lxvr, and payload loopback</p> <p>Typical use—Tests connectivity</p>                                                                                                   | <ul style="list-style-type: none"> <li>• E5-E1T1</li> </ul>                                     | <p>1024 concurrent</p>                       |



Table A-8. Loopback Testing Commands and Functions

| Command/Function                                                                                                                                                                                                                                                                                                                                                                                                                                                                                                                                 | Card Supported                                                                          | Testing limits                   |
|--------------------------------------------------------------------------------------------------------------------------------------------------------------------------------------------------------------------------------------------------------------------------------------------------------------------------------------------------------------------------------------------------------------------------------------------------------------------------------------------------------------------------------------------------|-----------------------------------------------------------------------------------------|----------------------------------|
|                                                                                                                                                                                                                                                                                                                                                                                                                                                                                                                                                  | <ul style="list-style-type: none"> <li>• HC-MIM</li> </ul>                              | tests per system                 |
| <p><b>tst-t1</b> LINE, LXVR (DS1 loop), PAYLOAD, FELINE, FEPAYLOAD <i>EAGLE initiated T1 port test</i></p> <p><b>NOTE:</b> FELINE and FEPAYLOAD are not supported for HC-MIM cards.</p> <p>Link State—Down</p> <p>Equipment tested—All links on the T1 port</p> <p>Purpose—Tests connectivity between 2 nodes at the T1 level with some isolation for the LIU and/or framer</p> <p>Description—Tests near-end card for line, lxvr, and payload loopback and far end card for line and payload loopback</p> <p>Typical use—Tests connectivity</p> | <ul style="list-style-type: none"> <li>• E5-E1T1 (T1 mode)</li> <li>• HC-MIM</li> </ul> | 1024 concurrent tests per system |

Figure A-1. ATM Loopback Tests

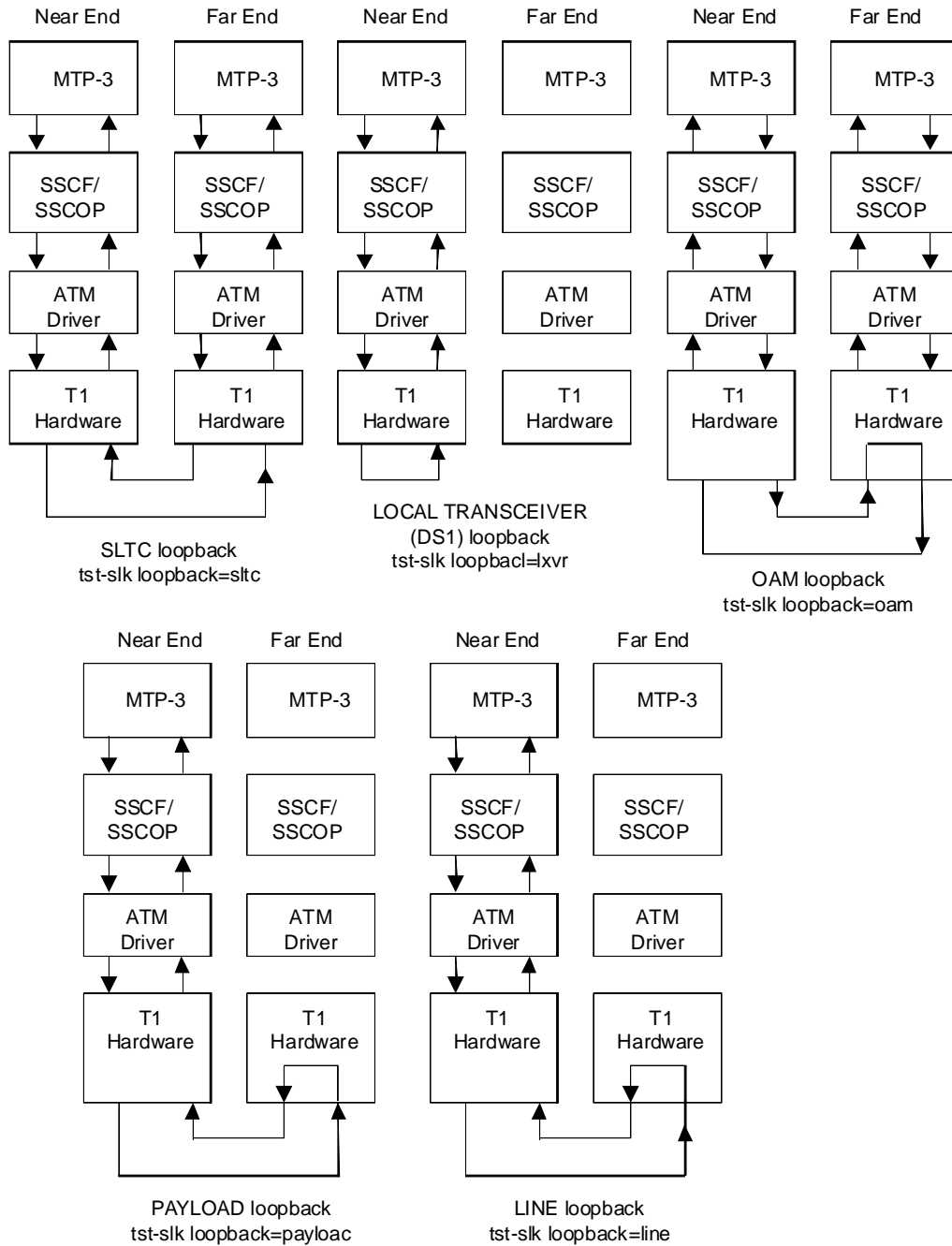

# B

## Acronyms and Abbreviations

|                |                                                                                                |
|----------------|------------------------------------------------------------------------------------------------|
| <b>A-Port</b>  | ANSI-41 Mobile Number Portability                                                              |
| <b>AINPQ</b>   | ANSI-41 INP Query                                                                              |
| <b>AAL</b>     | ATM Adaptation Layer                                                                           |
| <b>AAL5</b>    | ATM Adaptation Layer 5                                                                         |
| <b>AAL5CP</b>  | ATM Adaptation Layer 5 Common Port                                                             |
| <b>AATM</b>    | ATM Applique                                                                                   |
| <b>ACG</b>     | Automatic Call Gapping                                                                         |
| <b>ACM</b>     | Application Communications Module                                                              |
| <b>ADJ DPC</b> | Adjacent Destination Point Code                                                                |
| <b>AI</b>      | Address Indicator                                                                              |
| <b>AIN</b>     | Advanced Intelligent Network                                                                   |
| <b>AINF</b>    | Application Interface Applique                                                                 |
| <b>ANSI</b>    | American National Standards Institute                                                          |
| <b>AP</b>      | Application Processor                                                                          |
| <b>APC</b>     | Adjacent Point Code                                                                            |
| <b>ARP</b>     | Address Resolution Protocol                                                                    |
| <b>AS</b>      | Application Server; a logical entity serving a specific Routing Key                            |
| <b>ASM</b>     | Application Services Module                                                                    |
| <b>ASP</b>     | Application Server Process                                                                     |
| <b>ATI</b>     | Any Time Interrogation                                                                         |
| <b>ATM</b>     | Asynchronous Transfer Mode                                                                     |
| <b>ATMANSI</b> | The application software for the ATM (high-speed) SS7 signaling links                          |
| <b>ATM HSL</b> | Asynchronous Transfer Mode High Speed Link                                                     |
| <b>ATMM</b>    | ATM Layer Management                                                                           |
| <b>AVL</b>     | Availability Measurements report                                                               |
| <b>AVLD</b>    | Daily Availability measurements report                                                         |
| <b>AVLDTH</b>  | Day-to-Hour Availability measurements report                                                   |
| <b>BCSM</b>    | Basic Call State Model                                                                         |
| <b>BIP</b>     | Board Identification PROM                                                                      |
| <b>BITS</b>    | Building Integrated Timing System                                                              |
| <b>BLM</b>     | Bulk Load Module                                                                               |
| <b>BPHCAP</b>  | The application software used by the application processor and the IMT processor of the LIMATM |
| <b>BPDCM</b>   | The application software for flash memory management on the DCM card.                          |
| <b>BSD</b>     | Berkeley Software Distribution                                                                 |
| <b>BSN</b>     | Backward Sequence Number                                                                       |
| <b>CAS</b>     | Channel Associated Signaling                                                                   |
| <b>CCM</b>     | Command Class Management                                                                       |

## Acronyms and Abbreviations

|                |                                                                              |
|----------------|------------------------------------------------------------------------------|
| <b>CCS</b>     | Common Channel Signaling                                                     |
| <b>CCS7</b>    | Common Channel Signaling System #7                                           |
| <b>CCS7ITU</b> | The application software for the ITU SS7 signaling links                     |
| <b>CDPA</b>    | Called Party Address                                                         |
| <b>CDPN</b>    | Called Party Number                                                          |
| <b>CGPA</b>    | Calling Party Address                                                        |
| <b>CF</b>      | Control Frame                                                                |
| <b>CIC</b>     | Circuit Identification Code                                                  |
| <b>CLLI</b>    | Common Language Location Identifier                                          |
| <b>CLU</b>     | Network Cluster                                                              |
| <b>CM</b>      | Cluster Management                                                           |
| <b>CNCF</b>    | Calling Name Conversion Facility                                             |
| <b>CP</b>      | Communication Processor                                                      |
| <b>CPU</b>     | Central Processing Unit                                                      |
| <b>CRC</b>     | Cyclic Redundancy Check                                                      |
| <b>CRMD</b>    | Cluster Routing and Management Diversity                                     |
| <b>CRP</b>     | Circular Route Prevention                                                    |
| <b>CSL</b>     | Common Screening List                                                        |
| <b>CSPC</b>    | Concerned Signaling Point Code Group                                         |
| <b>CSU</b>     | Channel Service Unit                                                         |
| <b>DB</b>      | Database                                                                     |
| <b>DCM</b>     | Database Communications Module                                               |
| <b>DIP</b>     | Dual In-Line Package                                                         |
| <b>DIX</b>     | Digital/Intel/Xerox de facto standard for Ethernet Media Access Control Type |
| <b>DN</b>      | Dialed or Directory Number                                                   |
| <b>DPC</b>     | Destination Point Code                                                       |
| <b>DRAM</b>    | Dynamic Random Access Memory                                                 |
| <b>DS0</b>     | Digital Signal Level - 0                                                     |
| <b>DSM</b>     | Database Services Module                                                     |
| <b>DSU</b>     | Data Service Unit                                                            |
| <b>DTA</b>     | Database Transport Access                                                    |
| <b>E5-E1T1</b> | EPM-based E1/T1 Multi-Channel Interface Module                               |
| <b>E5-ENET</b> | EPM-based Ethernet card                                                      |
| <b>ESIS</b>    | Eagle 5 Integrated Monitoring Support                                        |
| <b>EBDA</b>    | Enhanced Bulk Download and Audit                                             |
| <b>EDR</b>     | Efficient Data Representation                                                |
| <b>EF</b>      | Extension Frame                                                              |
| <b>EGTT</b>    | Enhanced Global Title Translation                                            |
| <b>EIA</b>     | Electronic Industries Association                                            |
| <b>EILA</b>    | Enhanced Integrated LIM Applique                                             |
| <b>EIR</b>     | Equipment Identity Register                                                  |
| <b>ELAP</b>    | Eagle LNP Application Processor                                              |
| <b>EMP</b>     | Eagle Monitoring Protocol                                                    |
| <b>EMSALM</b>  | Element Management System Alarm Monitor                                      |
| <b>ENET</b>    | Ethernet                                                                     |
| <b>EOAM</b>    | Enhanced Operations, Administration, and Maintenance                         |
| <b>EOAP</b>    | Enhanced OSS Application Process                                             |
| <b>EPAP</b>    | Eagle Provisioning Application Processor                                     |
| <b>EPM</b>     | Embedded Processor Module (E5-E1T1 and E5-ENET cards are EPM-based cards)    |
| <b>EPROM</b>   | Erasable PROM                                                                |
| <b>ESP</b>     | Extended Services Platform                                                   |
| <b>FAK</b>     | Feature Access Key                                                           |
| <b>FAP</b>     | Fuse and Alarm Panel                                                         |
| <b>FAS</b>     | Frame Alignment Signal                                                       |

## Acronyms and Abbreviations

|               |                                                    |
|---------------|----------------------------------------------------|
| <b>FISU</b>   | Fill In Signal Unit                                |
| <b>FPBA</b>   | Frame Power Budget Alarm                           |
| <b>FPCR</b>   | Full Point Code Routing                            |
| <b>FPT</b>    | Frame Power Threshold                              |
| <b>FSN</b>    | Forward Sequence Number                            |
| <b>FTA</b>    | File Transfer Area                                 |
| <b>FTP</b>    | File Transfer Protocol                             |
| <b>FTRA</b>   | FTP-based Table Retrieve Application               |
| <b>GDB</b>    | GSM Real-Time Database                             |
| <b>G-Flex</b> | GSM Flexible Numbering                             |
| <b>G-Port</b> | GSM Mobile Number Portability                      |
| <b>GLS</b>    | Generic Loading Service                            |
| <b>GMSC</b>   | Gateway MSC                                        |
| <b>GPL</b>    | Generic Program Load                               |
| <b>GPSM</b>   | General Purpose Service Module                     |
| <b>GSL</b>    | Generic Software Load                              |
| <b>GSM</b>    | Global System for Mobile Communications            |
| <b>GTA</b>    | Global Title Address                               |
| <b>GTI</b>    | Global Title Indicator                             |
| <b>GTT</b>    | Global Title Translation                           |
| <b>GTWY</b>   | Gateway Administration measurements report         |
| <b>GWS</b>    | Gateway Screening                                  |
| <b>GWSA</b>   | Gateway Screening Application                      |
| <b>GWSM</b>   | Gateway Screening Messages                         |
| <b>HC-MIM</b> | High Capacity Multi-Channel Interface Module       |
| <b>HDB3</b>   | High Density Bipolar 3 encoding                    |
| <b>HIPR</b>   | High Speed IMT Packet Router                       |
| <b>HLR</b>    | Home Location Register                             |
| <b>HOMERN</b> | Home Network Routing Number Prefix                 |
| <b>HMUX</b>   | High-Speed Multiplexer                             |
| <b>HRN</b>    | Home Routing Number                                |
| <b>HSL</b>    | High-Speed Links                                   |
| <b>IAM</b>    | Initial Address Message                            |
| <b>IC</b>     | Integrated Circuit                                 |
| <b>ICMP</b>   | Internet Control Message Protocol                  |
| <b>ID</b>     | Identity                                           |
| <b>IDP</b>    | Initial Detection Point                            |
| <b>IEC</b>    | International Escape Code                          |
| <b>IETF</b>   | Internet Engineering Task Force                    |
| <b>IGM</b>    | IS41 GSM Migration                                 |
| <b>IGTTLS</b> | Intermediate Global Title Translation Load Sharing |
| <b>IL</b>     | Incremental loading                                |
| <b>ILA</b>    | Integrated LIM Applique                            |
| <b>IMEI</b>   | International Mobile Equipment Identifier          |
| <b>IMF</b>    | Integrated Message Feeder                          |
| <b>IMSI</b>   | International Mobile Station Identifier            |
| <b>IMT</b>    | Inter-processor Message Transport                  |
| <b>IN</b>     | Intelligent Network                                |
| <b>INAP</b>   | Intelligent Network Application Part               |
| <b>INET</b>   | Internet                                           |
| <b>INH</b>    | Inhibit                                            |
| <b>INP</b>    | INAP-based Number Portability                      |
| <b>INSL</b>   | In-Network Subscriber List                         |
| <b>IP</b>     | Internet Protocol                                  |

|                 |                                                                                                            |
|-----------------|------------------------------------------------------------------------------------------------------------|
| <b>IPGWI</b>    | An ITU version of SS7IPGW                                                                                  |
| <b>IPGWx</b>    | Point to multi-point IP Transport GPL, referring to SS7IPGW (ANSI) and IPGWI (ITU)                         |
| <b>IPLIM</b>    | The application software used by the DCM card for TCP/IP point-to-point connectivity for ANSI point codes. |
| <b>IPLIMI</b>   | The application software used by the DCM card for TCP/IP point-to-point connectivity for ITU point codes.  |
| <b>IPLIMx</b>   | Point to point IP Transport GPL, referring to IPLIM (ANSI) and IPLIMI (ITU)                                |
| <b>IPMX</b>     | IMT Power and Multiplexer                                                                                  |
| <b>IPS</b>      | Internet Protocol Services                                                                                 |
| <b>IPSM</b>     | Internet Protocol Services Module                                                                          |
| <b>IS-41</b>    | Interim Standard 41, same as and interchangeable with ANSI-41                                              |
| <b>IS-ANR</b>   | In Service - Abnormal                                                                                      |
| <b>ISDN</b>     | Integrated Services Digital Network                                                                        |
| <b>IS-NR</b>    | In Service - Normal                                                                                        |
| <b>ISUP</b>     | ISDN User Part                                                                                             |
| <b>ITU</b>      | International Telecommunications Union                                                                     |
| <b>ITUDUPPC</b> | ITU National Duplicate Point Code                                                                          |
| <b>JIP</b>      | Jurisdiction Indicator Parameter                                                                           |
| <b>LAN</b>      | Local Area Network                                                                                         |
| <b>LB</b>       | Load Balancing                                                                                             |
| <b>LBP</b>      | Loop Back Point                                                                                            |
| <b>LC</b>       | Logical channel                                                                                            |
| <b>LED</b>      | Light Emitting Diode                                                                                       |
| <b>LFS</b>      | Link Fault Sectionalization                                                                                |
| <b>LIM</b>      | Link Interface Module                                                                                      |
| <b>LIM-AINF</b> | Link Interface Module with the AINF interface                                                              |
| <b>LIM-ATM</b>  | LIM with ATM interface                                                                                     |
| <b>LIM-DS0</b>  | LIM with DS0 Applique                                                                                      |
| <b>LIM-E1</b>   | LIM with E1 Applique                                                                                       |
| <b>LIM-OCU</b>  | LIM with Office Channel Unit Applique                                                                      |
| <b>LIM-V35</b>  | LIM with V35 Interface                                                                                     |
| <b>LNP</b>      | Local Number Portability                                                                                   |
| <b>LNP MR</b>   | LNP Message Relay                                                                                          |
| <b>LNPQS</b>    | LNP Query Service                                                                                          |
| <b>LNP SMS</b>  | LNP Short Message Service                                                                                  |
| <b>LPE</b>      | Logical Processing Element                                                                                 |
| <b>LPO</b>      | Link Processor Outage                                                                                      |
| <b>LRN</b>      | Location Routing Number                                                                                    |
| <b>LS</b>       | Link Set                                                                                                   |
| <b>LSA</b>      | Link Status Alignment                                                                                      |
| <b>LSB</b>      | Least Significant Bit (bit 1)                                                                              |
| <b>LSL</b>      | Low-Speed Link                                                                                             |
| <b>LSMS</b>     | Local Service Management System                                                                            |
| <b>LSN</b>      | Link Set Name                                                                                              |
| <b>LSO</b>      | Link Status out of Service                                                                                 |
| <b>LSPE</b>     | Link Status Proving Emergency                                                                              |
| <b>LSPN</b>     | Link Status Proving Normal                                                                                 |
| <b>LSR</b>      | Link Status Ready                                                                                          |
| <b>LSSU</b>     | Link Status Signal Unit                                                                                    |
| <b>M2PA</b>     | SS7 MTP2-User Peer-to-Peer Adaptation Layer                                                                |
| <b>M3UA</b>     | SS7 MTP3-User Adaptation Layer                                                                             |
| <b>MAAL</b>     | Management ATM Adaptation Layer                                                                            |
| <b>MAP</b>      | Mobile Application Part                                                                                    |

## Acronyms and Abbreviations

|                |                                                                   |
|----------------|-------------------------------------------------------------------|
| <b>MAPSCRN</b> | GSM MAP Screening measurements report                             |
| <b>MCAP</b>    | MAS Communication Application Processor Card                      |
| <b>MCC</b>     | Mobile Country Code                                               |
| <b>MCM</b>     | Maintenance Communication Module                                  |
| <b>MCP</b>     | Measurement Collection Processor                                  |
| <b>MCPM</b>    | Measurement Collection and Polling Module                         |
| <b>MDAL</b>    | Maintenance Disk and Alarm (card)                                 |
| <b>MDN</b>     | Mobile Dialed Number                                              |
| <b>MGT</b>     | Mobile Global Title                                               |
| <b>MGTT</b>    | Modified Global Title Translation                                 |
| <b>MF</b>      | Miscellaneous Frame                                               |
| <b>MIM</b>     | Multi-Channel Interface Module                                    |
| <b>MIN</b>     | Mobile Identification Number                                      |
| <b>MLPRST</b>  | MTP Low Priority Route Set                                        |
| <b>MNP</b>     | Mobile Number Portability                                         |
| <b>MNP SMS</b> | Portability Check for Mobile Originated SMS                       |
| <b>MNP-SRF</b> | Signaling Relay Function for support of Mobile Number Portability |
| <b>MOBR</b>    | Origin-based MTP Routing feature                                  |
| <b>MPC</b>     | Multiple Point Code feature                                       |
| <b>MPL</b>     | Multi-port LIM                                                    |
| <b>MPS</b>     | Multi-Purpose Server                                              |
| <b>MR</b>      | Message Relay                                                     |
| <b>MRN</b>     | Mated Relay Node                                                  |
| <b>MRN</b>     | Message Reference Number                                          |
| <b>MS</b>      | Mobile Station                                                    |
| <b>MSB</b>     | Most Significant Bit                                              |
| <b>MSC</b>     | Mobile Switching Center                                           |
| <b>MSAR</b>    | Memory space accounting reporting                                 |
| <b>MSISDN</b>  | Mobile Station ISDN Number or Mobile Switching ISDN Number        |
| <b>MSRN</b>    | Mobile Station Roaming Number                                     |
| <b>MSU</b>     | Message Signal Unit                                               |
| <b>MTCD</b>    | Maintenance Daily measurements report                             |
| <b>MTCDTH</b>  | Maintenance Day-to-Hour measurements report                       |
| <b>MTCH</b>    | Maintenance Hourly (marginal) measurements report                 |
| <b>MTCS</b>    | Maintenance Status (link/link set) measurements report            |
| <b>MTP</b>     | Message Transfer Part                                             |
| <b>MTP2</b>    | Message Transfer Part, Level 2                                    |
| <b>NAI</b>     | Nature of Address Indicator                                       |
| <b>NCAI</b>    | Nested Cluster Allowed Indicator                                  |
| <b>NCR</b>     | Nested Cluster Routing                                            |
| <b>NEC</b>     | National Escape Code                                              |
| <b>NFAS</b>    | Non-Frame Alignment Signal                                        |
| <b>NI</b>      | Network Indicator                                                 |
| <b>NIC</b>     | Network Information Center                                        |
| <b>NID</b>     | Network Identification                                            |
| <b>NM</b>      | Network Management                                                |
| <b>NP</b>      | Number Plan                                                       |
| <b>NPA</b>     | Numbering Plan Area                                               |
| <b>NPAC</b>    | Number Portability Administration Center                          |
| <b>NPANXX</b>  | Numbering Plan Area and Exchange                                  |
| <b>NRT</b>     | Network Routing                                                   |
| <b>NSAP</b>    | Network Service Access Point                                      |
| <b>NSE</b>     | Network Security Enhancement                                      |
| <b>NSFI</b>    | Next Screening Function Indicator                                 |

## Acronyms and Abbreviations

|                     |                                                      |
|---------------------|------------------------------------------------------|
| <b>NSP</b>          | Network Services Part                                |
| <b>NSPC</b>         | New Secondary Point Code                             |
| <b>OAM</b>          | Operations, Administration, and Maintenance          |
| <b>OAP</b>          | Operation System Support Application Processor       |
| <b>OAMP</b>         | Operations, Administration and Maintenance Part      |
| <b>OBSR</b>         | Origin-based SCCP Routing feature                    |
| <b>OCU</b>          | Office Channel Unit                                  |
| <b>OOS-MA</b>       | Out of Service - Memory Administration               |
| <b>OOS-MT</b>       | Out of Service - Maintenance                         |
| <b>OOS-MT-DSBLD</b> | Out of Service - Maintenance Disabled                |
| <b>OPC</b>          | Origination Point Code                               |
| <b>OPCODE</b>       | Operation Code                                       |
| <b>OPNAME</b>       | Operation Name                                       |
| <b>OSI</b>          | Open Systems Interconnection                         |
| <b>OSS</b>          | Operations Systems Support                           |
| <b>PC</b>           | Point Code                                           |
| <b>PCR</b>          | Preventive Cyclic Retransmission                     |
| <b>PCS</b>          | Personal Communications Service (North American GSM) |
| <b>PDBA</b>         | Provisioning Database Application                    |
| <b>PDBI</b>         | Provisioning Database Interface                      |
| <b>PDN</b>          | Packet Data Network                                  |
| <b>PDS</b>          | Persistent Device States                             |
| <b>PLNP</b>         | PCS 1900 LNP                                         |
| <b>PLNPQS</b>       | LNPQS support provided for PLNP                      |
| <b>PPSMS</b>        | Prepaid Short Message Service Intercept              |
| <b>PROM</b>         | Programmable Read-Only Memory                        |
| <b>PSEL</b>         | Presentation Selector                                |
| <b>PST</b>          | Primary State for Maintenance                        |
| <b>PSTN</b>         | Public Switched Telephone Network                    |
| <b>PVC</b>          | Permanent Virtual Circuit                            |
| <b>PVN</b>          | Private Virtual Network                              |
| <b>Q3</b>           | Q.3 Protocol                                         |
| <b>RAM</b>          | Random Access Memory                                 |
| <b>RBASE</b>        | Record Base measurements report                      |
| <b>RC</b>           | Relative Cost                                        |
| <b>RI</b>           | Routing Indicator                                    |
| <b>RFC</b>          | Request for Comments                                 |
| <b>RMC</b>          | Remote Maintenance Center                            |
| <b>RMTTP</b>        | Reliable Multicast Transport Protocol                |
| <b>RN</b>           | Routing Number                                       |
| <b>RTDB</b>         | DSM Real-time database                               |
| <b>RTT</b>          | Round Trip Time                                      |
| <b>SAAL</b>         | Signaling ATM Adaptation Layer                       |
| <b>SAPC</b>         | Secondary Adjacent Point Code                        |
| <b>SCCP</b>         | Signaling Connection Control Part                    |
| <b>SCM</b>          | System Configuration Manager                         |
| <b>SCMG</b>         | SCCP Management                                      |
| <b>SCP</b>          | Service Control Point                                |
| <b>SCRSET</b>       | Screen Set                                           |
| <b>SCSI</b>         | Small Computer System Interface                      |
| <b>SCTP</b>         | Stream Control Transmission Protocol                 |
| <b>SE-HSL</b>       | Synchronous E1 High Speed Link                       |
| <b>SEAS</b>         | Signaling Engineering and Administration System      |
| <b>SIB</b>          | Status Indication "Busy"                             |



## Acronyms and Abbreviations

|                |                                                                                         |
|----------------|-----------------------------------------------------------------------------------------|
| <b>SIE</b>     | Status Indication “Emergency” Alignment                                                 |
| <b>SIN</b>     | Status Indication “Normal Alignment”                                                    |
| <b>SIO</b>     | Service Information Octet                                                               |
| <b>SIO</b>     | Status Indication “Out of Alignment”                                                    |
| <b>SIOS</b>    | Status Indication “Out of Service”                                                      |
| <b>SK</b>      | Service Key                                                                             |
| <b>SKTS</b>    | Service Key/TeleService List                                                            |
| <b>SLK</b>     | Signaling Link                                                                          |
| <b>SLS</b>     | Signaling Link Selection                                                                |
| <b>SLSCI</b>   | Signaling Link Conversion Indicator                                                     |
| <b>SLTA</b>    | Signaling Link Test Acknowledgement                                                     |
| <b>SLTM</b>    | Signaling Link Test Message                                                             |
| <b>SMS</b>     | Short Message Service                                                                   |
| <b>SMSC</b>    | Short Message Service Center                                                            |
| <b>SMSMR</b>   | Prepaid Short Message Service                                                           |
| <b>SNAI</b>    | Service Nature of Address Indicator                                                     |
| <b>SNM</b>     | Signaling Network Management                                                            |
| <b>SNR</b>     | Subsystem Normal Routing                                                                |
| <b>SOR</b>     | Support for Optimal Routing                                                             |
| <b>SORP</b>    | Socket Option Registration Primitive                                                    |
| <b>SPC</b>     | Secondary Point Code Signaling Point Code                                               |
| <b>SRF</b>     | Signaling Relay Function                                                                |
| <b>SRI</b>     | Send Routing Information                                                                |
| <b>SRVSEL</b>  | Service Selector                                                                        |
| <b>SS7</b>     | Signaling System #7                                                                     |
| <b>SS7ANSI</b> | The application software for the ANSI SS7 signaling links                               |
| <b>SS7GX25</b> | The application software for the X.25/SS7 gateway feature                               |
| <b>SS7IPGW</b> | The application software used by the DCM card for TCP/IP point-to-multipoint capability |
| <b>SSA</b>     | Subsystem Allowed (An SCCP management message)                                          |
| <b>SSEL</b>    | Session Selector                                                                        |
| <b>SSN</b>     | SS7 Subsystem Number                                                                    |
| <b>SSP</b>     | Service Switching Point                                                                 |
| <b>SSU</b>     | Status Signal Unit                                                                      |
| <b>ST</b>      | Stop Digit—BCD value 15 (0xF)—used to indicate the end of dialing in some applications  |
| <b>STC</b>     | Signaling Transport Card                                                                |
| <b>STP</b>     | Signal Transfer Point                                                                   |
| <b>STP LAN</b> | The application software for the STP LAN feature                                        |
| <b>SUA</b>     | SS7 SCCP-User Adaptation Layer                                                          |
| <b>SVC</b>     | Switched Virtual Circuit                                                                |
| <b>TALI</b>    | Transport Adapter Layer Interface (RFC 3094)                                            |
| <b>TCP</b>     | Transmission Control Protocol                                                           |
| <b>TCAP</b>    | Transaction Capabilities Application Part                                               |
| <b>TDM</b>     | Terminal Disk Module                                                                    |
| <b>TFA</b>     | Transfer Allowed                                                                        |
| <b>TFC</b>     | Transfer Congested (traffic)                                                            |
| <b>TFP</b>     | Transfer Prohibited                                                                     |
| <b>TFR</b>     | Transfer Restricted                                                                     |
| <b>TLNP</b>    | Triggerless LNP                                                                         |
| <b>TOS</b>     | Type of Service                                                                         |
| <b>TPS</b>     | Transactions Per Second                                                                 |
| <b>TRA</b>     | Traffic Restarting Allowed                                                              |
| <b>TRBL</b>    | Trouble                                                                                 |

## Acronyms and Abbreviations

|                |                                                           |
|----------------|-----------------------------------------------------------|
| <b>TRW</b>     | Traffic Restarting Waiting                                |
| <b>TSC</b>     | Time Slot Counter Synchronization                         |
| <b>TSM</b>     | Translation Services Module                               |
| <b>TT</b>      | Translation Type                                          |
| <b>TUP</b>     | Telephone User Part                                       |
| <b>TV</b>      | Ticket Voucher                                            |
| <b>TVG</b>     | Group Ticket Voucher                                      |
| <b>UA</b>      | IETF User Adaptation Layers                               |
| <b>UAM</b>     | Unsolicited Alarm Message                                 |
| <b>UART</b>    | Universal Asynchronous Receiver - Transmit                |
| <b>UDP</b>     | User Datagram Protocol                                    |
| <b>UDTS</b>    | Unit Data Transfer Service                                |
| <b>UI</b>      | User Interface                                            |
| <b>UID</b>     | User ID                                                   |
| <b>UIM</b>     | Unsolicited Informational Message                         |
| <b>UPD</b>     | Update                                                    |
| <b>VGTT</b>    | Variable Length GTT                                       |
| <b>VLR</b>     | Visitor Location Register                                 |
| <b>VMSC</b>    | Voice Mail Service Center Visited Mobile Switching Center |
| <b>VSCCP</b>   | VxWorks Signaling Connection Control Part                 |
| <b>WNP</b>     | Wireless Number Portability                               |
| <b>WNPQS</b>   | Wireless Number Portability Query Service                 |
| <b>X.25 DE</b> | X.25 Destination Entity                                   |
| <b>XGTT</b>    | Expanded GTT (GTT Table Expansion)                        |
| <b>XMAP</b>    | Expanded MAP Table                                        |