

Tekelec EAGLE[®] 5 SAS - Release 34.0

Database Administration - SS7

Table of Chapters

Table of Contents

List of Figures

List of Tables

List of Flowcharts

Chapter 1. Introduction

Chapter 2. Configuring Destination Tables

Chapter 3. SS7 Configuration

Appendix A. E1 Interface

Appendix B. T1 Interface

Appendix C. ATM Signaling Link Configuration

Appendix D. Reference Information

Index

Tekelec EAGLE[®] 5
Signaling Application System

Release 34.0

Database Administration Manual - SS7

910-0120-001 Revision B

October 2005



TEKELEC

**Copyright 2005 Tekelec.
All Rights Reserved
Printed in U.S.A.**

Notice

Information in this documentation is subject to change without notice. Unauthorized use or copying of this documentation can result in civil or criminal penalties.

Any export of Tekelec products is subject to the export controls of the United States and the other countries where Tekelec has operations.

No part of this documentation may be reproduced or transmitted in any form or by any means, electronic or mechanical, including photocopying or recording, for any purpose without the express written permission of an authorized representative of Tekelec.

Other product names used herein are for identification purposes only, and may be trademarks of their respective companies.

Trademarks

The Tekelec logo, EAGLE, G-Flex, G-Port, IP⁷, IP⁷Edge, IP⁷ Secure Gateway, and TALI are registered trademarks of Tekelec, Inc. TekServer is a trademark of Tekelec, Inc. All other trademarks are the property of their respective owners.

Patents

This product is covered by one or more of the following U.S. and foreign patents:

U.S. Patent Numbers:

5,008,929, 5,953,404, 6,167,129, 6,324,183, 6,327,350, 6,606,379, 6,639,981, 6,647,113, 6,662,017, 6,735,441, 6,745,041, 6,765,990, 6,795,546, 6,819,932, 6,836,477, 6,839,423, 6,885,872

Ordering Information

Additional copies of this document can be ordered from:

Tekelec Network Signaling Group
Attention: Central Logistics
5200 Paramount Parkway
Morrisville, North Carolina, 27560

Or e-mail your request to CentralLogistics@tekelec.com.

Table of Contents

Chapter 1. Introduction

Overview	1-2
Manual Organization	1-2
Related Publications	1-3
Documentation Packaging and Updates	1-8
Documentation Admonishments	1-8
Customer Care Center	1-8
Emergency Response	1-9
Maintenance and Administration Subsystem	1-10
Database Partitions	1-11
Fixed Disk Drive	1-12
Removable Cartridge	1-13
List of Acronyms and Abbreviations	1-14

Chapter 2. Configuring Destination Tables

Introduction	2-2
Point Code Formats	2-4
ANSI Point Codes	2-4
ITU International Point Codes	2-6
14-Bit ITU National Point Codes	2-7
24-Bit ITU National Point Codes	2-7
Spare Point Codes	2-7
Private Point Codes	2-8
Point Code Usage	2-8
14-Bit ITU National Point Code Formats	2-10
Changing the Format of 14-Bit ITU National Point Codes	2-12
ITU National Duplicate Point Codes	2-16
Group Codes	2-16
Normal Operation	2-17
C Linksets	2-18
Receiving an ITU-National MSU on an ITU-International Linkset	2-19
Existing ITU National Destinations	2-20
Interaction with Other Features	2-20
Limitations	2-22
Changing the DPC Quantity	2-23

Activating the ITU National and International Spare Point Code Support Feature	2-42
Multiple Point Code Support	2-55
Replacing Two STP Pairs with One Pair	2-56
Multiple Linksets between Two Nodes	2-58
Limitations	2-62
Adding a Secondary Point Code	2-63
Removing a Secondary Point Code	2-74
Adding a Point Code to the Self-Identification of the EAGLE 5 SAS	2-81
Changing the Self-Identification of the EAGLE 5 SAS	2-90
Cluster Routing and Management Diversity (CRMD)	2-119
Exception Lists (X-lists)	2-120
Cluster Routing	2-124
Compatibility with Non-Cluster Routing Nodes	2-125
Cluster Management and the ITU Network	2-125
Cluster Management When the Cluster Routing Feature is Turned Off	2-126
Cluster Routing and Management Diversity Rules	2-126
Cluster Routing and Management Diversity Example	2-128
Home Cluster Example	2-132
Nested Cluster Routing	2-135
Nested Clusters and Cluster Members	2-135
Administration	2-137
Nested Cluster Routing Rules of Operations	2-137
Limitations of the Nested Cluster Routing Feature	2-141
Adding a Cluster Point Code	2-142
Changing the Attributes of a Cluster Point Code	2-161
Network Routing	2-174
Types of Routing Strategies Available	2-174
Applications	2-175
Route Availability	2-176
Point Code Availability	2-176
Route Management	2-177
Administration	2-180
Adding a Network Routing Point Code	2-181
Adding a Destination Point Code	2-191
Removing a Destination Point Code	2-214

Table of Contents

Changing a Destination Point Code	2-226
Changing the Group Code Assigned to a 14-Bit ITU National Point Code	2-248
Chapter 3. SS7 Configuration	
Introduction	3-3
Enabling the Large System # Links Controlled Feature	3-10
Adding an SS7 Linkset	3-17
MTP Restart	3-24
5-Bit to 8-Bit SLS Conversion	3-26
ITU SLS Enhancement	3-29
ITU TFR Procedures	3-33
Sample Linkset Configuration	3-35
Removing a Linkset Containing SS7 Signaling Links	3-63
Changing an SS7 Linkset	3-74
Configuring an ITU Linkset with a Secondary Adjacent Point Code (SAPC)	3-113
Adding an SS7 Signaling Link	3-130
Example Signaling Link Configuration	3-134
Removing an SS7 Signaling Link	3-145
Adding a Route Containing an SS7 DPC	3-153
Adding a Route Containing a Cluster Point Code	3-164
Adding a Route Containing an IPGWx Linkset	3-172
Adding a Route Containing an X.25 DPC	3-181
Removing a Route	3-189
Changing a Route	3-206
Changing Level 2 Timers	3-219
Changing Level 3 Timers	3-222
Changing a Signaling Link Test Message	3-228
Configuring Circular Route Detection	3-231
Configuring the TFA/TFR Pacing Rate	3-235
Configuring the Frequency of RST Messages on Low Priority Routes	3-238
Adding Remote Loopback Points	3-241
Removing Remote Loopback Points	3-247
Changing Remote Loopback Points	3-250
Configuring the System for Random SLS Generation	3-254
Configuring the Options for the TDM Global Timing Interface	3-263
Configuring the Restricted Linkset Option	3-269

Configuring the Options for Handling TFCs on ITU-I and ITU-N Networks	3-276
Changing the HC MIM Temperature Alarm Thresholds	3-279
Appendix A. E1 Interface	
Introduction	A-2
Configured as an E1 Card	A-5
Configured as a Channel Card	A-5
High Capacity Multi-Channel Interface Module (HC MIM)	A-6
Determining the Configuration	A-8
External Interface Descriptions	A-8
E1 Cards Containing DIP Switches	A-8
Possible Configurations	A-9
E1 Interface Configuration Procedures	A-13
Adding a LIM-E1 Card	A-14
Removing a LIM-E1 Card	A-24
Adding Channelized and non-Channel Bridged E1 Ports	A-28
Adding Channel Bridged E1 Ports	A-37
Adding Unchannelized E1 Ports	A-45
Removing the E1 Interface Parameters	A-59
Changing the Attributes of an E1 Port	A-62
Adding an E1 Signaling Link	A-77
Configuring Signaling Links on LIM-E1 Cards	A-80
Example Signaling Link Configuration	A-81
Appendix B. T1 Interface	
Introduction	B-2
Configured as a T1 Card	B-4
Configured as a Channel Card	B-4
High Capacity Multi-Channel Interface Module (HC MIM)	B-4
Determining the Configuration	B-7
External Interface Descriptions	B-7
Possible Configurations	B-7
T1 Interface Configuration Procedures	B-10
Adding a LIM-T1 Card	B-11
Removing a LIM-T1 Card	B-20
Adding the T1 Interface Parameters	B-24
Removing the T1 Interface Parameters	B-33
Changing the T1 Interface Parameters	B-36

Table of Contents

Adding a T1 Signaling Link	B-47
Example Signaling Link Configuration	B-50
Appendix C. ATM Signaling Link Configuration	
Introduction	C-1
ATM Protocol Encapsulation	C-6
Overview of the ATM High-Speed Signaling Link LIM	
Operation	C-8
Applique	C-10
E1 Overview	C-12
ATM Driver	C-15
E1 ATM Driver	C-16
SSCOP	C-16
SSCF	C-17
ATM and SAAL Layer Management Interfaces	C-18
ATM High-Speed Signaling Link Testing Capability	C-19
Local Loopback Support	C-19
Remote Loopback Support	C-22
Link Status Logging Capability	C-23
Large MSUs	C-27
Unsolicited Messages	C-27
Link Unavailability UAMs	C-27
UIMs	C-29
ATM High-Speed Signaling Link Configuration	C-30
Adding a High-Speed LIM-ATM or an E1-ATM LIM	C-31
Adding an ATM High-Speed Signaling Link	C-34
Example Signaling Link Configuration	C-37
Changing an ATM High-Speed Signaling Link Parameter Set	C-50
Appendix D. Reference Information	
Requirements for EAGLE 5 SASs Containing more than 700 Signaling Links	D-2
Determining the Number of High-Speed and Low-Speed Signaling Links	D-2

Index

List of Figures

Figure 1-1. Database Partitions	1-11
Figure 2-1. Mixed Network with ANSI, ITU-I, and ITU-N Nodes	2-2
Figure 2-2. Network Example #1	2-16
Figure 2-3. Network Example #2	2-18
Figure 2-4. Network for Conversion	2-21
Figure 2-5. Replacing the First STP Pair	2-56
Figure 2-6. Replacing a Second STP Pair	2-58
Figure 2-7. Multiple Linkset Example	2-59
Figure 2-8. Cluster Routing and Management Diversity	2-120
Figure 2-9. Cluster Management	2-129
Figure 2-10. Home Cluster Example	2-132
Figure 2-11. Nested Cluster Routing Sample Configuration	2-138
Figure 2-12. Example of Network Routing Reliability	2-175
Figure 2-13. Potential Routing Network Failure	2-176
Figure 3-1. SS7 Database Relationships	3-4
Figure 3-2. Complex Network with ANSI, ITU-I, and ITU-N Nodes	3-8
Figure 3-3. Sample SS7 Network Configuration	3-9
Figure 3-4. ITU ISUP Routing Label with CIC	3-29
Figure 3-5. Example of Bit Rotation	3-31
Figure 3-6. SLS creation Using “Other CIC Bit”	3-32
Figure 3-7. Random SLS Mapping to a Single Linkset	3-256
Figure A-1. LIM-E1 Block Diagram	A-2
Figure A-2. E1/T1 MIM Block Diagram	A-3
Figure A-3. HC MIM Block Diagram	A-4
Figure A-4. Channel Bridging	A-6
Figure B-1. E1/T1 MIM Block Diagram	B-2
Figure B-2. HC MIM Block Diagram	B-3
Figure B-3. Channel Bridging	B-5
Figure C-1. High-Speed Link Protocol Model for CCS Network Elements	C-2

List of Figures

Figure C-2. ATM High-Speed Signaling Link Protocol Stack vs. Tekelec Implementation in the EAGLE 5 SAS	C-4
Figure C-3. Frame Formats for High-Speed and Low-Speed Signaling Link Protocol Stacks	C-5
Figure C-4. ATM Protocol Encapsulation	C-7
Figure C-5. Functional Block Diagram of ATM High-Speed Signaling Link	C-9
Figure C-6. E1 Frame Structure	C-12
Figure C-7. CRC-4 Multiframe Structure	C-14
Figure C-8. ATM Cell Mapping into E1 Frames	C-15
Figure C-9. ANSI ATM High-Speed Signaling Link Loopback Support	C-21
Figure C-10. E1 ATM High-Speed Signaling Link Loopback Support	C-22

List of Tables

Table 2-1. Point Code Format	2-8
Table 2-2. 14-Bit ITU National Point Code Values	2-11
Table 2-3. Example Cluster Routing Information	2-129
Table 2-4. Home Cluster Routing Information	2-132
Table 2-5. Routing Models	2-135
Table 2-6. Routing Table for Nested Cluster 5-5-*	2-139
Table 2-7. Routing Table for Full Point Code Member 5-5-1	2-139
Table 2-8. Example of Nested Cluster Routing Failure and Recovery Actions	2-139
Table 2-9. Reception of an RSx Message	2-179
Table 2-10. Reception of an RCx Message	2-180
Table 2-11. Destination Point Code and Alias Parameter Combinations	2-194
Table 2-12. Sample Destination Point Code Table Configuration	2-196
Table 2-13. Destination Point Code and Alias Parameter Combinations	2-229
Table 3-1. SS7 Signaling Link Card Types and Applications	3-5
Table 3-2. Actions of the National Spare for Network Indicator Feature	3-19
Table 3-3. MTP Restart Signaling Link Alignment Delay	3-25
Table 3-4. Signaling Link Selector (SLS) Conversion (ANSI Linksets Only)	3-27
Table 3-5. Route Management Messages Sent on Status Transition	3-34
Table 3-6. Linkset Configuration Table	3-35
Table 3-7. Actions of the National Spare for Network Indicator Feature	3-77
Table 3-8. Secondary Adjacent Point Code Configuration Table	3-114
Table 3-9. L2TSET Parameter Values	3-131
Table 3-10. SS7 Signaling Link Parameter Combinations	3-133
Table 3-11. Low-Speed Signaling Link Configuration Table	3-134
Table 3-12. Level 2 Timer Sets	3-219

List of Tables

Table 3-13. Level 2 Timer Values	3-219
Table 3-14. Loopback Point Configuration Table	3-242
Table 3-15. Failure Scenarios for a 32-Link Combined Linkset	3-257
Table A-1. Functional Overview of the E1 and Channel Card	A-5
Table A-2. Channel Bridging E1 Port Pairing	A-7
Table A-3. E1 Signaling Link Configuration Form	A-12
Table A-4. E1 Card Part Numbers	A-14
Table A-5. HC MIM Card Locations	A-14
Table A-6. Card Removal Procedures	A-16
Table A-7. Maximum Number of E1 Ports	A-30
Table A-8. E1 Interface Parameter Combinations	A-31
Table A-9. Channel Bridging Ports	A-38
Table A-10. Channel Bridged E1 Port Combinations	A-41
Table A-11. Unchannelized E1 Signaling Link Quantity Part Numbers	A-50
Table A-12. Unchannelized E1 Port Parameter Combinations	A-51
Table A-13. Channel Bridging Ports	A-63
Table A-14. E1 Interface Parameter Combinations	A-67
Table A-15. L2TSET Parameter Values	A-78
Table A-16. E1 Signaling Link Configuration Table	A-81
Table A-17. Link Parameter Values	A-87
Table B-1. Functional Overview of the T1 and Channel Card	B-4
Table B-2. Channel Bridging T1 Port Pairing	B-5
Table B-3. T1 Signaling Link Configuration Form	B-9
Table B-4. T1 Card Part Numbers	B-11
Table B-5. HC MIM Card Locations	B-11
Table B-6. Card Removal Procedures	B-13
Table B-7. Channel Bridging Ports	B-24
Table B-8. T1 Interface Parameter Combinations	B-27
Table B-9. Channel Bridging Ports	B-36
Table B-10. T1 Interface Parameter Combinations	B-39
Table B-11. L2TSET Parameter Values	B-48
Table B-12. T1 Signaling Link Configuration Table	B-50
Table B-13. Link Parameter Values	B-55

Table C-1. Link Proving Differences Between ITU and ANSI	C-17
Table C-2. ATM High-Speed Signaling Link Loopback Support	C-20
Table C-3. High-Speed Signaling Link vs. Low-Speed Signaling Link Unavailability Reasons by Priority	C-23
Table C-4. High-Speed Signaling Link State Transition Alignment Events	C-25
Table C-5. High-Speed Signaling Link Transmitted/Received Alignment PDUs	C-25
Table C-6. High-Speed Signaling Link Special Level 1 Alignment Events	C-26
Table C-7. Signaling Link Unsolicited Alarm Messages	C-28
Table C-8. Table 5 : Loopback Test UIMs	C-29
Table C-9. ATM High-Speed LIM Card Type and Card Application Combinations	C-31
Table C-10. Example Card Configuration	C-31
Table C-11. ATM Signaling Link Cable Lengths	C-35
Table C-12. ATM High-Speed Signaling Link Parameter Combinations	C-36
Table C-13. ANSI High-Speed ATM Signaling Link Configuration Table	C-37
Table C-14. E1 High-Speed ATM Signaling Link Configuration Table	C-37
Table D-1. Number of High-Speed and Low-Speed Links Supported at 100% Traffic	D-3

List of Flowcharts

Flowchart 2-1. Changing the Format of an ITU National Point Code	2-13
Flowchart 2-2. Changing the DPC Quantity	2-35
Flowchart 2-3. Activating the ITU National and International Spare Point Code Support Feature	2-51
Flowchart 2-4. Adding a Secondary Point Code	2-70
Flowchart 2-5. Removing a Secondary Point Code	2-78
Flowchart 2-6. Adding a Point Code to the Self-Identification of the EAGLE 5 SAS	2-87
Flowchart 2-7. Changing the Self-Identification of the System	2-108
Flowchart 2-8. Adding a Cluster Point Code	2-155
Flowchart 2-9. Changing the Attributes of a Cluster Point Code	2-169
Flowchart 2-10. Adding a Network Routing Point Code	2-188
Flowchart 2-11. Adding a Destination Point Code	2-206
Flowchart 2-12. Removing a Destination Point Code	2-221
Flowchart 2-13. Changing a Destination Point Code	2-239
Flowchart 2-14. Changing the Group Code Assigned to a 14-Bit ITU National Point Code	2-251
Flowchart 3-1. Enabling the Large System # Links Controlled Feature	3-14
Flowchart 3-2. Adding an SS7 Linkset	3-52
Flowchart 3-3. Removing a Linkset Containing SS7 Signaling Links	3-72
Flowchart 3-4. Changing an SS7 Linkset	3-99
Flowchart 3-5. Configuring an ITU Linkset with a Secondary Adjacent Point Code (SAPC)	3-125
Flowchart 3-6. Adding an SS7 Signaling Link	3-142
Flowchart 3-7. Removing an SS7 Signaling Link	3-151
Flowchart 3-8. Adding a Route Containing an SS7 DPC	3-161
Flowchart 3-9. Adding a Route Containing a Cluster Point Code	3-170
Flowchart 3-10. Adding a Route Containing an IPGWx Linkset	3-178
Flowchart 3-11. Adding a Route Containing an X.25 DPC	3-187
Flowchart 3-12. Removing a Route	3-199
Flowchart 3-13. Changing a Route	3-215

Flowchart 3-14. Changing the Level 2 Timers	3-221
Flowchart 3-15. Changing the Level 3 Timers	3-227
Flowchart 3-16. Changing a Signaling Link Test Message	3-230
Flowchart 3-17. Configuring the System to Detect Circular Routing	3-234
Flowchart 3-18. Configuring the TFA/TFR Pacing Rate	3-237
Flowchart 3-19. Configuring the Frequency of RST Messages on Low Priority Routes	3-240
Flowchart 3-20. Adding Remote Loopback Points	3-246
Flowchart 3-21. Removing Remote Loopback Points	3-249
Flowchart 3-22. Changing Remote Loopback Points	3-253
Flowchart 3-23. Random SLS Mapping to a Combined Linkset	3-255
Flowchart 3-24. Configuring the System for Random SLS Generation	3-261
Flowchart 3-25. Configuring the Options for the TDM Global Timing Interface	3-267
Flowchart 3-26. Configuring the Restricted Linkset Option	3-274
Flowchart 3-27. Configuring the Options for Handling TFCs on ITU-I and ITU-N Networks	3-278
Flowchart 3-28. Changing the HC MIM Temperature Alarm Thresholds	3-282
Flowchart A-1. Adding a LIM-E1 Card	A-20
Flowchart A-2. Removing a LIM-E1 Card	A-27
Flowchart A-3. Adding Channelized and non-Channel Bridged E1 Ports	A-33
Flowchart A-4. Removing the E1 Interface Parameters	A-61
Flowchart A-5. Changing the Attributes of an E1 Port	A-69
Flowchart A-6. Adding an E1 Signaling Link	A-92
Flowchart B-1. Adding a LIM-T1 Card	B-16
Flowchart B-2. Removing a LIM-T1 Card	B-23
Flowchart B-3. Adding the T1 Interface Parameters	B-29
Flowchart B-4. Removing the T1 Interface Parameters	B-35
Flowchart B-5. Changing the T1 Interface Parameters	B-41
Flowchart B-6. Adding a T1 Signaling Link	B-58
Flowchart C-1. Adding a High-Speed LIM-ATM or an E1-ATM LIM	C-33
Flowchart C-2. Adding an ATM High-Speed Signaling Link	C-46
Flowchart C-3. Changing an ATM High-Speed Signaling Link Parameter Set	C-56

1

Introduction

Overview	1-2
Manual Organization	1-2
Related Publications.....	1-3
Documentation Packaging and Updates.....	1-8
Documentation Admonishments	1-8
Customer Care Center	1-8
Emergency Response	1-9
Maintenance and Administration Subsystem	1-10
Database Partitions.....	1-11
Fixed Disk Drive.....	1-12
Removable Cartridge.....	1-13
List of Acronyms and Abbreviations.....	1-14

Overview

The *Database Administration Manual – SS7* describes the procedures necessary for database administration personnel or translations personnel to create, modify, display, and maintain the EAGLE 5 SAS database, and to configure the EAGLE 5 SAS to implement the SS7 protocol.

NOTE: Database administration privileges are password restricted. Only those persons with access to the command class “Database Administration” can execute the administrative functions. Other command classes and the commands allowed by those classes are listed in the *Commands Manual*.

NOTE: Previous editions of this manual contained the procedures for provisioning the IP⁷ Secure Gateway features. These procedures have been removed from this manual and are now located in the *Database Administration Manual - IP⁷ Secure Gateway*.

Manual Organization

Throughout this document, the terms database and system software are used. Database refers to all data that can be administered by the user, including shelves, cards, links, routes, global title translation tables, and gateway screening tables. System software refers to data that cannot be administered by the user, including generic program loads (GPLs).

This document is organized into these sections:

Chapter 1, “Introduction,” contains general information about the database and the organization of this manual.

Chapter 2, “Configuring Destination Tables,” describes the methods for configuring destination point codes (DPCs) in the database of the EAGLE 5 SAS. The cluster routing and management diversity feature is also discussed in this section.

Chapter 3, “SS7 Configuration,” describes the procedures necessary to configure the EAGLE 5 SAS to support the SS7 network.

Appendix A, “E1 Interface,” contains general information about the E1 interface and how to provision it.

Appendix B, “T1 Interface,” contains general information about the T1 interface and how to provision it.

Appendix C, “ATM Signaling Link Configuration,” contains general information about the ANSI ATM high-speed signaling links and how to provision them.

Appendix D, “Reference Information,” contains the following information that is used by more than one procedure in this manual:

- Requirements for EAGLE 5 SASs Containing more than 700 Signaling Links
- Determining the Number of High-Speed and Low-Speed Signaling Links

Related Publications

The *Database Administration Manual – SS7* is part of the EAGLE 5 SAS documentation set and may refer to one or more of the following manuals:

- The *Commands Manual* contains procedures for logging into or out of the EAGLE 5 SAS, a general description of the terminals, printers, the disk drive used on the system, and a description of all the commands used in the system.
- The *Commands Pocket Guide* is an abridged version of the *Commands Manual*. It contains all commands and parameters, and it shows the command-parameter syntax.
- The *Commands Quick Reference Guide* contains an alphabetical listing of the commands and parameters. The guide is sized to fit a shirt-pocket.
- The *Commands Error Recovery Manual* contains the procedures to resolve error message conditions generated by the commands in the *Commands Manual*. These error messages are presented in numerical order.
- The *Database Administration Manual – Features* contains procedural information required to configure the EAGLE 5 SAS to implement these features:
 - X.25 Gateway
 - STP LAN
 - Database Transport Access
 - GSM MAP Screening
 - EAGLE 5 SAS Support for Integrated Sentinel
- The *Database Administration Manual - Gateway Screening* contains a description of the Gateway Screening (GWS) feature and the procedures necessary to configure the EAGLE 5 SAS to implement this feature.
- The *Database Administration Manual – Global Title Translation* contains procedural information required to configure an EAGLE 5 SAS to implement these features:
 - Global Title Translation
 - Enhanced Global Title Translation
 - Variable Length Global Title Translation
 - Interim Global Title Modification
 - Intermediate GTT Load Sharing
 - ANSI-ITU-China SCCP Conversion

- The *Database Administration Manual - IP7 Secure Gateway* contains procedural information required to configure the EAGLE 5 SAS to implement the SS7-IP Gateway.
- The *Database Administration Manual – SEAS* contains the EAGLE 5 SAS configuration procedures that can be performed from the Signaling Engineering and Administration Center (SEAC) or a Signaling Network Control Center (SNCC). Each procedure includes a brief description of the procedure, a flowchart showing the steps required, a list of any EAGLE 5 SAS commands that may be required for the procedure but that are not supported by SEAS, and a reference to optional procedure-related information, which can be found in one of these manuals:
 - *Database Administration Manual – Gateway Screening*
 - *Database Administration Manual – Global Title Translation*
 - *Database Administration Manual – SS7*
- The *Database Administration Manual – SS7* contains procedural information required to configure an EAGLE 5 SAS to implement the SS7 protocol.
- The *Database Administration Manual – System Management* contains procedural information required to manage the EAGLE 5 SAS database and GPLs, and to configure basic system requirements such as user names and passwords, system-wide security requirements, and terminal configurations.
- The *Dimensioning Guide for EPAP Advanced DB Features* is used to provide EPAP planning and dimensioning information. This manual is used by Tekelec personnel and EAGLE 5 SAS customers to aid in the sale, planning, implementation, deployment, and upgrade of EAGLE 5 SAS systems equipped with one of the EAGLE 5 SAS EPAP Advanced Database (EADB) Features.
- The *ELAP Administration Manual* defines the user interface to the EAGLE 5 SAS LNP Application Processor on the MPS/ELAP platform. The manual defines the methods for accessing the user interface, menus, screens available to the user and describes their impact. It provides the syntax and semantics of user input, and defines the output the user receives, including information and error messages, alarms, and status.
- The *EPAP Administration Manual* describes how to administer the EAGLE 5 SAS Provisioning Application Processor on the MPS/EPAP platform. The manual defines the methods for accessing the user interface, menus, and screens available to the user and describes their impact. It provides the syntax and semantics of user input and defines the output the user receives, including messages, alarms, and status.
- The *Feature Manual - EIR* provides instructions and information on how to install, use, and maintain the EIR feature on the Multi-Purpose Server (MPS) platform of the EAGLE 5 SAS. The feature provides network operators with

Introduction

the capability to prevent stolen or disallowed GSM mobile handsets from accessing the network.

- The *Feature Manual - G-Flex C7 Relay* provides an overview of a feature supporting the efficient management of Home Location Registers in various networks. This manual gives the instructions and information on how to install, use, and maintain the G-Flex feature on the Multi-Purpose Server (MPS) platform of the EAGLE 5 SAS.
- The *Feature Manual - G-Port* provides an overview of a feature providing the capability for mobile subscribers to change the GSM subscription network within a portability cluster while retaining their original MSISDNs. This manual gives the instructions and information on how to install, use, and maintain the G-Port feature on the Multi-Purpose Server (MPS) platform of the EAGLE 5 SAS.
- The *Feature Manual - INP* provides the user with information and instructions on how to implement, utilize, and maintain the INAP-based Number Portability (INP) feature on the Multi-Purpose Server (MPS) platform of the EAGLE 5 SAS.
- The *FTP-Based Table Retrieve Application (FTRA) User Guide* describes how to set up and use a PC to serve as the offline application for the EAGLE 5 SAS FTP Retrieve and Replace feature.
- The *Hardware Manual - EAGLE 5 SAS* contains hardware descriptions and specifications of Tekelec's signaling products. These include the EAGLE 5 SAS, OEM-based products such as the ASi 4000 Service Control Point (SCP), the Netra-based Multi-Purpose Server (MPS), and the Integrated Sentinel with Extended Services Platform (ESP) subassembly.
- The *Hardware Manual* provides an overview of each system and its subsystems, details of standard and optional hardware components in each system, and basic site engineering. Refer to this manual to obtain a basic understanding of each type of system and its related hardware, to locate detailed information about hardware components used in a particular release, and to help configure a site for use with the system hardware.
- The *Hardware Manual - Tekelec 1000 Application Server* provides general specifications and a description of the Tekelec 1000 Applications Server (T1000 AS). This manual also includes site preparation, environmental and other requirements, procedures to physically install the T1000 AS, and troubleshooting and repair of Field Replaceable Units (FRUs).
- The *Hardware Manual - Tekelec 1100 Application Server* provides general specifications and a description of the Tekelec 1100 Applications Server (T1000 AS). This manual also includes site preparation, environmental and other requirements, procedures to physically install the T1100 AS, and troubleshooting and repair of Field Replaceable Units (FRUs).
- The *Installation Manual - EAGLE 5 SAS* contains cabling requirements, schematics, and procedures for installing the EAGLE 5 SAS along with LEDs,

Connectors, Cables, and Power Cords to Peripherals. Refer to this manual to install components or the complete systems.

- The *Installation Manual - Integrated Applications* provides the installation information for integrated applications such as EPAP 4.0 or earlier (Netra-based Multi-Purpose Server (MPS) platform) and Sentinel. The manual includes information about frame floors and shelves, LEDs, connectors, cables, and power cords to peripherals. Refer to this manual to install components or the complete systems.
- The *LNP Database Synchronization Manual - LSMS with EAGLE 5 SAS* describes how to keep the LNP databases at the LSMS and at the network element (the EAGLE 5 SAS is a network element) synchronized through the use of resynchronization, audits and reconciles, and bulk loads. This manual is contained in both the LSMS documentation set and in the EAGLE 5 SAS documentation set.
- The *LNP Feature Activation Guide* contains procedural information required to configure the EAGLE 5 SAS for the LNP feature and to implement these parts of the LNP feature on the EAGLE 5 SAS:
 - LNP services
 - LNP options
 - LNP subsystem application
 - Automatic call gapping
 - Triggerless LNP feature
 - Increasing the LRN and NPANXX Quantities on the EAGLE 5 SAS
 - Activating and Deactivating the LNP Short Message Service (SMS) feature
- The *Maintenance Manual* contains procedural information required for maintaining the EAGLE 5 SAS and the card removal and replacement procedures. The *Maintenance Manual* provides preventive and corrective maintenance procedures used in maintaining the different systems.
- The *Maintenance Pocket Guide* is an abridged version of the Maintenance Manual and contains all the corrective maintenance procedures used in maintaining the EAGLE 5 SAS.
- The *Maintenance Emergency Recovery Pocket Guide* is an abridged version of the Maintenance Manual and contains the corrective maintenance procedures for critical and major alarms generated on the EAGLE 5 SAS.
- The *MPS Platform Software and Maintenance Manual - EAGLE 5 SAS with Tekelec 1000 Application Server* describes the platform software for the Multi-Purpose Server (MPS) based on the Tekelec 1000 Application Server (T1000 AS) and describes how to perform preventive and corrective maintenance for the T1000 AS-based MPS. This manual should be used with the EPAP-based applications (EIR, G-Port, G-Flex, and INP).

Introduction

- The *MPS Platform Software and Maintenance Manual - EAGLE 5 SAS with Tekelec 1100 Application Server* describes the platform software for the Multi-Purpose Server (MPS) based on the Tekelec 1100 Application Server (T1100 AS) and describes how to perform preventive and corrective maintenance for the T1100 AS-based MPS. This manual should be used with the ELAP-based application (LNP).
- The *Provisioning Database Interface Manual* defines the programming interface that populates the Provisioning Database (PDB) for the EAGLE 5 SAS features supported on the MPS/EPAP platform. The manual defines the provisioning messages, usage rules, and informational and error messages of the interface. The customer uses the PDBI interface information to write his own client application to communicate with the MPS/EPAP platform.
- The *Previously Released Features Manual* summarizes the features of previous EAGLE, EAGLE 5 SAS, and IP⁷ Secure Gateway releases, and it identifies the release number of their introduction.
- The *Release Documentation* contains the following documents for a specific release of the system:
 - *Feature Notice* - Describes the features contained in the specified release. The Feature Notice also provides the hardware baseline for the specified release, describes the customer documentation set, provides information about customer training, and explains how to access the Customer Support website.
 - *Release Notice* - Describes the changes made to the system during the lifecycle of a release. The Release Notice includes Generic Program Loads (GPLs), a list of PRs resolved in a build, and all known PRs.
NOTE: The Release Notice is maintained solely on Tekelec's Customer Support site to provide you with instant access to the most up-to-date release information.
 - *System Overview* - Provides high-level information on SS7, the IP⁷ Secure Gateway, system architecture, LNP, and EOAP.
 - *Master Glossary* - Contains an alphabetical listing of terms, acronyms, and abbreviations relevant to the system.
 - *Master Index* - Lists all index entries used throughout the documentation set.
- The *System Manual – EOAP* describes the Embedded Operations Support System Application Processor (EOAP) and provides the user with procedures on how to implement the EOAP, replace EOAP-related hardware, device testing, and basic troubleshooting information.

Documentation Packaging and Updates



Customer documentation is updated whenever significant changes that affect EAGLE 5 SAS operation or configuration are made.

The document part number is shown on the title page along with the current revision of the document, the date of publication, and, if applicable, the software release that the document covers. The bottom of each page contains the document part number and the date of publication.

Documentation Admonishments

Admonishments are icons and text that may appear in this and other EAGLE 5 SAS manuals that alert the reader to assure personal safety, to minimize possible service interruptions, and to warn of the potential for equipment damage.

Following are the admonishments, listed in descending order of priority.

	<p>DANGER: (This icon and text indicate the possibility of <i>personal injury</i>.)</p>
	<p>CAUTION: (This icon and text indicate the possibility of <i>service interruption</i>.)</p>
	<p>WARNING: (This icon and text indicate the possibility of <i>equipment damage</i>.)</p>

Customer Care Center

The Customer Care Center offers a point of contact through which customers can receive support for problems that may be encountered during the use of Tekelec's products. The Customer Care Center is staffed with highly trained engineers to provide solutions to your technical questions and issues seven days a week, twenty-four hours a day. A variety of service programs are available through the Customer Care Center to maximize the performance of Tekelec products that meet and exceed customer needs.

To receive technical assistance, call the Customer Care Center at one of the following locations:

- Tekelec, UK
 - Phone: +44 1784 467 804
 - Fax: +44 1784 477 120
 - Email: ecsc@tekelec.com

Introduction

- Tekelec, USA

Phone (within the continental US) 888-367-8552 (888-FOR-TKLC)
(outside the continental US) +1 919-460-2150.

Email: support@tekelec.com.

When your call is received, the Customer Care Center issues a Customer Service Report (CSR). Each CSR includes an individual tracking number. When a CSR is issued, the Customer Care Center determines the classification of the trouble. The CSR contains the serial number of the system, problem symptoms, and messages. The Customer Care Center assigns the CSR to a primary engineer, who will work to solve the problem. The Customer Care Center closes the CSR when the problem is resolved.

If a critical problem exists, the Customer Care Center initiates emergency procedures (see the following topic, "Emergency Response").

Emergency Response

If a critical service situation occurs, the Customer Care Center offers emergency response twenty-four hours a day, seven days a week. The emergency response provides immediate coverage, automatic escalation, and other features to ensure a rapid resolution to the problem.

A critical situation is defined as an EAGLE 5 SAS or LSMS problem that severely affects service, traffic, or maintenance capabilities, and requires immediate corrective action. Critical problems affect service or system operation, resulting in:

- Failure in the system that prevents transaction processing
- Reduction in EAGLE 5 SAS capacity or in EAGLE 5 SAS traffic-handling capability
- Inability to restart the EAGLE 5 SAS
- Corruption of the database
- Inability to perform maintenance or recovery operations
- Inability to provide any required critical or major trouble notification
- Any other problem severely affecting service, capacity, traffic, and billing. Maintenance capabilities may be defined as critical by prior discussion and agreement with the Customer Care Center.

Maintenance and Administration Subsystem

The maintenance and administration subsystem consists of two processors, MASP (maintenance and administration subsystem processor) A and MASP B.

Each MASP is made up of two cards, the GPSM-II card (general purpose service module) and the TDM (terminal disk module).

The GPSM-II card contains the communications processor and applications processor and provides connections to the IMT bus. The GPSM-II controls the maintenance and database administration activity.

The TDM contains the fixed disk drive, the terminal processor for the 16 serial I/O ports and interfaces to the MDAL (maintenance disk and alarm) card which contains the removable cartridge drive and alarm logic. There is only one MDAL card in the maintenance and administration subsystem and it is shared between the two MASPs.

The procedures in the *Database Administration Manual – SS7* refer to the terms MASP and MDAL. The database commands, such as `rept-stat-db`, refer to the MASP because the MASP controls the input to the TDM and MDAL, and output from the TDM and MDAL. The MDAL is only referred to when inserting or removing the removable cartridge because the removable cartridge drive resides on the MDAL.

For more information on these cards, go to the *Hardware Manual - EAGLE 5 SAS*.

Database Partitions

The data that the EAGLE 5 SAS uses to perform its functions are stored in two separate areas: the fixed disk drives, and the removable cartridge. The Fixed Disk Drive section on page 1-12 and the Removable Cartridge section on page 1-13 describe these areas and data that is stored on them. These areas and their partitions are shown in Figure 1-1.

Figure 1-1. Database Partitions

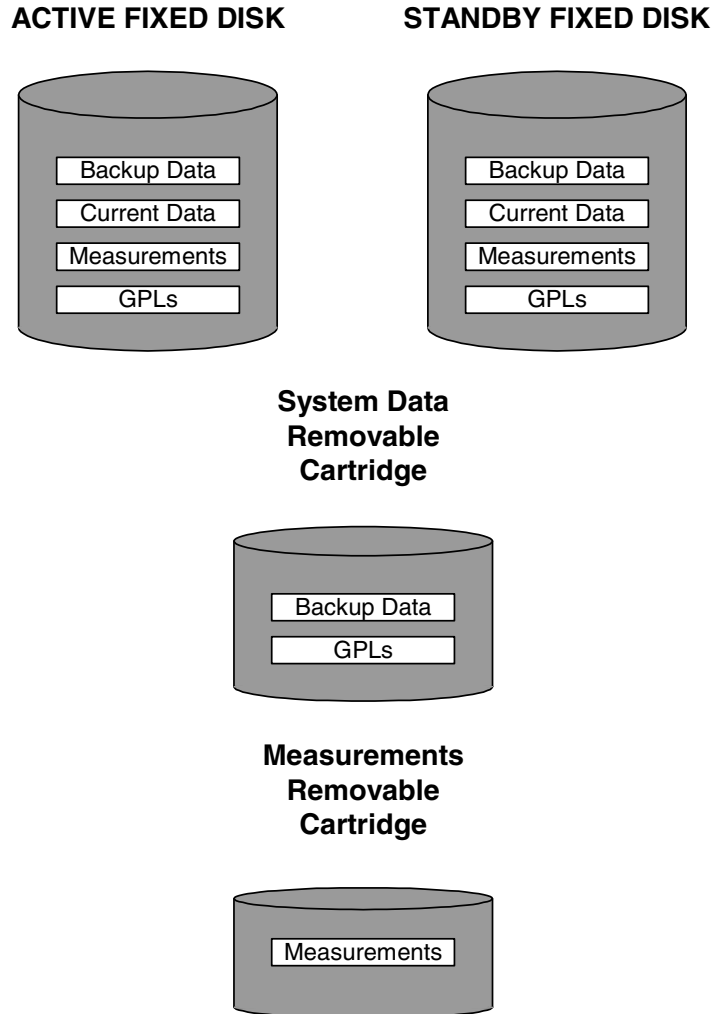

Fixed Disk Drive

There are two fixed disk drives on the EAGLE 5 SAS. The fixed disk drives contain the “master” set of data and programs for the EAGLE 5 SAS. The two fixed disk drives are located on the terminal disk modules (TDMs). Both disks have the same files. The data stored on the fixed disks is partially replicated on the various cards in the EAGLE 5 SAS. Changes made during database administration sessions are sent to the appropriate cards.

The data on the fixed disks can be viewed as four partitions.

- Current partition
- Backup partition
- Measurements partition
- Generic program loads (GPLs) partition

The data which can be administered by users is stored in two partitions on the fixed disk, a current database partition which has the tables which are changed by on-line administration, and a backup database partition which is a user-controlled copy of the current partition.

All of the on-line data administration commands effect the data in the current partition. The purpose of the backup partition is to provide the users with a means of rapidly restoring the database to a known good state if there has been a problem while changing the current partition.

A full set of GPLs is stored on the fixed disk in the GPL partition. There is an approved GPL and a trial GPL for each type of GPL in this set and a utility GPL, which has only an approved version. Copies of these GPLs are downloaded to the EAGLE 5 SAS cards. The GPL provides each card with its functionality. For example, the **ss7ansi** GPL provides MTP functionality for link interface modules (LIMs).

Measurement tables are organized as a single partition on the fixed disk. These tables are used as holding areas for the measurement counts.

Introduction

Removable Cartridge

A removable cartridge is used for two purposes.

- To hold an off-line backup copy of the administered data and system GPLs
- To hold a copy of the measurement tables

Because of the size of the data stored on the fixed disk drives on the TDMs, a single removable cartridge cannot store all of the data in the database, GPL, and measurements partitions.

To use a removable cartridge to hold the system data, it must be formatted for system data. To use a removable cartridge to hold measurements data, it must be formatted for measurements data. The EAGLE 5 SAS provides the user the ability to format a removable cartridge for either of these purposes. A removable cartridge can be formatted on the EAGLE 5 SAS by using the **format-disk** command. More information on the **format-disk** command can be found in the *Commands Manual*. More information on the removable cartridge drive can be found in the *Hardware Manual - EAGLE 5 SAS*.

The removable cartridge drive is located on the MDAL card in card location 1117.

Additional and preformatted removable cartridges are available from the Customer Care Center.

List of Acronyms and Abbreviations

AAL5CP	ATM Adaption Layer TYpe 5 Common Part
AATM.....	ATM Applique
ACM.....	Application Communications Module
ACM-ENET.....	Applications Communications Module with the Ethernet interface
ACT.....	Activate
ACTV	Active
AINF	Application Interface Appliquè
ALIASA	ANSI Alias Point Code
ALIASI.....	ITU International Alias Point Code
ALIASN.....	ITU National Alias Point Code
ALM.....	Alarm
ANSI	American National Standards Institute
APC.....	Adjacent Point Code
APCA.....	ANSI Adjacent Point Code
APCI.....	ITU International Adjacent Point Code
APCN.....	ITU National Adjacent Point Code
APPL.....	Application
AST.....	Associated State for Maintenance
ATM	Asynchronous Transfer Mode
ATMANSI	The application software for the ATM (high-speed) SS7 signaling links
ATMITU	The application software for the ITU ATM (high-speed) SS7 signaling links
ATMM	ATM Layer Management Module
ATMTSEL.....	ATM timing selector
BEI.....	Broadcast Exception Indicator
BOC.....	Byte Oriented Code
BPDCM.....	Application software for flash memory management on the DCM card
BPHCAP.....	Application software used by the application processor and the IMT processor of the LIMATM
BPS	Bits per Second or Bytes per Second

Introduction

BSN	Backward Sequence Number
C	Continue
CANC	Cancel
CAP.....	Capacity
CCS	Common Channel Signaling
CCS7ITU	The application software for the ITU SS7 (low-speed) signaling links
CHG.....	Change
CLLI.....	Common Language Location Identifier
CLP	Cell Loss Priority
Cmd Rej.....	Command Rejected
COO.....	Changeover Order Message
CPC.....	Capability Point Code
CPCA.....	ANSI Capability Point Code
CPCI.....	ITU International Capability Point Code
CPCN.....	ITU National Capability Point Code
CPCS.....	Common Part Convergence Sublayer
CPCTYPE	Capability Point Code Type
CRC.....	Cyclic Redundancy Check
CRMD.....	Cluster Routing and Management Diversity
DACT.....	Deactivate
DB.....	Database
DCE.....	Data Communication Equipment
DCM	Database Communication Module
DLT	Delete
DPC.....	Destination Point Code
DPCA.....	ANSI Destination Point Code
DPCI	ITU International Destination Point Code
DPCN	ITU National Destination Point Code
DS0A.....	Digital Signal Level - 0
DS1.....	Digital Signal Level - 1
DTE	Data Terminal Equipment

E1	European equivalent of the North American 1.544 Mbps T1 (Trunk Level 1) except that E1 carries information at 2.048 Mbps.
ECM	Error Correction Method
EIR.....	Equipment Identity Register
ELEI.....	Exception List Exclusion Indicator
EMDC	Element Measurement and Data Collection
ENT	Enter
EOAM.....	Enhanced Operations, Administration, and Maintenance
FAK	Feature Access Key
FAS	Frame Alignment Signal
FC	Flow control
FE.....	Far End
FIB	Forward Indicator Bit
FISU	Fill In Signal Unit
FPC.....	Provisioned full point code entry
FPCA.....	Full Point Code entry
FTA	File Transfer Area
FTP	File Transfer Protocol
GLS.....	Gateway Loading Services – Application software for the gateway screening loading services
GPL	Generic Program Load
GPSM.....	General Purpose Service Module
GTT	Global Title Translation
GWS	Gateway Screening
GWSA.....	Gateway Screening Application
GWSD.....	Gateway Screening Message Discard
GWSM	Gateway Screening Mode
HC MIM	High-Capacity Multi-Channel Interface Module
HEC.....	Header Error Control
HIPR	High-Speed IMT Packet Router
I/O	Input/Output
IAM.....	Initial Address Message

Introduction

ICMP	Internet Control Message Protocol
ID	Identity
IMT	Interprocessor Message Transport
INH	Inhibit
INIT	Initialize
IP	Internet Protocol
IPGWI	An ITU version of SS7IPGW application software
IPGWx	Point to multi-point IP ⁷ Secure Gateway application software, referring to SS7IPGW (ANSI) and IPGWI (ITU)
IPLIM	Application software for TCP/IP point-to-point connectivity for ANSI networks
IPLIMI	Application software for TCP/IP point-to-point connectivity for ITU networks
IPLIMx	Point to point IP ⁷ Secure Gateway application software, referring to IPLIM (ANSI) and IPLIMI (ITU)
IPS	Internet Protocol Services
IPSM	Internet Protocol Services Module
IS-NR	In Service - Normal
ISUP	ISDN User Part
ITU	International Telecommunications Union
ITU-I	ITU International
ITU-N	ITU National
LAN	Local Area Network
LBP	Loop Back Point
LC	Logical Channel
LCD	Loss of Cell Delineation
LED	Light Emitting Diode
LFS	Link Fault Sectionalization
LIM	Link Interface Module
LIMATM	LIM used with ATM (high-speed) signaling links
LIMCH	A LIM used as a channel card with either the E1 or T1 interfaces
LIMDS0	LIM with a DS0A interface

LIME1	LIM with an E1 Interface
LIME1ATM	LIM used with ITU ATM (high-speed) signaling links
LIMOCU.....	LIM with a OCU interface
LIMT1	LIM with a T1 interface
LIMV35.....	LIM with a V.35 interface
LINK	The signaling link on the LIM.
LLT	Latching LFS Test
LOC.....	Location
LOF	Loss of Frame
LOS.....	Loss of Signal
LNP	Local Number Portability
LPSET	ATM (high-speed) signaling link parameter set identifier
LS.....	Linkset
LSET NAME	The name of the linkset to which the signaling link is assigned.
LSMS.....	Local Service Management System
LSN	Linkset Name
LST	Linkset Type
LSSU.....	Link Status Signal Unit
MAAL.....	Management ATM Adaption Layer
MAP	Mated Application
MAS	Maintenance and Administration Subsystem
MASP.....	Maintenance and Administration Subsystem Processor
Mbyte.....	Megabyte
MDAL.....	Maintenance Disk and Alarm Card
MSAR.....	Memory Space Accounting Report
MSU	Message Signaling Unit
MTP.....	Message Transfer Part
MTP-1	Message Transfer Part Level 1
MTP-2	Message Transfer Part Level 2
NE	Near End
NCPC.....	New Capability Point Code

Introduction

NCPCA.....	New ANSI Capability Point Code
NCPCI	New ITU International Capability Point Code
NCPCN	New ITU National Capability Point Code
NEI.....	Network Element Interface
NLT	Non-latching LFS Test
OAP	Operations System Support/Applications Processor
OCU	Office Channel Unit
OOS.....	Out of Service
OOS-MT-DSBLD.....	Out of Service - Maintenance Disabled
OPC.....	Originating Point Code
PC.....	Point Code
PCA.....	ANSI Point Code
PCI	ITU International Point Code
PCN	ITU National Point Code
PCR.....	Preventive Cyclic Retransmission
PDS	Persistent Device States
PDU	Protocol Data Unit
PRTY	Parity
PST	Primary State for Maintenance
PTI.....	Payload Type Identification
PVC.....	Permanent Virtual Circuit
RCx	Signaling-Route-Set-Test for either a prohibited or restricted cluster network management message
REPT-STAT.....	Report Status
RLE.....	Remote Link Element
RLI.....	Remote Link Interface
RMV	Remove
RSP	Signaling-Route-Set-Test Signal for a prohibited destination network management message
RSR.....	Signaling-Route-Set-Test Signal for a restricted destination network management message
RST	Restore

RSx	Signaling-Route-Set-Test Signal for either a restricted destination or prohibited destination network management message
RTRV	Retrieve
SAAL	Signaling ATM Adaptation Layer
SCCP	Signaling Connection Control Part – Application software for the global title translation (GTT) feature
SCMG	SCCP Management
SCRN	Screen Set Name
SCRSET	Screen Set
SDU	Service Data Unit
SEAC	Signaling Engineering and Administration Center
SEAS	Signaling Engineering and Administration System
Si	International Usage Spare Bit
SIE	Status Indication Emergency Alignment
SIN	Status Indication Normal Alignment
SIO	Status Indication Out of Alignment or Service Information Octet
SIOS	Status Indication Out of Service
SIPO	Status Indication Process Outage
SLC	Signaling Link Code
SLK	Signaling Link
SLS	Signaling Link Selector
SLSCI	5- to 8-bit SLS Conversion Indicator
SLSCNV	SLS Conversion
SLTC	Signaling Link Test Control
SMF	Sub-Multi-Frames
Sn	National Usage Spare Bit
SNCC	Signaling Network Control Center
SS7	Signaling System #7
SS7 ADDR	The dummy X.25 address assigned to the SS7 destination entity on the SS7 side of the circuit
SS7 DPC	SS7 Destination Point Code

Introduction

SS7ANSI.....	The application software for the ANSI SS7 signaling links
SS7IPGW.....	The application software for IP ⁷ signaling gateway feature point-to-multipoint connectivity
SS7GX25.....	The application software for the X.25/SS7 gateway feature
SSA.....	Subsystem Allowed network management message
SSCF.....	Service Specific Coordination Function
SSCOP.....	Service Specific Coordination Oriented Protocol
SSCS.....	Service Specific Convergence Sublayer
SSN.....	SS7 Subsystem Number
SSP.....	Subsystem Prohibited network management message
SST.....	Secondary State for Maintenance
SST.....	Subsystem Status Test network management message
STDBY.....	Standby
STP.....	Signal Transfer Point
STP LAN.....	Feature that copies MSUs selected through the gateway screening process and sends these MSUs over the Ethernet to an external host computer for further processing
STPLAN.....	Application software for the STP LAN feature
SUERM.....	Signal Unit Error Rate Monitor
T1.....	Trunk Level 1
TCA.....	Transfer Cluster Allowed network management message
TCAP.....	Transaction Capability Application Part
TCP.....	Transmission Control Protocol
TCP/IP.....	Transmission Control Protocol/Internet Protocol
TCR.....	Transfer Cluster Restricted network management message
TCx.....	Either a Transfer Cluster Allowed, Transfer Cluster Restricted, or Transfer Cluster Prohibited network management message
TDM.....	Terminal Disk Module
TFA.....	Transfer Allowed network management message
TFC.....	Transfer Controlled network management message

TFATCABMLQ.....	TFA/TCA broadcast minimum link quantity
TFATFRPR.....	TFA/TFR pacing rate
TFP	Transfer Prohibited network management message
TFR.....	Transfer Restricted network management message
TFx.....	Either a Transfer Allowed, Transfer Controlled, Transfer Restricted, or Transfer Prohibited network management message
TPC.....	True Point Code
TRA.....	Traffic Restart Allowed
TRM	Terminal
TRW	Traffic Restart Waiting
TSET	Transmitter Signaling Element Timing
TSM.....	Translation Services Module
TT	Translation Type
TVG.....	Group Ticket Voucher feature
UAL.....	SEAS User Application Layer
UAM.....	Unsolicited Alarm Message
UDTS.....	Unit Data Transfer Service
UID.....	User ID
UIM.....	Unsolicited Information Message
UIMRD	UIM Redirect
UNHB.....	Uninhibit
VCC.....	Virtual Channel Connections
VCI.....	Virtual Channel Identifier
VPI.....	Virtual Path Identifier
VXWSLAN	STP LAN feature application for DCMs
X-list.....	Exception list of non-provisioned members of provisioned cluster.

Configuring Destination Tables

Introduction.....	2-2
Point Code Formats.....	2-4
14-Bit ITU National Point Code Formats	2-10
ITU National Duplicate Point Codes	2-16
Changing the DPC Quantity	2-23
Activating the ITU National and International Spare Point Code Support Feature	2-42
Multiple Point Code Support.....	2-55
Adding a Secondary Point Code	2-63
Removing a Secondary Point Code	2-74
Adding a Point Code to the Self-Identification of the EAGLE 5 SAS.....	2-81
Changing the Self-Identification of the EAGLE 5 SAS.....	2-90
Cluster Routing and Management Diversity (CRMD)	2-119
Nested Cluster Routing	2-135
Adding a Cluster Point Code.....	2-142
Changing the Attributes of a Cluster Point Code.....	2-161
Network Routing.....	2-174
Adding a Network Routing Point Code	2-181
Adding a Destination Point Code	2-191
Removing a Destination Point Code.....	2-214
Changing a Destination Point Code	2-226
Changing the Group Code Assigned to an ITU National Point Code.....	2-248

Introduction

The SS7 network configuration for the EAGLE 5 SAS requires linksets and routes. These entities use point codes, and these point codes must be defined in the destination point code table of the database. A destination is a node in any network that is uniquely identified by a point code in conjunction with a network indicator. The destination is always the node's true point code.

The EAGLE 5 SAS supports three types of networks and nodes to carry SS7 traffic, using TCP/IP technology:

- ANSI
- ITU International (ITU-I)
- ITU National (ITU-N)

When nodes in different networks wish to communicate, each node must have its own true point code and an alternate point code for each of the network types involved. For example, if node 1 in an ANSI network, node 2 in an ITU-N network, and node 3 in an ITU-I network wish to communicate with each other, node 1 must have an ANSI true point code and one alternate point code each for the ITU-N and ITU-I network. Node 2 must have an ITU-N true point code and one alternate point code each for the ANSI and ITU-I network. Node 3 must have an ITU-I true point code and one alternate point code each for the ANSI and ITU-N network.

Figure 2-1 shows an example of a mixed network with ANSI, ITU-I, and ITU-N nodes. Each node has one true point code and two alternate point codes.

Figure 2-1. Mixed Network with ANSI, ITU-I, and ITU-N Nodes

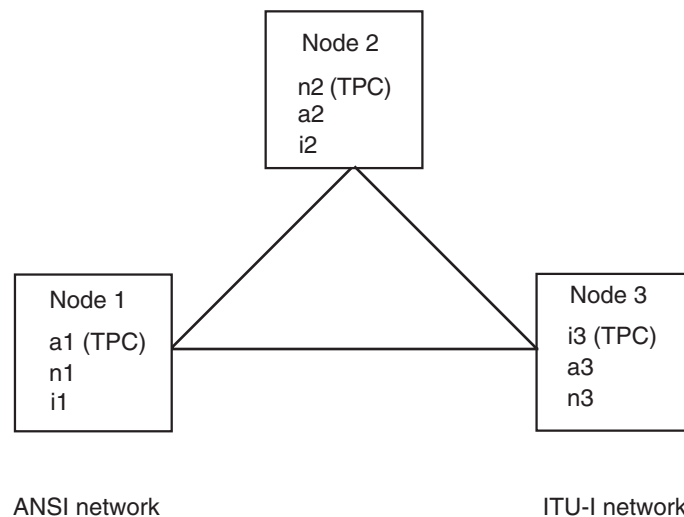

Configuring Destination Tables

The node's true point code is also called the destination point code.

This chapter discusses the method for configuring destination point codes (DPCs) in the database of the EAGLE 5 SAS. Destination point codes can be one of four types:

- Full point codes used for SS7 routing. A full point code is a point code containing numbers in each portion of the point code, for example, 111-011-100. The full point code can be in one of three formats, ANSI, ITU international, or ITU national. See the "Point Code Formats" section on page 2-4 for more information on the point code formats. The EAGLE 5 SAS must have a full point code for each network type (ANSI, ITU-N, ITU-I) it is connected to.
- Secondary point codes, used by the Multiple Point Code Support feature. A secondary point code is a point code assigned to a full point code and used as if they were the actual EAGLE 5 SAS point code. Secondary point codes can be in one of three formats: ANSI, ITU international, or ITU national. The format of the secondary point code must be the same as the format of the full destination point code. See the "Multiple Point Code Support" section on page 2-55 for more information on secondary point codes.
- Cluster destination point codes, used by the cluster routing and management (CRMD) feature and nested cluster routing feature. A cluster point code is an ANSI point code containing numbers in the network identifier and network cluster portions of the point code, and an asterisk (*) in the network cluster member field of the point code, for example, 111-011-*. See the "Cluster Routing and Management Diversity (CRMD)" section on page 2-119 and the "Nested Cluster Routing" section on page 2-135 for more information on cluster point codes.
- Network routing point codes, used by the network routing feature. A network routing point code is an ANSI point code containing a number in the network identifier portion of the point code, and asterisks (*) in the network cluster and network cluster member portions of the point code, for example, 111-*-*. See the "Network Routing" section on page 2-174 for information on network routing point codes.

The Cluster Routing and Management Diversity (CRMD) feature, the nested cluster routing feature, the multiple point code support feature, and the network routing features are also discussed in this section.

In order to complete the definition of linksets, and routes and X.25 destinations, destination point codes are required to be in the database. Even though linksets use adjacent point codes, the adjacent point code of a linkset must be defined in the destination point code table of the database.

The procedures shown in this chapter use a variety of commands. If more information on these commands is needed, go to the *Commands Manual* to find the required information.

Point Code Formats

The EAGLE 5 SAS supports three different point code formats:

- ANSI point codes
- ITU International point codes
- ITU National point codes (both 14-bit ITU-N point codes and 24-bit ITU-N point codes).

ANSI Point Codes

ANSI point codes are made up of three groups of digits called the network indicator (NI), network cluster (NC), and network cluster member (NCM). The values for ANSI point codes depends on the value of the `pctype` parameter of the `chg-sid` command, either `ansi` or `other`. If the `pctype` parameter is set to `ansi`, the ANSI rules for the ANSI point code are used to define the point code. The range of values for an ANSI point code with the `pctype=ansi` parameter are:

NI – 001-255
 NC – 001-255 (if ni = 001-005)
 000-255, * (if ni = 006-255)
 NCM – 000-255, *

The `pctype=other` parameter specifies that the ANSI point codes do not meet ANSI standards. The range of values for ANSI point codes with the `pctype=other` parameter are:

NI – 000-255
 NC – 000-255, *
 NCM – 000-255, *

The asterisk (*) point code value indicates a single cluster address for a cluster point code (for example, `20-2-*`) or a network routing destination (`21-*-*`). for more information on cluster point codes, see “Cluster Routing and Management Diversity (CRMD)” section on page 2-119. For more information on network routing point codes, see “Network Routing” section on page 2-174.

A double asterisk (**) and triple asterisk (***) can also be used for the NC and NCM fields of the ANSI point code, but for only the `rtrv-dstn` and `rept-stat-dstn` commands.

A double asterisk in the NCM field of a cluster point code produces a summary report that shows all point code destinations residing in the given cluster (`20-2-**`). This does not include the specified cluster point code. The following example is a report generated using two asterisks in the NCM field of a cluster point code.

Configuring Destination Tables

rtrv-dstn:dpca=20-2-**

```
rlghncxa03w 05-09-28 21:16:37 GMT EAGLE5 34.0.0
  DPCA          CLLI          BEI  ELEI  ALIASI          ALIASN/N24  DOMAIN
  020-002-045  rlghncbb100 no  ---  -----  -----  SS7
  020-002-050  rlghncbb100 no  ---  -----  -----  SS7
```

Destination table is (11 of 2000) 1% full

Alias table is (5 of 8000) 1% full

RTRV-DSTN: MASP A - COMPLTD

A double asterisk in the NC field of a network routing point code produces a summary report that shows all point code destinations that are members of the given network (21-**-*). This does not include the specified network routing point code. The following example is a report generated using two asterisks in the NC field of a network routing point code.

rtrv-dstn:dpca=21-***

```
rlghncxa03w 05-09-28 21:16:37 GMT EAGLE5 34.0.0
  DPCA          CLLI          BEI  ELEI  ALIASI          ALIASN/N24  DOMAIN
  021-002-045  rlghncbb101 no  ---  -----  -----  SS7
  021-002-050  rlghncbb101 no  ---  -----  -----  SS7
```

Destination table is (11 of 2000) 1% full

Alias table is (5 of 8000) 1% full

RTRV-DSTN: MASP A - COMPLTD

Three asterisks in the NCM field of a cluster point code produces a summary report that shows all point code destinations residing in the given network cluster along with the specified cluster point code. The following example is a report generated using three asterisks in the NCM field of a cluster point code.

rtrv-dstn:dpca=20-2-***

```
rlghncxa03w 05-09-17 16:00:32 GMT EAGLE5 34.0.0
  DPCA          CLLI          BEI  ELEI  ALIASI          ALIASN/N24  DOMAIN
  020-002-*    rlghncbb000 no  ---  -----  -----  SS7
  020-002-045  rlghncbb100 no  ---  -----  -----  SS7
  020-002-050  rlghncbb100 no  ---  -----  -----  SS7
```

Destination table is (11 of 2000) 1% full

Alias table is (5 of 8000) 1% full

RTRV-DSTN: MASP A - COMPLTD

Three asterisks in the NC field of the point code produces a summary report that shows all point code destinations residing in the given network along with the specified network routing point code. The following example is a report generated using three asterisks in the NC field of a network routing point code.

```

rtrv-dstn:dPCA=21-***-*

rlghncxa03w 05-09-17 16:00:32 GMT EAGLE5 34.0.0
  DPCA          CLLI          BEI  ELEI  ALIASI          ALIASN/N24  DOMAIN
  021-***      rlghncbb001 yes  yes  -----  -----  SS7
  021-002-045  rlghncbb101 no   ---  -----  -----  SS7
  021-002-050  rlghncbb101 no   ---  -----  -----  SS7

Destination table is (11 of 2000) 1% full
Alias table is (5 of 8000) 1% full
RTRV-DSTN: MASP A - COMPLTD
  
```

The following rules apply to provisioning ANSI point code if the **pctype=ansi** parameter is specified with the **chg-sid** command:

- The NI value of 0 is not allowed (for example, **dpc=0-1-1** and **dpc=0-0-0** are not valid point codes).
- If the NI value is 1, 2, 3, 4, or 5, then the nc value cannot be 0 (for example, **dpc=5-0-1** is rejected).
- If the NI value is 1, 2, 3, 4, or 5, then network routing point codes are not allowed (for example, **dpc=4-***** is rejected).

The following rules apply to provisioning ANSI point code if the **pctype=other** parameter is specified with the **chg-sid** command:

- The NI value of 0 is allowed, however **dpc=0-0-0** is rejected (for example, **dpc=0-1-1** is accepted).
- The NC value can be 0 for all values of NI (for example, **dpc=5-0-1** is accepted).
- Network routing point codes are allowed for all values of ni (for example, **dpc=4-***** is accepted).

An ANSI point code containing all zeros is not a valid point code and cannot be entered into the database.

ITU International Point Codes

The ITU international point codes are made up of three groups of digits called zone, area, and id. The range of values for ITU International point codes are:

```

ZONE – 0-7
AREA – 000-255
ID – 0-7
  
```

An ITU international point code containing all zeros is not a valid point code and cannot be entered into the database.

14-Bit ITU National Point Codes

The 14-bit ITU national point code is either a 1- to 5-digit number, or 2, 3, or 4 numbers separated by dashes. 14-bit ITU national point codes can also have group codes assigned to them if the ITU National Duplicate Point Code feature is on. The group code is a two-character field ranging from AA to ZZ that is entered as the last subfield of a 14-bit ITU national point code and is separated by a dash from the rest of the point code. If the ITU National Duplicate Point Code feature is on, the format of a 14-bit ITU national point code is either a 1- to 5-digit number with a group code (for example, 11567-aa), or 2, 3, or 4 numbers separated by dashes with a group code (for example, 5-15-10-3-aa).

For more information on the format of 14-bit ITU national point code formats, see the “14-Bit ITU National Point Code Formats” section on page 2-10.

For more information on the ITU National Duplicate Point Code feature and group codes, see the “ITU National Duplicate Point Codes” section on page 2-16.

24-Bit ITU National Point Codes

A 24-bit ITU national point code is made up of three segments separated by dashes. Each segment contains three digits and corresponds to 8 bits of the point code. The range of values for 24-bit ITU national point codes are:

Main Signaling Area (MSA) – 000-255

Sub Signaling Area (SSA) – 000-255

Signaling Point (SP) – 000-255

A 24-bit ITU international point code containing all zeros is not a valid point code and cannot be entered into the database.

Spare Point Codes

The provisioning of spare point codes allows the EAGLE 5 SAS to process messages that contain either the International Spare or National Spare network indicator values. Spare point codes can be provisioned only if the ITU National and International Spare Point Code (PC) Support feature is enabled. Only ITU-I and 14-bit ITU-N point codes can be provisioned as spare point codes.

Spare point codes are shown with the prefix “s-” with the point code value. This allows the destination point code table to contain two point code entries with the same value, one a spare point code and one a non-spare point code. For example, the destination point code table contains these point code entries, 2-034-5 and s-2-034-5. Point code 2-034-5 is a non-spare ITU-I point code and point code s-2-034-5 is a spare ITU-I point code.

Private Point Codes

Private point codes are used for internal routing in the EAGLE 5 SAS. Private point codes can be used for internal point codes for the End Office feature, and for adjacent point codes for IPGWx linksets.

Private point codes are shown with the prefix “p-” with the point code value. This allows the destination point code table to contain two point code entries with the same value, one private and one not private. For example, the destination point code table contains these point code entries, 002-002-002 and p-002-002-002. Point code 002-002-002 is a non-private point code that is used for configuring linksets and routes from the EAGLE 5 SAS to external nodes in the network. Point code p-002-002-002 is a private point code and is not known to the external nodes in the network.

By using private point codes for internal routing, these point code values are not known outside of the EAGLE 5 SAS and do not use a point code value for network configuration.

There can be private point codes for all point code types: ANSI, ITU-I, ITU-I Spare, 14-bit ITU-N, 14-bit ITU-N Spare, and 24-bit ITU-N.

Point Code Usage

The ANSI are used in ANSI networks. The ITU international point codes are used in ITU international networks. The ITU national point codes are used in ITU national networks. ITU national point codes can be either 14-bit ITU national point codes, or 24-bit ITU national point codes. Table 2-1 shows a sample destination point code for each type of network.

Table 2-1. Point Code Format

Network Type	Point Code Format
ANSI	001-002-003
ITU International	7-255-7
14-bit ITU National	See “14-Bit ITU National Point Code Formats” on page 2-10
24-bit ITU National	001-002-003

To enter an ITU international point code, a 14-bit ITU national point code or a 24-bit ITU national point code, either as a DPC or as an alias point code, the self ID of the EAGLE 5 SAS must be defined for these networks. Verify this with the `rtrv-sid` command. If point code values are shown in the `PCI` field of the output of the `rtrv-sid` command, then ITU international point codes can be entered. If point code values are shown in the `PCN` field of the output of the `rtrv-sid` command, then the 14-bit ITU national point codes can be entered. If point code values are shown in the `PCN24` field of the output of the `rtrv-sid` command, then 24-bit ITU national point codes can be entered. If a value is shown in the `PCN` field, then a value cannot be entered in the `PCN24` field. If a value is shown in the `PCN24` field, then a value cannot be entered in the `PCN` field.

Configuring Destination Tables

A destination is defined with a mandatory true point code of one format, and two optional alias point codes that are of the other two formats. Alias point codes are used to provide alternate point codes for a particular destination. The true point code must be of the same format as the point code used for the self ID of the EAGLE 5 SAS and must match the format of the point code used for the destination node. For example, if the destination node uses an ANSI point code, then the true point code must be an ANSI point code.

A destination can have up to two alias point codes. A destination alias point code type must not match that destination's true point code type. If both alias point codes are defined, the point code types of the aliases must not match.

The point code type (ANSI, ITU international, ITU national) is specified by different parameters. A letter that indicates the point code type is appended to the parameter that specifies the point codes. The appended letters are as follows.

“A” – indicates an ANSI point code, for example, `dpca`

“I” – indicates an ITU international point code, for example, `dpci`

“N” – indicates a 14-bit ITU national point code, for example, `dpcn`

“N24” – indicates a 24-bit ITU national point code, for example, `dpcn24`

The ANSI point codes can also be specified by a point code parameter without the letter “A” appended to it, for example, `dp`.

14-Bit ITU National Point Code Formats

The format of a 14-bit ITU national point code is defined by the **npcfmti** parameter of the **chg-stpopts** command. This parameter defines how the 14-bit ITU national point code is entered into the database, and how it is displayed in any EAGLE 5 SAS outputs (command outputs or unsolicited outputs).

The 14-bit ITU national point code can be either a single number, up to five digits, or two, three, or four numbers separated by dashes. The 14-bit ITU national point code is a 14-bit integer. The values used by the **npcfmti** parameter of the **chg-stpopts** command defines the number of bits that make up each part of the point code format, if the 14-bit ITU national point code is made up of two, three, or four numbers.

If the 14-bit ITU national point code format has less than four numbers, the parts of the point code format not being used must be specified as zero (0). All four parts of the point code format must be specified with the **npcfmti** parameter, no matter how many numbers the point code format will contain, and the sum of the values of all four parts of the point code format must be 14 (for example, **NPCFMTI=7-7-0-0**, **NPCFMTI=0-6-8-0**, **NPCFMTI=0-0-4-10**, **NPCFMTI=3-8-3-0**, **NPCFMTI=14-0-0-0**).

If the database contains 14-bit ITU national point codes of a particular format, and the format is changed with the **npcfmti** parameter of the **chg-stpopts** command, the format of the 14-bit ITU national point codes in the database will be changed to the new format.

The values of the parts of the 14-bit ITU national point code are defined in Table 2-2 on page 2-11.

Configuring Destination Tables

Table 2-2. 14-Bit ITU National Point Code Values

NPCFMTI Parameter Values	0	1	2	3	4
Range of Values	The segment is not used.	0-1	0-3	0-7	0-15
NPCFMTI Parameter Values	5	6	7	8	9
Range of Values	0-31	0-63	0-127	0-255	0-511
NPCFMTI Parameter Values	10	11	12	13	14
Range of Values	0-1023	0-2047	0-4095	0-8191	0-16383

A 14-bit ITU national point code containing all zeros is a valid point code and can be entered into the database.

When the EAGLE 5 SAS is delivered to the user, the format of the 14-bit ITU national point code is set to 14-0-0-0 (a single number containing up to five digits). If the 14-bit ITU national point code is a single number, the value of the point code is from 1 to 16383.

To change the format of a 14-bit ITU national point code, execute the “Changing the Format of 14-Bit ITU National Point Codes” procedure on page 2-12. The example used in this procedure changes the format of the 14-bit ITU national point code from 14-0-0-0 to 4-4-4-2.

Changing the Format of 14-Bit ITU National Point Codes

Procedure



CAUTION: Changing the formats of the 14-bit ITU national point codes will change how any existing 14-bit ITU national point codes are displayed in the database.

1. Display the existing values for the `npcfmti` parameter by entering the `rtrv-stpopts` command. The value for the `npcfmti` parameter is shown in the `NPCFMTI` field. This is an example of the possible output.

```
rlghncxa03w 05-09-17 16:02:05 GMT EAGLE5 34.0.0
STP OPTIONS
-----
NPCFMTI      14-0-0-0
```

NOTE: The `rtrv-stpopts` command output contains other fields that are not used by this procedure. If you wish to see all the fields displayed by the `rtrv-stpopts` command, see the `rtrv-stpopts` command description in the *Commands Manual*.

2. Change the value of the `npcfmti` parameter. For this example, enter this command.

```
chg-stpopts:npcfmti=4-4-4-2
```

When this command has successfully completed, this message should appear.

```
rlghncxa03w 05-09-07 00:22:57 GMT EAGLE5 34.0.0
CHG-STPOPTS: MASP A - COMPLTD
```

NOTE: The parameters of the `chg-stpopts` command are optional. For any parameters not specified with the `chg-stpopts` command, the values for these parameters are not changed.

3. Verify the changes using the `rtrv-stpopts` command. This is an example of the possible output.

```
rlghncxa03w 05-09-17 16:02:05 GMT EAGLE5 34.0.0
STP OPTIONS
-----
NPCFMTI      4-4-4-2
```

NOTE: The `rtrv-stpopts` command output contains other fields that are not used by this procedure. If you wish to see all the fields displayed by the `rtrv-stpopts` command, see the `rtrv-stpopts` command description in the *Commands Manual*.

4. Back up the new changes, using the `chg-db:action=backup:dest=fixed` command. These messages should appear; the active Maintenance and Administration Subsystem Processor (MASP) appears first.

```
BACKUP (FIXED) : MASP A - Backup starts on active MASP.  
BACKUP (FIXED) : MASP A - Backup on active MASP to fixed disk complete.  
BACKUP (FIXED) : MASP A - Backup starts on standby MASP.  
BACKUP (FIXED) : MASP A - Backup on standby MASP to fixed disk complete.
```

Flowchart 2-1. Changing the Format of an ITU National Point Code

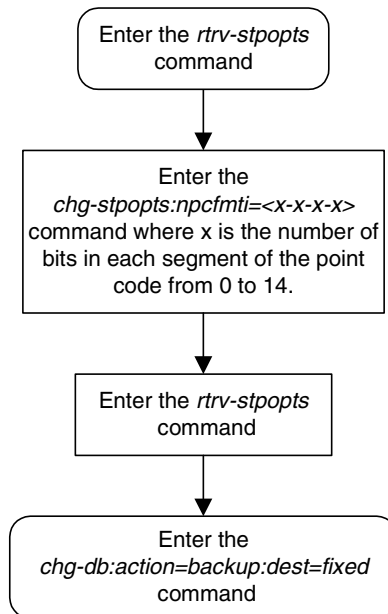

Examples of Different 14-Bit ITU National Point Code Formats

A 14-bit ITU national point code whose format is 3-8-3-0, results in a point code containing three numbers separated by dashes. Because the fourth part of the format is zero, the point code format contains only three numbers. Using Table 2-2 as a guide, the range of values for this point code format are from 0-000-1 to 7-255-7.

A 14-bit ITU national point code whose format is 2-8-3-1, results in a point code containing four numbers separated by dashes. Using Table 2-2 as a guide, the range of values for this point code format are from 0-000-0-1 to 3-255-7-1.

A 14-bit ITU national point code whose format is 7-0-7-0 results in a point code containing two numbers separated by dashes. Because the second and fourth parts of the format are zero, the point code format contains only two numbers. Using Table 2-2 on page 2-11 as a guide, the range of values for this point code format are from 000-001 to 127-127.

A 14-bit ITU national point code whose format is 14-0-0-0 results in a point code containing a single number, containing up to five digits. Using Table 2-2 as a guide, the range of values for this point code format are from 1 to 16383.

Exception

The format defined by the `npcfmt` parameter of the `chg-stpopts` command applies to all database entities that use 14-bit ITU national point codes, except gateway screening. Gateway screening allows the 14-bit ITU national point code to be displayed and entered in the database only as a single number. If the EAGLE 5 SAS is using a format for the 14-bit ITU national point code other than a single number, the point code will have to be converted from its current format to a single number in order to be used by gateway screening.

Converting Single Number 14-Bit ITU National Point Codes

To convert a single number ITU national point code to a multiple part ITU national point code, perform these steps. For this example, the 14-bit ITU national point codes 14781 and 695 are converted to point codes using the 3-8-3-0 format.

1. The point code is converted to a binary number. This can be done with most scientific calculators.
 - a. The number 14781 converts to the binary number 11100110111101.
 - b. The number 695 converts to the binary number 1010110111.

NOTE: Make sure the binary number contains 14 digits. If it does not, add leading zeros to the binary number to bring the total number of digits in the number to 14.

In this example, the binary equivalent for the decimal number 695 (1010110111) contains 10 digits, so four zeros must be added to the beginning of the binary number. The resulting binary number is now 00001010110111.

2. Divide the binary number into the number of parts required by the format of the 14-bit ITU national point code. For this example, the format is 3-8-3-0. Since the last part of the point code format is 0, the point code format contains only three parts. Divide the point code into three parts: the first part of the point code contains the first three digits of the 14-digit binary number, the second part of the point code contains the next eight digits of the 14-digit binary number, and the third part of the point code contains the last three digits of the 14-digit binary number.

For this example, the binary numbers would be divided like this:

- a. 11100110111101 = 111 00110111 101
- b. 00001010110111 = 000 01010110 111

Configuring Destination Tables

3. Convert each part of the point code into a decimal number, using the same scientific calculator used in step 1, and separate each part of the point code with dashes. The results are as follows.
 - a. 111 00110111 101 = 7-55-5
 - b. 000 01010110 111 = 0-86-7

When the 14-bit ITU national point codes are converted from single numbers to multiple-part point codes, the resulting value of the multiple-part point code depends on the point code format specified by the `npcfmt` parameter of the `chg-stpopts` command. When converting the single-number point code 14781 to the point code format 3-8-3-0, the resulting point code value is 7-55-5. If point code 14781 is converted to the point code format 4-4-4-2, the resulting point code value is 14-6-15-1.

Converting Multiple-Part 14-Bit ITU National Point Codes

To convert multiple-part 14-bit ITU national point codes to a single number, perform these steps. For this example, the 14-bit ITU national point codes 7-55-5 and 0-86-7, using the 3-8-3-0 point code format, are converted into a single number.

1. Convert each part of the point code into a binary number using a scientific calculator. The results are as follows.
 - a. 7-55-5 = 111 00110111 101
 - b. 0-86-7 = 000 01010110 111
2. Combine each part of the point code into a single binary number as follows.
 - a. 111 00110111 101 = 11100110111101
 - b. 000 01010110 111 = 00001010110111

NOTE: If the binary number has any zeros at the beginning of the number, remove these zeros, as they are not necessary.

In this example, the binary equivalent for the point code 0-86-7 (00001010110111) contains four zeros at the beginning of the binary number. When the leading zeros are removed from the binary number, the resulting binary number is now 1010110111.

3. Convert the binary number to a decimal number using the same scientific calculator used in step 1.
 - a. The binary number 11100110111101 converts to the decimal number 14781.
 - b. The binary number 1010110111 converts to the decimal number 695.

ITU National Duplicate Point Codes

NOTE: This feature applies only to 14-bit ITU national spare and non-spare point codes.

This feature allows an EAGLE 5 SAS mated pair to route traffic for two or more countries that may have overlapping point code values. For example, in the network shown in Figure 2-2, both Country 1 and Country 2 have SSPs with a PC value of 2047.

Figure 2-2. Network Example #1

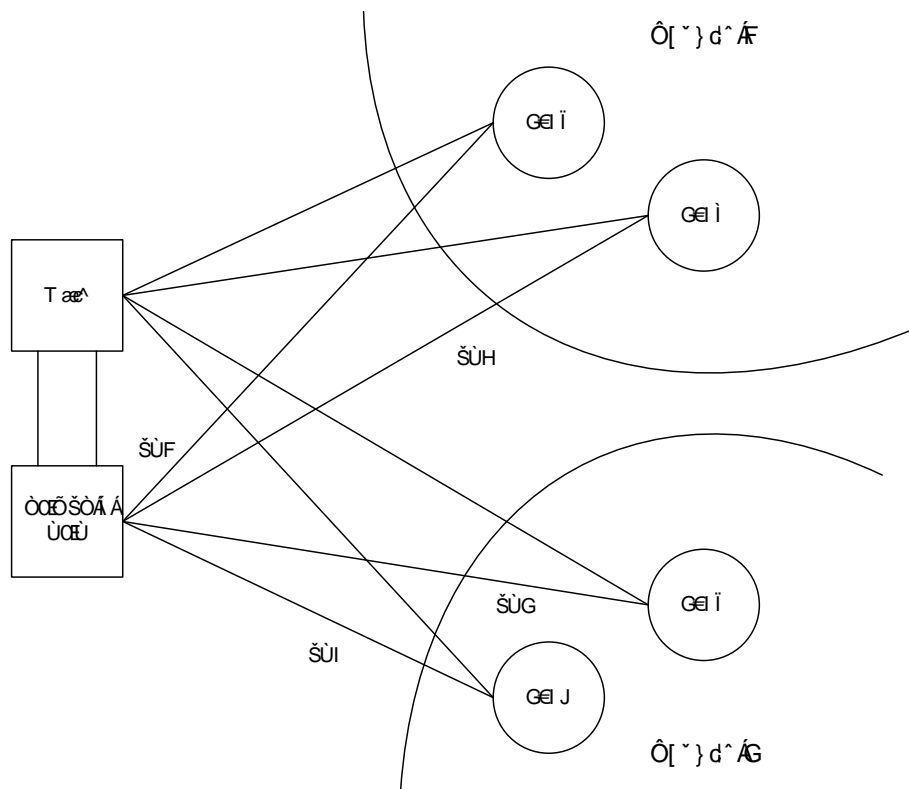

Group Codes

Users must divide their ITU-National destinations into groups. These groups will likely be based on Country. However, one group could have multiple countries within it, or a single country could be divided into multiple groups. The requirements for these groups are:

- No duplicate point codes are allowed within a group.
- ITU-National traffic from a group must be destined for a PC within the same group.
- The user must assign a unique two-letter group code to each group.

Configuring Destination Tables

For example, in the network shown in Figure 2-2 on page 2-16, Country 1 can only have 1 point code with a value of 2047. Traffic coming from SSP 2047 in Country 1 can only be destined to other nodes within Country 1. In this example, the user assigns a group code of 1 to Country 1, and a group code of 2 to Country 2.

When the user enters an ITU-National point code, they must also enter the group code, using the format "point code - group code". This group code must be used for any command that uses an ITU-N point code.

For example, to provision the EAGLE 5 SAS for the network shown in Figure 2-2 on page 2-16, the user would enter these commands:

```
ent-dstn:dpcn=2047-aa
ent-dstn:dpcn=2048-aa
ent-dstn:dpcn=2047-ab
ent-dstn:dpcn=2049-ab
ent-ls:lsn=LS1:apcn=2047-aa
ent-ls:lsn=LS2:apcn=2047-ab
ent-ls:lsn=LS3:apcn=2048-aa
ent-ls:lsn=LS4:apcn=2049-ab
```

Group Code aa

The following special rules apply to group code aa:

- ITU-N MSUs received on an ITU-I linkset are assigned group code of aa.
- ITU-N destinations entered before this feature is turned on are assigned group code of aa when the ITUDUPPC feature bit is turned on.

Normal Operation

When an ITU-N message arrives at the EAGLE 5 SAS, the EAGLE 5 SAS creates an internal point code based on the 14 bit PC in the message, and the group code assigned to the incoming linkset.

For example, when a message arrives on LS3 with DPC of 2047, the EAGLE 5 SAS maps that to an internal point code of 2047-aa, because LS3 has a group code of aa. The EAGLE 5 SAS then routes the message to LS1, which is the route for 2047-aa.

When a message arrives on LS4 with DPC of 2047, the EAGLE 5 SAS maps that to an internal point code of 2047-ab, because LS4 uses group code ab. The EAGLE 5 SAS then routes the message to LS2, which is the route for 2047-ab.

C Linksets

For each group defined, a separate C-linkset must be defined. This C-linkset is used as the alternate route for point codes in the group.

For example, in Figure 2-3, LSC1 is used for point codes in Group fr. Its adjacent point code is 6201-fr, and is used as the alternate route for 6217-fr, 6218-fr, and 6223-fr.

LSC2 is used for point codes in Group ge. Its adjacent point code is group 4169-ge, and is used as the alternate route for 6200-ge, 6209-ge, and 6217-ge.

Figure 2-3. Network Example #2

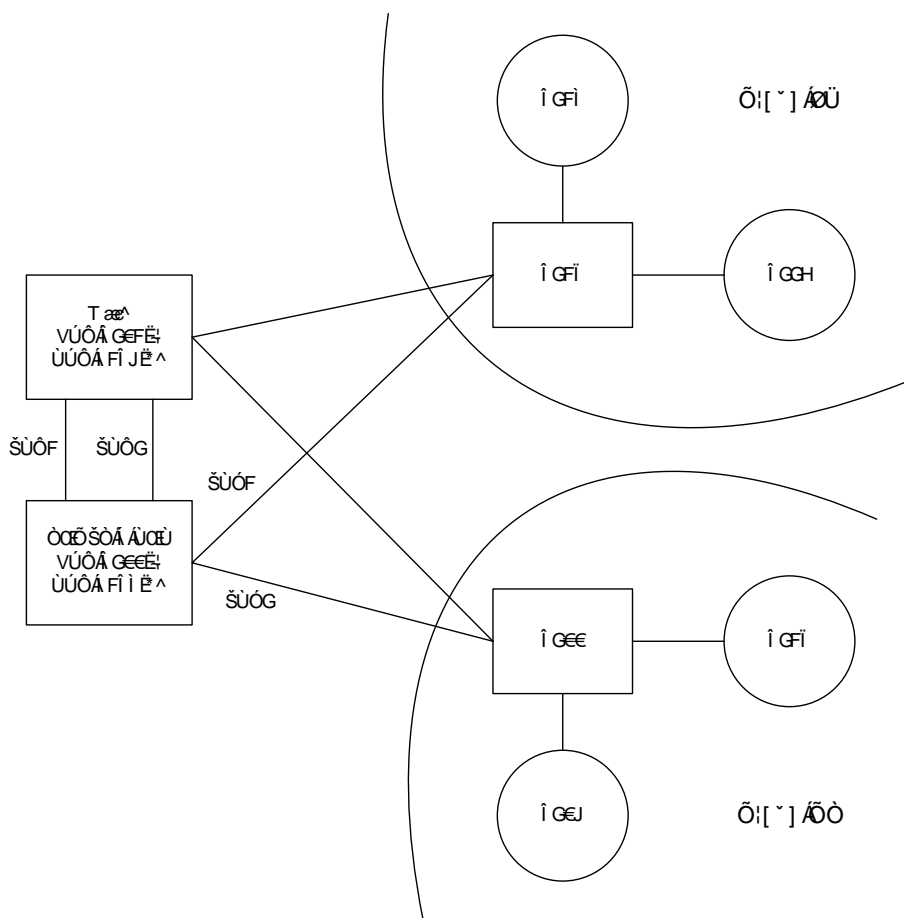

Configuring Destination Tables

For example, to provision the EAGLE 5 SAS for the network shown in Figure 2-3 on page 2-18, the user would enter these commands:

<code>ent-dstn:dpcn=6201-fr</code>	(Mate's true PC)
<code>ent-dstn:dpcn=4169-ge</code>	(Mate's secondary PC)
<code>ent-dstn:dpcn=6217-fr</code>	(Group fr destinations)
<code>ent-dstn:dpcn=6218-fr</code>	
<code>ent-dstn:dpcn=6223-fr</code>	
<code>ent-dstn:dpcn=6200-ge</code>	(Group ge destinations)
<code>ent-dstn:dpcn=6217-ge</code>	
<code>ent-dstn:dpcn=6209-ge</code>	
<code>ent-ls:lsn=LSC1:apcn=6201-fr:lst=C</code>	(C linkset used by Group fr)
<code>ent-ls:lsn=LSC2:apcn=4169-ge:lst=C</code>	(C linkset used by Group ge)
<code>ent-ls:lsn=LSB1:apcn=6217-fr:lst=B</code>	
<code>ent-ls:lsn=LSB2:apcn=6200-ge:lst=B</code>	
<code>ent-rte:dpcn=6217-fr:lsn=LSB1:rc=10</code>	(primary route for a Group fr destination)
<code>ent-rte:dpcn=6217-fr:lsn=LSC1:rc=20</code>	(alternate route for a Group fr destination)
<code>ent-rte:dpcn=6217-ge:lsn=LSB2:rc=10</code>	(primary route for a Group ge destination)
<code>ent-rte:dpcn=6217-ge:lsn=LSC2:rc=20</code>	(alternate route for a Group ge destination)

Receiving an ITU-National MSU on an ITU-International Linkset

It is possible for the EAGLE 5 SAS to receive ITU-National MSUs on an ITU-International linkset. A linkset is considered an ITU-International linkset if it's adjacent point code is an ITU-International PC. An MSU is ITU-National if it is received on an ITU linkset (National or International), and the NIC field in the SIO is set to 2 (National).

ITU-International linksets do not have a group code. ITU-National MSUs received on ITU-International linksets will be assigned a group code of aa.

Existing ITU National Destinations

Any ITU-National destinations that were entered before Release 26.05 or before the ITU National Duplicate Point Codes feature was turned on will be assigned the group code of aa.

Interaction with Other Features

Gateway Screening

For example, in the network in Figure 2-3 on page 2-18, if the user wanted to screen out MSU coming from 6217 in Group ge, but allow MSUs coming from 6217 in Group fr, he or she could assign different screensets to LSB1 and LSB2. The screenset assigned to LSB1 would allow MSUs from OPC 6217. The screenset assigned to LSB2 would block MSUs from OPC 6217.

Multiple Point Codes

The Multiple Point Codes feature (see “Multiple Point Code Support” on page 2-55) must be on in order to turn on the ITU National Duplicate Point Codes feature. For every group that is used, the user must provision either a True PC or Secondary Point Code, using the `chg-sid` command.

For example, in the network in Figure 2-3 on page 2-18, two groups are used having group codes of fr and ge. An ITU-National True Point Code is entered for group fr, and an ITU-National Secondary Point code is entered for group ge.

Conversion between ITU-N and ITU-I or ANSI

Each ITU-N destination and group code can have its own ITU-I or ANSI alias PC. Each ITU-I or ANSI node can be assigned one ITU-N destination. For conversion from ITU-I or ANSI to ITU-N to succeed, the ITU-N alias of the sending node must have the same group code as the destination's group code. So each ITU-I or ANSI node can only send and receive messages from one ITU-N group.

Figure 2-4. Network for Conversion

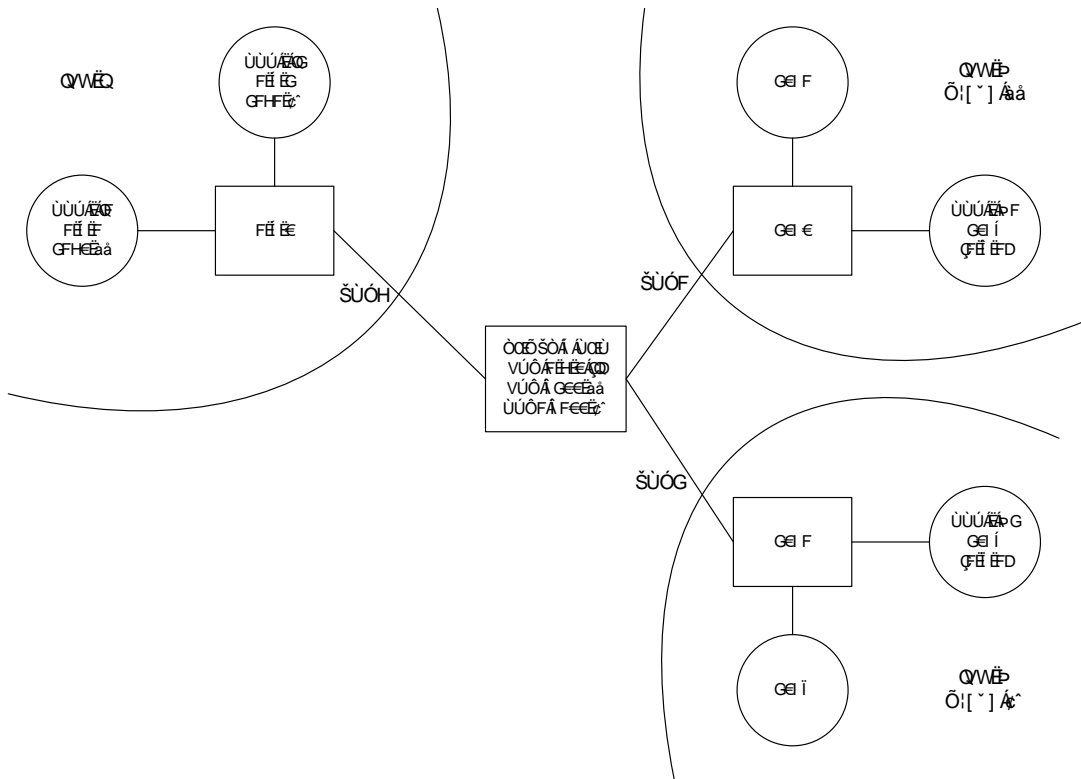

In Figure 2-4, SSP-N1 (2045-bd) is assigned ITU-I alias 1-6-1, and SSP-N2 (2045-xy) is assigned ITU-I alias 1-7-1. SSP-I1 is assigned ITU-N alias 2130-bd and SSP-I2 is assigned ITU-N alias 2131-xy. In this example, SSP-I1 can exchange traffic with nodes in group bd, but not nodes in group xy. SSP-I2 can exchange traffic with nodes in group xy, but not nodes in group bd.

SSP-I1 (1-5-1) can send to SSP-N1 by using the ITU-I alias 1-6-1, But if SSP-I1 tries to send to 2045-xy by using the ITU-I alias 1-7-1, conversion will fail, and the EAGLE 5 SAS will generate UIM 1091 (Indicating OPC conversion failed).

SSP-N1 can send traffic to SSP-I1, but SSP-N2 cannot send traffic to SSP-I1. SSP-N1 sends an ITU-N MSU with DPC set to 2130. The EAGLE 5 SAS assigns a group code of bd to the MSU based on the incoming linkset. The EAGLE 5 SAS then looks up 2130-bd, determines that this is an alias for ITU-I 1-5-1, and routes the MSU to SSP-I1.

If SSP-N2 sends an ITU-N MSU with DPC set to 2130, the EAGLE 5 SAS assigns a group code of xy to the MSU based on the incoming linkset. The EAGLE 5 SAS then looks up 2130-xy, does not find a match, and discards the MSU.

To provision the SSP-N1, SSP-N2, SSP-I1, and SSP-I2 in the network shown in Figure 2-4 on page 2-21, the following commands are used:

```
ent-dstn:dpcn=2045-bd:aliasi=1-6-1
ent-dstn:dpcn=2045-xy:aliasi=1-7-1
ent-dstn:dpci=1-5-1:aliasn=2130-bd
ent-dstn:dpci=1-5-2:aliasn=2131-xy
ent-rte:dpcn=2045-bd:lsn=LSB1:rc=10
ent-rte:dpcn=2045-xy:lsn=LSB2:rc=10
ent-rte:dpci=1-5-1:lsn=LSB3:rc=10
ent-rte:dpci=1-5-2:lsn=LSB3:rc=10
```

Limitations

The ITU National Duplicate Point Code feature has the following limitations:

- Duplicate Point Codes are only supported for ITU-National Destinations.
- ITU-National traffic from a group must be destined for a PC within the same group.
- No duplicate point codes are allowed within a group.
- For each group that is provisioned, a separate ITU-N C-linkset must be provisioned.
- It is not possible to change a destination's group code. If the user wants to move a destination from one group to another, the user must provision a new destination that uses the new group code and delete the old destination.
- If conversion between ITU-N and ITU-I or ANSI is used, only 1 ITU-N group can send traffic to a specific ANSI or ITU-I node.

Changing the DPC Quantity

This procedure is used to increase the number of DPCs that are allowed in the EAGLE 5 SAS beyond what is currently shown in the `ent-dstn`, `dlt-dstn`, `chg-dstn`, and `rtrv-dstn` outputs. The EAGLE 5 SAS can contain a maximum of one of these quantities: 2000 (system default), 5000, 6000, 7000, or 8000 DPCs.

To have more than 2000 DPCs in the EAGLE 5 SAS, the 5000 Routes feature must be turned on using the `chg-feat` command. Turning on the 5000 Routes features allows the EAGLE 5 SAS to contain a maximum of 5000 DPCs. To have more than 5000 DPCs in the EAGLE 5 SAS, either 6000, 7000, or 8000 routesets must be enabled using the `enable-ctrl-feat` command, in addition to having the 5000 Routes feature turned on. Enabling 6000, 7000, or 8000 routesets allows the EAGLE 5 SAS to contain a maximum of 6000, 7000, or 8000 DPCs. The `rtrv-ctrl-feat` command shows whether or not 6000, 7000, or 8000 routesets are enabled. The `rtrv-feat` command shows whether or not the 5000 Routes feature is turned on.

NOTE: Once the 5000 Routes feature is turned on with the `chg-feat` command, it cannot be turned off.

The 5000 Routes feature must be purchased before you turn this feature on with the `chg-feat` command. If you are not sure if you have purchased the 5000 Routes feature, contact your Tekelec Sales Representative or Account Representative.

Once the maximum DPC quantity is set, the actual number of DPCs allowed in the EAGLE 5 SAS is configured using the `mtpdpcq` parameter of the `chg-stpopts` command. The `rtrv-stpopts` command output, as well as the outputs of the `ent-dstn`, `dlt-dstn`, `chg-dstn`, and `rtrv-dstn` commands, shows the actual number of DPCs allowed in the EAGLE 5 SAS.

If the Cluster Routing and Management Diversity feature is turned on, (shown by the entry `CRMD = on` in the `rtrv-feat` output) the `mtpx1q` parameter is also shown in the `rtrv-stpopts` output. The `mtpx1q` parameter defines the maximum number of entries that the exception list (x-list) for the Cluster Routing and Management Diversity feature can contain. The value of the `mtpx1q` parameter of the `chg-stpopts` command can also be changed to more than 2000 destination point codes. For more information on exception lists, see "Exception Lists (X-lists)" on page 2-120.

The `enable-ctrl-feat` command enables 6000, 7000, or 8000 routesets by inputting the part number for the routeset quantity and the routeset quantity's feature access key with these parameters:

:partnum – The Tekelec-issued part number for the routeset quantity:

- For 6000 routesets - 893006401
- For 7000 routesets - 893006402
- For 8000 routesets - 893006403.

: fak – The feature access key supplied by Tekelec. The feature access key contains 13 alphanumeric characters and is not case sensitive.

NOTE: The values for the feature access key (the **fak** parameter) are provided by Tekelec. If you do not have the feature access key for the routeset quantity you wish to enable, contact your Tekelec Sales Representative or Account Representative.

The **enable-ctrl-feat** command requires a valid serial number for the EAGLE 5 SAS to be configured in the database, and that this serial number is locked. This can be verified with the **rtrv-serial-num** command. The EAGLE 5 SAS is shipped with a serial number in the database, but the serial number is not locked. The serial number can be changed, if necessary, and locked once the EAGLE 5 SAS is on-site, by using the **ent-serial-num** command. The **ent-serial-num** command uses these parameters.

:serial – The serial number assigned to the EAGLE 5 SAS. The serial number is not case sensitive.

:lock – Specifies whether or not the serial number is locked. This parameter has only one value, **yes**, which locks the serial number. Once the serial number is locked, it cannot be changed.

NOTE: To enter and lock the EAGLE 5 SAS's serial number, the **ent-serial-num** command must be entered twice, once to add the correct serial number to the database with the **serial** parameter, then again with the **serial** and the **lock=yes** parameters to lock the serial number. You should verify that the serial number in the database is correct before locking the serial number. The serial number can be found on a label affixed to the control shelf (shelf 1100).

To enable 7000 or 8000 routesets, the DPC table can contain no more than 8000 alias point codes. The number of alias point codes configured in the EAGLE 5 SAS is shown in the output of the **ent-dstn**, **dlt-dstn**, **chg-dstn**, and **rtrv-dstn** command outputs in one of two ways, depending on whether or not the Cluster Routing and Management Diversity feature is on or off.

If the Cluster Routing and Management Diversity feature is off:

```
rlghncxa03w 05-09-17 16:02:05 GMT EAGLE5 34.0.0
Destination table is (10 of 8000) 1% full
Alias table is (8 of 8000) 1% full
RTRV-DSTN: MASP A - COMPLTD
```

If the Cluster Routing and Management Diversity feature is on:

```
rlghncxa03w 05-09-17 16:02:05 GMT EAGLE5 34.0.0
DESTINATION ENTRIES ALLOCATED:      8000
  FULL DPC(s):                       9
  NETWORK DPC(s):                    0
  CLUSTER DPC(s):                     1
  TOTAL DPC(s):                       10
  CAPACITY (% FULL):                  1%
ALIASES ALLOCATED:                8000
  ALIASES USED:                    8
  CAPACITY (% FULL):                1%
X-LIST ENTRIES ALLOCATED:           500
RTRV-DSTN: MASP A - COMPLTD
```

Configuring Destination Tables

To set the alias point code quantity below 8000, perform the “Changing a Destination Point Code” procedure on page 2-226. The alias point codes are removed using this procedure.

The routeset quantities (6000, 7000, or 8000) cannot be temporarily enabled (with a temporary feature access key) and cannot be disabled with the `chg-ctrl-feat` command and the `status=off` parameter. The routeset quantity cannot be decreased to a smaller quantity once a quantity is enabled. For example, if the current routeset quantity of the EAGLE 5 SAS is 7000 routesets, the quantity cannot be reduced to 6000 routesets.

Once any of these routeset quantities are enabled with the `enable-ctrl-feat` command, they are also activated. The `chg-ctrl-feat` command is not necessary to activate these routeset quantities.

Procedure

1. Display the DPC quantity currently allowed in the EAGLE 5 SAS by entering the `rtrv-stpopts` command. The DPC quantity is displayed in the `MTPDPCQ` field of the output. This is an example of the possible output.

```
rlghncxa03w 05-09-17 16:02:05 GMT EAGLE5 34.0.0
STP OPTIONS
-----
MTPDPCQ           1750
```

NOTE: The `rtrv-stpopts` command output contains other fields that are not used by this procedure. If you wish to see all the fields displayed by the `rtrv-stpopts` command, see the `rtrv-stpopts` command description in the *Commands Manual*.

The `MTPDPCQ` value cannot exceed one of these totals depending on the features that are enabled or turned on:

- 2000 – if the 5000 Routes feature is not on, and 6000, 7000, or 8000 routesets are not enabled.
- 5000 – if the 5000 Routes feature is on, and 6000, 7000, or 8000 routesets are not enabled.
- 6000 – if 6000 routesets are enabled.
- 7000 – if 7000 routesets are enabled.
- 8000 – if 8000 routesets are enabled.

If the Cluster Routing and Management Diversity feature is on, the `MTPXLQ` field will be shown in the `rtrv-stpopts` command output. The `MTPXLQ` field shows the maximum number of entries the exception list (x-list) can contain.

The sum of the **MTPDPCQ** and **MTPXLQ** values cannot exceed one of these totals depending on the features that are enabled or turned on:

- 2500 – if the 5000 Routes feature is not on, and 6000, 7000, or 8000 routesets are not enabled.
- 5500 – if the 5000 Routes feature is on, and 6000, 7000, or 8000 routesets are not enabled.
- 6500 – if 6000 routesets are enabled.
- 7500 – if 7000 routesets are enabled.
- 8500 – if 8000 routesets are enabled.

For more information on the Cluster Routing and Management Diversity feature, see the “Cluster Routing and Management Diversity (CRMD)” section on page 2-119.

Perform one of the following steps based on the **MTPDPCQ** value (or **MTPDPCQ** and **MTPXLQ** values) shown in the **rtrv-stpopts** output. The values shown in parentheses are the sum of the **MTPDPCQ** and **MTPXLQ** values.

- 7001 - 8000 (7501 - 8500) – 8000 routesets are enabled. The only action that can be performed is to change the DPC quantity using the **chg-stpopts** command. This is the maximum number of routesets the EAGLE 5 SAS can have. Perform step 13 to change the DPC quantity. Skip steps 2 through 12. If you do not wish to change the DPC quantity, this procedure is finished.
 - 6001 - 7000 (6501 - 7500) – 7000 routesets are enabled. To enable the 8000 routeset quantity, skip steps 2 through 10 and perform step 11. If you wish to change the DPC quantity and not enable 8000 routesets, skip steps 2 through 12 and perform step 13. If you do not wish to enable 8000 routesets or change the DPC quantity, this procedure is finished.
 - 5001 - 6000 (5501 - 6500) – 6000 routesets are enabled. To enable 7000 or 8000 routesets, skip steps 2 through 9 and perform step 10. If you wish to change the DPC quantity and not enable 7000 or 8000 routesets, skip steps 2 through 12 and perform step 13. If you do not wish to enable 7000 or 8000 routesets or change the DPC quantity, this procedure is finished.
 - 2001 - 5000 (2501 - 5500) – The 5000 Routes feature is on. To enable 6000, 7000, or 8000 routesets, perform step 2. If you wish to change the DPC quantity and not enable 6000, 7000, or 8000 routesets, skip steps 2 through 12 and perform step 13. If you do not wish to enable 6000, 7000, or 8000 routesets or change the DPC quantity, this procedure is finished.
 - 2000 or less (2500 or less) – Perform step 2.
-

Configuring Destination Tables

2. Verify that 6000, 7000, or 8000 routesets are enabled by entering the **rtrv-ctrl-feat** command. The following is an example of the possible output.

```
rlghncxa03w 05-09-28 21:15:37 GMT EAGLE5 34.0.0
The following features have been permanently enabled:
```

Feature Name	Partnum	Status	Quantity
IPGWx Signaling TPS	893012814	on	20000
ISUP Normalization	893000201	on	----
Command Class Management	893005801	on	----
LNP Short Message Service	893006601	on	----
Intermed GTT Load Sharing	893006901	on	----
XGTT Table Expansion	893006101	on	4000000
XMAP Table Expansion	893007710	on	3000
Large System # Links	893005901	on	1500
Routesets	893006401	on	6000
HC-MIM SLK Capacity	893012707	on	64

```
The following features have been temporarily enabled:
```

Feature Name	Partnum	Status	Quantity	Trial Period Left
Zero entries found.				

```
The following features have expired temporary keys:
```

Feature Name	Partnum
Zero entries found.	

If 8000 routesets are enabled, the **Routesets** row appears in the **rtrv-ctrl-feat** output with a quantity of 8000. The only action that can be performed is to change the DPC quantity using the **chg-stpopts** command. This is the maximum number of routesets the EAGLE 5 SAS can have. Perform step 13 to change the DPC quantity. Skip steps 3 through 12. If you do not wish to change the DPC quantity, this procedure is finished.

If 7000 routesets are enabled, the **Routesets** row appears in the **rtrv-ctrl-feat** output with a quantity of 7000. To enable 8000 routesets, skip steps 3 through 10 and perform step 11. If you wish to change the DPC quantity and not enable 8000 routesets, skip steps 3 through 12 and perform step 13. If you do not wish to enable 8000 routesets or change the DPC quantity, this procedure is finished.

If 6000 routesets are enabled, the **Routesets** row appears in the **rtrv-ctrl-feat** output with a quantity of 6000. To enable 7000 or 8000 routesets, skip steps 3 through 9 and perform step 10. If you wish to change the DPC quantity and not enable 7000 or 8000 routesets, skip steps 3 through 12 and perform step 13. If you do not wish to enable 7000 or 8000 routesets or change the DPC quantity, this procedure is finished.

If 6000, 7000, or 8000 routesets are not enabled, go to step 3.

- Enter the `rtrv-feat` command and verify that the 5000 Routes feature is turned on. If the 5000 Routes feature is on, the `DSTN5000 = on` entry appears in the output.

NOTE: The `rtrv-feat` command output contains other fields that are not used by this procedure. If you wish to see all the fields displayed by the `rtrv-feat` command, see the `rtrv-feat` command description in the *Commands Manual*.

If the 5000 Routes feature is not on, and you do not wish to turn the 5000 Routes feature on, or enable 6000, 7000 or 8000 routesets, the only action that can be performed is to change the DPC quantity using the `chg-stpopts` command. However the DPC quantity can be no greater than 2000 DPCs (2500 DPCs if the `rtrv-stpopts` output in step 1 contains the `MTPDPCQ` and `MTPXLQ` parameters). Perform step 13 to change the DPC quantity. Skip steps 4 through 12. If you do not wish to change the DPC quantity, this procedure is finished.

If the 5000 Routes feature is not on, and you wish to turn the 5000 Routes feature on, or enable 6000, 7000 or 8000 routesets, go to step 4.

If the 5000 Routes feature is on, skip steps 4 and 5, and go to step 6.

- Turn the 5000 Routes feature on by entering this command.

```
chg-feat:DSTN5000=on
```

NOTE: Once the 5000 Routes feature is turned on with the `chg-feat` command, it cannot be turned off.

The 5000 Routes feature must be purchased before you turn this feature on with the `chg-feat` command. If you are not sure if you have purchased the 5000 Routes feature, contact your Tekelec Sales Representative or Account Representative.

When the `chg-feat` has successfully completed, this message appears.

```
rlghncxa03w 05-09-28 11:43:04 GMT EAGLE5 34.0.0
CHG-FEAT: MASP A - COMPLTD
```

Configuring Destination Tables

5. Verify that the 5000 Routes feature is turned on, by entering the `rtrv-feat` command. If the 5000 Routes feature is on, the `DSTN5000 = on` appears in the command output.

NOTE: The `rtrv-feat` command output contains other fields that are not used by this procedure. If you wish to see all the fields displayed by the `rtrv-feat` command, see the `rtrv-feat` command description in the *Commands Manual*.

If 6000, 7000, or 8000 routesets are not being enabled, the only action that can be performed is to change the DPC quantity. If you wish to change the DPC quantity and not enable 6000, 7000 or 8000 routesets, skip steps 6 through 12 and perform step 13. If you do not wish to enable 6000, 7000 or 8000 routesets or change the DPC quantity, this procedure is finished.

If 6000, 7000, or 8000 routesets are being enabled, go to step 6.

NOTE: If the `rtrv-ctrl-feat` output in step 2 shows any controlled features, skip steps 6 through 9, and go to step 10.

6. Display the serial number in the database with the `rtrv-serial-num` command. This is an example of the possible output.

```
rlghncxa03w 05-09-28 21:15:37 GMT EAGLE5 34.0.0
System serial number = nt00001231
System serial number is not locked.
rlghncxa03w 05-09-28 21:15:37 GMT EAGLE5 34.0.0
Command Completed
```

NOTE: If the serial number is correct and locked, skip steps 7, 8, and 9, and go to step 10. If the serial number is correct but not locked, skip steps 7 and 8, and go to step 9. If the serial number is not correct, but is locked, 6000, 7000, or 8000 routesets cannot be enabled and the remainder of this procedure cannot be performed. Contact the Customer Care Center to get an incorrect and locked serial number changed. Refer to “Customer Care Center” on page 1-8 for the contact information. The serial number can be found on a label affixed to the control shelf (shelf 1100).

7. Enter the correct serial number into the database using the `ent-serial-num` command with the `serial` parameter.

For this example, enter this command.

```
ent-serial-num:serial=<EAGLE 5 SAS's correct serial number>
```

When this command has successfully completed, the following message should appear.

```
rlghncxa03w 05-09-28 21:15:37 GMT EAGLE5 34.0.0
ENT-SERIAL-NUM: MASP A - COMPLTD
```

8. Verify that the serial number entered into step 7 was entered correctly using the **rtrv-serial-num** command. This is an example of the possible output.

```
rlghncxa03w 05-09-28 21:15:37 GMT EAGLE5 34.0.0
System serial number = nt00001231

System serial number is not locked.

rlghncxa03w 05-09-28 21:15:37 GMT EAGLE5 34.0.0
Command Completed
```

If the serial number was not entered correctly, repeat steps 7 and 8 and re-enter the correct serial number.

-
9. Lock the serial number in the database by entering the **ent-serial-num** command with the serial number shown in step 6, if the serial number shown in step 6 is correct, or with the serial number shown in step 8, if the serial number was changed in step 7, and with the **lock=yes** parameter.

For this example, enter this command.

```
ent-serial-num:serial=<EAGLE 5 SAS's serial number>;lock=yes
```

When this command has successfully completed, the following message should appear.

```
rlghncxa03w 05-09-28 21:15:37 GMT EAGLE5 34.0.0
ENT-SERIAL-NUM: MASP A - COMPLTD
```

NOTE: If 7000 or 8000 routesets are not being enabled, skip step 10 and go to step 11.

NOTE: If 7000 routesets are currently enabled, and 8000 routesets are being enabled, skip step 10 and go to step 11.

10. Verify the number of alias point codes configured in the EAGLE 5 SAS by entering the **rtrv-dstn** command with the **msar=only** parameter.

To enable 7000 or 8000 routesets, the EAGLE 5 SAS can have no more than 8000 alias point codes.

The **msar=only** parameter displays only the maximum numbers of different types of point codes the EAGLE 5 SAS can have and the actual numbers of the different types of point codes that are configured in the EAGLE 5 SAS.

```
rtrv-dstn:msar=only
```

One of two types of outputs are displayed, depending on whether or not the Cluster Routing and Management Diversity feature is on or off.

If the Cluster Routing and Management Diversity feature is off:

```
rlghncxa03w 05-09-17 16:02:05 GMT EAGLE5 34.0.0
Destination table is (10 of 8000) 1% full
Alias table is (8 of 8000) 1% full
RTRV-DSTN: MASP A - COMPLTD
```

Configuring Destination Tables

If the Cluster Routing and Management Diversity feature is on:

```
rlghncxa03w 05-09-17 16:02:05 GMT EAGLE5 34.0.0
DESTINATION ENTRIES ALLOCATED: 8000
  FULL DPC(s): 9
  NETWORK DPC(s): 0
  CLUSTER DPC(s): 1
  TOTAL DPC(s): 10
  CAPACITY (% FULL): 1%
ALIASES ALLOCATED: 8000
  ALIASES USED: 8
  CAPACITY (% FULL): 1%
X-LIST ENTRIES ALLOCATED: 500
RTRV-DSTN: MASP A - COMPLTD
```

If the EAGLE 5 SAS contains more than 8000 alias point codes, perform the “Changing a Destination Point Code” procedure on page 2-226 to reduce the number of alias point codes to an amount below 8000.

-
11. Enable the routeset quantity with the `enable-ctrl-feat` command specifying the part number for the routeset quantity and the feature access key. Enter one of these commands.

To enable 6000 routesets:

```
enable-ctrl-feat:partnum=893006401:fak=<6000 Routesets feature
access key>
```

To enable 7000 routesets:

```
enable-ctrl-feat:partnum=893006402:fak=<7000 Routesets feature
access key>
```

To enable 8000 routesets:

```
enable-ctrl-feat:partnum=893006403:fak=<8000 Routesets feature
access key>
```

NOTE: A temporary feature access key cannot be specified to enable the routeset quantity.

NOTE: The values for the feature access key (the `fak` parameter) are provided by Tekelec. If you do not have the feature access key for the routeset quantity you wish to enable, contact your Tekelec Sales Representative or Account Representative.

When the `enable-ctrl-feat` command has successfully completed, this message should appear.

```
rlghncxa03w 05-09-28 21:15:37 GMT EAGLE5 34.0.0
ENABLE-CTRL-FEAT: MASP B - COMPLTD
```

12. Verify the changes by entering the `rtrv-ctrl-feat` command with the routeset quantity part number specified in step 11. Enter one of these commands.

rtrv-ctrl-feat:partnum=893006401

The following is an example of the possible output.

```
rlghncxa03w 05-09-28 21:15:37 GMT EAGLE5 34.0.0
The following features have been permanently enabled:
```

Feature Name	Partnum	Status	Quantity
Routesets	893006401	on	6000

The following features have been temporarily enabled:

Feature Name	Partnum	Status	Quantity	Trial Period Left
Zero entries found.				

The following features have expired temporary keys:

Feature Name	Partnum
Zero entries found.	

rtrv-ctrl-feat:partnum=893006402

The following is an example of the possible output.

```
rlghncxa03w 05-09-28 21:15:37 GMT EAGLE5 34.0.0
The following features have been permanently enabled:
```

Feature Name	Partnum	Status	Quantity
Routesets	893006402	on	7000

The following features have been temporarily enabled:

Feature Name	Partnum	Status	Quantity	Trial Period Left
Zero entries found.				

The following features have expired temporary keys:

Feature Name	Partnum
Zero entries found.	

rtrv-ctrl-feat:partnum=893006403

The following is an example of the possible output.

```
rlghncxa03w 05-09-28 21:15:37 GMT EAGLE5 34.0.0
The following features have been permanently enabled:
```

Feature Name	Partnum	Status	Quantity
Routesets	893006403	on	8000

The following features have been temporarily enabled:

Feature Name	Partnum	Status	Quantity	Trial Period Left
Zero entries found.				

The following features have expired temporary keys:

Feature Name	Partnum
Zero entries found.	

NOTE: If the DPC quantity or exception list quantity are not being changed, skip steps 13 and 14, and go to step 15.

13. Change the maximum number of destination point codes that the EAGLE 5 SAS can contain by entering the **chg-stpopts** command with the **mtpdpcq** parameter. The values that can be specified with the **mtpdpcq** parameter is shown in the following list.

- 500 to 2000 – if the 5000 Routes feature is not on, and 6000, 7000, or 8000 routesets are not enabled.
- 500 to 5000 – if the 5000 Routes feature is on, and 6000, 7000, or 8000 routesets are not enabled.
- 500 to 6000 – if 6000 routesets are enabled.
- 500 to 7000 – if 7000 routesets are enabled.
- 500 to 8000 – if 8000 routesets are enabled.

For this example, enter this command.

```
chg-stpopts:mtpdpcq=7350
```

When this command has successfully completed, this message should appear.

```
rlghncxa03w 05-09-07 00:22:57 GMT EAGLE5 34.0.0  
CHG-STPOPTS: MASP A - COMPLTD
```

If the **MTPXLQ** field (the exception list quantity) is shown in the **rtrv-stpopts** output in step 1, and you wish to change only the **MTPXLQ** value, enter the **chg-stpopts** command with the **mtpxlq** parameter. For example, if you wish to change the exception list quantity to 1000 point codes, enter this command.

```
chg-stpopts:mtpxlq=1000
```

NOTE: The values that can be specified for the **mtpxlq** parameter are the same as the values for the **mtpdpcq** parameter and are shown in the list at the beginning of this step. However, if 7000 or 8000 routesets are enabled, the range of values for the **mtpxlq** parameter is 500 to 6000.

Both the exception list quantity and the maximum of destination point codes can be changed, by entering the **chg-stpopts** command with both the **mtpdpcq** and **mtpxlq** parameters. For example, if you wish to change the exception list quantity to 1000 point codes and the maximum number of point codes to 6200, enter this command.

```
chg-stpopts:mtpxlq=1000:mtpdpcq=6750
```

When specifying the **mtpxlq** parameter with the **chg-stpopts** command, the resulting sum of the **MTPDPCQ** and **MTPXLQ** values cannot be greater than the values shown in the following list:

- 2500 – if the 5000 Routes feature is not on, and 6000, 7000, or 8000 routesets are not enabled.
- 5500 – if the 5000 Routes feature is on, and 6000, 7000, or 8000 routesets are not enabled.

- 6500 – if 6000 routesets are enabled.
- 7500 – if 7000 routesets are enabled.
- 8500 – if 8000 routesets are is enabled.

-
- 14.** Verify the changes using the `rtrv-stpopts` command. This is an example of the possible output.

```
rlghncxa03w 05-09-17 16:02:05 GMT EAGLE5 34.0.0
STP OPTIONS
```

```
-----
MTPDPCQ          7350
```

NOTE: The `rtrv-stpopts` command output contains other fields that are not used by this procedure. If you wish to see all the fields displayed by the `rtrv-stpopts` command, see the `rtrv-stpopts` command description in the *Commands Manual*.

If the `mtpxlq` parameter was specified in step 13, that value will be shown in the `MTPXLQ` field of the `rtrv-stpopts` command output.

-
- 15.** Back up the new changes, using the `chg-db:action=backup:dest=fixed` command. These messages should appear; the active Maintenance and Administration Subsystem Processor (MASP) appears first.

```
BACKUP (FIXED): MASP A - Backup starts on active MASP.
BACKUP (FIXED): MASP A - Backup on active MASP to fixed disk complete.
BACKUP (FIXED): MASP A - Backup starts on standby MASP.
BACKUP (FIXED): MASP A - Backup on standby MASP to fixed disk complete.
```

Flowchart 2-2. Changing the DPC Quantity (Sheet 1 of 7)

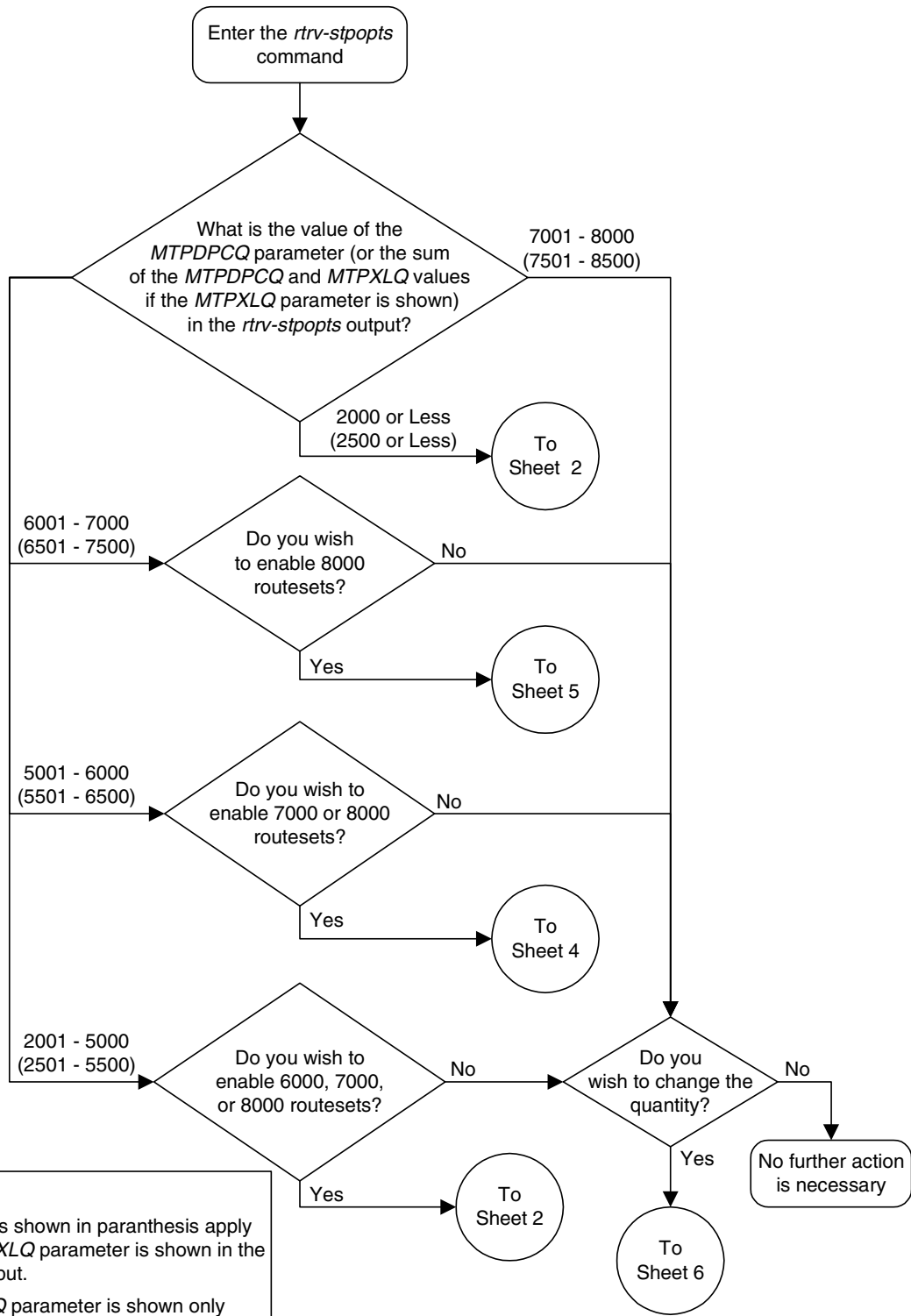

Notes:
 1. The quantities shown in paranthesis apply only if the *MTPXLQ* parameter is shown in the *rtrv-stpopts* output.
 2. The *MTPXLQ* parameter is shown only when the Cluster Routing and Management Diversity (CRMD) feature is on.

Flowchart 2-2. Changing the DPC Quantity (Sheet 2 of 7)

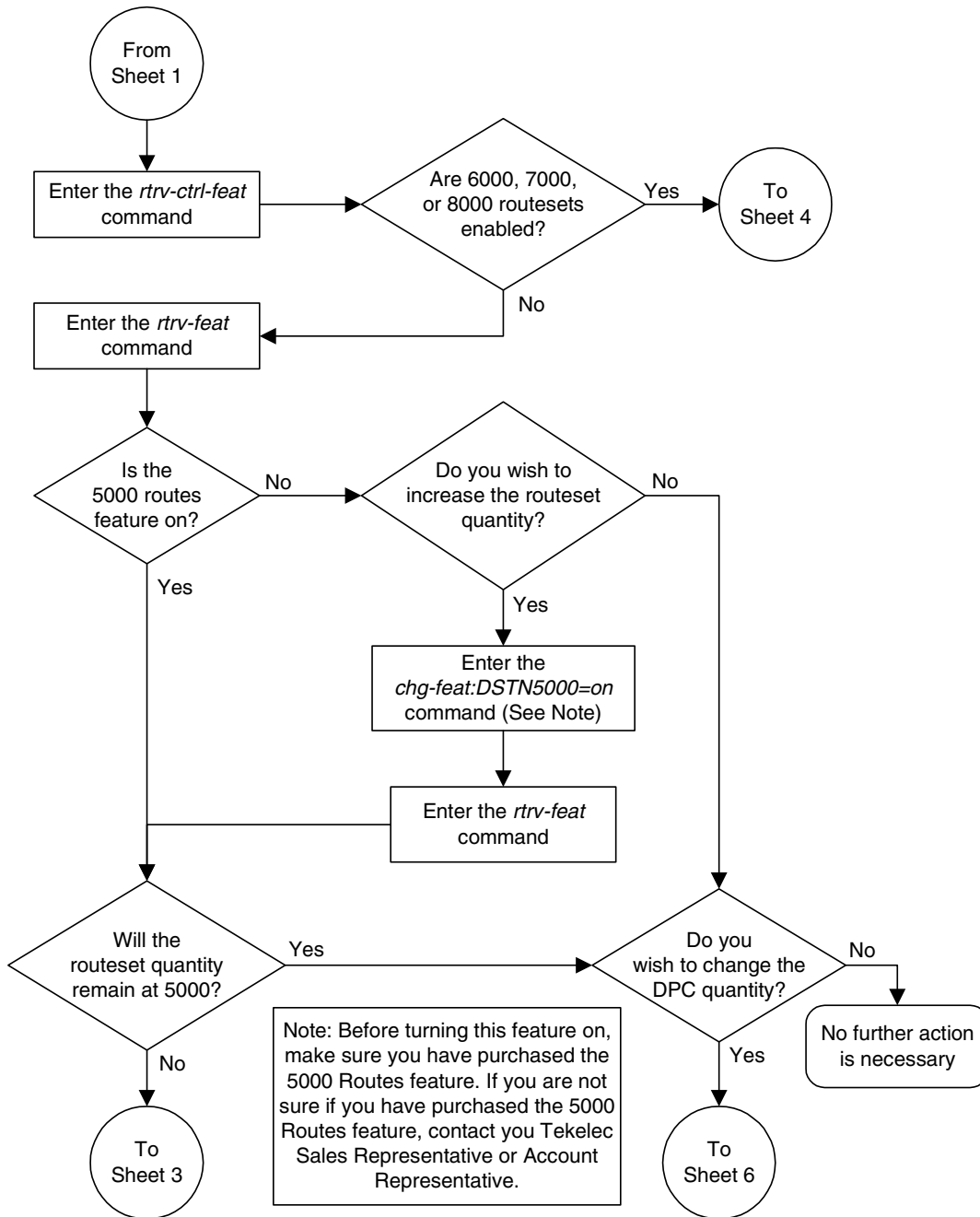

Flowchart 2-2. Changing the DPC Quantity (Sheet 3 of 7)

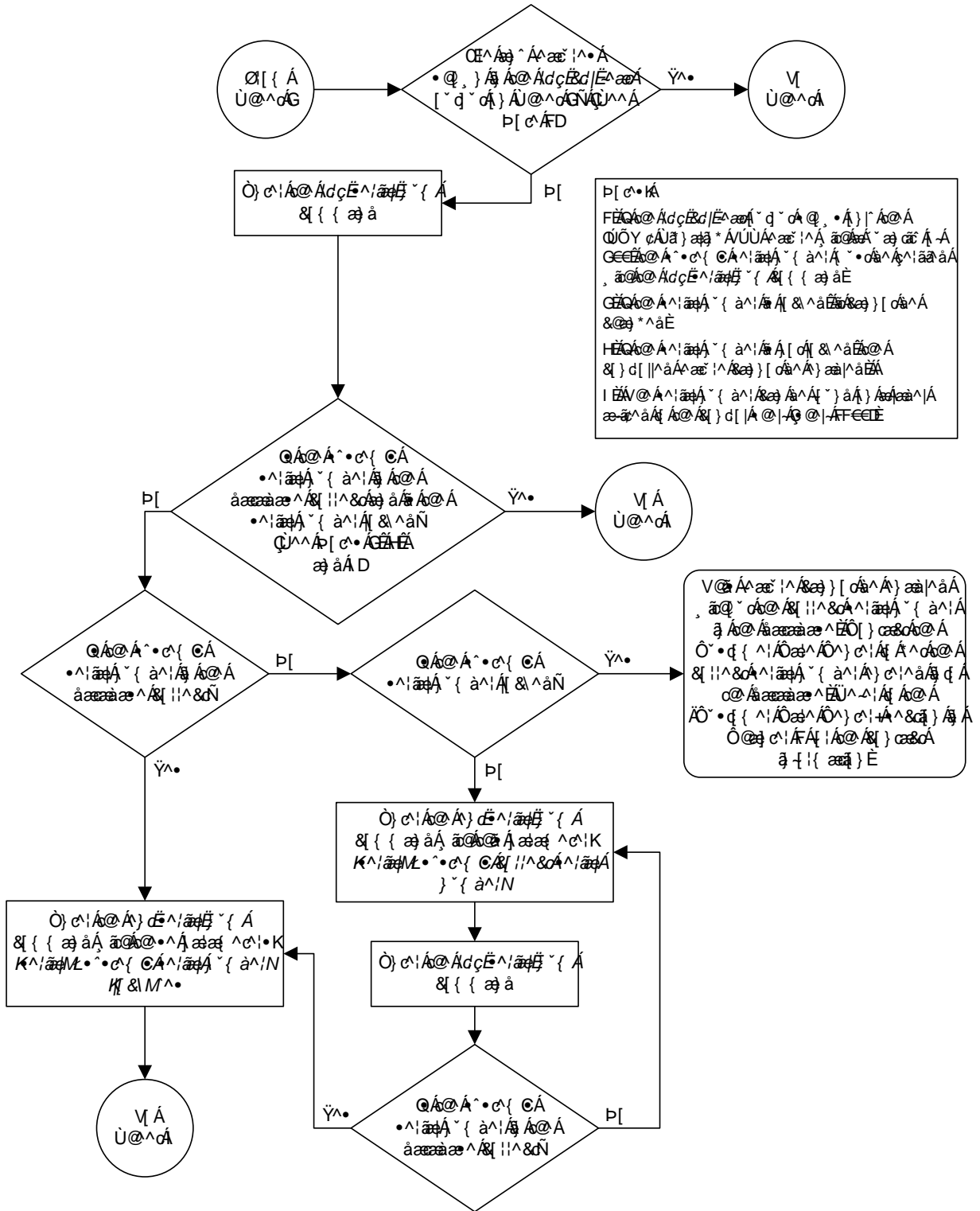

Flowchart 2-2. Changing the DPC Quantity (Sheet 4 of 7)

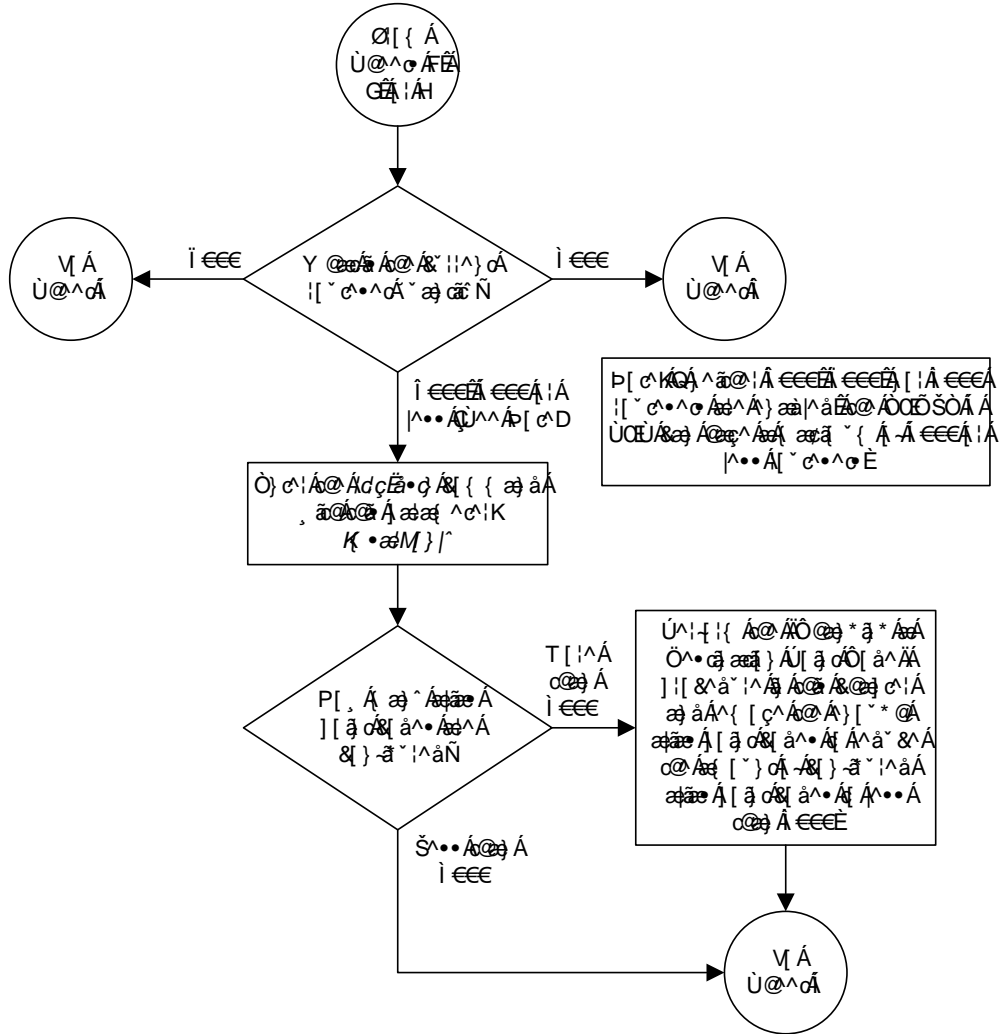

Flowchart 2-2. Changing the DPC Quantity (Sheet 5 of 7)

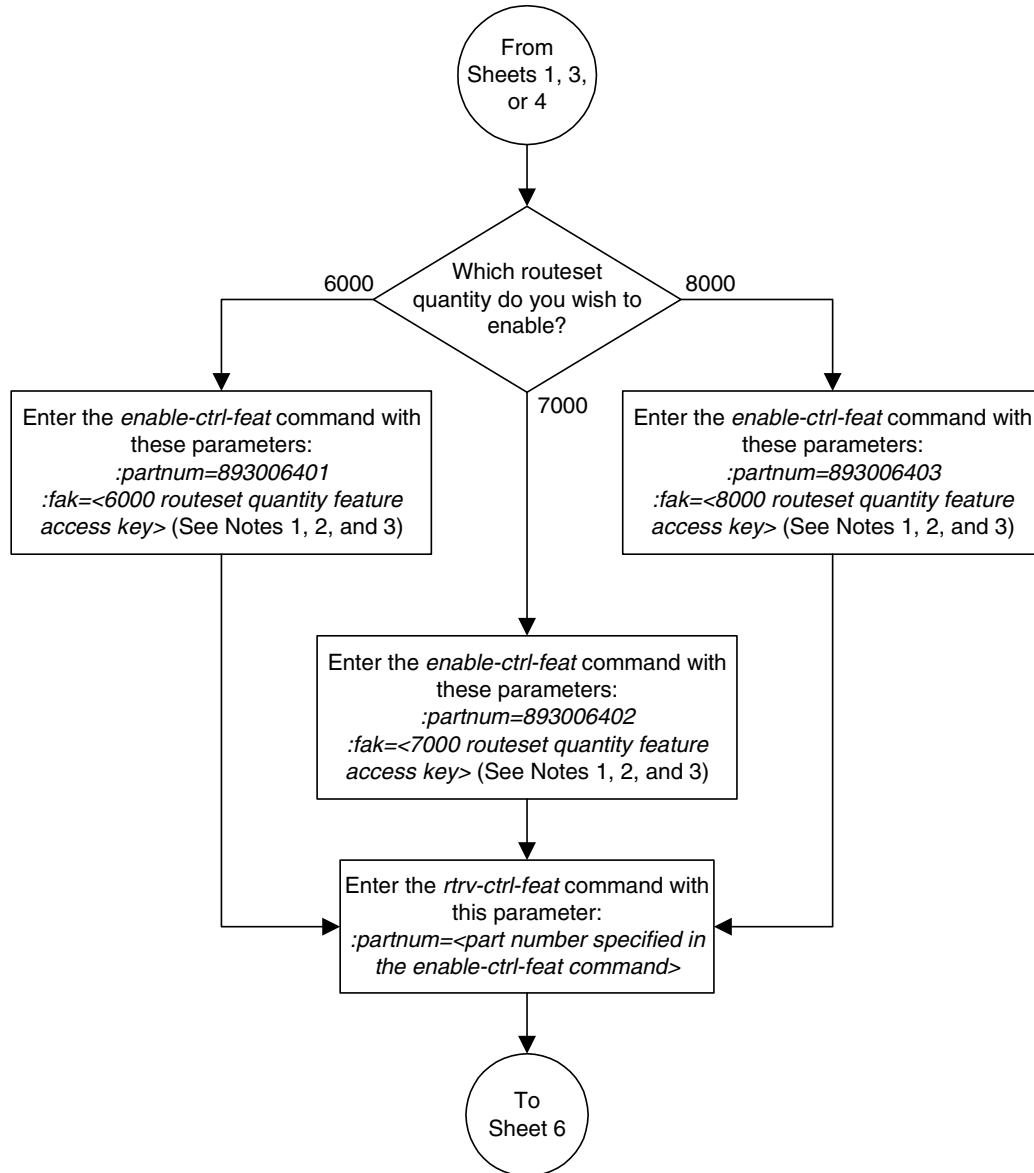

Notes:

1. Once this feature is enabled, it cannot be disabled or turned off.
2. This feature cannot be enabled with a temporary feature access key.
3. If you do not have the feature access key for the feature you wish to enable, contact your Tekelec Sales Representative or Account Representative.

Flowchart 2-2. Changing the DPC Quantity (Sheet 6 of 7)

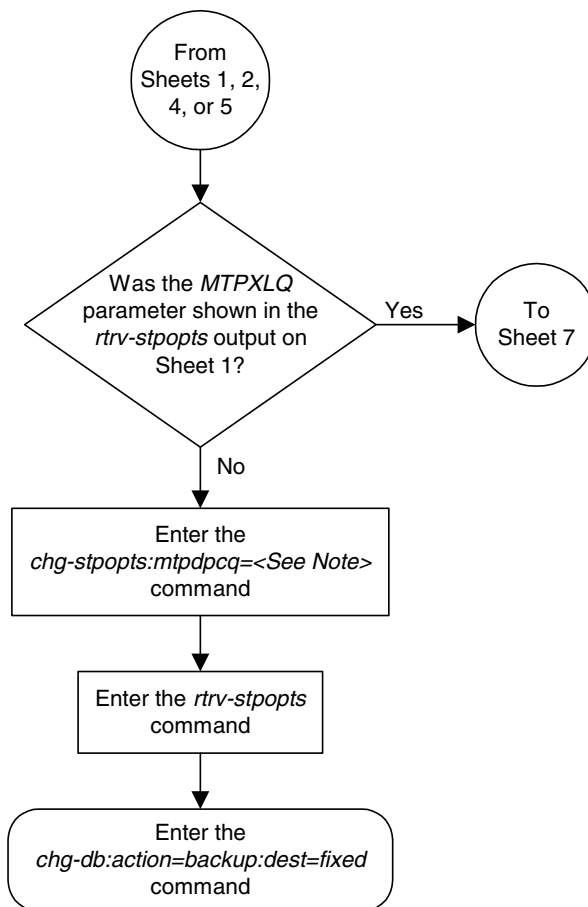

Note: The value for the *mtpdpcq* parameter is shown in the following list and is dependent on the routeset quantity that is enabled with the *enable-ctrl-feat* command, or turned on with the *chg-feat* command:

- 5000 routes not turned on, 6000, 7000, or 8000 routesets not enabled - **500 to 2000**
- 5000 routes turned on, 6000, 7000, or 8000 routesets not enabled - **500 to 5000**
- 6000 routesets enabled - **500 to 6000**
- 7000 routesets enabled - **500 to 7000**
- 8000 routesets enabled - **500 to 8000**

Flowchart 2-2. Changing the DPC Quantity (Sheet 7 of 7)

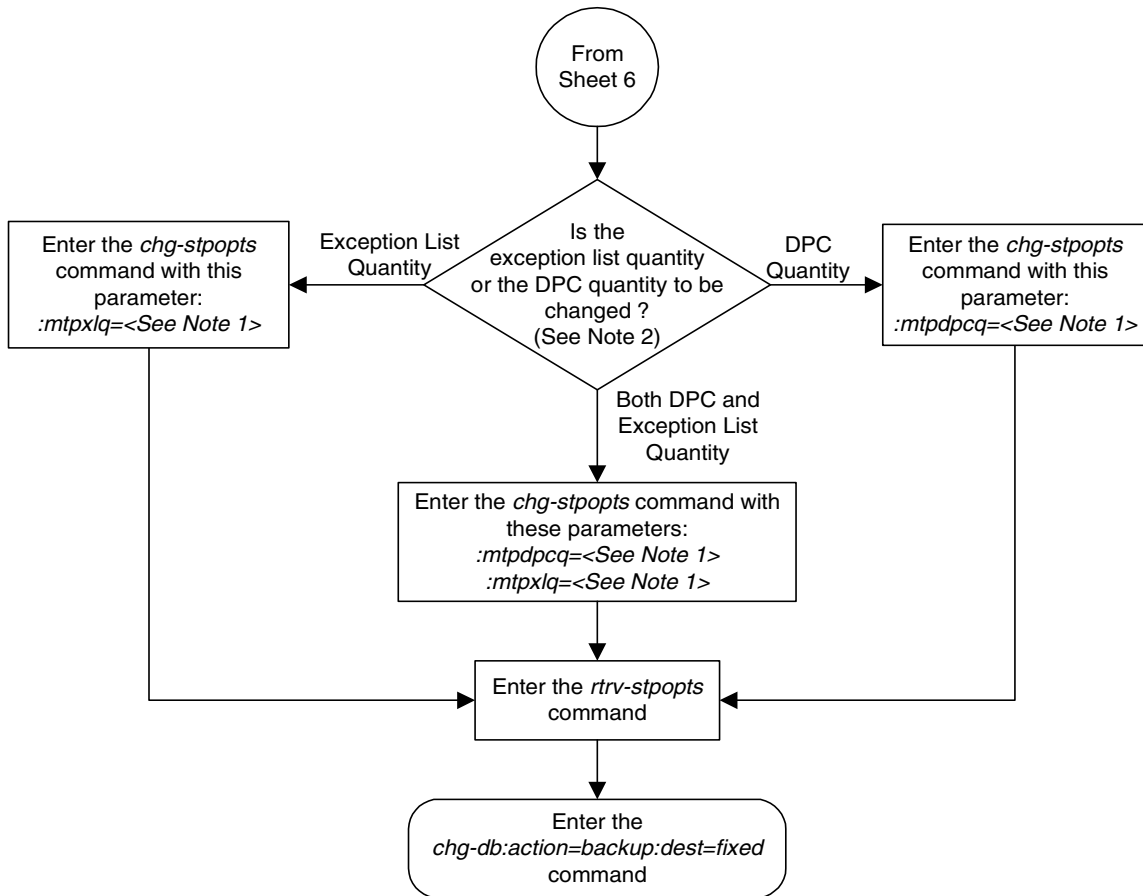

Notes:

1. The sum of the values for the *mtpdpcq* and *mtpxlq* parameters cannot exceed these values, depending which routeset quantity has been enabled with the *enable-ctrl-feat* command, or turned on with the *chg-feat* command:

- 5000 routes not turned on, 6000, 7000, or 8000 routesets not enabled - **2500**. The range of values for the *mtpdpcq* and *mtpxlq* parameters is 500 to 2000.
- 5000 routes turned on, 6000, 7000, or 8000 routesets not enabled - **5500**. The range of values for the *mtpdpcq* and *mtpxlq* parameters is 500 to 5000.
- 6000 routesets enabled - **6500**. The range of values for the *mtpdpcq* and *mtpxlq* parameters is 500 to 6000.
- 7000 routesets enabled - **7500**. The range of values for the *mtpdpcq* parameter is 500 to 7000. The range of values for the *mtpxlq* parameter is 500 to 6000.
- 8000 routesets enabled - **8500**. The range of values for the *mtpdpcq* parameter is 500 to 8000. The range of values for the *mtpxlq* parameter is 500 to 6000.

2. If the DPC quantity or the exception list quantity is being changed, both the *mtpdpcq* and *mtpxlq* parameters do not have to be specified unless the resulting sum of the *mtpdpcq* and *mtpxlq* parameters would exceed the totals shown in Note 1.

For example, the current *mtpdpcq* value is 4000 and the current *mtpxlq* value is 1500, resulting in a sum of 5500, and only the 5000 Routes feature is on. To increase either value, both parameters must be specified and the sum of the new values cannot exceed 5500. If either value is being decreased, the other parameter can be specified as long as the sum of the values does not exceed 5500.

If in this example, the current *mtpdpcq* value is 3000 and the current *mtpxlq* value is 1500, resulting in a sum of 4500, either parameter value can be changed without specifying the other parameter as long as the sum of the values does not exceed 5500.

Activating the ITU National and International Spare Point Code Support Feature

This feature allows ITU international (ITU-I) and 14-bit ITU national (ITU-N) spare point codes to be provisioned in the database. To provision these point codes, the ITU National and International Spare Point Code Support feature must be enabled with the **enable-ctrl-feat** command. Turning this feature on with the **chg-ctrl-feat** command allows the EAGLE 5 SAS to route messages using ITU-I and 14-bit ITU-N spare point codes.

The **enable-ctrl-feat** command enables the ITU National and International Spare Point Code Support feature by inputting the feature's access key and the feature's part number with these parameters:

- : fak** – The feature access key generated by the feature access key generator. The feature access key contains 13 alphanumeric characters and is not case sensitive.
- : partnum** – The Tekelec-issued part number of the ITU National and International Spare Point Code Support feature, 893013601.

Once this feature is enabled, it is permanently enabled. This feature cannot be enabled with a temporary feature access key.

If the EAGLE 5 SAS contains TALI sockets assigned to cards running the IPGWI application, these sockets must be removed before this feature can be enabled.

The **enable-ctrl-feat** command requires that the database contain a valid serial number for the EAGLE 5 SAS, and that this serial number is locked. This can be verified with the **rtrv-serial-num** command. The EAGLE 5 SAS is shipped with a serial number in the database, but the serial number is not locked. The serial number can be changed, if necessary, and locked once the EAGLE 5 SAS is on-site, with the **ent-serial-num** command. The **ent-serial-num** command uses these parameters.

- : serial** – The serial number assigned to the EAGLE 5 SAS. The serial number is not case sensitive.
- : lock** – Specifies whether or not the serial number is locked. This parameter has only one value, **yes**, which locks the serial number. Once the serial number is locked, it cannot be changed.

NOTE: To enter and lock the EAGLE 5 SAS's serial number, the **ent-serial-num** command must be entered twice, once to add the correct serial number to the database with the **serial** parameter, then again with the **serial** and the **lock=yes** parameters to lock the serial number. You should verify that the serial number in the database is correct before locking the serial number. The serial number can be found on a label affixed to the control shelf (shelf 1100).

Configuring Destination Tables

The **chg-ctrl-feat** command uses these parameters:

:partnum – The Tekelec-issued part number of the ITU National and International Spare Point Code Support feature, 893013601.

:status=on – used to turn the ITU National and International Spare Point Code Support on.

The status of the controlled features in the EAGLE 5 SAS is shown with the **rtrv-ctrl-feat** command.

Once the ITU National and International Spare Point Code Support is enabled, ITU-I or 14-bit ITU-N spare point codes can be added to the EAGLE 5 SAS. To do this, perform these procedures to provision these database entities:

1. To add spare point codes to the self identification of the EAGLE 5 SAS - “Adding a Point Code to the Self-Identification of the EAGLE 5 SAS” procedure on page 2-81
2. To change the self identification of the EAGLE 5 SAS to include spare point codes - “Changing the Self-Identification of the EAGLE 5 SAS” procedure on page 2-90
3. To add spare point codes to the DPC table - “Adding a Destination Point Code” procedure on page 2-191
4. To use spare point codes as the adjacent point code of a linkset - “Adding an SS7 Linkset” procedure on page 3-17
5. The signaling links assigned to the linkset - “Adding an SS7 Signaling Link” procedure on page 3-130
6. To use spare point codes as the DPC of a route - Perform one of the “Adding a Route” procedures in Chapter 3.

Procedure

1. Display the controlled features in the database by entering the **rtrv-ctrl-feat** command. This is an example of the possible output.

```
rlghncxa03w 05-09-28 11:43:04 GMT EAGLES 34.0.0
The following features have been permanently enabled:
```

Feature Name	Partnum	Status	Quantity
IPGWx Signaling TPS	893012810	on	12000
SCCP Conversion	893012001	on	----
EIR	893012301	on	----
GSM Map Screening (GMS)	893013201	on	----
HC-MIM SLK Capacity	893012707	on	64

The following features have been temporarily enabled:

Feature Name	Partnum	Status	Quantity	Trial Period Left
Zero entries found.				

The following features have expired temporary keys:

Feature Name	Partnum
Zero entries found.	

If the ITU National and International Spare Point Code Support feature is enabled, the entry **Spare Point Code Support** is shown in the permanently enabled section of the **rtrv-ctrl-feat** output. If the status of the ITU National and International Spare Point Code Support feature is on, no further action can be performed.

If the ITU National and International Spare Point Code Support is enabled but not turned on (shown by the entry **off** in the **Status** column), skip steps 2 through 11, and go to step 12.

If the ITU National and International Spare Point Code Support is not enabled, go to step 2.

Configuring Destination Tables

2. The ITU National and International Spare Point Code Support feature cannot be enabled if TALI sockets are assigned to cards running the IPGWI application. Display the TALI sockets in the database by entering the **rtrv-appl-sock** command. This is an example of the possible output.

```
rlghncxa03w 05-09-28 11:43:04 GMT EAGLE5 34.0.0
```

```
SNAME socket1
LINK      A
LHOST     host2
RHOST     remotehost1
LPORT     1024          RPORT     1024
SERVER    YES          DCMP5     10
REXMIT    FIXED        RTT       60
OPEN      YES          ALW      YES
```

```
SNAME socket2
LINK      A
LHOST     host3
RHOST     remotehost1
LPORT     1025          RPORT     2056
SERVER    YES          DCMP5     10
REXMIT    FIXED        RTT       60
OPEN      YES          ALW      YES
```

```
SNAME socket5
LINK      B1
LHOST     host5
RHOST     remotehost1
LPORT     3456          RPORT     3456
SERVER    YES          DCMP5     10
REXMIT    FIXED        RTT       60
OPEN      YES          ALW      YES
```

```
IP Appl Sock/Assoc table is (10 of 4000) 1% full
```

If no TALI sockets are shown in the **rtrv-appl-sock** output, skip steps 3 through 6, and go to step 7.

If TALI sockets are shown in the **rtrv-appl-sock** output, go to step 3.

- Enter the `rtrv-slk` command to display the signaling links in the database. This is an example of the possible output.

```

rlghncxa03w 05-09-28 11:43:04 GMT EAGLE5 34.0.0

LOC LINK LSN          SLC TYPE          L2T          L1          PCR PCR
                                SET BPS        MODE TSET      ECM N1  N2
1211 A   lsn7          0 LIMDS0        1  56000    --- ---    BASIC ---  ---
1211 B   lsn7          1 LIMDS0        1  56000    --- ---    BASIC ---  ---
1211 A1  lsn7          2 LIMDS0        1  56000    --- ---    BASIC ---  ---
1211 B1  lsn7          5 LIMDS0        1  56000    --- ---    BASIC ---  ---
1211 A2  lsn7          3 LIMDS0        1  56000    --- ---    BASIC ---  ---
1211 B2  lsn7          4 LIMDS0        1  56000    --- ---    BASIC ---  ---
1211 A3  lsn7          7 LIMDS0        1  56000    --- ---    BASIC ---  ---
1211 B3  lsn7          6 LIMDS0        1  56000    --- ---    BASIC ---  ---
1213 A   lsnx25        0 LIMDS0        1  56000    --- ---    BASIC ---  ---
1214 A   lsnx25        1 LIMDS0        1  56000    --- ---    BASIC ---  ---
1215 A   lsnx25        2 LIMDS0        1  56000    --- ---    BASIC ---  ---
1216 A   lsnx25        3 LIMDS0        1  56000    --- ---    BASIC ---  ---
1101 A   lsn2214       2 LIMDS0       11  56000    --- ---    BASIC ---  ---
1101 B   lsn2244       2 LIMDS0       11  56000    --- ---    BASIC ---  ---
1102 A   ls789         0 LIMDS0       11  56000    --- ---    BASIC ---  ---
1102 B   lss789        0 LIMDS0       11  56000    --- ---    BASIC ---  ---
1103 A   ls7890        0 LIMDS0       11  56000    --- ---    BASIC ---  ---
1103 B   lss7890      0 LIMDS0       11  56000    --- ---    BASIC ---  ---

LOC LINK LSN          SLC TYPE          LP          ATM
                                SET BPS        TSEL        VCI  VPI  LL

LOC LINK LSN          SLC TYPE          LP          ATM
                                SET BPS        TSEL        VCI  VPI  CRC4 SI SN
                                E1ATM

No Links Set up.

LOC LINK LSN          SLC TYPE          IPLIML2
1203 A   lsn1          0 IPLIM          SAALTALI
1203 B   lsn1          2 IPLIM          M2PA
1301 B   lsn1          3 IPLIM          SAALTALI
1301 B1  lsn1          10 IPLIM         SAALTALI
1302 A   lsn1          4 IPLIM          SAALTALI

LOC LINK LSN          SLC TYPE
1201 A   lsn6          0 IPGWI
1205 A   lsn4          1 SS7IPGW
1217 A   lsn6          1 IPGWI
1218 A   lsn6          2 IPGWI
1303 A   lsn4          3 SS7IPGW
1305 A   lsn4          2 SS7IPGW
1307 A   lsn4          4 SS7IPGW
1311 A   lsn4          5 SS7IPGW
1313 A   lsn6          3 IPGWI
1315 A   lsn6          4 IPGWI
1107 A   lsn4          0 SS7IPGW

LOC LINK LSN          SLC TYPE          L2T          PCR PCR  E1  E1
                                SET BPS        ECM  N1  N2  LOC PORT TS
                                L2T          PCR PCR  T1  T1
                                SET BPS        ECM  N1  N2  LOC PORT TS

SLK table is (34 of 1200) 3% full.

```

Configuring Destination Tables

If no signaling links are assigned to cards running the IPGWI application (shown with the entry **IPGWI** in the **TYPE** column), skip steps 4 through 6, and go to step 7.

If signaling links are assigned to cards running the IPGWI application (shown with the entry **IPGWI** in the **TYPE** column), go to step 4.

4. Display the IP links in the database by entering the **rtrv-ip-lnk** command with the card location of one of the signaling links running the IPGWI application shown in step 3. For this example, enter this command.

```
rtrv-ip-lnk:loc=1201
```

This is an example of the possible output.

```
rlghncxa03w 05-09-28 11:43:04 GMT EAGLE5 34.0.0
LOC  PORT  IPADDR          SUBMASK          DUPLEX  SPEED  MACTYPE  AUTO  MCAST
1201 A    192.69.1.1      255.255.255.0    HALF    10     DIX      NO    NO
1201 B    -----          -----          HALF    10     DIX      NO    NO
```

5. Display the IP host associated with the IP address shown in step 4 by entering the **rtrv-ip-host** command with the IP address shown in step 4. For this example, enter this command.

```
rtrv-ip-host:ipaddr=192.69.1.1
```

This is an example of the possible output.

```
rlghncxa03w 05-09-28 11:43:04 GMT EAGLE5 34.0.0

LOCAL IPADDR      LOCAL HOST
192.69.1.1        HOST2

IP Host table is (5 of 512) 1% full
```

6. Display the TALI sockets assigned to the IP host displayed in step 5 by entering the **rtrv-appl-sock** command with the host name displayed in the **HOST** column in step 5. For this example, enter this command.

```
rtrv-appl-sock:lhost=host2
```

This is an example of the possible output.

```
rlghncxa03w 05-09-28 11:43:04 GMT EAGLE5 34.0.0

SNAME socket1
LINK      A
LHOST     host2
RHOST     remotehost1
LPORT     1024          RPORT     1024
SERVER    YES            DCMPMS    10
REXMIT    FIXED         RTT       60
OPEN      NO            ALW       NO
```

```
IP Appl Sock/Assoc table is (10 of 4000) 1% full
```

Perform the “Removing an Application Socket” procedure in the *Database Administration Manual - IP⁷ Secure Gateway* and remove the sockets shown in this step.

If all the cards running the IPGWI application shown in the `rtrv-slk` output in step 3 have been checked for TALI socket assignments, go to step 7.

If all the cards running the IPGWI application shown in the `rtrv-slk` output in step 3 have not been checked for TALI socket assignments, repeat steps 4, 5, and 6.

NOTE: If the `rtrv-ctrl-feat` output in step 1 shows any controlled features, skip steps 7 through 10, and go to step 11. If the `rtrv-ctrl-feat` output shows only the IPGWx Signaling TPS feature with a quantity of 200 and the HC-MIM SLK Capacity feature with a quantity of 64, steps 7 through 10 must be performed.

7. Display the serial number in the database with the `rtrv-serial-num` command. This is an example of the possible output.

```
rlghncxa03w 05-09-28 21:15:37 GMT EAGLE5 34.0.0
System serial number = nt00001231
```

```
System serial number is not locked.
```

```
rlghncxa03w 05-09-28 21:15:37 GMT EAGLE5 34.0.0
Command Completed
```

NOTE: If the serial number is correct and locked, skip steps 8, 9, and 10, and go to step 11. If the serial number is correct but not locked, skip steps 8 and 9, and go to step 10. If the serial number is not correct, but is locked, this feature cannot be enabled and the remainder of this procedure cannot be performed. Contact the Customer Care Center to get an incorrect and locked serial number changed. Refer to "Customer Care Center" on page 1-8 for the contact information. The serial number can be found on a label affixed to the control shelf (shelf 1100).

8. Enter the correct serial number into the database using the `ent-serial-num` command with the `serial` parameter.

For this example, enter this command.

```
ent-serial-num:serial=<EAGLE 5 SAS's correct serial number>
```

When this command has successfully completed, the following message should appear.

```
rlghncxa03w 05-09-28 21:15:37 GMT EAGLE5 34.0.0
ENT-SERIAL-NUM: MASP A - COMPLTD
```

Configuring Destination Tables

9. Verify that the serial number entered into step 8 was entered correctly using the **rtrv-serial-num** command. This is an example of the possible output.

```
rlghncxa03w 05-09-28 21:15:37 GMT EAGLE5 34.0.0
System serial number = nt00001231
```

```
System serial number is not locked.
```

```
rlghncxa03w 05-09-28 21:15:37 GMT EAGLE5 34.0.0
Command Completed
```

If the serial number was not entered correctly, repeat steps 3 and 4 and re-enter the correct serial number.

-
10. Lock the serial number in the database by entering the **ent-serial-num** command with the serial number shown in step 7, if the serial number shown in step 7 is correct, or with the serial number shown in step 9, if the serial number was changed in step 3, and with the **lock=yes** parameter.

For this example, enter this command.

```
ent-serial-num:serial=<EAGLE 5 SAS's serial number>:lock=yes
```

When this command has successfully completed, the following message should appear.

```
rlghncxa03w 05-09-28 21:15:37 GMT EAGLE5 34.0.0
ENT-SERIAL-NUM: MASP A - COMPLTD
```

-
11. Enable the ITU National and International Spare Point Code Support feature by entering the **enable-ctrl-feat** command. For this example, enter this command.

```
enable-ctrl-feat:partnum=893013601:fak=<ITU National and International Spare Point Code Support feature access key>
```

NOTE: The values for the feature access key (the **fak** parameter) are provided by Tekelec. If you do not have the feature access key for the ITU National and International Spare Point Code Support feature, contact your Tekelec Sales Representative or Account Representative.

When the **enable-ctrl-feat** command has successfully completed, this message should appear.

```
rlghncxa03w 05-09-28 21:15:37 GMT EAGLE5 34.0.0
ENABLE-CTRL-FEAT: MASP A - COMPLTD
```

12. Turn the ITU National and International Spare Point Code Support feature on by entering the **chg-ctrl-feat** command with the part number used in step 11 and the **status=on** parameter.



CAUTION: Once the ITU National and International Spare Point Code Support feature is turned on, it cannot be turned off.

For this example, enter this command.

```
chg-ctrl-feat:partnum=893013601:status=on
```

When this command has successfully completed, the following message should appear.

```
rlghncxa03w 05-09-28 21:15:37 GMT EAGLE5 34.0.0
CHG-CTRL-FEAT: MASP A - COMPLTD
```

13. Verify the changes by entering the **rtrv-ctrl-feat** command. This is an example of the possible output.

```
rlghncxa03w 05-09-28 21:15:37 GMT EAGLE5 34.0.0
The following features have been permanently enabled:
```

Feature Name	Partnum	Status	Quantity
Spare Point Code Support	893013601	on	----

The following features have been temporarily enabled:

Feature Name	Partnum	Status	Quantity	Trial Period Left
Zero entries found.				

The following features have expired temporary keys:

Feature Name	Partnum
Zero entries found.	

14. Back up the new changes, using the **chg-db:action=backup:dest=fixed** command. These messages should appear; the active Maintenance and Administration Subsystem Processor (MASP) appears first.

```
BACKUP (FIXED): MASP A - Backup starts on active MASP.
BACKUP (FIXED): MASP A - Backup on active MASP to fixed disk complete.
BACKUP (FIXED): MASP A - Backup starts on standby MASP.
BACKUP (FIXED): MASP A - Backup on standby MASP to fixed disk complete.
```

15. To begin adding ITU-I or 14-bit ITU-N spare point codes, perform the "Adding a Point Code to the Self-Identification of the EAGLE 5 SAS" procedure on page 2-81.
-

Configuring Destination Tables

Flowchart 2-3. Activating the ITU National and International Spare Point Code Support Feature (Sheet 1 of 4)

NOTE: Before executing this procedure, make sure you have purchased the ITU National and International Spare Point Code Support feature. If you are not sure if you have purchased the ITU National and International Spare Point Code Support feature, contact your Tekelec Sales Representative or Account Representative.

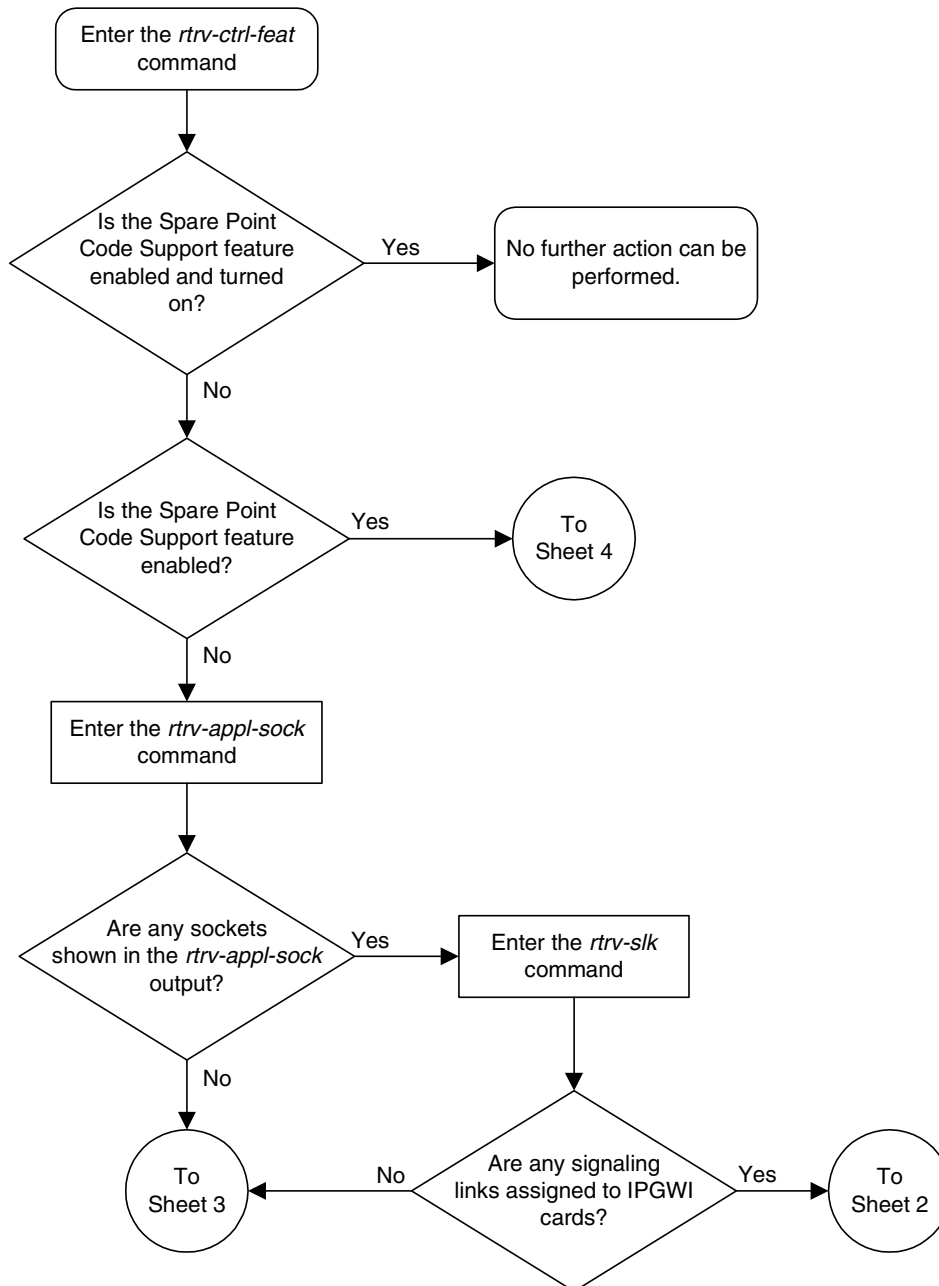

Flowchart 2-3. Activating the ITU National and International Spare Point Code Support Feature (Sheet 2 of 4)

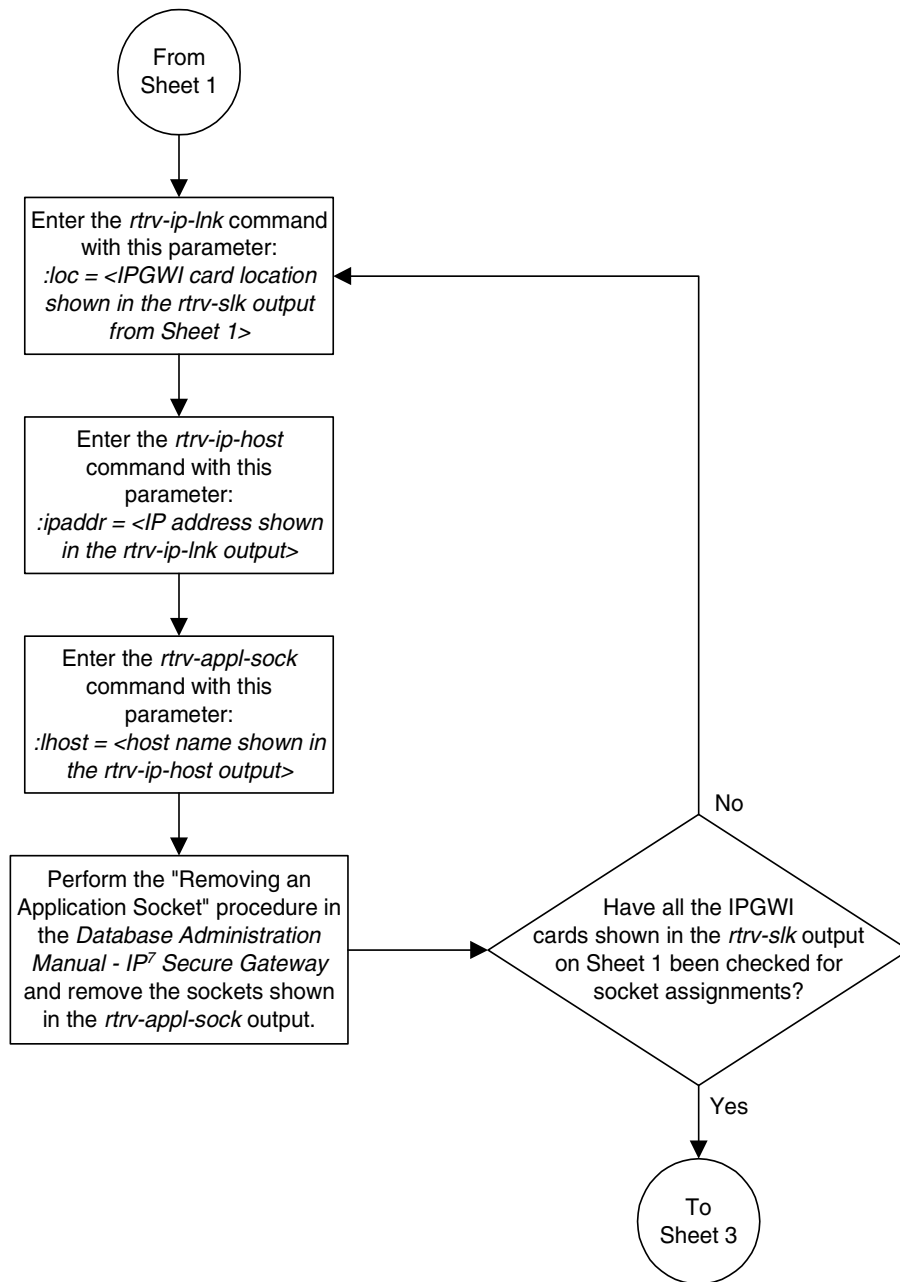

Flowchart 2-3. Activating the ITU National and International Spare Point Code Support Feature (Sheet 3 of 4)

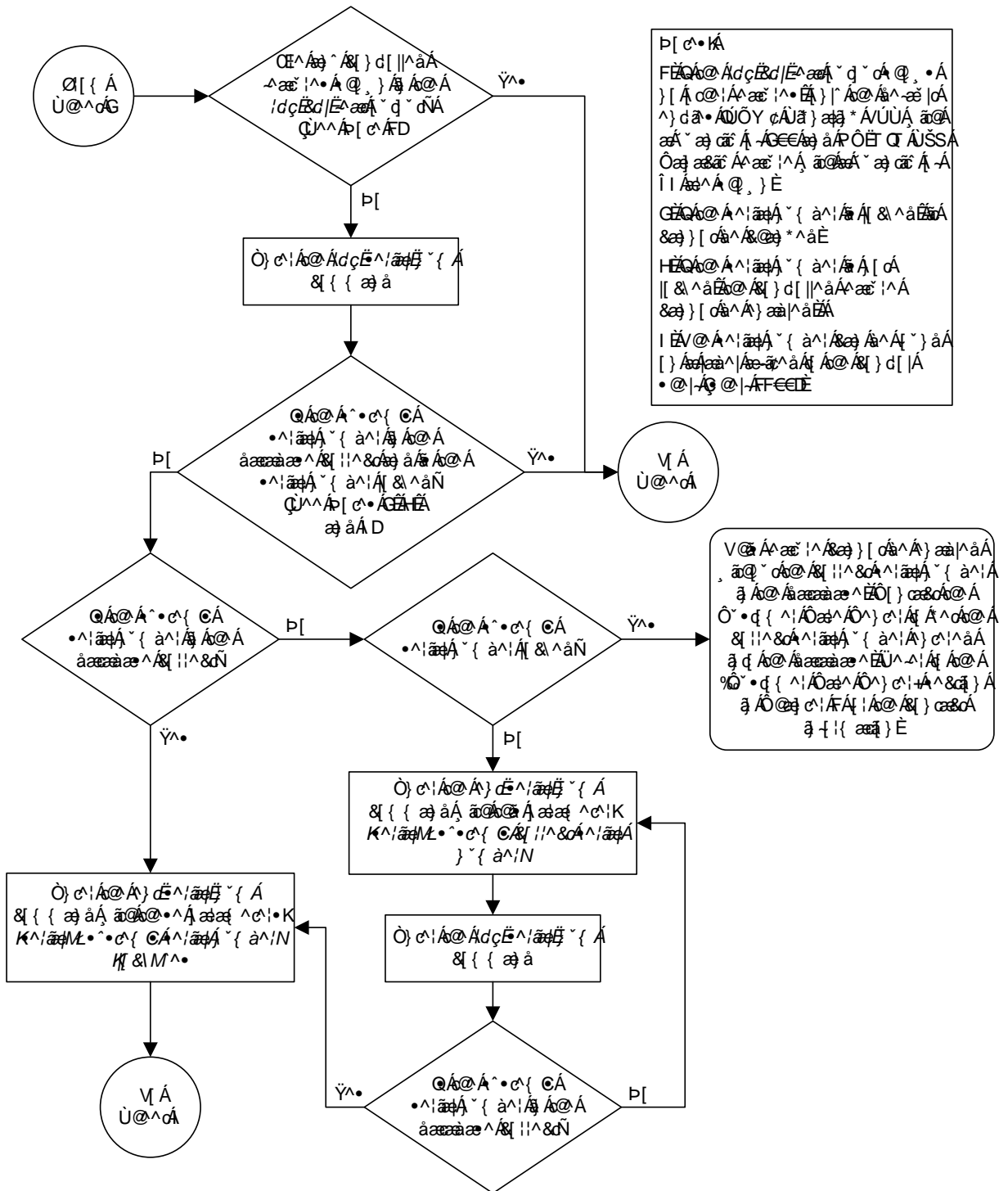

Flowchart 2-3. Activating the ITU National and International Spare Point Code Support Feature (Sheet 4 of 4)

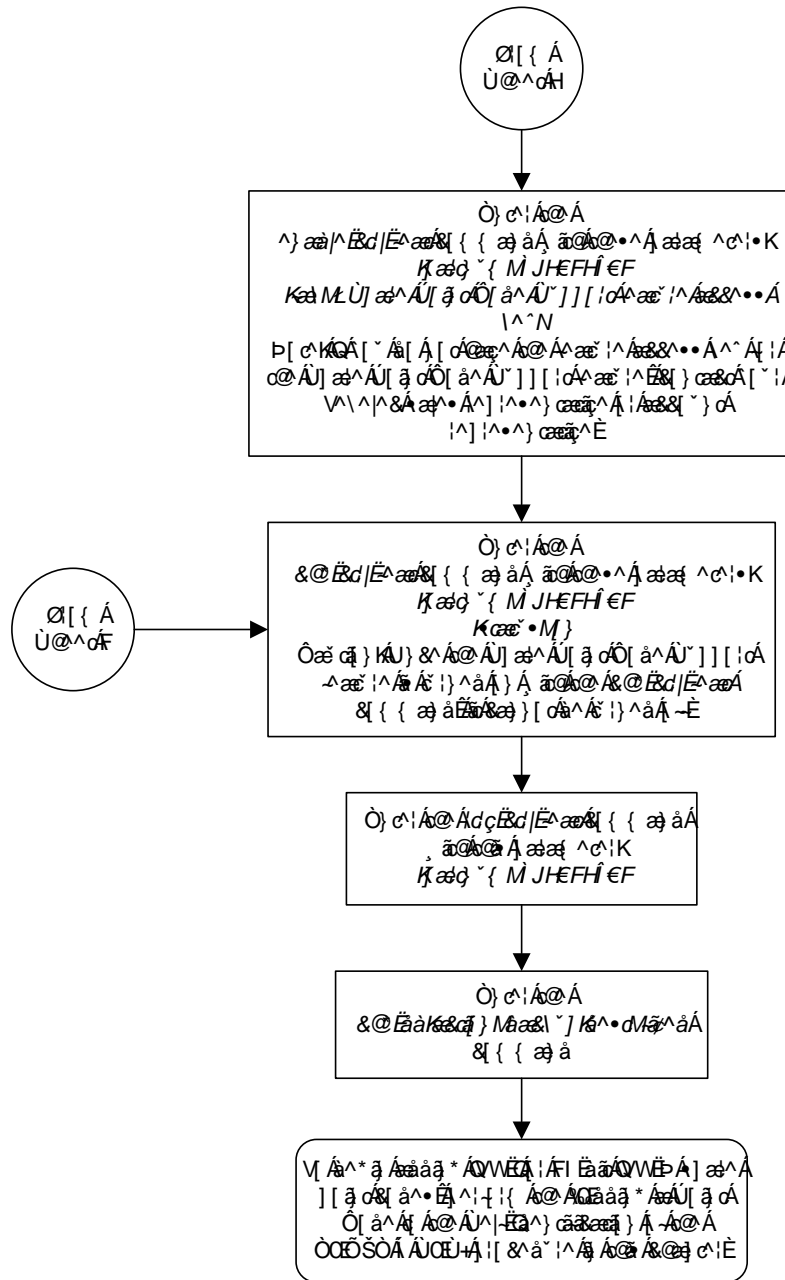

Multiple Point Code Support

Currently, the EAGLE 5 SAS supports six true point codes:

- ANSI point code
- ITU international point code
- ITU international spare point code
- 14-bit ITU national point code
- 14-bit ITU national spare point code
- 24-bit ITU national point code.

NOTE: The ITU national point code can be either 14-bit ITU national - spare and non-spare - or 24-bit ITU national. Both 14-bit ITU national and 24-bit national point codes cannot be present in the EAGLE 5 SAS at the same time.

In addition, the EAGLE 5 SAS supports up to 96 capability point codes, each of which can be designated as either ANSI, ITU-I (spare and non-spare), 14-bit ITU-N (spare and non-spare), or 24-bit ITU-N. Each capability point code defined on an EAGLE 5 SAS node can be used for routing messages to that node. For various reasons, customers might need the EAGLE 5 SAS to support more than one true point code in a particular domain.

There are three main reasons driving this feature:

1. Some customers desire to collapse multiple existing STP's into one EAGLE 5 SAS. This can present problems in that end offices and other nodes may not be controlled by the carrier making reprovisioning of these network elements difficult. Multiple Point Code (MPC) support is designed to allow the EAGLE 5 SAS to assume more than one point code for SS7 routing. MPC support is different in concept from capability point codes in that provisioning and routing will use secondary point codes as if they were the actual point code of the EAGLE 5 SAS.
2. Several customers in the international market want to deploy a single STP pair in multiple national (ITU-N) networks. This may not be possible without the MPC feature, as these operators are often forced to use a unique point code assigned by each national regulator of these target countries.
3. Customers may require additional links between two nodes beyond the number of links permitted by the protocol. For example, the maximum number of links between two nodes in an ITU network is 16. The MPC feature can allow for additional linksets between these nodes, increasing the number of links that can be used.

This feature adds the ability to support Secondary Point Codes (SPCs) in addition to the true point codes used by the EAGLE 5 SAS in any of the three domains ANSI, ITU-N (14-bit or 24-bit) and ITU-I. Secondary point codes are used by provisioning and routing as if they are the true point code of the EAGLE 5 SAS. SPCs are supported for any type of link (A, B, C, D, etc.). There is no effect on provisioning capability point codes as a result of this feature.

In addition to the one True Point Code (TPC) already supported for each of the ANSI, ITU-N (14-bit or 24-bit) and ITU-I domains, the EAGLE 5 SAS support a pool of 40 Secondary Point Codes (SPC), each of which may be assigned as either ANSI, ITU-I, 14-bit ITU-N, or 24-bit ITU-N (not to exceed a total of 40 in one EAGLE 5 SAS). SPCs can be used in the same ways that true PCs are used.

Replacing Two STP Pairs with One Pair

The following example shows how an EAGLE 5 SAS pair can replace two existing STP pairs. In this example, each EAGLE 5 SAS in the pair uses one true point code and one secondary point code.

As shown in Figure 2-5, a new EAGLE 5 SAS first replaces one existing STP pair. In this case, EAGLE 5 SAS's true point code is set to the true point code of the old STP. The adjacent nodes are cut over to the EAGLE 5 SAS pair. The adjacent nodes do not need to be reconfigured.

Figure 2-5. Replacing the First STP Pair

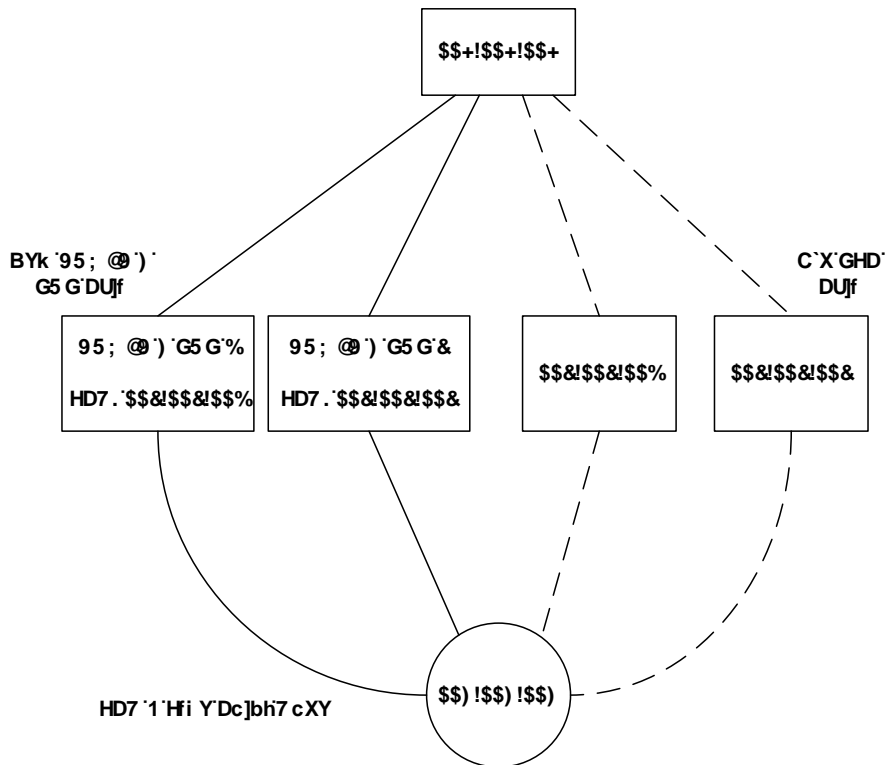

Configuring Destination Tables

Next, a second STP pair is replaced with the EAGLE 5 SAS pair. As shown in Figure 2-6 on page 2-58, an SSP and an STP are being “re-homed” from an old STP pair to a new EAGLE 5 SAS pair. In this example, the STP (003-003-003) is reconfigured with new routes to recognize that it is now connected to EAGLE 5 SAS 1 and EAGLE 5 SAS 2 instead of 001-001-001 and 001-001-002. STP 003-003-003, if not an EAGLE 5 SAS with Multiple Point Codes, may not be able to support more than one linkset to the same point code. See the “Multiple Linksets between Two Nodes” section on page 2-58 for a description of this capability. The interconnecting device (STP or SSP) can use either the TPC or SPC as the device requires.

At EAGLE 5 SAS 1, the user would configure the secondary point code 001-001-001, using the `ent-spc` command. The user would also configure a route to 001-001-002 over the C-linkset. The user would then configure point code 004-004-004 in the EAGLE 5 SAS's database to indicate that this point code uses the secondary point code 001-001-001, instead of the EAGLE 5 SAS's true point code (`chg-dstn:dpc=004-004-004:spc=001-001-001`). This last step would be repeated for all other adjacent SSPs and SCPs that are re-homed from the old STP Pair to the new EAGLE 5 SAS Pair.

Similarly, at EAGLE 5 SAS 2, the user would configure the secondary point code 001-001-002, and configure a route over the C-link to 001-001-001. The user would also configure point code 004-004-004 in EAGLE 5 SAS 2's database to indicate that this point code uses the secondary point code 001-001-002, instead of the EAGLE 5 SAS's true point code.

When EAGLE 5 SAS 1 receives a message from the SSP destined for 001-001-001, the EAGLE 5 SAS processes the message as if the message was sent to the EAGLE 5 SAS's true point code.

When EAGLE 5 SAS 1 generates a message (for example, network management, link test messages, or GTT messages) that is destined for 004-004-004, EAGLE 5 SAS 1 puts the OPC 001-001-001 in the message. When EAGLE 5 SAS 1 generates a message that is destined for 003-003-003 or 005-005-005, it puts the OPC 002-002-001 in the message. When EAGLE 5 SAS 1 generates GTT and SCMG messages that are destined for non-adjacent point codes, it includes the OPC 002-002-001 in the message.

Figure 2-6. Replacing a Second STP Pair

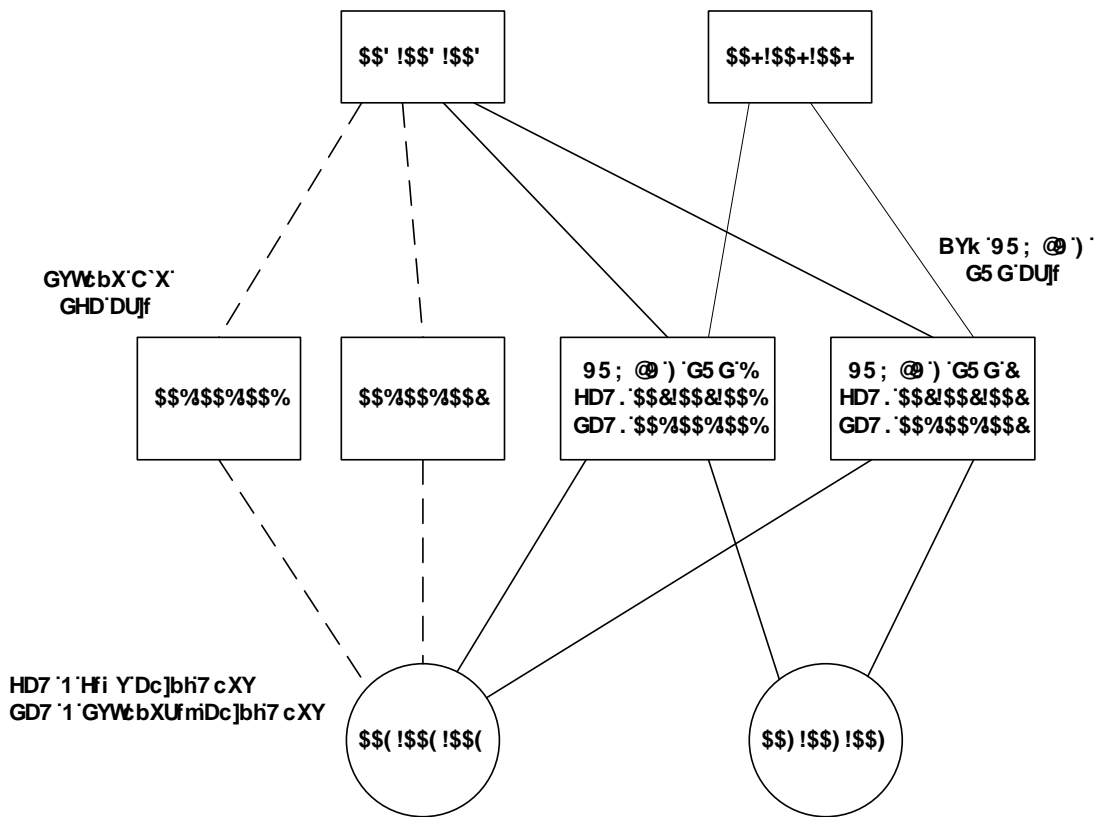

Multiple Linksets between Two Nodes

With this feature, it is possible to configure multiple linksets between two nodes, if the adjacent node also supports Multiple Point Codes. The EAGLE 5 SAS continues to enforce the rule that each linkset must have a different adjacent point code.

One reason for provisioning multiple linksets between two nodes is to increase the number of links that can be configured between STP pairs. For example, in Figure 2-7, the EAGLE 5 SAS is connected to an STP pair that supports multiple point codes. Without this feature, only 16 ITU links can be configured between the EAGLE 5 SAS and the STP pair (8 links in LS1 and 8 links in LS2). In this example, two linksets are added, increasing the number of links to 32 (8 links in each of LS1, LS2, LS3, and LS4).

Figure 2-7. Multiple Linkset Example

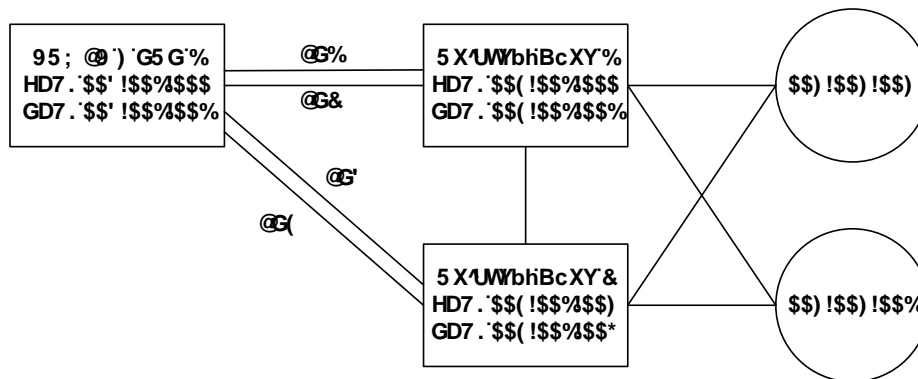

In this example, the adjacent point code (APC) for LS1 is 4-1-0 and the APC for LS2 is 4-1-1. 4-1-1 is assigned an SPC of 3-1-1. So adjacent, Adj Node1 sees LS1 as having an APC of 3-1-0, and LS2 as having an APC of 3-1-1.

To load balance over these 4 linksets, half the destinations that use the STP pair can be assigned LS1 and LS3 as a combined linkset. The other half of the destinations can be assigned LS2 and LS4 as a combined linkset.

The commands to provision EAGLE 5 SAS1 for the network shown in Figure 2-7 are:

```

chg-sid:pc=3-1-0
ent-spc=3-1-1
ent-dstn:dpc=4-1-0
ent-dstn:dpc=4-1-1:spc=3-1-1
ent-dstn:dpc=4-1-5
ent-dstn:dpc=4-1-6:spc=3-1-1
ent-dstn:dpc=5-5-1
ent-dstn:dpc=5-5-5
ent-ls:lsn=ls1:apc=4-1-0
ent-ls:lsn=ls2:apc=4-1-1
ent-ls:lsn=ls3:apc=4-1-5
ent-ls:lsn=ls4:apc=4-1-6
ent-rte:dpc=4-1-0:lsn=ls1:rc=10
ent-rte:dpc=4-1-1:lsn=ls2:rc=10
ent-rte:dpc=4-1-5:lsn=ls3:rc=10
ent-rte:dpc=4-1-6:lsn=ls4:rc=10
ent-rte:dpc=5-5-1:lsn=ls1:rc=10
ent-rte:dpc=5-5-1:lsn=ls3:rc=10
    
```

```
ent-rte:dpc=5-5-5:lsn=ls2:rc=10
```

```
ent-rte:dpc=5-5-5:lsn=ls4:rc=10
```

Local Number Portability

NOTE: Local number portability supports only ANSI point codes.

The EAGLE 5 SAS allows only the true point code to be entered into the mated application table. Also, the EAGLE 5 SAS continues to allow the user to enter translations to the true point code. However, the EAGLE 5 SAS does not allow the user to enter translation to a secondary point code.

If a node sends a **rt-on-gt** query, the node should set the query's DPC to the EAGLE 5 SAS's capability point code. If a node sends an **rt-on-ssn** query, the node should set the query's DPC to the true point code or secondary point code used by that node. If the node has a secondary point code, then the query's DPC is set to the secondary point code. If the node does not have a secondary point code, then the query's DPC is set to the true point code.

rt-on-gt Queries from a Node That Uses Secondary Point Codes

Nodes that send **rt-on-gt** queries should use the capability point code, regardless of whether these nodes use a true or a secondary point code.

1. The node sends a query containing this information:
 - The DPC is the capability point code of the EAGLE 5 SAS's LNP subsystem.
 - The routing indicator in the called party address is GT.
 - The point code in the calling party address is the node's point code.
2. The result of the translation contains this information:
 - The DPC is the EAGLE 5 SAS's true point code.
 - The routing indicator in the called party address is SSN.
 - The subsystem number in the calling party address is the LNP subsystem number.
3. The LNP subsystem sends a reply with this information:
 - The DPC is the calling party address' point code.
 - The OPC is the EAGLE 5 SAS's secondary point code.
 - The routing indicator in the called party address is SSN.

Configuring Destination Tables

In this case, if the local subsystem fails or is taken offline, the EAGLE 5 SAS sends a response method TFP containing this information:

- The DPC is the node's point code.
- The OPC is the EAGLE 5 SAS's secondary point code.
- The concerned point code is the EAGLE 5 SAS's capability point code.

This TFP causes the node to divert traffic to the mate.

If a node sends an `rt-on-gt` query to either the EAGLE 5 SAS's true point code or a secondary point code, the EAGLE 5 SAS cannot divert traffic to the mate. In this case, the EAGLE 5 SAS does not send a TFP concerning the secondary point code or the true point code, so the node will not divert traffic to the mate.

rt-on-ssn queries from a Node That Uses Secondary Point Codes

It is possible that nodes using a secondary point code will send `rt-on-ssn` queries. In this case, these nodes should send the queries to the secondary point code. The EAGLE 5 SAS will accept `rt-on-ssn` queries from these nodes if the DPC is the true point code or a secondary point code. However, SCCP management will not work correctly if the `rt-on-ssn` queries do not use the true point code or a secondary point code associated with the sending node.

1. Nodes send queries to the EAGLE 5 SAS with this information:
 - The DPC is the EAGLE 5 SAS's secondary point code.
 - The routing indicator in the called party address is SSN.
 - The subsystem number in the called party address is the LNP subsystem number.
 - The subsystem number is the LNP subsystem number.
 - The point code in the calling party address is the node's point code.
2. The LNP subsystem sends a reply with this information:
 - The DPC is the point code in the calling party address.
 - The OPC is the secondary point code.
 - The routing indicator in the called party address is SSN.
 - The point code in the calling party address is the secondary point code.

In this case, if the EAGLE 5 SAS's LNP subsystem fails or is taken offline, the EAGLE 5 SAS broadcasts an SSP (assuming that the node is in the concerned point code group) with this information:

- The DPC is the node's point code.
- The OPC is the secondary point code.
- The affected point code is the secondary point code.
- The affected subsystem number is the LNP subsystem number.

Limitations

1. The same adjacent point code cannot be used for two different links.
2. Local EAGLE 5 SAS subsystems (for example, LNP) must use the True Point Code.

Adding a Secondary Point Code

This procedure is used to add a secondary point code to the database using the `ent-spc` command.

The `ent-spc` command uses only one parameter: `spc/spca/spci/spcn/spcn24` – the secondary point code.

NOTE: See “Point Code Formats” on page 2-4 for a definition of the point code types that are used on the EAGLE 5 SAS and for a definition of the different formats that can be used for ITU national point codes.

The secondary point code must be a full point code. Cluster and network routing point codes cannot be specified as a secondary point code.

The Multiple Point Code Support feature must be on to configure secondary point codes in the database. This can be verified with the entry `MPC = on` in the `rtrv-feat` command output. If the Multiple Point Code Support feature is not turned on, enter the `chg-feat:mpc=on` command.

NOTE: Once the Multiple Point Code Support feature is turned on with the `chg-feat` command, it cannot be turned off.

The Multiple Point Code Support feature must be purchased before you turn this feature on with the `chg-feat` command. If you are not sure if you have purchased the Multiple Point Code Support feature, contact your Tekelec Sales Representative or Account Representative.

The database can contain up to 40 secondary point codes.

The secondary point code cannot be defined in the database as the true point code of the EAGLE 5 SAS, a capability point code, a destination point code, or an alias point code. The true point code and capability point codes are shown in the `rtrv-sid` command output. The destination point codes and alias point codes are shown in the `rtrv-dstn` command output.

For the examples in this procedure, these secondary point codes are being added to the database:

ANSI secondary point code = 010-100-010

ITU secondary international point code = 4-100-1

14-bit ITU secondary national point code = 14-15-12-1

The format of the 14-bit ITU national point codes used in these examples is 4-4-4-2.

Canceling the RTRV-DSTN Command

Because the `rtrv-dstn` command used in this procedure can output information for a long period of time, the `rtrv-dstn` commands can be canceled and the output to the terminal stopped. There are three ways that the `rtrv-dstn` command can be canceled:

- Press the **F9** function key on the keyboard at the terminal where the `rtrv-dstn` command was entered.
- Enter the `canc-cmd` without the `trm` parameter at the terminal where the `rtrv-dstn` command was entered.
- Enter the `canc-cmd:trm=<xx>`, where `<xx>` is the terminal where the `rtrv-dstn` command was entered, from another terminal other than the terminal where the `rtrv-dstn` command was entered. To enter the `canc-cmd:trm=<xx>` command, the terminal must allow Security Administration commands to be entered from it and the user must be allowed to enter Security Administration commands. The terminal's permissions can be verified with the `rtrv-secu-trm` command. The user's permissions can be verified with the `rtrv-user` or `rtrv-secu-user` commands.

For more information about the `canc-cmd` command, refer to the *Commands Manual*.

Procedure

1. Display the current secondary point codes, using the `rtrv-spc` command. This is an example of the possible output.

```
rlghncxa03w 05-09-17 16:02:05 GMT EAGLE5 34.0.0
SPC (Secondary Point Codes)

SPCA
    001-010-010
    002-010-010
    003-010-010

SPC-I
    1-253-5
    2-254-6
    3-255-7

SPC-N
    10-01-11-1
    13-02-12-0

SPC-N24

none

Secondary Point Code table is (8 of 40) 20% full
```

If the secondary point code table is full, shown by the entry **Secondary Point Code table is (40 of 40) 100% full**, go to the "Removing a Secondary Point Code" procedure on page 2-74 and remove a secondary point code from the database.

If error message **E3867 Cmd Rej: MPC feature must be enabled** is displayed, the EAGLE 5 SAS has detected that the multiple point code support feature is off and the **rtrv-spc** command will not display any data. Go to step 2 and verify that the multiple point code support feature is off.

-
2. Verify whether or not the multiple point code support feature is on, by entering the **rtrv-feat** command. If the multiple point code support feature is on, the **MPC** field should be set to **on**. For this example, the multiple point code support feature is off.

NOTE: The **rtrv-feat** command output contains other fields that are not used by this procedure. If you wish to see all the fields displayed by the **rtrv-feat** command, see the **rtrv-feat** command description in the *Commands Manual*.

If the multiple point code support feature is on, skip step 3 and go to step 6.

If the **rtrv-feat** command output shows that the multiple point code support feature is on, but error message E3867 was displayed when the **rtrv-spc** command was entered, contact the Customer Care Center. Refer to "Customer Care Center" on page 1-8 for the contact information.

If group codes are to be assigned to the ITU-N secondary point code, and none are currently displayed in the **rtrv-spc** command output, the ITU National Duplicate Point Code feature must be on. This is shown by the entry **ITUDUPPC = on** in the **rtrv-feat** command output.

-
3. Turn the multiple point code support feature on by entering this command.

```
chg-feat:mpc=on
```

NOTE: Once the multiple point code support feature is turned on with the **chg-feat** command, it cannot be turned off.

The multiple point code support feature must be purchased before you turn this feature on with the **chg-feat command. If you are not sure if you have purchased the multiple point code support feature, contact your Tekelec Sales Representative or Account Representative.**

When the **chg-feat** has successfully completed, this message should appear.

```
rlghncxa03w 05-09-07 00:57:31 GMT EAGLE5 34.0.0  
CHG-FEAT: MASP A - COMPLTD
```

NOTE: If group codes are shown for the 14-bit ITU-N secondary point codes in the `rtrv-spc` command output, if 24-bit ITU-N secondary point codes are being configured, or the ITU National Duplicate Point Code feature is on, skip this step and go to step 5.

4. Turn the ITU National Duplicate Point Code feature on by entering this command.

```
chg-feat:ituduppc=on
```

NOTE: Once the ITU National Duplicate Point Code feature is turned on with the `chg-feat` command, it cannot be turned off.

NOTE: The ITU National Duplicate Point Code feature must be purchased before you turn this feature on with the `chg-feat` command. If you are not sure if you have purchased the ITU National Duplicate Point Code feature, contact your Tekelec Sales Representative or Account Representative.

When the `chg-feat` has successfully completed, this message should appear.

```
rlghncxa03w 05-09-07 00:57:31 GMT EAGLE5 34.0.0
CHG-FEAT: MASP A - COMPLTD
```

5. Display the self-identification of the EAGLE 5 SAS using the `rtrv-sid` command to verify the point code values in the self-identification of the EAGLE 5 SAS, and to verify the point code types defined in the EAGLE 5 SAS. This is an example of the possible output.

```
rlghncxa03w 05-09-10 11:43:04 GMT EAGLE5 34.0.0
  PCA          PCI          PCN          CLLI          PCTYPE
  100-100-100  3-75-7          7-9-8-1      rlghncxa03w  OTHER

  CPCA
  002-002-002  002-002-003    002-002-004  002-002-005
  002-002-006  002-002-007    002-002-008  002-002-009
  004-002-001  004-003-003    050-060-070

  CPCA (LNP)
  005-005-002  005-005-004    005-005-005

  CPCI
  1-002-1      1-002-2        1-002-3      1-002-4
  2-001-1      7-222-7

  CPCN
  2-0-10-3     2-0-11-0       2-0-11-2     2-0-12-1
  2-2-3-3     2-2-4-0        10-14-10-1
```

To enter an ANSI secondary code with the `ent-spc` command, a point code must be shown in the `PCA` field of the `rtrv-sid` command output.

To enter an ITU-I secondary point code with the `ent-spc` command, a point code must be shown in the `PCI` field of the `rtrv-sid` command output.

To enter a 14-bit ITU-N secondary point code with the `ent-spc` command, a point code must be shown in the `PCN` field of the `rtrv-sid` command output.

Configuring Destination Tables

To enter a 24-bit ITU-N secondary point code with the **ent-spc** command, a point code must be shown in the **PCN24** field of the **rtrv-sid** command output.

If the required type of point code is shown in the **rtrv-spc** output in step 1 or is shown in the **rtrv-sid** output in this step, go to step 6.

If the required type of point code is not shown in the **PCA**, **PCI**, **PCN**, or **PCN24** fields of the **rtrv-sid** command output, go to the "Adding a Point Code to the Self-Identification of the EAGLE 5 SAS" procedure on page 2-81 and add the required point codes.

6. Display the current destination point codes, using the **rtrv-dstn** command. This is an example of the possible output.

```
rlghncxa03w 05-09-17 16:02:05 GMT EAGLE5 34.0.0
```

DPCA	CLLI	BEI	ELEI	ALIASI	ALIASN/N24	DOMAIN
030-045-*	rlghncbb010	yes	yes	-----	-----	SS7
111-011-*	rlghncbb000	yes	yes	-----	-----	SS7
240-012-004	rlghncbb001	yes	---	1-111-1	10-13-9-3	SS7
240-012-005	rlghncbb002	yes	---	1-112-2	10-13-10-0	SS7
240-012-006	rlghncbb003	yes	---	1-112-3	10-13-10-1	SS7
240-012-008	-----	yes	---	1-113-5	10-13-10-2	SS7
244-020-004	ls06clli	yes	---	-----	-----	X25
244-020-005	ls07clli	yes	---	-----	-----	X25
244-020-006	ls08clli	yes	---	-----	-----	X25
244-020-007	-----	yes	---	-----	-----	X25
244-020-008	-----	yes	---	-----	-----	X25

DPCI	CLLI	BEI	ELEI	ALIASA	ALIASN/N24	DOMAIN
2-131-1	rlghncbb023	no	---	222-210-000	11-11-8-1	SS7
2-131-2	-----	no	---	222-211-001	11-11-8-2	SS7
2-131-3	-----	no	---	222-211-002	11-11-8-3	SS7

DPCN	CLLI	BEI	ELEI	ALIASA	ALIASI	DOMAIN
10-15-2-3	rlghncbb013	no	---	222-200-200	2-121-1	SS7
10-15-3-0	rlghncbb013	no	---	222-200-201	2-121-2	SS7

DPCN24	CLLI	BEI	ELEI	ALIASA	ALIASI	DOMAIN
DESTINATION ENTRIES ALLOCATED: 2000						
FULL DPC(s): 14						
NETWORK DPC(s): 0						
CLUSTER DPC(s): 2						
TOTAL DPC(s): 16						
CAPACITY (% FULL): 1%						
ALIASES ALLOCATED: 8000						
ALIASES USED: 18						
CAPACITY (% FULL): 1%						
X-LIST ENTRIES ALLOCATED: 500						
RTRV-DSTN: MASP A - COMPLTD						

NOTE: If the `spcn` parameter is not being used in this procedure, skip this step and go to step 8.

7. Display the existing values for the `npcfmti` parameter by entering the `rtrv-stpopts` command. The value for the `npcfmti` parameter is shown in the `NPCFMTI` field. This is an example of the possible output.

```
rlghncxa03w 05-09-17 16:02:05 GMT EAGLE5 34.0.0
STP OPTIONS
-----
NPCFMTI          4-4-4-2
```

NOTE: The `rtrv-stpopts` command output contains other fields that are not used by this procedure. If you wish to see all the fields displayed by the `rtrv-stpopts` command, see the `rtrv-stpopts` command description in the *Commands Manual*.

If you wish to change the format of the 14-bit ITU national point codes, go to “14-Bit ITU National Point Code Formats” section on page 2-10. Changing the formats of the 14-bit ITU national point codes will change how any existing 14-bit ITU national point codes are displayed in the database.

8. Add the secondary point code, using the `ent-spc` command.

The secondary point code being added in this procedure cannot match any of the point code values shown in the `rtrv-sid` output in step 5, and any of the DPC or alias point code values shown in the `rtrv-dstn` output in step 6.

For this example, enter these commands.

```
ent-spc:spca=010-100-010
```

```
ent-spc:spci=4-100-1
```

```
ent-spc:spcn=14-15-12-1
```

When each of these commands has successfully completed, this is an example of the message that should appear.

```
rlghncxa03w 05-09-17 15:35:05 GMT EAGLE5 34.0.0
Destination table is (11 of 40) 28% full
ENT-SPC: MASP A - COMPLTD
```

Configuring Destination Tables

9. Verify the changes using the `rtrv-spc` command. This is an example of the possible output.

```
rlghncxa03w 05-09-17 16:02:05 GMT EAGLE5 34.0.0  
SPC (Secondary Point Codes)
```

```
SPCA  
    001-010-010  
    002-010-010  
    003-010-010  
    010-100-010
```

```
SPC-I  
    1-253-5  
    2-254-6  
    3-255-7  
    4-100-1
```

```
SPC-N  
    10-01-11-1  
    13-02-12-0  
    14-15-12-1
```

```
SPC-N24
```

```
none
```

```
Secondary Point Code table is (11 of 40) 28% full
```

10. Back up the new changes, using the `chg-db:action=backup:dest=fixed` command. These messages should appear; the active Maintenance and Administration Subsystem Processor (MASP) appears first.

```
BACKUP (FIXED) : MASP A - Backup starts on active MASP.  
BACKUP (FIXED) : MASP A - Backup on active MASP to fixed disk complete.  
BACKUP (FIXED) : MASP A - Backup starts on standby MASP.  
BACKUP (FIXED) : MASP A - Backup on standby MASP to fixed disk complete.
```

Flowchart 2-4. Adding a Secondary Point Code (Sheet 1 of 4)

NOTE: Before executing this procedure, make sure you have purchased the Multiple Point Code Support feature, and if you are assigning a group code to a 14-bit ITU-N secondary point code, the Duplicate ITU-N Point Code Support feature. If you are not sure if you have purchased these features, contact your Tekelec Sales Representative or Account Representative.

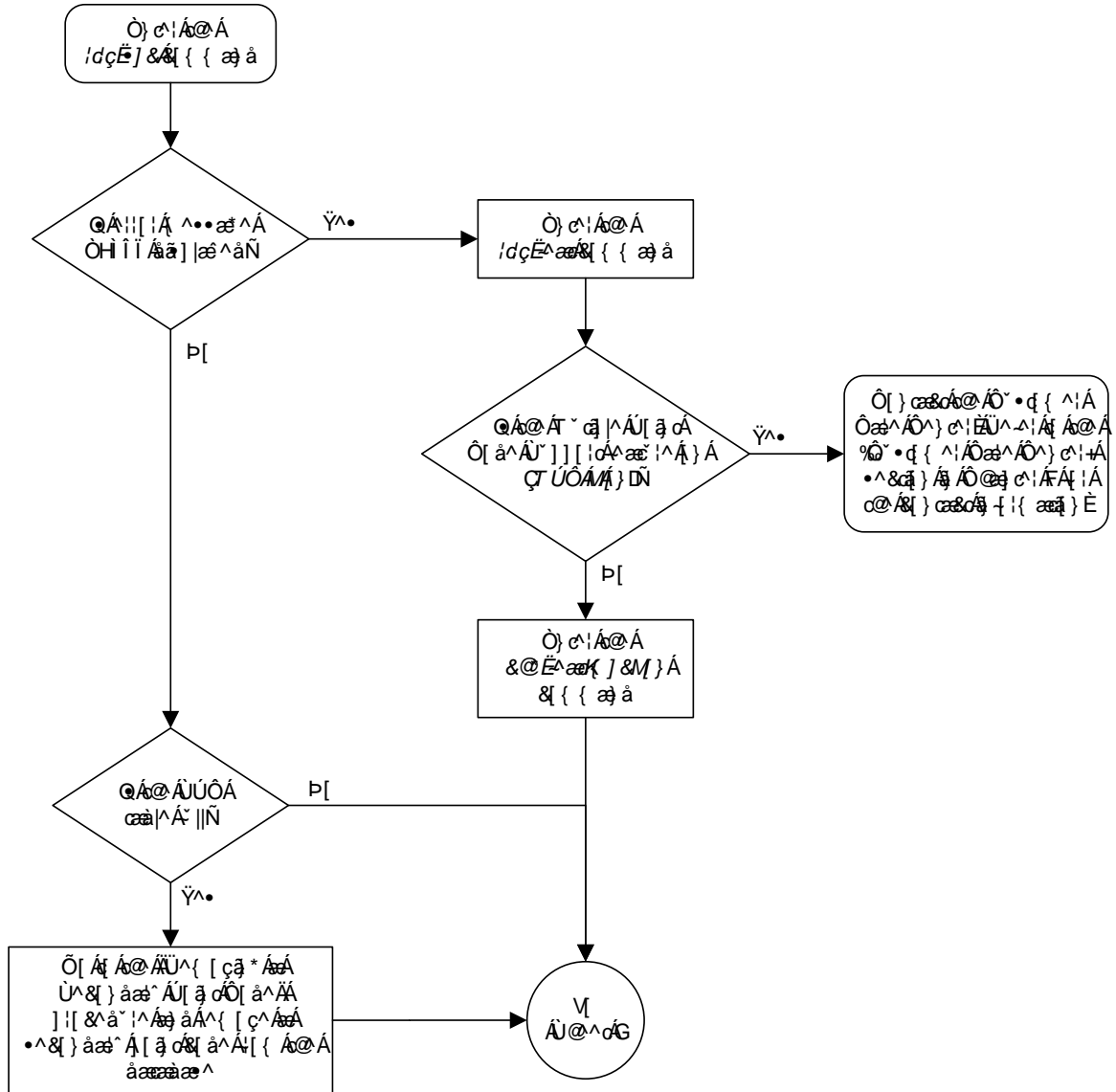

Configuring Destination Tables

Flowchart 2-4. Adding a Secondary Point Code (Sheet 2 of 4)

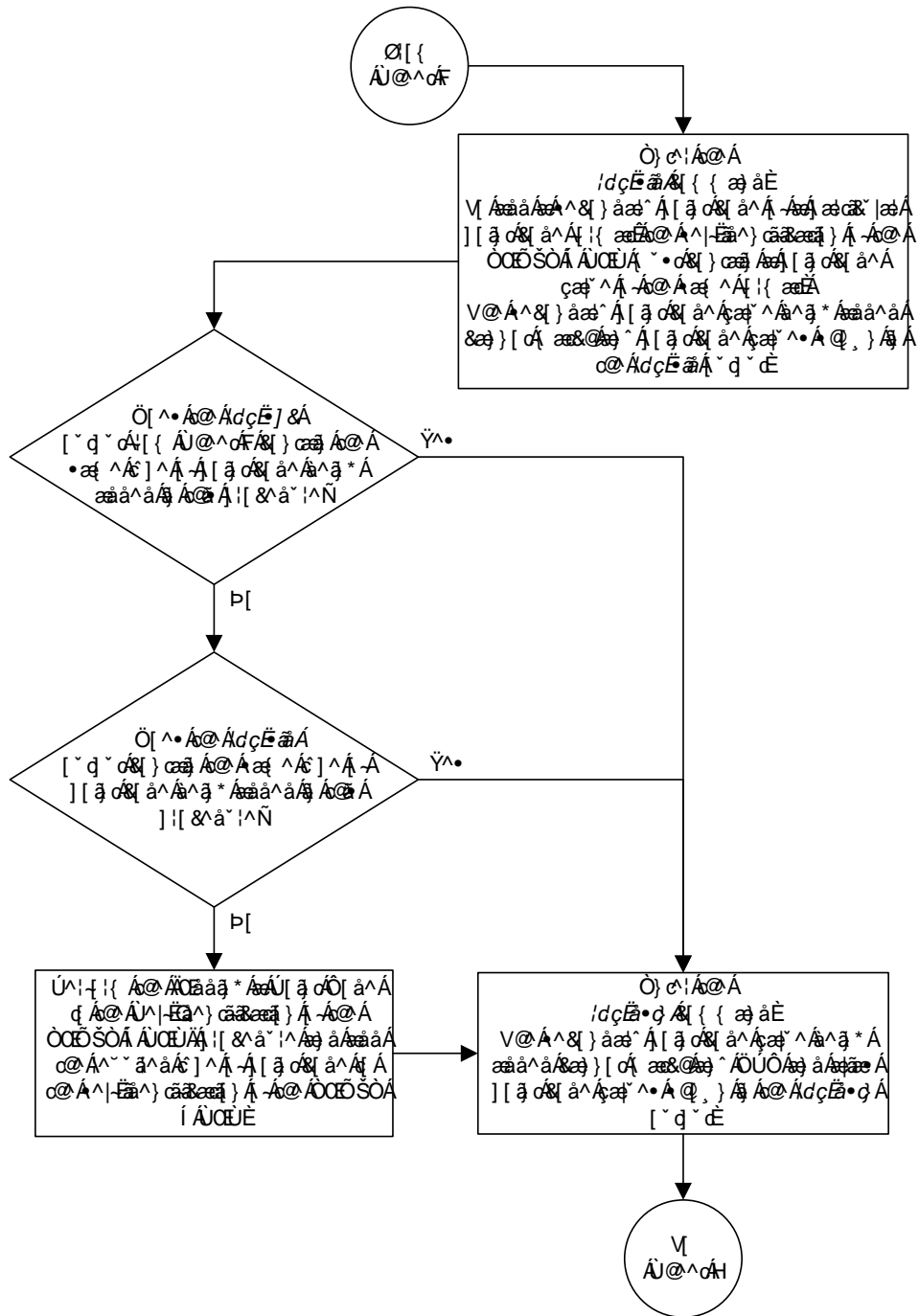

Flowchart 2-4. Adding a Secondary Point Code (Sheet 3 of 4)

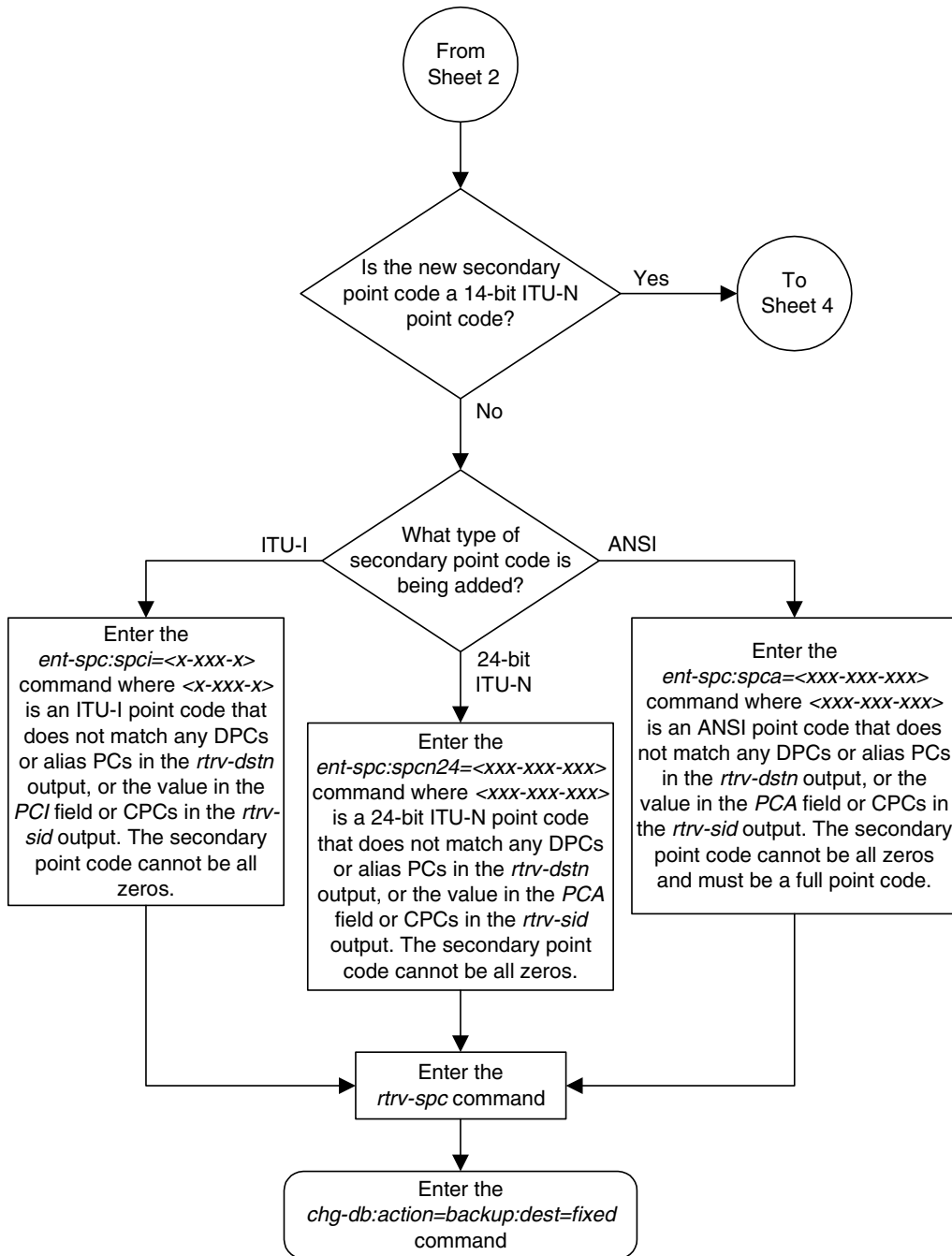

Flowchart 2-4. Adding a Secondary Point Code (Sheet 4 of 4)

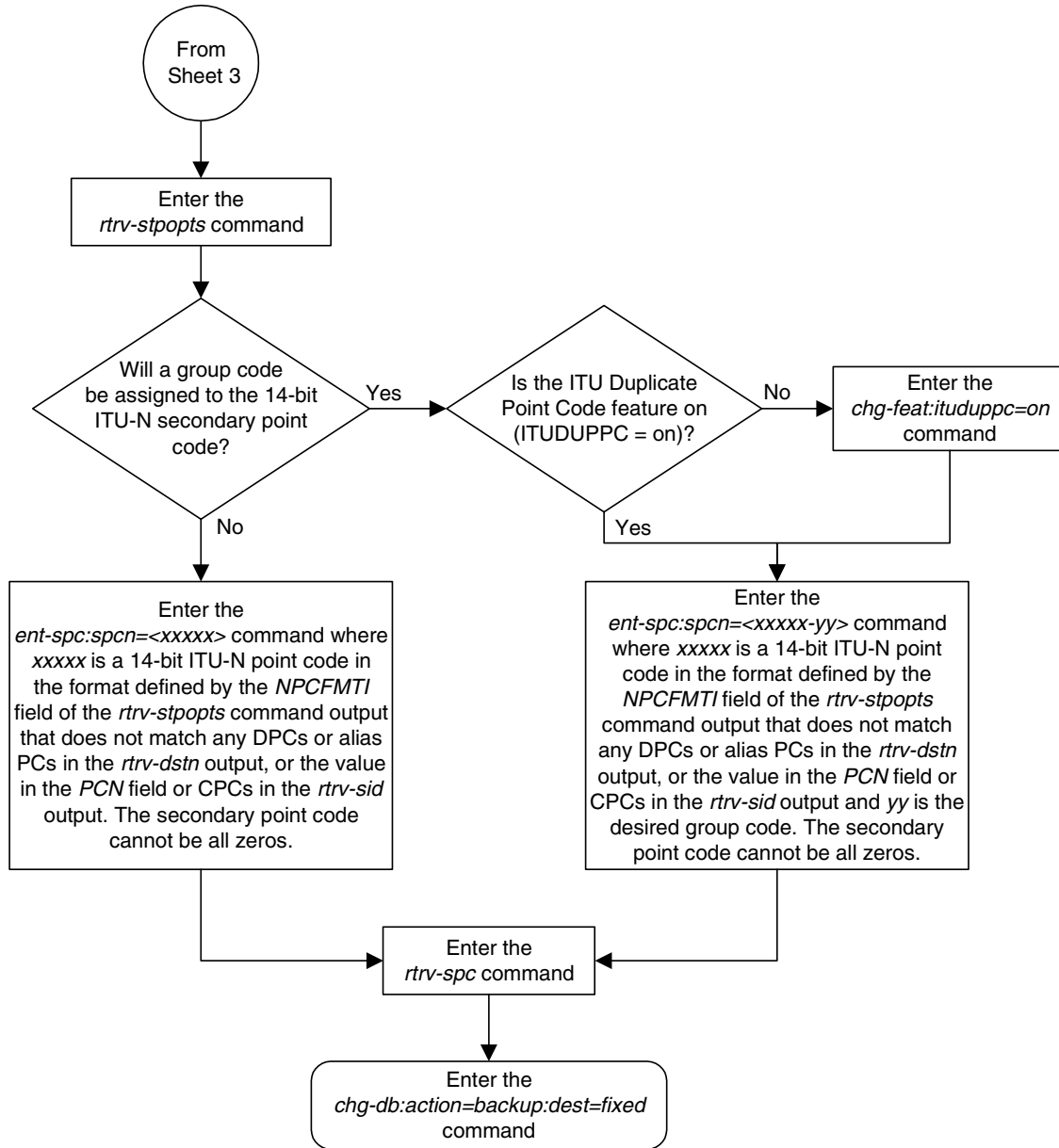

Removing a Secondary Point Code

This procedure is used to remove a secondary point code from the database using the `dlt-spc` command.

The `dlt-spc` command uses only one parameter: `spc/spca/spci/spcn/spcn24` – the secondary point code.

NOTE: See “Point Code Formats” on page 2-4 for a definition of the point code types that are used on the EAGLE 5 SAS and for a definition of the different formats that can be used for ITU national point codes.

The secondary point code being removed from the database must be in the database, but cannot be referenced by any destination point codes. Entering the `rtrv-dstn` command with either the `spca`, `spci`, `spcn`, or `spcn24`, depending on the point code type of the secondary point code being removed from the database, shows the destination point codes that are referencing the secondary point code being removed from the database.

For the example in this procedure, secondary point code 010-100-010 is being removed from the database.

Canceling the RTRV-DSTN Command

Because the `rtrv-dstn` command used in this procedure can output information for a long period of time, the `rtrv-dstn` commands can be canceled and the output to the terminal stopped. There are three ways that the `rtrv-dstn` command can be canceled:

- Press the **F9** function key on the keyboard at the terminal where the `rtrv-dstn` command was entered.
- Enter the `canc-cmd` without the `trm` parameter at the terminal where the `rtrv-dstn` command was entered.
- Enter the `canc-cmd:trm=<xx>`, where `<xx>` is the terminal where the `rtrv-dstn` command was entered, from another terminal other than the terminal where the `rtrv-dstn` command was entered. To enter the `canc-cmd:trm=<xx>` command, the terminal must allow Security Administration commands to be entered from it and the user must be allowed to enter Security Administration commands. The terminal’s permissions can be verified with the `rtrv-secu-trm` command. The user’s permissions can be verified with the `rtrv-user` or `rtrv-secu-user` commands.

For more information about the `canc-cmd` command, refer to the *Commands Manual*.

Procedure

1. Display the secondary point codes in the database, using the **rtrv-spc** command. This is an example of the possible output.

```
rlghncxa03w 05-09-17 16:02:05 GMT EAGLE5 34.0.0
SPC (Secondary Point Codes)
```

```
SPCA
  001-010-010
  002-010-010
  003-010-010
  010-100-010
```

```
SPC-I
  1-253-5
  2-254-6
  3-255-7
  4-100-1
```

```
SPC-N
  10-01-11-1
  13-02-12-0
  14-15-12-1
```

```
SPC-N24
```

```
none
```

```
Secondary Point Code table is (11 of 40) 28% full
```

2. Display the destination point codes that reference the secondary point code being removed from the database using the **rtrv-dstn** command with either the **spca**, **spci**, or **spcn** parameters.

For this example, enter this command.

```
rtrv-dstn:spca=010-100-010
```

This is an example of the possible output.

```
rlghncxa03w 05-09-17 16:02:05 GMT EAGLE5 34.0.0
```

DPCA	CLLI	BEI	ELEI	ALIASI	ALIASN/N24	DOMAIN
240-012-004	rlghncbb001	yes	---	1-111-1	10-13-9-3	SS7

	SPC	NCAI
	010-100-010	no

240-012-005	rlghncbb002	yes	---	1-112-2	10-13-10-0	SS7
-------------	-------------	-----	-----	---------	------------	-----

	SPC	NCAI
	010-100-010	no

```
Destination table is (16 of 2000) 1% full
```

```
Alias table is (9 of 8000) 1% full
```

```
RTRV-DSTN: MASP A - COMPLTD
```

- Remove the reference to the secondary point code using the **chg-dstn** command and specifying the destination point codes shown in step 2 with either the **dpca**, **dpci**, or **dpcn** parameters, and with either the **spca=none**, **spci=none**, or **spcn=none** parameters, depending on the type of point codes being used. For this example, enter these commands.

```
chg-dstn:dpca=240-012-004:spca=none
```

```
chg-dstn:dpca=240-012-005:spca=none
```

When this command has successfully completed, and the cluster routing and management diversity feature is turned off (**CRMD = off** in the **rtrv-feat** command output), this message should appear.

```
rlghncxa03w 05-09-17 15:35:05 GMT EAGLE5 34.0.0
Destination table is (16 of 2000) 1% full
CHG-DSTN: MASP A - COMPLTD
```

If the cluster routing and management diversity feature is turned on (**CRMD = on** in the **rtrv-feat** command output), this message should appear when each command has successfully completed.

```
rlghncxa03w 05-09-17 15:35:05 GMT EAGLE5 34.0.0
DESTINATION ENTRIES ALLOCATED:    2000
  FULL DPC(s):                    14
  NETWORK DPC(s):                  0
  CLUSTER DPC(s):                  2
  TOTAL DPC(s):                    16
  CAPACITY (% FULL):                1%
ALIASES ALLOCATED:                 8000
  ALIASES USED:                     8
  CAPACITY (% FULL):                1%
X-LIST ENTRIES ALLOCATED:          500
CHG-DSTN: MASP A - COMPLTD
```

- Remove the secondary point code, using the **dlt-spc** command. For this example, enter this command.

```
dlt-spc:spca=010-100-010
```

When this command has successfully completed, this is an example of the message that should appear.

```
rlghncxa03w 05-09-17 15:35:05 GMT EAGLE5 34.0.0
Destination table is (10 of 40) 25% full
ENT-SPC: MASP A - COMPLTD
```

Configuring Destination Tables

5. Verify the changes using the `rtrv-spc` command. This is an example of the possible output.

```
rlghncxa03w 05-09-17 16:02:05 GMT EAGLE5 34.0.0
SPC (Secondary Point Codes)
```

```
SPCA
  001-010-010
  002-010-010
  003-010-010
```

```
SPC-I
  1-253-5
  2-254-6
  3-255-7
  4-100-1
```

```
SPC-N
  10-01-11-1
  13-02-12-0
  14-15-12-1
```

```
SPC-N24
```

```
none
```

```
Secondary Point Code table is (10 of 40) 25% full
```

6. Back up the new changes, using the `chg-db:action=backup:dest=fixed` command. These messages should appear; the active Maintenance and Administration Subsystem Processor (MASP) appears first.

```
BACKUP (FIXED) : MASP A - Backup starts on active MASP.
BACKUP (FIXED) : MASP A - Backup on active MASP to fixed disk complete.
BACKUP (FIXED) : MASP A - Backup starts on standby MASP.
BACKUP (FIXED) : MASP A - Backup on standby MASP to fixed disk complete.
```

Flowchart 2-5. Removing a Secondary Point Code (Sheet 1 of 3)

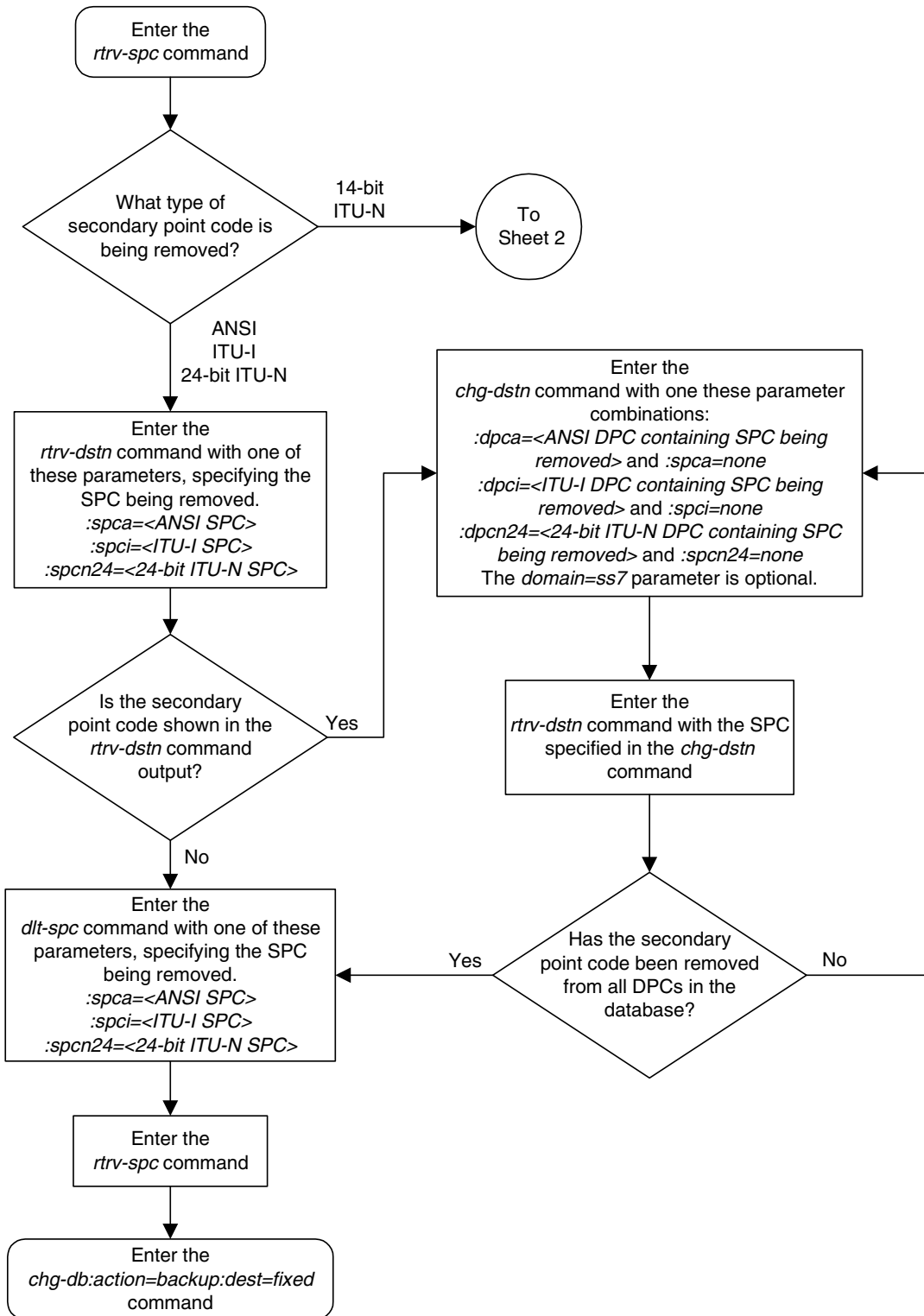

Configuring Destination Tables

Flowchart 2-5. Removing a Secondary Point Code (Sheet 2 of 3)

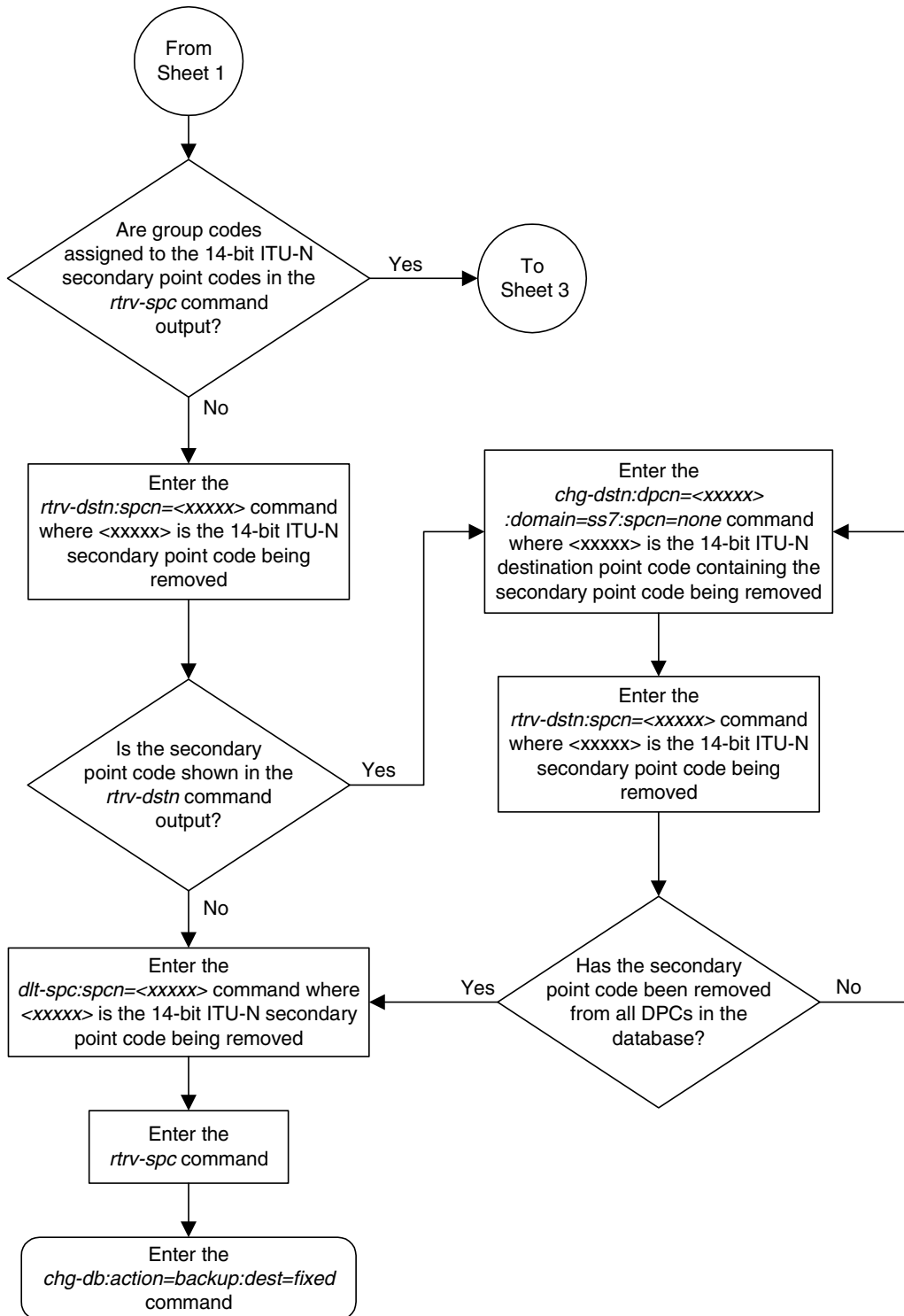

Flowchart 2-5. Removing a Secondary Point Code (Sheet 3 of 3)

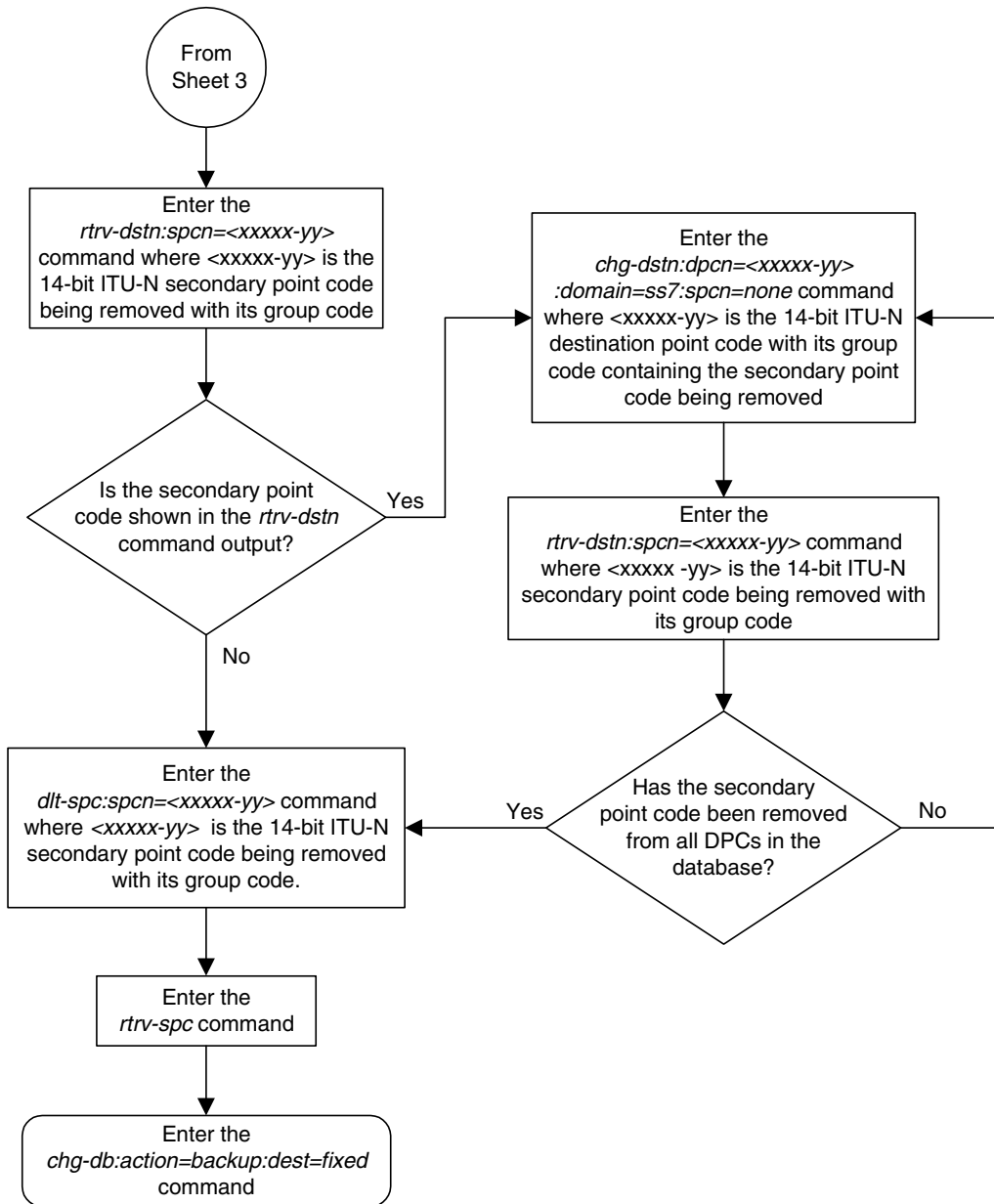

Adding a Point Code to the Self-Identification of the EAGLE 5 SAS

This procedure is used to add a true point code to the self-identification of the EAGLE 5 SAS using the `ent-sid` command. Adding the point code using this procedure instead of the “Changing the Self-Identification of the EAGLE 5 SAS” procedure on page 2-90 does not require the EAGLE 5 SAS to be re-initialized after the point code is added.

However, if you wish to add a capability point code, change an existing true point code, change the CLLI value, or the `pc type` parameter value in the self-identification, the “Changing the Self-Identification of the EAGLE 5 SAS” procedure on page 2-90 must be used.

The `ent-sid` command uses these parameters:

- `:pc/pca` – ANSI point code
- `:pci` – ITU-I or ITU-I spare point code
- `:pcn` – 14-bit ITU-N or 14-bit ITU-N spare point code
- `:pcn24` – 24-bit ITU-N point code

NOTE: See “Point Code Formats” on page 2-4 for a definition of the point code types that are used on the EAGLE 5 SAS and for a definition of the different formats that can be used for ITU national point codes.

The network type of the point code being added in this procedure cannot be the same as the network type of any point codes shown in `PCA`, `PCI`, `PCN`, or `PCN24` columns in the `rtrv-sid` output. For example, if an ANSI point code is shown in the `rtrv-sid` output (a point code in the `PCA` column), then the `pc/pca` parameter cannot be specified in this procedure.

However, the self-identification can contain both spare and non-spare point codes for the `PCI` and `PCN` values. If the `rtrv-sid` output contains an ITU-I point code, but does not contain an ITU-I spare point code, the `pci` parameter can be specified with an ITU-I spare point code value. If spare and non-spare point codes are shown for the `PCI` value, then the `pci` parameter cannot be specified in this procedure. This is also true for 14-bit ITU-N and 14-bit ITU-N spare point codes.

The point code of the EAGLE 5 SAS cannot match the capability point codes of the EAGLE 5 SAS or any destination point codes or alias point codes. Capability point code are shown in the `rtrv-sid` output. Destination point codes and alias point codes are shown in the `rtrv-dstn` output.

The point code of the EAGLE 5 SAS must be a full point code and cannot be a cluster point code. The point code containing all zeros cannot be used as a value for these parameters.

The point code value for the **pcn** parameter (either 14-bit ITU-N or 14-bit ITU-N spare point code) must match the format defined by the **NPCFMTI** parameter of the **rtrv-stpopts** output. If group codes are shown for the 14-bit ITU-N point codes in the **rtrv-sid** output, then a group code must be specified with the **pcn** parameter value. The group code must match the group codes shown in the **rtrv-sid** or **rtrv-spc** outputs.

Procedure

1. Display the self-identification of the EAGLE 5 SAS using the **rtrv-sid** command. This is an example of the possible output.

```
rlghncxa03w 05-09-10 11:43:04 GMT EAGLE5 34.0.0
PCA          PCI          PCN          CLLI          PCTYPE
001-001-001  1-200-6        10-13-9-3    rlghncxa03w   OTHER

CPCA
002-002-002    002-002-003    002-002-004    002-002-005
002-002-006    002-002-007    002-002-008    002-002-009
004-002-001    004-003-003    050-060-070

CPCA (LNP)
005-005-002    005-005-004    005-005-005

CPCI
1-002-1        1-002-2        1-002-3        1-002-4
2-001-1        7-222-7

CPCN
2-0-10-3      2-0-11-0      2-0-11-2      2-0-12-1
2-2-3-3      2-2-4-0      10-14-10-1
```

If the network type of the point code being added in this procedure matches the network types of the point codes shown in the **PCA**, **PCI**, **PCN**, or **PCN24** columns, this procedure cannot be performed. Perform the “Changing the Self-Identification of the EAGLE 5 SAS” procedure on page 2-90 to change the point codes shown in these columns.

Configuring Destination Tables

NOTE: If an ITU-I or 14-bit ITU-N spare point code is displayed in the `rtrv-sid` output in step 1, or if an ITU-I or 14-bit ITU-N spare point code is not being added in this procedure, skip step 2 and go to step 3.

2. Verify whether or not the ITU National and International Spare Point Code Support feature is enabled by entering the `rtrv-ctrl-feat` command with the part number of this feature. Enter this command.

```
rtrv-ctrl-feat:partnum=893013601
```

This is an example of the possible output.

```
rlghncxa03w 05-09-28 21:15:37 GMT EAGLE5 34.0.0
The following features have been permanently enabled:
```

Feature Name	Partnum	Status	Quantity
Spare Point Code Support	893013601	on	----

The following features have been temporarily enabled:

Feature Name	Partnum	Status	Quantity	Trial Period Left
Zero entries found.				

The following features have expired temporary keys:

Feature Name	Partnum
Zero entries found.	

If the ITU National and International Spare Point Code Support feature is not enabled, perform the “Activating the ITU National and International Spare Point Code Support Feature” procedure on page 2-42 to enable the ITU National and International Spare Point Code Support feature.

NOTE: If the `pcn` parameter is not being used in this procedure, skip this step and step 4, and go to step 5.

3. Display the existing values for the `npcfmti` parameter, by entering the `rtrv-stpopts` command. The value for the `npcfmti` parameter is shown in the `NPCFMTI` field. This is an example of the possible output.

```
rlghncxa03w 05-09-17 16:02:05 GMT EAGLE5 34.0.0
STP OPTIONS
-----
NPCFMTI          4-4-4-2
```

NOTE: The `rtrv-stpopts` command output contains other fields that are not used by this procedure. If you wish to see all the fields displayed by the `rtrv-stpopts` command, see the `rtrv-stpopts` command description in the *Commands Manual*.

NOTE: If the `rtrv-sid` output in step 1 shows group codes assigned to the 14-bit ITU-N point codes, then a group code must be assigned to the `pcn` parameter value specified in this procedure. This group code must be shown in either the `rtrv-sid` output or the `rtrv-spc` output. If the group code being assigned to the `pcn` parameter value is shown in the `rtrv-sid` output, skip this step and go to step 5.

4. Display the secondary point codes in the database, using the `rtrv-spc` command. This is an example of the possible output.

```
rlghncxa03w 05-09-07 11:43:04 GMT EAGLE5 34.0.0
SPC (Secondary Point Codes)
```

```
SPCA
```

```
001-010-010
002-010-010
003-010-010
010-100-010
```

```
SPC-I
```

```
1-253-5
2-254-6
3-255-7
4-100-1
```

```
SPC-N
```

```
10-01-11-1
13-02-12-0
14-15-12-1
```

```
SPC-N24
```

```
none
```

5. Verify whether or not the point code being added in this procedure is a DPC value in the DPC table by entering the `rtrv-dstn` command and specifying the point code value that is being added in this procedure. For this example, enter these commands.

```
rtrv-dstn:dpci=s-3-75-7
```

```
rtrv-dstn:dpcn=s-7-9-8-1
```

When each of these commands have been executed, the following output is displayed showing that the specified point code is not in the DPC table.

```
rlghncxa03w 05-09-28 21:16:37 GMT EAGLE5 34.0.0
```

```
DPCA          CLLI          BEI ELEI    ALIASI          ALIASN/N24    DOMAIN
```

```
No destinations meeting the requested criteria were found
```

```
Destination table is (22 of 2000) 1% full
```

```
Alias table is (18 of 8000) 1% full
```

Configuring Destination Tables

6. Verify whether or not the point code being added in this procedure is an alias point code in the DPC table by entering the `rtrv-dstn` command and specifying the point code value that is being added in this procedure. For this example, enter these commands.

```
rtrv-dstn:aliasi=s-3-75-7
```

```
rtrv-dstn:aliasn=s-7-9-8-1
```

When each of these commands have been executed, the following output is displayed showing that the specified point code is not an alias point code in the DPC table.

```
rlghncxa03w 05-09-28 21:16:37 GMT EAGLE5 34.0.0
```

```
          DPCA          CLLI          BEI ELEI  ALIASI          ALIASN/N24  DOMAIN
```

```
No destinations meeting the requested criteria were found
```

```
Destination table is (22 of 2000) 1% full
```

```
Alias table is (18 of 8000) 1% full
```

If the point code specified in steps 5 and 6 is shown in the DPC table, choose another point code to add to the self-identification and repeat steps 5 and 6.

If the point code specified in steps 5 and 6 is not shown in the DPC table, go to step 7.

-
7. Add the point code to the self-identification of the EAGLE 5 SAS using the `ent-sid` command with the `pca`, `pci`, `pcn`, or `pcn24` parameters and according to these rules.
 - If the `pcn` parameter is specified with the `ent-sid` command, the `pcn24` parameter cannot be specified.
 - If the `pcn24` parameter is specified with the `ent-sid` command, the `pcn` parameter cannot be specified.
 - For `pcn` parameter values, the format of the point code must match the format defined by the `NPCFMTI` parameter of the `rtrv-stpopts` output. If group codes are shown in the `rtrv-sid` output in step 1, a group code must be assigned to the `pcn` parameter value being added in this procedure. This group code must be shown either in the `rtrv-sid` or `rtrv-spc` output.
 - The point code values must be full point codes.
 - The ITU National and International Spare Point Code Support feature must be enabled to specify an ITU-I or 14-bit ITU-N spare point code.
 - The point code specified in this procedure cannot be defined as a capability point code.
 - See the “ANSI Point Codes” section on page 2-4 for information about entering ANSI point codes.

For this example, enter this command.

```
ent-sid:pci=s-3-75-7:pcn=s-7-9-8-1
```

When this command has successfully completed, this message should appear.

```
rlghncxa03w 05-09-07 09:17:40 GMT EAGLE5 34.0.0
ENT-SID: MASP A - COMPLTD
```

- Verify the changes using the `rtrv-sid` command. This is an example of the possible output.

```
rlghncxa03w 05-09-10 11:43:04 GMT EAGLE5 34.0.0
PCA          PCI          PCN          CLLI          PCTYPE
001-001-001  1-200-6        10-13-9-3    rlghncxa03w  OTHER
                s-3-75-7        s-7-9-8-1

CPCA
002-002-002      002-002-003      002-002-004      002-002-005
002-002-006      002-002-007      002-002-008      002-002-009
004-002-001      004-003-003      050-060-070

CPCA (LNP)
005-005-002      005-005-004      005-005-005      006-006-006

CPCI
1-002-1          1-002-2          1-002-3          1-002-4
2-001-1          7-222-7

CPCN
2-0-10-3        2-0-11-0        2-0-11-2        2-0-12-1
2-2-3-3        2-2-4-0        10-14-10-1
```

- Back up the new changes, using the `chg-db:action=backup:dest=fixed` command. These messages should appear; the active Maintenance and Administration Subsystem Processor (MASP) appears first.

```
BACKUP (FIXED) : MASP A - Backup starts on active MASP.
BACKUP (FIXED) : MASP A - Backup on active MASP to fixed disk complete.
BACKUP (FIXED) : MASP A - Backup starts on standby MASP.
BACKUP (FIXED) : MASP A - Backup on standby MASP to fixed disk complete.
```

Flowchart 2-6. Adding a Point Code to the Self-Identification of the EAGLE 5 SAS (Sheet 1 of 3)

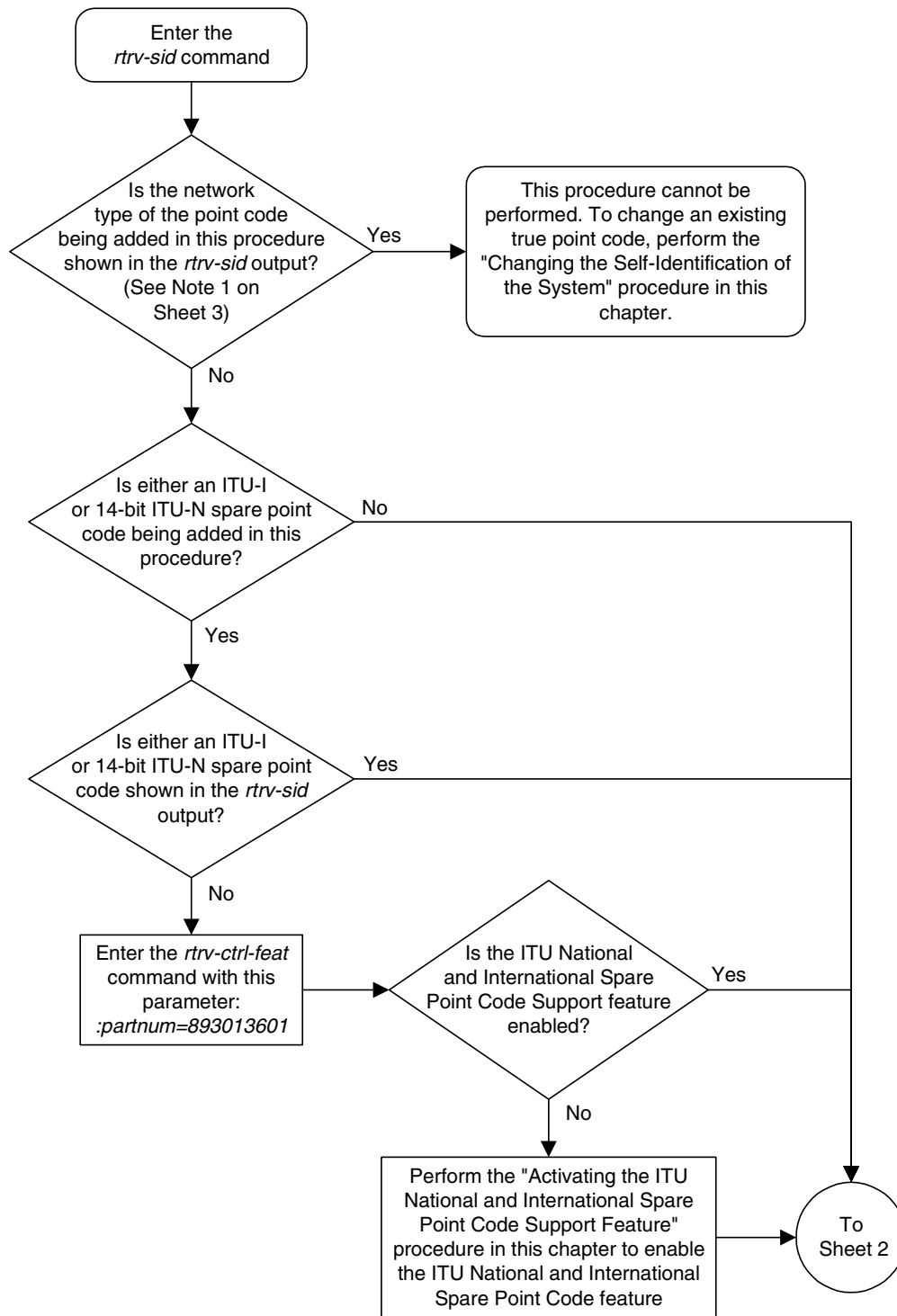

Changing the Self-Identification of the EAGLE 5 SAS

This procedure is used to change the self-identification of the EAGLE 5 SAS using the `chg-sid` command. The self-identification of the EAGLE 5 SAS is a set of point codes made up of a true point code (PC) and a capability point code (CPC) for each network type to which the EAGLE 5 SAS is connected. A capability point code identifies a group of nodes that have similar capabilities, for example, global title translation.



CAUTION: Use this procedure only during periods of low traffic. If the EAGLE 5 SAS's point code, defined by the `pc/pca/pci/pcn/pcn24` parameter, is changed with the procedure, the EAGLE 5 SAS must be reinitialized with the `init-sys` command. The `init-sys` command reboots the entire EAGLE 5 SAS and reloads all cards with the updated self-identification information.

The `chg-stpopts` command `rstrdev` parameter can be used to turn on the Persistent Device States (PDS) feature. If PDS is on, the current device states for cards, signaling links, and terminals are restored after the `init-sys` command has executed. Refer to the `chg-stpopts` command description in the *Commands Manual* for more information about PDS.

NOTE: If `pca`, `pci`, or `pcn` fields in the `rtrv-sid` output do not contain any values, and you only wish to add these values, it is recommended that the "Adding a Point Code to the Self-Identification of the EAGLE 5 SAS" procedure on page 2-81 be used to add these values instead of using this procedure as the "Adding a Point Code to the Self-Identification of the EAGLE 5 SAS" procedure does not require the EAGLE 5 SAS to be re-initialized after the point code value is added.

The `chg-sid` command uses these parameters:

:pc/pca/pci/pcn/pcn24 – The point code used to uniquely identify the EAGLE 5 SAS or, with the value `none`, the point code is defined by the `pc/pca/pcn24` parameter is removed from the database. Removing the `pci` or `pcn` value should be done by using the `npci` or `npcn` parameters.

:cpc/cpca/cpci/cpcn/cpcn24 – The point code used to identify a group of functionally related nodes in the signaling network to which the EAGLE 5 SAS belongs. This point code is called the capability point code.

:ncpc/ncpca/ncpci/ncpcn/ncpcn24 – The new capability point code that replaces an existing capability point code in the database or, with the value `none`, removes an existing capability point code from the database.

:npci/npcn – The new ITU-I (`npci`) or 14-bit ITU-N (`npcn`) point code used to uniquely identify the EAGLE 5 SAS that replaces an existing `pci` or `pcn` parameter value, with the value `none`, removes an existing `pci` or `pcn` parameter value from the database. The `npci/npcn` parameter values cannot be equal to any `cpc` or `pc` parameter values. The `pci` parameter must be specified if the `npci` parameter is specified. The `pcn` parameter must be specified if the `npcn` parameter is specified. The new ITU-I or 14-bit ITU-N

point code values (**npci**/**npcn**) must be the same type as the **pci**/**pcn** parameter value. For example, if the **pci** value is a non-spare point code, the **npci** value must be a non-spare point code. If the **pci** value is a spare point code, the **npci** value must be a spare point code.

NOTE: See “Point Code Formats” on page 2-4 for a definition of the point code types that are used on the EAGLE 5 SAS and for a definition of the different formats that can be used for ITU national point codes.

:c11i – The Common Language Location Identifier assigned to the EAGLE 5 SAS

:pctype – Point code type

:cpctype – the type of capability point code, STP, LNP, INP, or EIR

The self-identification of the EAGLE 5 SAS can consist of an ANSI point code, an ITU international non-spare point code, an ITU international spare point code, a 14-bit ITU national non-spare point code, a 14-bit ITU national spare point code, or a 24-bit ITU national point code, or combinations of these types of point codes. The self-identification of the EAGLE 5 SAS cannot have both a 14-bit ITU-N point code (spare or non-spare) and a 24-bit ITU-N point code.

The self-identification of the EAGLE 5 SAS must contain point codes whose formats match the network the EAGLE 5 SAS is connected to. For example, if the EAGLE 5 SAS is connected to an ANSI network, the self-identification of the EAGLE 5 SAS must contain an ANSI point code. If the EAGLE 5 SAS is connected to an ITU international network, the self-identification of the EAGLE 5 SAS must contain an ITU international point code. If the EAGLE 5 SAS is connected to an ITU national network, the self-identification of the EAGLE 5 SAS must contain either a 14-bit or a 24-bit ITU national point code.

The self-identification of the EAGLE 5 SAS can contain capability point codes. A capability point code is used by the SS7 protocol to identify a group of functionally related nodes in the signaling network. The self-identification of the EAGLE 5 SAS can contain up to 96 capability point codes which can be all one point code network type, or a mixture of all three point code network types.

The EAGLE 5 SAS can contain an ANSI capability point code, an ITU national capability point code (spare or non-spare), and either a 14-bit (spare or non-spare) or a 24-bit ITU-N capability point code.

NOTE: The self-identification of the EAGLE 5 SAS cannot contain private point codes, and private point codes cannot be assigned as capability point codes.

ITU international and 14-bit ITU national spare point codes can be specified only if the ITU National and International Spare Point Code Support feature is enabled. The status of this feature can be verified by entering the **rtrv-ctrl-feat** command. If the ITU National and International Spare Point Code Support feature is not enabled, perform the “Activating the ITU National and International Spare Point Code Support Feature” procedure on page 2-42 to enable the ITU National and International Spare Point Code Support feature.

The self-identification of the EAGLE 5 SAS can also contain a CLLI, the common language location identifier of the EAGLE 5 SAS.

The CLLI of the EAGLE 5 SAS cannot match the CLLI of any destination point code. Use the `rtrv-dstn` command to verify the CLLIs of the destination point codes in the database.

If the CLLI of the EAGLE 5 SAS is changed, and the SEAS feature is on, the OAP configuration must be updated with the new CLLI. Go to the *System Manual - EOAP* to update the OAP configuration.

If the CLLI of the EAGLE 5 SAS is to be changed, and the Eagle Support for Integrated Sentinel (E5IS) feature is on, the EISCOPY option must be off before the `chg-sid` command is executed. The value of the EISCOPY option can be verified with the `rtrv-eisopts` command. After the `chg-sid` command is executed, the EISCOPY option must be changed back to on.

The LNP capability point code, specified with the `cpctype=lnp` parameter, can be only an ANSI point code, specified with either the `cpc`, `cpca`, `ncpc`, or `ncpca` parameters.

The INP capability point code, specified with the `cpctype=inp` parameter, and the EIR capability point code, specified with the `cpctype=eir` parameter, can be either an ITU-I, 14-bit ITU-N, or 24-bit ITU-N point code, specified with either the `cpci`, `cpcn`, `cpcn24`, `ncpci`, `ncpcn`, or `ncpcn24` parameters.

The STP capability point code, specified with the `cpctype=stp` parameter, can be any point code type.

The LNP feature must be enabled to specify the `cpctype=lnp` parameter. This can be verified with the `rtrv-ctrl-feat` command. If the LNP feature is enabled, the entry `LNP TNs` is shown in the `rtrv-ctrl-feat` command output with a quantity greater than zero. If the LNP feature is not enabled, perform the procedures in the *LNP Feature Activation Guide* to enable the LNP feature.

The `pctype` parameter of the `chg-sid` command determines the format of point codes (but not the ITU international or ITU national point codes) that can be used on the EAGLE 5 SAS, `ansi` and `other`. The value `ansi` means the EAGLE 5 SAS supports point codes that meet the ANSI standard. The value `other` means that the EAGLE 5 SAS supports point codes that do not meet the ANSI standard. This does not apply to ITU international or ITU national point codes.

This procedure causes a change in the routing information for this node. Make sure that all other nodes that route messages to this node are notified of these changes.

The point code of the EAGLE 5 SAS cannot match the capability point codes of the EAGLE 5 SAS. The point code of the EAGLE 5 SAS and the capability point codes of the EAGLE 5 SAS are shown in step 1.

The point code and capability point codes of the EAGLE 5 SAS cannot match any destination point codes. Use the `rtrv-dstn` command to display the destination point codes in the database.

Configuring Destination Tables

The point code and capability point codes of the EAGLE 5 SAS cannot be defined as a destination point code of a route. Use the **rtrv-rte** command to display the destination point codes of the routes in the database.

The point code of the EAGLE 5 SAS or the capability point codes, specified by the **pc/pca/pci/pcn/pcn24**, **cpc/cpca/cpci/cpcn/cpcn24** or **npc/ncpca/ncpci/ncpcn/ncpcn24** parameters, must be a full point code and cannot be a cluster point code. The point code containing all zeros cannot be used as a value for these parameters.

If either the **cpctype** parameter or the capability point code parameter (**cpc/cpca/cpci/cpcn/cpcn24**) are specified, the other parameter must be specified.

INP capability point codes, specified with the **cpctype=inp** parameter, can only be specified if the INP feature is turned on. Enter the **rtrv-feat** command to verify whether or not the INP feature is on. If the INP feature is off, go to the *Feature Manual - INP* to turn the INP feature on.

EIR capability point codes, specified with the **cpctype=eir** parameter, can only be specified if the EIR feature is enabled and activated. Enter the **rtrv-ctrl-feat** command to verify whether or not the EIR feature is enabled and activated. If the EIR feature is not enabled or activated, go to the *Feature Manual - EIR* to enable and activate the EIR feature.

If the new capability point code parameter (**npc/ncpca/ncpci/ncpcn/ncpcn24**) is specified, the capability point code parameter (**cpc/cpca/cpci/cpcn/cpcn24**) and the **cpctype** parameters must be specified.

Only one of the new capability point code parameters (**npc/ncpca/ncpci/ncpcn/ncpcn24**) can be specified with the **chg-sid** command.

The new capability point code (**npc/ncpca/ncpci/ncpcn/ncpcn24**) must be of the same point code type as the capability point code (**cpc/cpca/cpci/cpcn/cpcn24**) specified in the command. For example, if an ITU international capability point code (**cpci**) is being replaced, then only the **ncpci** parameter can be specified.

The point code of the EAGLE 5 SAS cannot be changed if it is referenced in the mated application table. Enter the **rtrv-map** command to verify if the EAGLE 5 SAS's point code is being referenced in the mated application table. The EAGLE 5 SAS's point code would be shown in the **PCA**, **PCI**, **PCN**, **PCN24**, **MPCA**, **MPCI**, **MPCN**, or **MPCN24** fields of the **rtrv-map** command output. If the EAGLE 5 SAS's point code is referenced by the mated application table, go to the "Removing a Mated Application" procedure in the *Database Administration Manual - Global Title Translation*, and remove the mated applications that reference the EAGLE 5 SAS's point code.

The destination point codes and alias point codes are shown in the **DPCA**, **DPCI**, **DPCN**, **DPCN24**, **ALIASA**, **ALIASI**, **ALIASN**, and **ALIASN24** fields in the **rtrv-dstn** command output. The EAGLE 5 SAS's point code and capability point codes are displayed in the **PCA**, **PCI**, **PCN**, **PCN24**, **CPCA**, **CPCI**, **CPCN**, and **CPCN24** fields in the **rtrv-sid** command output.

To assign group codes to a 14-bit ITU-N point code, the ITU duplicate point code and multiple point code support features must be on. If the ITU National Duplicate Point Code feature is on, the entry **ITUDUPPC = on** is shown in the **rtrv-feat** command output. If the multiple point code support feature is on, the entry **MPC = on** is shown in the **rtrv-feat** command output. For more information on using group codes with 14-bit ITU-N point codes, see the "ITU National Duplicate Point Codes" section on page 2-16.

NOTE: Once the ITU duplicate point code and multiple point code support features are turned on with the **chg-feat** command, they cannot be turned off.

The ITU duplicate point code and multiple point code support features must be purchased before you turn this feature on with the **chg-feat command. If you are not sure if you have purchased the ITU duplicate point code and multiple point code support features, contact your Tekelec Sales Representative or Account Representative.**

If you wish to specify the **pcn24** parameter with the **chg-sid** command and the **rtrv-sid** output shows the **PCN** field, the 14-bit ITU-N point code value, shown in the **PCN** field must be removed with the **npcn=none** parameter before the **pcn24** parameter value can be specified by the **chg-sid** command. If the **PCN** field contains both spare and non-spare point code values, both the spare and non-spare 14-bit ITU-N point code values must be removed before the **pcn24** parameter can be specified. If no value is shown in the **PCN** field, specifying the **npcn=none** parameter is not necessary.

If you wish to specify the **pcn** parameter with the **chg-sid** command and the **rtrv-sid** output shows the **PCN24** field, the 24-bit ITU-N point code value, shown in the **PCN24** field must be removed with the **pcn24=none** parameter before the **pcn** parameter value can be specified by the **chg-sid** command. If no value is shown in the **PCN24** field, specifying the **pcn24=none** parameter is not necessary.

When the EAGLE 5 SAS is initially installed, the self-identification of the EAGLE 5 SAS must be configured before any destination point codes can be configured in the database.

Configuring Destination Tables

For the examples in this procedure, the self-identification of the EAGLE 5 SAS is being changed to these values:

ANSI point code = 100-100-100

ITU international point code = 3-75-7

14-bit ITU national point code = 7-9-8-1

LNP capability point code = 006-006-006

The format of the 14-bit ITU national point codes used in these examples is 4-4-4-2.

Canceling the `RTRV-DSTN`, `RTRV-MAP`, and `RTRV-RTE` Commands

Because the `rtrv-dstn`, `rtrv-map`, and `rtrv-rte` commands used in this procedure can output information for a long period of time, the `rtrv-dstn`, `rtrv-map`, and `rtrv-rte` commands can be canceled and the output to the terminal stopped. There are three ways that the `rtrv-dstn`, `rtrv-map`, and `rtrv-rte` commands can be canceled:

- Press the **F9** function key on the keyboard at the terminal where the `rtrv-dstn`, `rtrv-map`, or `rtrv-rte` command was entered.
- Enter the `canc-cmd` without the `trm` parameter at the terminal where the `rtrv-dstn`, `rtrv-map`, or `rtrv-rte` command was entered.
- Enter the `canc-cmd:trm=<xx>`, where `<xx>` is the terminal where the `rtrv-dstn`, `rtrv-map`, or `rtrv-rte` command was entered, from another terminal other than the terminal where the `rtrv-dstn`, `rtrv-map`, and `rtrv-rte` commands were entered. To enter the `canc-cmd:trm=<xx>` command, the terminal must allow Security Administration commands to be entered from it and the user must be allowed to enter Security Administration commands. The terminal's permissions can be verified with the `rtrv-secu-trm` command. The user's permissions can be verified with the `rtrv-user` or `rtrv-secu-user` commands.

For more information about the `canc-cmd` command, refer to the *Commands Manual*.

Procedure

1. Display the self-identification of the EAGLE 5 SAS using the `rtrv-sid` command. This is an example of the possible output.

```
rlghncxa03w 05-09-10 11:43:04 GMT EAGLE5 34.0.0
PCA          PCI          PCN          CLLI          PCTYPE
001-001-001  1-200-6        10-13-9-3   rlghncxa03w  OTHER

CPCA
002-002-002      002-002-003      002-002-004      002-002-005
002-002-006      002-002-007      002-002-008      002-002-009
004-002-001      004-003-003      050-060-070

CPCA (LNP)
005-005-002      005-005-004      005-005-005

CPCI
1-002-1          1-002-2          1-002-3          1-002-4
2-001-1          7-222-7

CPCN
2-0-10-3        2-0-11-0        2-0-11-2        2-0-12-1
2-2-3-3        2-2-4-0        10-14-10-1
```

NOTE: If the `cpctype=lnp` or `cpctype=eir` parameters are not being specified in this procedure, or if the `cpctype=inp` will be specified in this procedure, skip this step, and go to step 3.

2. Verify that either the LNP (if the `cpctype=lnp` parameter is specified) or EIR feature (if the `cpctype=eir` parameter is specified) is enabled, by entering the `rtrv-ctrl-feat` command. If the LNP feature is enabled, the `LNP TNs` field should be shown with a quantity greater than zero. If the EIR feature is enabled, the status of the `EIR` field should shown as `on`.

NOTE: The `rtrv-ctrl-feat` command output contains other fields that are not used by this procedure. If you wish to see all the fields displayed by the `rtrv-ctrl-feat` command, see the `rtrv-ctrl-feat` command description in the *Commands Manual*.

If the LNP is enabled, or the EIR feature is enabled and activated, go to step 4.

If the LNP feature is not enabled, perform the procedures in the *LNP Feature Activation Guide* to enable the LNP feature.

If the EIR feature is not enabled or activated, go to the *Feature Manual - EIR* and enable and activate the EIR feature.

NOTE: If the `cpctype=inp` parameter is not being specified in this procedure, or if the `cpctype=lnp` or `cpctype=eir` parameters will be specified in this procedure, skip this step, and go to step 4.

3. Verify that the INP feature is on, by entering the `rtrv-feat` command. If the INP feature is on, the `INP` field should be set to `on`. For this example, the INP feature is off.

NOTE: The `rtrv-feat` command output contains other fields that are not used by this procedure. If you wish to see all the fields displayed by the `rtrv-feat` command, see the `rtrv-feat` command description in the *Commands Manual*.

If the INP feature is on, go to step 4.

If the INP feature is off, go to the *Feature Manual - INP* and turn the INP feature on.

4. Display the point codes in the destination point code table by using the `rtrv-dstn` command. This is an example of the possible output.

```
rlghncxa03w 05-09-10 11:43:04 GMT EAGLE5 34.0.0
DPCA          CLLI          BEI  ELEI  ALIASI          ALIASN/N24  DOMAIN
001-002-003   ls04clli         yes  ---  -----  -----  SS7
002-002-002   ls01clli         no   ---  -----  -----  SS7
002-007-008   ls06clli         yes  ---  -----  -----  SS7
003-003-003   ls03clli         yes  ---  -----  -----  SS7
004-004-004   ls02clli         yes  ---  -----  -----  SS7
179-100-087   -----         yes  ---  -----  -----  SS7
200-050-176   -----         yes  ---  -----  -----  SS7
240-007-000   -----         yes  ---  -----  -----  SS7
240-012-004   rlghncbb001     yes  ---  1-111-1    10-13-9-3  SS7
240-012-005   rlghncbb002     yes  ---  1-112-2    10-13-10-0 SS7
240-012-006   rlghncbb003     yes  ---  1-112-3    10-13-10-1 SS7
240-012-008   -----         yes  ---  1-113-5    10-13-10-2 SS7
244-010-004   ls06clli         no   ---  -----  -----  X25
244-012-005   ls07clli         no   ---  -----  -----  X25
244-012-006   ls08clli         no   ---  -----  -----  X25
244-012-007   -----         no   ---  -----  -----  X25
244-012-008   -----         no   ---  -----  -----  X25

DPCI          CLLI          BEI  ELEI  ALIASA          ALIASN/N24  DOMAIN
2-131-1       rlghncbb023     no   ---  222-210-000 11-11-8-1  SS7
2-131-2       -----         no   ---  222-211-001 11-11-8-2  SS7
2-131-3       -----         no   ---  222-211-002 11-11-8-3  SS7
3-150-4       lsi7clli        yes  ---  -----  -----  SS7

DPCN          CLLI          BEI  ELEI  ALIASA          ALIASI       DOMAIN
10-6-15-1     lsn5clli        yes  ---  -----  -----  SS7
10-15-2-3     rlghncbb013     no   ---  222-200-200 2-121-1     SS7
10-15-3-0     rlghncbb013     no   ---  222-200-201 2-121-2     SS7

DPCN24        CLLI          BEI  ELEI  ALIASA          ALIASI       DOMAIN

Destination table is (24 of 2000) 1% full
Alias table is (18 of 8000) 1% full
RTRV-DSTN: MASP A - COMPLTD
```

5. Display the current route configuration, using the `rtrv-rte` command. This is an example of the possible output.

```

rlghncxa03w 05-09-07 11:43:04 GMT EAGLE5 34.0.0
  DPCA          ALIASI          ALIASN/N24    LSN          RC          APCA
  140-012-004   1-111-1          10-13-12-1   ls000001    10          240-012-002
                                     ls000002    10          240-012-002
                                     ls000003    20          240-012-002
                                     ls000004    30          240-012-002
                                     ls000005    40          240-012-002
                                     ls000006    50          240-012-002
                                     CLLI=dp1
  140-012-005  1-111-2          10-13-12-2   ls000001    10          240-012-002
                                     ls000002    10          240-012-002
                                     ls000003    20          240-012-002
                                     ls000004    30          240-012-002
                                     ls000005    40          240-012-002
                                     ls000006    50          240-012-002
                                     CLLI=dp2

  DPCI          ALIASN/N24      ALIASA        LSN          RC          APC
  2-234-5       11-13-3-3      240-111-111  ls100001    10          1-234-5
                                     ls100002    10          1-234-6
                                     ls100003    20          1-234-7
                                     ls100004    30          1-234-1
                                     ls100005    40          1-234-2
                                     ls100006    50          1-234-3
                                     CLLI=idp1

  DPCN          ALIASA          ALIASI        LSN          RC          APC
  12-12-13-3   011-222-111   0-001-1      ls200001    10          10-13-9-3
                                     ls200002    10          10-13-10-0
                                     ls200003    20          10-13-10-1
                                     ls200004    30          10-13-10-2
                                     ls200005    40          10-13-10-3
                                     ls200006    50          10-13-11-0
                                     CLLI=ndp1

  DPCN24        ALIASA          ALIASI        LSN          RC          APC

```

NOTE: If the `pcn`, `npcn`, `cpcn`, or `npcn` parameters are not being used in this procedure, skip this step and go to step 9.

6. Display the existing values for the `npcfmt i` parameter, by entering the `rtrv-stpopts` command. The value for the `npcfmt i` parameter is shown in the `NPCFMTI` field. This is an example of the possible output.

```

rlghncxa03w 05-09-17 16:02:05 GMT EAGLE5 34.0.0
STP OPTIONS
-----
NPCFMTI          4-4-4-2

```

NOTE: The `rtrv-stpopts` command output contains other fields that are not used by this procedure. If you wish to see all the fields displayed by the `rtrv-stpopts` command, see the `rtrv-stpopts` command description in the *Commands Manual*.

If you wish to change the format of the 14-bit ITU national point codes, go to the “14-Bit ITU National Point Code Formats” section on page 2-10. Changing the formats of the 14-bit ITU national point codes will change how any existing 14-bit ITU national point codes are displayed in the database.

NOTE: If group codes are not assigned to the 14-bit ITU national point codes in the EAGLE 5 SAS, or if the 14-bit ITU national point codes have group codes assigned to them, skip this step and go to step 8.

7. Enter the `rtrv-feat` command, or examine the `rtrv-feat` output in step 3, if step 3 was performed, to verify that the Multiple Point Code Support and ITU Duplicate Point Code Support features are on. If the Multiple Point Code Support feature is on, the `MPC` field should be set to `on`. If the ITU Duplicate Point Code Support feature is on, the `ITUDUPPC` field should be set to `on`. For this example, these features are off.

NOTE: The `rtrv-feat` command output contains other fields that are not used by this procedure. If you wish to see all the fields displayed by the `rtrv-feat` command, see the `rtrv-feat` command description in the *Commands Manual*.

If the ITU Duplicate Point Code Support feature is off and the Multiple Point Code feature is on, enter this command.

```
chg-feat:ituduppc=on
```

If both features are off, enter this command.

```
chg-feat:mpc=on:ituduppc=on
```

NOTE: Once the ITU Duplicate Point Code and Multiple Point Code features are turned on with the `chg-feat` command, they cannot be turned off.

The ITU Duplicate Point Code and Multiple Point Code features must be purchased before you turn these features on with the `chg-feat` command. If you are not sure if you have purchased these features, contact your Tekelec Sales Representative or Account Representative.

When the `chg-feat` has successfully completed, this message should appear.

```
rlghncxa03w 05-09-07 00:57:31 GMT EAGLE5 34.0.0  
CHG-FEAT: MASP A - COMPLTD
```

NOTE: If an ITU-I or 14-bit ITU-N spare point code is displayed in the `rtrv-sid` output in step 1, or if an ITU-I or 14-bit ITU-N spare point code is not being specified in this procedure, skip step 8 and go to step 9.

8. If spare point codes are being specified in this procedure, the ITU National and International Spare Point Code Support feature must be enabled. The `rtrv-ctrl-feat` command shows the status of the ITU National and International Spare Point Code Support feature. If step 2 was performed in this procedure, verify that the ITU National and International Spare Point Code Support feature is enabled.

If step 2 was not performed in this procedure, enter the `rtrv-ctrl-feat` command with the part number of this feature. Enter this command.

```
rtrv-ctrl-feat:partnum=893013601
```

This is an example of the possible output.

```
rlghncxa03w 05-09-28 21:15:37 GMT EAGLE5 34.0.0
The following features have been permanently enabled:
```

Feature Name	Partnum	Status	Quantity
Spare Point Code Support	893013601	on	----

The following features have been temporarily enabled:

Feature Name	Partnum	Status	Quantity	Trial Period Left
Zero entries found.				

The following features have expired temporary keys:

Feature Name	Partnum
Zero entries found.	

If the ITU National and International Spare Point Code Support feature is not enabled, perform the “Activating the ITU National and International Spare Point Code Support Feature” procedure on page 2-42 to enable the ITU National and International Spare Point Code Support feature.

Configuring Destination Tables

NOTE: If the EAGLE 5 SAS's point code is not being changed in this procedure, skip this step and step 10, and go to step 11.

9. Display the mated applications in the database, using the `rtrv-map` command. This is an example of the possible output.

```
rlghncxa03w 05-09-07 00:34:31 GMT EAGLE5 34.0.0
MAP TABLE IS 2 % FULL (20 of 1024)

PCA          SSN   RC  MULT  MPCA          MSSN  MATERC  MULT  SRM   MRC   GRP  NAME  SSO
255-001-000 250   10  SOL           255-001-000  250   10   SOL   YES  YES  GRP01  ON
255-001-000 251   10  SHR           255-001-000  251   10   SHR   YES  YES  GRP01  ON
255-001-000 252   10  SOL           253-001-002  254   10   SHR   YES  YES  GRP01  OFF
255-001-000 253   10  SHR           253-001-002  254   10   SHR   YES  YES  GRP01  ON
255-001-001 255   10  DOM           253-001-004  254   10   SHR   YES  YES  GRP01  OFF
255-001-001 250   10  DOM           253-001-005  254   20   DOM   YES  YES  GRP01  ON
255-001-001 251   10  SHR           253-001-001  254   20   DOM   YES  YES  GRP01  OFF
255-001-002 251   10  SHR           255-001-002  254   10   SHR   NO   YES  GRP01  OFF
255-001-002 252   10  DOM           255-001-003  254   20   DOM   YES  YES  GRP01  ON
255-001-002 253   10  SHR           255-001-004  254   10   SHR   YES  NO   GRP01  ON
MAP TABLE IS 2 % FULL (20 of 1024)

PCI          SSN   RC  MULT  MPCI          MSSN  MATERC  MULT  SRM   MRC   GRP  NAME  SSO
2-001-2      255   10  DOM           2-001-1      254   20   DOM   ---  ---  GRP03  OFF
MAP TABLE IS 2 % FULL (20 of 1024)

PCN          SSN   RC  MULT  MPCN          MSSN  MATERC  MULT  SRM   MRC   GRP  NAME  SSO
0-5-6-3     253   10  SHR           1-5-10-3     254   10   SHR   ---  ---  GRP05  OFF
```

If the EAGLE 5 SAS's point code is shown in the `rtrv-map` command output (in the `PCA`, `PCI`, `PCN`, `PCN24`, `MPCA`, `MPCI`, `MCPN`, or `MPCN24` fields), go to the "Removing a Mated Application" procedure in the *Database Administration Manual - Global Title Translation*, and remove the EAGLE 5 SAS's point code from the mated application table.

NOTE: If the EAGLE 5 SAS's point code is not being removed in this procedure, skip this step and go to step 11.

10. For the EAGLE 5 SAS to have point codes of a particular network type (ANSI, ITU-I, or ITU-N), a point code of that same type must be defined by the `pc/pca/pci/pcn/pcn24` parameter of the `chg-sid` command. To remove a point code defined by the `pc/pca/pci/pcn/pcn24` parameter, all point codes of the same network type as the point code being removed in this procedure must be removed from the database. Go to the "Removing a Destination Point Code" procedure on page 2-214 and remove the point codes shown in the `rtrv-dstn` output in step 4 that are the same network type as the point code being removed in this procedure.

NOTE: If step 10 was performed, skip this step and go to step 12.

11. Display the secondary point codes in the database, using the `rtrv-spc` command. This is an example of the possible output.

```
rlghncxa03w 05-09-07 11:43:04 GMT EAGLE5 34.0.0
SPC (Secondary Point Codes)
```

```
SPCA
```

```
001-010-010
002-010-010
003-010-010
010-100-010
```

```
SPC-I
```

```
1-253-5
2-254-6
3-255-7
4-100-1
```

```
SPC-N
```

```
10-01-11-1
13-02-12-0
14-15-12-1
```

```
SPC-N24
```

```
none
```

```
Secondary Point Code table is (11 of 40) 28% full
```

If the EAGLE 5 SAS's point code or capability point code that is being configured in this procedure is shown in steps 1, 4, 5, or 11, choose another point code to configure with this procedure.

NOTE: If the `c11i` parameter value is not being changed, skip steps 12 through 14, and go to step 15.

12. Enter the `rtrv-feat` command, or examine the `rtrv-feat` output in either steps 3, or 7, if steps 3, or 7 were performed, to verify that the Eagle Support for Integrated Sentinel feature is on. If the Eagle Support for Integrated Sentinel feature is on, the `E5IS` field should be set to `on`.

NOTE: The `rtrv-feat` command output contains other fields that are not used by this procedure. If you wish to see all the fields displayed by the `rtrv-feat` command, see the `rtrv-feat` command description in the *Commands Manual*.

NOTE: If the Eagle Support for Integrated Sentinel feature is not on, skip this step and step 14, and go to step 15.

13. Display the `EISCOPY` option by entering the `rtrv-eisopts` command. This is an example of the possible output.

```
rlghncxa03w 05-09-07 11:43:04 GMT EAGLE5 34.0.0
EISOPTION          STATUS
-----
EISCOPY            ON
```

NOTE: If the `EISCOPY` option is off, skip this step and go to step 15.



CAUTION: Changing the `EISCOPY` option to `off` will disable the Eagle Support for Integrated Sentinel feature.

14. Turn the `EISCOPY` option off by entering the `chg-eisopts` command with the `eiscopy=off` parameter.

When the `chg-eisopts` has successfully completed, this message should appear.

```
rlghncxa03w 05-09-07 11:43:04 GMT EAGLE5 34.0.0
CHG-EISOPTS: MASP A - COMPLTD
```

15. Change the value of the self-identification of the EAGLE 5 SAS, using the **chg-sid** command. For this example, the point code of the EAGLE 5 SAS is being changed to these values:

ANSI point code = 100-100-100

ITU international point code = 3-75-7

ITU national point code = 7-9-8-1

LNP capability point code = 006-006-006

To make these changes, enter this command.

```
chg-sid:pca=100-100-100:pci=3-75-7:pcn=7-9-8-1
:cpca=006-006-006:cpctype=lnp
```

If you wish to specify the **pcn24** parameter with the **chg-sid** command and the **rtrv-sid** output shows the **PCN** field, the 14-bit ITU-N point code value, shown in the **PCN** field must be removed with the **npcn=none** parameter before the **pcn24** parameter value can be specified by the **chg-sid** command. If the **PCN** field contains both spare and non-spare point code values, both the spare and non-spare 14-bit ITU-N point code values must be removed before the **pcn24** parameter can be specified. If no value is shown in the **PCN** field, specifying the **npcn=none** parameter is not necessary.

If you wish to specify the **pcn** parameter with the **chg-sid** command and the **rtrv-sid** output shows the **PCN24** field, the 24-bit ITU-N point code value, shown in the **PCN24** field must be removed with the **pcn24=none** parameter before the **pcn** parameter value can be specified by the **chg-sid** command. If no value is shown in the **PCN24** field, specifying the **pcn24=none** parameter is not necessary.

If you wish to configure network routing point codes using the network indicator values 1 through 5, the **pctype** parameter value must be **other**. For more information on network routing point codes, see the "Network Routing" section on page 2-174.

When this command has successfully completed, this message should appear.

```
rlghncxa03w 05-09-07 09:17:40 GMT EAGLE5 34.0.0
CHG-SID: MASP A - COMPLTD
```

If any of the **pc/pca/pci/pcn/pcn24** parameters are changed, the EAGLE 5 SAS needs to be reinitialized. Go to step 17. A caution message is displayed indicating that the EAGLE 5 SAS needs to be reinitialized.

```
CAUTION: SYSTEM SITE ID HAS BEEN CHANGED, MANUAL RE-INITIALIZATION IS NEEDED
```

If the SEAS feature is on, shown by the entry **SEAS = on** in the **rtrv-feat** command output, and the **c11i** parameter is changed, a caution message is displayed indicating that the OAPs must be configured with the new CLLI.

```
CAUTION: System CLLI has changed, OAP configuration is required
```

Go to the "Configuring the OAP from the EAGLE 5 SAS" section in the *Database Administration Manual - System Management* to update the OAP configuration.

NOTE: If the SEAS feature is not on, the OAPs are not present in the EAGLE 5 SAS, and the procedures in the *System Manual - EOAP* does not need to be performed.

If the point code of the EAGLE 5 SAS or capability point code is referenced by the gateway screening redirect function and the gateway screening redirect function is enabled, a caution message is displayed indicating that the gateway screening redirect function's DPC must be changed to reference the new EAGLE 5 SAS's point code.

CAUTION: SYSTEM SITE ID WAS REFERENCED BY THE REDIRECT FUNCTION'S DPC

Use the `chg-gws-redirect` command to change the gateway screening redirect function's DPC. Go to the "Changing the Gateway Screening Redirect Parameters" procedure in the *Database Administration Manual - Features* to change the gateway screening redirect function's DPC.

NOTE: If the `pc/pca/pci/pcn/pcn24` parameters were not changed in step 15, skip step this step and step 17, and go to step 18.



CAUTION: The following `init-sys` command causes a complete EAGLE 5 SAS reload, and should only be used during periods of low traffic. Using this command ensures the updated self-identification information is loaded onto all cards, but will interrupt service.



CAUTION: The `chg-stpopts` command `rstrdev` parameter can be used to turn on the Persistent Device States (PDS) feature. When PDS is turned off and the `init-sys` command executes, the EAGLE 5 SAS does not retain the manually initiated state (for example, OOS-MT-DSBLD) for the signaling links, cards, or terminals. After the command executes, the EAGLE 5 SAS attempts to bring all provisioned signaling links, cards, and terminals on-line, including those that were previously out of service. You will need to manually put each device back into its previous state after the EAGLE 5 SAS is back on-line. It is, therefore, advisable to print or electronically capture the output of the `rept-stat-slk`, `rept-stat-card`, and `rept-stat-trm` commands for reference prior to issuing the `init-sys` command. To restore a device to its previous state, issue the appropriate inhibit/deactivate command listed in the *Commands Manual* in the Related Commands section for each of the above `rept-stat` commands.

When PDS is turned on using the `chg-stpopts:rstrdev=on` command, the EAGLE 5 SAS restores the previous device states of signaling links, terminals, and cards after the `init-sys` command has executed.

16. Enter the `rtrv-stpopts` command to display the setting of the `rstrdev` parameter.

Step 17 instructs you to enter the `init-sys` command.

If you do not want the EAGLE 5 SAS to restore previous device states after the `init-sys` command has executed and `RSTRDEV` is on in the `rtrv-stpopts` output, enter the `chg-stpopts:rstrdev=off` command.

If you want the EAGLE 5 SAS to restore previous device states after the `init-sys` command has executed, and `RSTRDEV` is `off` in the `rtrv-stpopts` output, enter the `chg-stpopts:rstrdev=on` command

Continue with step 17.

17. Reinitialize the EAGLE 5 SAS by entering the `init-sys` command.

NOTE: The `init-sys` command must be entered twice within 30 seconds for the EAGLE 5 SAS to be re-initialized. If the `init-sys` command is not executed twice within 30 seconds, the attempt to re-initialize the EAGLE 5 SAS is aborted.

When the `init-sys` command is first entered, this message should appear.

```
rlghncxa03w 05-09-28 07:05:01 GMT EAGLE5 34.0.0
CAUTION: This command causes a complete system reload, and
will result in traffic loss.
Re-enter command within 30 seconds to confirm.
```

When the `init-sys` command is re-entered within the 30 second time limit, this message should appear.

```
rlghncxa03w 05-09-28 07:05:17 GMT EAGLE5 34.0.0
Init System command issued at terminal #3
```

From the time that the `init-sys` command is accepted, you must wait approximately two minutes before you can perform step 18 (logging onto the EAGLE 5 SAS). If the EAGLE 5 SAS terminal is in the VT-100/VT-320 mode, the terminal display will be refreshed with non-zero alarm counts. During this 2-minute interval, an intermediate screen refresh is caused by the MASP's role change from active to standby, and from standby to active. This screen refresh is typically a partial refresh, and the alarm indicators are set to zero.

If you are logged into the EAGLE 5 SAS in the KSR mode, the only response you will receive indicating that you are now able to log into the EAGLE 5 SAS is **UAM 0009, MASP became active**. **UAM 0009** could be issued twice due to possible transient MASP role change (switching from active to standby).

Following the execution of the `init-sys` command, the MASP that was active before the `init-sys` command was entered will be the active MASP when the EAGLE 5 SAS has finished reinitializing.

18. Log into the EAGLE 5 SAS using the `login` command (or the `act-user` command).

This is an example of the messages that appear when the login session has successfully completed.

```
NOTICE: This is a private computer system.
Unauthorized access or use may lead to prosecution.
```

```
0 LOGIN failures since last successful LOGIN
Last successful LOGIN was on port 4 on 04-06-02 @ 09:34:56
```

NOTE: If the `clli` parameter was not changed in step 15, skip this step and step 20, and go to step 21.

19. Go to the "Configuring the OAP from the EAGLE 5 SAS" section in the *Database Administration Manual - System Management* and re-configure the OAPs with the new CLI information.

NOTE: If the `EISCOPY` option was not changed in 14, skip this step and go to step 21.



CAUTION: The Eagle Support for the Integrated Sentinel feature will be disabled if this step is not performed.

20. Turn the `EISCOPY` option on by entering the `chg-eisopts` command with the `eiscopy=on` parameter.

When the `chg-eisopts` has successfully completed, this message should appear.

```
rlghncxa03w 05-09-28 07:05:01 GMT EAGLE5 34.0.0
CHG-EISOPTS: MASP A - COMPLTD
```

21. Verify the changes using the `rtrv-sid` command. This is an example of the possible output.

```
rlghncxa03w 05-09-10 11:43:04 GMT EAGLE5 34.0.0
PCA          PCI          PCN          CLLI          PCTYPE
100-100-100  3-75-7         7-9-8-1      rlghncxa03w  OTHER

CPCA
002-002-002      002-002-003      002-002-004      002-002-005
002-002-006      002-002-007      002-002-008      002-002-009
004-002-001      004-003-003      050-060-070

CPCA (LNP)
005-005-002      005-005-004      005-005-005      006-006-006

CPCI
1-002-1         1-002-2         1-002-3         1-002-4
2-001-1         7-222-7

CPCN
2-0-10-3       2-0-11-0       2-0-11-2       2-0-12-1
2-2-3-3       2-2-4-0       10-14-10-1
```

22. Back up the new changes, using the `chg-db:action=backup:dest=fixed` command. These messages should appear; the active Maintenance and Administration Subsystem Processor (MASP) appears first.

```
BACKUP (FIXED) : MASP A - Backup starts on active MASP.
BACKUP (FIXED) : MASP A - Backup on active MASP to fixed disk complete.
BACKUP (FIXED) : MASP A - Backup starts on standby MASP.
BACKUP (FIXED) : MASP A - Backup on standby MASP to fixed disk complete.
```

Flowchart 2-7. Changing the Self-Identification of the System (Sheet 1 of 11)

NOTE: Before executing this procedure, make sure you have purchased the ITU Duplicate Point Code and Multiple Point Code features. If you are not sure if you have purchased the ITU Duplicate Point Code and Multiple Point Code features, contact your Tekelec Sales Representative or Account Representative.

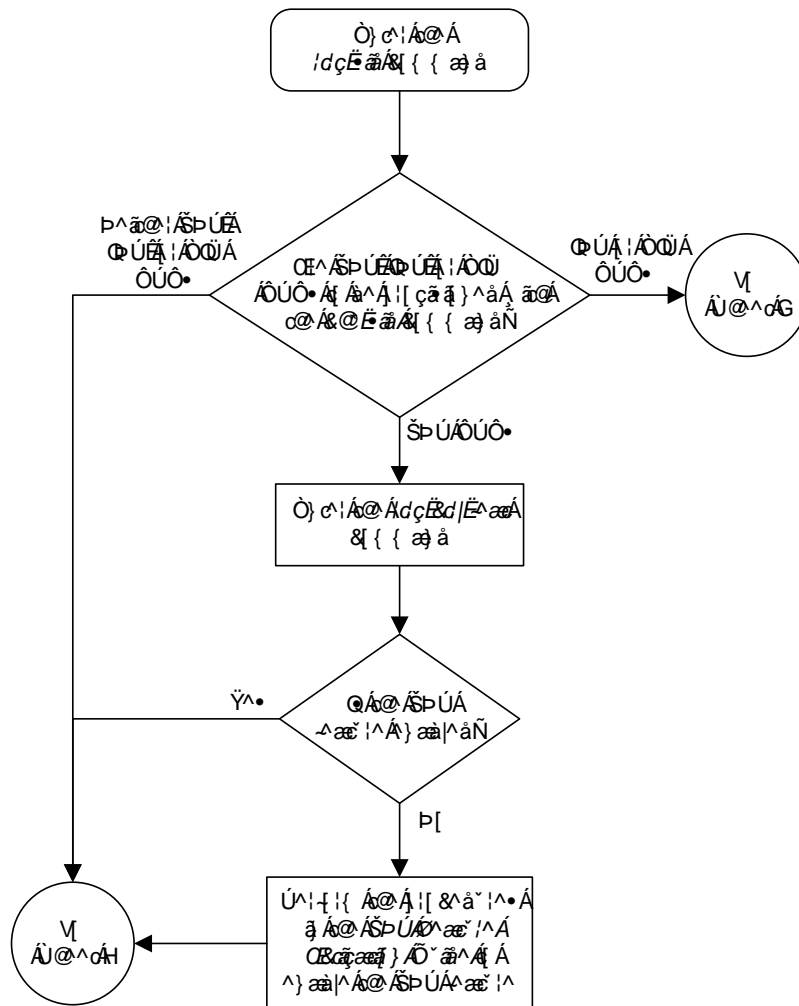

Flowchart 2-7. Changing the Self-Identification of the System (Sheet 2 of 11)

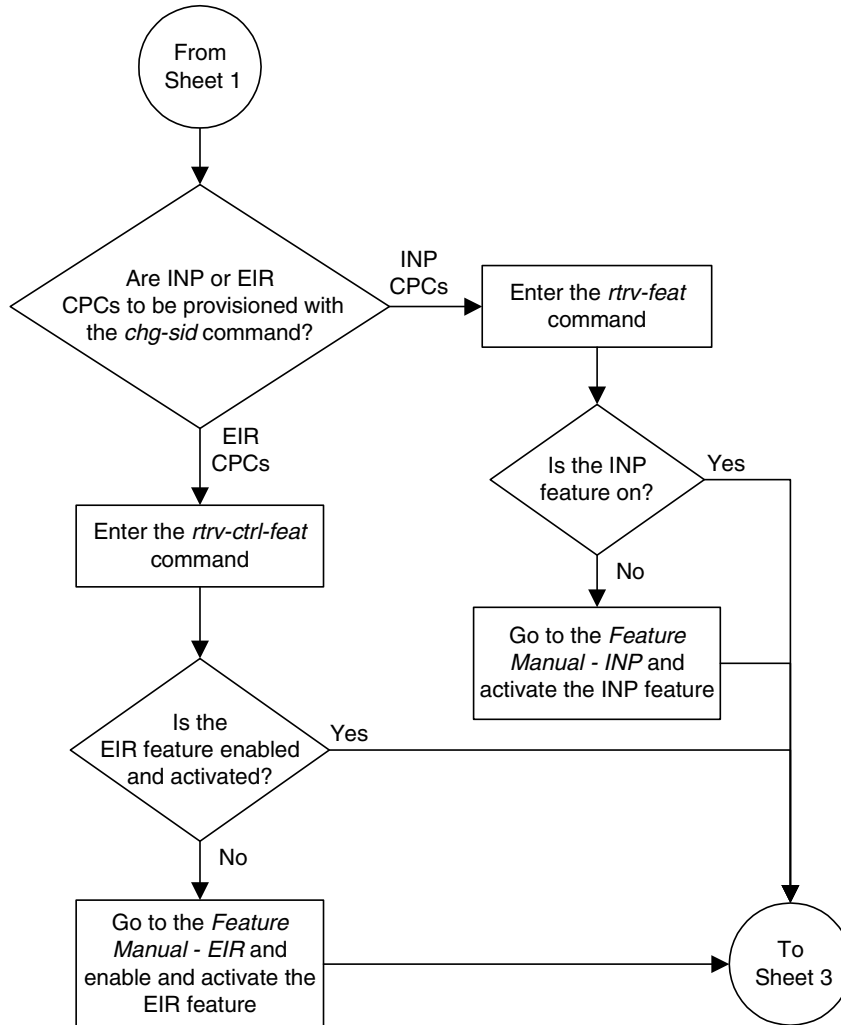

Flowchart 2-7. Changing the Self-Identification of the System (Sheet 3 of 11)

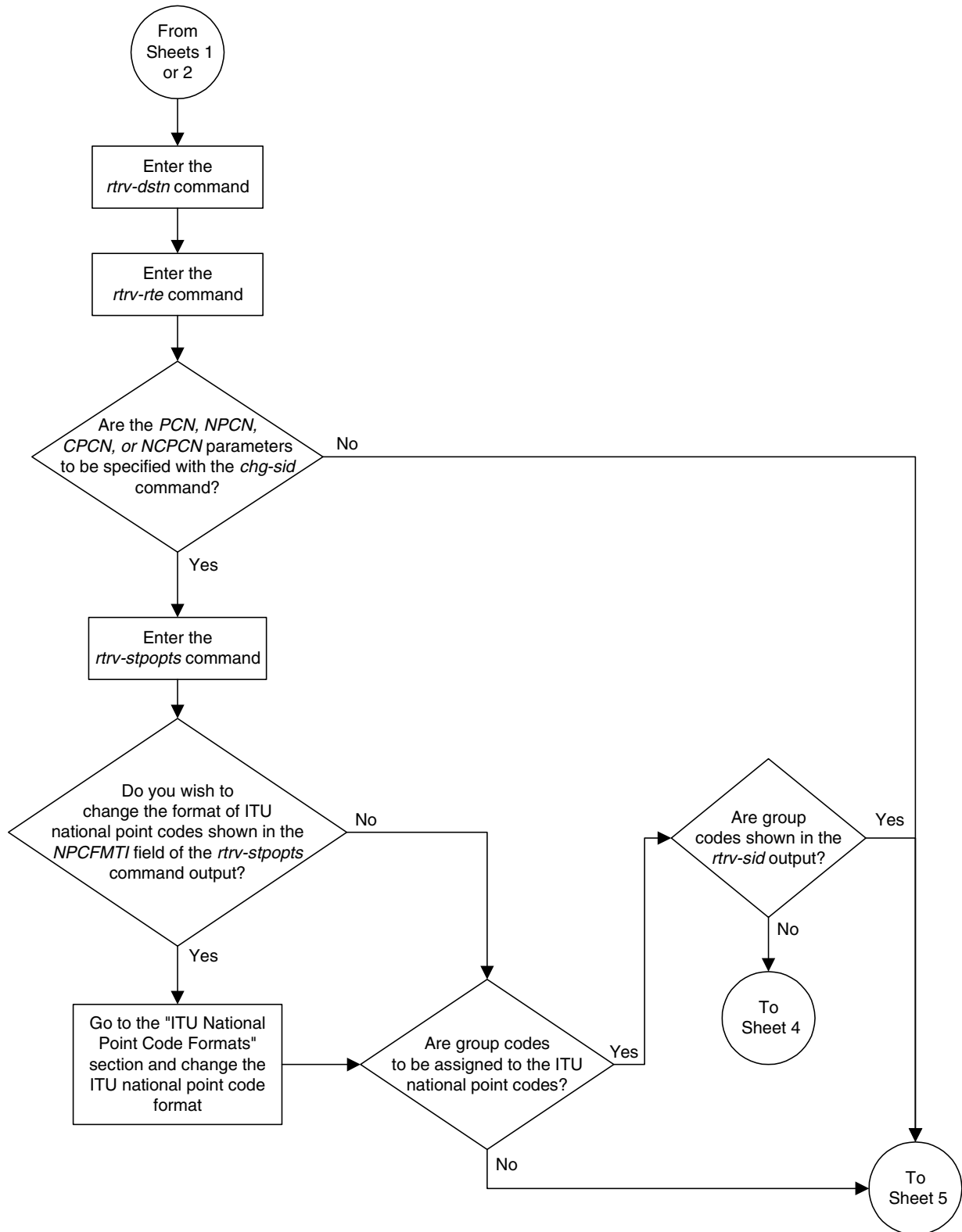

Flowchart 2-7. Changing the Self-Identification of the System (Sheet 4 of 11)

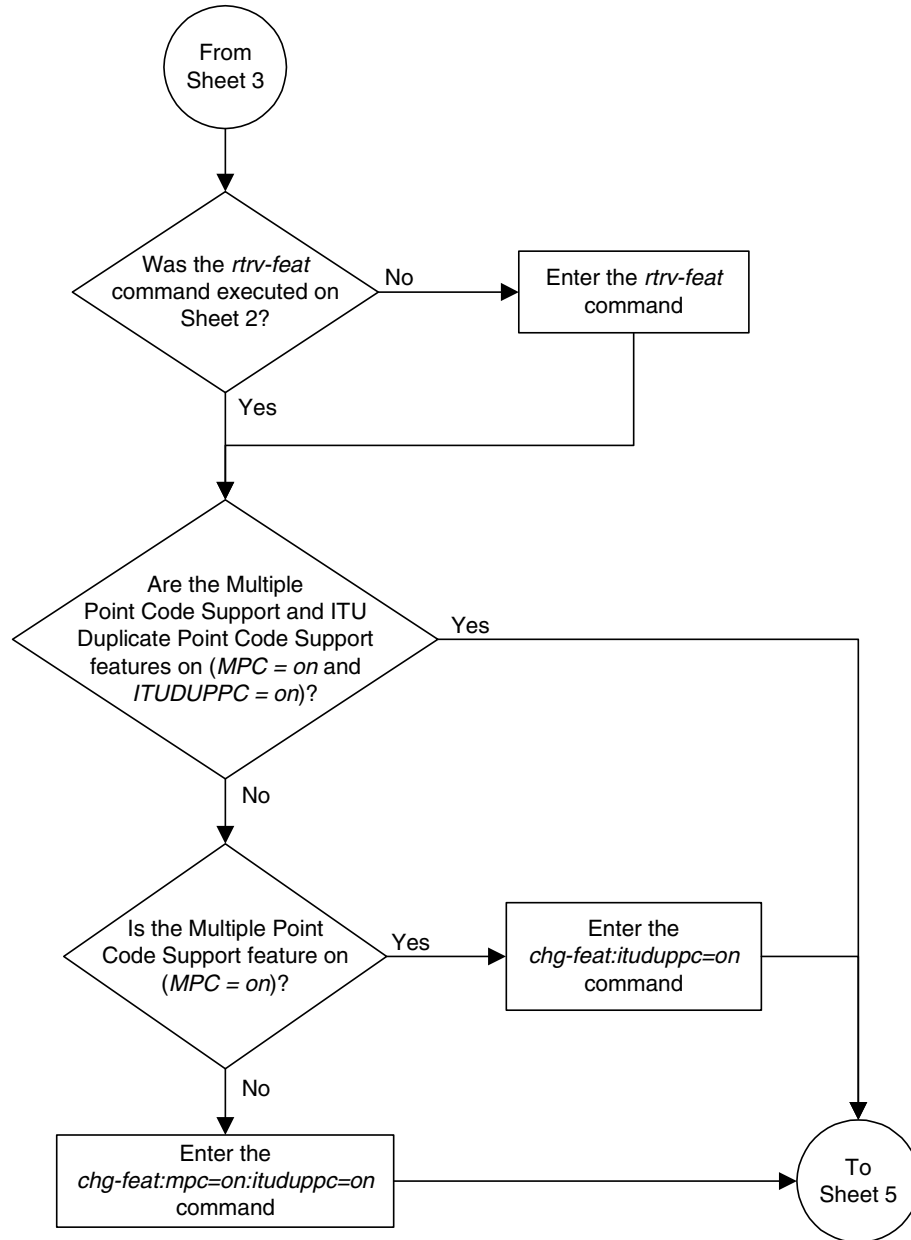

Flowchart 2-7. Changing the Self-Identification of the System (Sheet 5 of 11)

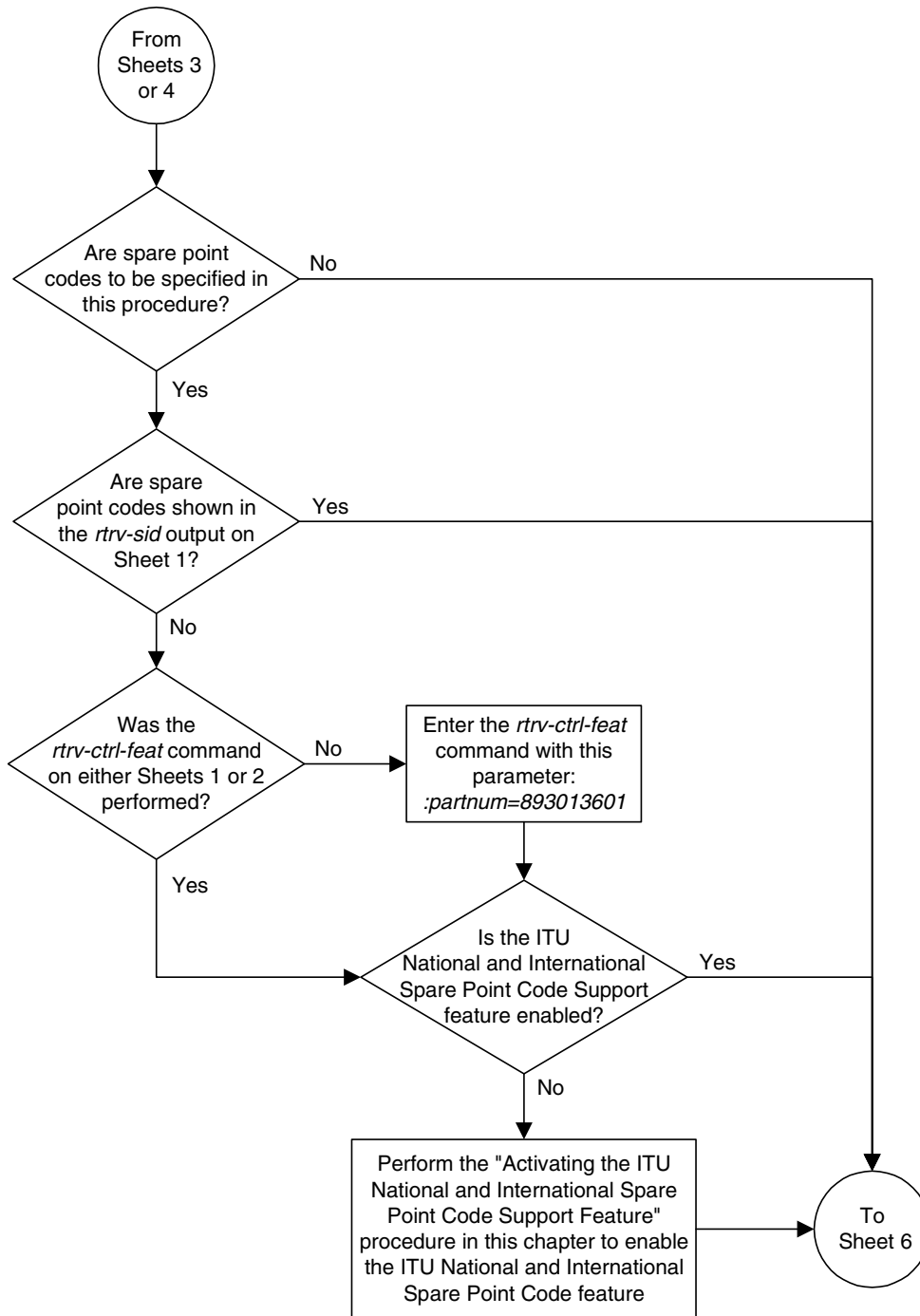

Flowchart 2-7. Changing the Self-Identification of the System (Sheet 6 of 11)

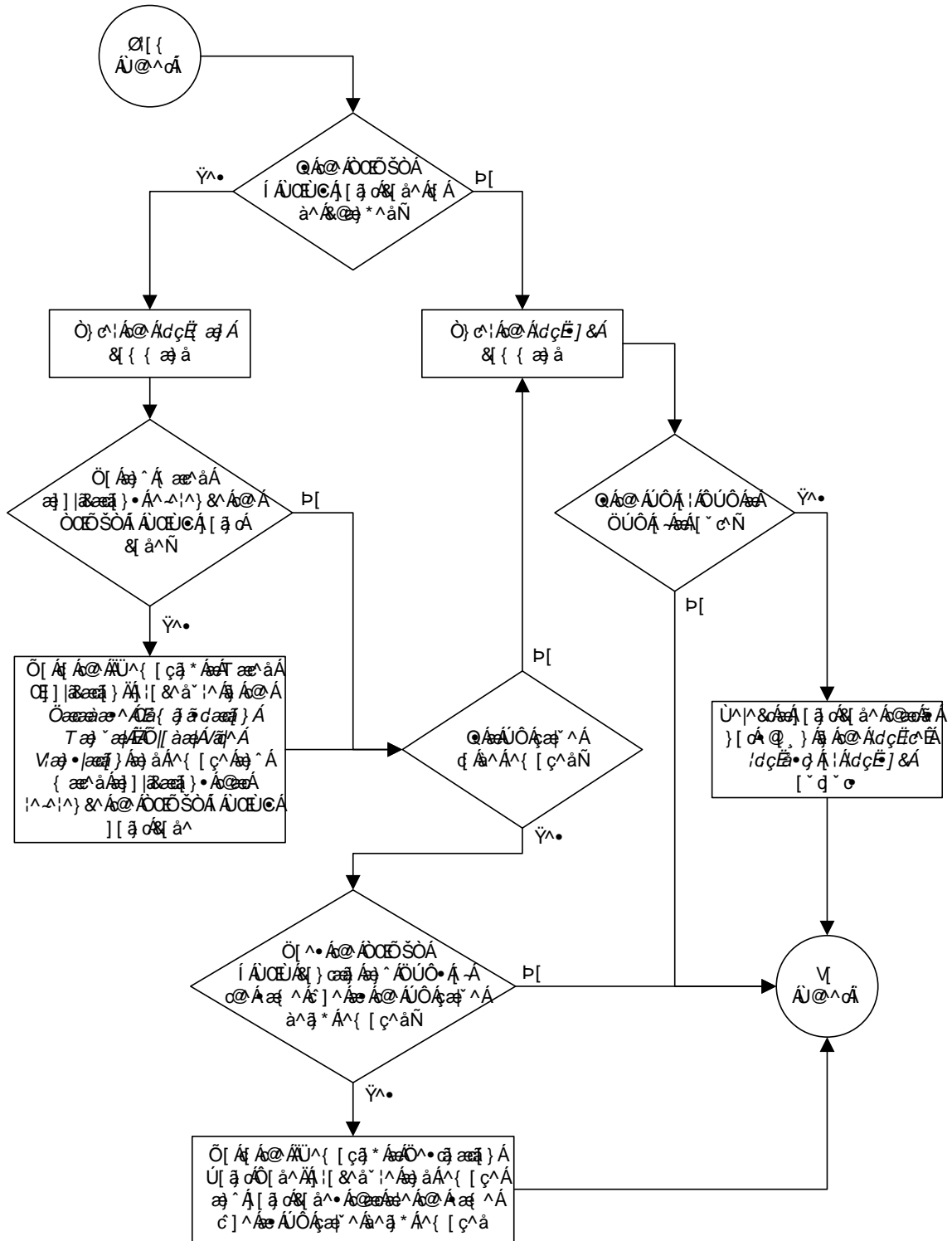

Flowchart 2-7. Changing the Self-Identification of the System (Sheet 7 of 11)

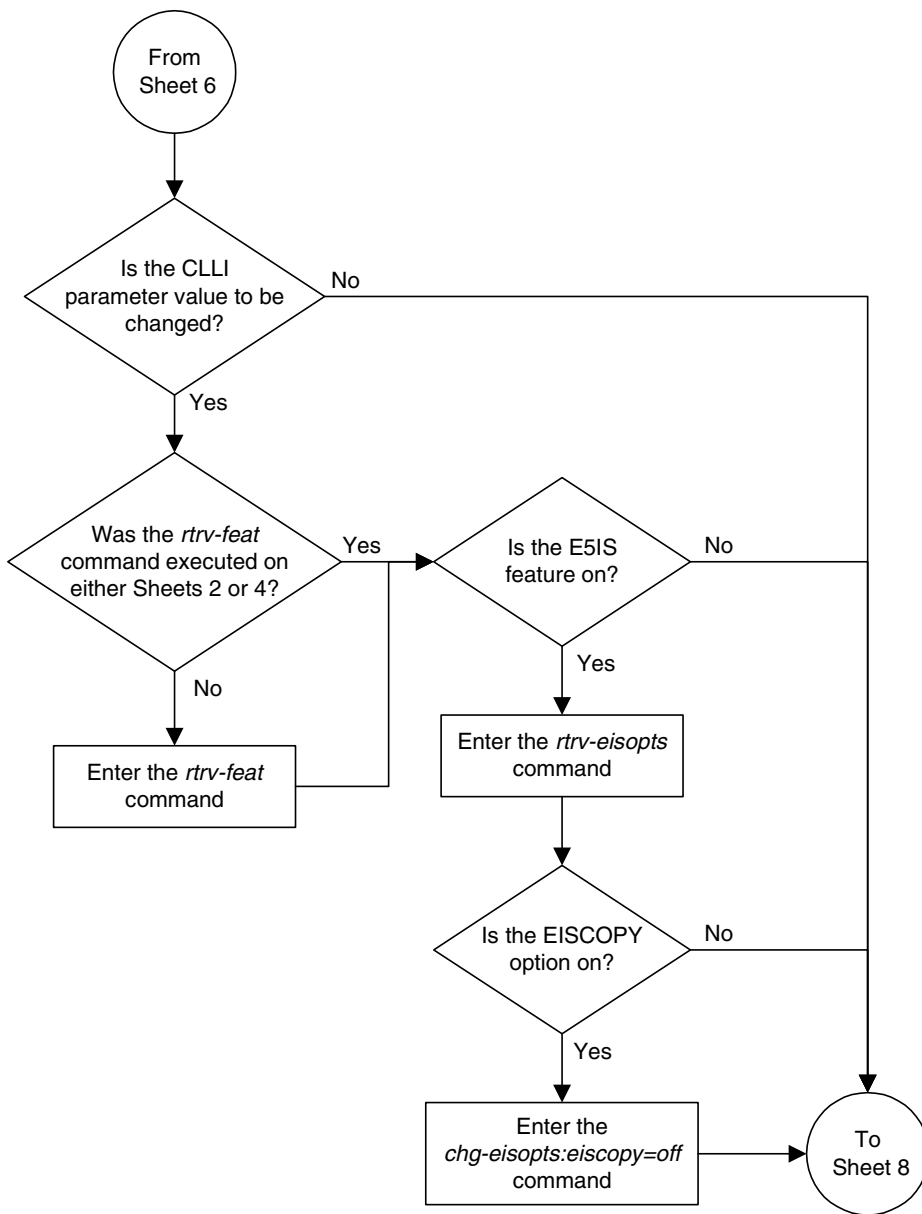

Flowchart 2-7. Changing the Self-Identification of the System (Sheet 8 of 11)

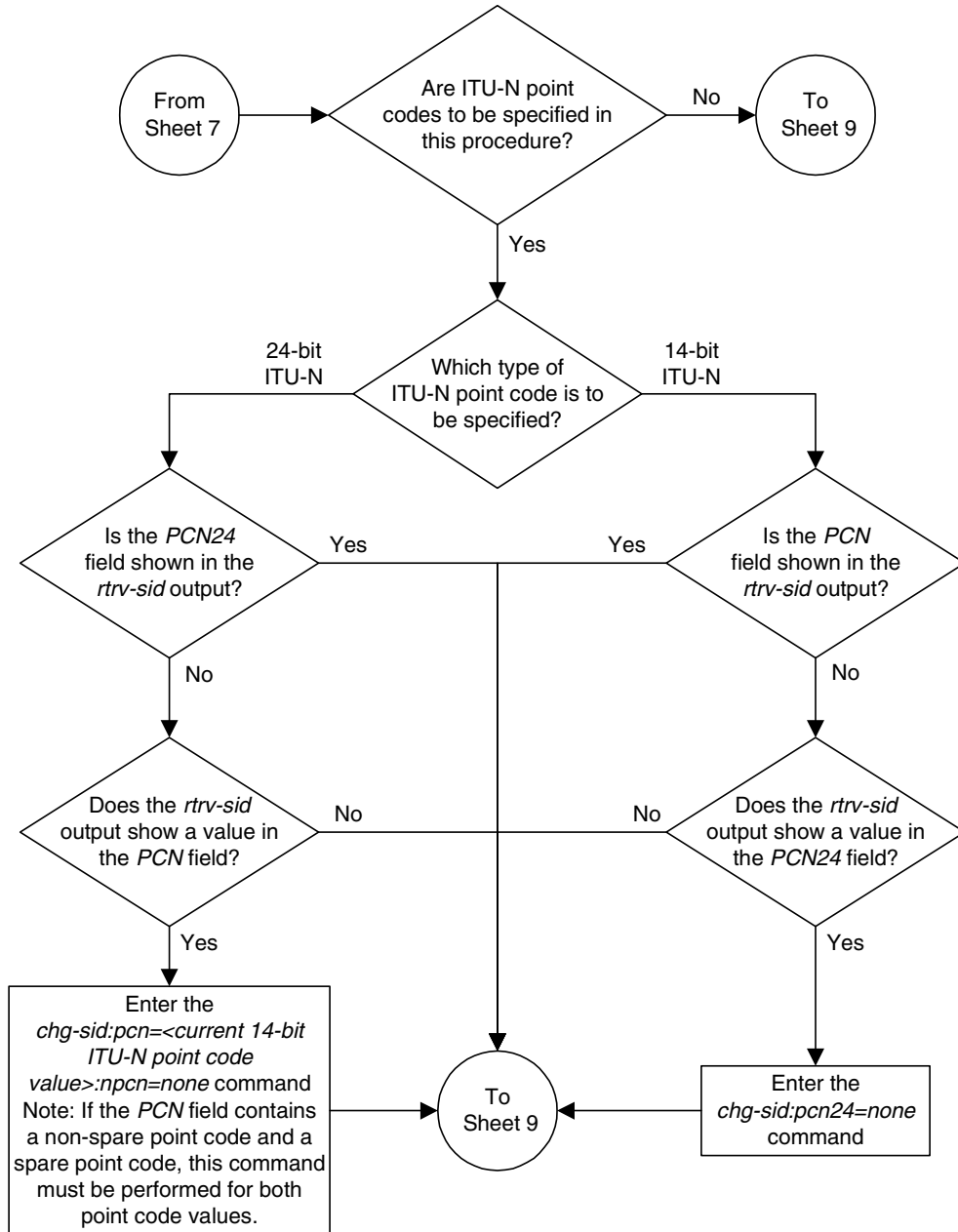

Flowchart 2-7. Changing the Self-Identification of the System (Sheet 9 of 11)

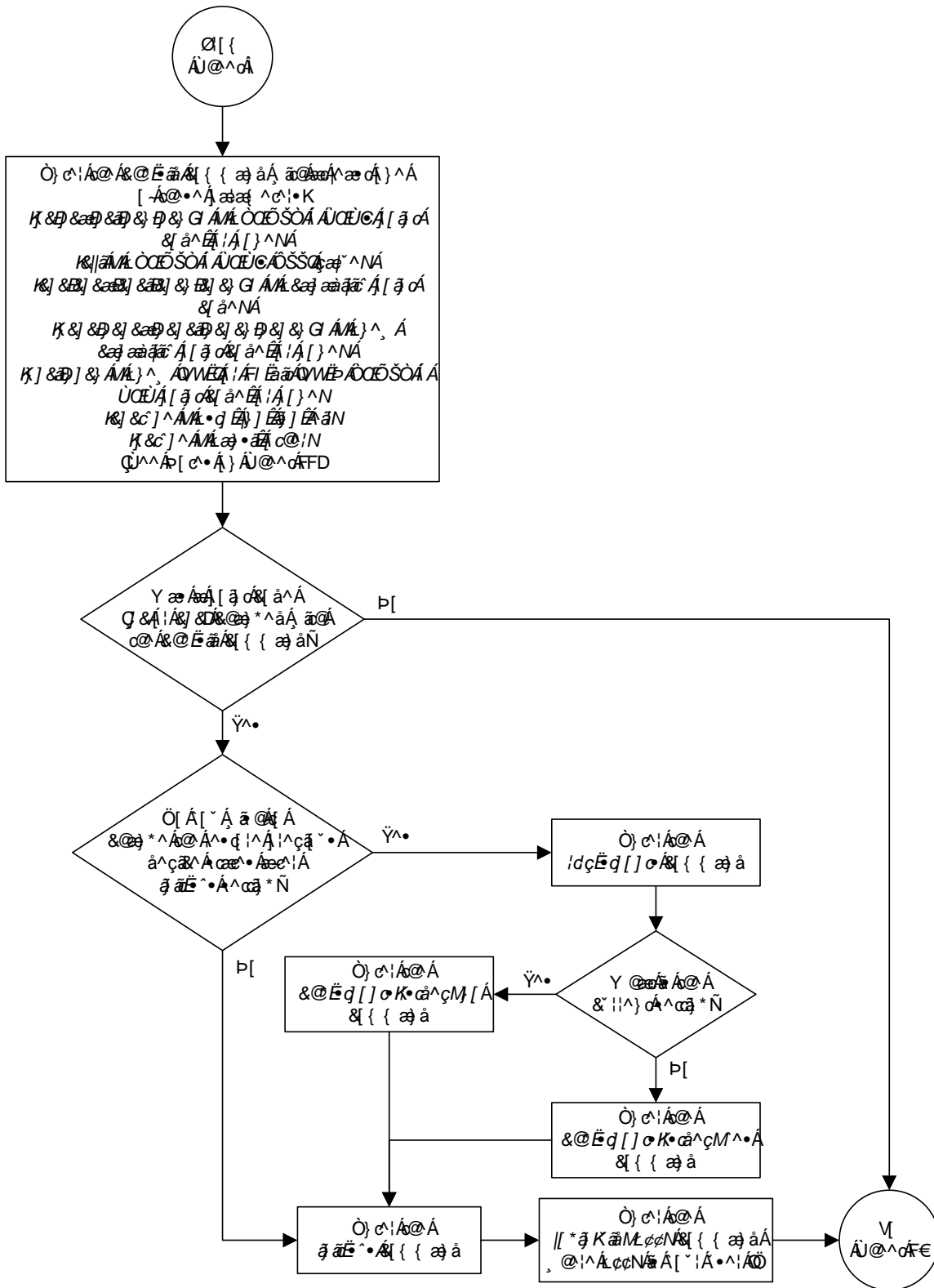

Configuring Destination Tables

Flowchart 2-7. Changing the Self-Identification of the System (Sheet 10 of 11)

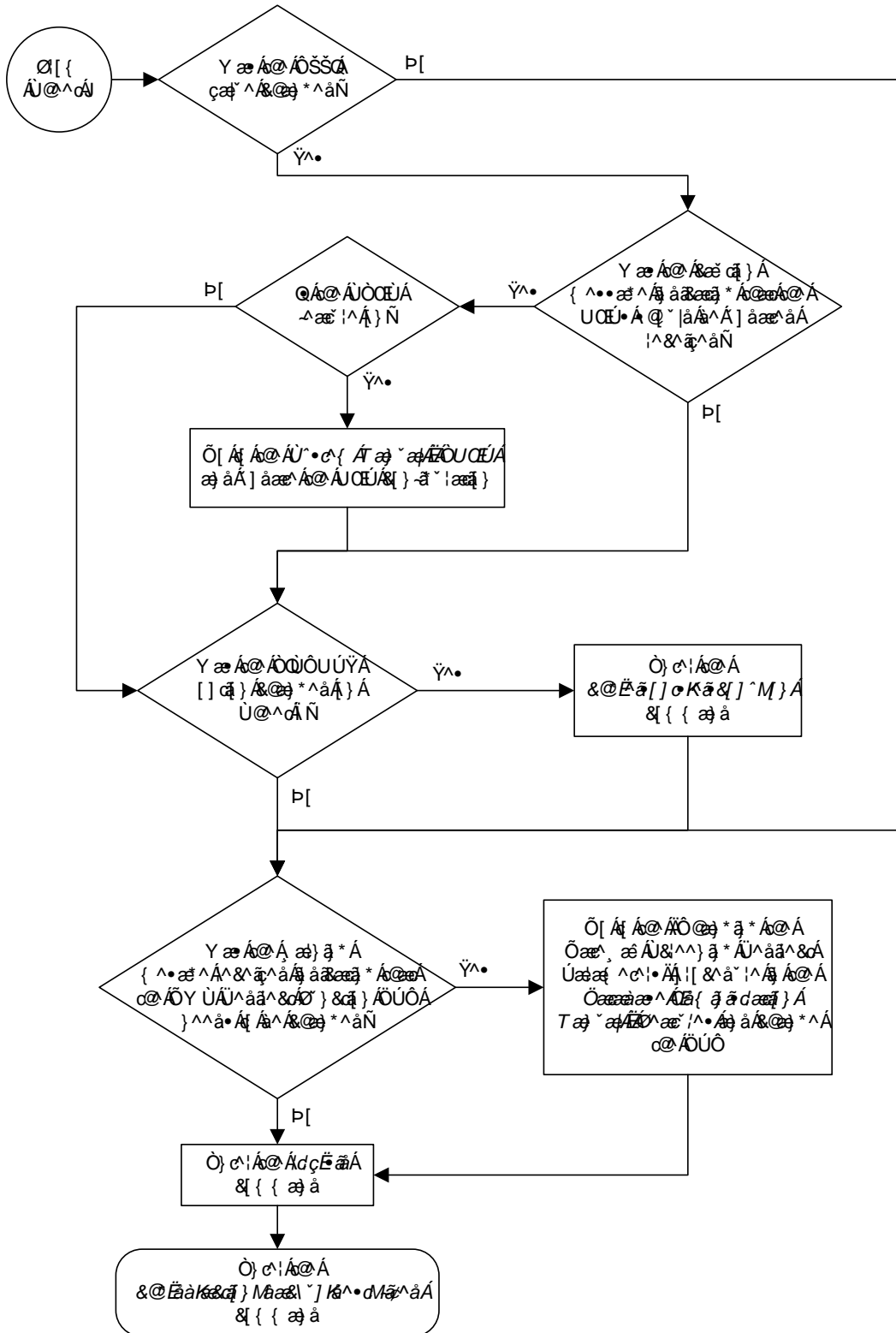

Flowchart 2-7. Changing the Self-Identification of the System (Sheet 11 of 11)



Cluster Routing and Management Diversity (CRMD)

The Cluster Routing and Management Diversity feature eliminates the need for a full point code entry in the routing table to route to every signaling point in every network. The Cluster Routing and Management Diversity feature allows the EAGLE 5 SAS to configure one routeset to a entire cluster of destinations. This feature also allows the EAGLE 5 SAS to manage and switch traffic to more end nodes.

If the 5000 Routes and 6000 Routesets features are not turned on, the routing table can contain 2000 entries. The 5000 Routes feature allows the routing table to contain up to 5000 entries. The 6000 Routesets feature increases the maximum number of entries to 6000 in the routing table.

A cluster is defined as a group of signaling points whose point codes have identical values for the network and cluster fields of the point codes. A cluster entry in the routing table is shown with an asterisk (*) in the member field of the point code, for example, 111-011-*. With this feature, ANSI destination point codes can be specified as either a full point code, for example, 123-043-045, or as a cluster of signaling point codes, for example, 111-011-*.

NOTE: Cluster entries can only be provisioned as ANSI destination point codes. Cluster entries cannot be provisioned for ITU international or ITU national destination point codes. The ANSI alias point code for an ITU international or ITU national destination point code must be a full point code.

If the X.25 gateway feature is turned on, all ANSI point codes specified as aliases and X.25 destinations must be full point codes and any routes used with the X.25 gateway feature must be defined with a full point code.

The Cluster Routing and Management Diversity feature allows provisioning of clusters, as well as of full point codes that belong to the same cluster as destination point codes (Figure 2-8). The point codes 111-011-*, 111-011-005 and 111-011-045 entries can be provisioned. In Figure 2-8, the cluster destination point code 111-011-* represents all the point codes of the cluster except for point codes 111-011-005 and 111-011-045. Cluster entries in the destination point code table can also be used as a DPC for a route. A group of such routes with varying relative cost forms a routeset to a cluster, just like a routeset to a full point code.

Figure 2-8. Cluster Routing and Management Diversity

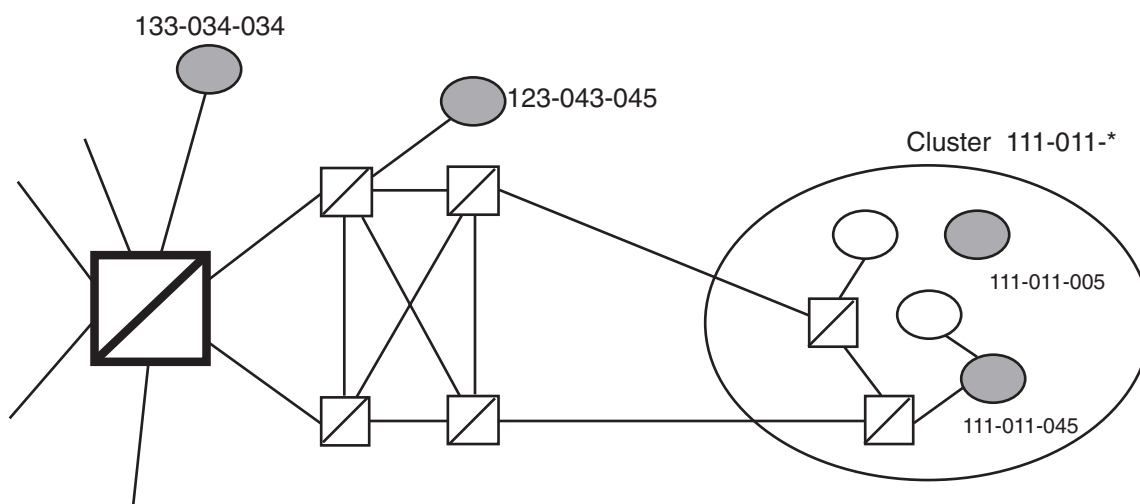

Exception Lists (X-lists)

An exception list for a cluster is a list of point codes in a cluster whose routes are more restricted than other routes to that cluster. The term “more restricted” is used when comparing the route status of a cluster member to the route status of the cluster. A **PROHIBITED** status is more restrictive than a **RESTRICTED** status, and a **RESTRICTED** status is more restrictive than an **ALLOWED** status.

This list contains point codes that are not assigned to any individual routeset, and the only routeset to that node is through a cluster routeset. The exception list is a dynamic list that changes when the status of the cluster routesets changes.

The EAGLE 5 SAS allows users to specify whether exception list entries need to be created on a per cluster basis. For each cluster, the user can specify an exception list exclusion indicator (ELEI) when configuring the cluster point code with the **ent-dstn** command. When the ELEI is **yes**, the EAGLE 5 SAS does not create exception list entries or remove any existing exception list entries for the given cluster. When the ELEI is **no**, the EAGLE 5 SAS creates and removes exception list entries. When the ELEI is **no**, it is not guaranteed that there will be space available to create each and every possible exception list entry for provisioned cluster entries. All such exception list entries must compete for available exception list space.

Configuring Destination Tables

Exception list entries are stored as an extension of the Destination Point Code table. The Destination Point Code table can contain a maximum number of entries, as follows:

- 2500 entries if the 5000 Routes feature is not turned on and 6000, 7000, or 8000 routesets are not enabled.
- 5500 entries if the 5000 Routes feature is turned on and 6000, 7000, or 8000 routesets are not enabled.
- 6500 entries if 6000 routesets are enabled.
- 7500 entries if 7000 routesets are enabled.
- 8500 entries if 8000 routesets are enabled.

The EAGLE 5 SAS allows the user to specify the number of entries reserved for the exception list. The remainder of the entries in the Destination Point Code table are reserved for configured destinations (the full and cluster point codes).

- If the 5000 Routes feature is off and 6000, 7000, or 8000 routesets are not enabled, the Destination Point Code table can contain up to 2500 entries. The exception list can contain from 500 to 2000 entries. The maximum number of entries reserved for configured destinations (full and cluster point codes) is 2500 minus the number of entries reserved for the exception list.
- If the 5000 Routes feature is on and 6000, 7000, or 8000 routesets are not enabled, the Destination Point Code table can contain up to 5500 entries. The exception list can contain from 500 to 5000 entries. The maximum number of entries reserved for configured destinations (full and cluster point codes) is 5500 minus the number of entries reserved for the exception list.
- If 6000 routesets are enabled, the Destination Point Code table can contain up to 6500 entries. The exception list can contain from 500 to 6000 entries. The maximum number of entries reserved for configured destinations (full and cluster point codes) is 6500 minus the number of entries reserved for the exception list.
- If 7000 routesets are enabled, the Destination Point Code table can contain up to 7500 entries. The exception list can contain from 500 to 7000 entries. The maximum number of entries reserved for configured destinations (full and cluster point codes) is 7500 minus the number of entries reserved for the exception list.
- If 8000 routesets are enabled, the Destination Point Code table can contain up to 8500 entries. The exception list can contain from 500 to 8000 entries. The maximum number of entries reserved for configured destinations (full and cluster point codes) is 8500 minus the number of entries reserved for the exception list.

The outputs of the `ent-dstn`, `dlt-dstn`, `chg-dstn`, and `rtrv-dstn` commands display this destination point code usage information:

- The number of configured full point codes
- The number of configured cluster point codes
- The number of configured network routing point codes
- The sum of configured destinations (full, network routing, and cluster point codes)
- The number of DPCs the EAGLE 5 SAS may contain (full, network routing, and cluster point codes). This number is the value of the `chg-stpopts` command's `mtpdpcq` parameter. This number is not always the maximum number of entries minus the number reserved for the exception list. This calculation determines the maximum number of DPCs the EAGLE 5 SAS may contain. The `mtpdpcq` parameter value of the `chg-stpopts` command determines the actual number of DPCs the EAGLE 5 SAS can have, and can be set to an amount less than the maximum.
- The number of entries reserved for exception list. This number is the value of the `chg-stpopts` command's `mtpxlq` parameter.
- The number of alias point codes the EAGLE 5 SAS may contain - 8000 or 12000. If 7000 or 8000 routesets are enabled, the EAGLE 5 SAS can contain a maximum of 8000 alias point codes. If 7000 or 8000 routesets are not enabled, the EAGLE 5 SAS can contain a maximum of 12000 alias point codes.
- The number of alias point codes configured in the EAGLE 5 SAS.

Exception list entries have an expiration timer. There is a single EAGLE 5 SAS-wide expiration timer value for exception list entries. The exception list expiration timer, the size of the exception list, and the percentage of occupancy that generates a minor alarm can be configured with the `chg-stpopts` command. The values are shown in these fields of the `rtrv-stpopts` command output:

MTPXLQ = the maximum number of entries the exception list (x-list) can contain.

MTPXLET = the maximum amount of time the EAGLE 5 SAS will maintain an unreferenced exception list (x-list) entry

MTPXLOT = the exception list (x-list) occupancy threshold (in terms of percentage of space available). If this threshold is exceeded, the EAGLE 5 SAS raises a minor alarm. The percentage of occupancy refers to the number of exception list entries as compared to the maximum number of entries the exception list can hold. For example, if there are 1500 entries configured for the exception list and the exception list contains 1000 entries, the percentage

Configuring Destination Tables

of the exception list space being used is 66%. If this threshold is exceeded, the EAGLE 5 SAS raises a minor alarm.

The EAGLE 5 SAS raises a major alarm when the exception list becomes completely full and the EAGLE 5 SAS fails to create any more exception list entries.

MTPDPCQ = the maximum number of destination point codes that can be configured in the EAGLE 5 SAS.

NOTE: The sum of the **MTPDPCQ** and **MTPXLQ** values cannot exceed one of these totals depending on the features that are enabled or turned on:

- 2500 – if the 5000 Routes feature is not on, and 6000, 7000, or 8000 routesets are not enabled.
- 5500 – if the 5000 Routes feature is on, but 6000, 7000, or 8000 routesets are not enabled.
- 6500 – if 6000 routesets are enabled.
- 7500 – if 7000 routesets are enabled.
- 8500 – if 8000 routesets are enabled.

An exception list entry's timer is restarted when an exception list entry gets created, updated, or used for routing. This expiration timer (the **mtpxlet** parameter in the **chg-stpopts** command) can be set from a minimum of 20 minutes to a maximum of 24 hours. The default value for the expiration timer upon EAGLE 5 SAS start-up is 60 minutes. If the timer expires before it is restarted, the exception list entry is removed. The expiration timer allows the EAGLE 5 SAS to save resources, if the exception list entry is sitting idle for a long time.

An exception list entry can be created for three distinct set of conditions:

1. The first set of conditions creates exception list entries based on the status of the route (allowed, restricted, or prohibited), and these entries are marked as "exception list due to routing."
2. The EAGLE 5 SAS creates an exception list entry to maintain the congestion status of a non-provisioned, cluster-routed destination point code. These entries are marked "exception list due to congestion."
3. The EAGLE 5 SAS also creates an exception list to prohibit routing to a member of a cluster when circular routing to that member is detected. These exception list entries are marked "exception list due to circular routing."

An exception list entry for a particular cluster can be removed from the exception list when these conditions are met:

1. The status of all routes to the specified point code changes to a status that is less or equally restrictive than the corresponding status of the cluster's routes. This can happen for two reasons.
 - a. A `dact-rstst` command was issued.
 - b. A network management message (TFA or TFR) was received indicating the new status of the route to the specified point code.
2. The expiration timer for the exception list entry expires.
3. When a `chg-dstn` command is issued and changes the ELEI to `yes` for the cluster, and the EAGLE 5 SAS removes all exception list entries created for that cluster.
4. The `chg-stpopts` command was issued with the `mtpxlet` parameter, and the new value for the `mtpxlet` parameter was smaller than the original value. This command can change the allocation of routing table entries for the exception list. If the size of the exception list is reduced and the number of entries in the exception list is now greater than the new value of the `mtpxlet` parameter, the EAGLE 5 SAS will remove excess exception list entries at random.
5. When the user allows a circular routed "exception list due to circular routing" entry.
6. When congestion abates for an "exception list due to routing" entry.

Cluster Routing

When the EAGLE 5 SAS receives an MSU to route, the routing function looks for the MSU's destination point code as a full point code entry in the routing table. If found, the full point code entry is used to find the corresponding routeset and the outgoing route. If a full point code entry is not found, the routing function uses the destination point code's network and cluster values to find a cluster entry to which the destination point code belongs. If found, the cluster entry is used to find the corresponding routeset and the outgoing route. If neither a full point code entry or cluster point code entry is found, the EAGLE 5 SAS generates UAM 1004, "MTP rcvd unknown DPC."

Compatibility with Non-Cluster Routing Nodes

It is possible that not all of the nodes in the network that the EAGLE 5 SAS is operating in are cluster routing nodes. In such a situation, those nodes not doing cluster routing will interpret TCx messages, and apply them to each individual point code belonging to the concerned cluster. This may cause an inconsistency in the status records for exception-listed point codes in different nodes. In order to avoid this situation, the EAGLE 5 SAS takes these steps:

1. After broadcasting a TCR message for a cluster, the EAGLE 5 SAS stops any level 3 T8 timers running for exception-listed members of the cluster, and enables TFPs for the cluster's exception-listed (prohibited) member point codes by stopping the level 3 T8 timer. This allows TFPs to be sent for prohibited members immediately after a TCR is broadcast.
2. After broadcasting a TCA message for a cluster, the EAGLE 5 SAS enables a one-time TFR for the cluster's exception-listed (restricted) member point codes by stopping the level 3 T18 timer, and enables the TFPs for the cluster's exception-listed (prohibited) member point codes by stopping the level 3 T8 timer. This allows TFPs to be sent for prohibited members, and TFRs for restricted members, immediately after a TCA is broadcast.

Cluster Management and the ITU Network

ITU SS7 networks do not use the concepts of clusters of point codes and cluster network management messages. The EAGLE 5 SAS does not generate TCx messages toward ITU nodes. When the EAGLE 5 SAS is acting as gateway between an ITU network and an ANSI network, during the broadcast phase of TCx messages, the EAGLE 5 SAS does not send TCx messages to adjacent ITU point codes. It is possible that messages may be lost in such a case. In order to reduce message loss and quickly notify the sending ITU node about the status, the EAGLE 5 SAS enables TFPs or TFRs immediately (with the level 3 T8 or T18 timers stopped) and relies on the TFPs or TFRs to convey the status information.

While sending response method network management messages in response to a received MSU, the EAGLE 5 SAS checks the MSU's originating point code. If the MSU's originating point code is an ITU point code, a Tfx message is returned.

Cluster Management When the Cluster Routing Feature is Turned Off

The Cluster Routing and Management Diversity feature is an optional feature that is turned off by default. To use the Cluster Routing and Management Diversity feature, it must be turned on by entering the appropriate command. Once this feature is turned on, it cannot be turned off. If this feature is turned off, the EAGLE 5 SAS does not send any cluster management messages or allow cluster destination point codes to be added to the destination point code table. The EAGLE 5 SAS is capable of processing incoming cluster management messages, even though the feature is turned off. When a cluster management message is received, the EAGLE 5 SAS treats this message as though network management messages were received for each full point code, configured in the destination point code table, that belongs to that cluster.

Cluster Routing and Management Diversity Rules

These rules apply to the Cluster Routing and Management Diversity feature:

- If the provisioned number of exception list entries are already created, the EAGLE 5 SAS will not create any more exception list entries. The EAGLE 5 SAS raises an alarm in advance of such an occurrence, and pegs each occurrence of failure-to-create an exception list entry.
- All adjacent point codes for linksets must be full point codes.
- All entries in the remote point code table must be a full point code.
- For X.25 destinations, the DPCs associated with the X.25 addresses must be full point codes and the DPCs of the routes associated with any X.25 routes must have full point codes.
- The EAGLE 5 SAS maintains the congestion status of only 100 destinations, including full point codes and point codes to which cluster routing is performed.
- When the cluster routing feature is turned on, and the EAGLE 5 SAS receives an MSU and does not find a route with a full point code, a cluster route, or any other full point code route belonging to the cluster, the EAGLE 5 SAS will generate a TCP response.
- When the cluster routing feature is turned off, and the EAGLE 5 SAS receives an MSU and does not find a route with a full point code, the EAGLE 5 SAS will generate a TFP response.

When the EAGLE 5 SAS is used as an ITU-ANSI gateway STP:

- The EAGLE 5 SAS does not broadcast TCx messages towards the ITU nodes. Messages could be lost until the response method is initiated. It is recommended that the cluster routing feature not be turned on when the EAGLE 5 SAS is an ITU gateway STP.

Configuring Destination Tables

- Cluster destination point codes cannot have ITU alias point codes.

All ANSI alias point codes specified for real ITU point codes are required to be full point codes.

The point code specified in the `ent-map` command must use a full point code, and that full point code must be in the routing table.

The point code specified in the `ent-gtt` and `ent-cspc` commands can use either a full point code or a cluster point code, but these point codes must be in the routing table.

The EAGLE 5 SAS allows cluster routing for subsequent global title (GTT) messages. The EAGLE 5 SAS also sends subsystem status messages to concerned point codes using a cluster route. The EAGLE 5 SAS does not generate MTP status messages for point codes that the EAGLE 5 SAS is routing clusters to, so all point codes in the mated application table must be full point codes.

Gateway screening verifies the concerned point code in TFX/RSx messages received by the EAGLE 5 SAS. Gateway screening passes a TFX/RSx message through the MTP-affected destination test, if the concerned point code has either a full point code route or a cluster route.

Gateway screening verifies the concerned point code in TCx/RCx messages received by the EAGLE 5 SAS. Gateway screening passes a TCx/RCx message through the MTP-affected destination test, if the concerned point code has either a cluster route for a concerned cluster or a member route for any of the members of the concerned cluster.

The EAGLE 5 SAS verifies that all destinations (X.25 destinations and SS7 destinations) used by the X.25 gateway feature have a full point code route available. The EAGLE 5 SAS does not allow the use of cluster routes to destinations used by the X.25 gateway feature because of these reasons:

- When SS7 destinations are routed using a cluster route, the EAGLE 5 SAS does not generate the MTP-PAUSE and MTP-RESUME indications for individual point codes of that cluster. These indications are required by the X.25 gateway feature to tear down virtual circuits in the case of inaccessibility to the node in SS7 network.
- When X.25 destinations are routed using a cluster route, there are chances of a transient flood of TFP messages and consequent TFA messages when the X.25 gateway feature is restarting. This results in a transient flood of exception list entries and degrades the EAGLE 5 SAS's performance and results in traffic loss.

If a point code is in the routing table as an exception-listed point code and the user enters a command (`ent-dstn`) to configure that same point code as a full point code, the exception-listed point code attribute is changed to a full point code attribute, and the exception-list related information from the cluster entry is updated.

When a cluster destination point code is removed from the EAGLE 5 SAS's database, all related exception-listed point codes of that cluster are removed.

The EAGLE 5 SAS implements these protocol features that are non-preferred options:

- The EAGLE 5 SAS broadcasts a TFP, when a full point code is prohibited and these conditions apply:
 - a. The corresponding cluster is not provisioned.
 - b. All other full point codes belonging to the same cluster are prohibited on the same route.
- The EAGLE 5 SAS responds with a TFP, when a message is received for an inaccessible point code and the corresponding cluster does not exist.
- Upon receiving a TCR message for a cluster that is not configured, the EAGLE 5 SAS marks all individually configured members of that cluster as restricted, and starts the RSR procedure for them.
- Upon receiving a TCP message for a cluster that is not provisioned, the EAGLE 5 SAS marks all individually configured members of that cluster as prohibited, and starts the RSP procedure for them.
- The EAGLE 5 SAS stops the level 3 T8 and T18 timers, after broadcasting a TCA for prohibited and restricted members of the clusters. These members can be exception-listed point codes or full point codes.
- The EAGLE 5 SAS stops the level 3 T8 timers after broadcasting a TCR for prohibited members of the clusters. These members can be exception-listed point codes or full point codes.

The route assigned to a full point code DPC cannot be removed from the database if that DPC is a member of a cluster point code in the database.

If a route assigned to a cluster point code is removed from the database, all routes to any members of that cluster are also removed from the database.

Cluster Routing and Management Diversity Example

This section shows an example of the Cluster Routing and Management Diversity feature, and lists the network events affecting the EAGLE 5 SAS. This example is based on Figure 2-9 and Table 2-3.

Figure 2-9. Cluster Management

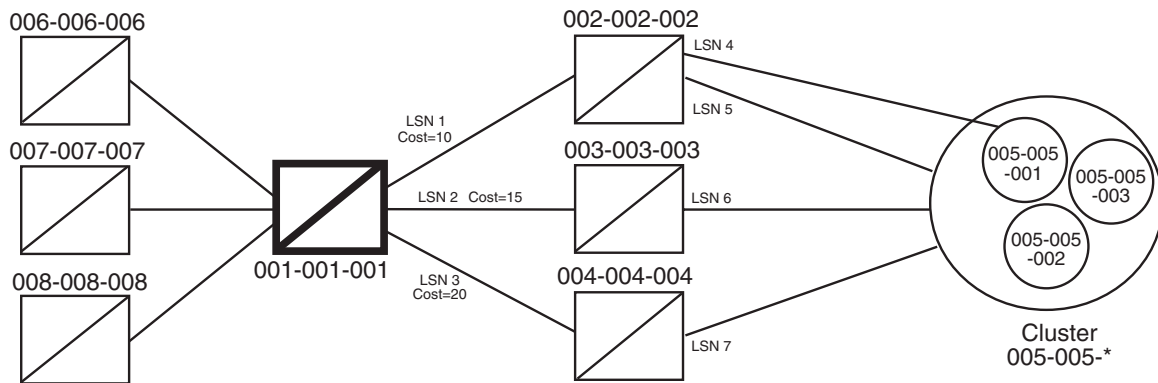

Table 2-3. Example Cluster Routing Information

	Route Table for Destination 005-005-001	Route Table for Cluster 005-005-*
1	LSN 1, Cost=10	LSN 1, Cost=10
2	LSN 2, Cost=15	LSN 2, Cost=15
3	LSN 3, Cost=20	LSN 3, Cost=20

When the normal routes, linksets LSN 1 and LSN 2, become available, the EAGLE 5 SAS sends a preventive TFP for destination 005-005-001 and a preventive TCP for cluster 005-005-* to node 002-002-002, and starts routing messages to destination 005-005-001 and cluster 005-005-* using linkset LSN 1. The EAGLE 5 SAS broadcasts TFAs about destination 005-005-001 and TCAs about cluster 005-005-* to all other adjacent nodes.

1. When linkset LSN 4 fails, node 002-002-002 sends a TFP for destination 005-005-001 to the EAGLE 5 SAS. Linkset LSN 4 is prohibited from carrying traffic from the EAGLE 5 SAS to destination 005-005-001. The EAGLE 5 SAS stops using linkset LSN 1 to send traffic to destination 005-005-001, performs forced rerouting, starts level 3 timer T11 for destination 005-005-001, and starts using linkset LSN 2 to send messages to destination 005-005-001. The EAGLE 5 SAS generates preventive TFPs about destination 005-005-001 to node 002-002-003. The preventive TCP for cluster 005-005-* sent to node 002-002-002 remains in effect.

When the level 3 timer T11 for destination 005-005-001 expires, TFRs are broadcast for destination 005-005-001 to nodes 004-004-004, 006-006-006, 007-007-007, and 008-008-008. Destination 005-005-001 is restricted.

2. When linkset LSN 5 fails, node 002-002-002 sends a TCP for cluster 005-005-* to the EAGLE 5 SAS. Linkset LSN 5 is prohibited from carrying traffic from the EAGLE 5 SAS to cluster 005-005-*. The EAGLE 5 SAS stops using linkset LSN 1 to send traffic to cluster 005-005-*, performs forced rerouting, starts the

level 3 timer T11 for cluster 005-005-*, and starts using linkset LSN 2 to send messages to cluster 005-005-*. The EAGLE 5 SAS sends preventive TCPs for cluster 005-005-* on linkset LSN 2. The EAGLE 5 SAS sends a TCR for cluster 005-005-* on linkset LSN 1, to allow cluster 005-005-* and destination 005-005-001 to send messages back to the EAGLE 5 SAS on linkset LSN 1. When the level 3 timer T11 for cluster 005-005-* expires, the EAGLE 5 SAS sends a TCR for cluster 005-005-* to nodes 004-004-004, 006-006-006, 007-007-007, and 008-008-008. Cluster 005-005-* is restricted.

3. When linkset LSN 6 fails, node 003-003-003 sends a TCP for cluster 005-005-* to the EAGLE 5 SAS. The EAGLE 5 SAS performs forced rerouting, sends a preventive TFP for destination 005-005-001 and a TCP for destination 005-005-001 to node 004-004-004, and starts using linkset LSN 3 for sending messages to destination 005-005-001 and cluster 005-005-*.
4. When linkset LSN 7 fails, node 004-004-004 sends a TCP for cluster 005-005-* to EAGLE 5 SAS. The EAGLE 5 SAS cannot send traffic to either destination 005-005-001 or cluster 005-005-*. The EAGLE 5 SAS broadcasts TCPs for cluster 005-005-* to nodes 002-002-002, 003-003-003, 004-004-004, 006-006-006, 007-007-007, and 008-008-008. Cluster 005-005-* and destination 005-005-001 are inaccessible.
5. When linkset LSN 7 recovers, node 004-004-004 sends a TCA for cluster 005-005-* to the EAGLE 5 SAS. The EAGLE 5 SAS sends a preventive TCP for cluster 005-005-* to node 004-004-004, and starts using linkset LSN 3 to send traffic to cluster 005-005-*. The EAGLE 5 SAS sends a TCR for cluster 005-005-* to node 002-002-002. This allows cluster 005-005-* to send messages back to the EAGLE 5 SAS on linkset LSN 3. The EAGLE 5 SAS sends a preventive TCP for cluster 005-005-* to nodes 003-003-003 and 004-004-004. The EAGLE 5 SAS sends a TCR for cluster 005-005-* to nodes 006-006-006, 007-007-007, and 008-008-008. The EAGLE 5 SAS enables response method for destination 005-005-001, and starts a routeset test for destination 005-005-001 on linkset LSN 3. Cluster 005-005-* is restricted.
6. When linkset LSN 6 recovers, node 003-003-003 sends a TCA for cluster 005-005-* to the EAGLE 5 SAS. The EAGLE 5 SAS performs controlled rerouting on cluster 005-005-*, sends a preventive TCP for cluster 005-005-* to node 003-003-003, and starts using linkset LSN 2 to send traffic to cluster 005-005-*. The EAGLE 5 SAS sends a TCR for cluster 005-005-* to node 004-004-004. The EAGLE 5 SAS starts a routeset test for destination 005-005-001 on linkset LSN 2.

Configuring Destination Tables

7. When linkset LSN 5 recovers, node 002-002-002 sends a TCA for cluster 005-005-* to the EAGLE 5 SAS. The EAGLE 5 SAS performs controlled rerouting, and starts using linkset LSN 1 to send traffic to cluster 005-005-*. The EAGLE 5 SAS sends a preventive TCP for cluster 005-005-* to node 002-002-002. The EAGLE 5 SAS broadcasts a TCA for cluster 005-005-* to nodes 003-003-003, 004-004-004, 006-006-006, 007-007-007, and 008-008-008. The EAGLE 5 SAS enables response method for destination 005-005-001, and starts a routeset test for destination 005-005-001 on linkset LSN 1. Cluster 005-005-* is allowed.
8. In response to the routeset test, node 004-004-004 sends a TFA for destination 005-005-001 to the EAGLE 5 SAS. The EAGLE 5 SAS performs controlled rerouting, and starts using linkset LSN 3 to send traffic to destination 005-005-001. The EAGLE 5 SAS sends a preventive TFP for destination 005-005-001 to nodes 003-003-003 and 004-004-004. The EAGLE 5 SAS sends a TFR for destination 005-005-001 to node 002-002-002 that allows destination 005-005-001 to send messages back to the EAGLE 5 SAS on linkset LSN 1. The EAGLE 5 SAS broadcasts a TFR for destination 005-005-001 to nodes 006-006-006, 007-007-007, and 008-008-008. Destination 005-005-001 is restricted.
9. In response to the routeset test, node 003-003-003 sends a TFA for destination 005-005-001 to the EAGLE 5 SAS. The EAGLE 5 SAS performs controlled rerouting and starts using linkset LSN 2 to send traffic to destination 005-005-001. The EAGLE 5 SAS sends a preventive TFP for destination 005-005-001 to node 003-003-003. The EAGLE 5 SAS sends a TFR for destination 005-005-001 to node 004-004-004.
10. In response to the routeset test, node 002-002-002 sends a TFA for destination 005-005-001 to the EAGLE 5 SAS. The EAGLE 5 SAS performs controlled rerouting, and starts using linkset LSN 1 to send traffic to destination 005-005-001. The EAGLE 5 SAS sends a preventive TFP for destination 005-005-001 to node 002-002-002. The EAGLE 5 SAS sends a TFA for destination 005-005-001 to nodes 003-003-003, 004-004-004, 006-006-006, 007-007-007, and 008-008-008. Destination 005-005-001 is allowed.

Home Cluster Example

Figure 2-10. Home Cluster Example

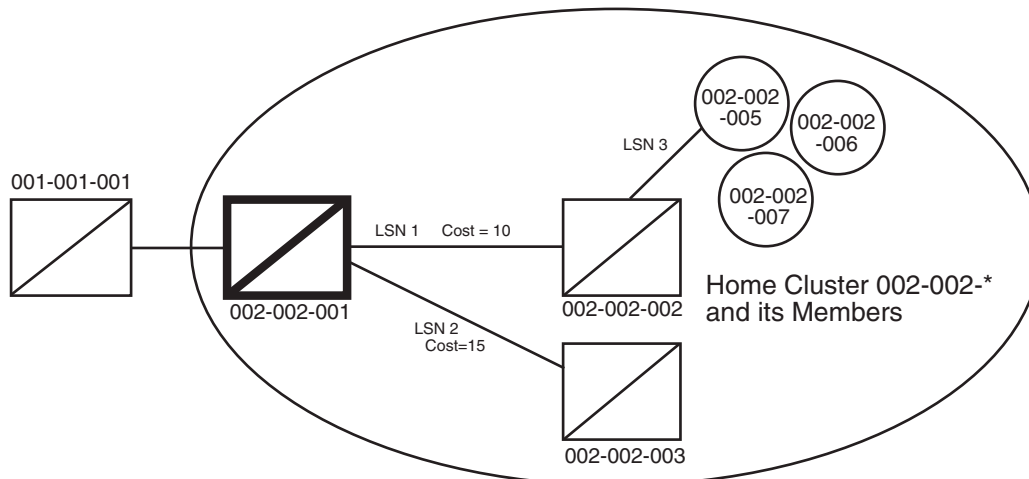

Table 2-4. Home Cluster Routing Information

	Route table for Destination 002-002-005	Route table for cluster 002-002-*
1	LSN 1, Cost=10	LSN 1, Cost=10
2	LSN 2, Cost=15	LSN 2, Cost=15

A home cluster is a cluster point code that contains either the true point code or any capability point code of the EAGLE 5 SAS. For example, if the EAGLE 5 SAS's true point code or any capability point code is 002-002-001 and a cluster 002-002-* is configured, then the cluster 002-002-* is a home cluster.

Provisioning a home cluster causes a profound impact on network management, regarding the home cluster as well as members of the cluster. These impacts are:

- Because the EAGLE 5 SAS is one of the accessible members of the home cluster, the EAGLE 5 SAS never transmits TCP or TCR messages regarding the home cluster, except for these:
 - a. Preventive TCP – when starting to route to the cluster through an adjacent node
 - b. Broadcast TCR – when the EAGLE 5 SAS starts routing on an alternate route for the entire cluster
 - c. Back Routing TCR – to allow adjacent nodes on normal routes to route through the EAGLE 5 SAS, when the cluster is not accessible on the normal route

Configuring Destination Tables

- d. Broadcast TCP – when the cluster (except the EAGLE 5 SAS itself) becomes inaccessible
- If individual members are provisioned for the home cluster, the EAGLE 5 SAS properly generates network management messages for these nodes, except that no TFRs can be sent from those members being routed on the alternate route to the EAGLE 5 SAS.
 - Network management replies to the routeset test, and the response method generates the correct network management messages for the home cluster, its members, and unprovisioned member point codes.
 - When the entire home cluster is being routed on the alternate route, the EAGLE 5 SAS generates a full point code response method TFR reply. In such a case, the EAGLE 5 SAS generates only one TFR for the very first member of the cluster for which MSU is received on each signaling link to that cluster.
 - When the home cluster is inaccessible, the EAGLE 5 SAS generates one response TFP, at an interval equal to the value of the level 3 timer T8 for the members of the home cluster. If the EAGLE 5 SAS keeps receiving traffic for the home cluster, the EAGLE 5 SAS sends response TFPs for all members of the cluster.

This makes network management unreliable for the home cluster and its members.

When the normal routes, linksets LSN 1 and LSN 2, become available, the EAGLE 5 SAS sends a preventive TFP for destination 002-002-005 to node 002-002-002, and starts sending messages to destination 002-002-005 and cluster 002-002-* using linkset LSN 1. No preventive messages are sent for cluster 002-002-*. The EAGLE 5 SAS broadcasts a TFA for destination 002-002-005 and a TCA for cluster 002-002-* to all other adjacent nodes.

1. Node 002-002-002 sends an MSU containing the destination point code 002-002-006 on linkset LSN 1. The EAGLE 5 SAS responds with a response preventive TFP for destination 002-002-006 to node 002-002-002.
2. When linkset LSN 3 fails, node 002-002-002 sends a TFP for destination 002-002-005 to the EAGLE 5 SAS. The EAGLE 5 SAS stops using linkset LSN 1 to send traffic to destination 002-002-005, performs forced rerouting, starts the level 3 timer T11 for destination 002-002-005, and starts using linkset LSN 2 to send traffic to destination 002-002-005. The EAGLE 5 SAS generates a preventive TFP for destination 002-002-005 to node 002-002-003. When the level 3 timer T11 for destination 002-002-005 expires, TFRs for destination 002-002-005 are broadcast to nodes 002-002-003 and 001-001-001. Destination 002-002-005 is restricted.

3. Node 002-002-002 sends an MSU containing the destination point code 002-002-005 on linkset LSN 1. The EAGLE 5 SAS responds with a response preventive TFP for destination 002-002-005 to node 002-002-002, because no member of a home cluster is allowed to route messages back to the EAGLE 5 SAS.
4. When linkset LSN 1 fails, the EAGLE 5 SAS stops using linkset LSN 1 to send traffic to cluster 002-002-*, performs forced rerouting, starts the level 3 timer T11 for cluster 002-002-*, and starts using linkset LSN 2 to send traffic to cluster 002-002-*. Cluster 002-002-* is restricted. No preventive or broadcast messages are sent, and no member of the cluster is allowed to send messages back to the EAGLE 5 SAS.
5. Node 001-001-001 sends an MSU containing the destination point code 002-002-006. The EAGLE 5 SAS responds with a response TFR for destination 002-002-006 to node 001-001-001. The MSU is routed on linkset LSN 2.
6. Node 001-001-001 sends an MSU containing the destination point code 002-002-005. The EAGLE 5 SAS responds with a response TFR for destination 002-002-005 to node 001-001-001. The MSU is routed on linkset LSN 2.
7. Node 001-001-001 sends an MSU containing the destination point code 002-002-007 and receives no response. The MSU is routed on linkset LSN 2.
8. When linkset LSN 2 fails, destination 002-002-005 and cluster 002-002-* are prohibited. The EAGLE 5 SAS broadcasts a TFP for destination 002-002-005 to node 001-001-001.
9. Node 001-001-001 sends an MSU containing the destination point code 002-002-007. The EAGLE 5 SAS responds with a TFP for destination 002-002-007 to node 001-001-001, and starts the level 3 timer T8 for cluster 002-002-*.
10. Node 001-001-001 sends an MSU containing the destination point code 002-002-006, and receives no response until the level 3 timer T8 expires.
11. Node 001-001-001 sends an MSU containing the destination point code 002-002-005. The EAGLE 5 SAS responds with a TFP for destination 002-002-005 to node 001-001-001, and starts the level 3 timer T8 for destination 002-002-005.
12. Node 001-001-001 sends an MSU containing the destination point code 002-002-006. After the level 3 timer T8 for cluster 002-002-* expires, the EAGLE 5 SAS responds with a TFP for destination 002-002-006 to node 001-001-001, and starts the level 3 timer T8 for cluster 002-002-*.

Nested Cluster Routing

When a node is switching traffic to remote (non-adjacent) nodes, it is possible that an STP is using at least one route that is different from the other members of a cluster. Typically, this occurs when the node is directly connected to the member of a cluster, such as when an STP has A-links or E-links that are connected to a member. The nested cluster routing feature provides a mechanism that allows both cluster and member routes to be provisioned in the same cluster.

Nested Clusters and Cluster Members

The cluster routing and management feature requires that routes to a cluster and members of that cluster be in the same routeset. With the nested cluster routing feature, however, users can have certain members of the provisioned cluster with different full point code routesets. This different routeset may be totally different, partially different, or exactly the same.

With the nested cluster routing feature, routes to these members can be changed, deleted, or added. Deletion of a full point code route entry within a cluster will result in the member using the cluster entry for routing. Deletion of a cluster route entry will not delete the full point code route entry. This holds true even if the full point code entry and the cluster have the same route.

The EAGLE 5 SAS sends cluster network management messages (TCA, TCR, TCP) based on the least restrictive of the cluster's routeset status, and the routeset status of any full point code entries within the cluster.

The nested cluster routing feature provides a new routing model. The EAGLE 5 SAS allows several routing models. Table 2-5 describes coupling between the cluster and its members. Coupling describes the relationship between the cluster and member routes.

Table 2-5. Routing Models

System Routing Model	Characteristics	Issues and Resolution
Full Point Code Routing (FPR) No coupling	The EAGLE 5 SAS behaves as a full point code router when the Cluster Routing and Management Diversity feature is off. Only full point code destinations are provisioned. The EAGLE 5 SAS never generates TCx messages concerning clusters of provisioned members. Received TCx messages are applied to all members of the concerned cluster.	No issues. There is no coupling between cluster status and member statuses due to the lack of clusters.

Table 2-5. Routing Models (Continued)

System Routing Model	Characteristics	Issues and Resolution
Cluster Routing (CR) No coupling NCAI=No	With the Cluster Routing and Management Diversity feature on, the EAGLE 5 SAS allows the provisioning of cluster destinations. For cluster destinations, only cluster destinations are provisioned. The EAGLE 5 SAS generates TCx messages only for provisioned cluster destinations. All received TCx messages are applied to concerned cluster entry, if it exists. Otherwise, it is applied to all individual members.	No issues. There is no coupling between cluster status and member status due to the lack of members belonging to provisioned cluster.
Cluster Routing and Management Diversity (CRMD) Full coupling NCAI=No	In this mode, the EAGLE 5 SAS allows provisioning of clusters as well as members of same clusters. Here cluster and member have the same routeset, and they are fully coupled. All TCx messages are applied to members, and TCx messages generated by the EAGLE 5 SAS reflect member status. In this mode, the member status cannot be less restrictive than the cluster.	No issues regarding network management message generation and processing. Cluster and members cannot have a different routeset, and thus E-links cannot be provisioned for members of a cluster.
Nested Cluster Routing No coupling NCAI=Yes	In this mode, if the <code>ncai</code> parameter is <code>yes</code> (provided both the nested cluster routing and the Cluster Routing and Management Diversity features are on), the user can enter a cluster routeset, then enter a different routeset for a member of that cluster. In this case, member routeset status can be less restricted than cluster routeset status.	There is an issue regarding broadcasting network management messages. Because members can be less restricted than the cluster, the broadcast of cluster messages (TCA, TCR, TCP) is based on the least restrictive of the following: <ul style="list-style-type: none"> • The cluster's routeset status. • The routeset status of any full point code entries within the cluster. • Also, when the <code>ncai</code> parameter is <code>yes</code>, the EAGLE 5 SAS does not generate preventive TCP messages.

Administration

The nested cluster routing feature is provisioned using the `ncai` parameter of either the `ent-dstn` or `chg-dstn` commands. The `ncai` parameter can only be specified for cluster point codes.

In order to specify the `ncai` parameter, both the Cluster Routing and Management Diversity and the nested cluster routing features must be on. If the `ncai` parameter is `yes`, the EAGLE 5 SAS allows certain members of the provisioned cluster to have a different full point code routeset.

If the `ncai` parameter is `no`, standard command-handler rules apply (any full point code routeset within a cluster must have the same routeset as the cluster). If `ncai` parameter is `yes`, new command-handler rules apply (full point code routeset can be different from the cluster routeset). Figure 2-11 provides an example of provisioning a nested cluster and its associated members.

Nested Cluster Routing Rules of Operations

The following rules apply to nested clusters (cluster entries with the `ncai` parameter set to `yes`):

1. The EAGLE 5 SAS allows the user to enter a full point code routeset entry even if the point code is a member of a cluster that has a different routeset. For example, in Figure 2-11, the provisioned member 5-5-1 has a different routeset than the cluster's routeset.
2. When the EAGLE 5 SAS broadcasts network management messages relating to the cluster, the EAGLE 5 SAS uses the least restricted of the following to determine which cluster message (TCA, TCR, TCP) to send:
 - The cluster's routeset status
 - The routeset status of any full point code entries within the clusterFor example, in Figure 2-11, if linkset LSB fails, a TCP message for cluster 5-5-* is not broadcast because the least restrictive status of provisioned member 5-5-1 is allowed.
3. The EAGLE 5 SAS does not send preventive TCPs when it begins routing towards a nested cluster. The EAGLE 5 SAS sends response-method preventive TFPs if it receives an MSU and there is danger of circular routing. For example, in Figure 2-11, the EAGLE 5 SAS does not send a preventive TCP for cluster 5-5-* when routing to cluster 5-5-* over linkset LSB. However, if the EAGLE 5 SAS receives an MSU on linkset LSB destined for node 5-5-2, the EAGLE 5 SAS discards the MSU and sends a TFP to node B concerning node 5-5-2.

NOTE: The EAGLE 5 SAS will still send preventive TFPs when it starts routing towards a full point code member of a nested cluster.

4. The EAGLE 5 SAS replies to RCx cluster routeset test messages, using the less restrictive routeset status as indicated in rule #2.
5. The EAGLE 5 SAS replies to RSx full point code routeset messages, using the full point code's routeset status and the danger of circular routing.
6. Response method TFP or TFR is used when the cluster destination is more restrictive than a full point code member. The modified TFP response method will send no more than one TFP per cluster member during the time period defined by the level 3 T8 timer. The modified TFR response method sends no more than one response TFR per cluster member.

Nested Cluster Routing Example

Figure 2-11 provide an example of nested cluster routing. Tables 2-6 and 2-7 show the routing tables for the cluster point code and one of the members of the cluster point code. Table 2-8 shows what actions the EAGLE 5 SAS takes when the linksets in a nested cluster configuration fail and recover. The actions in Table 2-8 are based on the example nested cluster routing configuration shown in Figure 2-11.

Figure 2-11. Nested Cluster Routing Sample Configuration

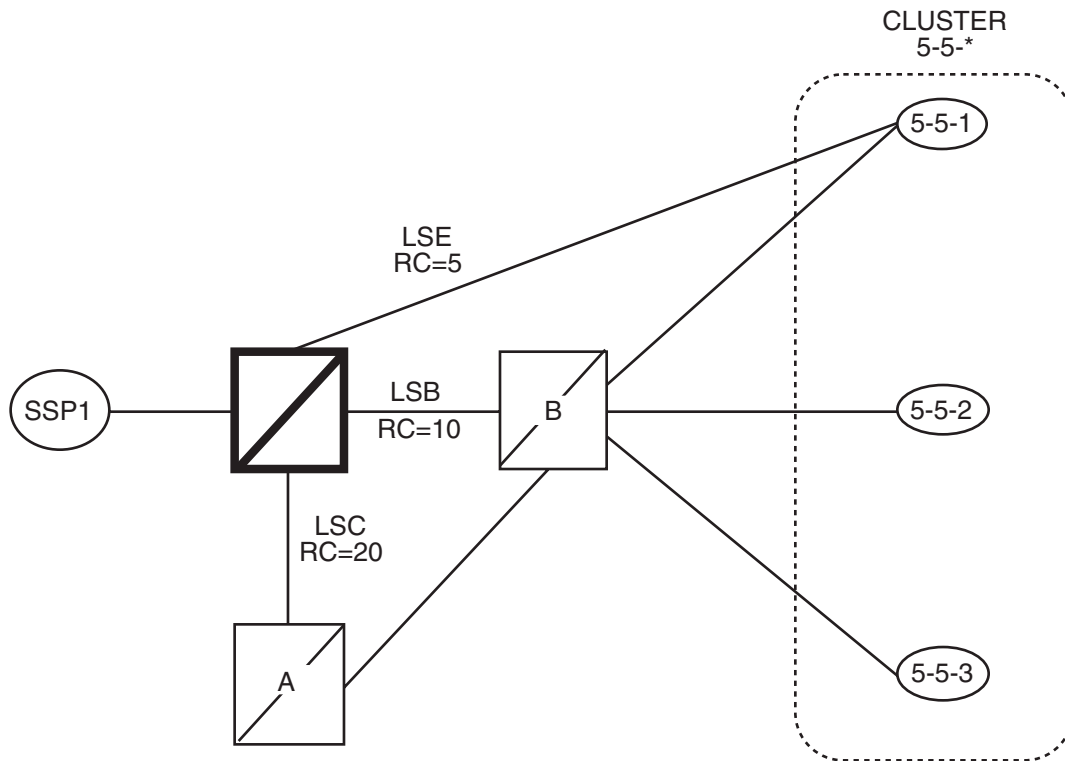

Configuring Destination Tables

Table 2-6. Routing Table for Nested Cluster 5-5-*

Linkset Name	Route DPC	Cost Value of the Route
LSB	5-5-*	10
LSC	5-5-*	20

Table 2-7. Routing Table for Full Point Code Member 5-5-1

Linkset Name	Route DPC	Cost Value of the Route
LSE	5-5-1	5
LSB	5-5-1	10
LSC	5-5-1	20

Table 2-8. Example of Nested Cluster Routing Failure and Recovery Actions

Event	Action
All linksets are up and all routes are available.	The EAGLE 5 SAS does not send a preventive TCP for cluster 5-5-* to node B because cluster 5-5-* is a nested cluster. Messages are routed to SSP 5-5-1 using linkset LSE and to cluster 5-5-* using linkset LSB. The EAGLE 5 SAS broadcasts TCAs concerning cluster 5-5-* to nodes SSP1, SSP 5-5-1, node A, and node B.
The linkset between node B and SSP 5-5-2 fails. Node B sends a TFP concerning SSP 5-5-2.	The EAGLE 5 SAS creates an x-list entry for point code 5-5-2 and marks it prohibited on linkset LSB. The EAGLE 5 SAS broadcasts TFPs to SSP1, SSP 5-5-1 and node A and sends response method TFP concerning point code 5-5-2. The EAGLE 5 SAS starts an RSP for SSP 5-5-2 on linkset LSB.
The linkset between node B and SSP 5-5-1 fails. Node B sends a TFP for SSP 5-5-1 to the EAGLE 5 SAS.	The EAGLE 5 SAS marks full point code 5-5-1 as prohibited on linkset LSB. The EAGLE 5 SAS routes the traffic to SSP 5-5-1 using linkset LSE. The EAGLE 5 SAS starts an RSP for SSP 5-5-1 on linkset LSB.
The linkset between node B and SSP 5-5-2 recovers, and node B sends a TFA for SSP 5-5-2 to the EAGLE 5 SAS.	The EAGLE 5 SAS removes point code 5-5-2 from the exception list. The status of linkset LSB is changed from prohibited to allowed. Traffic is routed to SSP 5-5-2 using linkset LSB. The EAGLE 5 SAS broadcasts a TFA concerning SSP 5-5-2 to SSP1, SSP 5-5-1 and node A. The EAGLE 5 SAS sends a preventive TFP concerning SSP 5-5-2 to node B.

Table 2-8. Example of Nested Cluster Routing Failure and Recovery Actions (Continued)

Event	Action
The linkset between node B and SSP 5-5-1 recovers, and node B sends a TFA concerning SSP 5-5-1 to the EAGLE 5 SAS.	The EAGLE 5 SAS marks full point code 5-5-1 as allowed on linkset LSB.
Linkset LSB fails.	<p>The EAGLE 5 SAS stops using linkset LSB to send traffic to cluster 5-5-*. Linkset LSB is marked prohibited, forced rerouting is performed, level 3 timer T11 for cluster 5-5-* is started, and starts using linkset LSC to send traffic to cluster 5-5-*</p> <p>The EAGLE 5 SAS marks cluster 5-5-* restricted on linkset LSC for all members of cluster 5-5-* except full point code 5-5-1. When level 3 timer T11 expires, a TFR response method is sent for all members of cluster 5-5-* except full point code 5-5-1.</p>
SSP1 sends an MSU with DPC=5-5-2.	The EAGLE 5 SAS responds with TFR concerning SSP 5-5-2 to SSP1. The MSU is routed on linkset LSC.
SSP1 sends an MSU with DPC=5-5-1.	The EAGLE 5 SAS routes the MSU to SSP 5-5-1 using linkset LSE.
Linkset LSB recovers.	The EAGLE 5 SAS stops using linkset LSC to send traffic to cluster 5-5-*, performs controlling rerouting on cluster 5-5-*, marks cluster 5-5-* as allowed on linkset LSB, and starts routing traffic to cluster 5-5-* using linkset LSB.
The SSP sends a routeset test (RSR) concerning SSP 5-5-2 to the EAGLE 5 SAS.	The EAGLE 5 SAS responds with a TFA concerning SSP 5-5-2.
Linkset LSC fails.	The EAGLE 5 SAS stops using linkset LSC to send traffic to cluster 5-5-* or full point code 5-5-1, and marks cluster 5-5-* and full point code 5-5-1 as prohibited on linkset LSC.
Linkset LSC recovers.	The EAGLE 5 SAS marks cluster 5-5-* and full point code 5-5-1 as allowed on linkset LSC.

Table 2-8. Example of Nested Cluster Routing Failure and Recovery Actions (Continued)

Event	Action
Linkset LSE fails.	The EAGLE 5 SAS stops using linkset LSE to send traffic to SSP-5-5-1, marks SSP 5-5-1 as prohibited on linkset LSE, performs forced rerouting, starts level 3 timer T11 concerning SSP 5-5-1, sends preventive TFP concerning SSP 5-5-1 to node B, and starts using linkset LSB to send traffic to full point code 5-5-1. The EAGLE 5 SAS marks full point code 5-5-1 as restricted on linkset LSB. When level 3 timer T11 expires, a TFR concerning SSP 5-5-1 is sent to SSP1 and node A.
SSP1 sends an MSU with the DPC 5-5-2.	The EAGLE 5 SAS routes the MSU to SSP 5-5-2 using linkset LSB.
SSP1 sends an MSU with the DPC 5-5-1.	The EAGLE 5 SAS responds with a TFR concerning SSP 5-5-1 to SSP1. The MSU is routed to SSP 5-5-1 using linkset LSB.
Linkset LSE recovers.	The EAGLE 5 SAS stops using linkset LSB to send traffic to SSP 5-5-1, performs controlling rerouting on full point code 5-5-1, marks full point code 5-5-1 as allowed on linkset LSE, and starts routing traffic to full point code 5-5-1 using linkset LSE. The EAGLE 5 SAS broadcasts a TFA for SSP 5-5-1 to SSP1, node A, and node B.

Limitations of the Nested Cluster Routing Feature

1. The EAGLE 5 SAS only supports a maximum of 200 nested cluster destinations. This limit does not apply to non-nested clusters (clusters with the `ncai` parameter set to `no`).
2. If a cluster is more restricted than a member, the EAGLE 5 SAS broadcasts the status of the least restricted member, and relies on response method for members of the cluster that do not have a full point code entry.
3. The EAGLE 5 SAS does not broadcast preventive TCPs for nested cluster destinations. Because the EAGLE 5 SAS does not send preventive TCPs when it begins routing towards a nested cluster, circular routing can occur. The EAGLE 5 SAS sends response method TFPs if it receives an MSU when there is a danger of circular routing.

Adding a Cluster Point Code

This procedure is used to add a cluster point code for the Cluster Routing and Management Diversity (CRMD) feature, and nested cluster point codes for the nested cluster routing feature to the database, using the `ent-dstn` command.

To change the attributes of an existing cluster point code, go to the “Changing the Attributes of a Cluster Point Code” procedure on page 2-161.

NOTE: Cluster entries can only be provisioned as ANSI destination point codes. Cluster entries cannot be provisioned for ITU international or ITU national destination point codes. The ANSI alias point code for an ITU international or ITU national destination point code must be a full point code. An ANSI private point code must be a full point code.

To remove a cluster point code from the database, go to the “Removing a Destination Point Code” procedure on page 2-214.

The Cluster Routing and Management Diversity feature must be turned on.

The `ent-dstn` command uses these parameters:

`:dpc/dpca` – The destination point code being added to the database.

NOTE: See “Point Code Formats” on page 2-4 for a definition of the point code types that are used on the EAGLE 5 SAS.

NOTE: Alias point codes (`aliasi/aliasn/aliasn24`) and secondary point codes (`spc/spca`) cannot be specified for a cluster point code.

`:c11i` – The Common Language Location Identifier assigned to this point code.

`:domain` – The network in which the destination entity or node exists, X.25 or SS7.

NOTE: Specifying `:domain=ss7` is the only valid entry for cluster destinations.

`:bei` – Broadcast exception indicator that indicates whether transfer-prohibited (TFP) messages will be broadcast from this node. The `bei=yes` parameter means TFPs will not be broadcast. The `bei=no` parameter means TFPs will be broadcast.

`:ipgwapc` – (ANSI networks only) IP Gateway Adjacent Point Code indicator. Specify `ipgwapc=yes` to provide SS7 linkset definition compatibility for gateway connections to IP-SCPs. The default is `ipgwapc=no`.

`:elei` – For cluster point codes only. Specifies whether or not the EAGLE 5 SAS maintains a dynamic status exception list for each cluster route that may be used to reach the member signaling points making up the cluster. The `elei=yes` parameter means the EAGLE 5 SAS does not maintain an exception list for the cluster point code specified by the `dpc` parameter. The `elei=no` parameter means the EAGLE 5 SAS does maintain an exception list for the cluster point code specified by the `dpc` parameter. The default value for the `elei` parameter is `no`.

Configuring Destination Tables

:ncai – The nested-cluster-allowed indicator specifies whether or not the route to the cluster point code can be different from the route to a point code that is a member of the cluster point code. A point code is a member of a cluster point code if it has the same network identifier (NI) and network cluster (NC) values as the cluster point code. This parameter can be specified only for cluster point codes.

If the **ncai** parameter value is **yes**, the cluster point code is a nested cluster point code. Point codes that are members of this cluster point code can be assigned to routesets that are different from the routeset assigned to the cluster point code.

If the **ncai** parameter value is **no**, the cluster point code is not a nested cluster point code. Point codes that are members of this cluster point code must be assigned to the same routeset assigned to the cluster point code.

The default value for the **ncai** parameter is **no**.

See the “Nested Cluster Routing” section on page 2-135 for more information on the nested cluster routing feature.

To add a cluster point code to the database, the Cluster Routing and Management Diversity feature must be on. The **ncai** parameter can be specified for the cluster point code only if both the Cluster Routing and Management Diversity and nested cluster routing features are on. This is shown by the entries **CRMD = on** (for the Cluster Routing and Management Diversity feature) and **NCR = on** (for the nested cluster routing feature) in the **rtrv-feat** command output.

The domain of the cluster point code must be SS7 (**domain=ss7**).

To enter an ANSI point code, an ANSI self ID for the EAGLE 5 SAS must be defined. This can be verified with the **rtrv-sid** command. The ANSI self ID is shown in the **PCA** field in the **rtrv-sid** command output. If no values are shown in the **PCA** field of the **rtrv-sid** command output, go to “Changing the Self-Identification of the EAGLE 5 SAS” procedure on page 2-90 to add the ANSI Self ID of the EAGLE 5 SAS.

The actual number of destination point codes that can be configured in the database is set by the **mtpdpcq** parameter of the **chg-stpopts** command, and is shown in the **MTPDPCQ** field in the **rtrv-stpopts** command output. See step 10 in the procedure that follows.

If the 5000 Routes feature is not on, and 6000, 7000, or 8000 routesets are not enabled, the sum of the **mtpdpcq** and **mtpxlq** parameters cannot exceed 2500. The range of values for the **mtpdpcq** and **mtpxlq** parameters is 500 to 2000.

If the 5000 Routes feature is on, the sum of the **mtpdpcq** and **mtpxlq** parameters cannot exceed 5500. The range of values for the **mtpdpcq** and **mtpxlq** parameters is 500 to 5000.

If 6000 routesets are enabled, the sum of the **mtpdpcq** and **mtpxlq** parameters cannot exceed 6500. The range of values for the **mtpdpcq** and **mtpxlq** parameters is 500 to 6000.

If 7000 routesets are enabled, the sum of the `mtpdpcq` and `mtpxlq` parameters cannot exceed 7500. The range of values for the `mtpdpcq` parameter is 500 to 7000. The range of values for the `mtpxlq` parameter is 500 to 6000.

If 8000 routesets are enabled, the sum of the `mtpdpcq` and `mtpxlq` parameters cannot exceed 8500. The range of values for the `mtpdpcq` parameter is 500 to 8000. The range of values for the `mtpxlq` parameter is 500 to 6000.

NOTE: For more information on the destination point code quantities, go to the “Changing the DPC Quantity” procedure on page 2-23.

If the `ncai` parameter value is `yes`, the EAGLE 5 SAS can have a maximum of 200 nested cluster point codes in the database.

The value of the `clli` parameter cannot be in the DPC table and cannot match the CLLI of the EAGLE 5 SAS. Verify this by entering the `rtrv-dstn` and the `rtrv-sid` commands, shown in steps 3 and 4 of the procedure. If the value of the `clli` parameter matches any CLLI values in either of these outputs, choose another value for the `clli` parameter that does not match any CLLIs shown in either of these command outputs.

If the `PCTYPE` field of the `rtrv-sid` command output contains the entry `ANSI`, and the network value of the destination point codes specified by the `ent-dstn` command, is from 0 to 5, the cluster value of that point code must be from 1 to 255. If the network value of that point code is from 6 to 255, the cluster value of that point code must be from 0 to 255.

To add a cluster point code to the database when the database contains point codes that are members of the cluster, the linkset type used by the routes to the member point codes must be either B, C, or D. For example, you wish to add the cluster point code 004-004-* and the database contains point codes 004-004-001 and 004-004-002. When cluster point code is added, point codes 004-004-001 and 004-004-002 would become members of the cluster point code 004-004-*. If point codes 004-004-001 or 004-004-002 are the destination point codes of routes, and the linkset type of these routes are either A or E, the cluster point code 004-004-* cannot be added to the database. The linkset type of these routes must be changed to either B, C, or D to add cluster point code 004-004-* to the database. To change the linkset type of a linkset, perform the “Changing an SS7 Linkset” procedure on page 3-74.

The examples in this procedure are used to enter the cluster point code 111-011-* and the nested cluster point code 030-045-*.

Canceling the RTRV-DSTN Command

Because the `rtrv-dstn` command used in this procedure can output information for a long period of time, the `rtrv-dstn` command can be canceled and the output to the terminal stopped. There are three ways that the `rtrv-dstn` command can be canceled:

Configuring Destination Tables

- Press the **F9** function key on the keyboard at the terminal where the **rtrv-dstn** command was entered.
- Enter the **canc-cmd** without the **trm** parameter at the terminal where the **rtrv-dstn** command was entered.
- Enter the **canc-cmd:trm=<xx>**, where **<xx>** is the terminal where the **rtrv-dstn** command was entered, from another terminal other than the terminal where the **rtrv-dstn** command was entered. To enter the **canc-cmd:trm=<xx>** command, the terminal must allow Security Administration commands to be entered from it and the user must be allowed to enter Security Administration commands. The terminal's permissions can be verified with the **rtrv-secu-trm** command. The user's permissions can be verified with the **rtrv-user** or **rtrv-secu-user** commands.

For more information about the **canc-cmd** command, refer to the *Commands Manual*.

Procedure

1. Display the current destination point codes in the database, using the **rtrv-dstn** command. This is an example of the possible output.

```
rlghncxa03w 05-09-17 16:02:05 GMT EAGLE5 34.0.0
DPCA        CLLI        BEI  ELEI  ALIASI  ALIASN  DOMAIN
020-002-045 rlghncbb100 no  ---  -----  -----  SS7
020-002-050 rlghncbb100 no  ---  -----  -----  SS7
030-045-001 -----  yes  ---  -----  -----  SS7
111-011-001 -----  yes  ---  -----  -----  SS7
240-012-004 rlghncbb001 yes  ---  -----  -----  X25
240-012-005 rlghncbb002 yes  ---  1-112-2  11112  SS7
240-012-006 rlghncbb003 yes  ---  1-112-3  11113  SS7
240-012-008 -----  yes  ---  -----  -----  X25

DPCI        CLLI        BEI  ELEI  ALIASA  ALIASN  DOMAIN
2-131-1     rlghncbb023 no  ---  222-210-000  12001  SS7
2-131-2     -----  no  ---  222-211-001  12002  SS7

DPCN        CLLI        BEI  ELEI  ALIASA  ALIASI  DOMAIN
11211      rlghncbb013 no  ---  222-200-200  2-121-1  SS7
11212      rlghncbb013 no  ---  222-200-201  2-121-2  SS7

DPCN24     CLLI        BEI  ELEI  ALIASA  ALIASI  DOMAIN

DESTINATION ENTRIES ALLOCATED:  2000
  FULL DPC(s) :                   12
  NETWORK DPC(s) :                  0
  CLUSTER DPC(s) :                  0
  TOTAL DPC(s) :                   12
  CAPACITY (% FULL) :               1%
ALIASES ALLOCATED:                8000
  ALIASES USED:                    12
  CAPACITY (% FULL) :               1%
X-LIST ENTRIES ALLOCATED:         500
RTRV-DSTN: MASP A - COMPLTD
```

If the addition of the cluster point code will not exceed the current DPC capacity shown in the `rtrv-dstn` output, go to step 2.

If the addition of the cluster point code will exceed the current DPC capacity, and the current capacity is less than 8000 (or 8500 if the `DESTINATION ENTRIES ALLOCATED` and `X-LIST ENTRIES ALLOCATED` fields are shown in the `rtrv-dstn` output), perform the “Changing the DPC Quantity” procedure on page 2-23 to change the DPC quantity. Then go to step 2.

If the addition of the cluster point code will exceed the current DPC capacity, and the current capacity is 8000 (or 8500 if the `DESTINATION ENTRIES ALLOCATED` and `X-LIST ENTRIES ALLOCATED` fields are shown in the `rtrv-dstn` output), perform the “Removing a Destination Point Code” procedure on page 2-214 to remove a DPC. Then go to step 2.

NOTE: If the `rtrv-dstn` output in step 1 shows any cluster point codes, and nested cluster point codes are not being configured in this procedure, skip this step and go to step 3.

NOTE: If cluster point codes are not shown in the `rtrv-dstn` output in step 1, but ANSI point codes are shown in step 1, skip this step and go to step 3.

2. Display the self-identification of the EAGLE 5 SAS using the `rtrv-sid` command. This is an example of the possible output.

```

rlghncxa03w 05-09-10 11:43:04 GMT EAGLE5 34.0.0
PCA          PCI          PCN          CLLI          PCTYPE
010-020-030  0-123-1          12-0-14-1    rlghncxa03w   OTHER

CPCA
002-002-002    002-002-003    002-002-004    002-002-005
002-002-006    002-002-007    002-002-008    002-002-009
004-002-001    004-003-003    050-060-070

CPCI
1-001-1        1-001-2        1-001-3        1-001-4
1-002-1        1-002-2        1-002-3        1-002-4
2-001-1        7-222-7

CPCN
2-0-10-3       2-0-11-0       2-0-11-2       2-0-12-1
2-2-3-3        2-2-4-0        10-14-10-1
    
```

If the PCA field does not contain an entry, perform the “Changing the Self-Identification of the EAGLE 5 SAS” procedure on page 2-90 and add an ANSI point code to the self identification of the EAGLE 5 SAS.

NOTE: If the **DESTINATION ENTRIES ALLOCATED** and **X-LIST ENTRIES ALLOCATED** fields are shown in the `rtrv-dstn` output in step 1, and nested cluster point codes are not being configured in this procedure, skip this step and steps 4 and 5, and go to step 6.

3. Verify that the Cluster Routing and Management Diversity feature is turned on, by entering the `rtrv-feat` command. If nested cluster point codes are to be configured in the database, the nested cluster routing feature must be turned on. If the Cluster Routing and Management Diversity feature is turned on, the **CRMD** field should be set to **on**. If the nested cluster routing feature is turned on, the **NCR** field should be set to **on**. In this example, both features are off.

NOTE: The `rtrv-feat` command output contains other fields that are not used by this procedure. If you wish to see all the fields displayed by the `rtrv-feat` command, see the `rtrv-feat` command description in the *Commands Manual*.

NOTE: If the Cluster Routing and Management Diversity feature is on, shown by the **CRMD = on** entry in the `rtrv-feat` command output in step 3, skip step 4 and go to step 5.

4. Turn the Cluster Routing and Management Diversity feature on by entering this command.

```
chg-feat:crmd=on
```

NOTE: Once the Cluster Routing and Management Diversity feature is turned on with the `chg-feat` command, it cannot be turned off.

The Cluster Routing and Management Diversity feature must be purchased before you turn this feature on with the `chg-feat` command. If you are not sure if you have purchased the Cluster Routing and Management Diversity feature, contact your Tekelec Sales Representative or Account Representative.

When this command has successfully completed, this message should appear.

```
rlghncxa03w 05-09-10 11:43:04 GMT EAGLE5 34.0.0  
CHG-FEAT: MASP A - COMPLTD
```

NOTE: If nested cluster point codes are being added to the database or the `ncal` parameter is specified for the cluster point code and the nested cluster routing feature is on, shown by the `NCR = on` entry in the `rtrv-feat` command output in step 3, skip step 5 and go to step 6.

- Turn the nested cluster routing feature on by entering this command.

```
chg-feat:ncr=on
```

NOTE: Once the nested cluster routing feature is turned on with the `chg-feat` command, it cannot be turned off.

The nested cluster routing feature must be purchased before you turn this feature on with the `chg-feat` command. If you are not sure if you have purchased the nested cluster routing feature, contact your Tekelec Sales Representative or Account Representative.

When this command has successfully completed, this message should appear.

```
rlghncxa03w 05-09-10 11:43:04 GMT EAGLE5 34.0.0
CHG-FEAT: MASP A - COMPLTD
```

- Display the current destination point codes in the database, using the `rtrv-dstn` command. This is an example of the possible output.

```
rlghncxa03w 05-09-17 16:02:05 GMT EAGLE5 34.0.0
  DPCA          CLLI          BEI  ELEI  ALIASI          ALIASN/N24  DOMAIN
  020-002-045   rlghncbb100 no   ---  -----  -----  SS7
  020-002-050   rlghncbb100 no   ---  -----  -----  SS7
  030-045-001   -----  yes  ---  -----  -----  SS7
  111-011-001   -----  yes  ---  -----  -----  SS7
  240-012-004   rlghncbb001 yes  ---  -----  -----  X25
  240-012-005   rlghncbb002 yes  ---  1-112-2   11112     SS7
  240-012-006   rlghncbb003 yes  ---  1-112-3   11113     SS7
  240-012-008   -----  yes  ---  -----  -----  X25

  DPCI          CLLI          BEI  ELEI  ALIASA          ALIASN/N24  DOMAIN
  2-131-1       rlghncbb023 no   ---  222-210-000 12001     SS7
  2-131-2       -----  no   ---  222-211-001 12002     SS7

  DPCN          CLLI          BEI  ELEI  ALIASA          ALIASI       DOMAIN
  11211         rlghncbb013 no   ---  222-200-200 2-121-1    SS7
  11212         rlghncbb013 no   ---  222-200-201 2-121-2    SS7

  DPCN24        CLLI          BEI  ELEI  ALIASA          ALIASI       DOMAIN

DESTINATION ENTRIES ALLOCATED: 2000
  FULL DPC(s) : 12
  NETWORK DPC(s) : 0
  CLUSTER DPC(s) : 0
  TOTAL DPC(s) : 12
  CAPACITY (% FULL) : 1%
X-LIST ENTRIES ALLOCATED: 500
```

NOTE: If the `rtrv-dstn` output does not show any DPCs that are members of the cluster point code being added in this procedure, skip steps 5 through 6, and go to step 7.

- The cluster point code cannot be added to the database if the database contains member point codes assigned to routes that are assigned to linksets whose linkset type is either A or E.

Enter the `rtrv-rte` command with one of the DPCs that is a member of the cluster point code being added in this procedure. For this example, enter these commands.

```
rtrv-rte:dpca=111-011-001
```

This is an example of the possible output.

```
rlghncxa03w 05-09-17 15:35:05 GMT EAGLE5 34.0.0
DPCA          ALIASI          ALIASN/N24      LSN            RC      APCA
111-011-001   -----          -----          lsn2           10     111-011-001
CLLI=-----
```

```
rtrv-rte:dpca=030-045-001
```

This is an example of the possible output.

```
rlghncxa03w 05-09-17 15:35:05 GMT EAGLE5 34.0.0
DPCA          ALIASI          ALIASN/N24      LSN            RC      APCA
030-045-001   -----          -----          lsn3           10     030-045-001
CLLI=-----
```

If the DPC specified in this step is the DPC of a route, go to step 6.

If the DPC specified in this step is not the DPC of a route, repeat this step for other DPCs, shown in the `rtrv-dstn` output, that are members of the cluster point code being added in this procedure.

If all the DPCs that are members of the cluster point code being added have been displayed, and none of these DPCs are DPCs of routes, skip step 6 and go to step 7.

- Enter the `rtrv-ls` command with the linkset name shown in the `rtrv-rte` output in step 5. The linkset name is shown in the `LSN` column of the `rtrv-rte` output. For this example, enter these commands.

```
rtrv-ls:lsn=lsn2
```

This is an example of the possible output.

```
rlghncxa03w 05-09-17 15:35:05 GMT EAGLE5 34.0.0

LSN          APCA  (SS7)  SCRN  SET  SET  BEI  LST  LNKS  ACT  MES  DIS  SLSCI  NIS
lsn2         111-011-001  none  1    1    no  B    2    off  off  off  no    off

CLLI          TFATCABMLQ  MTRPSE  ASL8  IPGWAPC
-----          1          ---    no    no
```

Configuring Destination Tables

```

          L2T          L1          PCR PCR
LOC LINK SLC TYPE SET BPS MODE TSET ECM N1 N2
1103 A 0 LIMDS0 1 56000 --- --- BASIC --- -----
1104 A 1 LIMDS0 1 56000 --- --- BASIC --- -----

          LP          ATM
LOC LINK SLC TYPE SET BPS TSEL VCI VPI LL

          LP          ATM          E1ATM
LOC LINK SLC TYPE SET BPS TSEL VCI VPI CRC4 SI SN

LOC LINK SLC TYPE IPLIML2

LOC LINK SLC TYPE

          L2T          PCR PCR E1 E1
LOC LINK SLC TYPE SET BPS ECM N1 N2 LOC PORT TS

          L2T          PCR PCR T1 T1
LOC LINK SLC TYPE SET BPS ECM N1 N2 LOC PORT TS

```

Link set table is (6 of 1024) 1% full.

rtrv-ls:lsn=lsn3

This is an example of the possible output.

rlghncxa03w 05-09-17 15:35:05 GMT EAGLE5 34.0.0

```

          L3T SLT          GWS GWS GWS
LSN      APCA (SS7) SCRN SET SET BEI LST LNKS ACT MES DIS SLSCI NIS
lsn3     030-045-001 none 1 1 no B 2 off off off no off

          CLLI          TFATCABMLQ MTPRSE ASL8 IPGWAPC
          ----- 1 --- no no

          L2T          L1          PCR PCR
LOC LINK SLC TYPE SET BPS MODE TSET ECM N1 N2
1103 B 0 LIMDS0 1 56000 --- --- BASIC --- -----
1104 B 1 LIMDS0 1 56000 --- --- BASIC --- -----

          LP          ATM
LOC LINK SLC TYPE SET BPS TSEL VCI VPI LL

          LP          ATM          E1ATM
LOC LINK SLC TYPE SET BPS TSEL VCI VPI CRC4 SI SN

LOC LINK SLC TYPE IPLIML2

LOC LINK SLC TYPE

          L2T          PCR PCR E1 E1
LOC LINK SLC TYPE SET BPS ECM N1 N2 LOC PORT TS

          L2T          PCR PCR T1 T1
LOC LINK SLC TYPE SET BPS ECM N1 N2 LOC PORT TS

```

Link set table is (6 of 1024) 1% full.

If the linkset type of the linkset is either A or E, go to the “Changing an SS7 Linkset” procedure on page 3-74 and change the linkset type to B, C, or D.

Configuring Destination Tables

If the linkset type is B, C, or D, go to step 7.

If all the DPCs that are members of the cluster point code being added have not been displayed in step 5, repeat steps 5 and 6.

If all the DPCs that are members of the cluster point code being added have been displayed, go to step 7.

-
9. Add the cluster point code to the database, by using the **ent-dstn** command. For this example, enter these commands.

```
ent-dstn:dpca=111-011-*:clli=rlghncbb000:bei=yes:elei=yes
:domain=ss7
```

```
ent-dstn:dpca=030-045-*:clli=rlghncbb010:bei=yes:elei=yes
:domain=ss7:ncai=yes
```

When these commands have successfully completed, this message should appear.

```
rlghncxa03w 05-09-17 15:35:05 GMT EAGLE5 34.0.0
DESTINATION ENTRIES ALLOCATED: 2000
  FULL DPC(s): 12
  NETWORK DPC(s): 0
  CLUSTER DPC(s): 2
  TOTAL DPC(s): 14
  CAPACITY (% FULL): 1%
ALIASES ALLOCATED: 8000
  ALIASES USED: 12
  CAPACITY (% FULL): 1%
X-LIST ENTRIES ALLOCATED: 500
ENT-DSTN: MASP A - COMPLTD
```

-
10. Verify the changes using the **rtrv-dstn** command and specifying the DPC that was entered in step 9. For this example, enter these commands.

```
rtrv-dstn:dpca=111-011-*
```

This is an example of the possible output.

```
rlghncxa03w 05-09-28 21:16:37 GMT EAGLE5 34.0.0
  DPCA          CLLI          BEI ELEI  ALIASI          ALIASN/N24  DOMAIN
  111-011-*     rlghncbb000 yes yes  -----     -----     SS7

                SPC          NCAI
                -----     no

DESTINATION ENTRIES ALLOCATED: 2000
  FULL DPC(s): 12
  NETWORK DPC(s): 0
  CLUSTER DPC(s): 2
  TOTAL DPC(s): 14
  CAPACITY (% FULL): 1%
ALIASES ALLOCATED: 8000
  ALIASES USED: 12
  CAPACITY (% FULL): 1%
X-LIST ENTRIES ALLOCATED: 500
RTRV-DSTN: MASP A - COMPLTD
```

rtrv-dstn:dpca=030-045-*

This is an example of the possible output.

```

rlghncxa03w 05-09-28 21:16:37 GMT EAGLE5 34.0.0
  DPCA          CLLI          BEI  ELEI  ALIASI          ALIASN/N24  DOMAIN
  030-045-*    rlghncbb010 yes yes -----
                                     -----
                                     SPC          NCAI
                                     ----- yes
DESTINATION ENTRIES ALLOCATED:  2000
  FULL DPC(s) :                12
  NETWORK DPC(s) :              0
  CLUSTER DPC(s) :              2
  TOTAL DPC(s) :                14
  CAPACITY (% FULL) :           1%
ALIASES ALLOCATED:              8000
  ALIASES USED:                 12
  CAPACITY (% FULL) :           1%
X-LIST ENTRIES ALLOCATED:       500
RTRV-DSTN: MASP A - COMPLTD

```

NOTE: If you do not wish to change the exception list parameters for the Cluster Routing and Management Diversity feature, skip steps 11, 12, and 13, and go to step 14.

11. The parameters for the exception list for the Cluster Routing and Management Diversity feature can be changed from the default settings by using the **chg-stpopts** command. The parameters of the **chg-stpopts** command that control the exception point-code list are:

mtpxlq = the maximum number of entries the exception list (x-list) can contain

mtpxlet = the maximum amount of time the EAGLE 5 SAS will maintain an unreferenced exception list (x-list) entry, expressed in the format **hhmm**, where **hh** is the number of hours, and **mm** is the number of minutes

mtpxlot = the exception list (x-list) occupancy threshold (in terms of percentage of space available). If this threshold is exceeded, the EAGLE 5 SAS raises a minor alarm.

mtpdpcq = the maximum number of destination point codes that can be configured on the EAGLE 5 SAS

NOTE: The sum of the **MTPDPCQ** and **MTPXLQ** value's cannot exceed one of these totals depending on the features that are enabled or turned on:

- 2500 – if the 5000 Routes feature is not on, and 6000, 7000, or 8000 routesets are not enabled. The range of values for the **mtpdpcq** and **mtpxlq** parameters is 500 to 2000.
- 5500 – if the 5000 Routes feature is on, but 6000, 7000, or 8000 routesets are not enabled. The range of values for the **mtpdpcq** and **mtpxlq** parameters is 500 to 5000.
- 6500 – if 6000 routesets are enabled. The range of values for the **mtpdpcq** and **mtpxlq** parameters is 500 to 6000.

Configuring Destination Tables

- 7500 – if 7000 routesets are enabled. The range of values for the `mtpdpcq` parameter is 500 to 7000. The range of values for the `mtpxlq` parameter is 500 to 6000.
- 8500 – if 8000 routesets are enabled. The range of values for the `mtpdpcq` parameter is 500 to 8000. The range of values for the `mtpxlq` parameter is 500 to 6000.

Display the existing values for the exception list parameters, by entering the `rtrv-stpopts` command. This is an example of the possible output.

```
rlghncxa03w 05-09-17 16:02:05 GMT EAGLE5 34.0.0
STP OPTIONS
-----
MTPXLQ           500
MTPXLET          0100
MTPXLOT           90%
MTPDPCQ          2000
```

NOTE: The `rtrv-stpopts` command output contains other fields that are not used by this procedure. If you wish to see all the fields displayed by the `rtrv-stpopts` command, see the `rtrv-stpopts` command description in the *Commands Manual*.

NOTE: If the Cluster Routing and Management Diversity was turned on in this procedure, the `MTPXLQ`, `MTPXLET`, and `MTPXLOT` parameters are shown with these default values:

- `MTPXLQ` – 500
- `MTPXLET` – 0100
- `MTPXLOT` – 90%

The `MTPDPCQ` value is not changed when the Cluster Routing and Management Diversity is turned on.

NOTE: If you do not wish to change the DPC quantity, or the exception list parameters for the Cluster Routing and Management Diversity feature, skip steps 12 and 13, and go to step 14.

12. If you wish to change the exception list parameters or the `mtpdpcq` value, enter the `chg-stpopts` command.

NOTE: If the DPC quantity or the exception list quantity is being changed in this step, both the `mtpdpcq` and `mtpxlq` parameters do have to be specified in this step unless the resulting sum of the `mtpdpcq` and `mtpxlq` parameters would exceed the totals shown in step 10.

NOTE: For example, the current `mtpdpcq` value is 4000 and the current `mtpxlq` value is 1500, resulting in a sum of 5500, and only the 5000 Routes feature is on. To change either value, both parameters must be specified and the sum of the new values cannot exceed 5500. If in this example, the current `mtpdpcq` value is 3000 and the current `mtpxlq` value is 1500, resulting in a sum of 4500, either parameter value can be changed without specifying the other parameter as long as the sum of the values does not exceed 5500.

For this example, change the DPC quantity value to 1750, the exception list size to 750, the exception list timer to 1 hour and 30 minutes (90 minutes), and the exception list occupancy threshold to 75%. Enter this command.

```
chg-stpopts:mtpdpcq=1750:mtpxlq=750:mtpxlet=0130:mtpxlot=75
```

When this command has successfully completed, this message should appear.

```
rlghncxa03w 05-09-17 15:35:05 GMT EAGLE5 34.0.0
CHG-STPOPTS: MASP A - COMPLTD
```

13. Verify the changes using the `rtrv-stpopts` command. This is an example of the possible output.

```
rlghncxa03w 05-09-17 16:02:05 GMT EAGLE5 34.0.0
STP OPTIONS
-----
MTPXLQ           750
MTPXLET          0130
MTPXLOT           75%
MTPDPCQ          1750
```

NOTE: The `rtrv-stpopts` command output contains other fields that are not used by this procedure. If you wish to see all the fields displayed by the `rtrv-stpopts` command, see the `rtrv-stpopts` command description in the *Commands Manual*.

14. Back up the new changes, using the `chg-db:action=backup:dest=fixed` command. These messages should appear; the active Maintenance and Administration Subsystem Processor (MASP) appears first.

```
BACKUP (FIXED) : MASP A - Backup starts on active MASP.
BACKUP (FIXED) : MASP A - Backup on active MASP to fixed disk complete.
BACKUP (FIXED) : MASP A - Backup starts on standby MASP.
BACKUP (FIXED) : MASP A - Backup on standby MASP to fixed disk complete.
```

Flowchart 2-8. Adding a Cluster Point Code (Sheet 1 of 6)

NOTE: Before executing this procedure, make sure you have purchased the Cluster Routing and Management Diversity feature and the nested cluster routing feature. If you are not sure if you have purchased the Cluster Routing and Management Diversity feature and the nested cluster routing feature, contact your Tekelec Sales Representative or Account Representative.

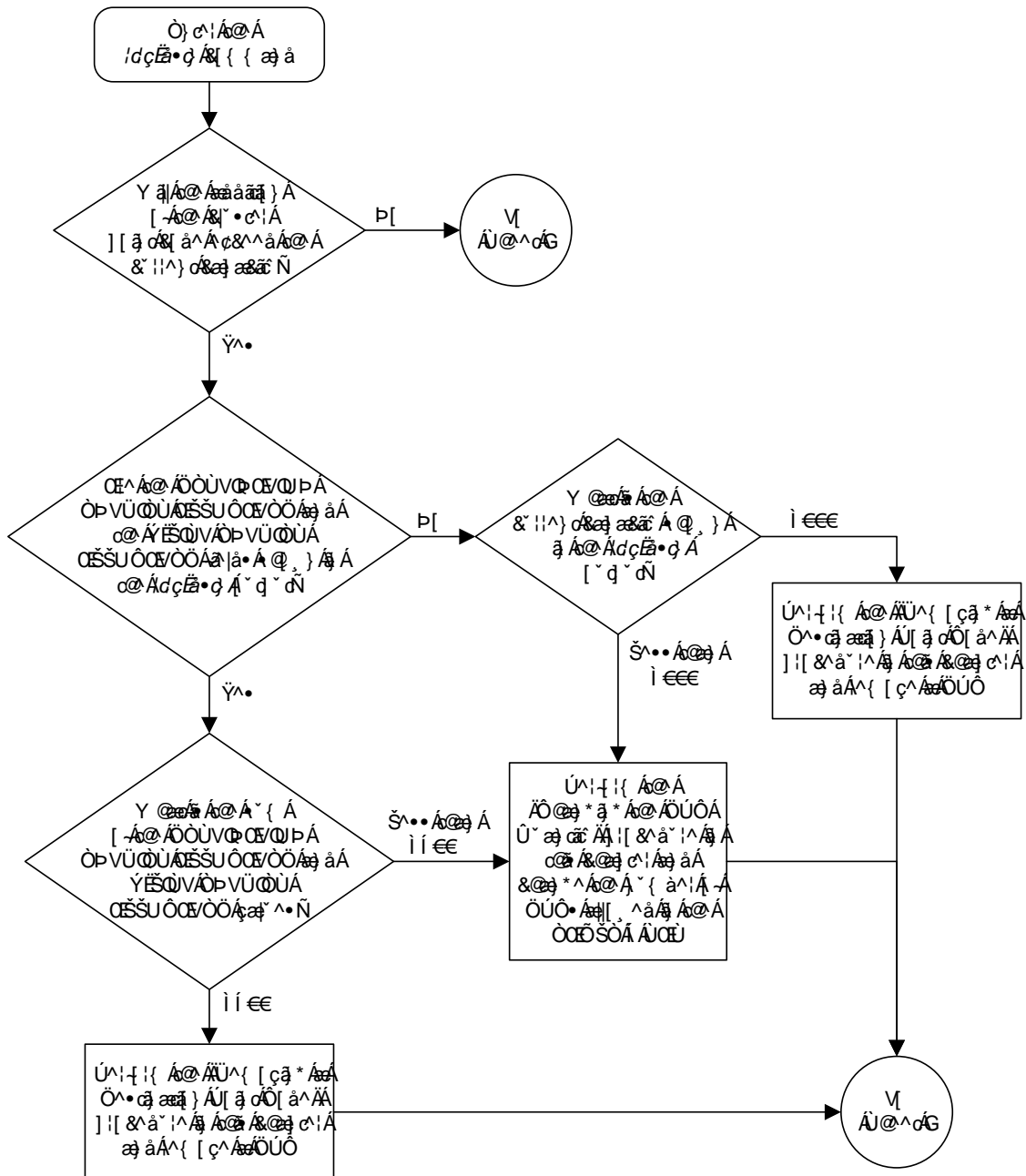

Flowchart 2-8. Adding a Cluster Point Code (Sheet 2 of 6)

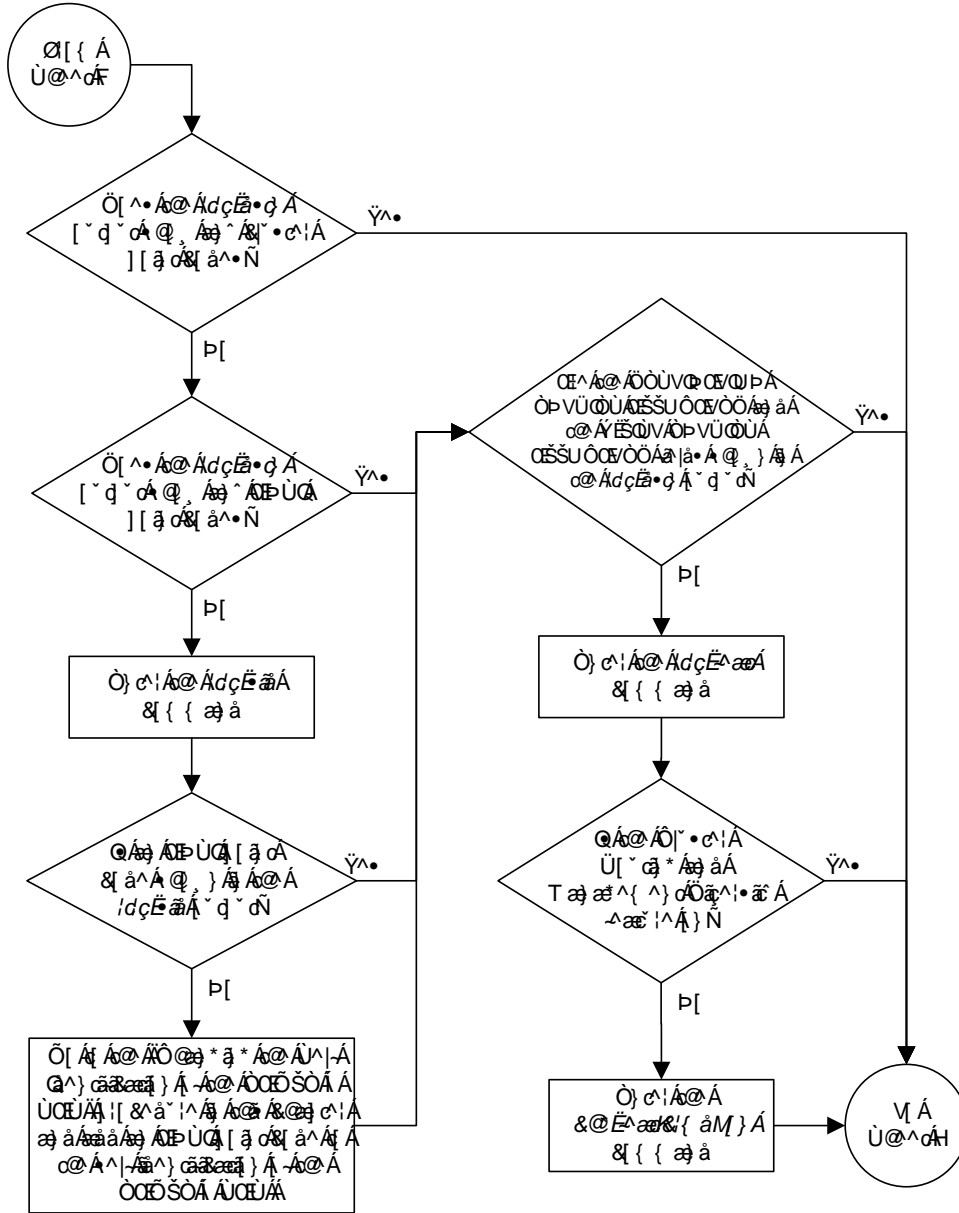

Flowchart 2-8. Adding a Cluster Point Code (Sheet 3 of 6)

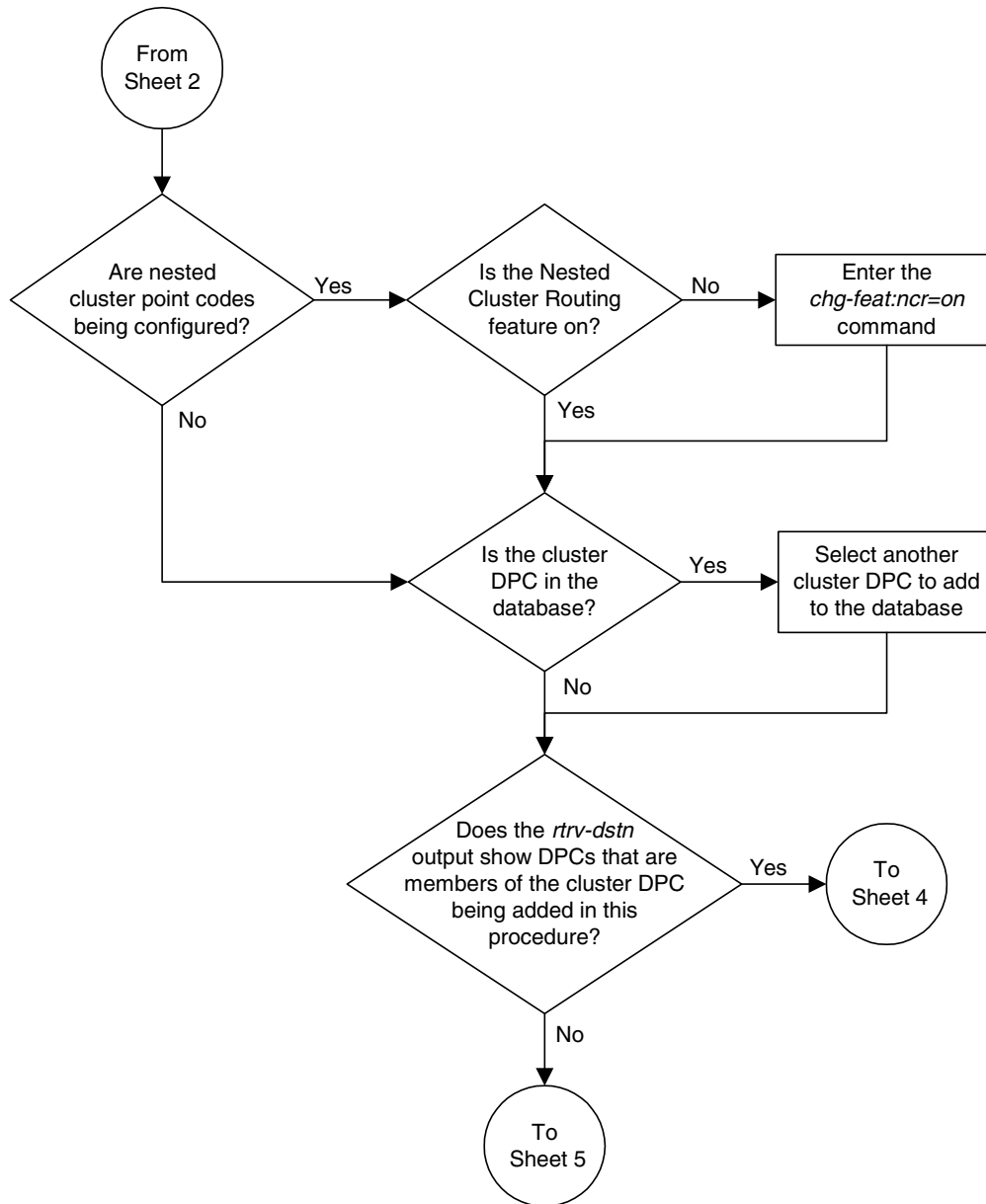

Flowchart 2-8. Adding a Cluster Point Code (Sheet 4 of 6)

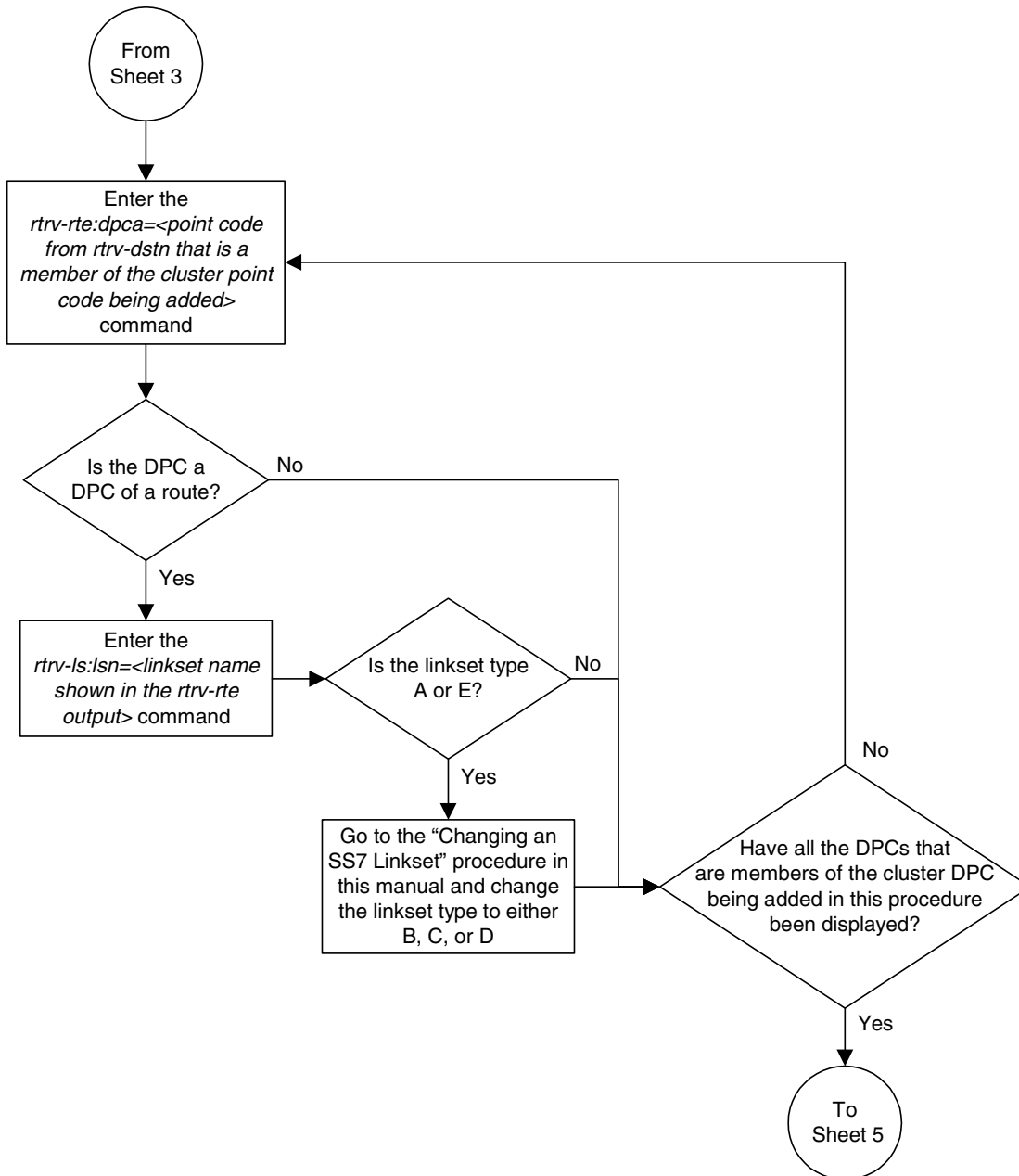

Flowchart 2-8. Adding a Cluster Point Code (Sheet 6 of 6)

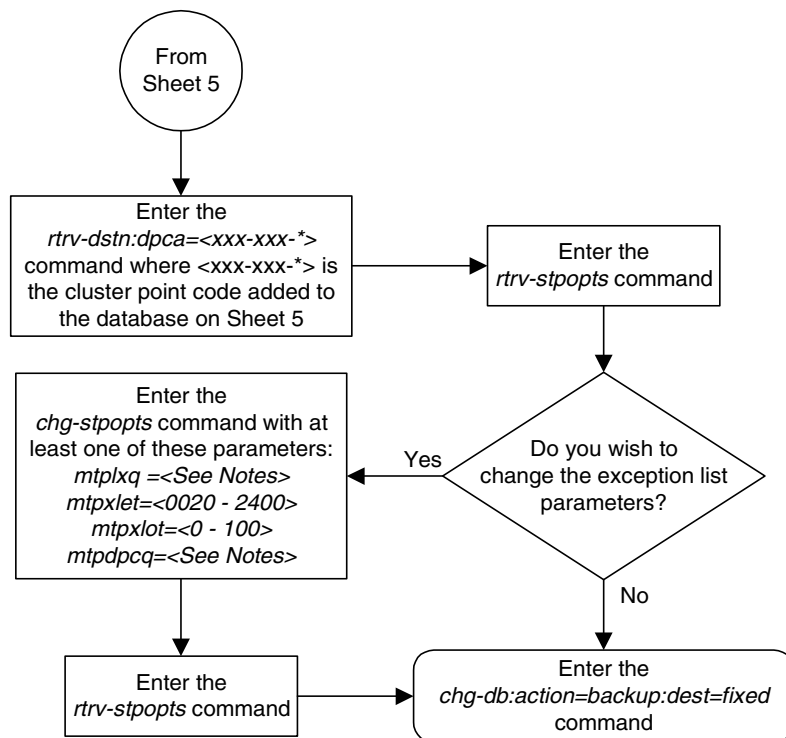

Notes:

- The sum of the values for the *mtpdpcq* and *mtpxlq* parameters cannot exceed these values, depending which routeset quantity has been enabled with the *enable-ctrl-feat* command, or turned on with the *chg-feat* command:
 - 5000 routes not turned on, 6000, 7000, or 8000 routesets not enabled - **2500**. The range of values for the *mtpdpcq* and *mtpxlq* parameters is 500 to 2000.
 - 5000 routes turned on, 6000, 7000, or 8000 routesets not enabled - **5500**. The range of values for the *mtpdpcq* and *mtpxlq* parameters is 500 to 5000.
 - 6000 routesets enabled - **6500**. The range of values for the *mtpdpcq* and *mtpxlq* parameters is 500 to 6000.
 - 7000 routesets enabled - **7500**. The range of values for the *mtpdpcq* parameter is 500 to 7000. The range of values for the *mtpxlq* parameter is 500 to 6000.
 - 8000 routesets enabled - **8500**. The range of values for the *mtpdpcq* parameter is 500 to 8000. The range of values for the *mtpxlq* parameter is 500 to 6000.
- If the DPC quantity or the exception list quantity is being changed in this step, both the *mtpdpcq* and *mtpxlq* parameters do have to be specified in this step unless the resulting sum of the *mtpdpcq* and *mtpxlq* parameters would exceed the totals shown in Note 1. For example, the current *mtpdpcq* value is 4000 and the current *mtpxlq* value is 1500, resulting in a sum of 5500, and only the 5000 Routes feature is on. To increase either value, both parameters must be specified and the sum of the new values cannot exceed 5500. If either value is being decreased, the other parameter can be specified as long as the sum of the values does not exceed 5500. If in this example, the current *mtpdpcq* value is 3000 and the current *mtpxlq* value is 1500, resulting in a sum of 4500, either parameter value can be changed without specifying the other parameter as long as the sum of the values does not exceed 5500.

Changing the Attributes of a Cluster Point Code

This procedure is used to change the attributes of a cluster point code in the database, using the **chg-dstn** command.

NOTE: Cluster entries can be provisioned only as ANSI destination point codes. Cluster entries cannot be provisioned for ITU international or ITU national destination point codes. The ANSI alias point code for an ITU international or ITU national destination point code must be a full point code. An ANSI private point code must be a full point code.

To add a new cluster point code to the database, go to the “Adding a Cluster Point Code” procedure on page 2-142.

To remove a cluster point code from the database, go to the “Removing a Destination Point Code” procedure on page 2-214.

The cluster point code to be changed must be in the database.

The **chg-dstn** command uses these parameters:

:dpc/dpca – The destination point code in the database being changed

NOTE: See “Point Code Formats” on page 2-4 for a definition of the point code types that are used on the EAGLE 5 SAS.

NOTE: Alias point codes (aliasi/aliasn/aliasn24) and secondary point codes (spc/spca) cannot be specified for a cluster point code.

:c11i – The Common Language Location Identifier assigned to this point code

:domain – The network in which the destination entity or node exists X.25 or SS7

NOTE: Specifying :domain=x25 is valid only for ANSI destinations, but cannot be specified for cluster point codes.

:bei – Broadcast exception indicator that indicates whether transfer-prohibited (TFP) messages will be broadcast from this node. The **bei=yes** parameter means TFPs will not be broadcast. The **bei=no** parameter means TFPs will be broadcast.

:ipgwapc – (ANSI networks only) IP Gateway Adjacent Point Code indicator. Specify **ipgwapc=yes** to provide SS7 linkset definition compatibility for gateway connections to IP-SCPs. The default is **ipgwapc=no**.

:elei – For cluster point codes only. Specifies whether or not the EAGLE 5 SAS maintains a dynamic status exception list for each cluster route that may be used to reach the member signaling points making up the cluster. The **elei=yes** parameter means the EAGLE 5 SAS does not maintain an exception list for the cluster point code specified by the **dpc** parameter. The **elei=no** parameter means the EAGLE 5 SAS does maintain an exception list for the cluster point code specified by the **dpc** parameter.

:ncai – The nested-cluster-allowed indicator specifies whether or not the route to the cluster point code can be different from the route to a point code that is a member of the cluster point code. A point code is a member of a cluster point code if it has the same network identifier (NI) and network cluster (NC) values as the cluster point code. This parameter can be specified only for cluster point codes.

If the **ncai** parameter value is **yes**, the cluster point code is a nested cluster point code. Point codes that are members of this cluster point code can be assigned to routesets that are different from the routeset assigned to the cluster point code.

If the **ncai** parameter value is **no**, the cluster point code is not a nested cluster point code. Point codes that are members of this cluster point code must be assigned to the same routeset assigned to the cluster point code.

See the “Nested Cluster Routing” section on page 2-135 for more information on the nested cluster routing feature.

The value of the **c11i** parameter cannot be in the DPC table and cannot match the CLLI of the EAGLE 5 SAS. Verify this by entering the **rtrv-dstn** and the **rtrv-sid** commands, shown in steps 1 and 3. If the value of the **c11i** parameter matches any CLLI values in either of these outputs, choose another value for the **c11i** parameter that does not match any CLLIs shown in either of these command outputs.

If a nested cluster point code is changed to a non-nested cluster point code (the value of the **ncai** parameter is changed from **yes** to **no**), any point codes that are members of this point code must be assigned to the same routeset as the cluster point code.

If an X.25 destination point code is a member of a cluster, the value of the **bei** parameter for the X.25 destination point code is not changed to the value of the **bei** parameter of the cluster, but the value of the **bei** parameter of the cluster determines the behavior of the X.25 destination point code as long as the cluster remains in the DPC table. If this cluster is removed from the DPC table, the X.25 destination behaves as it is configured with the **ent-dstn** command. For example, if the X.25 destination point code, 002-002-002, is a member of the cluster 002-002-*, the **bei** parameter of the cluster is set to **yes**, and the **bei** parameter of the X.25 destination point code is set to **no**, the X.25 destination point code behaves as if the **bei** parameter is set to **yes**. If the cluster 002-002-* is removed from the database, the **bei** parameter of the X.25 destination point code is set to **no** and the X.25 destination point code broadcasts TFP and TFA messages to adjacent nodes.

If you intend to use this X.25 destination point code with an X.25 route that has the **1c2nm** parameter set to **yes**, make sure that the **bei** parameter of the cluster containing the X.25 destination point code is set to **no**. Verify the value of the **bei** parameter of the cluster with the **rtrv-dstn** command. To change the existing value the **bei** parameter, specify the **bei** parameter with the appropriate value (**yes** or **no**) with the **chg-dstn** command in this procedure. If the **bei** parameter

Configuring Destination Tables

is not specified with the `chg-dstn` command, the value of the `bei` parameter is not changed.

The `e1ei` (exception list exclusion indicator) parameter can be specified only for a cluster destination point code. Cluster destination point codes and the `e1ei` parameter can be specified only if the Cluster Routing and Management Diversity feature is turned on. Verify this with the `rtrv-feat` command. If the Cluster Routing and Management Diversity feature is turned on, the `CRMD` field should be set to `on`. If the Cluster Routing and Management Diversity feature is not turned on, enter the `chg-feat:crmd=on` command. For more information on the Cluster Routing and Management Diversity feature, go to the “Cluster Routing and Management Diversity (CRMD)” section on page 2-119.

The `ncai` parameter can be specified only if the Nested Cluster Routing feature is on. This can be verified with the entry `NCR = on` in the `rtrv-feat` command output. If the nested cluster routing feature is not turned on, enter the `chg-feat:ncr=on` command. For more information on the nested cluster routing feature, go to the “Nested Cluster Routing” section on page 2-135.

NOTE: Once the Cluster Routing and Management Diversity and nested cluster routing features are turned on with the `chg-feat` command, they cannot be turned off.

The Cluster Routing and Management Diversity and nested cluster routing features must be purchased before you turn these features on with the `chg-feat` command. If you are not sure if you have purchased the Cluster Routing and Management Diversity and nested cluster routing features, contact your Tekelec Sales Representative or Account Representative.

The examples in this procedure are used to change the attributes of the cluster point code 030-003-*

Canceling the `RTRV-DSTN` and `RTRV-RTE` Commands

Because the `rtrv-dstn` and `rtrv-rte` commands used in this procedure can output information for a long period of time, the `rtrv-dstn` and `rtrv-rte` commands can be canceled and the output to the terminal stopped. There are three ways that the `rtrv-dstn` and `rtrv-rte` commands can be canceled:

- Press the **F9** function key on the keyboard at the terminal where the `rtrv-dstn` or `rtrv-rte` command was entered.
- Enter the `canc-cmd` without the `trm` parameter at the terminal where the `rtrv-dstn` or `rtrv-rte` command was entered.
- Enter the `canc-cmd:trm=<xx>`, where `<xx>` is the terminal where the `rtrv-dstn` or `rtrv-rte` command was entered, from another terminal other than the terminal where the `rtrv-dstn` or `rtrv-rte` command was entered. To enter the `canc-cmd:trm=<xx>` command, the terminal must allow Security Administration commands to be entered from it and the user must be allowed to enter Security Administration commands. The terminal's permissions can

be verified with the `rtrv-secu-trm` command. The user's permissions can be verified with the `rtrv-user` or `rtrv-secu-user` commands.

For more information about the `canc-cmd` command, refer to the *Commands Manual*.

Procedure

1. Display the current destination point codes, using the `rtrv-dstn` command. This is an example of the possible output.

```

rlghncxa03w 05-09-17 16:02:05 GMT EAGLE5 34.0.0
  DPCA          CLLI          BEI  ELEI  ALIASI          ALIASN/N24  DOMAIN
  020-002-*     rlghncbb000 yes yes  -----  -----  SS7
  240-012-004   rlghncbb001 yes ---  1-111-1    10-13-9-3  SS7
  240-012-005   rlghncbb002 yes ---  1-112-2    10-13-10-0 SS7
  240-012-006   rlghncbb003 yes ---  1-112-3    10-13-10-1 SS7
  240-012-007   ----- yes ---  1-117-3    10-13-11-1 SS7
  240-012-008   ----- yes ---  1-113-5    10-13-10-2 SS7
  030-003-*     rlghncbb333 yes yes  -----  -----  SS7
  030-003-100   rlghncbb334 yes ---  1-112-3    10-13-10-1 SS7
  030-003-200   rlghncbb335 yes ---  1-117-3    10-13-11-1 SS7
  030-003-225   rlghncbb336 yes ---  -----  -----  SS7
  244-020-004   ls06clli     yes ---  -----  -----  X25
  244-020-005   ls07clli     yes ---  -----  -----  X25
  244-020-006   ls08clli     yes ---  -----  -----  X25
  244-020-007   ----- yes ---  -----  -----  X25
  244-020-008   ----- yes ---  -----  -----  X25

  DPCI          CLLI          BEI  ELEI  ALIASA          ALIASN/N24  DOMAIN
  2-131-1       rlghncbb023 no ---  222-210-000 11-11-8-1  SS7
  2-131-2       ----- no ---  222-211-001 11-11-8-2  SS7
  2-131-3       ----- no ---  222-211-002 11-11-8-3  SS7
  4-163-5       ----- no ---  250-200-007 15-11-5-1  SS7

  DPCN          CLLI          BEI  ELEI  ALIASA          ALIASI       DOMAIN
  7-9-10-1     ----- no ---  210-090-100 1-75-6     SS7
  10-15-2-3    rlghncbb013 no ---  222-200-200 2-121-1    SS7
  10-15-3-0    rlghncbb013 no ---  222-200-201 2-121-2    SS7

  DPCN24       CLLI          BEI  ELEI  ALIASA          ALIASI       DOMAIN

DESTINATION ENTRIES ALLOCATED:  2000
  FULL DPC(s) :                   20
  NETWORK DPC(s) :                  0
  CLUSTER DPC(s) :                  2
  TOTAL DPC(s) :                    22
  CAPACITY (% FULL) :                1%
ALIASES ALLOCATED:                8000
  ALIASES USED:                     28
  CAPACITY (% FULL) :                1%
X-LIST ENTRIES ALLOCATED:         500
RTRV-DSTN: MASP A - COMPLTD

```

Configuring Destination Tables

NOTE: If the **CLLI** value for the cluster point code is not being changed in this procedure, skip this step 2 and go to step 3.

2. Display the self-identification of the EAGLE 5 SAS using the **rtrv-sid** command. This is an example of the possible output.

```
rlghncxa03w 05-09-10 11:43:04 GMT EAGLE5 34.0.0
PCA          PCI          PCN          CLLI          PCTYPE
010-020-030  0-123-1        12-0-14-1    rlghncxa03w  OTHER

CPCA
002-002-002    002-002-003    002-002-004    002-002-005
002-002-006    002-002-007    002-002-008    002-002-009
004-002-001    004-003-003    050-060-070

CPCI
1-001-1        1-001-2        1-001-3        1-001-4
1-002-1        1-002-2        1-002-3        1-002-4
2-001-1        7-222-7

CPCN
2-0-10-3      2-0-11-0      2-0-11-2      2-0-12-1
2-2-3-3      2-2-4-0      10-14-10-1
```

If the **CLLI** value for the cluster point code is being changed in this procedure, that **CLLI** value cannot be shown in the **CLLI** fields of either the **rtrv-dstn** (step 1) or the **rtrv-sid** (step 2) command outputs.

NOTE: If the **NCAI** value is not being changed in this procedure, skip steps 3, 5, 6, 6, and 7, and go to step 8.

If the **NCAI** value is being changed from **YES** to **NO** in this procedure, perform steps 3, 4, and 5.

If the **NCAI** value is being changed from **NO** to **YES** in this procedure, skip steps 3, 4, and 5, and go to step 6.

3. Display the **NCAI** value that is assigned to the cluster point code being changed, by entering the **rtrv-dstn** command and specifying the **DPC** that is being changed. For this example, enter this command.

```
rtrv-dstn:dpca=030-003-*
```

This is an example of the possible output.

```
rlghncxa03w 05-09-28 21:16:37 GMT EAGLE5 34.0.0
DPCA          CLLI          BEI  ELEI  ALIASI          ALIASN/N24  DOMAIN
030-003-*     rlghncbb333  yes  yes  -----        -----      SS7

          SPC          NCAI
          -----      yes

DESTINATION ENTRIES ALLOCATED:  2000
FULL DPC(s):                    20
NETWORK DPC(s):                  0
CLUSTER DPC(s):                  2
TOTAL DPC(s):                    22
CAPACITY (% FULL):                1%
ALIASES ALLOCATED:                8000
```

```

ALIASES USED:                28
CAPACITY (% FULL):          1%
X-LIST ENTRIES ALLOCATED:    500
RTRV-STN: MASP A - COMPLTD

```

4. Enter the **rtrv-dstn** command with the cluster point code being changed, but with three asterisks for the network-cluster member value of the cluster point code instead of one asterisk. For this example, enter this command.

```
rtrv-dstn:dpca=030-003-***
```

This is an example of the possible output.

```

rlghncxa03w 05-09-28 21:16:37 GMT EAGLE5 34.0.0
  DPCA          CLLI          BEI ELEI  ALIASI          ALIASN/N24  DOMAIN
030-003-*      rlghncbb333 yes yes  -----          -----  SS7
030-003-100    rlghncbb334 yes no   1-112-3          10-13-10-1  SS7
030-003-200    rlghncbb335 yes no   1-117-3          10-13-11-1  SS7
030-003-225    rlghncbb336 yes no   -----          -----  SS7

```

```

Destination table is (20 of 2000) 1% full
Alias table is (28 of 8000) 1% full
RTRV-DSTN: MASP A - COMPLTD

```

NOTE: If the cluster point code does not have any member point codes in the database, skip step 5 and go to step 6.

5. Display the routes to the members of the cluster point code, shown in step 4, in the database using the **rtrv-rte** command with the DPC values shown in step 4 for the members of the cluster point code. For this example, enter these commands.

```
rtrv-rte:dpca=030-003-100
```

This is an example of the possible output.

```

rlghncxa03w 05-09-07 11:43:04 GMT EAGLE5 34.0.0
  DPCA          ALIASI          ALIASN/N24  LSN          RC          APCA
030-003-100    1-112-3          10-13-10-1  1s000300    10          030-003-100
                                           CLLI=rlghncbb334

```

```
rtrv-rte:dpca=030-003-200
```

This is an example of the possible output.

```

rlghncxa03w 05-09-07 11:43:04 GMT EAGLE5 34.0.0
  DPCA          ALIASI          ALIASN/N24  LSN          RC          APCA
030-003-200    1-117-3          10-13-11-1  1s000301    10          10 030-003-200
                                           CLLI=rlghncbb335

```

```
rtrv-rte:dpca=030-003-225
```

This is an example of the possible output.

```

rlghncxa03w 05-09-07 11:43:04 GMT EAGLE5 34.0.0
  DPCA          ALIASI          ALIASN/N24  LSN          RC          APCA
030-003-225    -----          -----          1s000301    10          030-003-300
                                           CLLI=rlghncbb336

```

If the **NCAI** parameter is being changed from **YES** to **NO**, the routes to the point codes that are members of the cluster point code being changed must be removed from the database. Go to the "Removing a Route" procedure on

page 3-189 and remove these routes from the database. For this example, the routes to point codes 030-003-100, 030-003-200, and 030-003-225 must be removed.

NOTE: If the **NCAI** parameter value is not being changed from **NO** to **YES**, skip steps 6 and 7, and go to step 8.

6. Verify that the nested cluster routing feature is on with the **rtrv-feat** command. If the nested cluster routing feature is turned on, the **NCR** field should be set to **on**. In this example, the nested cluster routing feature is off.

NOTE: The **rtrv-feat** command output contains other fields that are not used by this procedure. If you wish to see all the fields displayed by the **rtrv-feat** command, see the **rtrv-feat** command description in the *Commands Manual*.

If the nested cluster routing feature is on, skip step 7 and go to step 8.

-
7. Turn the nested cluster routing feature on by entering this command.

```
chg-feat:ncr=on
```

NOTE: Once the nested cluster routing feature is turned on with the **chg-feat** command, it cannot be turned off

The nested cluster routing feature must be purchased before you turn this feature on with the **chg-feat** command. If you are not sure if you have purchased the nested cluster routing features, contact your Tekelec Sales Representative or Account Representative.

When this command has successfully completed, this message should appear.

```
rlghncxa03w 05-09-10 11:43:04 GMT EAGLE5 34.0.0
CHG-FEAT: MASP A - COMPLTD
```

-
8. Change the cluster point code, using the **chg-dstn** command, and specifying either the **ncai** or **elei** parameters, or both. For this example, enter this command.

```
chg-dstn:dpca=030-003-*:clli=1s09clli:ncai=no:elei=no
```

When this command has successfully completed, this message should appear.

```
rlghncxa03w 05-09-17 15:35:05 GMT EAGLE5 34.0.0
DESTINATION ENTRIES ALLOCATED: 2000
  FULL DPC(s): 20
  NETWORK DPC(s): 0
  CLUSTER DPC(s): 2
  TOTAL DPC(s): 22
  CAPACITY (% FULL): 1%
ALIASES ALLOCATED: 8000
  ALIASES USED: 28
  CAPACITY (% FULL): 1%
X-LIST ENTRIES ALLOCATED: 500
CHG-DSTN: MASP A - COMPLTD
```

- Verify the changes using the `rtrv-dstn` command, and specifying the cluster point code that was entered in step 8 with the `dpca` parameter. For this example, enter this command.

`rtrv-dstn:dpca=030-003-*`

This is an example of the possible output.

```
rlghncxa03w 05-09-28 21:16:37 GMT EAGLE5 34.0.0
  DPCA          CLLI          BEI ELEI  ALIASI          ALIASN/N24  DOMAIN
  030-003-*     ls09clli        yes no  -----          -----          SS7

                SPC          NCAI
                -----          no

DESTINATION ENTRIES ALLOCATED:  2000
  FULL DPC(s) :                   20
  NETWORK DPC(s) :                  0
  CLUSTER DPC(s) :                  2
  TOTAL DPC(s) :                   22
  CAPACITY (% FULL) :              1%
ALIASES ALLOCATED:                8000
  ALIASES USED:                    28
  CAPACITY (% FULL) :              1%
X-LIST ENTRIES ALLOCATED:         500
RTRV-DSTN: MASP A - COMPLTD
```

- Back up the new changes, using the `chg-db:action=backup:dest=fixed` command. These messages should appear; the active Maintenance and Administration Subsystem Processor (MASP) appears first.

```
BACKUP (FIXED) : MASP A - Backup starts on active MASP.
BACKUP (FIXED) : MASP A - Backup on active MASP to fixed disk complete.
BACKUP (FIXED) : MASP A - Backup starts on standby MASP.
BACKUP (FIXED) : MASP A - Backup on standby MASP to fixed disk complete.
```

Flowchart 2-9. Changing the Attributes of a Cluster Point Code (Sheet 1 of 5)

NOTE: Before executing this procedure, make sure you have purchased the Cluster Routing and Management Diversity feature or the nested cluster routing feature. If you are not sure if you have purchased the Cluster Routing and Management Diversity feature or the nested cluster routing feature, contact your Tekelec Sales Representative or Account Representative.

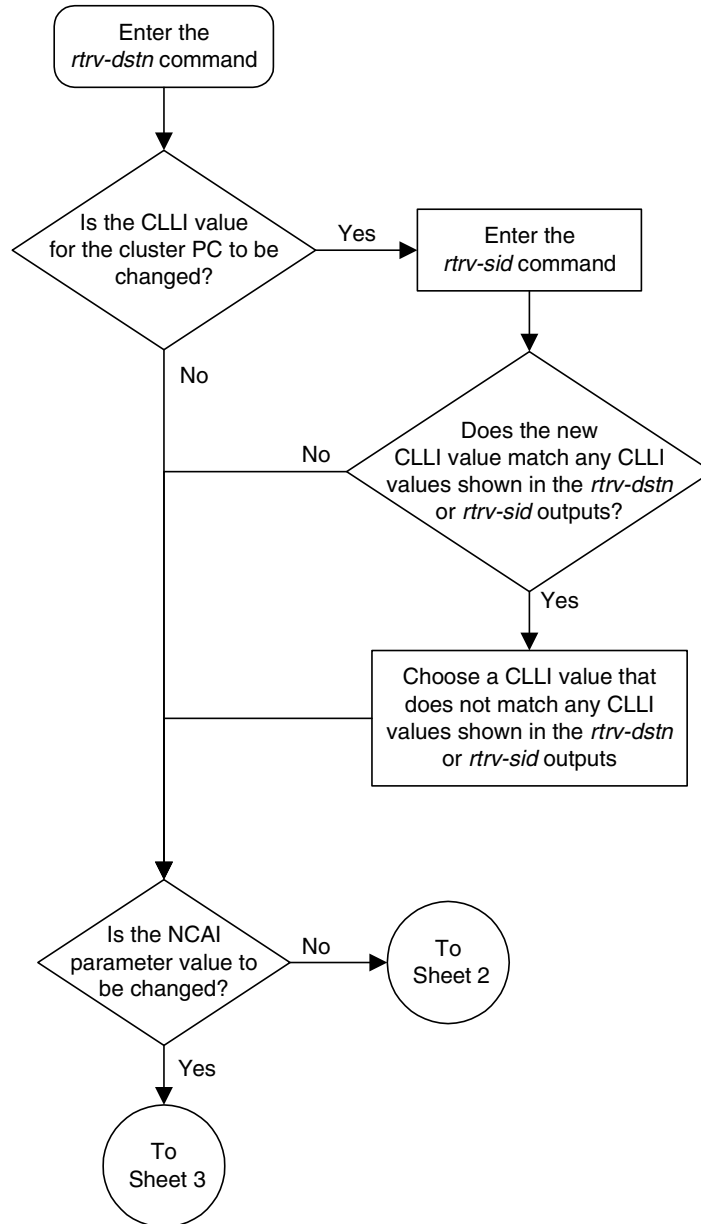

Flowchart 2-9. Changing the Attributes of a Cluster Point Code (Sheet 2 of 5)

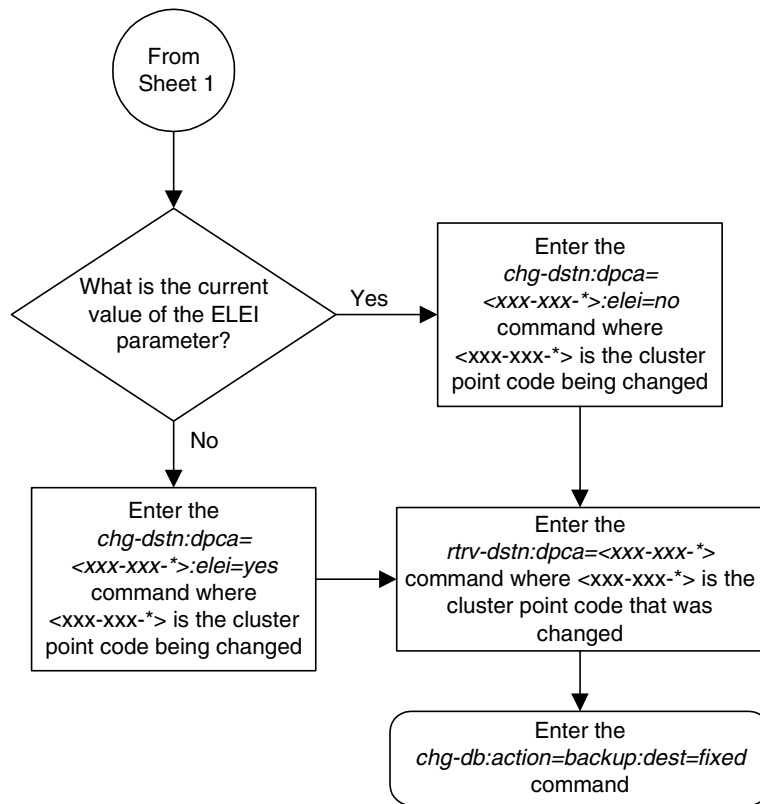

Flowchart 2-9. Changing the Attributes of a Cluster Point Code (Sheet 3 of 5)

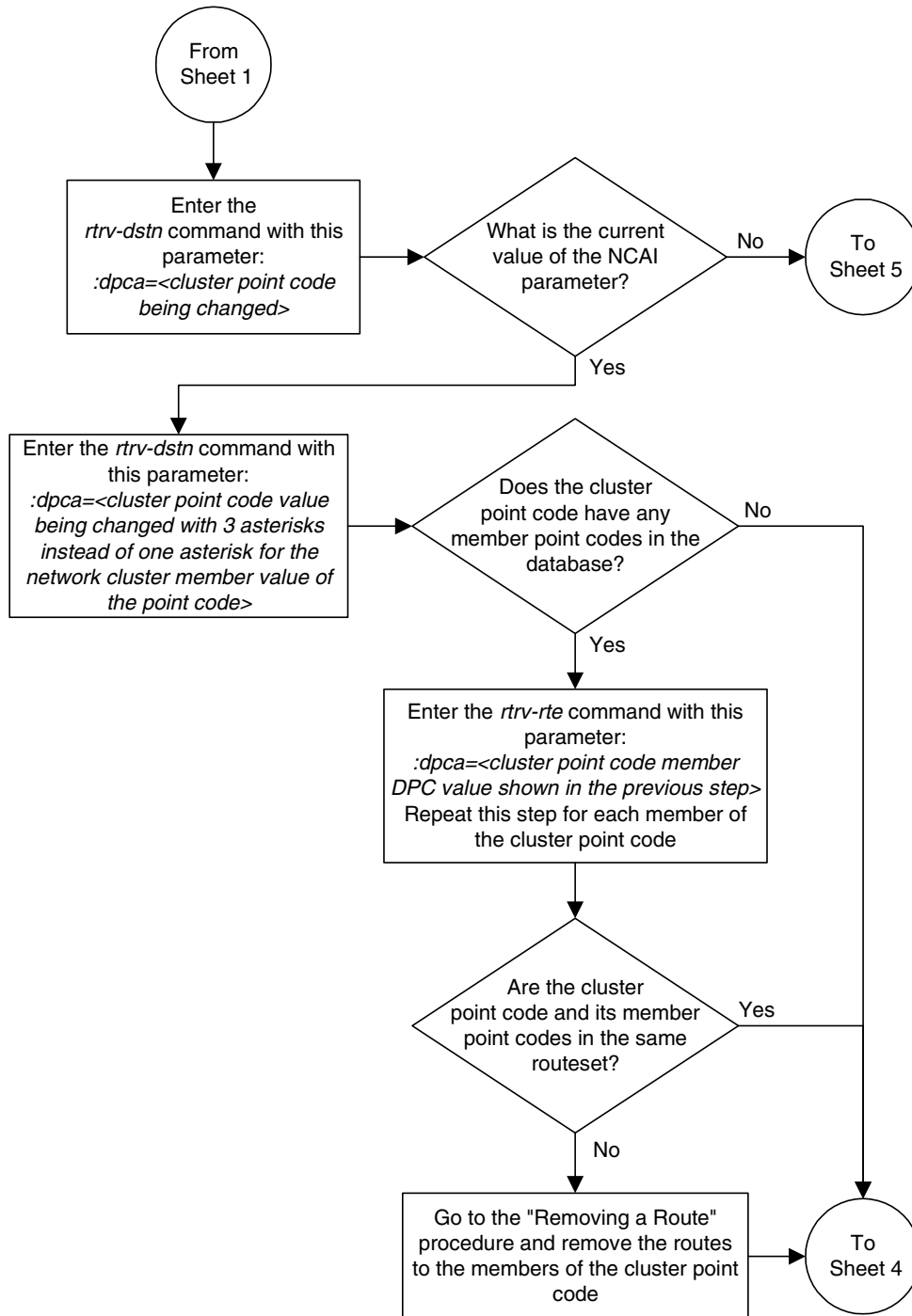

Flowchart 2-9. Changing the Attributes of a Cluster Point Code (Sheet 4 of 5)

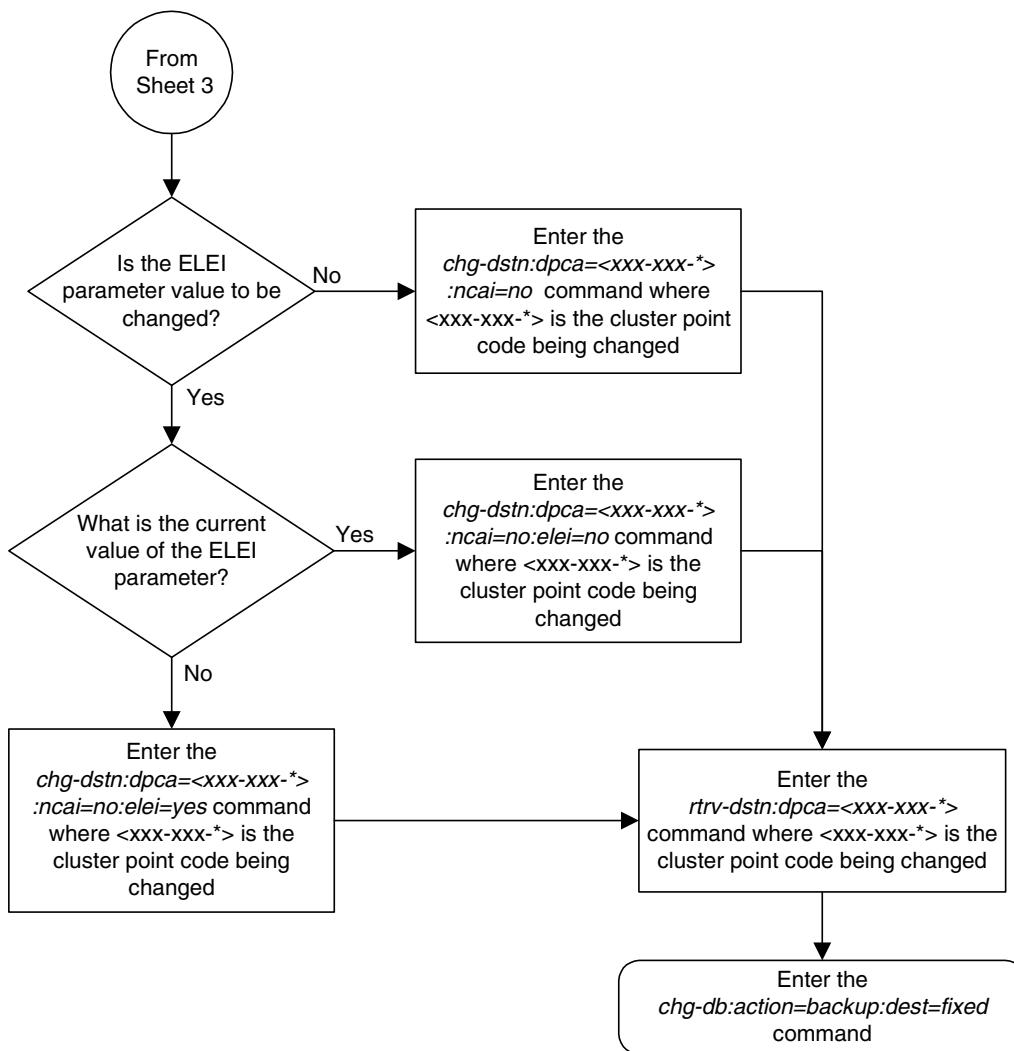

Flowchart 2-9. Changing the Attributes of a Cluster Point Code (Sheet 5 of 5)

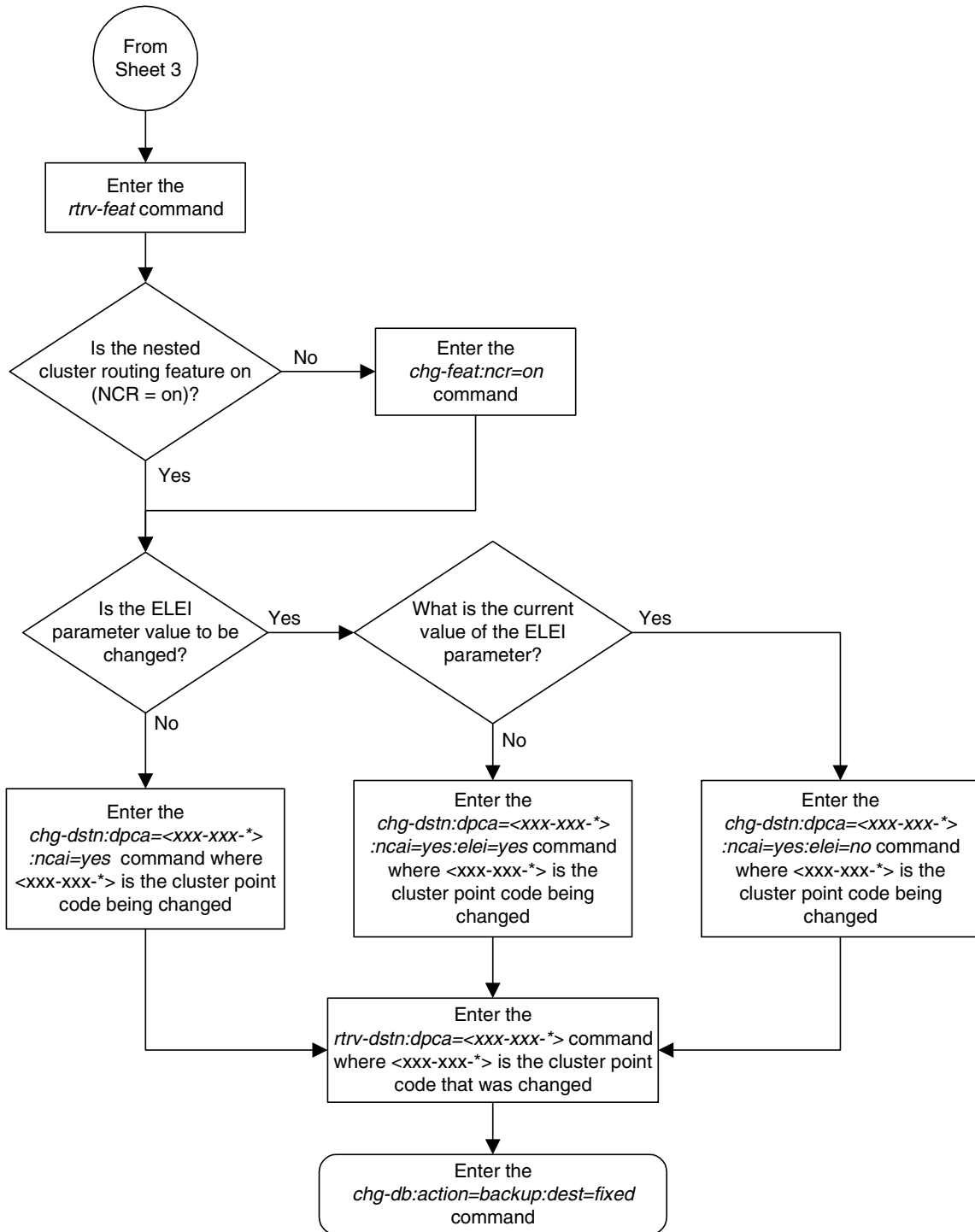

Network Routing

Network routing allows the user to provision a single routeset that can be used for all MSUs destined to members of that network. The advantages of network routing are:

- Reduces the number of entries in the route table
- Allows routing to members of a network without having to add those members to the route table

A EAGLE 5 SAS user can connect to a remote network by provisioning a single route table element. As the remote network grows, the EAGLE 5 SAS user does not have to add new route table entries for each new point code in the remote network.

NOTE: Network routing can be used only with ANSI point codes.

Types of Routing Strategies Available

The EAGLE 5 SAS currently allows a user to provision two types of routing strategies:

- Full point code routing
- Network/cluster routing (also called cluster routing)

This feature allows the user to provision a third type of routing strategy, network routing.

It is possible to provision full point code entries, cluster entries, and network entries for members of the same network. Any overlaps in the routing strategies are handled by a specific searching hierarchy.

All of these route table entries can coexist:

- 8-1-1 – A full point code entry
- 8-1-* – A cluster entry
- 8-*-* – A network entry

The searching hierarchy tries to match against a full point code entry first, followed by a cluster entry, and finally a network entry. In the preceding example, when the EAGLE 5 SAS routes an MSU destined for 8-1-1, it uses the full point code entry; when the EAGLE 5 SAS routes an MSU destined for 8-1-2 it uses the cluster entry; and when the EAGLE 5 SAS routes an MSU destined for 8-2-2, it uses the network entry.

Applications

Network routing is very useful when the destination node is very far away from the source node. The reliability of network routing increases when the destination is further away. Notice that in Figure 2-12, routing from network A is more reliable to nodes in network C than to nodes in network B.

Figure 2-12. Example of Network Routing Reliability

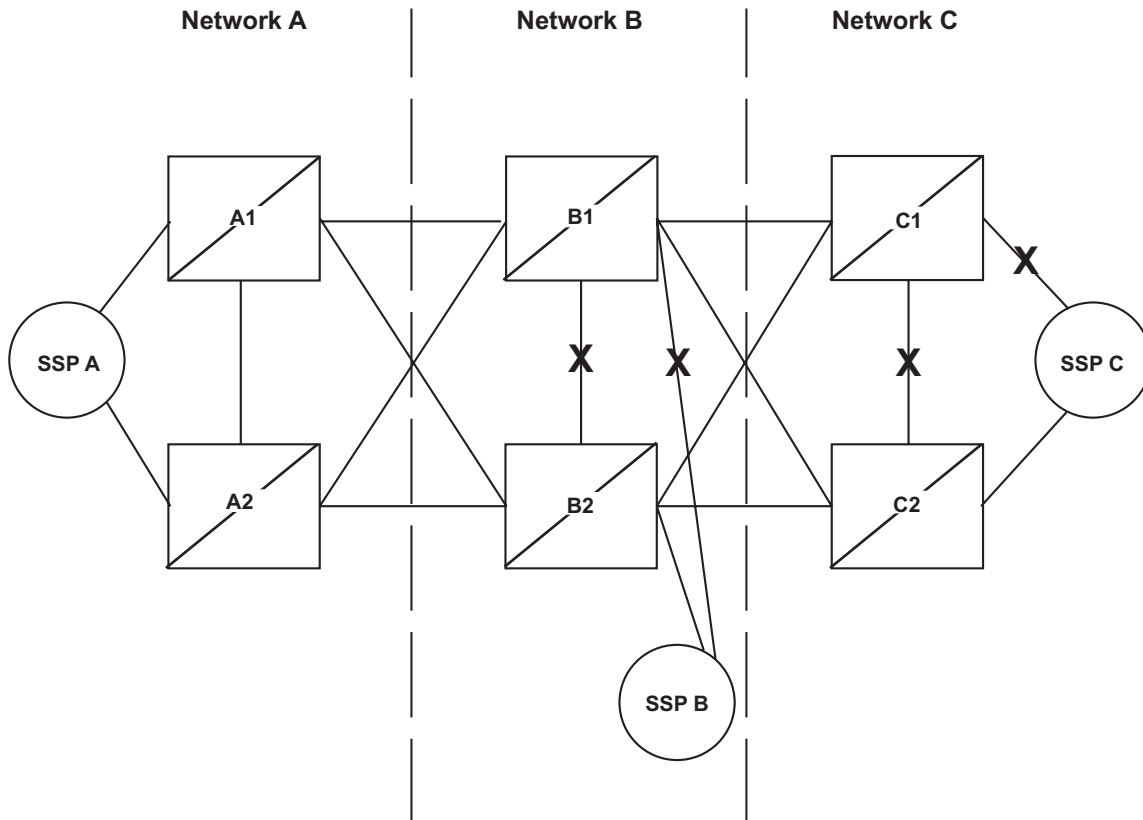

If the nodes in network A use network routing for network C, network A can still route traffic to SSP C, even if two linksets fail. In this example, one of the A-linksets to SSP C and the C-linkset between node C1 and node C2 fail. In this case, the EAGLE 5 SAS in network A continues to route half its traffic to node B1, and half to node B2. Node B1 and node B2 (which do not use network routing) route all traffic for SSP C through node C2.

If the nodes in network A use network routing for network B, traffic going to SSP B may be lost if two linksets fail. In this example, one of the A-linksets to SSP B and the C-linkset between node B1 and node B2 fail. In this case, the EAGLE 5 SAS in network A continues to route half its traffic to node B1, and half to node B2. Traffic for SSP B routed through node B1 is discarded, resulting in message loss.

Route Availability

A route is one path to a destination. A routeset is a list of paths to a destination. Route availability consists of two parts:

- Local availability
- Remote availability

Remote availability is affected by TFX network management messages. Local availability is affected by linkset failures and recoveries. TFX messages do not affect point codes accessed by network route entries. Therefore, for network route entries, route availability consists of only local availability. The highest priority linkset available for traffic is used for routing MSUs, regardless of the remote availability of that route.

Figure 2-13. Potential Routing Network Failure

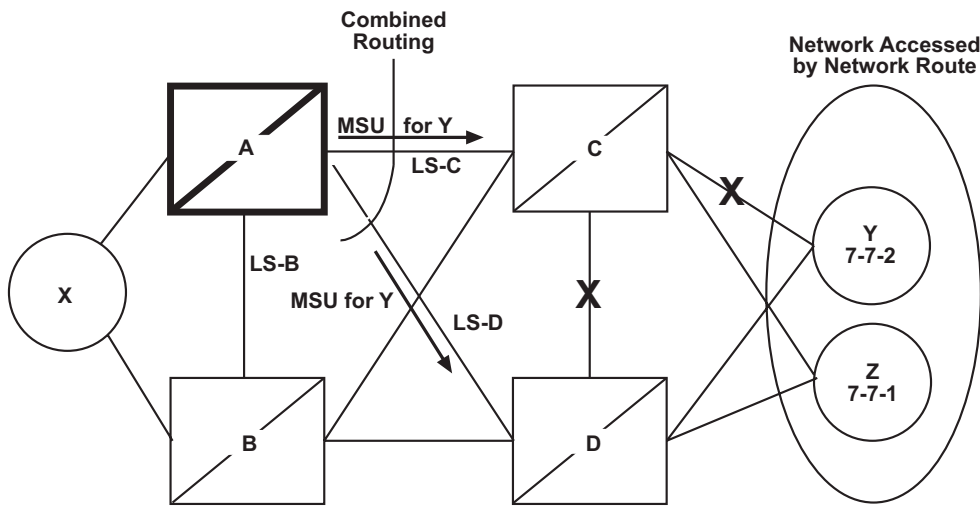

In the example in Figure 2-13, linksets LS-C and LS-D form a combined route to network route 7-7-*. Because 7-7-* is a network route, the EAGLE 5 SAS always considers the non-adjacent status of the routes to be allowed. In the example shown, the EAGLE 5 SAS routes traffic destined to 7-7-1 over LS-C and LS-D. The EAGLE 5 SAS ignores TFPs concerning 7-7-1 or TCPs concerning 7-7-*.

Point Code Availability

A point code that is accessed by a network route entry is considered available if there is any linkset in the routeset that is available for traffic.

Route Management

Local Link Congestion

This feature has no impact on the generation of TFC messages. A TFC is generated concerning point code X-Y-Z, even if X-Y-Z is routed using a network route entry.

Remote Congestion

Because the EAGLE 5 SAS has global title capabilities, it is possible for the EAGLE 5 SAS to receive a TFC concerning a point code that is accessed by a network route entry. Network route entries are not affected by TFC messages.

Broadcast Transfer Messages

The EAGLE 5 SAS does not broadcast TFX messages for network route entries.

Response Method Transfer Messages

The EAGLE 5 SAS sends response method TFX messages for network routes as follows:

- Prohibited Network Routes

If the EAGLE 5 SAS receives an MSU that is accessed by a network route entry, and that network route is Prohibited, the EAGLE 5 SAS sends a response method TFP or TCP message, as follows:

- If there is a full point code defined in the same cluster as the MSU (for example, 8-**-* and 8-1-1 are defined in the EAGLE 5 SAS's routing table, and MSU is destined for 8-1-2), the EAGLE 5 SAS sends a TFP with concerned point code set to the MSU's DPC.
- Otherwise, the EAGLE 5 SAS sends a TCP with concerned point code set to the cluster of the MSU's DPC.

The EAGLE 5 SAS sends response method TCPs or TFPs at a rate of one TCP or TFP per signaling link during the level 3 T8 timer period for each network route.

For example, in Figure 2-13 on page 2-176, the network route for 7-**-* becomes Prohibited due to the failure of LS-B, LS-C, and LS-D. When the EAGLE 5 SAS receives an MSU from X destined for 7-7-1, the EAGLE 5 SAS sends a response method TCP concerning 7-7-*. When the EAGLE 5 SAS receives an MSU from X destined for 7-8-2, the EAGLE 5 SAS sends a response method TCP concerning 7-8-*.

- System Detects Danger of Circular Routing

If the EAGLE 5 SAS receives an MSU that is accessed by a network route entry, and the EAGLE 5 SAS detects danger of circular routing, the EAGLE 5 SAS sends a response method TFP or TCP message, as follows:

- If there is a full point code defined in the same cluster as the MSU (for example, 8-*- and 8-1-1 are defined in the EAGLE 5 SAS's routing table, and the MSU is destined for 8-1-2), the EAGLE 5 SAS sends a TFP with concerned point code set to the MSU's DPC.
- Otherwise, the EAGLE 5 SAS sends a TCP with concerned point code set to the cluster of the MSU's DPC.

The EAGLE 5 SAS sends response method TCPs at a rate of one TCP per signaling link during the level 3 T8 timer period for each network route.

For example, in Figure 2-13 on page 2-176, all linksets are available. If the EAGLE 5 SAS receives an MSU from node C destined for 7-7-1, the EAGLE 5 SAS detects danger of circular routing, and sends a response method TCP concerning 7-7-*. The EAGLE 5 SAS also discards the MSU.

- Restricted Network Routes

If the EAGLE 5 SAS receives an MSU that is accessed by a network route entry, and that network route is Restricted, the EAGLE 5 SAS sends a one-time response method TFR or TCR message, as follows:

- If there is a full point code defined in the same cluster as the MSU (for example, 8-*- and 8-1-1 are defined in the EAGLE 5 SAS's routing table, and MSU is destined for 8-1-2), the EAGLE 5 SAS sends a TFR with concerned point code set to the MSU's DPC.
- Otherwise, the EAGLE 5 SAS sends a TCR with concerned point code set to the cluster of the MSU's DPC.

For example, in Figure 2-13 on page 2-176, the network route for 7-*- becomes Restricted due to the failure of LS-C and LS-D. When the EAGLE 5 SAS receives an MSU from X destined for 7-7-1, the EAGLE 5 SAS sends a response method TCR concerning 7-7-*, then routes the MSU over LS-B. When the EAGLE 5 SAS next receives an MSU from X destined for 7-8-2, the EAGLE 5 SAS does not send a response, and routes the MSU over LS-B.

Reception of Transfer Messages

The EAGLE 5 SAS does not apply received transfer messages to a network route.

For example, in Figure 2-13 on page 2-176, if the EAGLE 5 SAS receives a TFP concerning 7-7-1, it has no effect on the routing status of 7-*-*. The EAGLE 5 SAS continues to send MSUs destined to 7-*-*, including MSUs destined to 7-7-1, on LS-C.

As another example, if the EAGLE 5 SAS receives a TCP concerning 7-8-*, it has no effect on the routing status of 7-*-*. The EAGLE 5 SAS continues to send MSUs destined to 7-*-*, including MSUs destined to 7-8-2, on LS-C.

Reception of an RSx Message

If a routeset test (RSP or RSR) is received, a full point code reply (TFx) is generated. The responses to RSP/RSR have been changed according to Table 2-9. Note that the searching hierarchy applies.

Table 2-9. Reception of an RSx Message

Concerned Point Code is:	Result
Found by a full point code match	No change to existing rules.
Found by a cluster match	No change to existing rules.
Found by a network match	Send a TFx message based on the current routeset status. <ul style="list-style-type: none"> • Send a TFP if danger of circular routing. Otherwise: <ul style="list-style-type: none"> • Send a TFA if the network route is Allowed. • Send a TFR if the network route is Restricted. • Send a TFP if the network route is Prohibited.
Not found	No change to existing rules. Send a TFP.

Reception of an RCx Message

If a routeset cluster test (RCP or RCR) is received, a cluster reply (TCx) is generated. The responses to RCP/RCR have been changed according to Table 2-10. Note that the searching hierarchy applies.

Table 2-10. Reception of an RCx Message

Concerned Point Code is:	Result
Found by a cluster match	No change to existing rules.
Found by a network match	Send a TCx message based on the current routeset status. <ul style="list-style-type: none"> • Send a TCP if danger of circular routing. Otherwise: <ul style="list-style-type: none"> • Send a TCA if the network route is Allowed. • Send a TCR if the network route is Restricted. • Send a TCP if the network route is Prohibited.
Not found	No change to existing rules. Send a TCP.

Administration

The network routing feature must be on, before a network routing point code can be provisioned in the database. This can be verified with the entry `NRT = on` in the output of the `rtrv-feat` command. If the network routing feature is not on, `NRT = off`, it must be turned on with the `chg-feat` command using the `nrt=on` parameter. Once the network routing feature is on, the network routing point code can be provisioned in the database like any other destination point code. Routes can then be assigned to the network routing point code like any other destination point code. For more information on provisioning network routing point codes, see the “Adding a Network Routing Point Code” procedure on page 2-181.

NOTE: Once the network routing feature is turned on using the `chg-feat` command, it cannot be turned off. When using the network routing feature, limited network management is provided for point codes not covered by full point code routing, cluster routing, or nested cluster routing.

The network routing feature must be purchased before you turn this feature on with the `chg-feat` command. If you are not sure if you have purchased the network routing feature, contact your Tekelec Sales Representative or Account Representative.

Adding a Network Routing Point Code

This procedure is used to add a destination point code to the database, using the `ent-dstn` command.

To change the attributes of an existing network routing point code, go to the “Changing a Destination Point Code” procedure on page 2-226.

To remove a network routing point code from the database, go to the “Removing a Destination Point Code” procedure on page 2-214.

The `ent-dstn` command uses these parameters:

`:dpc/dpca` – The destination point code being added to the database

NOTE: See “Point Code Formats” on page 2-4 for a definition of the point code types that are used on the EAGLE 5 SAS. Alias point codes (`aliasi/aliasn/aliasn24`) and secondary point codes (`spc/spca`) cannot be specified for a network routing point code. An ANSI private point code must be a full point code.

`:c11i` – The Common Language Location Identifier assigned to this point code

`:domain` – The network in which the destination entity or node exists, X.25 or SS7

NOTE: Specifying the `domain=x25` parameter is not valid for network routing destination point codes.

`:bei` – Broadcast exception indicator that indicates whether transfer-prohibited (TFP) messages will be broadcast from this node. The `bei=yes` parameter means TFPs will not be broadcast. The `bei=no` parameter means TFPs will be broadcast.

`:ipgwapc` – (ANSI networks only) IP Gateway Adjacent Point Code indicator. Specify `ipgwapc=yes` to provide SS7 linkset definition compatibility for gateway connections to IP-SCPs. The default is `ipgwapc=no`.

`:elei` – For cluster point codes only. Specifies whether or not the EAGLE 5 SAS maintains a dynamic status exception list for each cluster route that may be used to reach the member signaling points making up the cluster.

NOTE: See the “Cluster Routing and Management Diversity (CRMD)” section on page 2-119 and the “Adding a Cluster Point Code” procedure on page 2-142 for more information on the cluster routing feature and the `elei` parameter.

`:ncai` – The nested-cluster-allowed indicator specifies whether or not the route to the cluster point code can be different from the route to a point code that is a member of the cluster point code.

NOTE: See the “Nested Cluster Routing” section on page 2-135 and the “Adding a Cluster Point Code” procedure on page 2-142 for more information on the nested cluster routing feature and the `ncai` parameter.

The network routing point code must be in the SS7 domain (`domain=ss7`) and can only be an ANSI point code. ITU point codes cannot be specified as network routing point codes.

The `ncai`, `spc`, and `elei` parameters cannot be specified with a network routing point code.

The value of the `cli` parameter cannot be in the DPC table and cannot match the CLI of the EAGLE 5 SAS. Verify this by entering the `rtrv-dstn` and the `rtrv-sid` commands, shown in steps 1 and 2 of the procedure that follows. If the value of the `cli` parameter matches any CLI values in either of these outputs, choose another value for the `cli` parameter that does not match any CLIs shown in either of these command outputs.

To enter the `dpc/dpca` parameter with the `ent-dstn` command, a point code must be defined in the `pca` field of the self ID of the EAGLE 5 SAS. Verify this with the `rtrv-sid` command.

If no value is shown in the `pca` field in the `rtrv-sid` command output, the self-identification of the EAGLE 5 SAS must be updated with an ANSI point code. Go to “Changing the Self-Identification of the EAGLE 5 SAS” procedure on page 2-90 to change the self-identification of the EAGLE 5 SAS.

NOTE: To enter a network routing point code with the network indicator values 1 through 5, the `pctype` parameter value of the `chg-sid` command must be set to `other`. If you attempt to add a network routing point code with the network indicator values 1 through 5 and the `pctype` parameter value is `ansi`, the `ent-dstn` command will be rejected with this error message.

E2169 Cmd Rej: Point code out of range

Destination point codes must be unique in the database.

The actual number of destination point codes that can be configured in the database is set by the `mtpdpcq` parameter of the `chg-stpopts` command, and is shown in the `MTPDPCQ` field in the `rtrv-stpopts` command output.

If the 5000 Routes feature is not on, and 6000, 7000, or 8000 routesets are not enabled, a maximum of 2000 destination point codes can be configured in the database.

If the 5000 Routes feature is on, and 6000, 7000, or 8000 routesets are not enabled, a maximum of 5000 destination point codes can be configured in the database.

If 6000 routesets are enabled, a maximum of 6000 destination point codes can be configured in the database.

If 7000 routesets are enabled, a maximum of 7000 destination point codes can be configured in the database.

Configuring Destination Tables

If 8000 routesets are enabled, a maximum of 8000 destination point codes can be configured in the database.

NOTE: For more information on the destination point code quantities, go to the “Changing the DPC Quantity” procedure on page 2-23.

The examples in this procedure are used to add the network routing point code 007-**-* to the database.

Canceling the RTRV-DSTN Command

Because the `rtrv-dstn` command used in this procedure can output information for a long period of time, the `rtrv-dstn` command can be canceled and the output to the terminal stopped. There are three ways that the `rtrv-dstn` command can be canceled:

- Press the **F9** function key on the keyboard at the terminal where the `rtrv-dstn` command was entered.
- Enter the `canc-cmd` without the `trm` parameter at the terminal where the `rtrv-dstn` command was entered.
- Enter the `canc-cmd:trm=<xx>`, where `<xx>` is the terminal where the `rtrv-dstn` command was entered, from another terminal other than the terminal where the `rtrv-dstn` command was entered. To enter the `canc-cmd:trm=<xx>` command, the terminal must allow Security Administration commands to be entered from it and the user must be allowed to enter Security Administration commands. The terminal’s permissions can be verified with the `rtrv-secu-trm` command. The user’s permissions can be verified with the `rtrv-user` or `rtrv-secu-user` commands.

For more information about the `canc-cmd` command, refer to the *Commands Manual*.

Procedure

1. Display the current destination point codes using the `rtrv-dstn` command. This is an example of the possible output.

```
rlghncxa03w 05-09-17 16:02:05 GMT EAGLE5 34.0.0
DPCA          CLLI          BEI  ELEI    ALIASI          ALIASN/N24    DOMAIN
001-002-003   ls04c1li       yes  ---     -----        -----      SS7
030-045-*     rlghncbb010   yes  yes     -----        -----      SS7
111-011-*     rlghncbb000   yes  yes     -----        -----      SS7
240-012-004   rlghncbb001   yes  ---     1-111-1        10-13-9-3    SS7
240-012-005   rlghncbb002   yes  ---     1-112-2        10-13-10-0   SS7
240-012-006   rlghncbb003   yes  ---     1-112-3        10-13-10-1   SS7
240-012-008   -----       yes  ---     1-113-5        10-13-10-2   SS7
244-020-004   ls06c1li       yes  ---     -----        -----      X25
244-020-005   ls07c1li       yes  ---     -----        -----      X25
244-020-006   ls08c1li       yes  ---     -----        -----      X25
244-020-007   -----       yes  ---     -----        -----      X25
244-020-008   -----       yes  ---     -----        -----      X25
```

DPCI	CLLI	BEI	ELEI	ALIASA	ALIASN/N24	DOMAIN
2-131-1	rlghncbb023	no	---	222-210-000	11-11-8-1	SS7
2-131-2	-----	no	---	222-211-001	11-11-8-2	SS7
2-131-3	-----	no	---	222-211-002	11-11-8-3	SS7

DPCN	CLLI	BEI	ELEI	ALIASA	ALIASI	DOMAIN
10-15-2-3	rlghncbb013	no	---	222-200-200	2-121-1	SS7
10-15-3-0	rlghncbb013	no	---	222-200-201	2-121-2	SS7

DPCN24	CLLI	BEI	ELEI	ALIASA	ALIASI	DOMAIN
--------	------	-----	------	--------	--------	--------

```

DESTINATION ENTRIES ALLOCATED: 6000
FULL DPC(s) : 14
NETWORK DPC(s) : 0
CLUSTER DPC(s) : 2
TOTAL DPC(s) : 16
CAPACITY (% FULL) : 1%
ALIASES ALLOCATED: 8000
ALIASES USED: 18
CAPACITY (% FULL) : 1%
X-LIST ENTRIES ALLOCATED: 500
RTRV-DSTN: MASP A - COMPLTD
    
```

If the addition of the network routing point code will not exceed the current DPC capacity shown in the **rtrv-dstn** output, go to step 2.

If the addition of the network routing point code will exceed the current DPC capacity, and the current capacity is less than 8000 (or 8500 if the **DESTINATION ENTRIES ALLOCATED** and **X-LIST ENTRIES ALLOCATED** fields are shown in the **rtrv-dstn** output), perform the “Changing the DPC Quantity” procedure on page 2-23 to change the DPC quantity. Then go to step 2.

If the addition of the network routing point code will exceed the current DPC capacity, and the current capacity is 8000 (or 8500 if the **DESTINATION ENTRIES ALLOCATED** and **X-LIST ENTRIES ALLOCATED** fields are shown in the **rtrv-dstn** output), perform the “Removing a Destination Point Code” procedure on page 2-214 to remove a DPC. Then go to step 2.

2. Verify that the network routing feature is on, by entering the **rtrv-feat** command. If the network routing feature is on, the **NRT** field should be set to **on**. For this example, the network routing feature is off.

NOTE: The **rtrv-feat** command output contains other fields that are not used by this procedure. If you wish to see all the fields displayed by the **rtrv-feat** command, see the **rtrv-feat** command description in the *Commands Manual*.

If the network routing feature is on, skip this step and go to step 3.

Configuring Destination Tables

3. If the network routing feature is not on, shown by the **NRT = off** entry in the **rtrv-feat** command output of step 2, turn the network routing feature on by entering this command.

```
chg-feat:nrt=on
```

NOTE: Once the network routing feature is turned on with the **chg-feat** command, it cannot be turned off.

The network routing feature must be purchased before you turn this feature on with the **chg-feat** command. If you are not sure if you have purchased the network routing feature, contact your Tekelec Sales Representative or Account Representative.

When the **chg-feat** has successfully completed, this message should appear.

```
rlghncxa03w 05-09-07 00:57:31 GMT EAGLE5 34.0.0
CHG-FEAT: MASP A - COMPLTD
```

NOTES:

1. If network routing point codes with the network indicator values 1 through 5 are shown in the **rtrv-dstn** command output in step 1, skip this step and go to step 5.
 2. If you wish to enter a network routing point code with the network indicator values 1 through 5, perform this step to verify the **pctype** value.
 3. If ANSI point codes are not shown in the **rtrv-dstn** output in step 1, perform this step to verify that an ANSI point code is assigned to the self-identification of the EAGLE 5 SAS.
 4. If network routing point codes or ANSI point codes are shown in the **rtrv-dstn** command output in step 1, and you do not wish to enter a network routing point code with the network indicator values 1 through 5, skip this step and go to step 5.
4. Display the self-identification of the EAGLE 5 SAS using the **rtrv-sid** command. This is an example of the possible output.

```
rlghncxa03w 05-09-10 11:43:04 GMT EAGLE5 34.0.0
PCA          PCI          PCN          CLLI          PCTYPE
100-100-100  3-75-7         7-9-8-1      rlghncxa03w  OTHER

CPCA
002-002-002      002-002-003      002-002-004      002-002-005
002-002-006      002-002-007      002-002-008      002-002-009
004-002-001      004-003-003      050-060-070

CPCA (LNP)
005-005-002      005-005-004      005-005-005

CPCI
1-002-1          1-002-2          1-002-3          1-002-4
2-001-1          7-222-7

CPCN
2-0-10-3        2-0-11-0        2-0-11-2        2-0-12-1
2-2-3-3        2-2-4-0        10-14-10-1
```

To enter an ANSI destination point code with the `ent-dstn` command, a point code must be shown in the `PCA` field of the `rtrv-sid` command output.

If the required point code is not shown in the `PCA` field of the `rtrv-sid` command output, go to the “Changing the Self-Identification of the EAGLE 5 SAS” procedure on page 2-90 and configure the required point codes.

To enter a network routing point code with the network indicator values 1 through 5, the `pctype` parameter value of the `chg-sid` command must be set to `other`. If you wish to enter a network routing point code with a network indicator value 1 through 5, and the `pctype` parameter value is `ansi`, perform the “Changing the Self-Identification of the EAGLE 5 SAS” procedure on page 2-90 and change the `pctype` value to `other`.

NOTE: If the `rtrv-dstn` command output in step 1 shows network routing point codes, skip steps 3 and 3, and go to step 5.

5. Add the network routing destination point code, using the `ent-dstn` command. For this example, enter this command.

```
ent-dstn:dpca=007-**-*
```

When this command has successfully completed, and the Cluster Routing and Management Diversity feature is turned off (shown with the `CRMD = off` entry in the `rtrv-feat` command output), this message should appear.

```
rlghncxa03w 05-09-17 15:35:05 GMT EAGLE5 34.0.0
Destination table is (17 of 2000) 1% full
ENT-DSTN: MASP A - COMPLTD
```

If the Cluster Routing and Management Diversity feature is turned on (`CRMD = on` in the `rtrv-feat` command output), this message should appear when each command has successfully completed.

```
rlghncxa03w 05-09-17 15:35:05 GMT EAGLE5 34.0.0
DESTINATION ENTRIES ALLOCATED: 6000
  FULL DPC(s): 14
  NETWORK DPC(s): 1
  CLUSTER DPC(s): 2
  TOTAL DPC(s): 17
  CAPACITY (% FULL): 1%
ALIASES ALLOCATED: 8000
  ALIASES USED: 18
  CAPACITY (% FULL): 1%
X-LIST ENTRIES ALLOCATED: 500
ENT-DSTN: MASP A - COMPLTD
```

Configuring Destination Tables

6. Verify the changes using the `rtrv-dstn` command, and specifying the DPC that was entered in step 5.

If an ANSI DPC was changed in step 5, use the `dpca` parameter to display the attributes of the DPC.

For this example, enter this command.

```
rtrv-dstn:dpca=007-**-*
```

This is an example of the possible output.

```
rlghncxa03w 05-09-28 21:16:37 GMT EAGLE5 34.0.0
  DPCA          CLLI          BEI ELEI  ALIASI          ALIASN/N24  DOMAIN
  007-**-*      ----- yes  --- -----          ----- SS7
                                     SPC          NCAI
                                     ----- no
```

```
Destination table is (14 of 2000) 1% full
Alias table is (18 of 8000) 1% full
```

7. Back up the new changes, using the `chg-db:action=backup:dest=fixed` command. These messages should appear; the active Maintenance and Administration Subsystem Processor (MASP) appears first.

```
BACKUP (FIXED) : MASP A - Backup starts on active MASP.
BACKUP (FIXED) : MASP A - Backup on active MASP to fixed disk complete.
BACKUP (FIXED) : MASP A - Backup starts on standby MASP.
BACKUP (FIXED) : MASP A - Backup on standby MASP to fixed disk complete.
```

Flowchart 2-10. Adding a Network Routing Point Code (Sheet 1 of 3)

NOTE: Before executing this procedure, make sure you have purchased the network routing feature. If you are not sure if you have purchased the network routing feature, contact your Tekelec Sales Representative or Account Representative.

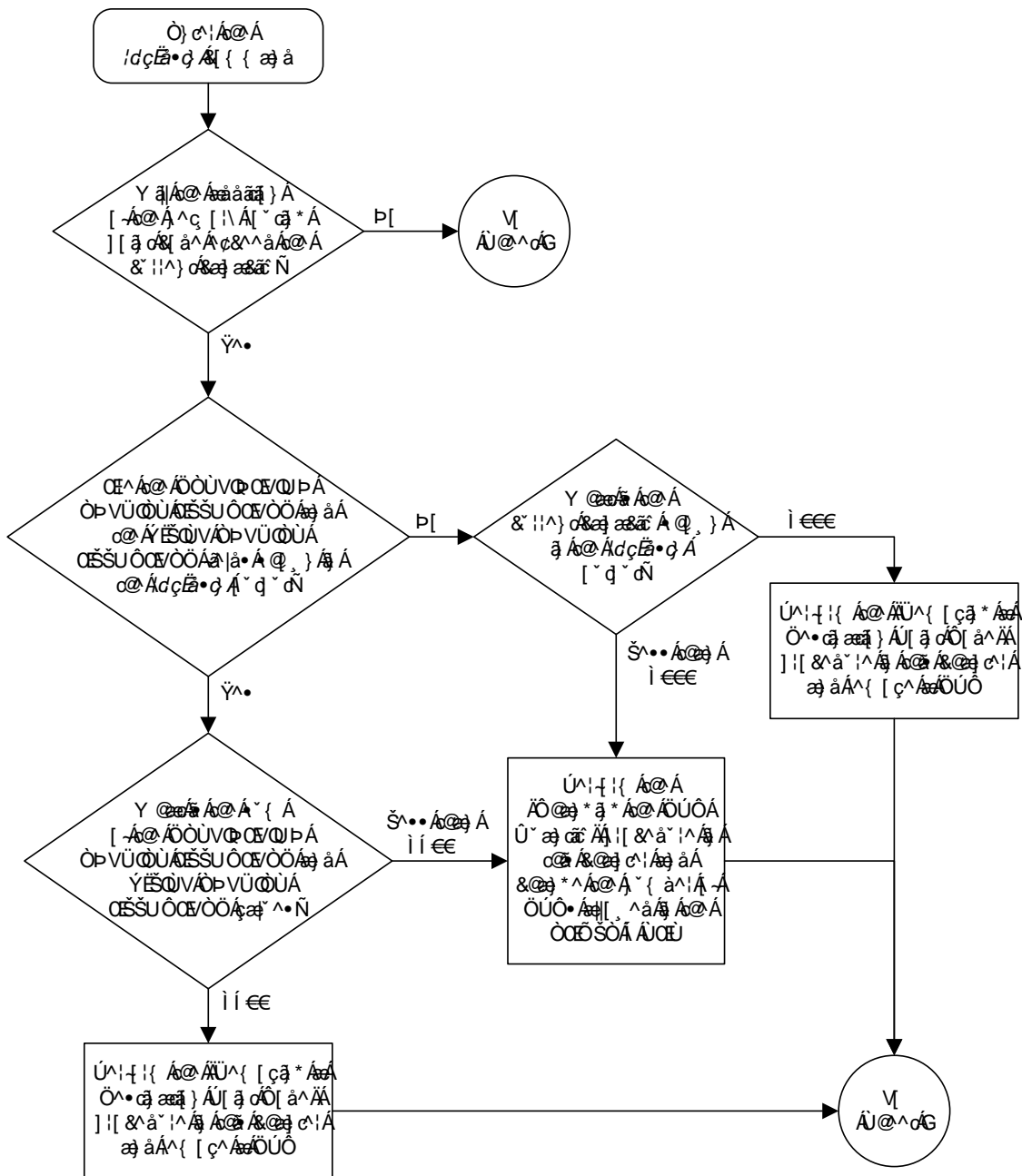

Flowchart 2-10. Adding a Network Routing Point Code (Sheet 2 of 3)

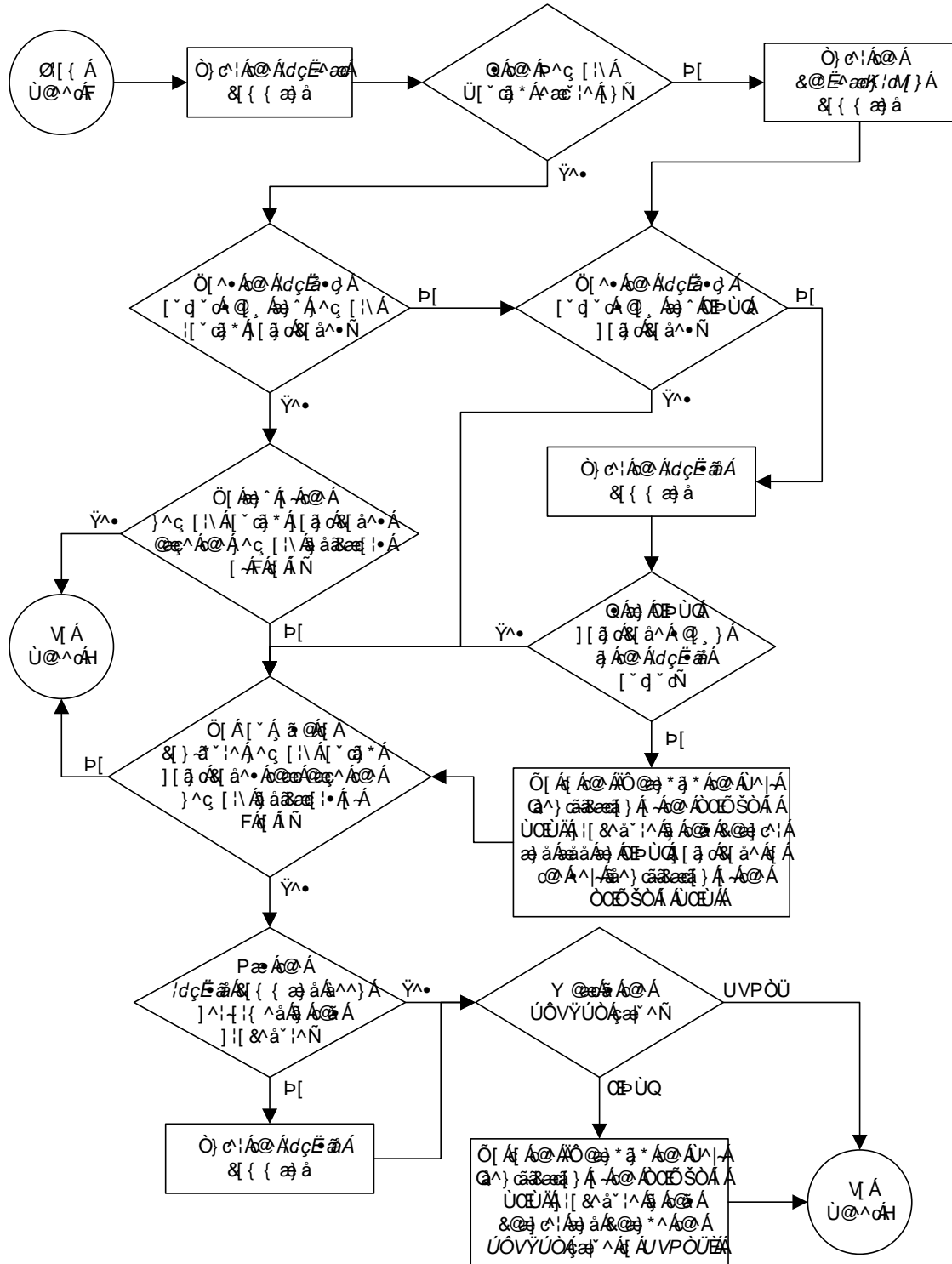

Flowchart 2-10. Adding a Network Routing Point Code (Sheet 3 of 3)

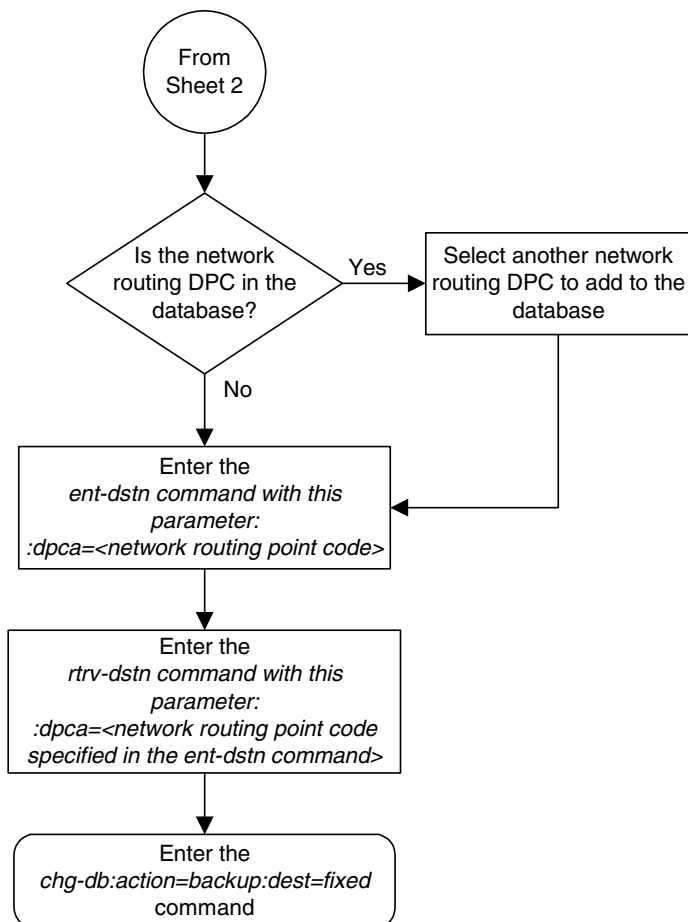

Adding a Destination Point Code

This procedure is used to add a destination point code to the database, using the `ent-dstn` command.

The `ent-dstn` command uses these parameters:

`:dpc/dpca/dpci/dpcn/dpcn24` – The destination point code being added to the database

`:aliasa/aliasi/aliasn/aliasn24` – The alternate destination point code. Two optional alias addresses can be defined.

NOTE: If 7000 or 8000 routesets are enabled, the EAGLE 5 SAS can contain a maximum of 8000 alias point codes. If 7000 or 8000 routesets are not enabled, the EAGLE 5 SAS can contain a maximum of 12000 alias point codes.

NOTE: See “Point Code Formats” on page 2-4 for a definition of the point code types that are used on the EAGLE 5 SAS and for a definition of the different formats that can be used for ITU national point codes. A private point code cannot be used as an alias point code.

`:c11i` – The Common Language Location Identifier assigned to this point code

`:domain` – The network in which the destination entity or node exists, X.25 or SS7

NOTE: Specifying `:domain=x25` is valid only for ANSI destinations.

`:ipgwapc` – IP Gateway Adjacent Point Code indicator. Specify `ipgwapc=yes` to provide SS7 linkset definition compatibility for gateway connections to IP-SCPs. The default is `ipgwapc=no`.

`:bei` – Broadcast exception indicator that indicates whether transfer-prohibited (TFP) messages will be broadcast from this node. The `bei=yes` parameter means TFPs will not be broadcast. The `bei=no` parameter means TFPs will be broadcast.

`:spc/spca/spci/spcn/spcn24` – The secondary point code as defined by the `ent-spc` command. The secondary point code allows the EAGLE 5 SAS to use another point code in addition to the one defined by the `dpc`, `dpca`, `dpci`, `dpcn`, or `dpcn24` parameters of the `ent-dstn` command for SS7 routing purposes. See the “Multiple Point Code Support” section on page 2-55 for more information on secondary point codes. A private point code cannot be used as a secondary point code.

`:e1ei` – For cluster point codes only. Specifies whether or not the EAGLE 5 SAS maintains a dynamic status exception list for each cluster route that may be used to reach the member signaling points making up the cluster.

NOTE: See the “Cluster Routing and Management Diversity (CRMD)” section on page 2-119 and the “Adding a Cluster Point Code” procedure on page 2-142 for more information on the cluster routing feature and the `e1ei` parameter.

:ncai – The nested-cluster-allowed indicator specifies whether or not the route to the cluster point code can be different from the route to a point code that is a member of the cluster point code.

NOTE: See the “Nested Cluster Routing” section on page 2-135 and the “Adding a Cluster Point Code” procedure on page 2-142 for more information on the nested cluster routing feature and the **ncai** parameter.

Secondary point codes must be in the SS7 domain and must be a full point code. A secondary point code can only be assigned to a full point code in the SS7 domain. The network type of the secondary point code must match the network type of the DPC. The secondary point code used in this procedure must be configured in the database with the **ent-spc** command. The secondary point codes are shown in the **SPCA**, **SPC-I**, **SPC-N**, and **SPC-N24** fields of the **rtrv-spc** command output. If the desired secondary point code is not shown in the output of the **rtrv-spc** command, go to the “Adding a Secondary Point Code” procedure on page 2-63 and configure the desired point code as a secondary point code.

If the **dpci**, **dpcn**, **dpcn24**, **aliasa**, **aliasi**, **aliasn**, **aliasn24**, or **spc**, **spca**, **spci**, **spcn**, or **spcn24** parameters are specified with the **ent-dstn** command, the domain of the DPC must be SS7 (**domain=ss7**).

To specify the **domain=x25** parameter with the **ent-dstn** command, the X.25 gateway feature must be turned on. Verify this with the **rtrv-feat** command. If the X.25 gateway feature is turned on, the **x25g** field should be set to **on**. If the X.25 gateway feature is not turned on, enter the **chg-feat:x25g=on** command.

NOTE: Once the X.25 gateway feature is turned on with the **chg-feat** command, it cannot be turned off.

For provisioning of SS7IPGW ISUP-CIC routing keys, the **ipgwapc=yes** parameter and the IP Gateway ISUP routing feature must be turned on. Verify this with the **rtrv-feat** command. If the IP Gateway ISUP routing feature is turned on, the **ipisup** field should be set to **on**. If the IP Gateway ISUP routing feature is not turned on, enter the **chg-feat:ipisup=on** command.

NOTE: Once the IP Gateway ISUP routing feature is turned on with the **chg-feat** command, it cannot be turned off.

NOTE: The SS7IPGW application applies to ANSI networks only.

The value of the **c11i** parameter cannot be in the DPC table and cannot match the CLI of the EAGLE 5 SAS. Verify this by entering the **rtrv-dstn** and the **rtrv-sid** commands, shown in steps 1 and 5 of the procedure that follows. If the value of the **c11i** parameter matches any CLI values in either of these outputs, choose another value for the **c11i** parameter that does not match any CLIs shown in either of these command outputs.

Configuring Destination Tables

To enter point codes of any network type (ANSI, ITU-I, 14-bit ITU-N, or 24-bit ITU-N) into the database with the `ent-dstn` command, the self ID of the EAGLE 5 SAS must be defined for these networks. Verify this with the `rtrv-sid` command.

If a point code value is shown in the `PCA` column of the `rtrv-sid` command, then ANSI point codes can be specified with the `ent-dstn` command.

If a point code value is shown in the `PCI` column of the output of the `rtrv-sid` command, then ITU-I point codes can be specified with the `ent-dstn` command. The `PCI` column of the `rtrv-sid` output can contain spare and non-spare point code values. To provision ITU-I non-spare point codes in this procedure, the `rtrv-sid` output must contain an ITU-I non-spare point code in the `PCI` column. To provision ITU-I spare point codes in this procedure, the `rtrv-sid` output must contain an ITU-I spare point code in the `PCI` column.

If a point code value is shown in the `PCN` column of the output of the `rtrv-sid` command, then 14-bit ITU-N point codes can be specified with the `ent-dstn` command. The `PCN` column of the `rtrv-sid` output can contain spare and non-spare point code values. To provision 14-bit ITU-N non-spare point codes in this procedure, the `rtrv-sid` output must contain a 14-bit ITU-N non-spare point code in the `PCN` column. To provision 14-bit ITU-N spare point codes in this procedure, the `rtrv-sid` output must contain a 14-bit ITU-N spare point code in the `PCN` column.

If a point code value is shown in the `PCN24` column of the output of the `rtrv-sid` command, then 24-bit ITU-N point codes can be specified with the `ent-dstn` command.

If no values are shown in the `PCA`, `PCI`, `PCN`, or `PCN24` columns in the `rtrv-sid` command output, the self-identification of the EAGLE 5 SAS must be updated with an ANSI point code, ITU international point code, 14-bit ITU national point code, or a 24-bit ITU national point code. Go to “Adding a Point Code to the Self-Identification of the EAGLE 5 SAS” procedure on page 2-81 to add the necessary point codes to the self-identification of the EAGLE 5 SAS.

NOTE: The EAGLE 5 SAS can contain 14-bit ITU national point codes or 24-bit ITU national point codes, but both at the same time.

Private point codes cannot be specified in the self-identification of the EAGLE 5 SAS, therefore, private point codes can be added as long as the self identification of the EAGLE 5 SAS contains a point code with the same network type as the private point code being added in this procedure. The ITU National and International Spare Point Code Support feature does not have to be enabled to add a private point code.

If the alias point code parameters **aliasa**, **aliasi**, **aliasn**, or **aliasn24** are specified with the **ent-dstn** command, the aliases must be of a different point code type than the true point code. For example, if the **dpca** parameter is specified, then only the **aliasi**, **aliasn**, or **aliasn24** parameters can be specified. The **aliasa** parameter cannot be specified. Table 2-11 shows which alias parameters can be specified with the destination point code parameters.

Table 2-11. Destination Point Code and Alias Parameter Combinations

Destination Point Code Parameters	Alias Point Code Parameters
dpc/dpca	aliasi, aliasn/aliasn24*
dpci	aliasa, aliasn/aliasn24*
dpcn/dpcn24*	aliasa, aliasi
* The EAGLE 5 SAS can contain 14-bit ITU national point codes or 24-bit ITU national point codes, but both at the same time.	

Alias point codes can only be specified for full point code entries, and must be full point codes.

ANSI alias point codes cannot be a member of a cluster point code that is already in the database. A point code is a member of a cluster point code if it has the same network identifier (NI) and network cluster (NC) values as the cluster point code.

Destination point codes and alias point codes must be unique in the database. A point code can be defined as a true destination point code, an alias point code, the self ID of the EAGLE 5 SAS, or the capability point code of the EAGLE 5 SAS. The self IDs and capability point codes of the EAGLE 5 SAS can be verified with the **rtrv-sid** command.

If the X.25 destination point code is a member of a cluster, the value of the **bei** parameter for the X.25 destination point code is not changed to the value of the **bei** parameter of the cluster, but the value of the **bei** parameter of the cluster determines the behavior of the X.25 destination point code as long as the cluster remains in the DPC table. If this cluster is removed from the DPC table, the X.25 destination behaves as it is configured with the **ent-dstn** command. For example, if the X.25 destination point code, 002-002-002, is a member of the cluster 002-002-*, the **bei** parameter of the cluster is set to **yes**, and the **bei** parameter of the X.25 destination point code is set to **no**, the X.25 destination point code behaves as if the **bei** parameter is set to **yes**. If the cluster 002-002-* is removed from the database, the **bei** parameter of the X.25 destination point code is set to **no** and the X.25 destination point code broadcasts TFP and TFA messages to adjacent nodes.

Configuring Destination Tables

If you intend to use an X.25 destination point code with an X.25 route that has the `lc2nm` parameter set to `yes`, make sure that the `bei` parameter of the cluster containing the X.25 destination point code is set to `no`. Verify the value of the `bei` parameter of the cluster with the `rtrv-dstn` command. To change the existing value the `bei` parameter, go to the “Changing a Destination Point Code” procedure on page 2-226.

For X.25 destination point codes or members of a cluster that have the value of the `bei` parameter set to `yes`, the default value of the `bei` parameter is `yes`. For cluster destination point codes, or members of a cluster that have the value of the `bei` parameter set to `no`, the default value of the `bei` parameter is `no`.

The `elei` (exception list exclusion indicator) parameter can be specified only for a cluster destination point code. Cluster destination point codes and the `elei` parameter can be specified only if the Cluster Routing and Management Diversity feature is turned on. Verify this with the `rtrv-feat` command. If the Cluster Routing and Management Diversity feature is turned on, the `CRMD` field should be set to `on`. If the Cluster Routing and Management Diversity feature is not turned on, enter the `chg-feat:crmd=on` command. For more information on the Cluster Routing and Management Diversity feature, go to the “Cluster Routing and Management Diversity (CRMD)” section on page 2-119.

NOTE: Once the Cluster Routing and Management Diversity feature is turned on with the `chg-feat` command, it cannot be turned off.

If the `PCTYPE` field of the `rtrv-sid` command output contains the entry `ANSI`, and the network value of the destination point code specified by the `ent-dstn` command is from 0 to 5, the cluster value of that point code must be from 1 to 255. If the network value of that point code is from 6 to 255, the cluster value of that point code must be from 0 to 255.

The actual number of destination point codes that can be configured in the database is set by the `mtpdpcq` parameter of the `chg-stpopts` command, and is shown in the `MTPDPCQ` field in the `rtrv-stpopts` command output.

If the 5000 Routes feature is not on, and 6000, 7000, or 8000 routesets are not enabled, a maximum of 2000 destination point codes can be configured in the database.

If the 5000 Routes feature is on, and 6000, 7000, or 8000 routesets are not enabled, a maximum of 5000 destination point codes can be configured in the database.

If 6000 routesets are enabled, a maximum of 6000 destination point codes can be configured in the database.

If 7000 routesets are enabled, a maximum of 7000 destination point codes can be configured in the database.

If 8000 routesets are enabled, a maximum of 8000 destination point codes can be configured in the database.

NOTE: For more information on the destination point code quantities, go to the “Changing the DPC Quantity” procedure on page 2-23.

If ITU-N point codes are specified with the `ent-dstn` command, the format of the point code values must match the format shown in the `NPCFMTI` field of the `rtrv-stpopts` command output. For more information, see “14-Bit ITU National Point Code Formats” on page 2-10.

The examples in this procedure are used to add the point code information shown in Table 2-12. The format of the 14-bit ITU national point codes used in these examples is 4-4-4-2.

Table 2-12. Sample Destination Point Code Table Configuration

Type of Point Code	DPC	CLLI	BEI	ALIASA	ALIASI	ALIASN	DOMAIN	SPC
ANSI	240-012-007	-----	yes	-----	1-117-3	10-13-11-1	SS7	001-010-010
	240-012-006	-----	---	-----	-----	-----	SS7	002-010-010
	200-150-100	-----	---	-----	-----	-----	X25	-----
ITU-I	4-163-5	-----	no	250-200-007	-----	15-11-5-1	SS7	2-254-6
ITU-N	7-9-10-1-fr	-----	no	210-090-100	1-75-6	-----	SS7	-----
	7-9-10-1-ge	-----	no	210-100-100	2-175-6	-----	SS7	13-02-12-0-ge

Canceling the `RTRV-DSTN` Command

Because the `rtrv-dstn` command used in this procedure can output information for a long period of time, the `rtrv-dstn` command can be canceled and the output to the terminal stopped. There are three ways that the `rtrv-dstn` command can be canceled:

- Press the **F9** function key on the keyboard at the terminal where the `rtrv-dstn` command was entered
- Enter the `cancel-cmd` without the `trm` parameter at the terminal where the `rtrv-dstn` command was entered
- Enter the `cancel-cmd:trm=<xx>`, where `<xx>` is the terminal where the `rtrv-dstn` command was entered, from another terminal other than the terminal where the `rtrv-dstn` command was entered. To enter the `cancel-cmd:trm=<xx>` command, the terminal must allow Security Administration commands to be entered from it and the user must be allowed to enter Security Administration commands. The terminal's permissions can be verified with the `rtrv-secu-trm` command. The user's permissions can be verified with the `rtrv-user` or `rtrv-secu-user` commands.

For more information about the `cancel-cmd` command, refer to the *Commands Manual*.

Procedure

1. Display the current destination point codes, using the `rtrv-dstn` command. This is an example of the possible output.

```

rlghncxa03w 05-09-17 16:02:05 GMT EAGLE5 34.0.0
  DPCA          CLLI          BEI  ELEI  ALIASI          ALIASN/N24  DOMAIN
001-002-003    ls04clli          yes  ---  -----  -----  SS7
030-045-*      rlghncbb010      yes  yes  -----  -----  SS7
111-011-*      rlghncbb000      yes  yes  -----  -----  SS7
240-012-004    rlghncbb001      yes  ---  1-111-1    10-13-9-3-fr  SS7
240-012-005    rlghncbb002      yes  ---  1-112-2    10-13-10-0-ge  SS7
240-012-006    rlghncbb003      yes  ---  1-112-3    10-13-10-1-fr  SS7
240-012-008    -----          yes  ---  1-113-5    10-13-10-2-ge  SS7
244-020-004    ls06clli          yes  ---  -----  -----  X25
244-020-005    ls07clli          yes  ---  -----  -----  X25
244-020-006    ls08clli          yes  ---  -----  -----  X25
244-020-007    -----          yes  ---  -----  -----  X25
244-020-008    -----          yes  ---  -----  -----  X25

  DPCI          CLLI          BEI  ELEI  ALIASA          ALIASN/N24  DOMAIN
2-131-1        rlghncbb023      no   ---  222-210-000  11-11-8-1-ge  SS7
2-131-2        -----          no   ---  222-211-001  11-11-8-2-fr  SS7
2-131-3        -----          no   ---  222-211-002  11-11-8-3-ge  SS7

  DPCN          CLLI          BEI  ELEI  ALIASA          ALIASI        DOMAIN
10-15-2-3-fr  rlghncbb013      no   ---  222-200-200  2-121-1       SS7
10-15-2-3-ge  rlghncbb013      no   ---  222-100-200  2-100-1       SS7
10-15-3-0-fr  rlghncbb013      no   ---  222-200-201  2-121-2       SS7
10-15-3-0-ge  rlghncbb013      no   ---  222-100-201  2-100-2       SS7

  DPCN24        CLLI          BEI  ELEI  ALIASA          ALIASI        DOMAIN
DESTINATION ENTRIES ALLOCATED:  2000
  FULL DPC(s) :                18
  NETWORK DPC(s) :              0
  CLUSTER DPC(s) :              2
  TOTAL DPC(s) :                20
  CAPACITY (% FULL) :           1%
ALIASES ALLOCATED:              8000
  ALIASES USED:                 22
  CAPACITY (% FULL) :           1%
X-LIST ENTRIES ALLOCATED:       500
RTRV-DSTN: MASP A - COMPLTD
  
```

If the addition of the destination point code will not exceed the current DPC capacity shown in the `rtrv-dstn` output, go to step 2.

If the addition of the destination point code will exceed the current DPC capacity, and the current capacity is less than 8000 (or 8500 if the **DESTINATION ENTRIES ALLOCATED** and **X-LIST ENTRIES ALLOCATED** fields are shown in the `rtrv-dstn` output), perform the “Changing the DPC Quantity” procedure on page 2-23 to change the DPC quantity. Then go to step 2.

If the addition of the destination point code will exceed the current DPC capacity, and the current capacity is 8000 (or 8500 if the **DESTINATION ENTRIES ALLOCATED** and **X-LIST ENTRIES ALLOCATED** fields are shown in the `rtrv-dstn` output), perform the “Removing a Destination Point Code” procedure on page 2-214 to remove a DPC. Then go to step 2.

NOTE: If the `rtrv-dstn` command output in step 1 shows the type of point code being added in this procedure, ANSI (DPCA field), ITU-I or ITU-I Spare (DPCI field), 14-bit ITU-N or 14-bit ITU-N Spare (DPCN), or 24-bit ITU-N (DPCN24 field) point codes, or if the `clli` or `spc` parameters are not being used in this procedure, skip step 2 and go to step 3.

2. Display the self-identification of the EAGLE 5 SAS using the `rtrv-sid` command. This is an example of the possible output.

```
rlghncxa03w 05-09-10 11:43:04 GMT EAGLE5 34.0.0
  PCA          PCI          PCN          CLLI          PCTYPE
  100-100-100  3-75-7          7-9-8-1-fr   rlghncxa03w   OTHER

  CPCA
  002-002-002  002-002-003    002-002-004  002-002-005
  002-002-006  002-002-007    002-002-008  002-002-009
  004-002-001  004-003-003    050-060-070

  CPCA (LNP)
  005-005-002  005-005-004    005-005-005

  CPCI
  1-002-1      1-002-2        1-002-3      1-002-4
  2-001-1      7-222-7

  CPCN
  2-0-10-3-fr  2-0-11-0-fr    2-0-11-2-fr  2-0-12-1-fr
  2-2-3-3-fr  2-2-4-0-fr     10-14-10-1-fr
```

To enter an ANSI point code with the `ent-dstn` command, a ANSI point code must be shown in the `PCA` field of the `rtrv-sid` output.

To enter an ITU-I non-spare point code with the `ent-dstn` command, an ITU-I non-spare point code must be shown in the `PCI` field of the `rtrv-sid` output.

To enter an ITU-I spare point code with the `ent-dstn` command, an ITU-I spare point code must be shown in the `PCI` field of the `rtrv-sid` output.

To enter a 14-bit ITU-N non-spare point code with the `ent-dstn` command, a 14-bit non-spare point code must be shown in the `PCN` field of the `rtrv-sid` output. To enter a 14-bit ITU-N spare point code with the `ent-dstn` command, a 14-bit ITU-N spare point code must be shown in the `PCN` field of the `rtrv-sid` output. If 14-bit ITU-N point codes (spare or non-spare point codes) with group codes are being provisioned in this procedure, the point code value in the `PCN` field must have a group code assigned to it.

To enter a 24-bit ITU-N point code with the `ent-dstn` command, a point code must be shown in the `PCN24` field of the `rtrv-sid` output.

If the required point code is not shown in the `PCA`, `PCI`, `PCN`, or `PCN24` fields of the `rtrv-sid` command output, go to the “Adding a Point Code to the Self-Identification of the EAGLE 5 SAS” procedure on page 2-81 and provision the required point codes. If 14-bit ITU-N point codes with group codes are being provisioned in this procedure, make sure the 14-bit ITU-N

point code provisioned in the “Adding a Point Code to the Self-Identification of the EAGLE 5 SAS” procedure has a group code assigned to it.

NOTE: The EAGLE 5 SAS can contain 14-bit ITU national point codes or 24-bit ITU national point codes, but both at the same time.

NOTE: If the `spc`, `spca`, `spci`, or `spcn` parameters are not being used in this procedure, skip step 3 and go to step 4.

NOTE: To assign group codes to 14-bit ITU-N point codes, the group code must be shown in the `rtrv-sid`, `rtrv-dstn`, or `rtrv-spc` outputs. If the group code you wish to use is not shown in the `rtrv-dstn` output (step 1) or the `rtrv-sid` output (step 2), perform step 3 to verify that the group code is assigned to a secondary point code. If the desired group code is shown in steps 1 or 2, skip step 3 and go to step 4.

3. Display the secondary point codes in the database with the `rtrv-spc` command. This is an example of the possible output.

```
rlghncxa03w 05-09-17 16:02:05 GMT EAGLE5 34.0.0
SPC (Secondary Point Codes)
```

```
SPCA
```

```
001-010-010
002-010-010
003-010-010
010-100-010
```

```
SPC-I
```

```
1-253-5
2-254-6
3-255-7
4-100-1
```

```
SPC-N
```

```
10-1-11-1-ge
13-2-12-0-ge
14-15-12-1-ge
```

```
SPC-N24
```

```
none
```

```
Secondary Point Code table is (11 of 40) 28% full
```

If the desired secondary point code is not shown in the `rtrv-spc` command output, go to the “Adding a Secondary Point Code” procedure on page 2-63 and add the secondary point code to the database.

NOTE: If ITU-N point codes are not being used in this procedure, skip step 4 and go to step 5.

4. Display the existing values for the `npcfmti` parameter by entering the `rtrv-stpopts` command. The value for the `npcfmti` parameter is shown in the `NPCFMTI` field. This is an example of the possible output.

```
rlghncxa03w 05-09-17 16:02:05 GMT EAGLE5 34.0.0
STP OPTIONS
-----
NPCFMTI          4-4-4-2
```

NOTE: The `rtrv-stpopts` command output contains other fields that are not used by this procedure. If you wish to see all the fields displayed by the `rtrv-stpopts` command, see the `rtrv-stpopts` command description in the *Commands Manual*.

If you wish to change the format of the 14-bit ITU national point codes, go to “14-Bit ITU National Point Code Formats” section on page 2-10. Changing the formats of the 14-bit ITU national point codes will change how any existing 14-bit ITU national point codes are displayed in the database.

NOTE: If the domain of the DPC is to be SS7, or if the `rtrv-dstn` command output in step 1 shows X.25 point codes, (the entry `x25` is in the `DOMAIN` field), skip steps 5 and 6, and go to step 9.

5. Verify that the X.25 gateway feature is on, by entering the `rtrv-feat` command. If the X.25 gateway feature is on, the `x25g` field should be set to `on`. For this example, the X.25 gateway feature is off.

NOTE: The `rtrv-feat` command output contains other fields that are not used by this procedure. If you wish to see all the fields displayed by the `rtrv-feat` command, see the `rtrv-feat` command description in the *Commands Manual*.

If the X.25 gateway feature is on, skip step 5 and go to step 6.

6. If the X.25 gateway feature is not on, shown by the `x25g = off` entry in the `rtrv-feat` command output in step 5, turn the X.25 gateway feature on by entering this command.

```
chg-feat:x25g=on
```

NOTE: Once the X.25 gateway feature is turned on with the `chg-feat` command, it cannot be turned off.

The X.25 gateway feature must be purchased before you turn this feature on with the `chg-feat` command. If you are not sure if you have purchased the X.25 gateway feature, contact your Tekelec Sales Representative or Account Representative.

When the `chg-feat` has successfully completed, this message should appear.

```
rlghncxa03w 05-09-07 00:57:31 GMT EAGLE5 34.0.0
CHG-FEAT: MASP A - COMPLTD
```

Configuring Destination Tables

NOTE: If alias point codes are not being provisioned in this procedure, skip steps 7 and 8, and go to step 9.

NOTE: If the DPC quantity shown in the `rtrv-dstn` output in step 1 is from 6001 to 8000, skip step 7 and go to step 8.

7. Verify that either 6000, 7000, or 8000 routesets are enabled by entering the `rtrv-ctrl-feat` command. The following is an example of the possible output.

```
rlghncxa03w 05-09-28 21:15:37 GMT EAGLE5 34.0.0
The following features have been permanently enabled:
```

Feature Name	Partnum	Status	Quantity
IPGWx Signaling TPS	893012814	on	20000
ISUP Normalization	893000201	on	----
Command Class Management	893005801	on	----
LNP Short Message Service	893006601	on	----
Intermed GTT Load Sharing	893006901	on	----
XGTT Table Expansion	893006101	on	4000000
XMAP Table Expansion	893007710	on	3000
Large System # Links	893005901	on	1500
Routesets	893006401	on	6000
HC-MIM SLK Capacity	893012707	on	64

The following features have been temporarily enabled:

Feature Name	Partnum	Status	Quantity	Trial Period Left
Zero entries found.				

The following features have expired temporary keys:

Feature Name	Partnum
Zero entries found.	

8. The number of routesets that are enabled is shown in the `rtrv-ctrl-feat` output in step 7 with the quantity of 6000, 7000, or 8000 in the **Routesets** row. If 6000, 7000, or 8000 routesets are not enabled, the EAGLE 5 SAS can contain a maximum of either 2000 or 5000 routesets. The routeset quantity enabled is also shown by the DPC quantity in the `rtrv-dstn` output in step 1. If the DPC quantity is from 6001 to 8000, either 7000 or 8000 routesets have been enabled.

If 7000 or 8000 routesets are enabled, the EAGLE 5 SAS can contain a maximum of 8000 alias point codes. If 7000 or 8000 routesets are not enabled, the EAGLE 5 SAS can contain a maximum of 12000 alias point codes.

If the alias point code being added will exceed the maximum number of alias point codes the EAGLE 5 SAS is allowed to have, other alias point codes will have to be removed before this alias point code can be added. Perform the "Changing a Destination Point Code" procedure on page 2-226 to remove alias point codes. Then go to step 9 to add the destination point code with an alias point code. If you do not wish to remove other alias point codes, do not perform the "Changing a Destination Point Code" procedure on page 2-226. Go to step 9 to add the destination point code without an alias point code.

If the alias point code being added will not exceed the maximum number of alias point codes the EAGLE 5 SAS is allowed to have, go to step 9 to add the destination point code with an alias point code.

9. Add the destination point code, using the `ent-dstn` command. For this example, enter these commands based on the information shown in Table 2-12 on page 2-196.

```
ent-dstn:dpca=240-012-007:bei=yes:aliasi=1-117-3
:aliasn=10-13-11-1-fr:domain=ss7:spca=001-010-010
ent-dstn:dpca=240-012-006:spca=002-010-010
ent-dstn:dpca=200-150-100:domain=x25
ent-dstn:dpci=4-163-5:bei=no:aliasa=250-200-007
:domain=ss7:spci=2-254-6
ent-dstn:dpcn=7-9-10-1-fr:bei=no:aliasa=210-090-100
:aliasi=1-75-6:domain=ss7
ent-dstn:dpcn=7-9-10-1-ge:bei=no:aliasa=210-100-100
:aliasi=2-175-6:domain=ss7:spcn=13-02-12-0-ge
```

When each of these commands has successfully completed, and the Cluster Routing and Management Diversity feature is turned off (shown with the `CRMD = off` entry in the `rtrv-feat` command output), this message should appear.

```
rlghncxa03w 05-09-17 15:35:05 GMT EAGLE5 34.0.0
Destination table is (26 of 2000) 1% full
ENT-DSTN: MASP A - COMPLTD
```

If the Cluster Routing and Management Diversity feature is turned on (`CRMD = on` in the `rtrv-feat` command output), this message should appear when each command has successfully completed.

```
rlghncxa03w 05-09-17 15:35:05 GMT EAGLE5 34.0.0
DESTINATION ENTRIES ALLOCATED: 2000
  FULL DPC(s): 24
  NETWORK DPC(s): 0
  CLUSTER DPC(s): 2
  TOTAL DPC(s): 26
  CAPACITY (% FULL): 1%
ALIASES ALLOCATED: 8000
  ALIASES USED: 27
  CAPACITY (% FULL): 1%
X-LIST ENTRIES ALLOCATED: 500
ENT-DSTN: MASP A - COMPLTD
```

Configuring Destination Tables

10. Verify the changes using the **rtrv-dstn** command with the **dpca** parameter, and specifying the DPC that was entered in step 9.

For this example, enter these commands.

```
rtrv-dstn:dpca=240-012-007
```

This is an example of the possible output.

```
rlghncxa03w 05-09-28 21:16:37 GMT EAGLE5 34.0.0
  DPCA          CLLI          BEI ELEI  ALIASI          ALIASN/N24  DOMAIN
  240-012-007  ----- yes ---  1-117-3          10-13-11-1-fr SS7
```

```
          SPC          NCAI
          001-010-010  no
```

```
DESTINATION ENTRIES ALLOCATED:  2000
  FULL DPC(s):                    24
  NETWORK DPC(s):                  0
  CLUSTER DPC(s):                  2
  TOTAL DPC(s):                    26
  CAPACITY (% FULL):               1%
ALIASES ALLOCATED:                8000
  ALIASES USED:                    27
  CAPACITY (% FULL):               1%
X-LIST ENTRIES ALLOCATED:         500
RTRV-DSTN: MASP A - COMPLTD
```

```
rtrv-dstn:dpca=240-012-006
```

This is an example of the possible output.

```
rlghncxa03w 05-09-28 21:16:37 GMT EAGLE5 34.0.0
  DPCA          CLLI          BEI ELEI  ALIASI          ALIASN/N24  DOMAIN
  240-012-006  rlghncbb003 yes ---  1-112-3          10-13-10-1-fr SS7
```

```
          SPC          NCAI
          002-010-010  no
```

```
DESTINATION ENTRIES ALLOCATED:  2000
  FULL DPC(s):                    24
  NETWORK DPC(s):                  0
  CLUSTER DPC(s):                  2
  TOTAL DPC(s):                    26
  CAPACITY (% FULL):               1%
ALIASES ALLOCATED:                8000
  ALIASES USED:                    27
  CAPACITY (% FULL):               1%
X-LIST ENTRIES ALLOCATED:         500
RTRV-DSTN: MASP A - COMPLTD
```

```
rtrv-dstn:dpca=200-150-100
```

This is an example of the possible output.

```
rlghncxa03w 05-09-28 21:16:37 GMT EAGLE5 34.0.0
  DPCA          CLLI          BEI ELEI  ALIASI          ALIASN/N24  DOMAIN
  200-150-100  ----- yes --- -----  ----- X25
```

```
          SPC          NCAI
          -----  no
```

```
Destination table is (26 of 2000) 1% full
```

rtrv-dstn:dpci=4-163-5

This is an example of the possible output.

```
rlghncxa03w 05-09-28 21:16:37 GMT EAGLE5 34.0.0
  DPCI          CLLI          BEI  ELEI  ALIASA          ALIASN/N24  DOMAIN
  4-163-5      -----  no   ---   250-200-007  -----  SS7

                SPC          NCAI
                2-254-6      no

DESTINATION ENTRIES ALLOCATED:  2000
  FULL DPC(s) :                   24
  NETWORK DPC(s) :                  0
  CLUSTER DPC(s) :                  2
  TOTAL DPC(s) :                   26
  CAPACITY (% FULL) :               1%
ALIASES ALLOCATED:                8000
  ALIASES USED:                    27
  CAPACITY (% FULL) :               1%
X-LIST ENTRIES ALLOCATED:         500
RTRV-DSTN: MASP A - COMPLTD
```

rtrv-dstn:dpcn=7-9-10-1-fr

This is an example of the possible output.

```
rlghncxa03w 05-09-28 21:16:37 GMT EAGLE5 34.0.0
  DPCN          CLLI          BEI  ELEI  ALIASA          ALIASI          DOMAIN
  7-9-10-1-fr  -----  no   ---   210-090-100  1-75-6          SS7

                SPC          NCAI
                -----  no

DESTINATION ENTRIES ALLOCATED:  2000
  FULL DPC(s) :                   24
  NETWORK DPC(s) :                  0
  CLUSTER DPC(s) :                  2
  TOTAL DPC(s) :                   26
  CAPACITY (% FULL) :               1%
ALIASES ALLOCATED:                8000
  ALIASES USED:                    27
  CAPACITY (% FULL) :               1%
X-LIST ENTRIES ALLOCATED:         500
RTRV-DSTN: MASP A - COMPLTD
```

Configuring Destination Tables

rtrv-dstn:dpcn=7-9-10-1-ge

This is an example of the possible output.

```
rlghncxa03w 05-09-28 21:16:37 GMT EAGLE5 34.0.0
DPCN          CLLI          BEI  ELEI  ALIASA          ALIASI          DOMAIN
7-9-10-1-ge  -----  no   ---   210-100-100    2-175-6         SS7

                SPC          NCAI
                13-02-12-0-ge no

DESTINATION ENTRIES ALLOCATED:  2000
FULL DPC(s):                    24
NETWORK DPC(s):                  0
CLUSTER DPC(s):                  2
TOTAL DPC(s):                    26
CAPACITY (% FULL):               1%
ALIASES ALLOCATED:               8000
ALIASES USED:                     27
CAPACITY (% FULL):               1%
X-LIST ENTRIES ALLOCATED:        500
RTRV-DSTN: MASP A - COMPLTD
```

- 11. Back up the new changes, using the `chg-db:action=backup:dest=fixed` command. These messages should appear; the active Maintenance and Administration Subsystem Processor (MASP) appears first.**

```
BACKUP (FIXED) : MASP A - Backup starts on active MASP.
BACKUP (FIXED) : MASP A - Backup on active MASP to fixed disk complete.
BACKUP (FIXED) : MASP A - Backup starts on standby MASP.
BACKUP (FIXED) : MASP A - Backup on standby MASP to fixed disk complete.
```

Flowchart 2-11. Adding a Destination Point Code (Sheet 1 of 8)

NOTE: If you plan to provision X.25 point codes using this procedure, before executing this procedure, make sure you have purchased the X.25 gateway feature. If you are not sure if you have purchased the X.25 gateway feature, contact your Tekelec Sales Representative or Account Representative.

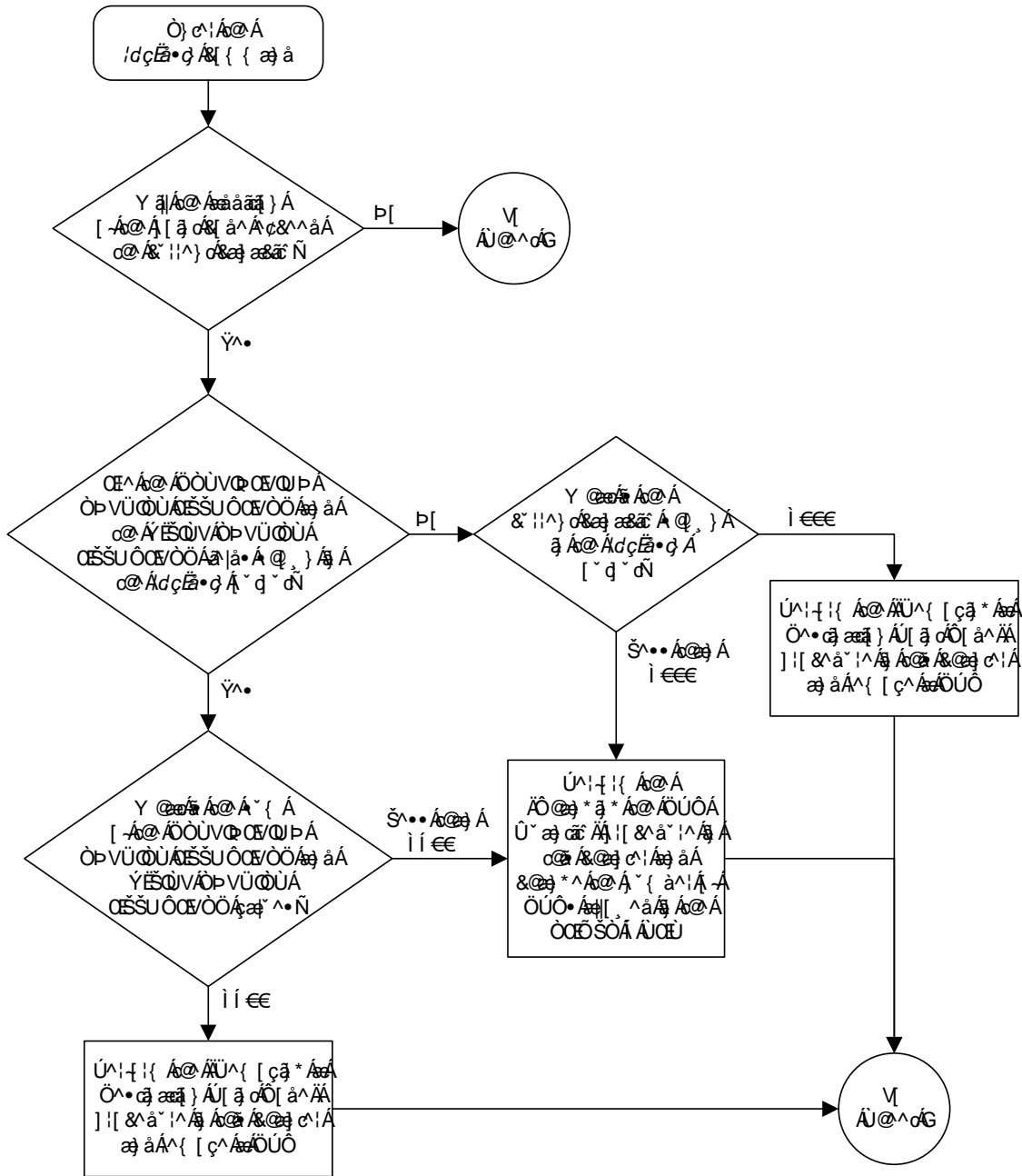

Configuring Destination Tables

Flowchart 2-11. Adding a Destination Point Code (Sheet 2 of 8)

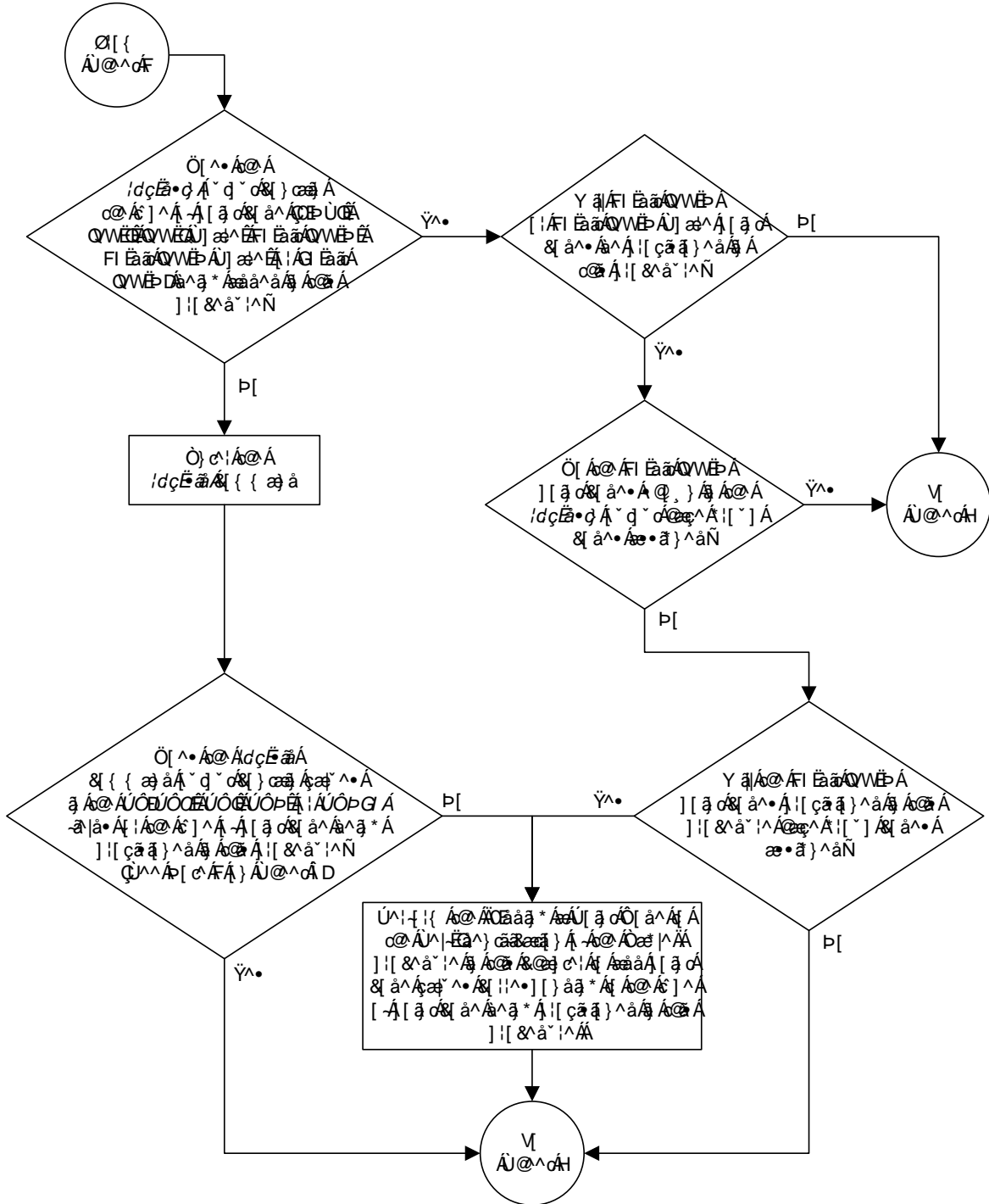

Flowchart 2-11. Adding a Destination Point Code (Sheet 3 of 8)

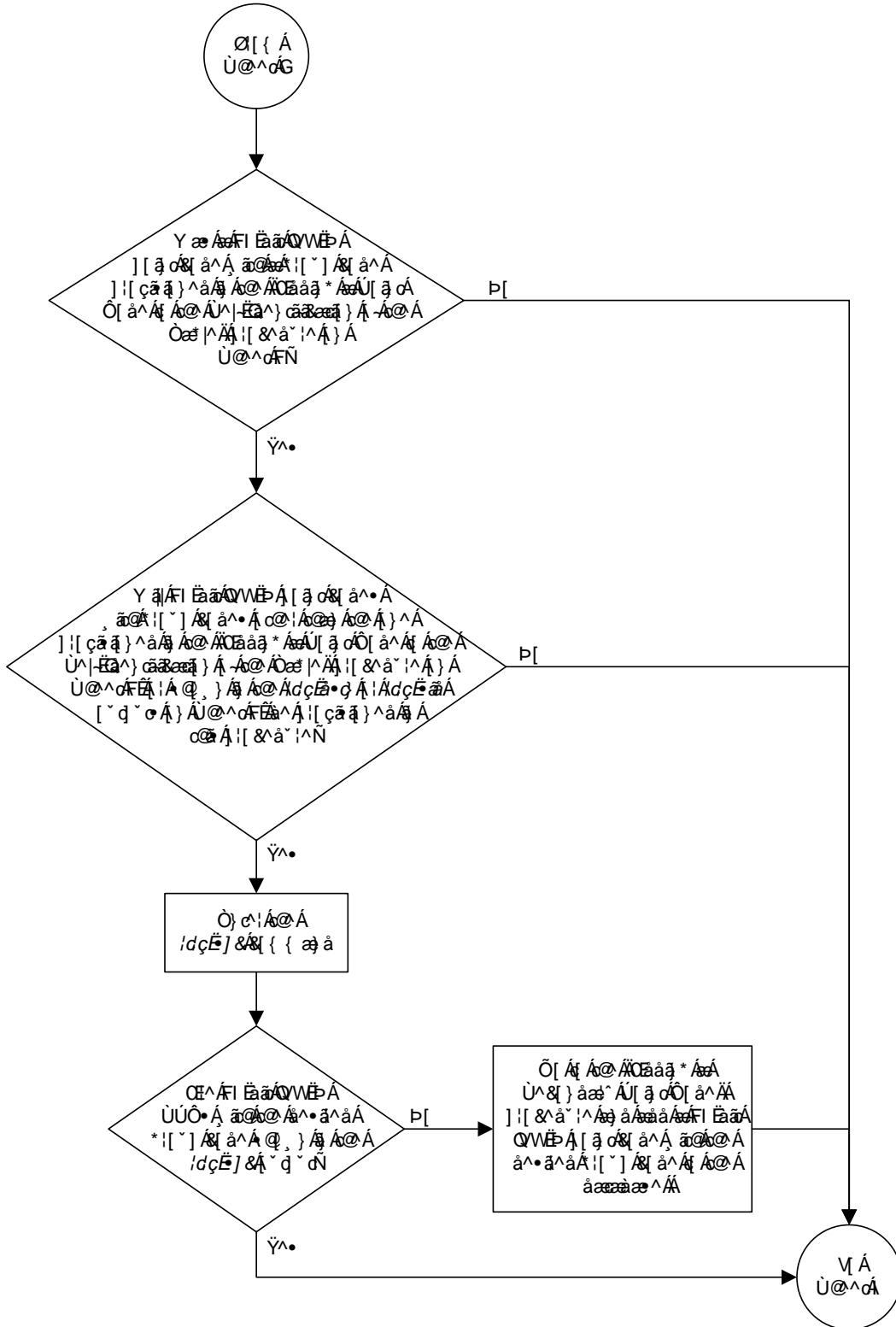

Flowchart 2-11. Adding a Destination Point Code (Sheet 4 of 8)

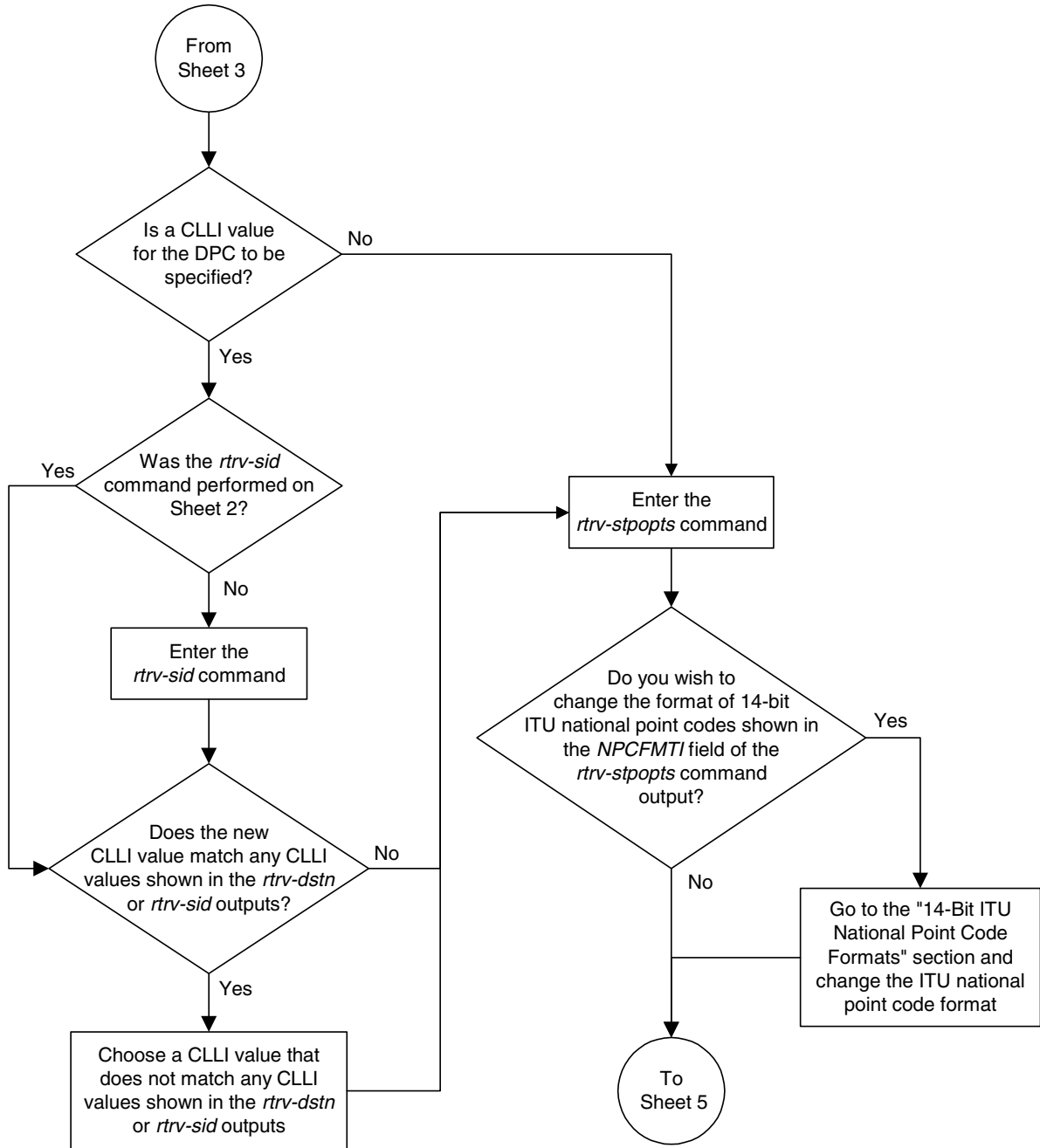

Flowchart 2-11. Adding a Destination Point Code (Sheet 5 of 8)

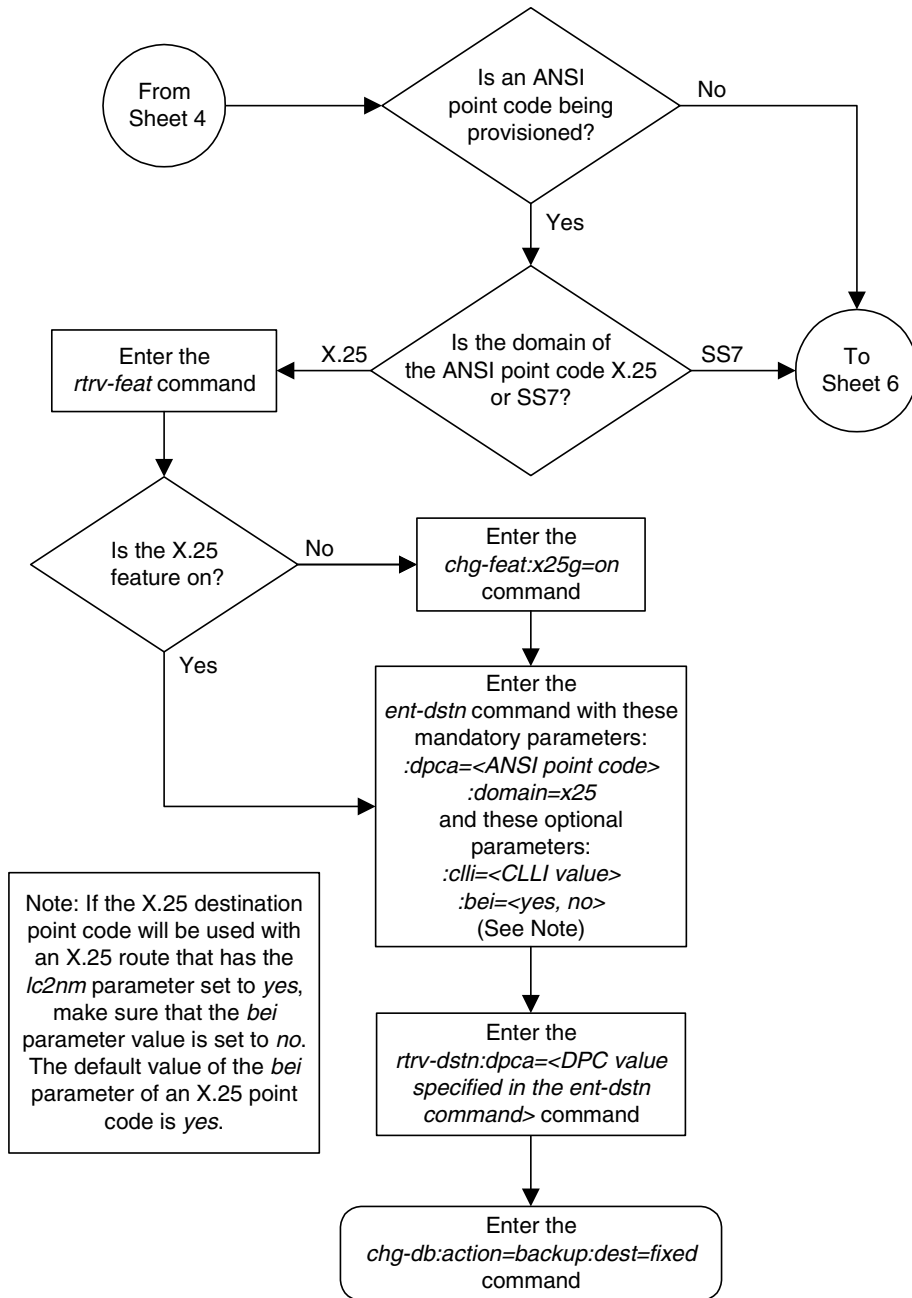

Flowchart 2-11. Adding a Destination Point Code (Sheet 6 of 8)

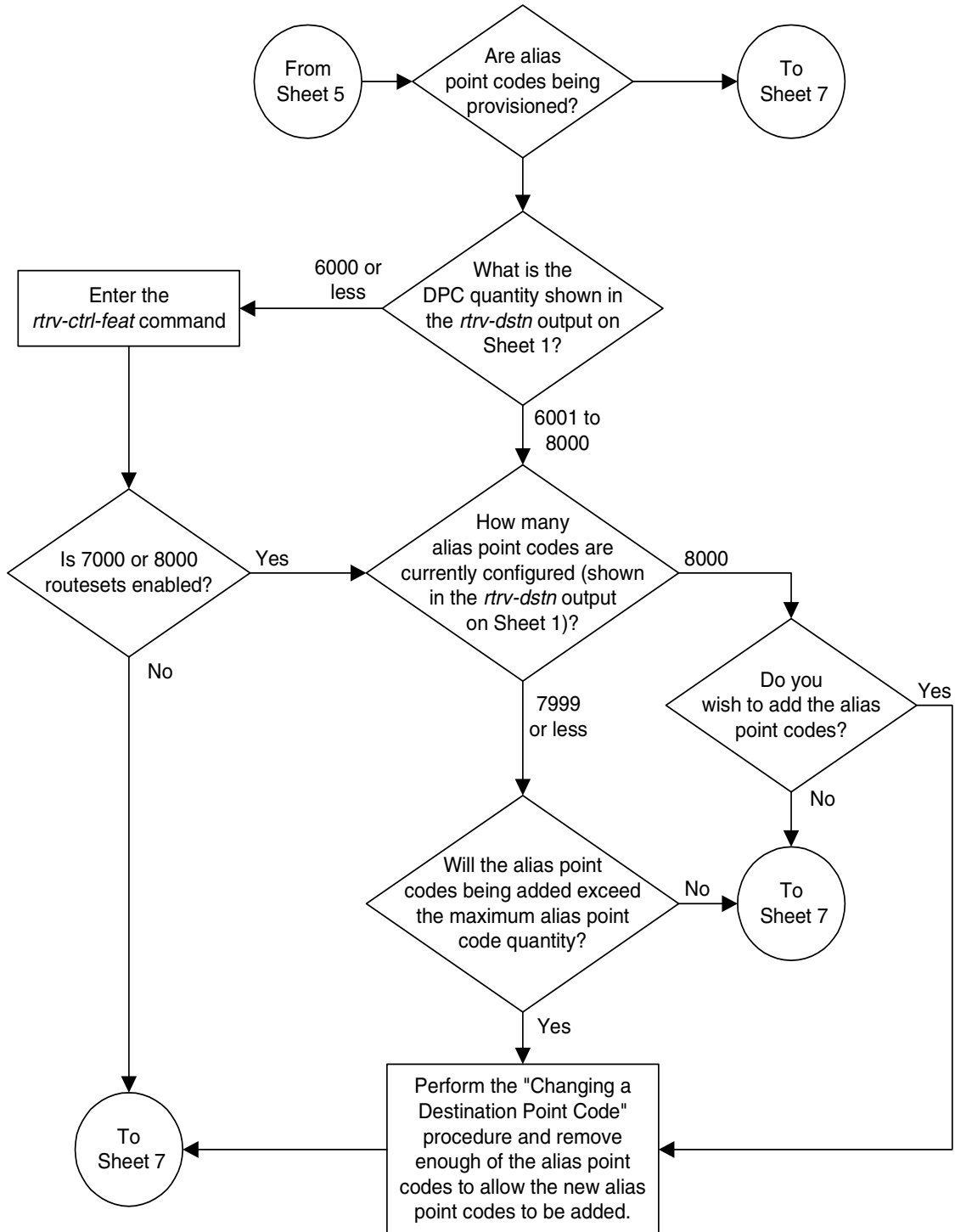

Flowchart 2-11. Adding a Destination Point Code (Sheet 7 of 8)

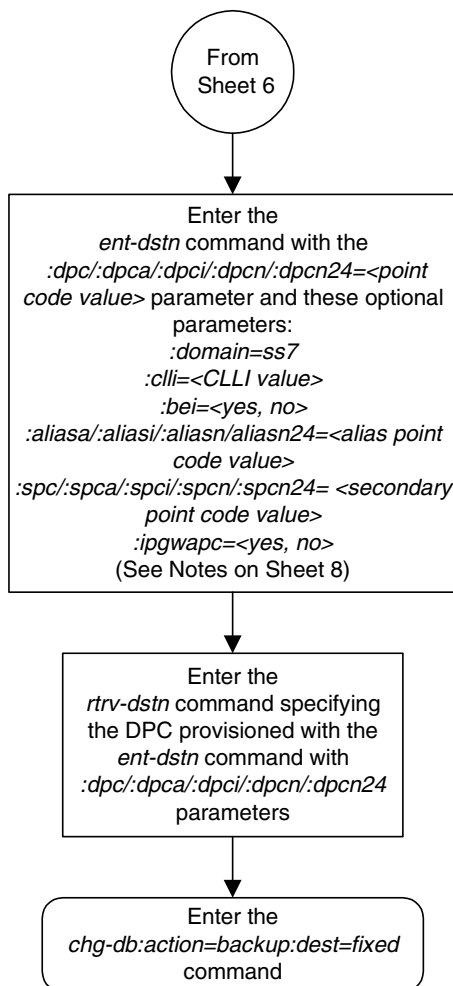

Removing a Destination Point Code

This procedure is used to remove a destination point code from the database, using the `dlt-dstn` command.

The `dlt-dstn` command uses this parameter:

`:dpc/dpca/dpci/dpcn/dpcn24` – The destination point code being removed from the database

NOTE: See “Point Code Formats” on page 2-4 for a definition of the point code types that are used on the EAGLE 5 SAS and for a definition of the different formats that can be used for ITU national point codes.

The destination point code to be removed must exist in the database, but cannot be assigned to any routes. Enter the `rtrv-rte` command to see if the destination point code to be removed is assigned to any routes. If the destination point code is assigned to any routes, go to the “Removing a Route” procedure on page 3-189 to remove these routes.

The destination point code cannot be defined as an adjacent point code for a linkset. Enter the `rtrv-ls` to see if the destination point code to be removed is defined as an adjacent point code for a linkset. If the destination point code is defined as an adjacent point code for a linkset, go to the “Removing a Linkset Containing SS7 Signaling Links” procedure on page 3-63, or the “Removing a Linkset Containing X.25 Signaling Links” procedure in the *Database Administration Manual – Features*, depending on the domain of the linkset. The domain of the linkset is shown in the `DOMAIN` field of the `rtrv-ls` output.

A destination point code in the X.25 domain cannot be removed if it is referenced by an X.25 destination. Verify this with the `rtrv-x25-dstn` command. The destination point code is shown in the `SS7 DPC` field of the `rtrv-x25-dstn` command output. If the destination point code is shown in the `SS7 DPC` field of the `rtrv-x25-dstn` command, go to the “Removing an X.25 Gateway Destination” procedure in the *Database Administration Manual – Features* to remove these X.25 destinations.

The destination point code cannot be in the mated relay node (MRN) table. Verify this by entering the `rtrv-mrn` command, specifying the destination point code being removed from the database. If the destination point code is shown in the `rtrv-mrn` command output, remove the point code from the MRN table, by executing the “Removing an MRN Group or MRN Group Entry” procedure in the *Database Administration Manual – Features*.

The destination point code cannot be defined as an end office internal point code. Verify this by entering the `rtrv-rmt-app1` command. If the destination point code is shown in the `rtrv-rmt-app1` command output, go to the “Removing an End Node Internal Point Code” procedure in the *Database Administration Manual - IP⁷ Secure Gateway* to remove the internal point code.

The examples in this procedure are used to remove destination point codes 240-012-007 and 244-020-005.

Canceling the RTRV-DSTN, RTRV-MAP, and RTRV-LS Commands

Because the `rtrv-dstn`, `rtrv-map`, and `rtrv-ls` commands used in this procedure can output information for a long period of time, the `rtrv-dstn`, `rtrv-map`, and `rtrv-ls` commands can be canceled and the output to the terminal stopped. There are three ways that the `rtrv-dstn`, `rtrv-map`, and `rtrv-ls` commands can be canceled:

- Press the **F9** function key on the keyboard at the terminal where the `rtrv-dstn`, `rtrv-map`, or `rtrv-ls` command was entered
- Enter the `canc-cmd` without the `trm` parameter at the terminal where the `rtrv-dstn`, `rtrv-map`, or `rtrv-ls` command was entered
- Enter the `canc-cmd:trm=<xx>`, where `<xx>` is the terminal where the `rtrv-dstn`, `rtrv-map`, or `rtrv-ls` command was entered, from another terminal other than the terminal where the `rtrv-dstn`, `rtrv-map`, or `rtrv-ls` command was entered. To enter the `canc-cmd:trm=<xx>` command, the terminal must allow Security Administration commands to be entered from it and the user must be allowed to enter Security Administration commands. The terminal's permissions can be verified with the `rtrv-secu-trm` command. The user's permissions can be verified with the `rtrv-user` or `rtrv-secu-user` commands.

For more information about the `canc-cmd` command, go to the *Commands Manual*.

Procedure

1. Display the current destination point codes, using the `rtrv-dstn` command. This is an example of the possible output.

```

rlghncxa03w 05-09-17 16:02:05 GMT EAGLE5 34.0.0
  DPCA          CLLI          BEI  ELEI  ALIASI          ALIASN/N24  DOMAIN
007-*-*        ----- yes  --- -----          -----  SS7
030-045-*      rlghncbb010 yes yes -----          -----  SS7
111-011-*      rlghncbb000 yes yes -----          -----  SS7
240-012-004    rlghncbb001 yes ---  1-111-1        10-13-9-3-fr SS7
240-012-005    rlghncbb002 yes ---  1-112-2        10-13-10-0-ge SS7
240-012-006    rlghncbb003 yes ---  1-112-3        10-13-10-1-fr SS7
240-012-007    ----- yes ---  1-117-3        10-13-11-1-fr SS7
240-012-008    ----- yes  ---  1-113-5        10-13-10-2-ge SS7
200-150-100    ----- yes  --- -----          -----  X25
244-020-004    ls06clli      yes --- -----          -----  X25
244-020-005    ls07clli    yes --- -----          -----  X25
244-020-006    ls08clli      yes --- -----          -----  X25
244-020-007    ----- yes  --- -----          -----  X25
244-020-008    ----- yes  --- -----          -----  X25

  DPCI          CLLI          BEI  ELEI  ALIASA          ALIASN/N24  DOMAIN
2-131-1        rlghncbb023 no  ---  222-210-000    11-11-8-1-ge  SS7
2-131-2        ----- no  ---  222-211-001    11-11-8-2-fr  SS7
2-131-3        ----- no  ---  222-211-002    11-11-8-3-ge  SS7
4-163-5        ----- no  ---  250-200-007    -----        SS7

  DPCN          CLLI          BEI  ELEI  ALIASA          ALIASI          DOMAIN
7-9-10-1-fr    ----- no  ---  210-090-100    1-75-6         SS7
7-9-10-1-ge    ----- no  ---  210-100-100    2-175-6        SS7
10-15-2-3-fr    rlghncbb013 no  ---  222-200-200    2-121-1        SS7
10-15-2-3-ge    rlghncbb013 no  ---  222-100-200    2-100-1        SS7
10-15-3-0-fr    rlghncbb013 no  ---  222-200-201    2-121-2        SS7
10-15-3-0-ge    rlghncbb013 no  ---  222-100-201    2-100-2        SS7

  DPCN24        CLLI          BEI  ELEI  ALIASA          ALIASI          DOMAIN

DESTINATION ENTRIES ALLOCATED:  2000
  FULL DPC(s) :                   21
  NETWORK DPC(s) :                  1
  CLUSTER DPC(s) :                  2
  TOTAL DPC(s) :                    24
  CAPACITY (% FULL) :                1%
ALIASES ALLOCATED:                8000
  ALIASES USED:                     29
  CAPACITY (% FULL) :                1%
X-LIST ENTRIES ALLOCATED:         500
RTRV-DSTN: MASP A - COMPLTD

```

Configuring Destination Tables

- Verify whether or not the DPC to be removed from the database is a DPC of a route, by entering the **rtrv-rte** command with the DPC that is to be removed from the database. For this example, enter these commands.

rtrv-rte:dPCA=240-012-007

This is an example of the possible output.

```
rlghncxa03w 05-09-17 16:02:05 GMT EAGLE5 34.0.0

      DPCA          ALIASI      ALIASN/N24  LSN          RC    APCA
      240-012-007    1-117-3      10-13-11-1-fr  ls04         10    240-012-007
                                          ls02         20    004-004-004
                                          ls03         30    003-003-003
                                          CLLI=ls04c1li
```

rtrv-rte:dPCA=244-020-005

```
rlghncxa03w 05-09-17 16:02:05 GMT EAGLE5 34.0.0

      DPCA          ALIASI      ALIASN/N24  LSN          RC    APCA
      244-020-005    -----      -----      ls10         10    244-020-005
                                          ls11         20    100-100-100
                                          CLLI=ls07c1li
```

If the DPC being removed from the database is a DPC of a route, go to the “Removing a Route” procedure on page 3-189 and remove the route from the database.

- Verify whether or not the DPC to be removed from the database is an APC of a linkset, by entering the **rtrv-ls** command. This is an example of the possible output.

```
rlghncxa03w 05-09-10 11:43:04 GMT EAGLE5 34.0.0

      LSN          APCA      (SS7)      L3T SLT      GWS GWS GWS
      ele2         001-207-000 none 1 1 no B 6 off off off no off
      ls1305       000-005-000 none 1 1 no A 1 off off off no off
      ls1307       000-007-000 none 1 1 no A 1 off off off no off
      elm1s1       001-001-001 none 1 1 no A 7 off off off no off
      elm1s2       001-001-002 none 1 1 no A 7 off off off no off

      LSN          APCA      (X25)      L3T SLT      GWS GWS GWS
      ele2         001-207-000 none 1 1 no B 6 off off off no off
      ls1305       000-005-000 none 1 1 no A 1 off off off no off
      ls1307       000-007-000 none 1 1 no A 1 off off off no off
      elm1s1       001-001-001 none 1 1 no A 7 off off off no off
      elm1s2       001-001-002 none 1 1 no A 7 off off off no off

      LSN          APCI      (SS7)      L3T SLT      GWS GWS GWS
      ele2i        1-207-0      none 1 1 no B 4 off off off --- on
      ls1315       0-015-0      none 1 1 no A 1 off off off --- off
      ls1317       0-017-0      none 1 1 no A 1 off off off --- on
      elm2s1       1-011-1      none 1 1 no A 7 off off off --- off
      elm2s2       1-011-2      none 1 1 no A 7 off off off --- off

      LSN          APCN      (SS7)      L3T SLT      GWS GWS GWS
      ele2         001-207-000 none 1 1 no B 6 off off off no off
      ls1305       000-005-000 none 1 1 no A 1 off off off no off
      ls1307       000-007-000 none 1 1 no A 1 off off off no off
      elm1s1       001-001-001 none 1 1 no A 7 off off off no off
      elm1s2       001-001-002 none 1 1 no A 7 off off off no off

      LSN          APCN24 (SS7)      L3T SLT      GWS GWS GWS
      ele2         001-207-000 none 1 1 no B 6 off off off no off
      ls1305       000-005-000 none 1 1 no A 1 off off off no off
      ls1307       000-007-000 none 1 1 no A 1 off off off no off
      elm1s1       001-001-001 none 1 1 no A 7 off off off no off
      elm1s2       001-001-002 none 1 1 no A 7 off off off no off

      LSN (CHINA) APCN      (SS7)      L3T SLT      GWS GWS GWS
      ele2         001-207-000 none 1 1 no B 6 off off off no off
      ls1305       000-005-000 none 1 1 no A 1 off off off no off
      ls1307       000-007-000 none 1 1 no A 1 off off off no off
      elm1s1       001-001-001 none 1 1 no A 7 off off off no off
      elm1s2       001-001-002 none 1 1 no A 7 off off off no off
```

```

                                L3T SLT                                GWS GWS GWS
LSN (CHINA) APCN24 (SS7)  SCRN  SET SET BEI LST LNKS ACT MES DIS SLSCI NIS

```

Link set table is (10 of 1024) 1% full.

If the DPC being removed from the database is an APC of an SS7 linkset, go to the “Removing a Linkset Containing SS7 Signaling Links” procedure on page 3-63 and remove the linkset from the database.

If the DPC being removed from the database is an APC of an X.25 linkset, go to the “Removing a Linkset Containing X.25 Signaling Links” procedure in the *Database Administration Manual - Features* and remove the linkset from the database.

4. Verify that the IGTTLS feature is enabled, by entering the `rtrv-ctrl-feat` command with the IGTTLS part number. Enter this command.

```
rtrv-ctrl-feat:partnum=893006901
```

The following is an example of the possible output.

```
rlghncxa03w 05-09-28 21:15:37 GMT EAGLE5 34.0.0
The following features have been permanently enabled:
```

Feature Name	Partnum	Status	Quantity
Intermed GTT Load Sharing	893006901	on	----

The following features have been temporarily enabled:

Feature Name	Partnum	Status	Quantity	Trial Period Left
Zero entries found.				

The following features have expired temporary keys:

Feature Name	Partnum
Zero entries found.	

NOTE: If the `rtrv-ctrl-feat` output in step 4 shows that the IGTTLS feature is not enabled, skip step 5 and go to step 6.

5. Verify whether or not the DPC is in the mated relay node table using the `rtrv-mrn` command, specifying the destination point code being removed from the database. For this example, enter this command.

```
rtrv-mrn:pca=244-020-007
```

This is an example of the possible output.

```
rlghncxa03w 05-09-07 00:34:31 GMT EAGLE5 34.0.0
```

PC	RC
7-7-7	10
8-1-1	20
244-20-7	30
8-1-3	40
8-1-4	50

PC	RC
8-1-5	60
8-1-6	70

Configuring Destination Tables

```
8-1-7    80
8-1-8    90
```

If the destination point code is shown in the `rtrv-mrn` command output, remove the point code from the MRN table, by executing the “Removing an MRN Group or MRN Group Entry” procedure in the *Database Administration Manual – Features*.

-
6. Verify whether or not the DPC is defined as an end office internal point code using the `rtrv-rmt-app1` command. This is an example of the possible output.

```
rlghncxa03w 05-09-28 09:12:36 GMT EAGLE5 34.0.0
IPCA          SI SSN
003-003-003   3 100, 110-119, 200
               5
244-020-007   3 150, 175

IPCI          SI SSN
3-003-3       3 5, 50-100, 250
               5

IPCN          SI SSN
10-12-0-0-fr  3 250
               5

IPC24         SI SSN
```

If the destination point code is shown in the `rtrv-rmt-app1` command output, go to the “Removing an End Node Internal Point Code” procedure in the *Database Administration Manual - IP⁷ Secure Gateway* to remove the internal point code.

NOTE: If the domain of the DPC is SS7 (shown in the `DOMAIN` field of the `rtrv-dstn` command output in step 1), skip step 7 and go to step 8.

7. Verify whether or not the X.25 DPC is assigned to an X.25 destination by entering the `rtrv-x25-dstn` command. This is an example of the possible output.

```
rlghncxa03w 05-09-28 21:16:37 EDT EAGLE5 34.0.0
X25 ADDR      SS7 DPC  SSN
11101         244-020-004 005
220525586456772 244-020-005 002
33301         244-020-006 006
423423045656767 244-020-007 112
55501         244-020-008 005
X.25 DSTN TABLE IS 1 % FULL
```

If the DPC is shown in the `rtrv-x25-dstn` output, go to the “Removing an X.25 Gateway Destination” procedure in the *Database Administration Manual - Features* and remove the X.25 destinations assigned to the X.25 DPC from the database.

8. Remove the destination point code from the database, using the **dlt-dstn** command. For this example, enter these commands.

```
dlt-dstn:dpca=240-012-007
```

```
dlt-dstn:dpca=244-020-005
```

When the **dlt-dstn** command has successfully completed, and the Cluster Routing and Management Diversity feature is turned off (**CRMD = off** in the **rtrv-feat** command output), this message should appear.

```
rlghncxa03w 05-09-17 15:35:05 GMT EAGLE5 34.0.0
Destination table is (22 of 2000) 1% full
DLT-DSTN: MASP A - COMPLTD
```

If the Cluster Routing and Management Diversity feature is turned on (**CRMD = on** in the **rtrv-feat** command output), this is an example of the message that should appear when the **dlt-dstn** command has successfully completed.

```
rlghncxa03w 05-09-17 15:35:05 GMT EAGLE5 34.0.0
DESTINATION ENTRIES ALLOCATED:    2000
  FULL DPC(s):                    19
  NETWORK DPC(s):                 1
  CLUSTER DPC(s):                 2
  TOTAL DPC(s):                   22
  CAPACITY (% FULL):              1%
ALIASES ALLOCATED:                8000
  ALIASES USED:                   27
  CAPACITY (% FULL):              1%
X-LIST ENTRIES ALLOCATED:        500
DLT-DSTN: MASP A - COMPLTD
```

9. Verify the changes using the **rtrv-dstn** command with the DPC specified in step 10. For this example, enter these commands.

```
rtrv-dstn:dpca=240-012-007
```

```
rtrv-dstn:dpca=244-020-005
```

This is an example of the possible output for both of these commands.

```
rlghncxa03w 05-09-17 16:02:05 GMT EAGLE5 34.0.0

      DPCA          CLLI          BEI ELEI    ALIASI          ALIASN/N24    DOMAIN

No destinations meeting the requested criteria were found

Destination table is (22 of 2000) 1% full
Alias table is (27 of 8000) 1% full
```

10. Back up the new changes, using the **chg-db:action=backup:dest=fixed** command. These messages should appear; the active Maintenance and Administration Subsystem Processor (MASP) appears first.

```
BACKUP (FIXED) : MASP A - Backup starts on active MASP.
BACKUP (FIXED) : MASP A - Backup on active MASP to fixed disk complete.
BACKUP (FIXED) : MASP A - Backup starts on standby MASP.
BACKUP (FIXED) : MASP A - Backup on standby MASP to fixed disk complete.
```

Flowchart 2-12. Removing a Destination Point Code (Sheet 1 of 5)

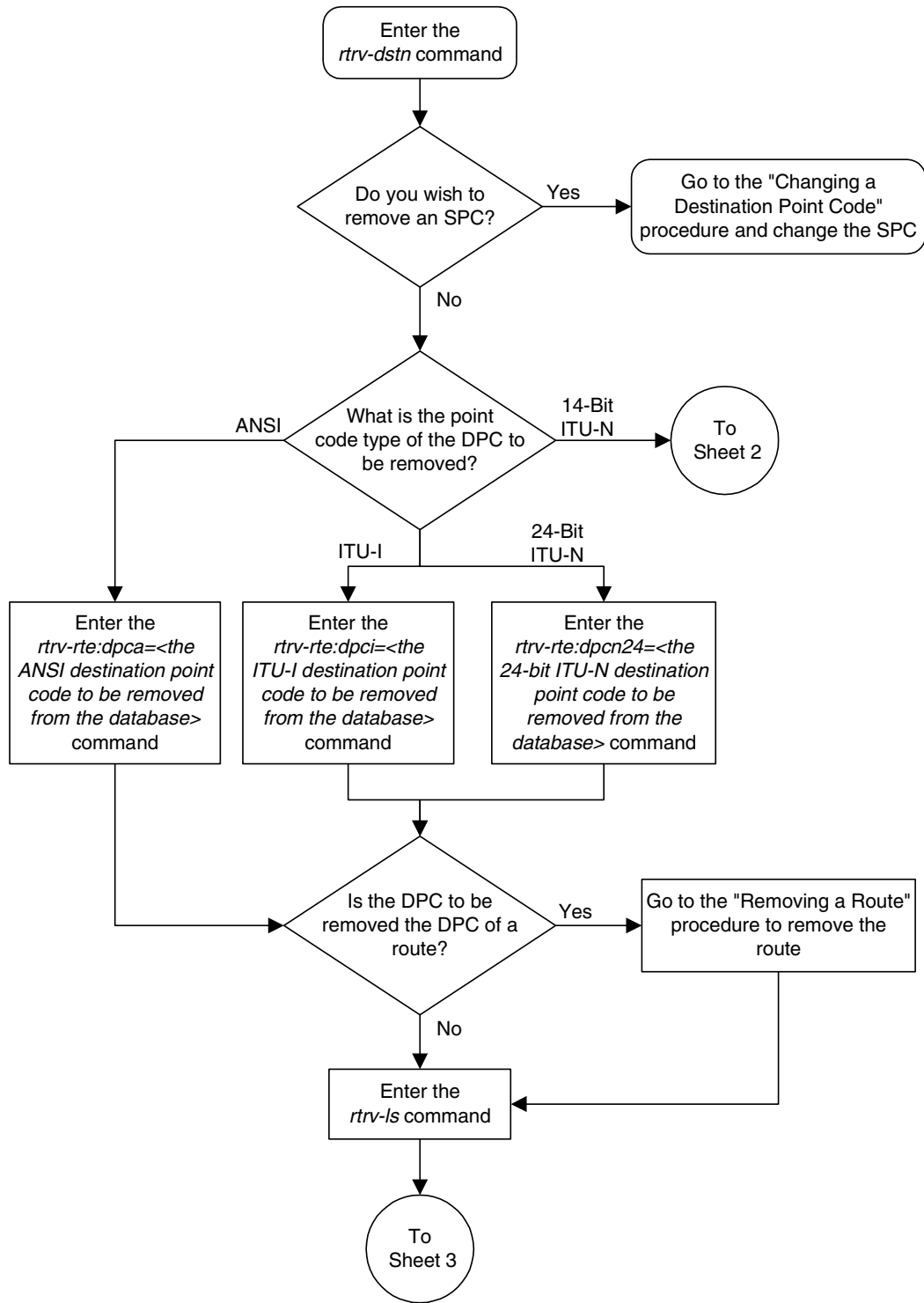

Flowchart 2-12. Removing a Destination Point Code (Sheet 2 of 5)

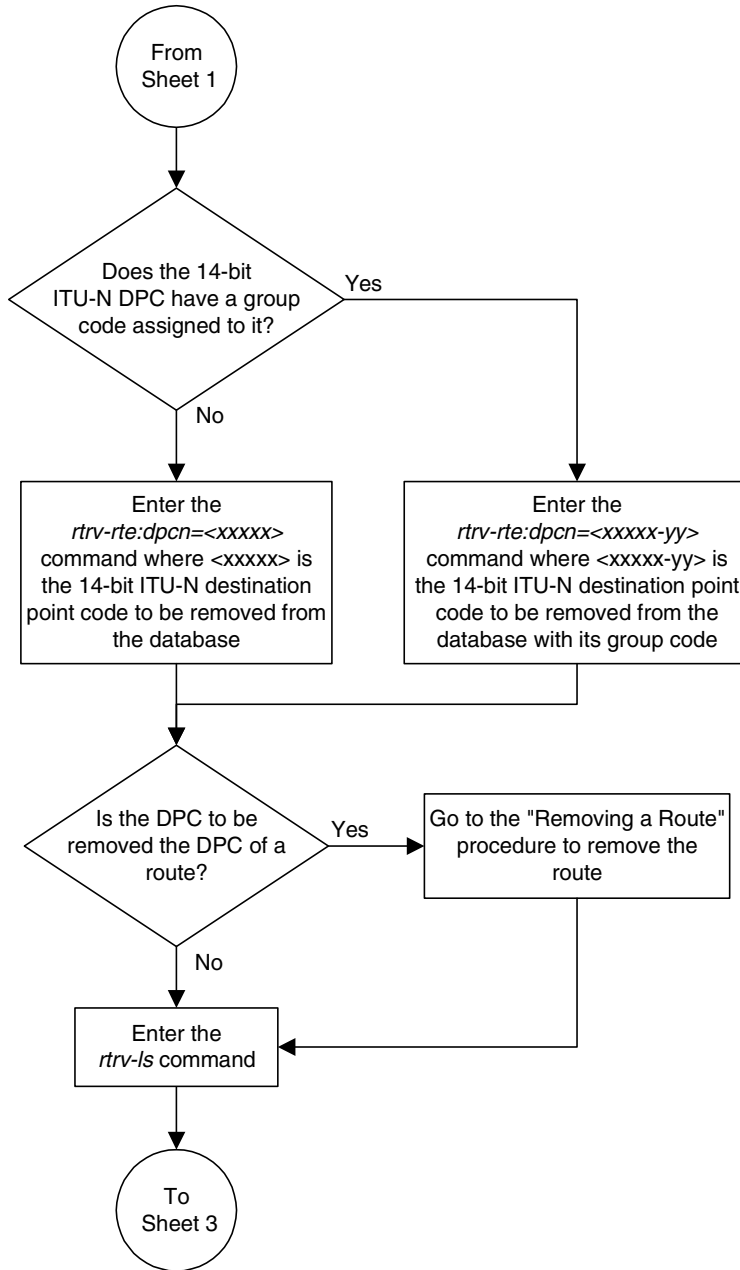

Flowchart 2-12. Removing a Destination Point Code (Sheet 3 of 5)

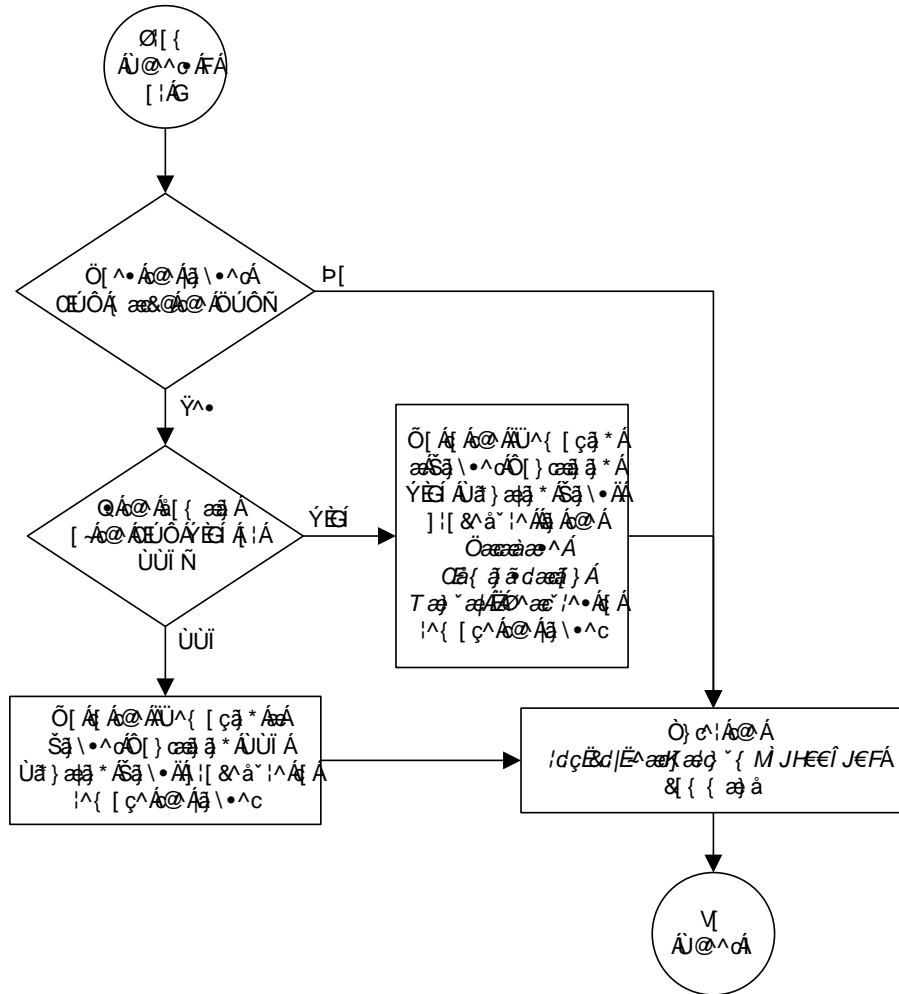

Flowchart 2-12. Removing a Destination Point Code (Sheet 4 of 5)

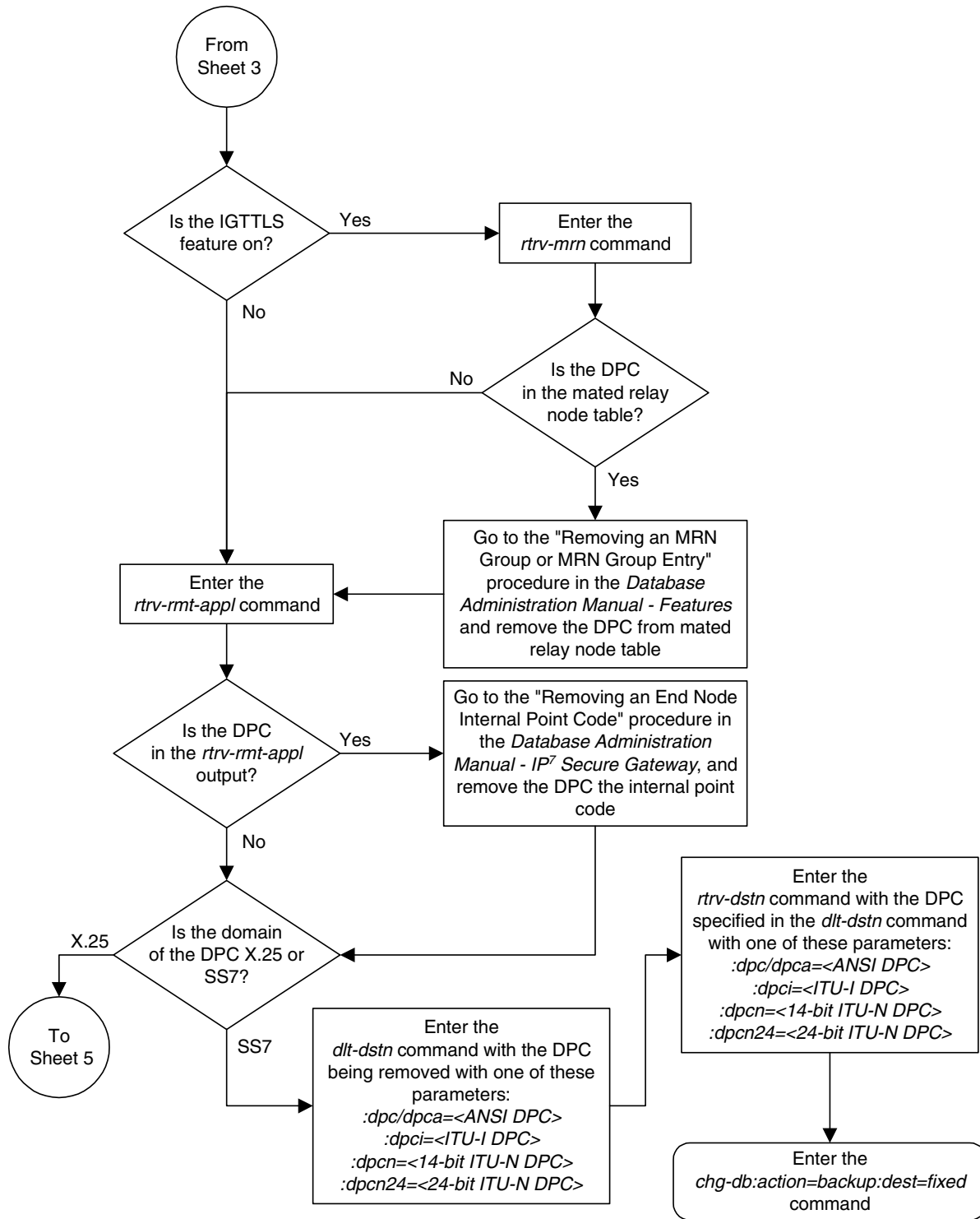

Flowchart 2-12. Removing a Destination Point Code (Sheet 5 of 5)

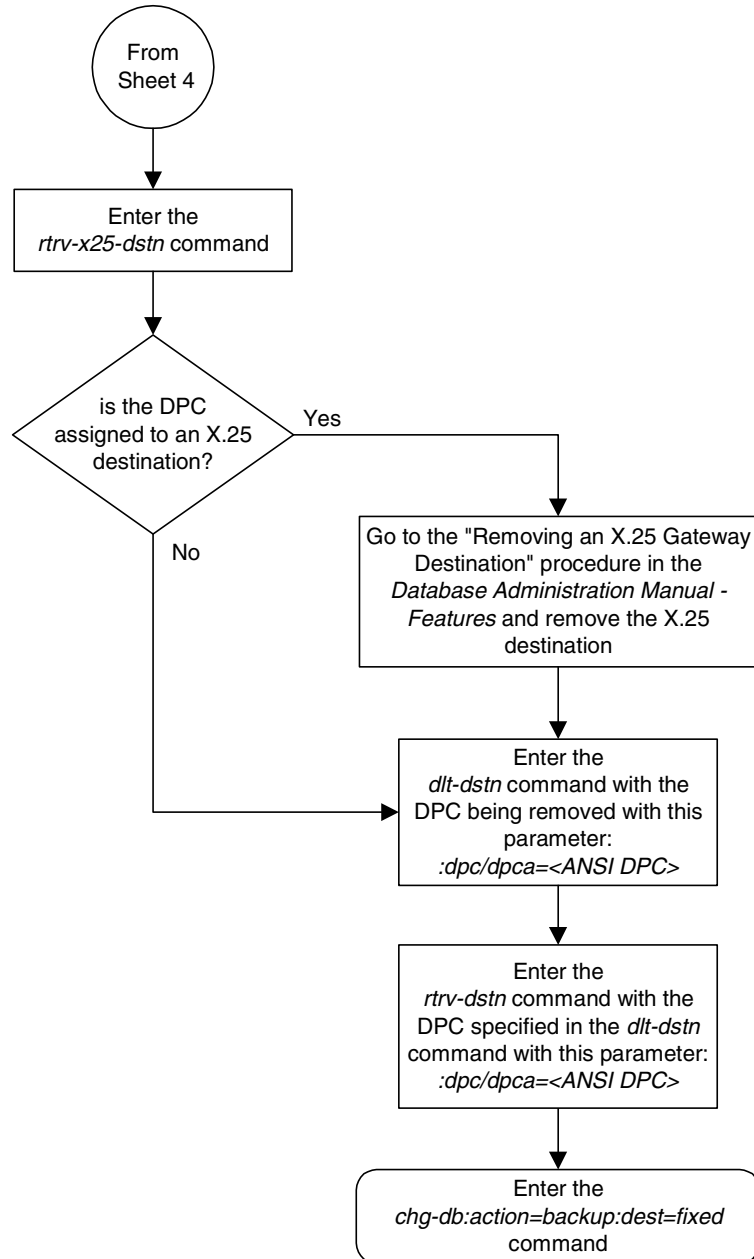

Changing a Destination Point Code

This procedure is used to change the attributes of a full destination point code in the database, using the `chg-dstn` command.

To change the attributes of a cluster point code, go to the “Changing the Attributes of a Cluster Point Code” procedure on page 2-161.

This procedure cannot be used to change a true point code (`dpc/dpca/dpci/dpcn/dpcn24`) or the domain of a destination point code. To change a true point code or the domain of a destination point code, the destination point code must be removed, then re-entered. Go to the “Removing a Destination Point Code” procedure on page 2-214 and remove the point code from the database. To add the new point code, go to one of these procedures:

- Cluster point code – “Adding a Cluster Point Code” procedure on page 2-142
- Network routing point code – “Adding a Network Routing Point Code” procedure on page 2-181
- All other point codes – “Adding a Destination Point Code” procedure on page 2-191

The destination point code to be changed must be in the database.

The `chg-dstn` command uses these parameters:

`:dpc/dpca/dpci/dpcn/dpcn24` – The destination point code in the database being changed

`:aliasa/aliasi/aliasn/aliasn24` – The alternate destination point code. Two optional alias addresses can be defined.

NOTE: If 7000 or 8000 routesets are enabled, the EAGLE 5 SAS can contain a maximum of 8000 alias point codes. If 7000 or 8000 routesets are not enabled, the EAGLE 5 SAS can contain a maximum of 12000 alias point codes.

NOTE: See “Point Code Formats” on page 2-4 for a definition of the point code types that are used on the EAGLE 5 SAS and for a definition of the different formats that can be used for ITU national point codes. A private point code cannot be used as an alias point code.

`:c11i` – The Common Language Location Identifier assigned to this point code

`:bei` – Broadcast exception indicator that indicates whether transfer-prohibited (TFP) messages will be broadcast from this node. The `bei=yes` parameter means TFPs will not be broadcast. The `bei=no` parameter means TFPs will be broadcast.

`:spc/spca/spci/spcn/spcn24` – The secondary point code as defined by the `ent-spc` command. The secondary point code allows the EAGLE 5 SAS to use another point code in addition to the one defined by the `dpc`, `dpca`, `dpci`, `dpcn`, or `dpcn24` parameters of the `chg-dstn` command for SS7 routing

purposes. See the “Multiple Point Code Support” section on page 2-55 for more information on secondary point codes. **A private point code cannot be used as a secondary point code.**

:elei – For cluster point codes only. Specifies whether or not the EAGLE 5 SAS maintains a dynamic status exception list for each cluster route that may be used to reach the member signaling points making up the cluster.

NOTE: See the “Cluster Routing and Management Diversity (CRMD)” section on page 2-119 for more information on the cluster routing feature.

For more information on changing the value of the `elei` parameter, see the “Changing the Attributes of a Cluster Point Code” procedure on page 2-161.

:ncai – The nested cluster allowed indicator specifies whether or not the route to the cluster point code can be different from the route to a point code that is a member of the cluster point code.

NOTE: See the “Nested Cluster Routing” section on page 2-135 for more information on the nested cluster routing feature.

For more information on changing the value of the `ncai` parameter, see the “Changing the Attributes of a Cluster Point Code” procedure on page 2-161.

Secondary point codes must be in the SS7 domain and must be a full point code. A secondary point code can only be assigned to a full point code in the SS7 domain. The network type of the secondary point code must match the network type of the destination point code. The secondary point code used in this procedure must be configured in the database with the `ent-spc` command. The secondary point codes are shown in the `SPCA`, `SPC-I`, `SPC-N`, and `SPC-N24` fields of the `rtrv-spc` command output. If the desired secondary point code is not shown in the output of the `rtrv-spc` command, go to the “Adding a Secondary Point Code” procedure on page 2-63 and configure the desired point code as a secondary point code.

If a secondary point code is assigned to the destination point code, the group code of the 14-bit ITU-N destination point code must match the group code of the secondary point code. Otherwise, the group code of the destination point code must match the group code assigned to the EAGLE 5 SAS’s true 14-bit ITU-N point code, shown in the `PCN` field of the `rtrv-sid` output.

The value `none` for the `spca`, `spci`, `spcn`, or `spcn24` parameters removes the assignment of the current secondary point code and leaves the destination point code without a secondary point code.

The value `none` for the `aliasa` (ANIS), `aliasi` (ITU-I), `aliasn` (14-bit ITU-N), or `aliasn24` (24-bit ITU-N) parameters removes that type of alias point code from the destination point code.

The value of the **c11i** parameter cannot be in the destination point code table and cannot match the CLLI of the EAGLE 5 SAS. Verify this by entering the **rtrv-dstn** and the **rtrv-sid** commands, shown in steps 1 and 2 of the procedure that follows. If the value of the **c11i** parameter matches any CLLI values in either of these outputs, choose another value for the **c11i** parameter that does not match any CLLIs shown in either of these command outputs.

If the **dpci**, **dpcn**, **dpcn24**, **aliasa**, **aliasi**, **aliasn**, **aliasn24**, **spca**, **spci**, **spcn**, or **spcn24** parameters cannot be specified if the existing domain of the destination point code being changed is X.25 (**domain=x25**).

To enter point codes of any network type (ANSI, ITU-I, or ITU-N - 14-bit or 24-bit) into the database with the **chg-dstn** command, the self ID of the EAGLE 5 SAS must be defined for these networks. Verify this with the **rtrv-sid** command.

If a point code value is shown in the **PCA** field of the **rtrv-sid** command, then ANSI point codes can be specified with the **chg-dstn** command.

If a point code value is shown in the **PCI** field of the output of the **rtrv-sid** command, then ITU-I point codes can be specified with the **chg-dstn** command. The **PCI** column of the **rtrv-sid** output can contain spare and non-spare point code values. To provision ITU-I non-spare point codes in this procedure, the **rtrv-sid** output must contain an ITU-I non-spare point code in the **PCI** column. To provision ITU-I spare point codes in this procedure, the **rtrv-sid** output must contain an ITU-I spare point code in the **PCI** column.

If a point code value is shown in the **PCN** field of the output of the **rtrv-sid** command, then 14-bit ITU-N point codes can be specified with the **chg-dstn** command. The **PCN** column of the **rtrv-sid** output can contain spare and non-spare point code values. To provision 14-bit ITU-N non-spare point codes in this procedure, the **rtrv-sid** output must contain a 14-bit ITU-N non-spare point code in the **PCN** column. To provision 14-bit ITU-N spare point codes in this procedure, the **rtrv-sid** output must contain a 14-bit ITU-N spare point code in the **PCN** column.

If a point code value is shown in the **PCN24** field of the output of the **rtrv-sid** command, then 24-bit ITU-N point codes can be specified with the **chg-dstn** command.

If no values are shown in the **PCA**, **PCI**, **PCN**, or **PCN24** fields in the **rtrv-sid** command output, the self-identification of the EAGLE 5 SAS must be updated with an ANSI point code, ITU international point code or a 14-bit ITU national point code. Go to "Changing the Self-Identification of the EAGLE 5 SAS" procedure on page 2-90 to change the self-identification of the EAGLE 5 SAS.

NOTE: The EAGLE 5 SAS can contain 14-bit ITU national point codes or 24-bit ITU national point codes, but both at the same time.

Configuring Destination Tables

Private point codes cannot be specified in the self-identification of the EAGLE 5 SAS, therefore, private point codes can be added as long as the self identification of the EAGLE 5 SAS contains a point code with the same network type as the private point code being added in this procedure. The ITU National and International Spare Point Code Support feature does not have to be enabled to add a private point code.

If the alias point code parameters **aliasa**, **aliasi**, **aliasn**, or **aliasn24** are specified with the **chg-dstn** command, the aliases must be of a different point code type than the true point code. For example, if the **dpca** parameter is specified, then only the **aliasi**, **aliasn**, or **aliasn24** parameters can be specified. The **aliasa** parameter cannot be specified. Table 2-13 shows which alias parameters can be specified with the destination point code parameters. The value **none** for the alias parameters removes that point code as an alias for the specified destination point code from the database.

Table 2-13. Destination Point Code and Alias Parameter Combinations

Destination Point Code Parameters	Alias Point Code Parameters
dpc/dpca	aliasi, aliasn/aliasn24*
dpci	aliasa, aliasn/aliasn24*
dpcn/dpcn24*	aliasa, aliasi
* The EAGLE 5 SAS can contain 14-bit ITU national point codes or 24-bit ITU national point codes, but both at the same time.	

Alias point codes can only be specified for full point code entries and must be full point codes.

Destination point codes and alias point codes must be unique in the database. A point code cannot be defined as a true destination point code and an alias point code.

If the X.25 destination point code is a member of a cluster, the value of the **bei** parameter for the X.25 destination point code is not changed to the value of the **bei** parameter of the cluster, but the value of the **bei** parameter of the cluster determines the behavior of the X.25 destination point code as long as the cluster remains in the destination point code table. If this cluster is removed from the DPC table, the X.25 destination behaves as it is configured with the **ent-dstn** command.

For example, if the X.25 destination point code, 002-002-002, is a member of the cluster 002-002-*, the **bei** parameter of the cluster is set to **yes**, and the **bei** parameter of the X.25 destination point code is set to **no**, the X.25 destination point code behaves as if the **bei** parameter is set to **yes**. If the cluster 002-002-* is removed from the database, the **bei** parameter of the X.25 destination point code is set to **no** and the X.25 destination point code broadcasts TFP and TFA messages to adjacent nodes.

If you intend to use this X.25 destination point code with an X.25 route that has the `lc2nm` parameter set to `yes`, make sure that the `bei` parameter of the cluster containing the X.25 destination point code is set to `no`. Verify the value of the `bei` parameter of the cluster with the `rtrv-dstn` command. To change the existing value the `bei` parameter, specify the `bei` parameter with the appropriate value (`yes` or `no`) with the `chg-dstn` command in this procedure. If the `bei` parameter is not specified with the `chg-dstn` command, the value of the `bei` parameter is not changed.

If either the `dpcn` or `aliasn` parameters are specified with the `chg-dstn` command, the format of the 14-bit ITU-N point code values must match the format shown in the `NPCFMTI` field of the `rtrv-stpopts` command output. For more information, see “14-Bit ITU National Point Code Formats” on page 2-10.

The examples in this procedure are used to change the attributes of the destination point code 240-012-007. The format of the 14-bit ITU national point codes used in these examples is 4-4-4-2.

Canceling the RTRV-DSTN Command

Because the `rtrv-dstn` command used in this procedure can output information for a long period of time, the `rtrv-dstn` command can be canceled and the output to the terminal stopped. There are three ways that the `rtrv-dstn` command can be canceled:

- Press the **F9** function key on the keyboard at the terminal where the `rtrv-dstn` command was entered
- Enter the `canc-cmd` without the `trm` parameter at the terminal where the `rtrv-dstn` command was entered
- Enter the `canc-cmd:trm=<xx>`, where `<xx>` is the terminal where the `rtrv-dstn` command was entered, from another terminal other than the terminal where the `rtrv-dstn` command was entered. To enter the `canc-cmd:trm=<xx>` command, the terminal must allow Security Administration commands to be entered from it and the user must be allowed to enter Security Administration commands. The terminal's permissions can be verified with the `rtrv-secu-trm` command. The user's permissions can be verified with the `rtrv-user` or `rtrv-secu-user` commands.

For more information about the `canc-cmd` command, refer to the *Commands Manual*.

Procedure

1. Display the current destination point codes, using the `rtrv-dstn` command. This is an example of the possible output.

```

rlghncxa03w 05-09-17 16:02:05 GMT EAGLE5 34.0.0
DPCA          CLLI          BEI  ELEI  ALIASI          ALIASN/N24  DOMAIN
007-*-*      ----- yes --- -----  -----  SS7
030-045-*    rlghncbb010 yes yes -----  -----  SS7
111-011-*    rlghncbb000 yes yes -----  -----  SS7
240-012-004  rlghncbb001 yes ---  1-111-1    10-13-9-3-fr SS7
240-012-005  rlghncbb002 yes ---  1-112-2    10-13-10-0-ge SS7
240-012-006  rlghncbb003 yes ---  1-112-3    10-13-10-1-fr SS7
240-012-007  ----- yes ---  1-117-3    10-13-11-1-fr SS7
240-012-008  ----- yes ---  1-113-5    10-13-10-2-ge SS7
200-150-100  ----- yes --- -----  -----  X25
244-020-004  ls06clli    yes --- -----  -----  X25
244-020-005  ls07clli    yes --- -----  -----  X25
244-020-006  ls08clli    yes --- -----  -----  X25
244-020-007  ----- yes --- -----  -----  X25
244-020-008  ----- yes --- -----  -----  X25

DPCI          CLLI          BEI  ELEI  ALIASA          ALIASN/N24  DOMAIN
2-131-1      rlghncbb023 no ---  222-210-000 11-11-8-1-ge SS7
2-131-2      ----- no ---  222-211-001 11-11-8-2-fr SS7
2-131-3      ----- no ---  222-211-002 11-11-8-3-ge SS7
4-163-5      ----- no ---  250-200-007 -----  SS7

DPCN          CLLI          BEI  ELEI  ALIASA          ALIASI        DOMAIN
7-9-10-1-fr  ----- no ---  210-090-100 1-75-6        SS7
7-9-10-1-ge  ----- no ---  210-100-100 2-175-6       SS7
10-15-2-3-fr rlghncbb013 no ---  222-200-200 2-121-1       SS7
10-15-2-3-ge rlghncbb013 no ---  222-100-200 2-100-1       SS7
10-15-3-0-fr rlghncbb013 no ---  222-200-201 2-121-2       SS7
10-15-3-0-ge rlghncbb013 no ---  222-100-201 2-100-2       SS7

DPCN24        CLLI          BEI  ELEI  ALIASA          ALIASI        DOMAIN

DESTINATION ENTRIES ALLOCATED:  2000
  FULL DPC(s):                   21
  NETWORK DPC(s):                 1
  CLUSTER DPC(s):                 2
  TOTAL DPC(s):                   24
  CAPACITY (% FULL):              1%
ALIASES ALLOCATED:                8000
  ALIASES USED:                   29
  CAPACITY (% FULL):              1%
X-LIST ENTRIES ALLOCATED:         500
RTRV-DSTN: MASP A - COMPLTD

```

NOTE: If the CLI value assigned to the destination point code is not being changed, skip this step and go to step 3.

2. Display the EAGLE 5 SAS self-identification, using the `rtrv-sid` command. This is an example of the possible output.

```
rlghncxa03w 05-09-10 11:43:04 GMT EAGLE5 34.0.0
PCA          PCI          PCN          CLLI          PCTYPE
100-100-100  3-75-7         7-9-8-1-fr  rlghncxa03w  OTHER

CPCA
002-002-002  002-002-003  002-002-004  002-002-005
002-002-006  002-002-007  002-002-008  002-002-009
004-002-001  004-003-003  050-060-070

CPCA (LNP)
005-005-002  005-005-004  005-005-005

CPCI
1-002-1      1-002-2      1-002-3      1-002-4
2-001-1      7-222-7

CPCN
2-0-10-3-fr  2-0-11-0-fr  2-0-11-2-fr  2-0-12-1-fr
2-2-3-3-fr   2-2-4-0-fr   10-14-10-1-fr
```

If the CLI value for the destination point code is being changed in this procedure, that CLI value cannot be shown in the `CLLI` fields of either the `rtrv-dstn` (step 1) or the `rtrv-sid` (step 2) command outputs.

NOTE: If the point code being changed in this procedure is an X.25 point code, skip steps 3 through 9, and go to step 10.

NOTE: If the secondary point code value assigned to the destination point code is not being changed, skip this step and step 4, and go to step 5.

3. Display all the attributes of the point code being changed, using the `rtrv-dstn` command with either the `dpca`, `dpci`, `dpcn`, or `dpcn24` parameters.

For this example, enter this command.

```
rtrv-dstn:dpca=240-012-007
```

This is an example of the possible output.

```
rlghncxa03w 05-09-28 21:16:37 GMT EAGLE5 34.0.0
DPCA          CLLI          BEI ELEI     ALIASI          ALIASN/N24     DOMAIN
240-012-007  ----- yes ---  1-117-3        10-13-11-1-fr SS7

          SPC          NCAI
          003-010-010  no

DESTINATION ENTRIES ALLOCATED:  2000
FULL DPC(s) :                    21
NETWORK DPC(s) :                   1
CLUSTER DPC(s) :                   2
TOTAL DPC(s) :                     24
CAPACITY (% FULL) :                 1%
ALIASES ALLOCATED:                 8000
ALIASES USED:                      29
```

Configuring Destination Tables

```
CAPACITY (% FULL):          1%
X-LIST ENTRIES ALLOCATED:    500
RTRV-DSTN: MASP A - COMPLTD
```

The secondary point code being changed is shown in the **SPC** field.

4. Display the secondary point codes in the database with the **rtrv-spc** command. This is an example of the possible output.

```
rlghncxa03w 05-09-17 16:02:05 GMT EAGLE5 34.0.0
SPC (Secondary Point Codes)
```

```
SPCA
  001-010-010
  002-010-010
  003-010-010
  010-100-010

SPC-I
  1-253-5
  2-254-6
  3-255-7
  4-100-1

SPC-N
  10-1-11-1-ge
  13-2-12-0-ge
  14-15-12-1-ge
```

```
SPC-N24
```

```
none
```

```
Secondary Point Code table is (11 of 40) 28% full
```

If the desired secondary point code is not shown in the **rtrv-spc** command output, go to the “Adding a Secondary Point Code” procedure on page 2-63 and add the secondary point code to the database.

NOTE: If an existing alias point code is not being changed in this procedure, or if a new alias point code is not being added in this procedure, skip steps 5 through 9, and go to step 10.

NOTE: If an ITU national alias point code (**aliasn** parameter) is not being changed in this procedure, skip steps 5 and 6, and go to step 7.

5. Display the existing values for the **npcfmti** parameter by entering the **rtrv-stpopts** command. The value for the **npcfmti** parameter is shown in the **NPCFMTI** field. This is an example of the possible output.

```
rlghncxa03w 05-09-17 16:02:05 GMT EAGLE5 34.0.0
STP OPTIONS
-----
NPCFMTI          4-4-4-2
```

NOTE: The **rtrv-stpopts** command output contains other fields that are not used by this procedure. If you wish to see all the fields displayed by the **rtrv-stpopts** command, see the **rtrv-stpopts** command description in the *Commands Manual*.

If you wish to change the format of the 14-bit ITU national point codes, go to “14-Bit ITU National Point Code Formats” section on page 2-10. Changing the formats of the 14-bit ITU national point codes will change how all existing 14-bit ITU national point codes are displayed in the database.

NOTE: If the current 14-bit ITU-N alias point code being changed does not have a group code assigned to it, skip step 6 and go to step 7.

NOTE: If the group code being assigned to the new 14-bit ITU-N alias point code is shown in the `rtrv-dstn` output in step 1, skip step 6 and go to step 7.

6. The group code to be assigned to the 14-bit ITU-N alias point code must be shown in either the `rtrv-sid` or `rtrv-spc` outputs. If step 2 (`rtrv-sid` command) was performed in this procedure, and the desired group code is shown in step 2, go to step 7.

If step 2 was not performed in this procedure, enter the `rtrv-sid` command. See step 2 for an example of the output. If the desired group code is shown in the `rtrv-sid` output, go to step 7.

If the desired group code is not shown in the `rtrv-sid` output, verify the group codes in the `rtrv-spc` output.

If step 4 (`rtrv-spc` command) was performed in this procedure, and the desired group code is shown in step 4, go to step 7.

If step 4 was not performed in this procedure, enter the `rtrv-spc` command. See step 4 for an example of the output. If the desired group code is shown in the `rtrv-spc` output, go to step 7.

If the desired group code is not shown in the `rtrv-spc` output, add a secondary point code with the desired group code by performing the “Adding a Point Code to the Self-Identification of the EAGLE 5 SAS” procedure on page 2-81.

NOTE: If new alias point codes are not being added in this procedure, skip steps 7, 8, and 9, and go to step 10.

NOTE: If the DPC quantity shown in the `rtrv-dstn` output in step 1 is from 6001 to 8000, skip step 7 and go to step 8.

7. Verify that either 6000, 7000, or 8000 routesets are enabled by entering the `rtrv-ctrl-feat` command. The following is an example of the possible output.

```
rlghncxa03w 05-09-28 21:15:37 GMT EAGLE5 34.0.0
The following features have been permanently enabled:

Feature Name           Partnum   Status   Quantity
IPGWx Signaling TPS   893012814 on       20000
ISUP Normalization    893000201 on       ----
Command Class Management 893005801 on       ----
LNP Short Message Service 893006601 on       ----
Intermed GTT Load Sharing 893006901 on       ----
```

Configuring Destination Tables

```
XGTT Table Expansion      893006101  on   4000000
XMAP Table Expansion      893007710  on   3000
Large System # Links     893005901  on   1500
Routesets                 893006401  on   6000
HC-MIM SLK Capacity      893012707  on    64
```

The following features have been temporarily enabled:

```
Feature Name          Partnum  Status  Quantity  Trial Period Left
Zero entries found.
```

The following features have expired temporary keys:

```
Feature Name          Partnum
Zero entries found.
```

8. The number of routesets enabled are shown in the `rtrv-ctrl-feat` output in step 7 with the quantity of 6000, 7000, or 8000 in the `Routesets` row. If 6000, 7000, or 8000 routesets are not enabled, the EAGLE 5 SAS can contain a maximum of either 2000 or 5000 routesets. The routeset quantity enabled is also shown by the DPC quantity in the `rtrv-dstn` output in step 1. If the DPC quantity is from 6001 to 8000, either 7000 or 8000 routesets have been enabled.

If 7000 or 8000 routesets are enabled, the EAGLE 5 SAS can contain a maximum of 8000 alias point codes. If 7000 or 8000 routesets are not enabled, the EAGLE 5 SAS can contain a maximum of 12000 alias point codes.

If the alias point code being added will exceed the maximum number of alias point codes the EAGLE 5 SAS is allowed to have, other alias point codes will have to be removed before this alias point code can be added.

To remove an alias point code, enter the `chg-dstn` command with the DPC containing the alias point code being removed, and with the value `none` for the `aliasa/aliasi/aliasn/aliasn24` parameter. For this example, enter this command.

```
chg-dstn:dpcn=10-15-2-3-fr:aliasa=none:aliasi=none
```

When this command has successfully completed, and the Cluster Routing and Management Diversity feature is turned off (`CRMD = off` in the `rtrv-feat` command output), this message should appear.

```
rlghncxa03w 05-09-17 15:35:05 GMT EAGLE5 34.0.0
Destination table is (24 of 2000) 1% full
Alias table is (29 of 8000) 1% full
CHG-DSTN: MASP A - COMPLTD
```

If the Cluster Routing and Management Diversity feature is turned on (`CRMD = on` in the `rtrv-feat` command output), this message should appear when each command has successfully completed.

```
rlghncxa03w 05-09-17 15:35:05 GMT EAGLE5 34.0.0
DESTINATION ENTRIES ALLOCATED: 2000
  FULL DPC(s):                21
  NETWORK DPC(s):              1
  CLUSTER DPC(s):              2
  TOTAL DPC(s):                24
```

```

CAPACITY (% FULL):          1%
ALIASES ALLOCATED:          8000
ALIASES USED:                29
CAPACITY (% FULL):          1%
X-LIST ENTRIES ALLOCATED:    500
CHG-DSTN: MASP A - COMPLTD

```

When the **chg-dstn** command has successfully completed, go to step 8 to add the new alias point code.

If you do not wish to remove other alias point codes, do not perform the **chg-dstn** command to remove the alias point code. Go to step 9 and change the destination point code without adding an alias point code.

If the alias point code being added will not exceed the maximum number of alias point codes the EAGLE 5 SAS is allowed to have, go to step 9 and change the destination point code and add the new alias point code.

NOTE: If the **rtrv-dstn** command output in step 1 shows point codes of the same type as the new alias point code you wish to assign to the destination point code being changed in this procedure, skip step 9 and go to step 10.

ANSI point codes are shown in the **DPCA** and **ALIASA** fields. ITU-I or ITU-I Spare point codes are shown in the **DPCI** and **ALIASI** fields. 14-bit ITU-N or 14-bit ITU-N Spare point codes are shown in the **DPCN** and **ALIASN/24** fields. 24-bit ITU-N point codes are shown in the **DPCN24** and **ALIASN/24** fields. The EAGLE 5 SAS can contain either 14-bit ITU-N or 24-bit ITU-N point codes, but not both types of point codes at the same time.

9. The EAGLE 5 SAS must contain point codes with the same network type as the new alias point code being assigned to the destination point code being changed in this procedure. For example, if the new alias point code is an ITU international point code, then ITU international point codes must be shown in the **rtrv-sid** output.

If steps 2 or 6 (**rtrv-sid** command) were performed in this procedure, and a point code of the same type as the new alias point code is shown in the **rtrv-sid** output (see step 2 for an example of the output), go to step 10.

If step 2 was not performed in this procedure, enter the **rtrv-sid** command. See step 2 for an example of the output. If a point code of the same type as the new alias point code is shown in the **rtrv-sid** output, go to step 10.

To enter an ANSI alias point code, a ANSI point code must be shown in the **PCA** field of the **rtrv-sid** output.

To enter an ITU-I non-spare alias point code, an ITU-I non-spare point code must be shown in the **PCI** field of the **rtrv-sid** output.

To enter an ITU-I spare alias point code, an ITU-I spare point code must be shown in the **PCI** field of the **rtrv-sid** output.

Configuring Destination Tables

To enter a 14-bit ITU-N non-spare alias point code, a 14-bit non-spare point code must be shown in the **PCN** field of the **rtrv-sid** output. To enter a 14-bit ITU-N spare alias point code, a 14-bit ITU-N spare point code must be shown in the **PCN** field of the **rtrv-sid** output. If 14-bit ITU-N alias point codes (spare or non-spare point codes) with group codes are being provisioned in this procedure, the point code value in the **PCN** field must have a group code assigned to it.

To enter a 24-bit ITU-N alias point code, a 24-bit ITU-N point code must be shown in the **PCN24** field of the **rtrv-sid** output.

If a point code of the same type as the new alias point code is not shown in the **rtrv-sid** output, add a point code of the same network type as the new alias point code by performing the "Adding a Point Code to the Self-Identification of the EAGLE 5 SAS" procedure on page 2-81.

-
10. Change the destination point code, using the **chg-dstn** command. For this example, enter this command.

```
chg-dstn:dpca=240-012-007:c11i=1s09c11i:bei=no:aliasi=2-66-1
:aliasn=0-10-13-3-fr:spca=003-010-010
```

If the destination point code being changed is an X.25 destination point code, only the **bei** and **c11i** parameters can be specified with the **chg-dstn** command.

If the **aliasn** parameter is specified with the **chg-dstn** command, make sure that the format of the ITU national alias point code matches the format shown in the **NPCFMTI** field of the **rtrv-stpopts** command output shown in step 5.

When this command has successfully completed, and the Cluster Routing and Management Diversity feature is turned off (**CRMD = off** in the **rtrv-feat** command output), this message should appear.

```
rlghncxa03w 05-09-17 15:35:05 GMT EAGLE5 34.0.0
Destination table is (24 of 2000) 1% full
Alias table is (29 of 8000) 1% full
CHG-DSTN: MASP A - COMPLTD
```

If the Cluster Routing and Management Diversity feature is turned on (**CRMD = on** in the **rtrv-feat** command output), this message should appear when each command has successfully completed.

```
rlghncxa03w 05-09-17 15:35:05 GMT EAGLE5 34.0.0
DESTINATION ENTRIES ALLOCATED: 2000
  FULL DPC(s): 21
  NETWORK DPC(s): 1
  CLUSTER DPC(s): 2
  TOTAL DPC(s): 24
  CAPACITY (% FULL): 1%
ALIASES ALLOCATED: 8000
  ALIASES USED: 29
  CAPACITY (% FULL): 1%
X-LIST ENTRIES ALLOCATED: 500
CHG-DSTN: MASP A - COMPLTD
```

11. Verify the changes using the **rtrv-dstn** command, and specifying the destination point code that was entered in step 10.
- If an ANSI destination point code was changed in step 10, use the **dpca** parameter to display the attributes of the destination point code.
 - If an ITU international destination point code was changed in step 10, use the **dpci** parameter to display the attributes of the destination point code.
 - If a 14-bit ITU national destination point code was changed in step 10, use the **dpcn** parameter to display the attributes of the destination point code.
 - If a 24-bit ITU national destination point code was changed in step 10, use the **dpcn24** parameter to display the attributes of the destination point code.

For this example, enter this command.

```
rtrv-dstn:dpca=240-012-007
```

This is an example of the possible output.

```
rlghncxa03w 05-09-28 21:16:37 GMT EAGLE5 34.0.0
  DPCA          CLLI          BEI ELEI  ALIASI          ALIASN/N24  DOMAIN
  240-012-007  ls09clli          no  ---  2-66-1          0-10-13-3-fr  SS7

                SPC          NCAI
                003-010-010  no

DESTINATION ENTRIES ALLOCATED:  2000
  FULL DPC(s) :                   21
  NETWORK DPC(s) :                   1
  CLUSTER DPC(s) :                   2
  TOTAL DPC(s) :                   24
  CAPACITY (% FULL) :                   1%
ALIASES ALLOCATED:                   8000
  ALIASES USED:                       29
  CAPACITY (% FULL) :                   1%
X-LIST ENTRIES ALLOCATED:             500
RTRV-DSTN: MASP A - COMPLTD
```

12. Back up the new changes, using the **chg-db:action=backup:dest=fixed** command. These messages should appear; the active Maintenance and Administration Subsystem Processor (MASP) appears first.

```
BACKUP (FIXED) : MASP A - Backup starts on active MASP.
BACKUP (FIXED) : MASP A - Backup on active MASP to fixed disk complete.
BACKUP (FIXED) : MASP A - Backup starts on standby MASP.
BACKUP (FIXED) : MASP A - Backup on standby MASP to fixed disk complete.
```

Flowchart 2-13. Changing a Destination Point Code (Sheet 1 of 9)

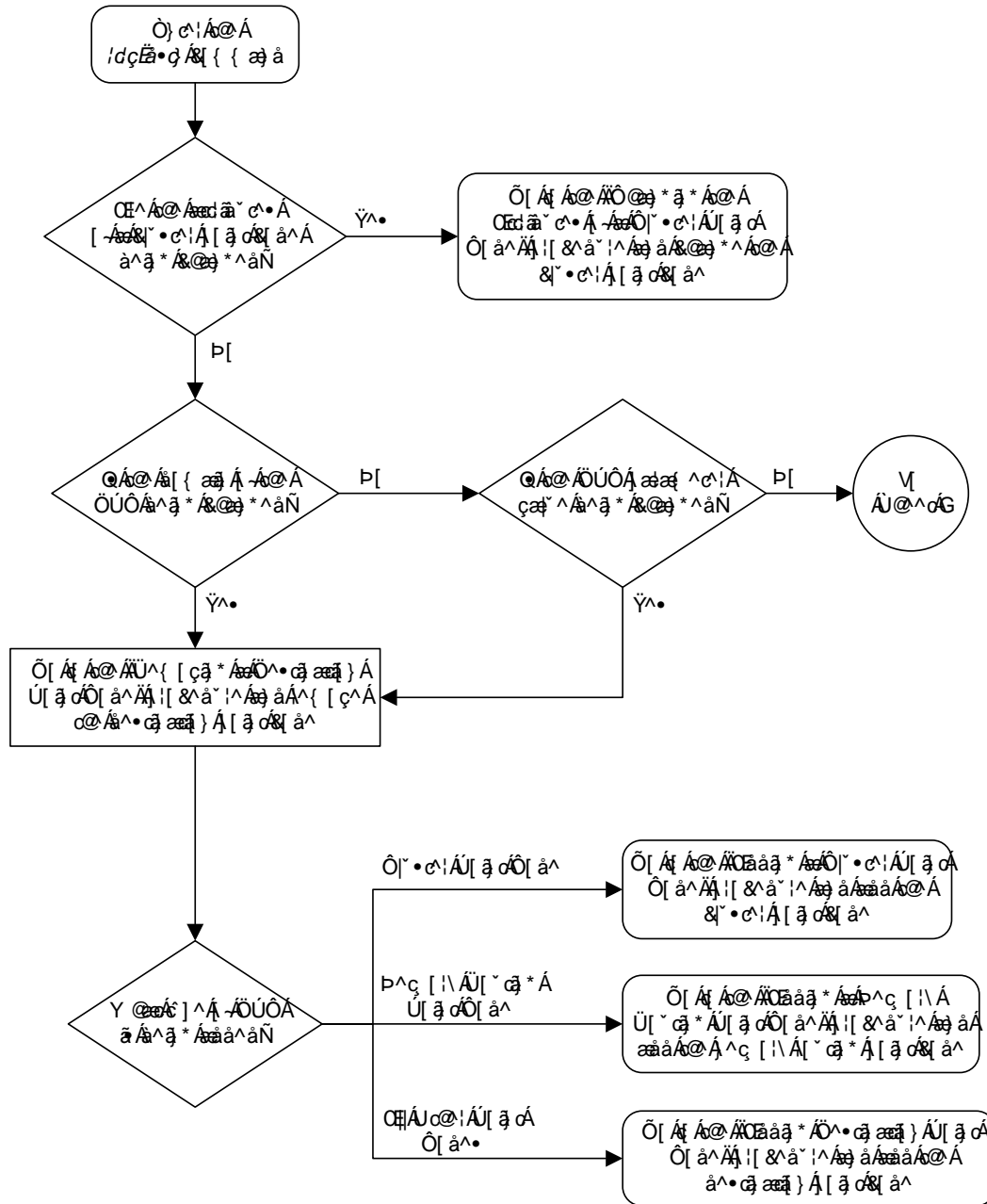

Flowchart 2-13. Changing a Destination Point Code (Sheet 2 of 9)

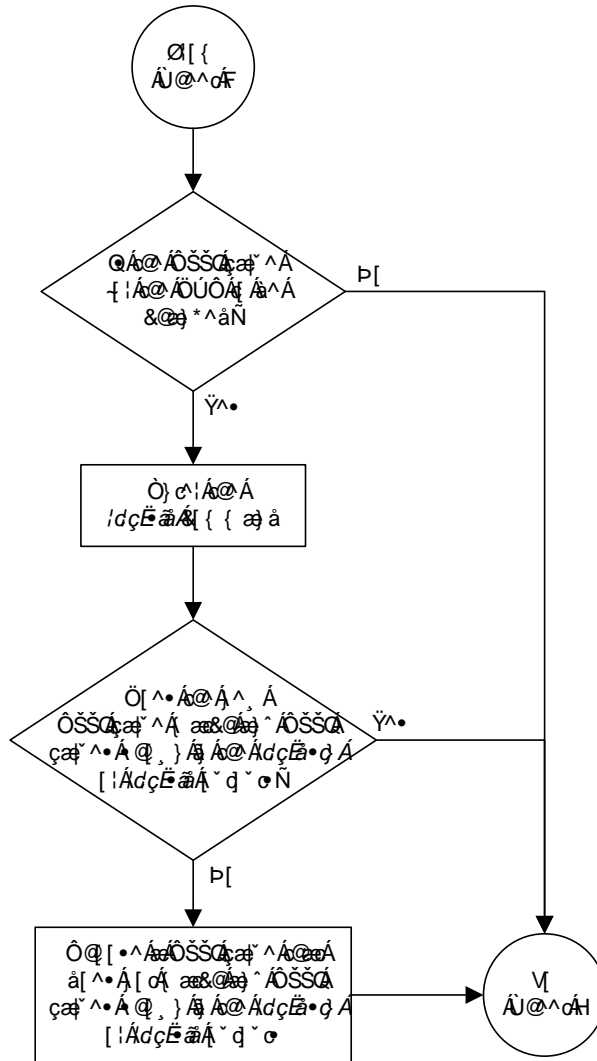

Flowchart 2-13. Changing a Destination Point Code (Sheet 3 of 9)

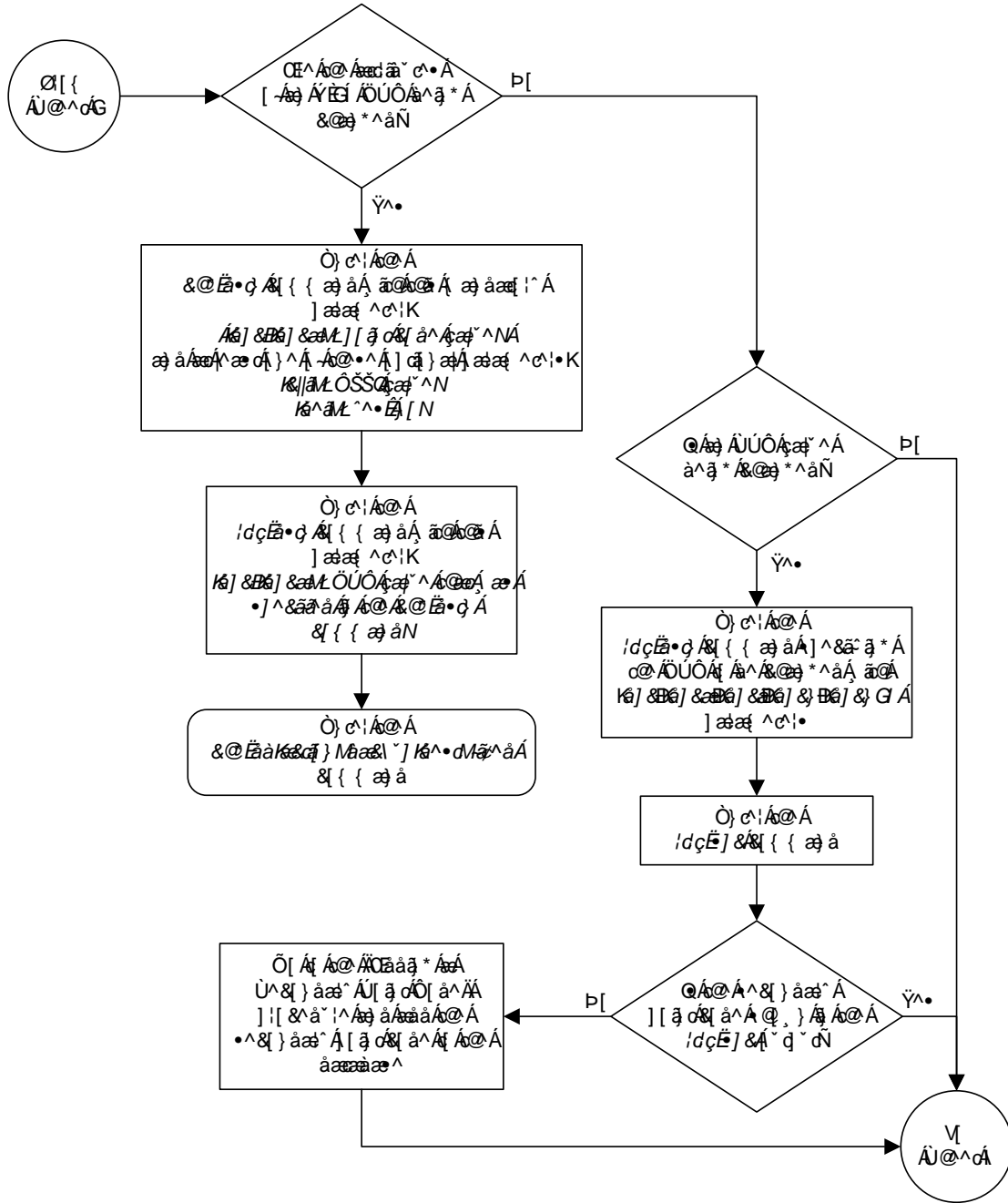

Flowchart 2-13. Changing a Destination Point Code (Sheet 4 of 9)

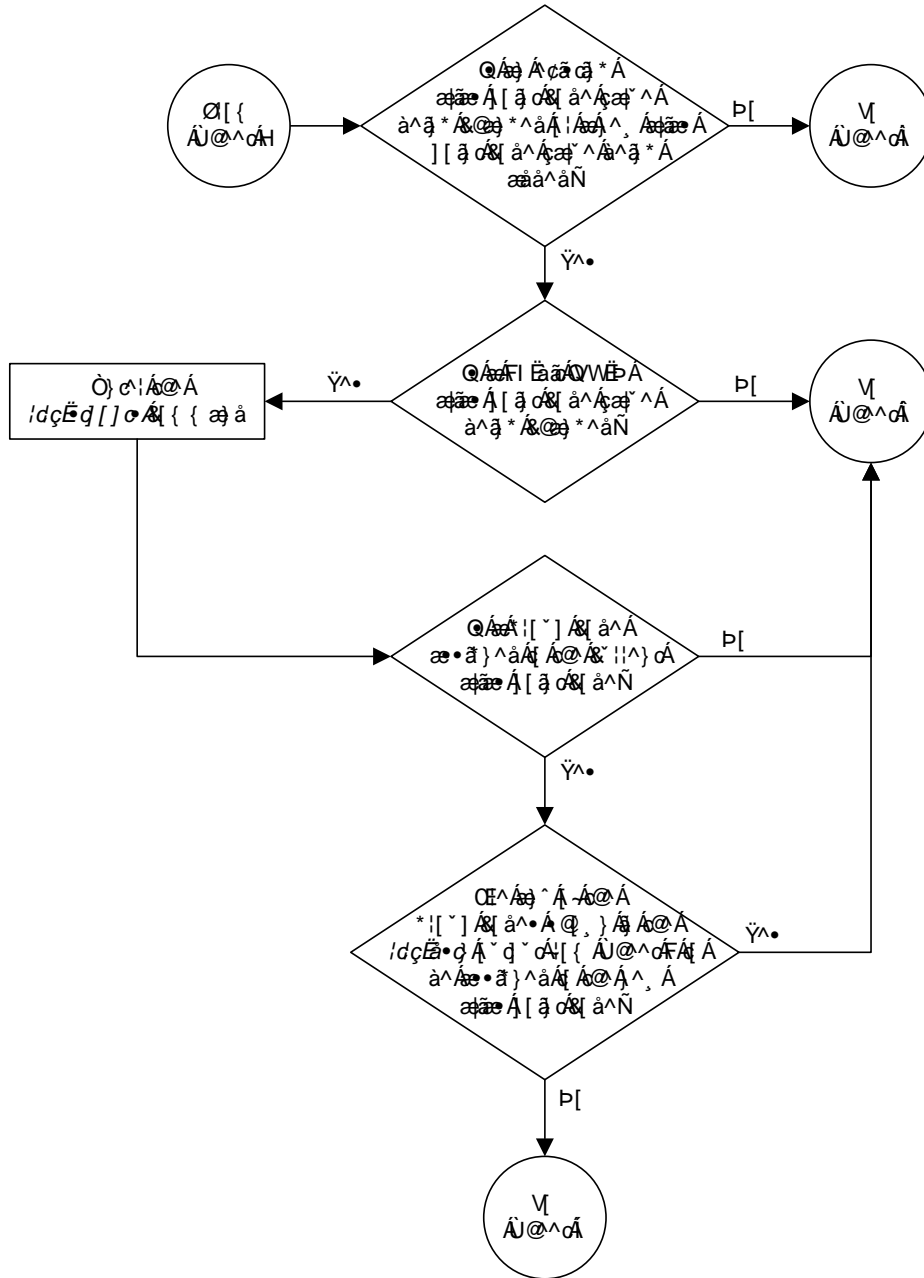

Configuring Destination Tables

Flowchart 2-13. Changing a Destination Point Code (Sheet 5 of 9)

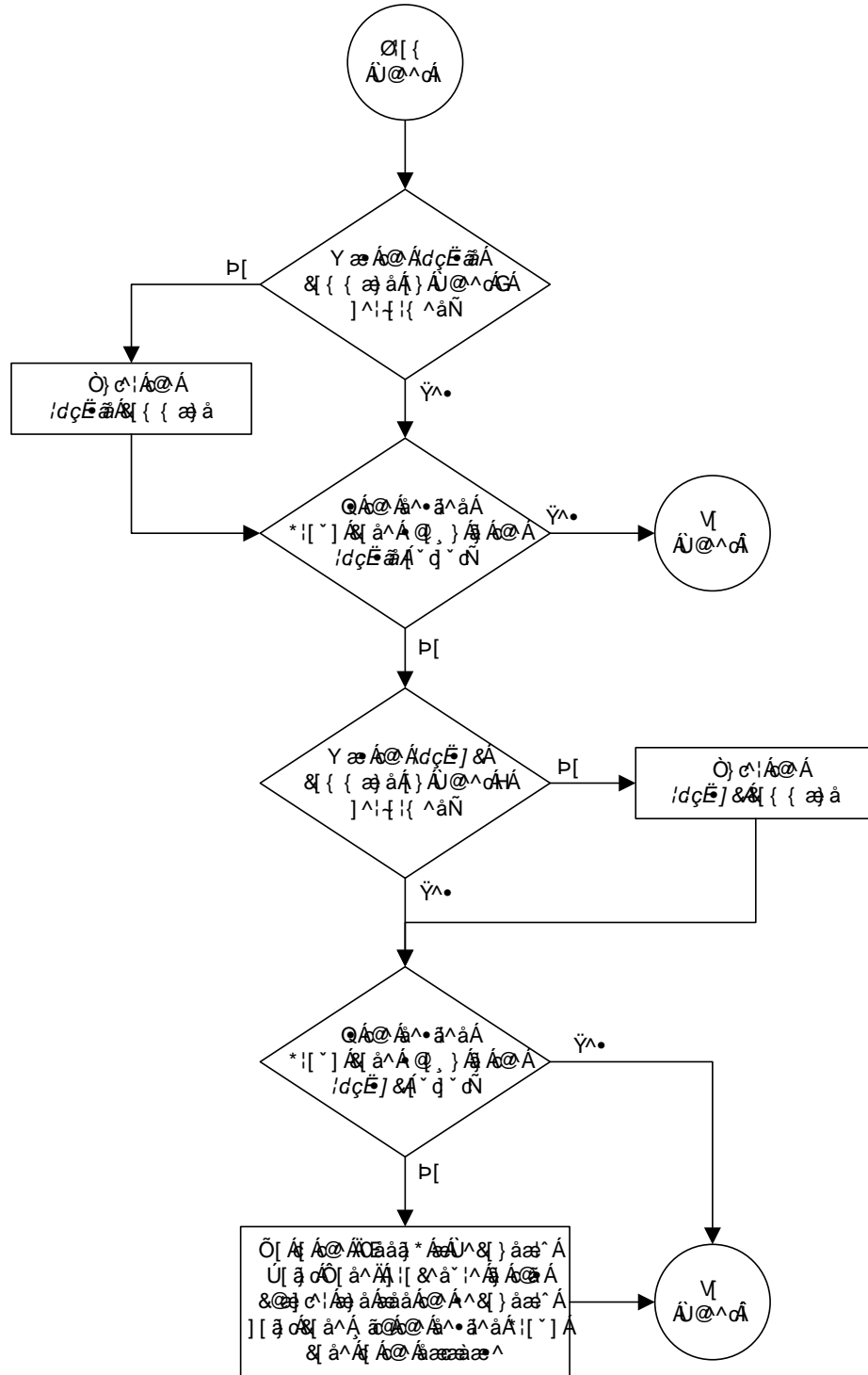

Flowchart 2-13. Changing a Destination Point Code (Sheet 6 of 9)

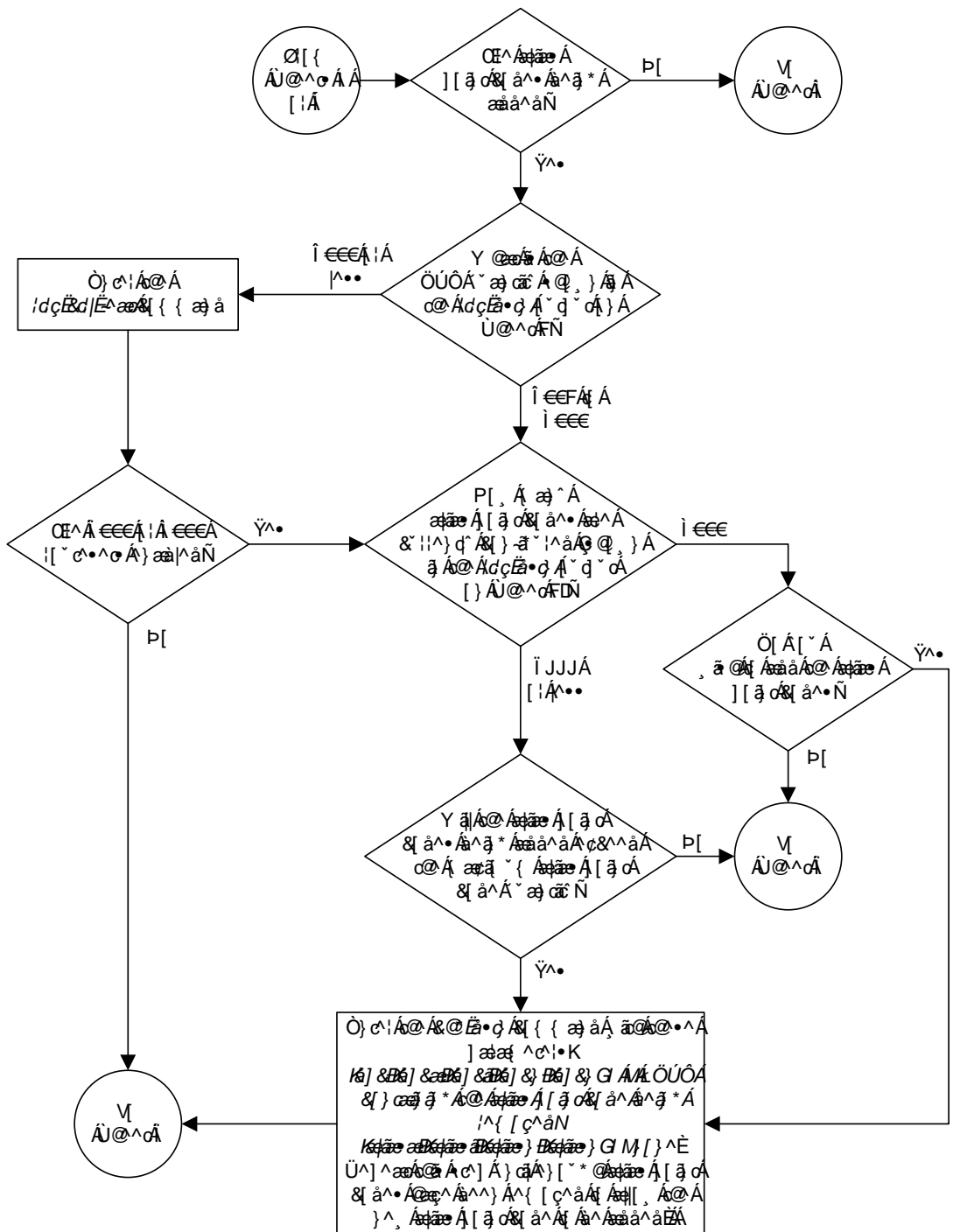

Configuring Destination Tables

Flowchart 2-13. Changing a Destination Point Code (Sheet 7 of 9)

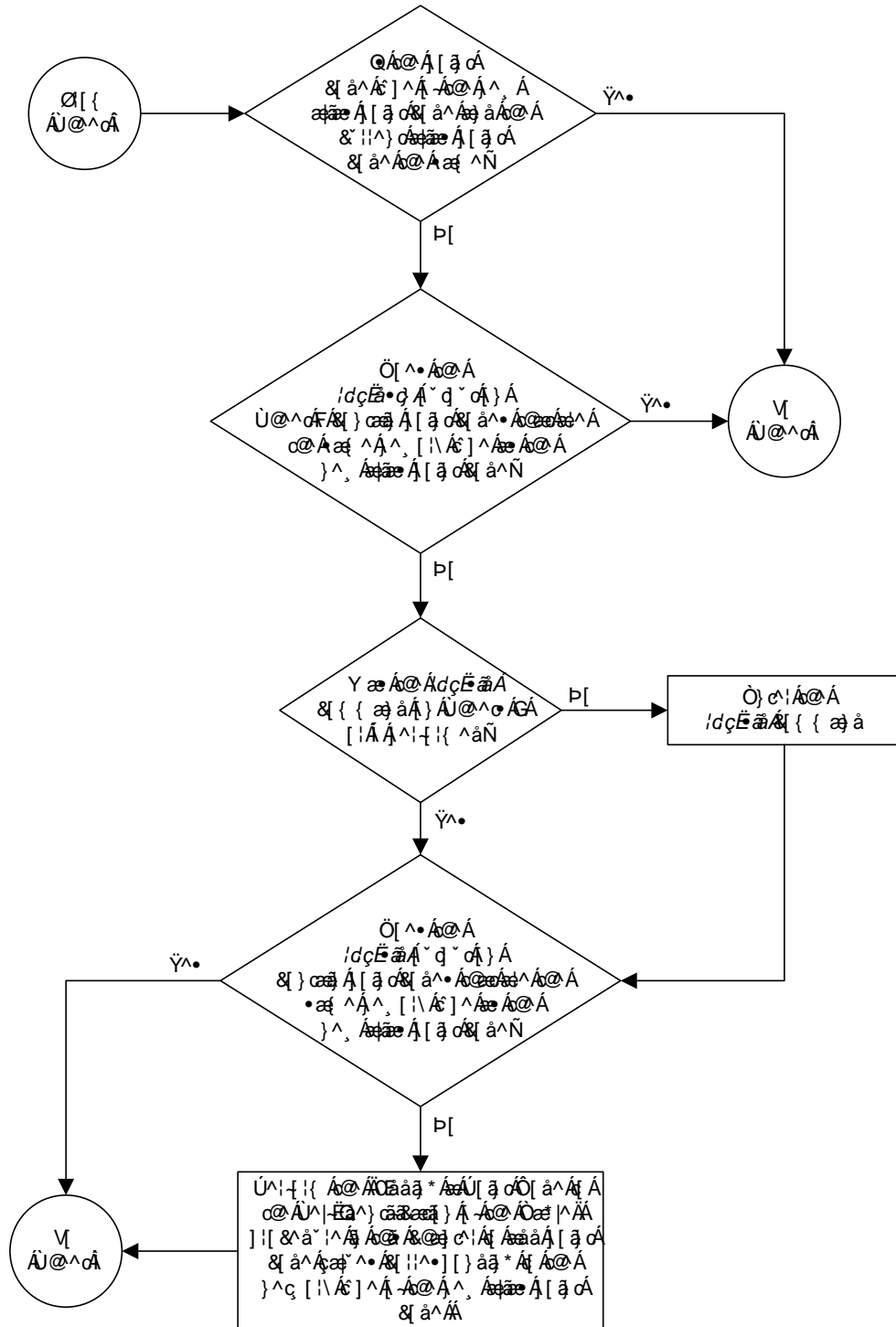

Flowchart 2-13. Changing a Destination Point Code (Sheet 8 of 9)

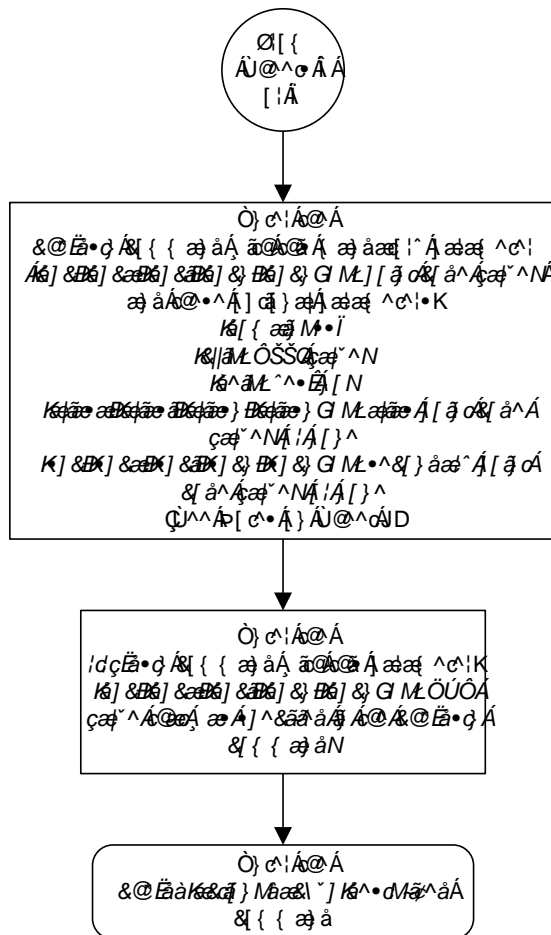

Changing the Group Code Assigned to a 14-Bit ITU National Point Code

This procedure is used to change the group code that is assigned to a 14-bit ITU national point code. The 14-bit ITU national point code to be changed must be in the database.

To change a group code assigned to a ITU national point code, a duplicate point code with the new group code must be configured in the database with a route, linkset, and signaling link to the new destination. Then the 14-bit ITU national point code with the old group code with its route can be removed from the database.

The **chg-dstn** command cannot be used to change the group code assigned to 14-bit ITU national point codes.

The examples in this procedure are used to remove the group code assigned to ITU national destination point code **7-9-10-1-aa** to **7-9-10-1-de**. The format of the 14-bit ITU national point codes used in these examples is 4-4-4-2.

Canceling the **RTRV-DSTN** and **RTRV-RTE** Commands

Because the **rtrv-dstn** and **rtrv-rte** commands used in this procedure can output information for a long period of time, the **rtrv-dstn** and **rtrv-rte** commands can be canceled and the output to the terminal stopped. There are three ways that the **rtrv-dstn** and **rtrv-rte** commands can be canceled:

- Press the **F9** function key on the keyboard at the terminal where the **rtrv-dstn** or **rtrv-rte** command was entered
- Enter the **canc-cmd** without the **trm** parameter at the terminal where the **rtrv-dstn** or **rtrv-rte** command was entered
- Enter the **canc-cmd:trm=<xx>**, where **<xx>** is the terminal where the **rtrv-dstn** or **rtrv-rte** command was entered, from another terminal other than the terminal where the **rtrv-dstn** or **rtrv-rte** command was entered. To enter the **canc-cmd:trm=<xx>** command, the terminal must allow Security Administration commands to be entered from it and the user must be allowed to enter Security Administration commands. The terminal's permissions can be verified with the **rtrv-secu-trm** command. The user's permissions can be verified with the **rtrv-user** or **rtrv-secu-user** commands.

For more information about the **canc-cmd** command, refer to the *Commands Manual*.

Procedure

1. Display all the attributes of the 14-bit ITU national point code whose group code is being changed, using the **rtrv-dstn** command with the **dpcn** parameter.

For this example, enter this command.

rtrv-dstn:dpcn=7-9-10-1-aa

This is an example of the possible output.

```
rlghncxa03w 05-09-28 21:16:37 GMT EAGLE5 34.0.0
  DPCN          CLLI          BEI  ELEI  ALIASA          ALIASI          DOMAIN
  7-9-10-1-aa  ----- no   ---   210-090-100    1-75-6          SS7

                SPC          NCAI
                13-2-12-0-aa no
```

```
Destination table is (17 of 2000) 1% full
Alias table is (8 of 8000) 1% full
RTRV-DSTN: MASP A - COMPLTD
```

2. Display the route configuration of the 14-bit ITU national point code specified in step 1, by entering the **rtrv-rte** command with the **dpcn** parameter. For this example, enter this command.

rtrv-rte:dpcn=7-9-10-1-aa

This is an example of the possible output.

```
rlghncxa03w 05-09-17 16:02:05 GMT EAGLE5 34.0.0
  DPCN          ALIASA          ALIASI  LSN          RC    APC
  7-9-10-1-aa  210-090-100    1-75-6  1s04         10   10-4-15-1-aa
                1s02         20   12-11-2-0-aa
                1s03         30   8-1-15-2-aa
                                     CLLI=1s04clli
```

3. Go to the “Removing a Destination Point Code” procedure on page 2-214 and add the duplicate ITU national point code with the new group code. For this example, the new point code is **7-9-10-1-de**.

4. Go to the “Removing a Destination Point Code” procedure on page 2-214 and remove the 14-bit ITU national point code with the old group code, specified in steps 1 and 2. This procedure will also remove the route to the point code with the old group code, the linkset used by this route, and the signaling links in that linkset. Record the configuration of the signaling links in the linkset. This information will be used to restore these signaling links in step 6.

NOTE: If the DPC specified in step 2 is not the adjacent point code of a linkset, shown in the APCN field of the `rtrv-rte` output, skip steps 5 and 6 and go to substep b of step 7.

5. Go to the “Adding an SS7 Linkset” procedure on page 3-17 and add a new linkset to the database containing the 14-bit ITU national point code with the new group code specified in step 3 as the APC of the linkset.

6. Go to the “Adding an SS7 Signaling Link” procedure on page 3-130 and add the signaling links that were removed by the “Removing a Destination Point Code” procedure in step 4 and specifying the linkset name of the linkset that was added in step 5.

7. If the DPC specified in step 2 is the adjacent point code of a linkset and a new linkset was created in step 5, then go to substep a. If the DPC specified in step 2 is not the adjacent point code of a linkset, then go to substep b. Do not perform substeps a and b.
 - a. Perform one of the “Adding a Route” procedures in Chapter 3 and add the route to the 14-bit ITU national point code with the new group code specifying the name of the linkset created in step 5 and the 14-bit ITU national point code with the new group code from step 3.
 - b. Perform one of the “Adding a Route” procedures in Chapter 3 and add the route to the 14-bit ITU national point code with the new group code specifying the 14-bit ITU national point code with the new group code from step 3.

8. Back up the new changes, using the `chg-db:action=backup:dest=fixed` command. These messages should appear; the active Maintenance and Administration Subsystem Processor (MASP) appears first.

```
BACKUP (FIXED) : MASP A - Backup starts on active MASP.
BACKUP (FIXED) : MASP A - Backup on active MASP to fixed disk complete.
BACKUP (FIXED) : MASP A - Backup starts on standby MASP.
BACKUP (FIXED) : MASP A - Backup on standby MASP to fixed disk complete.
```

Flowchart 2-14. Changing the Group Code Assigned to a 14-Bit ITU National Point Code

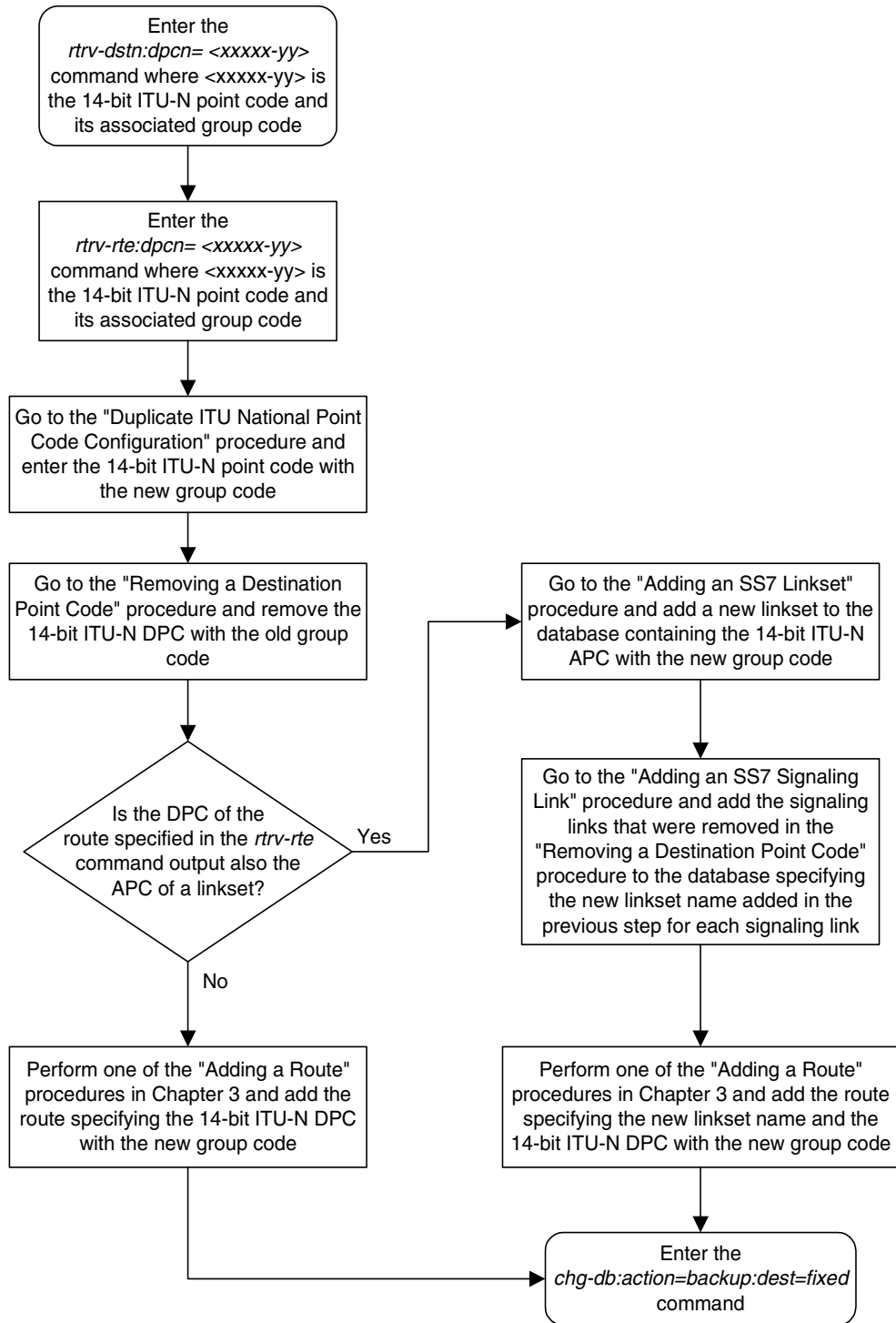

3

SS7 Configuration

Introduction.....	3-3
Enabling the Large System # Links Controlled Feature.....	3-10
Adding an SS7 Linkset.....	3-17
Removing a Linkset Containing SS7 Signaling Links	3-63
Changing an SS7 Linkset	3-74
Configuring an ITU Linkset with a Secondary Adjacent Point Code (SAPC).....	3-113
Adding an SS7 Signaling Link.....	3-130
Removing an SS7 Signaling Link	3-145
Adding a Route Containing an SS7 DPC	3-153
Adding a Route Containing a Cluster Point Code	3-164
Adding a Route Containing an IPGWx Linkset.....	3-172
Adding a Route Containing an X.25 DPC.....	3-181
Removing a Route	3-189
Changing a Route	3-206
Changing Level 2 Timers.....	3-219
Changing Level 3 Timers.....	3-222
Changing a Signaling Link Test Message.....	3-228
Configuring Circular Route Detection	3-231
Configuring the TFA/TFR Pacing Rate.....	3-235

Configuring the Frequency of RST Messages on Low Priority Routes.....	3-238
Adding Remote Loopback Points.....	3-241
Removing Remote Loopback Points.....	3-247
Changing Remote Loopback Points.....	3-250
Configuring the System for Random SLS Generation	3-254
Configuring the Options for the TDM Global Timing Interface.....	3-263
Configuring the Restricted Linkset Option.....	3-269
Configuring the Options for Handling TFCs on ITU-I and ITU-N Networks	3-276
Changing the HC MIM Temperature Alarm Thresholds.....	3-279

Introduction

This chapter contains the procedures necessary to configure the EAGLE 5 SAS to support the SS7 network. These items are configured to support the SS7 network.

- Linksets, including linksets for these features:
 - MTP restart
 - 5-Bit to 8-Bit SLS conversion
 - ITU SLS enhancement
 - Configuring the option for determining how the EAGLE 5 SAS routes messages over restricted linksets and routes - the restricted linkset option.
 - Configuring the options for determining how the EAGLE 5 SAS handles TFC messages from ITU-I and ITU-N networks.
- Signaling links
- Routes
- Level 2 timers
- Level 3 timers
- Signaling link test messages
- The rate that TFA and TFP messages are sent
- Circular route detection
- The frequency that signaling-route-set-test (RST) messages are sent for lower priority routes
- Remote loopback points for the link fault sectionalization feature
- Options for the TDM Global Timing Interface
- Configuring the HC MIM temperature alarm thresholds.

Figure 3-1 on page 3-4 shows the relationships of the database elements that are configured in these procedures.

Figure 3-1. SS7 Database Relationships

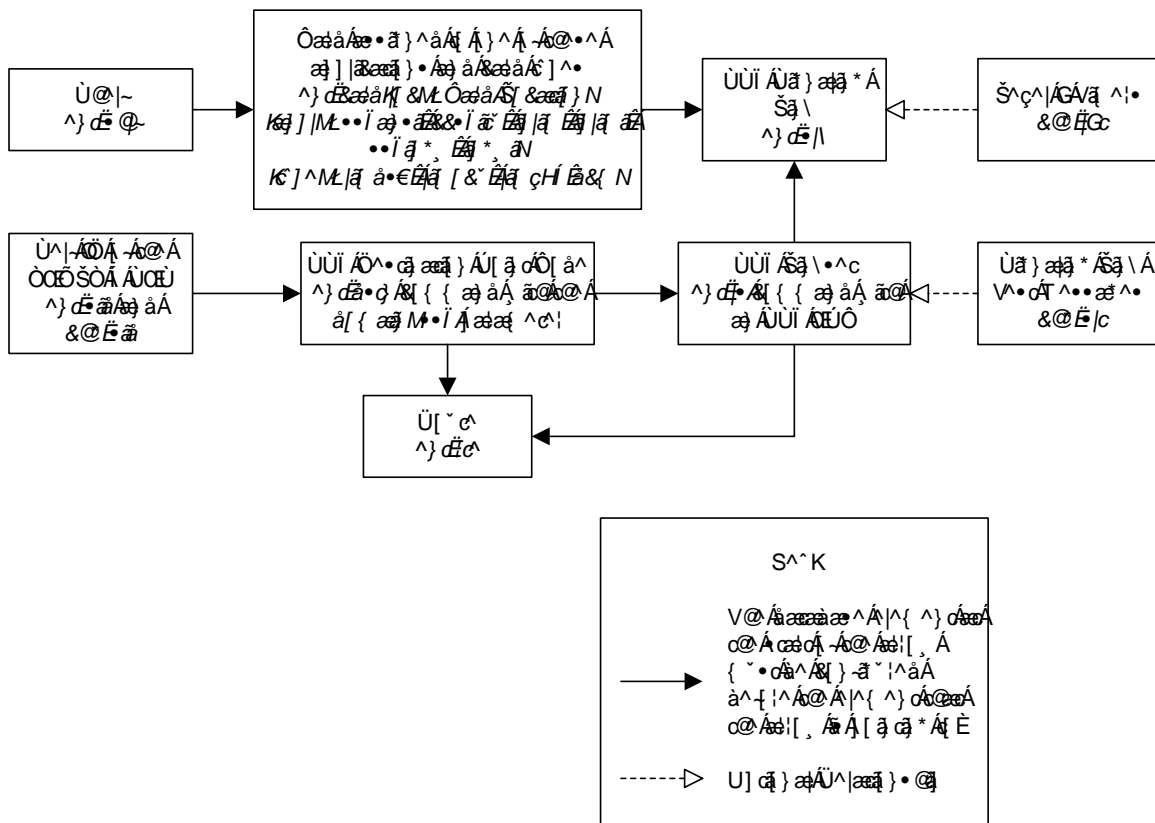

The procedures shown in this chapter use a variety of commands. If more information on these commands is needed, go to the *Commands Manual* to find the required information.

In addition to the items discussed in this section, other entities must be configured in the database to support the SS7 network. The entities that are required for the particular SS7 entity are listed with the particular procedure. They are also shown here to give an overview of what is required to configure the EAGLE 5 SAS to support the SS7 network. These entities (shown in Figure 3-1) must also be configured in the order that they are shown.

1. Make sure that the required shelf is in the database with the `rtrv-shlf` command. If it is not in the database, go to the "Adding a Shelf" procedure in the *Database Administration Manual - System Management* and add it with the `ent-shlf` command.

SS7 Configuration

2. Make sure the cards that the SS7 signaling links will be assigned to are in the database with the `rtrv-card` command. These cards must be LIMs or DCMs. The LIMs must have either the `limds0`, `limocu`, or `limv35` card type and either the `ss7ansi`, or `ccs7itu` application assigned to them. The DCMs must have the card type `dcm` and either the `iplim`, `iplimi`, `ss7ipgw`, or `ipgwi` application assigned to it. Table 3-1 shows the application type(s) valid for LIM and DCM signaling card types and the signaling link assignment. The `ss7ansi`, `iplim`, and `ss7ipgw` applications are used for signaling links assigned to linksets with ANSI adjacent point codes (APCs). The `ccs7itu`, `iplimi`, and `ipgwi` applications are used for signaling links assigned to linksets with ITU APCs (ITU international or ITU national point codes - 14-bit or 24-bit ITU-N point codes). The `iplim`, `iplimi`, `ss7ipgw`, and `ipgwi` applications are used for SS7-IP connectivity.

Table 3-1. SS7 Signaling Link Card Types and Applications

Application Type	Card Type				Signaling Link Assignment
	limds0	limocu	limv35	dcm	
ccs7itu	X	X	X		to linksets with ITU adjacent point codes
ss7ansi	X	X	X		to linksets with ANSI adjacent point codes
iplim				X	to TCP/IP ANSI adjacent point codes
iplimi				X	to TCP/IP ITU adjacent point codes
ss7ipgw				X	to TCP/IP ANSI adjacent point codes
ipgwi				X	to TCP/IP ITU adjacent point codes

If these cards are not in the database, add them with the `ent-card` command, specifying a card type and an application. To add a LIM card, go to the “Adding an SS7 LIM” procedure in the *Database Administration Manual - System Management*. To add a DCM card for SS7-IP connectivity, go to the “Adding an IP Card” procedure in the *Database Administration Manual - IP⁷ Secure Gateway*.

3. The SS7 network configuration for the EAGLE 5 SAS requires linksets and routes. These entities use point codes and these point codes must be defined in the database. When nodes in different networks wish to communicate, each node must have either a true point code (TPC) or an alternate point code for each of the two network types involved. For example, if node1 in an ANSI network wishes to communicate with node2 in an ITU-N network, node1 must have an ANSI TPC and an ITU-N alternate point code; and node2 must have an ITU-N TPC and an ANSI alternate point code. For internetwork

communication, the MTP3 routing label is converted. Conversions that fail, result in discarded MSUs with appropriate MRN outputs to the user terminals, for example, MRN 1091: RPT_MRN_UNKNOWN_DPC.

Verify that the necessary point codes are in the database with the **rtrv-dstn** command. If they are not in the database, go to the “Adding a Destination Point Code” procedure on page 2-191 and add them with the **ent-dstn** command. The point codes must be assigned to the SS7 domain.

4. The linksets that will contain the SS7 signaling links must be in the database. A linkset is a group of links that terminate into the same adjacent point code. All links in the linkset can transport compatible MSU formats. The network type of the adjacent point code assigned to the linkset determines the network type of the linkset. These linksets must be assigned an adjacent point code (APC) that is in the SS7 domain. Verify this with the **rtrv-ls** command. If the APC is in the SS7 domain, the entry **ss7** is shown in the **DOMAIN** field of the output. Mated nodes are connected through C links. Since each destination is only reachable by linksets that match that destination's network type, mated nodes require a C-link linkset for each network the node is connected to. For nodes with three true point codes (TPCs), there needs to be a C linkset to transport ANSI formatted MSUs, a C linkset to transport ITU-N formatted MSUs, and a C linkset to transport ITU-I formatted MSUs. A TPC uniquely identifies the node in the network.

If the necessary linksets are not in the database, go to the “Adding an SS7 Linkset” procedure on page 3-17 and add them with the **ent-ls** command. Specify an APC that is in the database and in the SS7 domain added in step 3. The APC of the linkset must be a true point code and not an alias point code. The **apc** parameter must be of the same type as the DPC chosen in step 3.

5. The SS7 signaling links must be in the database. Verify this with the **rtrv-slk** command. The SS7 signaling links are assigned to linksets in the SS7 domain from step 4. SS7 signaling links are assigned to LIMs with the **ss7ansi** or **ccs7itu** application or to DCMs with the **iplim**, **iplimi**, **ss7ipgw**, or **ipgwi** application from step 2. If the LIM's application is **ss7ansi**, then the linkset's APC must be an ANSI APC. If the LIM's application is **ccs7itu**, then the linkset's APC can be either an ITU international APC or an ITU national APC (either a 14-bit or 24-bit ITU-N point codes). If the DCM's application is **iplim** or **ss7ipgw**, then the linkset's APC must be an ANSI APC. If the DCM's application is **iplimi** or **ipgwi**, then the linkset's APC can be either an ITU international APC or an ITU national APC.

If the necessary SS7 signaling links are not in the database, go to the “Adding an SS7 Signaling Link” procedure on page 3-130 and add them with the **ent-slk** command.

SS7 Configuration

6. When SS7 signaling links for IP cards with card type `iplim`, `iplimi`, `ss7ipgw`, and `ipgwi` are added to the database, there are parameters that control the behavior of the signaling links that are not configured with the `ent-slk` command. The configuration of these values are described in the *Database Administration Manual - IP⁷ Secure Gateway*
7. The linksets must be assigned to a route. These linksets must contain APCs in the SS7 domain. The DPCs of these routes must be in the database and in the SS7 domain. Verify this with the `rtrv-rte` command. If the necessary routes are not in the database, go to one of these procedures and add the routes to the database with the `ent-rte` command, specifying a point code in the SS7 domain, from step 3, and a linkset with an SS7 APC, from step 4.
 - “Adding a Route Containing an SS7 DPC” procedure on page 3-153
 - “Adding a Route Containing a Cluster Point Code” procedure on page 3-164
 - “Adding a Route Containing an IPGWx Linkset” procedure on page 3-172
 - “Adding a Route Containing an X.25 DPC” procedure on page 3-181

By using the `iplim`, `iplimi`, `ss7ipgw`, and `ipgwi` applications, the entire EAGLE 5 SAS will be able to communicate via TCP/IP to the rest of the SS7 network elements. When properly configured, the EAGLE 5 SAS will be able to convert between any of the ANSI, ITU-N, and ITU-I networks, switch traffic between these networks, and perform network management for each of these networks.

Figure 3-2 on page 3-8 shows an example of a complex network with ANSI, ITU-I, and ITU-N nodes.

Figure 3-2. Complex Network with ANSI, ITU-I, and ITU-N Nodes

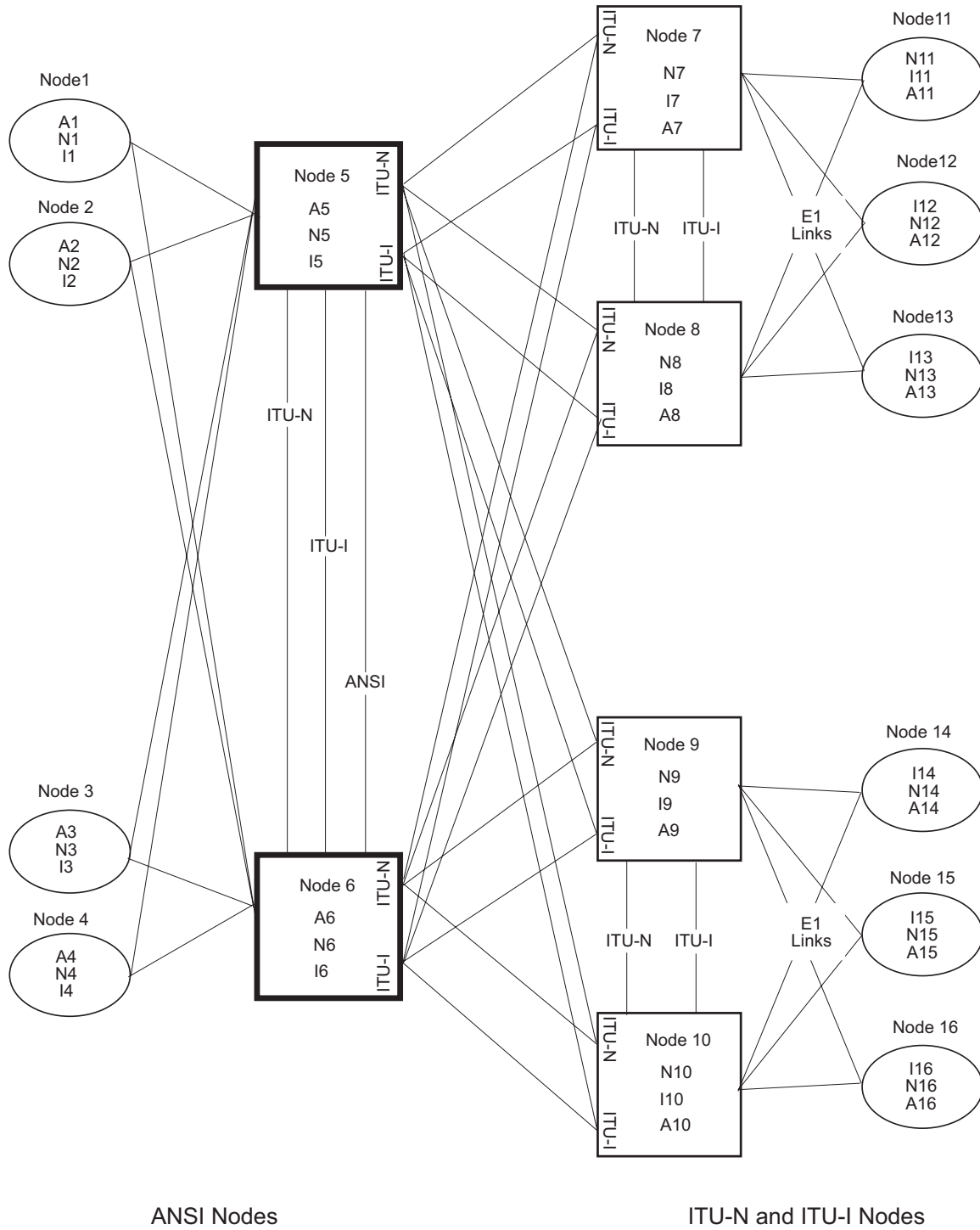

SS7 Configuration

Figure 3-3 shows a typical SS7 network configuration and is used in this chapter for example configurations. Table 3-6, "Linkset Configuration Table," on page 3-35, Table 3-11, "Low-Speed Signaling Link Configuration Table," on page 3-134 show the database information that must be configured to establish this network.

Figure 3-3. Sample SS7 Network Configuration

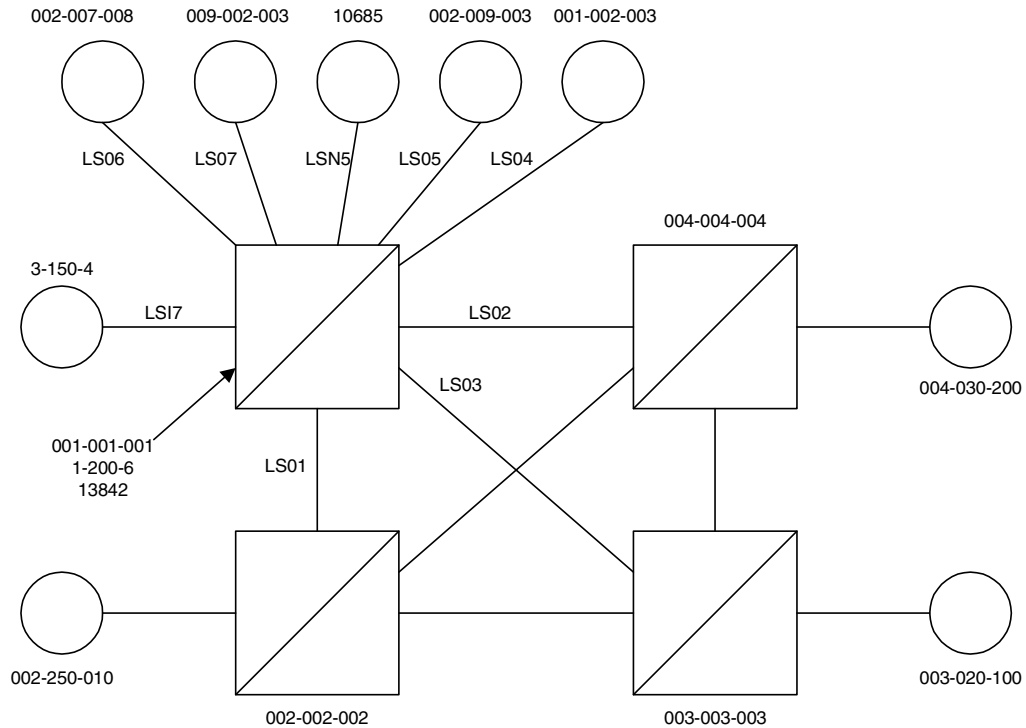

Enabling the Large System # Links Controlled Feature

This procedure is used to enable the Large System # Links controlled feature using the feature's part number and a feature access key.

The feature access key for the Large System # Links controlled feature is based on the feature's part number and the serial number of the EAGLE 5 SAS, making the feature access key site-specific.

This feature allows the EAGLE 5 SAS to contain up to 1500 signaling links. The part number for this feature is 893-0059-01.

The **enable-ctrl-feat** command enables the controlled feature by inputting the controlled feature's access key and the controlled feature's part number with these parameters:

: fak – The feature access key generated by Tekelec's feature access key generator, and supplied to you when you purchase or temporarily try a controlled feature. The feature access key contains 13 alphanumeric characters and is not case sensitive.

: partnum – The Tekelec-issued part number associated with the controlled feature. The part number is a 9-digit number, not including dashes; the first three digits must be 893 (that is, 893xxxxxx, where x is a numeric value).

The **enable-ctrl-feat** command requires that the database contain a valid serial number for the EAGLE 5 SAS, and that this serial number is locked. This can be verified with the **rtrv-serial-num** command. The EAGLE 5 SAS is shipped with a serial number in the database, but the serial number is not locked. The serial number can be changed, if necessary, and locked once the EAGLE 5 SAS is on-site, by using the **ent-serial-num** command. The **ent-serial-num** command uses these parameters.

: serial – The serial number assigned to the EAGLE 5 SAS. The serial number is not case sensitive.

: lock – Specifies whether or not the serial number is locked. This parameter has only one value, **yes**, which locks the serial number. Once the serial number is locked, it cannot be changed.

NOTE: To enter and lock the EAGLE 5 SAS's serial number, the **ent-serial-num** command must be entered twice, once to add the correct serial number to the database with the **serial** parameter, then again with the **serial** and the **lock=yes** parameters to lock the serial number. You should verify that the serial number in the database is correct before locking the serial number. The serial number can be found on a label affixed to the control shelf (shelf 1100).

This feature cannot be temporarily enabled (with the temporary feature access key).

Once this feature is enabled with the `enable-ctrl-feat` command, the feature is also activated. The `chg-ctrl-feat` command is not necessary to activate the feature.

This feature cannot be disabled with the `chg-ctrl-feat` command and the `status=off` parameter.

Procedure

1. Display the status of the Large System # Links controlled feature by entering the `rtrv-ctrl-feat` command. The following is an example of the possible output.

```
rlghncxa03w 05-09-28 21:15:37 GMT EAGLE5 34.0.0
The following features have been permanently enabled:
```

Feature Name	Partnum	Status	Quantity
IPGWx Signaling TPS	893012814	on	20000
ISUP Normalization	893000201	on	----
Command Class Management	893005801	on	----
LNP Short Message Service	893006601	on	----
Intermed GTT Load Sharing	893006901	on	----
XGTT Table Expansion	893006101	on	400000
XMAP Table Expansion	893007710	off	----
Routesets	893006401	on	6000
HC-MIM SLK Capacity	893012707	on	64

```
The following features have been temporarily enabled:
```

Feature Name	Partnum	Status	Quantity	Trial Period Left
Zero entries found.				

```
The following features have expired temporary keys:
```

Feature Name	Partnum
Zero entries found.	

If the `rtrv-ctrl-feat` output shows that the controlled feature is permanently enabled for the desired quantity or for a quantity that is greater than the desired quantity, no further action is necessary. This procedure does not need to be performed.

NOTE: If the `rtrv-ctrl-feat` output in step 1 shows any controlled features, or if the Large System # Links controlled feature is enabled for a quantity that is less than the desired quantity, skip steps 2 through 5, and go to step 6.

2. Display the serial number in the database with the `rtrv-serial-num` command. This is an example of the possible output.

```
rlghncxa03w 05-09-28 21:15:37 GMT EAGLE5 34.0.0
System serial number = nt00001231
```

```
System serial number is not locked.
```

```
rlghncxa03w 05-09-28 21:15:37 GMT EAGLE5 34.0.0
Command Completed
```

NOTE: If the serial number is correct and locked, skip steps 3, 4, and 5, and go to step 6. If the serial number is correct but not locked, skip steps 3 and 4, and go to step 5. If the serial number is not correct, but is locked, this feature cannot be enabled and the remainder of this procedure cannot be performed. Contact the Customer Care Center to get an incorrect and locked serial number changed. Refer to "Customer Care Center" on page 1-8 for the contact information. The serial number can be found on a label affixed to the control shelf (shelf 1100).

3. Enter the correct serial number into the database using the `ent-serial-num` command with the `serial` parameter.

For this example, enter this command.

```
ent-serial-num:serial=<EAGLE 5 SAS's correct serial number>
```

When this command has successfully completed, the following message should appear.

```
rlghncxa03w 05-09-28 21:15:37 GMT EAGLE5 34.0.0
ENT-SERIAL-NUM: MASP A - COMPLTD
```

4. Verify that the serial number entered into step 3 was entered correctly using the `rtrv-serial-num` command. This is an example of the possible output.

```
rlghncxa03w 05-09-28 21:15:37 GMT EAGLE5 34.0.0
System serial number = nt00001231
```

System serial number is not locked.

```
rlghncxa03w 05-09-28 21:15:37 GMT EAGLE5 34.0.0
Command Completed
```

If the serial number was not entered correctly, repeat steps 3 and 4 and re-enter the correct serial number.

5. Lock the serial number in the database by entering the `ent-serial-num` command with the serial number shown in step 2, if the serial number shown in step 2 is correct, or with the serial number shown in step 4, if the serial number was changed in step 3, and with the `lock=yes` parameter.

For this example, enter this command.

```
ent-serial-num:serial=<EAGLE 5 SAS's serial number>:lock=yes
```

When this command has successfully completed, the following message should appear.

```
rlghncxa03w 05-09-28 21:15:37 GMT EAGLE5 34.0.0
ENT-SERIAL-NUM: MASP A - COMPLTD
```

6. Enable the Large System # Links controlled feature for the desired quantity with the `enable-ctrl-feat` command specifying the part number corresponding to the new quantity of signaling links and the feature access key. To increase the number of signaling links the EAGLE 5 SAS can contain to 1500, enter this command.

```
enable-ctrl-feat:partnum=893005901:fak=<feature access key>
```

NOTE: A temporary feature access key cannot be specified to enable this feature.

NOTE: The values for the feature access key (the `fak` parameter) are provided by Tekelec. If you do not have the controlled feature part number or the feature access key for the feature you wish to enable, contact your Tekelec Sales Representative or Account Representative.

When the `enable-ctrl-feat` command has successfully completed, this message should appear.

```
rlghncxa03w 05-09-28 21:15:37 GMT EAGLE5 34.0.0
ENABLE-CTRL-FEAT: MASP B - COMPLTD
```

7. Verify the changes by entering the `rtrv-ctrl-feat` command. The following is an example of the possible output.

```
rlghncxa03w 05-09-28 21:15:37 GMT EAGLE5 34.0.0
The following features have been permanently enabled:
```

Feature Name	Partnum	Status	Quantity
IPGWx Signaling TPS	893012814	on	20000
ISUP Normalization	893000201	on	----
Command Class Management	893005801	on	----
LNP Short Message Service	893006601	on	----
Intermed GTT Load Sharing	893006901	on	----
XGTT Table Expansion	893006101	on	4000000
XMAP Table Expansion	893007710	on	3000
Large System # Links	893005901	on	1500
Routesets	893006401	on	6000
HC-MIM SLK Capacity	893012707	on	64

The following features have been temporarily enabled:

Feature Name	Partnum	Status	Quantity	Trial Period Left
Zero entries found.				

The following features have expired temporary keys:

Feature Name	Partnum
Zero entries found.	

8. Back up the new changes using the `chg-db:action=backup:dest=fixed` command. These messages should appear, the active Maintenance and Administration Subsystem Processor (MASP) appears first.

```
BACKUP (FIXED) : MASP A - Backup starts on active MASP.
BACKUP (FIXED) : MASP A - Backup on active MASP to fixed disk complete.
BACKUP (FIXED) : MASP A - Backup starts on standby MASP.
BACKUP (FIXED) : MASP A - Backup on standby MASP to fixed disk complete.
```

Flowchart 3-1. Enabling the Large System # Links Controlled Feature (Sheet 1 of 3)

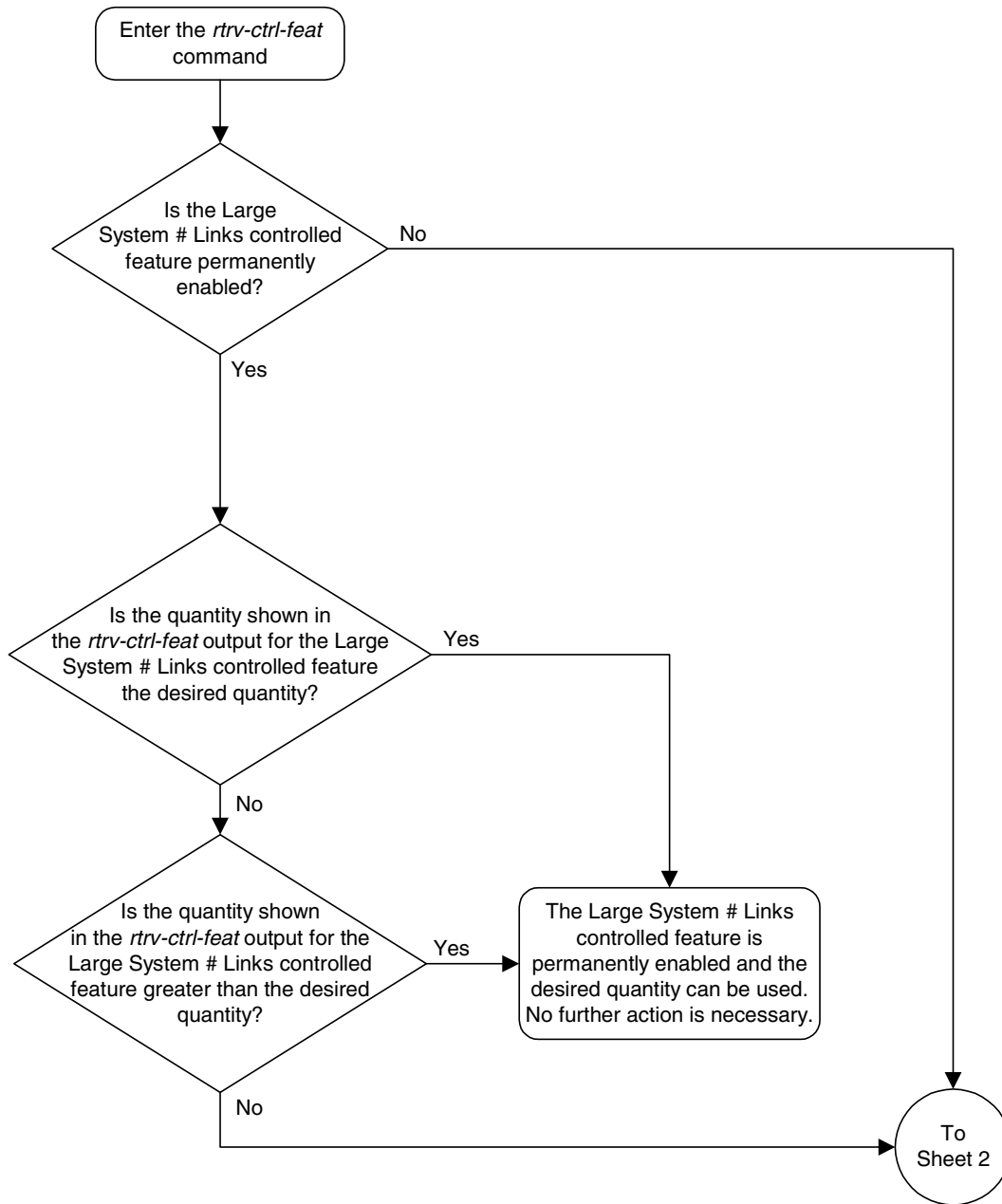

Flowchart 3-1. Enabling the Large System # Links Controlled Feature
(Sheet 3 of 3)

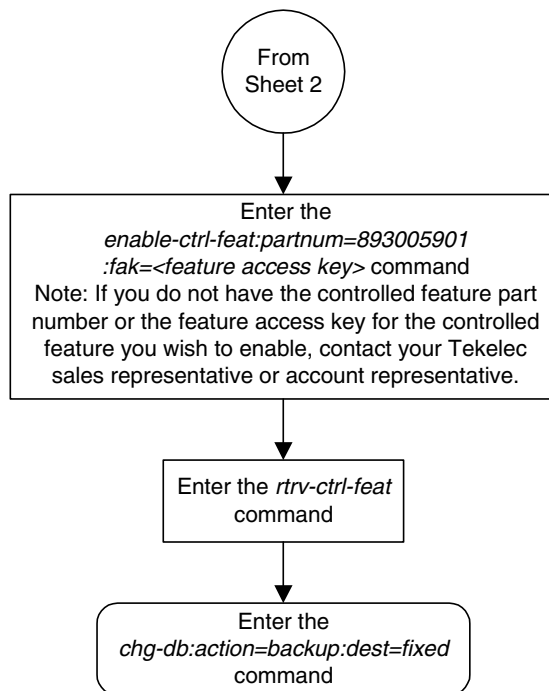

Adding an SS7 Linkset

This procedure is used to add SS7 linksets to the EAGLE 5 SAS using the `ent-1s` command without the `gmscrn`, `ipgwpc`, `iptps`, `lsusealm`, and `slkusealm`, parameters of the `ent-1s` command.

The `gmscrn` parameter is used for the GSM MAP Screening feature. To add an SS7 linkset for the GSM MAP Screening feature, perform the “Configuring a Linkset for the GSM MAP Screening Feature,” in Chapter 5, “GSM MAP Screening Configuration,” in the *Database Administration Manual - Features*.

The `iptps`, `lsusealm`, `slkusealm`, `matelsn`, and `action` parameters are used to configure IPGWx linksets. To configure IPGWx linksets, perform one of these procedures in Chapter 3, “IP⁷ Secure Gateway Configuration Procedures,” in the *Database Administration Manual - IP⁷ Secure Gateway*.

- “Configuring an IPGWx Linkset”
- “Configuring a Mate IPGWx Linkset”

To add X.25 linksets, go to the “Adding an X.25 Linkset” procedure in the *Database Administration Manual – Features*.

The `ent-1s` command uses these parameters.

:1sn – The name of the linkset. The linkset name can contain up to 10 characters, with the first character being a letter. However, the SEAS interface supports only eight characters. If this linkset is displayed on the SEAS interface and the linkset name contains more than eight characters, only the first eight characters in the linkset name are shown. If this linkset name contains more than eight characters, and is specified with the linkset commands on the SEAS interface, only the first eight characters can be specified.

:apc/apca/apci/apcn/apcn24 – Adjacent point code – the point code identifying the node that is next to the EAGLE 5 SAS. The adjacent point code can be one of the following types of point codes:

:apc/apca – ANSI point code

:apci – ITU-I point code, ITU-I spare point code

:apcn – 14-bit ITU-N point code, 14-bit ITU-N spare point code

:apcn24 – 24-bit ITU-N point code

NOTE: See “Point Code Formats” on page 2-4 for a definition of the point code types that are used on the EAGLE 5 SAS and for a definition of the different formats that can be used for ITU national point codes. Private point codes can be assigned only to IPGWx linksets. The procedures for configuring IPGWx linksets are in the *Database Administration Manual - IP⁷ Secure Gateway*.

:apcntype – Specifies whether or not the linkset containing either a 14-bit ITU-N adjacent point code or a 24-bit ITU-N adjacent point code is being used in China (**:apcntype=itunchina**) or in countries other than China (**:apcntype=itun**). Signaling links in linksets with the **:apcntype=itunchina** parameter are handled according to the specifications in *YD/N 068-1997, Technical Specification of National No.7 Signaling System - Message Transfer Part (MTP)*. Signaling links in linksets with the **:apcntype=itun** parameter are handled according to the specifications in *ITU-T Q.2210 (07/96), Switching and Signaling, Broadband ISDN- Signaling Network Protocols*. The default value for the **:apcntype** parameter is **itun**.

Linksets shown in section of the **rtrv-ls** output with the **LSN (CHINA)** column (and with either the **APCN** or **APCN24** column) have the **:apcntype=itunchina** parameter assigned to them.

Linksets shown in section of the **rtrv-ls** output with the **LSN** column (and with either the **APCN** or **APCN24** column) have the **:apcntype=itun** parameter assigned to them.

:lst – The linkset type of the specified linkset

:c11i – The Common Language Location Identifier assigned to this point code. The value of the **c11i** parameter is only displayed in the **rtrv-ls** command output when a specific linkset is being displayed with the **rtrv-ls:lsn=<linkset name>** command.

:sltset – The signaling link test message record to be associated with the linkset.

:l3tset – The level 3 timer set table. This parameter identifies which level three timer set is to be assigned to this linkset.

:scrn – The name of the screenset to be assigned to this linkset if gateway screening is to be used.

:gwsa – Gateway screening action determines whether gateway screening (GWS) is on or off for the specified link set.

:gwsn – Gateway screening messaging is used to turn on or off the display of messages generated for each screened message. When an MSU is rejected by gateway screening, a message is output to alert personnel of the event.

:gwsd – Gateway screening MSU discard is used to turn on or off the discarding of MSUs that bypass the gateway screening function due to load shedding. Also use this parameter with the redirect function; MSUs that cannot be screened are discarded if you specify **gwsd=on**.

:bei – The broadcast exception indicator. This parameter indicates whether TFP (transfer prohibited) messages are allowed to be broadcast on the linkset. The **yes** parameter means TFPs are not broadcast. The **no** parameter means TFPs are broadcast.

:nis – specifies whether the National Spare for Network Indicator feature is on or off for the specific linkset. This feature allows the linkset to use the national spare value (3) for the network indicator code field in the service

information octet (SIO) of the MSU for ANSI linksets and ITU national linksets (linksets containing either 14-bit ITU-N point codes or 24-bit ITU-N point codes). This parameter cannot be specified for ITU international linksets. The default value for the **nis** parameter is **off**.

For MSUs on incoming linksets, only those MSUs having the network indicator code values shown in Table 3-2 on page 3-19 are allowed into the EAGLE 5 SAS.

For MSUs on outgoing linksets, the network indicator code value in the MSU is changed to either the national network indicator code value (2) or the national spare network indicator code value (3). If the **nis** parameter is set to **off**, the network indicator code value is set to 2.

These actions are summarized in Table 3-2 on page 3-19.

The actions described for this parameter apply only if the ITU National and International Spare Point Code Support feature is not enabled.

If the ITU National and International Spare Point Code Support feature is enabled, the **nis** parameter value is ignored for ITU-I and 14-bit ITU-N linksets. All the network indicator values are permitted on ITU-I and ITU-N linksets, and the network indicator value for transmission is based on the International/National and Spare/Non-Spare status of the DPC of the message.

Having the ITU National and International Spare Point Code Support feature enabled has no effect on ANSI and 24-bit ITU-N linksets. The **nis** parameter value determines which incoming network indicator spare bit values to permit, and what network indicator spare bit value should be transmitted.

Table 3-2. Actions of the National Spare for Network Indicator Feature

Linkset Type	Feature Disabled	Feature Enabled
Incoming ANSI Linkset	MSUs containing the national network indicator code (2) are allowed into the EAGLE 5 SAS.	MSUs containing these network indicator code values are allowed into the EAGLE 5 SAS. <ul style="list-style-type: none"> • National Network Indicator Code (2) • National Spare Network Indicator Code (3)
Outgoing ANSI Linkset	The network indicator code value in the MSU is set to the national network indicator code (2).	The network indicator code value in the MSU is set to the national spare network indicator code (3).
Incoming ITU National Linkset	MSUs containing these network indicator code values are allowed into the EAGLE 5 SAS. <ul style="list-style-type: none"> • International Network Indicator Code (0) • National Network Indicator Code (2) 	MSUs containing these network indicator code values are allowed into the EAGLE 5 SAS. <ul style="list-style-type: none"> • International Network Indicator Code (0) • National Network Indicator Code (2) • National Spare Network Indicator Code (3)

Table 3-2. Actions of the National Spare for Network Indicator Feature (Continued)

Linkset Type	Feature Disabled	Feature Enabled
Outgoing ITU National Linkset	The network indicator code value in the MSU is set to the national network indicator code (2).	The network indicator code value in the MSU is set to the national spare network indicator code (3).

:itutfr – specifies whether or not ITU TFR (transfer restricted) procedures are being used on the linkset. This parameter applies only to linksets with ITU national adjacent point codes (linksets containing either 14-bit ITU-N point codes or 24-bit ITU-N point codes) and can be specified only for linksets with ITU national adjacent point codes. TFR procedures are used to redirect traffic away from a node that is having problems routing traffic to a destination. When a node determines that a destination is restricted, the node sends a TFR message informing the adjacent nodes about the destination's status. When a destination is restricted, the node should not be used to route messages to the destination even though it still has limited capability to do so. The values for this parameter are either **on** (ITU TFR procedures are enabled) or **off** (ITU TFR procedures are disabled).

:mtrpse – shows if the node adjacent to the EAGLE 5 SAS is equipped with the MTP restart capability. The **mtrpse=yes** parameter can only be specified if the MTP restart feature is turned on for ANSI linksets (**MTPRS = on** in the **rtrv-feat** command output), or if the ITU MTP restart is on for ITU linksets (**ITUMTPRS=on** in the **rtrv-feat** command output). If the MTP restart feature is not turned on, or the APC of the linkset is in the X25 domain, the value of the **mtrpse** parameter defaults to **no**. The value of the **mtrpse** parameter value is not dependent on the value of the **mtrpsi** parameter (the MTP restart indicator) in the **chg-stpopts** command. The value of the **mtrpse** parameter is only displayed in the **rtrv-ls** command output when a specific linkset is being displayed with the **rtrv-ls:lsn=<linkset name>** command.

NOTE: For more information on the **mtrpse** parameter and MTP restart, see "MTP Restart" on page 3-24.

:slsci – indicates whether the 5-bit to 8-bit SLS conversion feature is used to select signaling links for outgoing messages on the specified link set. If the **slsci=yes** parameter is specified, the EAGLE 5 SAS replaces any 5-bit SLS values contained in received messages with a random 8-bit value before they are used by the EAGLE 5 SAS to select the outgoing signaling link in that linkset. The 5-bit to 8-bit SLS conversion is also controlled by the **slscnv** parameter of the **chg-stpopts** command. The **slscnv** parameter of the **chg-stpopts** command has three values: **on**, **off**, and **perls**.

The **slsci** parameter can only be specified for linksets with ANSI SS7 adjacent point codes.

:as18 – shows if the node adjacent to the EAGLE 5 SAS is sending MSUs with 8-bit SLSs. If the **as18=yes** parameter is specified with the **lst=a** parameter (a

linkset containing access signaling links), this indicates that the originator of the MSUs is generating 8-bit SLSs. For other linkset types, the **as18=yes** parameter indicates that the adjacent node is converting 5-bit SLSs to 8-bit SLSs. The SLS in MSUs received by the EAGLE 5 SAS on a linkset that has the **as18=yes** parameter assigned to it will not be converted. These MSUs are assumed to contain 8-bit SLSs. If the **as18=no** parameter is specified for the linkset, the SLS will be converted to an 8-bit SLS. The **as18** parameter can only be specified for linksets with ANSI SS7 adjacent point codes. The value of the **as18** parameter is only displayed in the **rtrv-ls** command output when a specific linkset is being displayed with the **rtrv-ls:lsn=<linkset name>** command.

NOTE: For more information on the slsci and as18 parameters and 5-bit to 8-bit conversion, see “5-Bit to 8-Bit SLS Conversion” on page 3-26.

:slsrsb – selects which bit (1 - 4) of the SLS field to use as the least significant bit for signaling link selection in the link set for all ITU messages.

:slsocbit – selects which bit (5 - 16) of the SLS field to use as the most significant bit for signaling link selection in the link set for all ITU messages.

NOTE: For more information on the slsrsb and slsocbit parameters and ITU SLS enhancement, see “ITU SLS Enhancement” on page 3-29.

:multgc – specifies whether multiple group codes (for 14-bit ITU-N point codes) are supported for the linkset. When this parameter value is **yes**, secondary adjacent point codes whose group codes are different from the adjacent point code of the linkset can be assigned to the linkset. If the parameter value is **no**, the group code of the secondary adjacent point code must be the same as the group code of the linkset’s adjacent point code. For more information on secondary adjacent point codes, go to the “Configuring an ITU Linkset with a Secondary Adjacent Point Code (SAPC)” procedure on page 3-113.

This parameter only applies to linksets whose adjacent point codes are either ITU international point codes or ITU national point codes. All the signaling links in this linkset must be assigned to cards running the IPLIMI application. For more information on assigning signaling links to cards running the IPLIMI application, go to the “Adding an IP Signaling Link” procedure in the *Database Administration Manual - IP⁷ Secure Gateway*.

The ITU duplicate point code feature must be on before this parameter can be specified. Verify this with the **rtrv-feat** command. If the ITU duplicate point code feature is turned on, the **itutuppc** field should be set to **on**. If the

ITU duplicate point code feature is not turned on, enter the `chg-feat:itupppc=on` command.

NOTE: Once the ITU duplicate point code feature is turned on with the `chg-feat` command, it cannot be turned off.

The ITU duplicate point code feature must be purchased before you turn the feature on with the `chg-feat` command. If you are not sure if you have purchased the ITU duplicate point code feature, contact your Tekelec Sales Representative or Account Representative.

The linkset also contains the `tfatcabmlq` parameter, whose value is shown in the `rtrv-ls:lsn=<linkset name>` command. The `tfatcabmlq` parameter exists only in the `chg-ls` command and not the `ent-ls` command, because no links are assigned to the linkset when the linkset is first created with the `ent-ls` command. The default value for the `tfatcabmlq` parameter (`tfatcabmlq=0`) is entered for the linkset, and shown in the `rtrv-ls` output as 1, when a new linkset is added to the database.

The EAGLE 5 SAS can contain 1024 linksets, with a maximum of 255 of these linksets being gateway linksets. A gateway linkset is a linkset that contains routes to a different network.

The linkset to be added cannot be in the database. This can be verified in step 1 of this procedure.

The adjacent point code (APC) must be defined in the database, must be in the SS7 domain and cannot match the point code or capability point code of the EAGLE 5 SAS. This can be verified in steps 2 and 3 of this procedure. The domain of the point code is shown in the **DOMAIN** field in the output of the `rtrv-dstn` command

(step 3). The point code of the EAGLE 5 SAS is shown in the **PCA**, **PCN**, **PCN24**, or **PCI** fields and the capability point code of the EAGLE 5 SAS are shown in the **CPCA**, **CPCN**, **CPCN24**, or **CPCI** fields in the output of the `rtrv-sid` command (step 2). The adjacent point code must be a full point code and cannot be a cluster point code or a network routing point code.

If the APC is not in the destination point code table, go to the "Adding a Destination Point Code" procedure on page 2-191 and add the APC to the destination point code table.

An X.25 APC cannot be referenced by an X.25 route that has the logical channel to network management function turned on (`lc2nm=yes`). Use the `rtrv-x25-dstn` command to verify which point codes are assigned to each X.25 address. Use the `rtrv-x25-rte` to verify which X.25 address is assigned to each X.25 route and to verify which X.25 route has the logical channel to network management function turned on, shown by the entry **yes** in the **LC2NM** field.

The `ent-1s` command has a parameter, `gwsd`, that can allow the discarding of messages that should have gone through the gateway screening process, but did not. The `gwsd` parameter is only intended to be used with the Database Transport Access (DTA) feature. If you are not using the DTA feature, the `gwsd` parameter should not be specified or should be set to `no` (`gwsd=no`).

The `gwsa`, `gwsn`, and `gwsd` parameters can only be specified if the `scrn` parameter is specified. If the `scrn` parameter is specified, the gateway screening screen set name specified by this parameter must also be defined as a gateway screening screen set entity. This can be verified with the `rtrv-scrset` command.



CAUTION: When Gateway Screening is in the screen test mode, as defined by the linkset parameters `gwsa=off` and `gwsn=on`, the gateway screening action in the gateway screening stop action set specified by the `actname` parameter of the gateway screening screen set at the end of the gateway screening process will be performed.

If the domain of the linkset's APC is in the X.25 domain, the `bei=yes` parameter must be specified, or the `bei` parameter must be omitted.

To help manage congestion on signaling links, the EAGLE 5 SAS starts the level 3 T31 timer whenever a signaling link goes into congestion level 1 or congestion level 2. The congestion level that is associated with the level 3 T31 timer is set using the `chg-stpopts` command with the `mtpt31ctl` parameter and is displayed with the `MTPT31CTL` field in the `rtrv-stpopts` command output. When the level 3 timer T31 and the `chg-stpopts` command are first introduced to the EAGLE 5 SAS, the system default value for the `mtpt31ctl` parameter of the `chg-stpopts` command is 1, for congestion level 1, and the system default value for the level 3 T31 timer is 60 seconds. To change the value of the level 3 T31 timer, go to the "Changing Level 3 Timers" procedure on page 3-222. To change value of the `mtpt31ctl` parameter, enter the either `chg-stpopts:mtpt31ctl=1` or the `chg-stpopts:mtpt31ctl=2` command, depending on the current value of the `mtpt31ctl` parameter.

To help prevent the signaling link in the linkset from oscillating in out of service, the EAGLE 5 SAS starts the level 3 T32 timer. When the EAGLE 5 SAS begins restoring an out of service signaling link, the EAGLE 5 SAS starts the level 3 T32 timer. If the signaling link fails to get back into service before the level 3 T32 expires, the EAGLE 5 SAS does not attempt to continue to bring the signaling link into service until the level 3 T32 timer expires. Once the level 3 T32 timer expires, the EAGLE 5 SAS attempts to restore the signaling link into service. When the level 3 timer T32 is first introduced to the EAGLE 5 SAS, the default value for the level 3 T32 timer is 60 seconds. To change the value of the level 3 T32 timer, go to the "Changing Level 3 Timers" procedure on page 3-222.

The word **SEAS** cannot be used as a value for the **scrn** parameter of the **ent-1s** command. The word **SEAS** is used in the **rtrv-1s** command output, in the **SCRN** field, to show gateway linksets created on the SEAS interface. A gateway linkset combines the functions of a gateway screening screen set and an SS7 linkset specifying the **gwsa=on** and **scrn** parameters. Like a EAGLE 5 SAS gateway screening screen set, a gateway linkset defines the screening references that are to be used to screen the messages on the linkset. It also defines the linkset whose messages are to be screened. A gateway linkset can only be configured from a SEAS terminal and not from a EAGLE 5 SAS terminal.

If the **clli** parameter is specified with the **ent-1s** command, the value of the **clli** parameter must match the CLLI value of the adjacent point code of the linkset. The CLLI value of the adjacent point code is shown in the **CLLI** field of the **rtrv-dstn** command.

If the **randsls** parameter of the **chg-stpopts** command is set to either **all** or **class0**, a maximum of 16 links continues to be supported in a single linkset to a destination. However, it is now possible to have up to 32 links in a combined linkset to a destination, with a maximum of 16 links per linkset. The 32 links is a change from the current EAGLE 5 SAS maximum of only 16 links per combined linkset, which is due to ITU protocol restrictions. If more than 16 links are used in a combined linkset, the operator needs to be aware that a maximum of 16 links can be used by non-Random SLS traffic over the linkset. The non-Random SLS traffic continues to operate under the rules of the ITU protocol. For more information on the Random SLS Generation feature, go to the “Configuring the System for Random SLS Generation” procedure on page 3-254.

MTP Restart

If the MTP restart feature is turned on, the alignment of all ANSI signaling links is delayed until all the LIMs containing ANSI signaling links are in service. This allows the EAGLE 5 SAS to be restored to network service in an orderly fashion and allows all the LIMs containing ANSI signaling links to participate in the MTP restart process. The amount of time that the alignment of the signaling links is delayed is dependent on the number of LIMs and DCMs in the EAGLE 5 SAS and is shown in Table 3-3. Table 3-3 shows an example of MTP signaling link alignment delay for LIMs.

NOTE: The MTP restart feature cannot be used on linksets containing IP signaling links with the **iplim12=m3ua** parameter. The MTP restart feature can be used on linksets containing non-IP signaling links or IP signaling links with either the **iplim12=saaltali** or **iplim12=m2pa** parameter.

Table 3-3. MTP Restart Signaling Link Alignment Delay

Number of LIMs Containing Signaling Links	Signaling Link Alignment Delay
1 to 64	62 seconds
64 to 127	97 seconds
128 to 191	132 seconds
192 or more	167 seconds

If the ANSI MTP restart feature is on (**MTPRS = on** in the **rtrv-feat** command output), the **mtparsi** parameter is set to **yes**, and at least one ANSI linkset has the **mtpirse** parameter set to **yes**, the EAGLE 5 SAS starts these level 3 timers; T22, T23, T24, T25, T26, T28, T29, and T30 to control the behavior of the MTP restart feature. These timers control when the TRA and TRW network management messages are sent to the nodes adjacent to the EAGLE 5 SAS when the EAGLE 5 SAS is going through the MTP restart process. When these timers are first introduced to the EAGLE 5 SAS, the system default values for these timers are:

- T22 - 10 seconds
- T23 - 10 seconds
- T24 - 10 seconds
- T25 - 30 seconds
- T26 - 12 seconds
- T28 - 3 seconds
- T29 - 60 seconds
- T30 - 30 seconds.

To change the values of these timers, go to the “Changing Level 3 Timers” procedure on page 3-222.

If the ITU MTP restart feature is on (**ITUMTPRS = on** in the **rtrv-feat** command output), the **mtparsi** parameter is set to **yes**, and at least one ITU linkset has the **mtpirse** parameter set to **yes**, the EAGLE 5 SAS starts these level 3 timers; IT18, IT19, IT20, and IT21 to control the behavior of the ITU MTP restart feature. These timers control when the TRA and TRW network management messages are sent to the nodes adjacent to the EAGLE 5 SAS when the EAGLE 5 SAS is going through the MTP restart process. When these timers are first introduced to the EAGLE 5 SAS, the default values for these timers are:

- IT18 - 50 seconds
- IT19 - 67 seconds

- IT20 - 59 seconds
- IT21 - 63 seconds.

To change the values of these timers, go to the “Changing Level 3 Timers” procedure on page 3-222.

If both the ANSI and ITU MTP restart features are on, the `mtprsi` parameter is set to `yes`, and at least one ANSI and ITU linkset has the `mtprse` parameter set to `yes`, the EAGLE 5 SAS starts the level 3 timers for both the ANSI and ITU MTP restart features to control the behavior of both the ANSI and ITU MTP restart features.

5-Bit to 8-Bit SLS Conversion

5-Bit to 8-Bit SLS conversion is performed based on the values assigned to the `s1sci` and `as18` parameters for the linkset and the `s1scnv` parameter of the `chg-stpopts` command.

NOTE: The `s1sci` and `as18` parameters can be specified only for linksets containing ANSI adjacent point codes.

The `s1sci` parameter indicates whether the 5-bit to 8-bit SLS conversion feature is used to select signaling links for outgoing messages on the specified link set. If the `s1sci=yes` parameter is specified, the EAGLE 5 SAS replaces any 5-bit SLS values contained in received messages with a random 8-bit value before they are used by the EAGLE 5 SAS to select the outgoing signaling link in that linkset. The 5-bit to 8-bit SLS conversion is also controlled by the `s1scnv` parameter of the `chg-stpopts` command. The `s1scnv` parameter of the `chg-stpopts` command has three values: `on`, `off`, and `perls`.

The `as18` parameter shows if the node adjacent to the EAGLE 5 SAS is sending MSUs with 8-bit SLSs. If the `as18=yes` parameter is specified with the `lst=a` parameter (a linkset containing access signaling links), this indicates that the originator of the MSUs is generating 8-bit SLSs. For other linkset types, the `as18=yes` parameter indicates that the adjacent node is converting 5-bit SLSs to 8-bit SLSs. The SLS in MSUs received by the EAGLE 5 SAS on a linkset that has the `as18=yes` parameter assigned to it will not be converted. These MSUs are assumed to contain 8-bit SLSs. If the `as18=no` parameter is specified for the linkset, the SLS will be converted to an 8-bit SLS. The value of the `as18` parameter is only displayed in the `rtrv-ls` command output when a specific linkset is being displayed with the `rtrv-ls:lsn=<linkset name>` command.

The interaction between the `s1sci` and `as18` parameters of the `ent-ls` command and the `s1scnv` parameter of the `chg-stpopts` command is shown in Table 3-4.

Table 3-4. Signaling Link Selector (SLS) Conversion (ANSI Linksets Only)

CHG-STPOPTS SLSCNV Parameter Value	Outgoing Linkset SLSCI Parameter Value	Incoming Linkset ASL8 Parameter Value	Result
ON	Not Applicable	YES	The adjacent node is sending 8-bit SLSs. No SLS conversion is performed on MSUs received on this linkset.
ON	Not Applicable	NO	The adjacent node is not sending 8-bit SLSs. 5-bit to 8-bit SLS conversion on MSUs received on this linkset.
OFF	Not Applicable	YES	The adjacent node is sending 8-bit SLSs. No SLS conversion is performed on any linksets.
OFF	Not Applicable	NO	The adjacent node is not sending 8-bit SLSs. 5-bit to 8-bit SLS conversion is not performed on all linksets.
PERLS*	YES	YES	The adjacent node is sending 8-bit SLSs. No SLS conversion is performed.
PERLS*	YES	NO	The adjacent node is not sending 8-bit SLSs. 5-bit to 8-bit SLS conversion is performed.
PERLS*	NO	YES	The adjacent node is sending 8-bit SLSs. No SLS conversion is performed.
PERLS*	NO	NO	The adjacent node is not sending 8-bit SLSs. 5-bit to 8-bit SLS conversion is not performed.
* When the slscnv=perls parameter is specified with the chg-stpopts command, 5-bit to 8-bit SLS conversion is only performed on the MSUs arriving at the EAGLE 5 SAS on linksets that have the asl8=no parameter of the ent-1s command assigned to them, and leaving the EAGLE 5 SAS on linksets that have the slsci=yes parameter of the ent-1s command assigned to them.			

The **slscnv** parameter of the **chg-stpopts** command has three values: **on**, **off**, and **perls**.

- **slscnv=on** – 5-bit to 8-bit conversion is performed on all linksets in the EAGLE 5 SAS, regardless of what the value of the **slsci** parameter of the **ent-1s** or **chg-1s** command is for the specific linkset. If the **asl8=yes** parameter of either the **ent-1s** or **chg-1s** commands is assigned to the linkset, no SLS conversion is performed.

- **s1scnv=off** – 5-bit to 8-bit conversion is not performed on the linksets in the EAGLE 5 SAS, regardless of what the value of the **s1sci** parameter of the **ent-1s** or **chg-1s** command is for the specific linkset.
- **s1scnv=per1s** – 5-bit to 8-bit SLS conversion is only performed on the MSUs arriving at the EAGLE 5 SAS on linksets that have the **as18=no** parameter assigned to them, and leaving the EAGLE 5 SAS on linksets that have the **s1sci=yes** parameter assigned to them. The **as18** and **s1sci** parameters are configured with either the **ent-1s** or **chg-1s** commands.

When a 5-bit ANSI SLS is converted to an 8-bit ANSI SLS, the three most significant bits of the SLS are set using a function of originating point code and incoming signaling link. This ensures that MSUs with the same originating point code, SLS, and incoming signaling link will always have the same SLS after the conversion, guaranteeing that the MSUs arrive at the destination in the same sequence that they were sent.

5-bit to 8-bit SLS conversion is performed under these conditions.

- The incoming linkset is an ANSI linkset, a linkset containing an ANSI adjacent point code.
- The **as18=no** parameter of the **ent-1s** or **chg-1s** command is assigned to the incoming linkset.
- The outgoing linkset is an ANSI linkset.
- The **s1scnv=on** parameter of the **chg-stpopts** command is specified
- The **s1scnv=per1s** parameter of the **chg-stpopts** command is specified and **s1sci=yes** parameter of the **ent-1s** or **chg-1s** command assigned to the outgoing linkset.
- The three most significant bits of the SLS in the MSU are zero.

All ANSI MSUs originating from the EAGLE 5 SAS have an 8-bit SLS.

The EAGLE 5 SAS also converts ANSI SLSs to ITU SLSs, and ITU SLSs to ANSI SLSs.

When an ITU SLS is converted to an ANSI SLS, the ITU SLS is always converted to an ANSI 5-bit SLS. If the MSU containing the converted SLS is rerouted because of a link outage, the SLS may be converted from a 5-bit SLS to an 8-bit SLS.

When an ANSI SLS is converted to an ITU SLS, the ANSI SLS is always converted to an ITU 4-bit SLS.

The EAGLE 5 SAS does not convert a 4-bit ITU SLS to an 8-bit ANSI SLS.

The 5-bit to 8-bit SLS conversion takes place during the routing process, after the linkset is selected, but before the signaling link is selected. The ITU to ANSI SLS conversion takes place during the ANSI to ITU MSU conversion and after the outgoing signaling link is chosen.

ITU SLS Enhancement

The ITU SLS Enhancement gives customers the ability to modify the method the EAGLE 5 SAS distributes traffic across SS7 links.

The EAGLE 5 SAS uses the least significant bit of the SLS to load share between linksets of a combined linkset. ITU ISUP messages use a SLS that is obtained from the lower 4 bits of the CIC field representing the circuit being used. Figure 3-4 shows the ITU ISUP routing label with the CIC field.

Figure 3-4. ITU ISUP Routing Label with CIC

16	15	14	13	12	11	10	9	8	7	6	5	4	3	2	1	Bit Location
DPC															Routing Label word 1	
SLS (CIC)				OPC											Routing Label word 2	
Spare				"Other" CIC bits (bits 5-16)											ISUP CIC (cont.)	

CIC selection can be determined based on an odd or even method where a SSP uses either all odd CICs, or all even CICs, to help prevent "glaring" (that is, 2 SSPs attempting to seize the same trunk at the same time). This causes the least significant bit of the SLS to be fixed. If the least significant bit is fixed, inadequate load sharing occurs for the SS7 network. This situation can also occur within a single linkset (international), since the EAGLE 5 SAS also uses the lower 4 bits of the SLS (containing a fixed least significant bit) to select a link within a linkset.

This enhancement provides the user two options for addressing the problem:

- Bit Rotation – The customer can have the EAGLE 5 SAS rotate the 4 bits of the SLS, thus changing the least significant bit of the SLS. If selected, this option is applied to all ITU messages. This option is set with the `s1srsb` parameter of either the `ent-1s` or `chg-1s` commands. More information on this option can be found in the "Bit Rotation" section on page 3-30.
- Use of Other CIC Bit – The user can have the EAGLE 5 SAS derive the SLS from the bits 2 through 4 of the CIC to serve as the three lower bits of SLS, and one other bit of the CIC to serve as the most significant bit of the SLS. If selected, this option is only applied to ITU ISUP messages. This option is set with the `s1sobit` parameter of either the `ent-1s` or `chg-1s` commands. More information on this option can be found in the "Use of the Other CIC Bit" section on page 3-31.

Before the Use of the Other CIC Bit option can be set, the Other CIC Bit Used feature must be turned on with the `chg-feat` command and the `s1sob=on` parameter. This can be verified with the `SLSOCB = on` entry of the `rtvr-feat` command output.

The `s1srsb` and `s1socbit` parameters can only be specified for linksets that contain either an ITU international or ITU national adjacent point code (either a 14-bit or 24-bit ITU-N adjacent point code).

The value of the `s1srsb` and `s1socbit` parameters are only displayed in the `rtrv-ls` command output when a specific linkset is being displayed with the `rtrv-ls:lsn=<linkset name>` command.

NOTE: If the `randsls` parameter of the `chg-stpopts` command, a system-wide option, is set to either `all` or `class0`, the EAGLE 5 SAS uses the Random SLS Generation feature to perform load sharing between ITU linksets. The `s1srsb` parameter value is ignored. However, the `ent-ls` and `chg-ls` commands allow the `s1srsb` parameter value to be specified. For more information on the Random SLS Generation feature, go to the “Configuring the System for Random SLS Generation” procedure on page 3-254.

Only the link selection algorithm is modified by this feature, not the actual SLS field of the message (that is, the SLS value received by the EAGLE 5 SAS is the SLS value sent by the EAGLE 5 SAS).

Bit Rotation

To alleviate the situation of the EAGLE 5 SAS selecting the same linkset of a combined linkset, the customer can apply the bit rotation option. Bit rotation can be used, on a per linkset basis, to ensure the EAGLE 5 SAS does not use the static least significant bit (always 0 or always 1) in the received SLS for linkset selection.

When defining a link set using the `ent-ls` or `chg-ls` commands, the customer will be able to select which bit (1-4) of the SLS field to use as the least significant bit for link set selection. This rotation only affects the 4 bits of the SLS during linkset selection, as follows:

- If bit 4 is selected, bit locations 4 3 2 1 will be rotated to 3 2 1 4.
For example: SLS = 0110 becomes Rotated SLS = 1100
 SLS = 1011 becomes Rotated SLS = 0111
- If bit 3 is selected, bit locations 4 3 2 1 will be rotated to 2 1 4 3.
For example: SLS = 0110 becomes Rotated SLS = 1001
 SLS = 1011 becomes Rotated SLS = 1110
- If bit 2 selected, bit locations 4 3 2 1 will be rotated to 1 4 3 2.
For example: SLS = 0110 becomes Rotated SLS = 0011
 SLS = 1011 becomes Rotated SLS = 1101
- If bit 1 is selected, no rotation is performed, since bit 1 is the existing least significant bit. Bit 1 is the default value.

Figure 3-5 shows an example of bit rotation.

Figure 3-5. Example of Bit Rotation

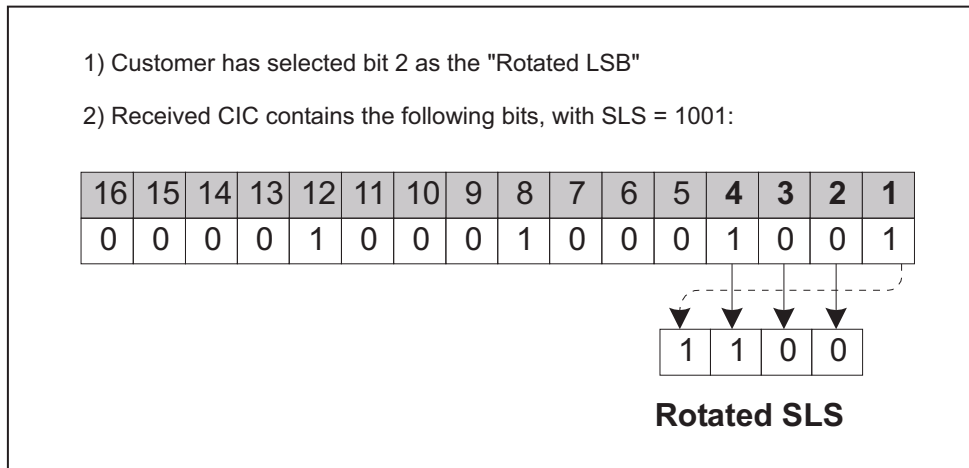

After the SLS is rotated, the existing algorithm for selecting a linkset and signaling link is performed, and the message is sent out the selected link. Note that the SLS is modified only for the link selection algorithm, and is not modified in the outgoing message.

Use of bit rotation alone does not guarantee an even distribution of ITU-ISUP messages across all links within a linkset. The EAGLE 5 SAS uses all 4 bits of the SLS to determine the actual link to route messages. Since the static bit is simply rotated within the SLS, all possible values of the SLS field will still not be realized. A second option, Use of the Other CIC Bit, must be applied to guarantee even distribution across all links within the linkset.

Use of the Other CIC Bit

The Use of the Other CIC Bit option can be applied by the customer to alleviate the problem of the EAGLE 5 SAS not load sharing between all links within a linkset. When defining a linkset with the **chg-ls** or **ent-ls** command, the user can specify whether the Use of the Other CIC Bit option is to be used during link selection. If the option is to be used, the customer can also specify which bit (bits 5 through 16 of CIC) is to be used as the "other CIC bit".

During link selection, the specified bit acts as the most significant bit of the new SLS, and bits 2 through 4 of the received CIC become the least significant bits of the new SLS.

Figure 3-6 shows how the new SLS field is generated using the "other CIC bit."

Figure 3-6. SLS creation Using "Other CIC Bit"

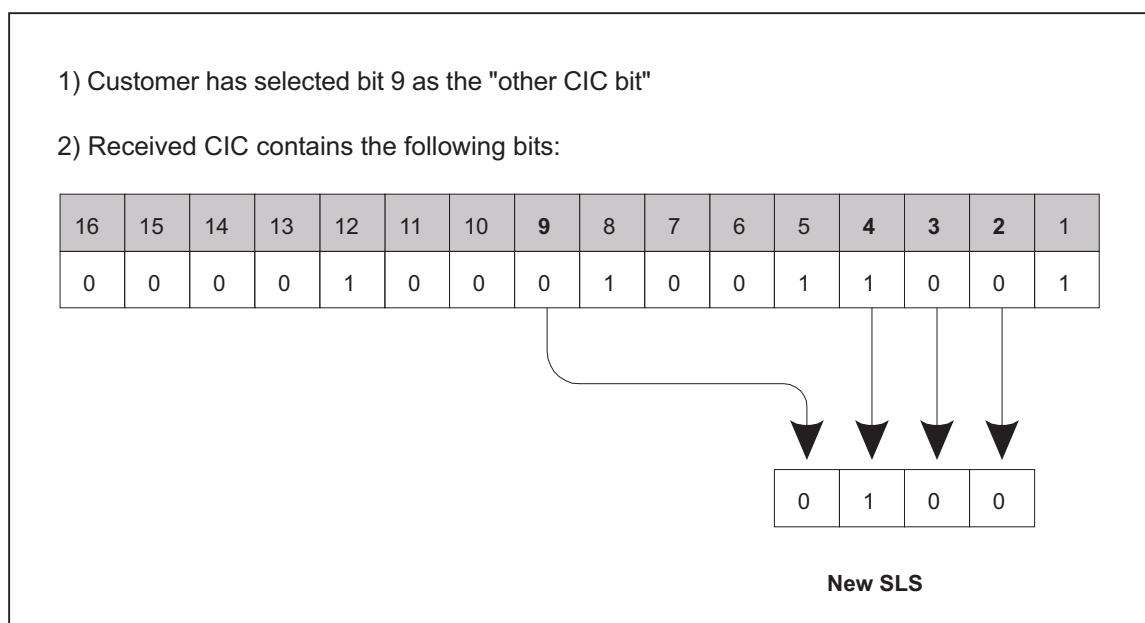

After the SLS is generated using the "other CIC bit", the existing algorithm for selecting a linkset and signaling link is performed, and the message is sent out from the selected link. Note that the SLS is modified only for the link selection algorithm, and is not modified in the outgoing message.

Combining the Bit Rotation and Use of the Other CIC Bit Options

Both the bit rotation option and the Other CIC Bit options can be applied to provide an even distribution of ITU-ISUP messages sent by the EAGLE 5 SAS. If the customer has activated the options for a given linkset, the SLS field is processed in the following order.

1. The SLS is modified using the other CIC bit option.
2. The modified SLS is modified again using the bit rotation option.
3. The modified SLS is used by the existing linkset and link selection algorithms to select a link
4. The ISUP message is sent out the link containing the original, unmodified SLS field.

ITU TFR Procedures

Receiving TFR Messages

If ITU TFR procedures have been enabled for the linkset and a TFR message is received on that linkset, the EAGLE 5 SAS marks the route to the destination as restricted and performs controlled rerouting of the messages that are destined for the destination specified in the TFR message.

If ITU TFR procedures have not been enabled for the linkset and a TFR message is received on that linkset, the TFR message is converted to a TFA (transfer allowed) message and traffic is routed to the destination specified in the TFR message. When this condition is present and a TFR is received on this linkset, UIM 1233 is displayed showing that a TFR was received on a linkset that does not support the TFR procedure.

When a TFR message is received for a route that is already prohibited, and no alternative route exists, the traffic to the concerned node is restarted towards the signaling point from which the TFR message was received.

Invalid TFR messages

The TFR message is ignored under any of these conditions:

- The TFR message is not from an adjacent point code.
- The point code specified in the TFR message is being sent from that same point code.
- The TFR message is from an unknown destination.
- The TFR message is from an adjacent point code, but the adjacent point code is not the route for concerned point code.
- If the route to the concerned point code is already restricted.
- The route to concerned point code not found or is unavailable.

Sending TFR Messages

The EAGLE 5 SAS must send a TFR message containing the affected point code (restricted destination) to all accessible adjacent nodes, whose linkset has the TFR procedure enabled, when the following conditions are in effect:

- When long term failure occurs on the ITU-N linkset (primary) used to route messages to the affected point code. Long term failure occurs when all links of a linkset remain unavailable for more than the amount of time specified by level 3 timer T11.
- While waiting for “long term failure” to be determined, if congestion (or “danger of congestion”) is detected on an alternate linkset used to route

messages to the affected point code, then TFRs are sent immediately without waiting for level 3 timer T11 to expire. For example: level 3 timer T11 is set to 30 seconds, the links of the linkset to the adjacent node fail and MSUs are now sent out the alternate linkset. Within 10 seconds of the failure, congestion is detected on the alternate linkset, so TFR messages are sent to each adjacent point code (if linkset has ITUTFR procedures enabled) for each destination (affected point code) routed through that node.

- When an adjacent node becomes accessible by an alternate route, the EAGLE 5 SAS sends a TFR for each destination that is restricted to the node.
- During restarts, TFRs are broadcast to all accessible adjacent nodes for each restricted destination.

Unlike the ANSI network, the ITU national network does not use response method TFR messages. The ITU national network only uses broadcast method TFR messages that are sent to all adjacent nodes under the conditions described above.

NOTE: In ANSI networks, response method TFRs are sent to adjacent nodes in response to a MSU, when that node continues to send MSUs after a broadcast method TFR has already been sent.

The EAGLE 5 SAS maintains the status (allowed, restricted, or prohibited) for all destinations. Table 3-5 shows the type of message sent when a destination transitions from one status to another.

Table 3-5. Route Management Messages Sent on Status Transition

Status Transition	ITU TFR Procedures Enabled	ITU TFR Procedures Disabled
Prohibited to Restricted	TFR	TFA
Allowed to Restricted	TFR	None
Restricted to Prohibited	TFP	TFP
Restricted to Allowed	TFA	None

Sample Linkset Configuration

The examples used in this procedure are based on the example network shown in Figure 3-3 on page 3-9 and Table 3-6.

Table 3-6. Linkset Configuration Table

Linkset Names	Linkset APC	LST	CLLI	SLTSET	BEI	IPGWAPC	APCNTYPE
ls05	002-002-003	a	N/A	1	no	no	N/A
ls06	002-007-008	a	N/A	4	yes	no	N/A
ls07	009-002-003	a	N/A	1	no	no	N/A
atmansi0	179-100-087	a	N/A	16	yes	no	N/A
atmansi1	200-050-176	a	rlghnccc001	9	no	no	N/A
lsi7	3-150-4	a	N/A	2	N/A	N/A	N/A
lsn5	10685	a	N/A	2	N/A	N/A	ITUN
lsn6	12543	a	N/A	3	N/A	N/A	ITUNCHINA
Linkset Names	SCRN	GWSA	GWSD	GWSM	NIS	ITUTFR	
ls05	scr2	on	on	off	off	N/A	
ls06	scr4	on	off	off	on	N/A	
ls07	scr2	on	on	off	off	N/A	
atmansi0	scr2	on	off	off	off	N/A	
atmansi1	scr1	on	off	off	off	N/A	
lsi7	scr1	on	off	N/A	N/A	N/A	
lsn5	scr3	on	off	N/A	N/A	yes	
lsn6	scr3	on	off	N/A	N/A	yes	

Canceling the RTRV-LS and RTRV-DSTN Commands

Because the `rtrv-ls` and `rtrv-dstn` commands used in this procedure can output information for a long period of time, the `rtrv-ls` and `rtrv-dstn` commands can be canceled and the output to the terminal stopped. There are three ways that the `rtrv-ls` and `rtrv-dstn` commands can be canceled.

- Press the **F9** function key on the keyboard at the terminal where the `rtrv-ls` or `rtrv-dstn` commands were entered.
- Enter the `canc-cmd` without the `trm` parameter at the terminal where the `rtrv-ls` or `rtrv-dstn` commands were entered.
- Enter the `canc-cmd:trm=<xx>`, where `<xx>` is the terminal where the `rtrv-ls` or `rtrv-dstn` commands were entered, from another terminal other than the

terminal where the **rtrv-ls** or **rtrv-dstn** commands were entered. To enter the **canc-cmd:trm=<xx>** command, the terminal must allow Security Administration commands to be entered from it and the user must be allowed to enter Security Administration commands. The terminal's permissions can be verified with the **rtrv-secu-trm** command. The user's permissions can be verified with the **rtrv-user** or **rtrv-secu-user** commands.

For more information about the **canc-cmd** command, go to the *Commands Manual*.

Procedure

1. Display the current linkset configuration using the **rtrv-ls** command. This is an example of the possible output.

```
rlghncxa03w 05-09-10 11:43:04 GMT EAGLE5 34.0.0
```

LSN	APCA	(SS7)	SCRN	SET	SET	BEI	LST	LNKS	ACT	MES	DIS	SLSCI	NIS
e1e2	001-207-000	none	1	1	no	B	6	6	off	off	off	no	off
ls1305	000-005-000	none	1	1	no	A	1	1	off	off	off	no	off
ls1307	000-007-000	none	1	1	no	A	1	1	off	off	off	no	off
e1m1s1	001-001-001	none	1	1	no	A	7	7	off	off	off	no	off
e1m1s2	001-001-002	none	1	1	no	A	7	7	off	off	off	no	off

LSN	APCA	(X25)	SCRN	SET	SET	BEI	LST	LNKS	ACT	MES	DIS	SLSCI	NIS

LSN	APCI	(SS7)	SCRN	SET	SET	BEI	LST	LNKS	ACT	MES	DIS	SLSCI	NIS
e1e2i	1-207-0	none	1	1	no	B	4	4	off	off	off	---	on
ls1315	0-015-0	none	1	1	no	A	1	1	off	off	off	---	off
ls1317	0-017-0	none	1	1	no	A	1	1	off	off	off	---	on
e1m2s1	1-011-1	none	1	1	no	A	7	7	off	off	off	---	off
e1m2s2	1-011-2	none	1	1	no	A	7	7	off	off	off	---	off

LSN	APCN	(SS7)	SCRN	SET	SET	BEI	LST	LNKS	ACT	MES	DIS	SLSCI	NIS

LSN	APCN24	(SS7)	SCRN	SET	SET	BEI	LST	LNKS	ACT	MES	DIS	SLSCI	NIS

LSN (CHINA)	APCN	(SS7)	SCRN	SET	SET	BEI	LST	LNKS	ACT	MES	DIS	SLSCI	NIS

LSN (CHINA)	APCN24	(SS7)	SCRN	SET	SET	BEI	LST	LNKS	ACT	MES	DIS	SLSCI	NIS

Link set table is (10 of 1024) 1% full.

2. Display the point code and capability point code of the EAGLE 5 SAS by using the **rtrv-sid** command. This is an example of the possible output.

```
rlghncxa03w 05-09-10 11:43:04 GMT EAGLE5 34.0.0
```

PCA	PCI	PCN	CLLI	PCTYPE
001-001-001	1-200-6	13482	rlghncxa03w	OTHER
CPCA				
002-002-002	002-002-003	002-002-004	002-002-005	
002-002-006	002-002-007	002-002-008	002-002-009	

SS7 Configuration

```

004-002-001      004-003-003      144-212-003

CPCA (LNP)
005-005-002      005-005-004      005-005-005

CPCI
1-001-1          1-001-2          1-001-3          1-001-4

CPCN
02091           02092           02094           02097
02191           02192           11177

```

3. Display the point codes in the destination point code table by using the **rtrv-dstn** command. This is an example of the possible output.

```

rlghncxa03w 05-09-10 11:43:04 GMT EAGLE5 34.0.0
DPCA      CLLI      BEI  ELEI  ALIASI      ALIASN/N24  DOMAIN
001-002-003  ls04c11i  yes  ---  -----  -----  SS7
002-002-100  ls01c11i  no   ---  -----  -----  SS7
002-007-008  ls06c11i  yes  ---  -----  -----  SS7
002-009-003  -----  no   ---  -----  -----  SS7
002-250-010  -----  no   ---  -----  -----  SS7
003-003-003  ls03c11i  yes  ---  -----  -----  SS7
003-020-100  -----  no   ---  -----  -----  SS7
004-004-004  ls02c11i  yes  ---  -----  -----  SS7
004-030-200  -----  no   ---  -----  -----  SS7
009-002-003  -----  no   ---  -----  -----  SS7
179-100-087  -----  yes  ---  -----  -----  SS7
200-050-176  -----  yes  ---  -----  -----  SS7
240-007-000  -----  yes  ---  -----  -----  SS7
240-012-004  rlghncbb001  yes  ---  1-111-1  11111  SS7
240-012-005  rlghncbb002  yes  ---  1-112-2  11112  SS7
240-012-006  rlghncbb003  yes  ---  1-112-3  11113  SS7
240-012-008  -----  yes  ---  1-113-5  11114  SS7
244-010-004  ls06c11i  no   ---  -----  -----  X25
244-012-005  ls07c11i  no   ---  -----  -----  X25
244-012-006  ls08c11i  no   ---  -----  -----  X25
244-012-007  -----  no   ---  -----  -----  X25
244-012-008  -----  no   ---  -----  -----  X25

DPCI      CLLI      BEI  ELEI  ALIASA      ALIASN/N24  DOMAIN
2-131-1    rlghncbb023  no   ---  222-210-000  12001  SS7
2-131-2    -----  no   ---  222-211-001  12002  SS7
2-131-3    -----  no   ---  222-211-002  12003  SS7
3-150-4    lsi7c11i  yes  ---  -----  -----  SS7

DPCN      CLLI      BEI  ELEI  ALIASA      ALIASI      DOMAIN
10685     lsn5c11i  yes  ---  -----  -----  SS7
11211     rlghncbb013  no   ---  222-200-200  2-121-1  SS7
11212     rlghncbb013  no   ---  222-200-201  2-121-2  SS7

DPCN24    CLLI      BEI  ELEI  ALIASA      ALIASI      DOMAIN

Destination table is (29 of 2000) 1% full
Alias table is (18 of 8000) 1% full
RTRV-DSTN: MASP A - COMPLTD

```

If the adjacent point code is not shown in the **rtrv-dstn** command output, go to the “Adding a Destination Point Code” procedure on page 2-191 and add the adjacent point code to the destination point code table.

NOTE: If the linkset being added to the database will not have a gateway screening screen set assigned to it, or if the screen set that you wish to assign to the linkset is assigned to other linksets (shown in the **SCRN** field of the **rtrv-ls** command output in step 1), skip step 4 and go to step 5.

4. Verify that the gateway screening screen set that is to be assigned to the linkset is in the database by entering the **rtrv-scrset** command. This is an example of the possible output.

```
rlghncxa03w 05-09-28 16:37:05 GMT EAGLE5 34.0.0
ENTIRE GWS DATABASE IS 1% FULL
CDPA + AFTPC TABLES ARE 1% FULL
THERE ARE 243 SCREEN SETS AVAILABLE
```

THE FOLLOWING ARE OVER 80% FULL:

SCRN	NSFI	NSR/ACT	FULL	RULES	TABLES	DESTFLD
fld1	OPC	fld2	1%	5	4	NO
gws1	OPC	gws4	1%	9	7	NO
gws2	BLKOPC	gws5	1%	5	4	NO
ls01	SIO	ls02	1%	3	3	YES
scr1	OPC	opc1	1%	37	10	YES
scr2	OPC	opc2	2%	75	22	YES
scr3	OPC	opc3	2%	75	22	YES
scr4	OPC	opc1	51%	2075	22	NO
scr5	OPC	opc1	51%	2075	22	YES
scr6	OPC	opc1	51%	2075	22	NO
ss28	OPC	opc1	51%	2075	22	YES
wrd1	SIO	iec	1%	6	5	YES

If you wish to examine the contents of a particular screen set, enter the **rtrv-scrset:scrn=<screen set name>** command specifying a screen set name shown in the **SCRN** field of either the **rtrv-scrset** command executed in this step or the **rtrv-ls** command executed in step 1. for this example, enter the **rtrv-scrset:scrn=scr1** command This is an example of the possible output.

rtrv-scrset:scrn=scr1

```
rlghncxa03w 05-09-14 16:39:04 GMT EAGLE5 34.0.0
SCRN NSFI NSR/ACT RULES DESTFLD
scr1 OPC opc1 3 Y
      BLKDPC bkd2 2
      CGPA cgp1 3
      TT tt1 3
      TT tt2 3
      TT tt3 4
      CDPA cdp1 3
      CDPA cdp2 3
      CDPA cdp3 4
      AFTPC end1 9
```

The output of this command shows the screens that make up the screen set. These screens can be examined by entering the gateway screening retrieve command corresponding to the value in the **NSFT** field and specifying the screening reference name shown in the **NSR/ACT** field. For this example, you enter these commands to examine the screens in the screen set.

```
rtrv-scr-opc:sr=opc1
rtrv-scr-blkdpc:sr=bkd2
rtrv-scr-cgpa:sr=cgp1
rtrv-scr-tt:sr=tt1
rtrv-scr-tt:sr=tt2
rtrv-scr-tt:sr=tt3
rtrv-scr-cdpa:sr=cdp1
rtrv-scr-cdpa:sr=cdp2
rtrv-scr-cdpa:sr=cdp3
rtrv-scr-aftpc:sr=end1
```

If the screen set that you wish to assign to the linkset is not in the database, go to the "Adding a Screen Set" procedure in the *Database Administration Manual - Gateway Screening* and add the screen set to the database.

NOTE: If the **mtprse** parameter is not being assigned to the linkset, skip steps 5 through 10, and go to step 11.

5. If you wish to use either the ANSI MTP restart feature or the ITU MTP restart feature, enter the **rtrv-feat** command to verify that either of these features are on. The entry **MTPRS = on** in the **rtrv-feat** command output shows that the ANSI MTP restart feature is on. The entry **ITUMTPRS = on** in the **rtrv-feat** command output shows that the ITU MTP restart feature is on. In this example, both features are off.

NOTE: The **rtrv-feat** command output contains other fields that are not used by this procedure. If you wish to see all the fields displayed by the **rtrv-feat** command, see the **rtrv-feat** command description in the *Commands Manual*.

If both the ANSI and ITU MTP restart feature are on, skip steps 6 and 7 and go to step 8.

NOTE: If you are not going to turn the ANSI MTP restart feature on, or if the output of the `rtrv-feat` command in step 5 shows that the ANSI MTP restart feature is on (shown by the `MPTRS = on` entry), skip this step and go to step 7.

6. Turn the ANSI MTP restart feature on by entering this command.

```
chg-feat:mtprs=on
```

NOTE: Once the ANSI MTP restart feature is turned on with the `chg-feat` command, it cannot be turned off.

The ANSI MTP restart feature must be purchased before you turn the feature on with the `chg-feat` command. If you are not sure if you have purchased the ANSI MTP restart feature, contact your Tekelec Sales Representative or Account Representative.

When this command has successfully completed, this message should appear.

```
rlghncxa03w 05-09-10 11:43:04 GMT EAGLE5 34.0.0
CHG-FEAT: MASP A - COMPLTD
```

NOTE: If you are not going to turn the ITU MTP restart feature on, or if the output of the `rtrv-feat` command in step 5 shows that the ITU MTP restart feature is on (shown by the `ITUMPTRS = on` entry), skip this step and go to step 8.

7. Turn the ITU MTP restart feature on by entering this command.

```
chg-feat:itumtprs=on
```

NOTE: Once the ITU MTP restart feature is turned on with the `chg-feat` command, it cannot be turned off.

The ITU MTP restart feature must be purchased before you turn the feature on with the `chg-feat` command. If you are not sure if you have purchased the ITU MTP restart feature, contact your Tekelec Sales Representative or Account Representative.

When this command has successfully completed, this message should appear.

```
rlghncxa03w 05-09-10 11:43:04 GMT EAGLE5 34.0.0
CHG-FEAT: MASP A - COMPLTD
```

8. Enter the `rtrv-stpopts` command to display the value of the `mtprsi` and `mtprsit` parameters of the `chg-stpopts` command.

The `mtprsi` parameter either enables (`mtprsi=yes`) or disables (`mtprsi=no`) the MTP restart process on the EAGLE 5 SAS.

The `mtprsit` parameter (the MTP restart isolation timer) specifies the minimum amount of time that the EAGLE 5 SAS is isolated before the MTP restart process is started. The value of the `mtprsit` parameter is from 2 to 900 seconds, with a system default value of 5 seconds.

The value of the `mtprsi` parameter is shown in the `MTPRSI` field of the `rtrv-stpopts` command output. The value of the `mtprsit` parameter is shown in the `MTPRSIT` field of the `rtrv-stpopts` command output, and is shown in milliseconds.

This is an example of the possible output.

```
rlghncxa03w 05-09-17 16:02:05 GMT EAGLE5 34.0.0
STP OPTIONS
-----
MTPRSI                no
MTPRSIT              5000
```

NOTE: The `rtrv-stpopts` command output contains other fields that are not used by this procedure. If you wish to see all the fields displayed by the `rtrv-stpopts` command, see the `rtrv-stpopts` command description in the *Commands Manual*.

To change the value of the `MTPRSI` or the `MTPRSIT` fields, go to step 9. Otherwise, skip steps 9 and 10 and go to step 11.

9. Enable the MTP restart process on the EAGLE 5 SAS by changing the value of the `MTPRSI` field of the `rtrv-stpopts` command output. Enter the `chg-stpopts` command with the `mtprsi` parameter.

```
chg-stpopts:mtprsi=yes
```

If you wish to change the value of the MTP restart isolation timer, enter `chg-stpopts` command with the `mtprsit` parameter.

```
chg-stpopts:mtprsit=7500
```

If you wish to change the value of the MTP restart isolation timer and enable the MTP restart process, enter `chg-stpopts` command with both the `mtprsi=yes` and `mtprsit` parameters.

```
chg-stpopts:mtprsi=yes:mtprsit=7500
```

For this example, the MTP restart process is enabled and the value of the MTP restart isolation timer is changed.

When the `chg-stpopts` command has successfully completed, this message should appear.

```
rlghncxa03w 05-09-07 00:22:57 GMT EAGLE5 34.0.0
CHG-STPOPTS: MASP A - COMPLTD
```

10. Verify the changes using the `rtrv-stpopts` command. This is an example of the possible output.

```
rlghncxa03w 05-09-17 16:02:05 GMT EAGLE5 34.0.0
STP OPTIONS
-----
MTPRSI                yes
MTPRSIT               7500
```

NOTE: The `rtrv-stpopts` command output contains other fields that are not used by this procedure. If you wish to see all the fields displayed by the `rtrv-stpopts` command, see the `rtrv-stpopts` command description in the *Commands Manual*.

NOTE: If the `slsci` and `as18` parameters are not being assigned to the linkset, skip steps 11 through 13, and go to step 14. The `slsci` and `as18` parameters can be specified only for linksets with ANSI APCs.

NOTE: If the `rtrv-stpopts` command was performed in steps 8 and 10, skip this step and go to step 12.

11. Display the existing value for the `slscnv` parameter by entering the `rtrv-stpopts` command. The value for the `slscnv` parameter is shown in the `SLSCNV` field. This is an example of the possible output.

```
rlghncxa03w 05-09-17 16:02:05 GMT EAGLE5 34.0.0
STP OPTIONS
-----
SLSCNV                on
```

NOTE: The `rtrv-stpopts` command output contains other fields that are not used by this procedure. If you wish to see all the fields displayed by the `rtrv-stpopts` command, see the `rtrv-stpopts` command description in the *Commands Manual*.

NOTE: If the `slscnv` parameter is not being changed, skip this step and step 13, and go to step 14.

12. Change the `slscnv` parameter value using the `chg-stpopts` command. For this example, the value of the `slscnv` parameter is being changed from `on` to `per1s`. Enter this command.

```
chg-stpopts:slscnv=per1s
```

When this command has successfully completed, this message should appear.

```
rlghncxa03w 05-09-07 00:22:57 GMT EAGLE5 34.0.0
CHG-STPOPTS: MASP A - COMPLTD
```

13. Verify the changes using the `rtrv-stpopts` command. This is an example of the possible output.

```
rlghncxa03w 05-09-17 16:02:05 GMT EAGLE5 34.0.0
STP OPTIONS
```

```
-----
SLSCNV          perls
```

NOTE: The `rtrv-stpopts` command output contains other fields that are not used by this procedure. If you wish to see all the fields displayed by the `rtrv-stpopts` command, see the `rtrv-stpopts` command description in the *Commands Manual*.

NOTE: If the `slsobit` parameter is not being assigned to the linkset, skip steps 14 and 15, and go to step 16. The `slsobit` parameter can be specified only for linksets with either ITU-I or ITU-N APCs (either 14-bit or 24-bit ITU-N APCs).

NOTE: If the `rtrv-feat` command was performed in step 5, skip this step and go to step 15.

14. To use the `slsobit` parameter with either the `ent-ls` command, the Use of the Other CIC Bit feature must be on. Enter the `rtrv-feat` command to verify that either of this feature is on. The entry `SLSOCB = on` in the `rtrv-feat` command output shows that this feature is on. In this example, the Use of the Other CIC Bit feature is off.

NOTE: The `rtrv-feat` command output contains other fields that are not used by this procedure. If you wish to see all the fields displayed by the `rtrv-feat` command, see the `rtrv-feat` command description in the *Commands Manual*.

NOTE: If the Use of the Other CIC Bit feature is on (`SLSOCB = on`), skip this step and go to step 16.

15. Turn the Use of the Other CIC Bit feature is on feature on by entering this command.

```
chg-feat:slsob=on
```

NOTE: Once the Use of the Other CIC Bit feature is turned on with the `chg-feat` command, it cannot be turned off.

The Use of the Other CIC Bit feature must be purchased before you turn the feature on with the `chg-feat` command. If you are not sure if you have purchased the Use of the Other CIC Bit feature, contact your Tekelec Sales Representative or Account Representative.

When this command has successfully completed, this message should appear.

```
rlghncxa03w 05-09-10 11:43:04 GMT EAGLE5 34.0.0
CHG-FEAT: MASP A - COMPLTD
```

NOTE: If the `multgc=yes` parameter is not being assigned to the linkset, skip steps 16, and 17, and go to step 18. The `multgc=yes` parameter can be specified only for linksets with either ITU-I or 14-bit ITU-N APCs, and linksets that will contain signaling links running the IPLIMI applications.

NOTE: If the `rtrv-feat` command was performed in steps 5 or 14, skip this step and go to step 17.

16. To specify the `multgc=yes` parameter with the `ent-1s` command, the ITU Duplicate Point Code feature must be on. For the ITU Duplicate Point Code feature to be on, the Multiple Point Code feature must be on. Enter the `rtrv-feat` command to verify that either of these features are on. The entry `MPC = on` in the `rtrv-feat` command output shows that the Multiple Point Code feature is on. The entry `ITUDUPPC = on` in the `rtrv-feat` command output shows that the ITU Duplicate Point Code feature is on. In this example, both features are off.

NOTE: The `rtrv-feat` command output contains other fields that are not used by this procedure. If you wish to see all the fields displayed by the `rtrv-feat` command, see the `rtrv-feat` command description in the *Commands Manual*.

NOTE: If the ITU Duplicate Point Code feature is on (`ITUDUPPC = on`), skip this step and go to step 18.

17. Turn the ITU Duplicate Point Code feature on, and the Multiple Point Code feature if necessary, by entering one of these commands.

To turn the ITU Duplicate Point Code feature on only.

```
chg-feat:ituduppc=on
```

To turn both the ITU Duplicate Point Code and Multiple Point Code features on.

```
chg-feat:mpc=on:ituduppc=on
```

NOTE: Once the ITU Duplicate Point Code and Multiple Point Code features are turned on with the `chg-feat` command, they cannot be turned off.

The ITU Duplicate Point Code and Multiple Point Code features must be purchased before you turn either of these features on with the `chg-feat` command. If you are not sure if you have purchased these features, contact your Tekelec Sales Representative or Account Representative.

When this command has successfully completed, this message should appear.

```
rlghncxa03w 05-09-10 11:43:04 GMT EAGLE5 34.0.0
CHG-FEAT: MASP A - COMPLTD
```

18. Using the outputs from steps 1 through 17, Table 3-2 on page 3-19, and Table 3-6 on page 3-35 as a guide, add the new linkset to the database using the **ent-1s** command. The new linkset must meet these conditions.

- The new linkset cannot already be in the database – the linkset configuration is shown in the output of step 1.
- The APC of the new linkset must be in the destination point code table, but cannot be either the EAGLE 5 SAS's point code or the EAGLE 5 SAS's capability point code – shown in the outputs of steps 2 and 3.
- If a gateway screening screen set is assigned to the linkset, the gateway screening screen set must be in the database – shown in the output of step 4.
- The **gwsa**, **gwsn**, and **gwsd** parameters can be specified only if the **scrn** parameter is specified.



CAUTION: When Gateway Screening is in the screen test mode, as defined by the linkset parameters **gwsa=off** and **gwsn=on**, the gateway screening action in the gateway screening stop action set specified by the **actname** parameter of the gateway screening screen set at the end of the gateway screening process will be performed.

- The **gwsd=on** parameter can be specified only with the **gwsa=on** parameter.
- See Table 3-4 on page 3-27 for the combinations of the **as18** and **s1sci** parameters, and the **s1scnv** STP option, and the results that these combinations produce. The **as18** and **s1sci** parameters can be specified only for linksets with ANSI APCs.
- The **n1s=on** parameter cannot be specified for linksets with ITU-I adjacent point codes.
- The **multgc=yes** parameter can be specified only for linksets with either ITU-I or 14-bit ITU-N APCs, and for linksets that will contain signaling links running the IPLIMI application.
- The **itutfr=on** parameter can be specified only for linksets with ITU-N APCs (either 14-bit or 24-bit ITU-N APCs).
- Private point codes cannot be used as an adjacent point code in this procedure. Private point codes can be assigned only to IPGWx linksets. The procedures for configuring IPGWx linksets is in the *Database Administration Manual - IP⁷ Secure Gateway*.
- The **apcntype** parameter can be used only with 14-bit ITU-N or 24-bit ITU-N adjacent point codes.

For this example, enter these commands.

```
ent-ls:lsn=ls05:apca=002-009-009:lst=a:scrn=scr2:gwsa=on
:gws=off:gwsd=on:bei=no:sltset=1:nis=off

ent-ls:lsn=ls06:apca=002-007-008:lst=a:scrn=scr4:gwsa=on
:gws=off:gwsd=off:bei=yes:sltset=4:nis=on

ent-ls:lsn=ls07:apca=009-002-002:lst=a:scrn=scr2:gwsa=on
:gws=off:gwsd=on:bei=no:sltset=1:nis=off

ent-ls:lsn=atmansi0:apca=179-100-087:lst=a:scrn=scr2:gwsa=on
:gws=off:gwsd=off:bei=yes:sltset=16:nis=off

ent-ls:lsn=atmansil:apca=200-050-176:lst=a:scrn=scr1:gwsa=on
:gwsd=off:clli=rlghnccc001:bei=no:sltset=9:nis=off

ent-ls:lsn=lsi7:apci=3-150-4:lst=a:scrn=scr1:gwsa=on
:gwsd=off:sltset=2

ent-ls:lsn=lsn5:apcn=10685:lst=a:scrn=scr3:gwsa=on
:gwsd=off:sltset=2:itutfr=on

ent-ls:lsn=lsn6:apcn=12543:lst=a:scrn=scr3:gwsa=on
:gwsd=off:sltset=3:itutfr=on:apcntype=itunchina
```

When each of these commands have successfully completed, this message should appear.

```
rlghncxa03w 05-09-17 16:23:21 GMT EAGLE5 34.0.0
Link set table is ( 19 of 1024) 2% full
ENT-LS: MASP A - COMPLTD
```

- Verify the changes using the `rtrv-ls` command specifying the linkset name specified in step 18 with the `lsn` parameter. For this example, enter these commands.

```
rtrv-ls:lsn=ls05
```

This is an example of the possible output.

```
rlghncxa03w 05-09-17 11:43:04 GMT EAGLE5 34.0.0

LSN          APCA  (SS7)  L3T SLT          GWS GWS GWS
ls05         002-009-003 scr2 1 1 no a 0 on off on no off

CLLI          TFATCABMLQ  MTPRSE  ASL8
-----      -
0              no      no

LOC  LINK SLC TYPE          L2T          L1          PCR PCR
SET BPS          MODE TSET  ECM  N1  N2

LOC  LINK SLC TYPE          LP          ATM          VCI  VPI  LL
SET BPS          TSEL          VCI  VPI  LL

LOC  LINK SLC TYPE          LP          ATM          E1ATM
SET BPS          TSEL          VCI  VPI  CRC4 SI SN

LOC  LINK SLC TYPE          IPLIML2
```

SS7 Configuration

```

LOC LINK SLC TYPE
LOC LINK SLC TYPE L2T PCR PCR E1 E1
SET BPS ECM N1 N2 LOC PORT TS
LOC LINK SLC TYPE L2T PCR PCR T1 T1
SET BPS ECM N1 N2 LOC PORT TS
Link set table is ( 20 of 1024) 2% full

```

rtrv-ls:lsn=ls06

This is an example of the possible output.

rlghncxa03w 05-09-17 11:43:04 GMT EAGLE5 34.0.0

```

LSN APCA (SS7) SCRNL3T SLT GWS GWS GWS
ls06 002-007-008 scr4 1 4 no a 0 on off off no on
CLLI TFATCABMLQ MTPRSE ASL8
ls06c1li 0 no no
LOC LINK SLC TYPE L2T L1 PCR PCR
SET BPS MODE TSET ECM N1 N2
LOC LINK SLC TYPE LP ATM
SET BPS TSEL VCI VPI LL
LOC LINK SLC TYPE LP ATM E1ATM
SET BPS TSEL VCI VPI CRC4 SI SN
LOC LINK SLC TYPE IPLIML2
LOC LINK SLC TYPE
LOC LINK SLC TYPE L2T PCR PCR E1 E1
SET BPS ECM N1 N2 LOC PORT TS
LOC LINK SLC TYPE L2T PCR PCR T1 T1
SET BPS ECM N1 N2 LOC PORT TS
Link set table is ( 20 of 1024) 2% full

```

rtrv-ls:lsn=ls07

This is an example of the possible output.

rlghncxa03w 05-09-17 11:43:04 GMT EAGLE5 34.0.0

```

LSN APCA (SS7) SCRNL3T SLT GWS GWS GWS
ls07 009-002-003 scr2 1 1 no a 0 on off on no off
CLLI TFATCABMLQ MTPRSE ASL8
----- 0 no no
LOC LINK SLC TYPE L2T L1 PCR PCR
SET BPS MODE TSET ECM N1 N2
LOC LINK SLC TYPE LP ATM
SET BPS TSEL VCI VPI LL
LOC LINK SLC TYPE LP ATM E1ATM
SET BPS TSEL VCI VPI CRC4 SI SN

```

```

LOC LINK SLC TYPE IPLIML2

LOC LINK SLC TYPE

LOC LINK SLC TYPE L2T PCR PCR E1 E1
SET BPS ECM N1 N2 LOC PORT TS

LOC LINK SLC TYPE L2T PCR PCR T1 T1
SET BPS ECM N1 N2 LOC PORT TS

```

Link set table is (20 of 1024) 2% full

rtrv-ls:lsn=atmansi0

This is an example of the possible output.

rlghncxa03w 05-09-17 11:43:04 GMT EAGLE5 34.0.0

```

LSN APCA (SS7) SCRNL3T SLT GWS GWS GWS
atmansi0 179-100-087 scr2 1 16 yes a 0 ACT MES DIS SLSCI NIS
----- 0 no no on off off no off

CLLI TFATCABMLQ MTPRSE ASL8
----- 0 no no

LOC LINK SLC TYPE L2T L1 PCR PCR
SET BPS MODE TSET ECM N1 N2

LOC LINK SLC TYPE LP ATM
SET BPS TSEL VCI VPI LL

LOC LINK SLC TYPE LP ATM
SET BPS TSEL VCI VPI CRC4 SI SN

LOC LINK SLC TYPE IPLIML2

LOC LINK SLC TYPE

LOC LINK SLC TYPE L2T PCR PCR E1 E1
SET BPS ECM N1 N2 LOC PORT TS

LOC LINK SLC TYPE L2T PCR PCR T1 T1
SET BPS ECM N1 N2 LOC PORT TS

```

Link set table is (20 of 1024) 2% full

rtrv-ls:lsn=atmansi1

This is an example of the possible output.

rlghncxa03w 05-09-17 11:43:04 GMT EAGLE5 34.0.0

```

LSN APCA (SS7) SCRNL3T SLT GWS GWS GWS
atmansi1 200-050-176 scr1 1 9 no a 0 ACT MES DIS SLSCI NIS
----- 0 no no on off off no off

CLLI TFATCABMLQ MTPRSE ASL8
rlghnccc001 0 no no

LOC LINK SLC TYPE L2T L1 PCR PCR
SET BPS MODE TSET ECM N1 N2

```

SS7 Configuration

```

LOC LINK SLC TYPE LP ATM
SET BPS TSEL VCI VPI LL

LOC LINK SLC TYPE LP ATM E1ATM
SET BPS TSEL VCI VPI CRC4 SI SN

LOC LINK SLC TYPE IPLIML2

LOC LINK SLC TYPE

LOC LINK SLC TYPE L2T PCR PCR E1 E1
SET BPS ECM N1 N2 LOC PORT TS

LOC LINK SLC TYPE L2T PCR PCR T1 T1
SET BPS ECM N1 N2 LOC PORT TS

```

Link set table is (20 of 1024) 2% full

rtrv-ls:lsn=lsi7

This is an example of the possible output.

rlghncxa03w 05-09-17 11:43:04 GMT EAGLE5 34.0.0

```

LSN APCI (SS7) SCRNL3T SLT GWS GWS GWS
lsi7 3-150-4 scr1 1 2 no a 0 on off off no off

CLLI TFATCABMLQ MTPRSE ASL8 SLSOCBIT SLRSRB GSMSCRN
lsi7c1li 1 no no none 1 off

LOC LINK SLC TYPE L2T L1 PCR PCR
SET BPS MODE TSET ECM N1 N2

LOC LINK SLC TYPE LP ATM
SET BPS TSEL VCI VPI LL

LOC LINK SLC TYPE LP ATM E1ATM
SET BPS TSEL VCI VPI CRC4 SI SN

LOC LINK SLC TYPE IPLIML2

LOC LINK SLC TYPE

LOC LINK SLC TYPE L2T PCR PCR E1 E1
SET BPS ECM N1 N2 LOC PORT TS

LOC LINK SLC TYPE L2T PCR PCR T1 T1
SET BPS ECM N1 N2 LOC PORT TS

```

Link set table is (20 of 1024) 2% full

rtrv-ls:lsn=lsn5

This is an example of the possible output.

rlghncxa03w 05-09-17 11:43:04 GMT EAGLE5 34.0.0

```

                                L3T SLT                      GWS GWS GWS
LSN          APCN   (SS7)  SCRN  SET SET BEI LST LNKS ACT MES DIS SLSCI NIS
lsn5         10685                scr3  1  2  no  a  0   on off off no   off

          CLLI          TFATCABMLQ MTPRSE ASL8  SLSOCBIT SLSRSB ITUTFR
lsn5clli    1                ---  ---  none      1      on

GMSSCRN
on

IPGWAPC MATELSN   IPTPS LSUSEALM SLKUSEALM
no          -----  ---  ---  ---

          L2T          L1          PCR  PCR
LOC   LINK SLC TYPE  SET  BPS    MODE TSET  ECM  N1  N2

          LP          ATM
LOC   LINK SLC TYPE  SET  BPS    TSEL      VCI   VPI  LL

          LP          ATM          E1ATM
LOC   LINK SLC TYPE  SET  BPS    TSEL      VCI   VPI  CRC4 SI SN

LOC   LINK SLC TYPE  IPLIML2

LOC   LINK SLC TYPE

          L2T          PCR  PCR  E1  E1
LOC   LINK SLC TYPE  SET  BPS   ECM  N1  N2  LOC  PORT TS

          L2T          PCR  PCR  T1  T1
LOC   LINK SLC TYPE  SET  BPS   ECM  N1  N2  LOC  PORT TS
    
```

Link set table is (20 of 1024) 2% full

rtrv-ls:lsn=lsn6

This is an example of the possible output.

rlghncxa03w 05-09-17 11:43:04 GMT EAGLE5 34.0.0

```

                                L3T SLT                      GWS GWS GWS
LSN (CHINA) APCN   (SS7)  SCRN  SET SET BEI LST LNKS ACT MES DIS SLSCI NIS
lsn6         12543                scr3  1  3  no  A  0   on off off ---  off

          CLLI          TFATCABMLQ MTPRSE ASL8  SLSOCBIT SLSRSB ITUTFR
-----  1                ---  ---  none      1      on

GMSSCRN
off

IPGWAPC MATELSN   IPTPS LSUSEALM SLKUSEALM
no          -----  ---  ---  ---

          L2T          L1          PCR  PCR
LOC   LINK SLC TYPE  SET  BPS    MODE TSET  ECM  N1  N2

          LP          ATM
LOC   LINK SLC TYPE  SET  BPS    TSEL      VCI   VPI  LL
    
```

SS7 Configuration

```
LOC LINK SLC TYPE LP ATM E1ATM
SET BPS TSEL VCI VPI CRC4 SI SN

LOC LINK SLC TYPE IPLIML2

LOC LINK SLC TYPE

LOC LINK SLC TYPE L2T PCR PCR E1 E1
SET BPS ECM N1 N2 LOC PORT TS

LOC LINK SLC TYPE L2T PCR PCR T1 T1
SET BPS ECM N1 N2 LOC PORT TS
```

Link set table is (20 of 1024) 2% full

-
- 20.** Back up the new changes using the **chg-db:action=backup:dest=fixed** command. These messages should appear, the active Maintenance and Administration Subsystem Processor (MASP) appears first.

```
BACKUP (FIXED) : MASP A - Backup starts on active MASP.
BACKUP (FIXED) : MASP A - Backup on active MASP to fixed disk complete.
BACKUP (FIXED) : MASP A - Backup starts on standby MASP.
BACKUP (FIXED) : MASP A - Backup on standby MASP to fixed disk complete.
```

Flowchart 3-2. Adding an SS7 Linkset (Sheet 1 of 11)

NOTE: This procedure can require that these features are enabled: ANSI MTP Restart, ITU MTP Restart, ITU National Duplicate Point Code, Multiple Point Code, and ITU SLS Enhancement. Before executing this procedure, make sure you have purchased the features you plan to enable. If you are not sure if you have purchased these features, contact your Tekelec Sales Representative or Account Representative.

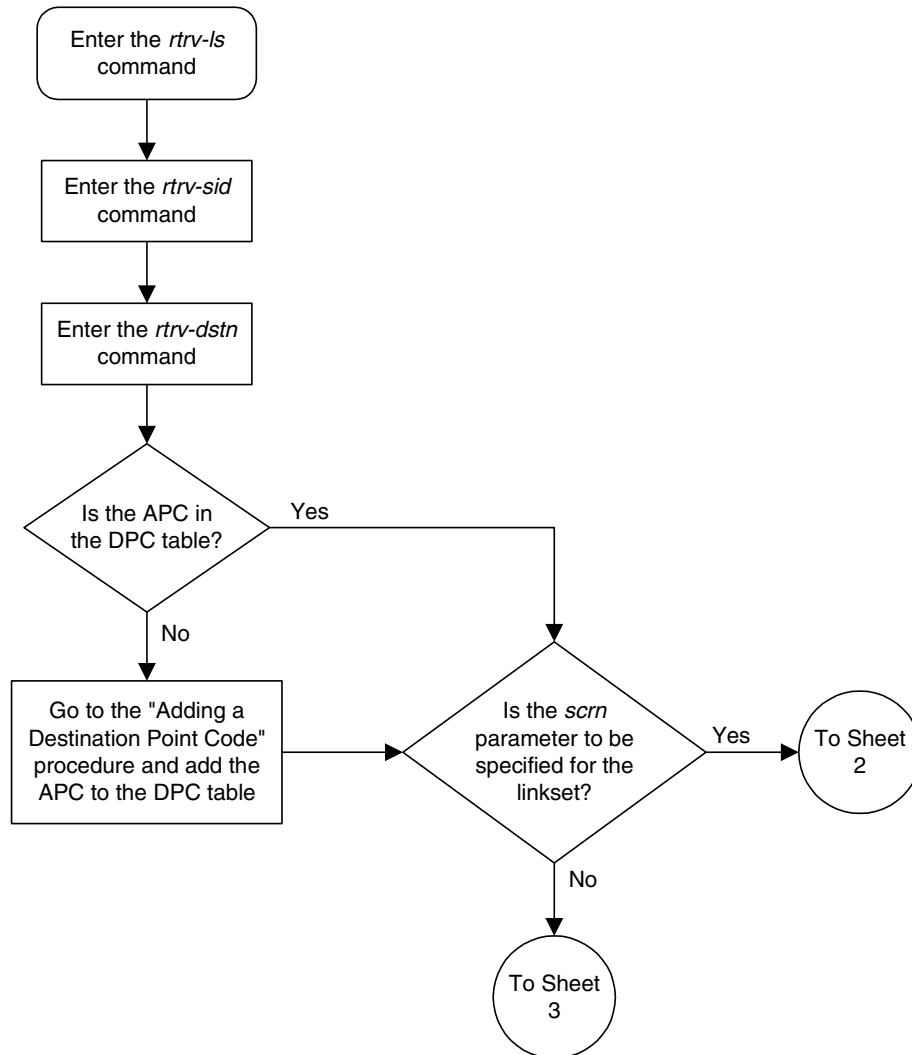

Flowchart 3-2. Adding an SS7 Linkset (Sheet 2 of 11)

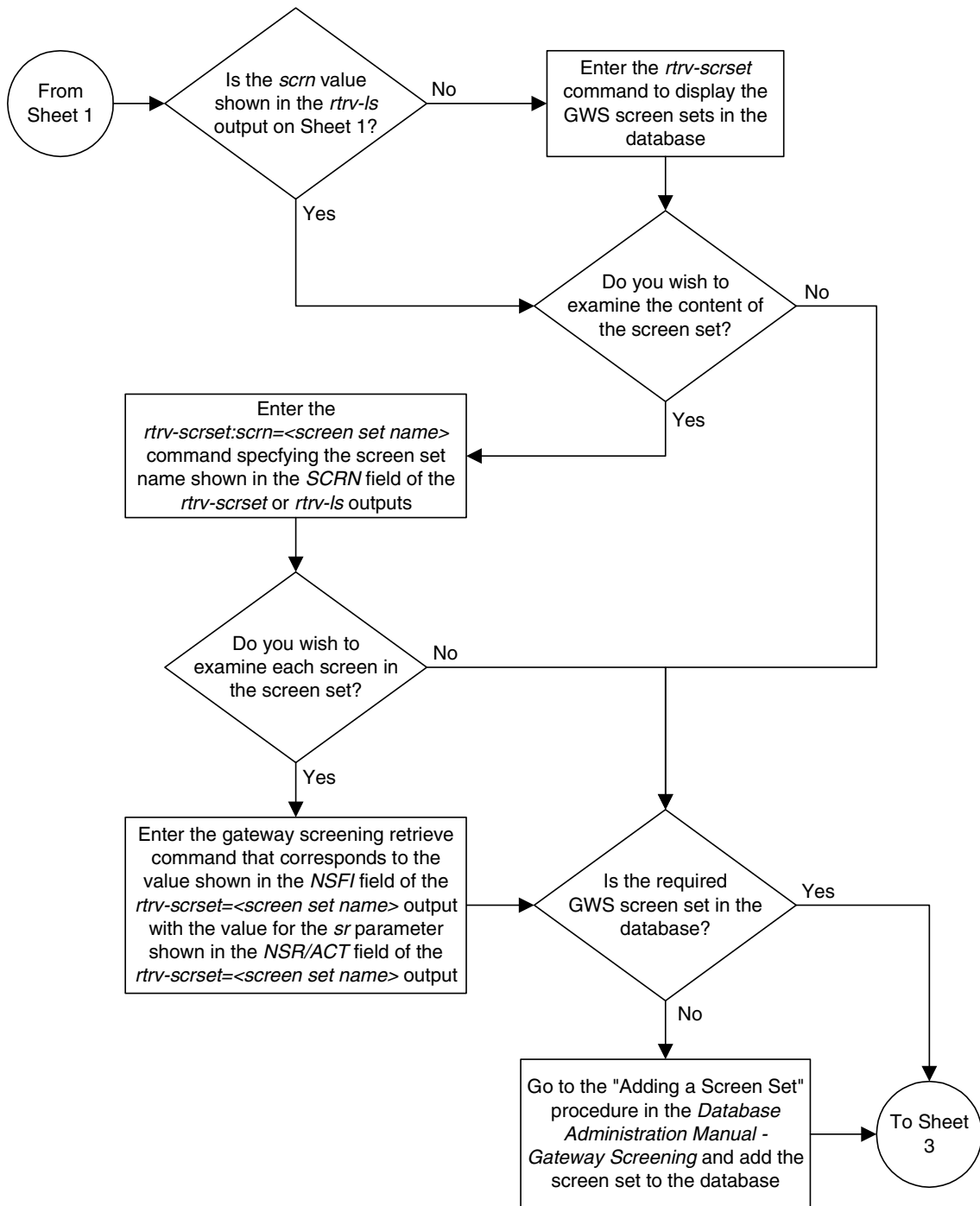

Flowchart 3-2. Adding an SS7 Linkset (Sheet 3 of 11)

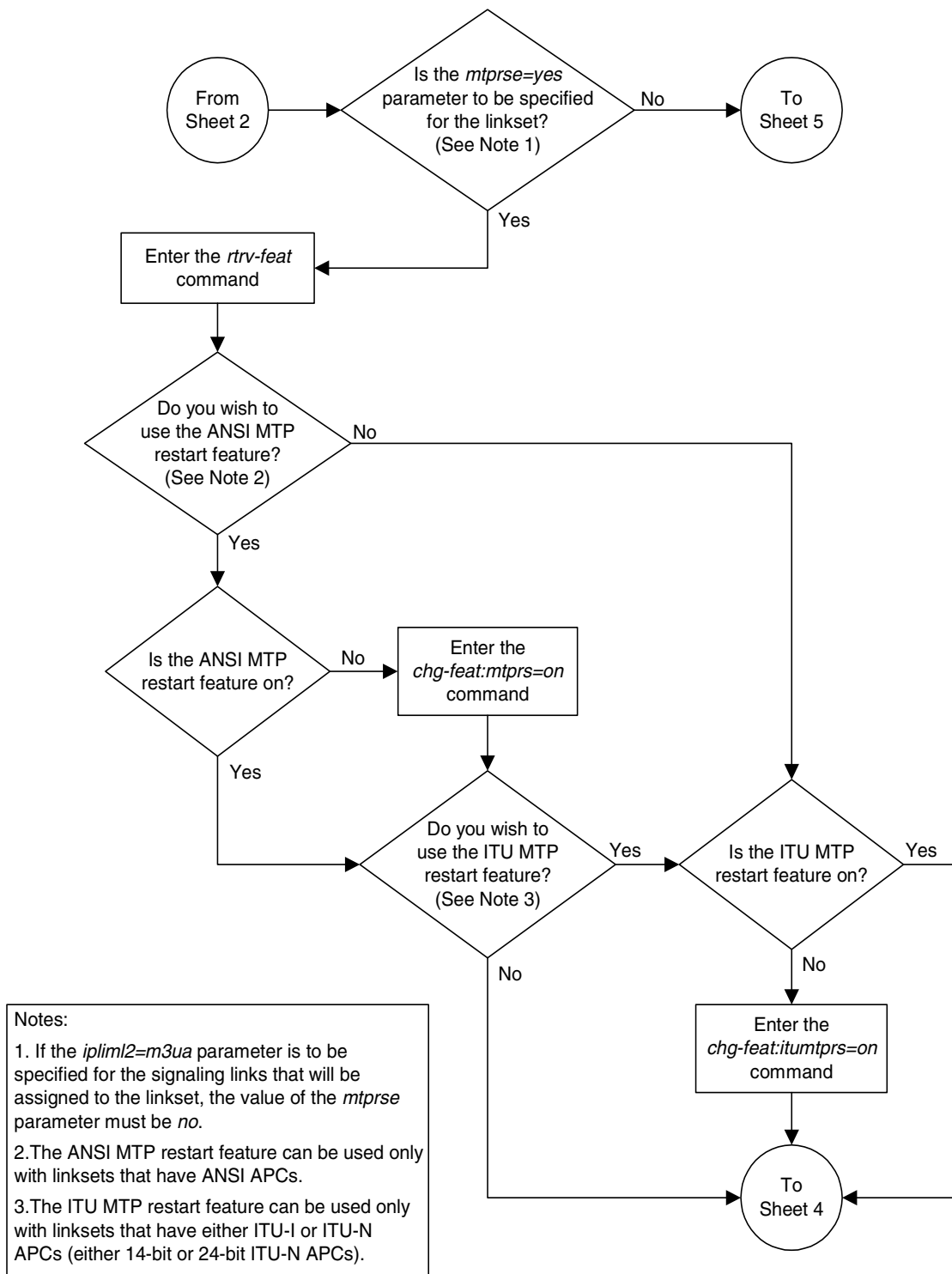

Flowchart 3-2. Adding an SS7 Linkset (Sheet 4 of 11)

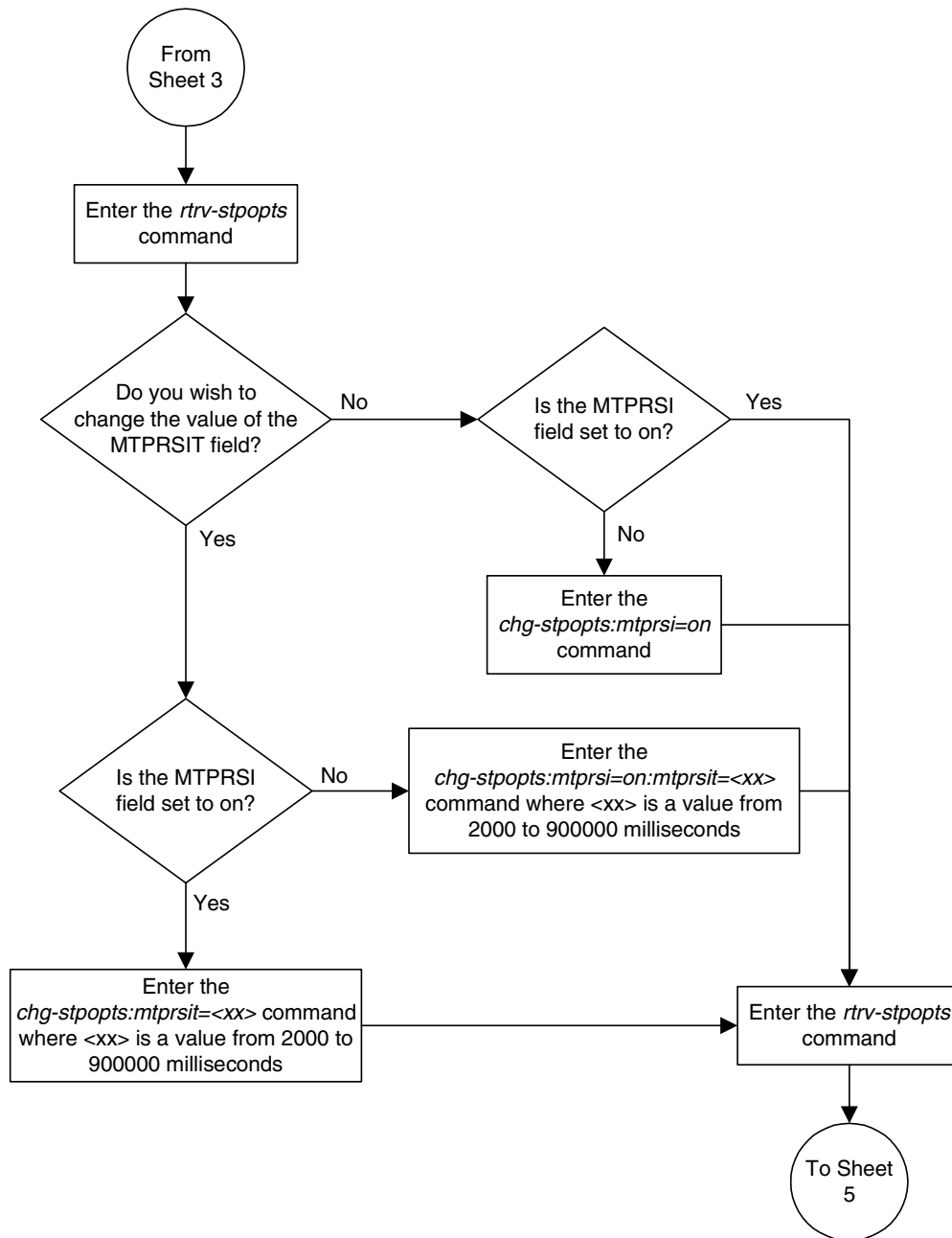

Flowchart 3-2. Adding an SS7 Linkset (Sheet 5 of 11)

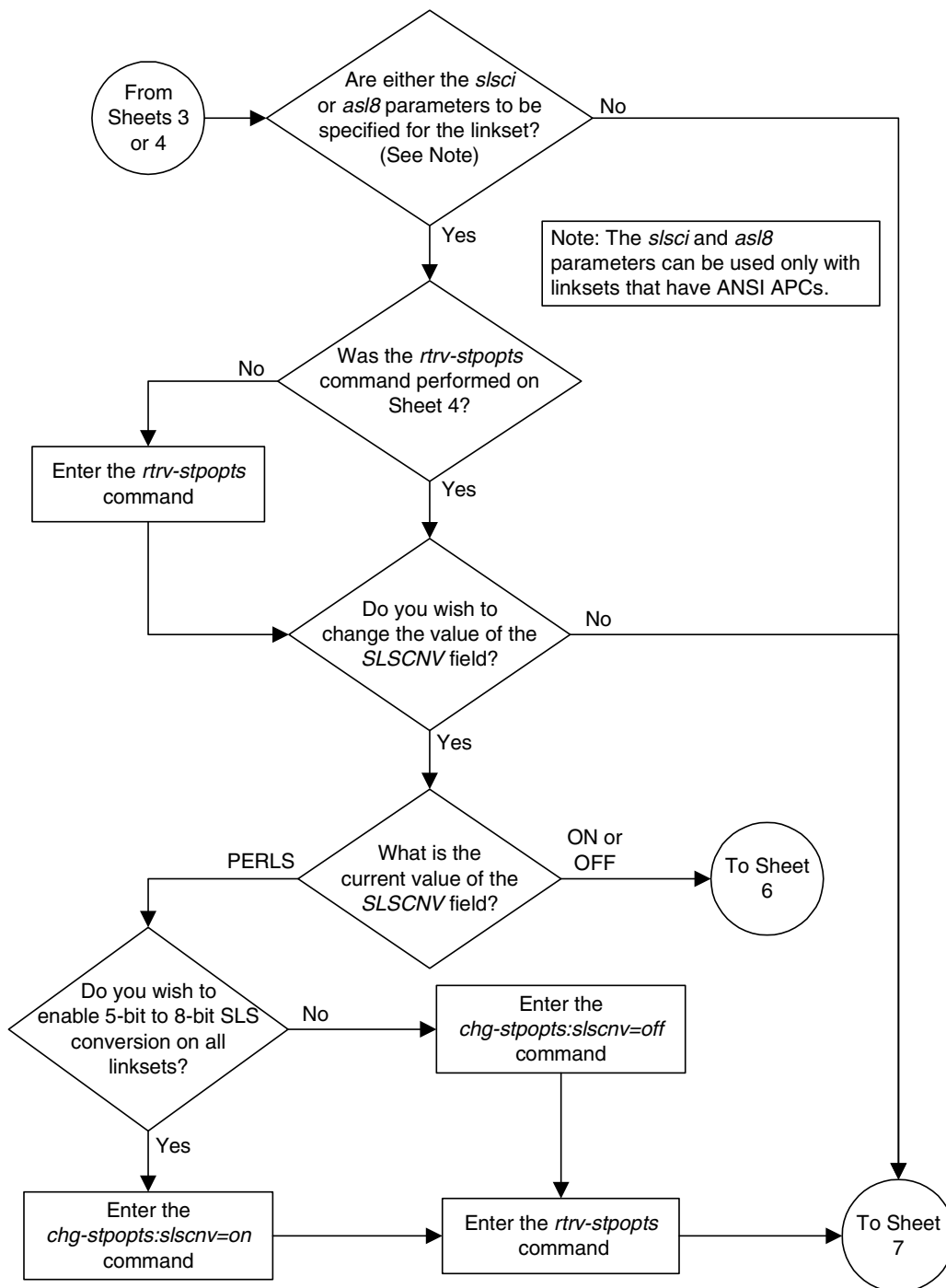

Flowchart 3-2. Adding an SS7 Linkset (Sheet 6 of 11)

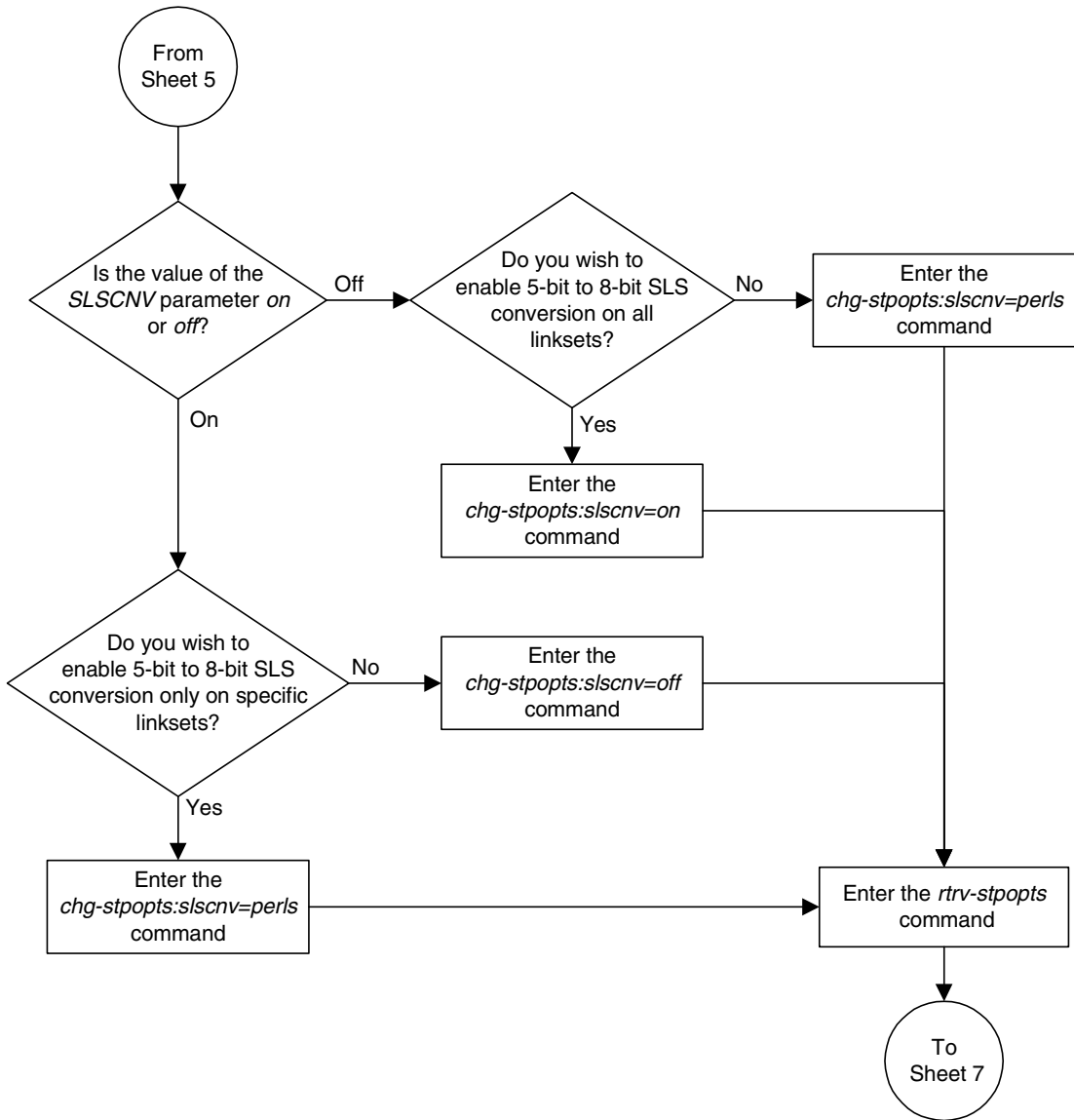

Flowchart 3-2. Adding an SS7 Linkset (Sheet 7 of 11)

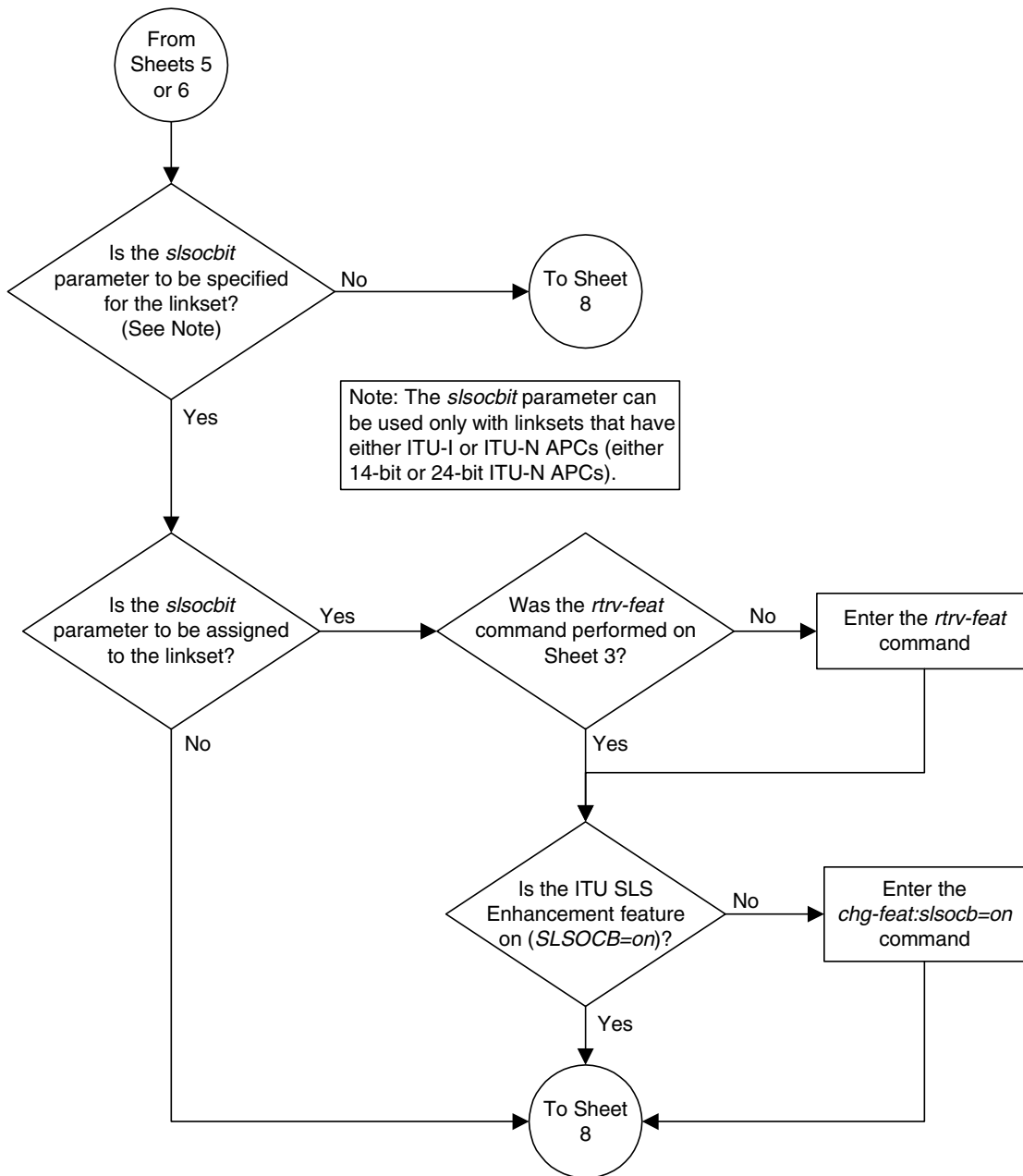

Flowchart 3-2. Adding an SS7 Linkset (Sheet 8 of 11)

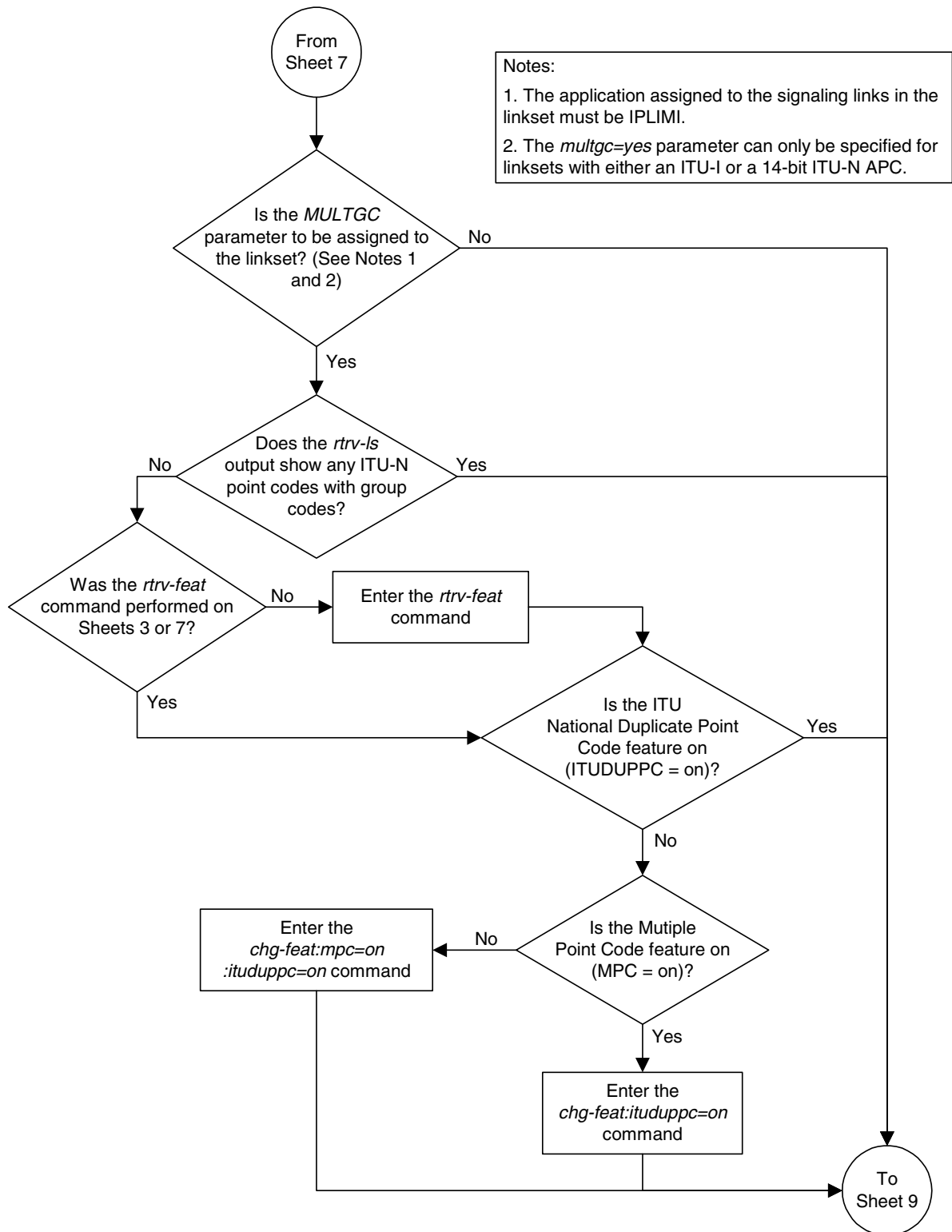

Flowchart 3-2. Adding an SS7 Linkset (Sheet 10 of 11)

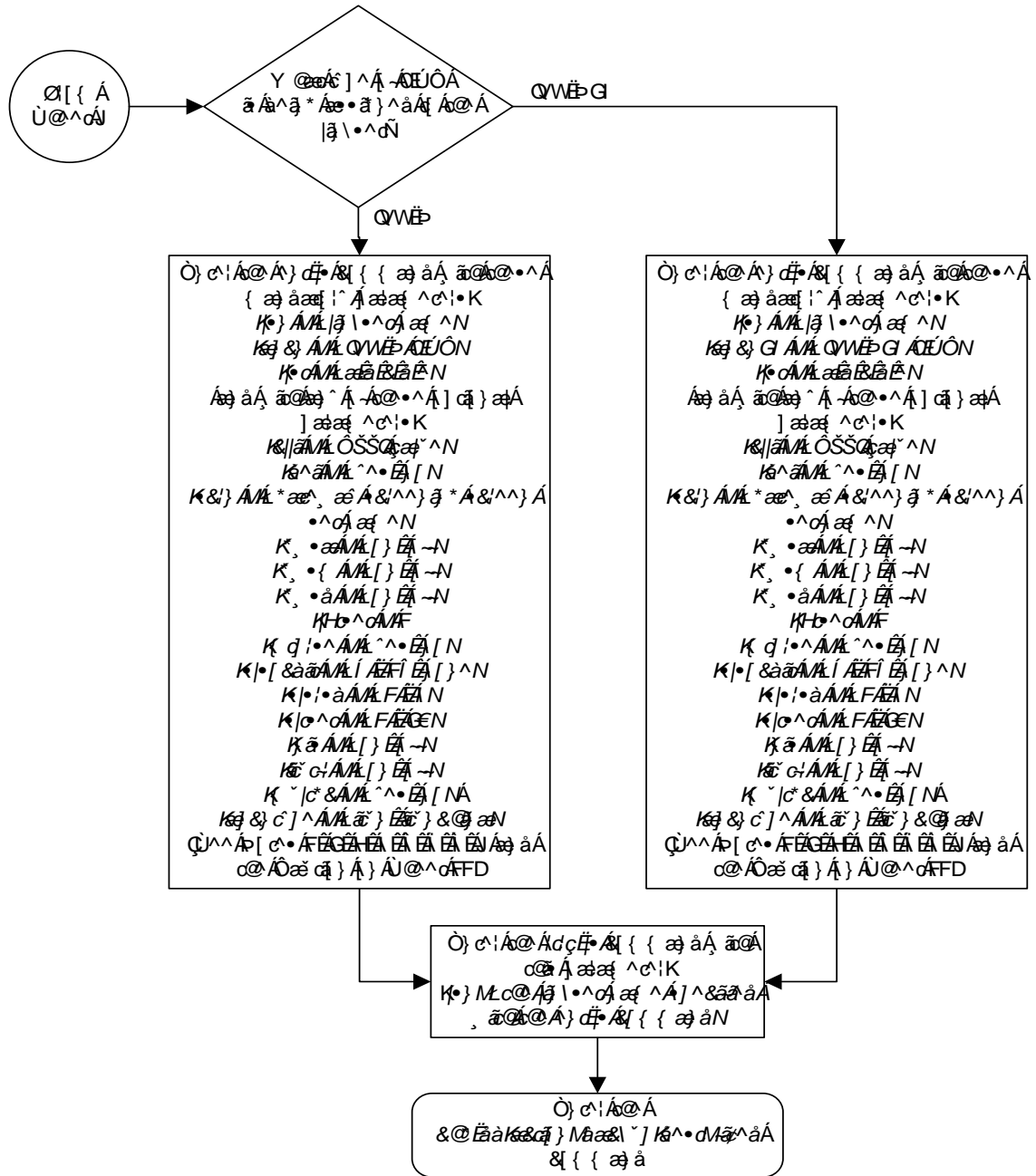

Flowchart 3-2. Adding an SS7 Linkset (Sheet 11 of 11)

Notes:

1. The adjacent point code must be a full point code, cannot be an alias point code, and must be shown in the *rtrv-dstn* output. Private point codes cannot be used as an adjacent point code in this procedure. Private point codes can be assigned only to IPGWx linksets. The procedures for configuring IPGWx linksets are in the *Database Administration Manual - IP⁷ Secure Gateway*.
2. The adjacent point code cannot be shown in the *rtrv-sid* output as the system's point code or any capability point codes.
3. The *gwsa*, *gwsn*, and *gwsd* parameters can be specified only if the *scrn* parameter is specified.
4. The *gwsd=on* parameter can be specified only with the *gwsa=on* parameter.
5. See the Signaling Link Selector (SLS) Conversion (ANSI Linksets Only) table in this procedure for the combinations of the *aslb* and *s/sci* parameters, and the *s/scnv* STP option, and the results that these combinations produce.
6. The *nis=on* parameter cannot be specified for linksets with ITU-I adjacent point codes.
7. The *mtrse=yes* parameter cannot be specified if the linkset will contain signaling links with the *iplim2=m3ua* parameter assigned.
8. The *multgc=yes* parameter can be specified only if the linkset being added will contain signaling links assigned to the IPLIMI application, and only for linksets with ITU-I or 14-bit ITU-N APCs.
9. The *itutfr=on* parameter can be specified only for linksets with ITU-N adjacent point codes (either 14-bit or 24-bit ITU-N APCs).

Caution: When Gateway Screening is in the screen test mode, as defined by the linkset parameters *gwsa=off* and *gwsn=on*, the gateway screening action in the gateway screening stop action set specified by the *actname* parameter of the gateway screening screen set at the end of the gateway screening process will be performed.

Removing a Linkset Containing SS7 Signaling Links

This procedure is used to remove a linkset containing SS7 signaling links from the database using the `dlt-ls` command. To remove linkset with X.25 signaling links, go to the “Removing a Linkset Containing X.25 Signaling Links” procedure in the *Database Administration Manual – Features*.

The `dlt-ls` command has only one parameter, `lsn`, which is the name of the linkset to be removed from the database.

The linkset to be removed must exist in the database.

To remove a linkset, all links associated with the linkset must be removed.

The linkset to be removed cannot be referenced by a routeset.

To remove an IPGWx linkset, a linkset containing signaling links assigned to cards running either the SS7IPGW or IPGWI applications, the IPGWx linkset cannot be the mate of another IPGWx linkset.

Canceling the RTRV-LS Command

Because the `rtrv-ls` command used in this procedure can output information for a long period of time, the `rtrv-ls` command can be canceled and the output to the terminal stopped. There are three ways that the `rtrv-ls` command can be canceled.

- Press the **F9** function key on the keyboard at the terminal where the `rtrv-ls` command was entered.
- Enter the `canc-cmd` without the `trm` parameter at the terminal where the `rtrv-ls` command was entered.
- Enter the `canc-cmd:trm=<xx>`, where `<xx>` is the terminal where the `rtrv-ls` command was entered, from another terminal other than the terminal where the `rtrv-ls` command was entered. To enter the `canc-cmd:trm=<xx>` command, the terminal must allow Security Administration commands to be entered from it and the user must be allowed to enter Security Administration commands. The terminal's permissions can be verified with the `rtrv-secu-trm` command. The user's permissions can be verified with the `rtrv-user` or `rtrv-secu-user` commands.

For more information about the `canc-cmd` command, go to the *Commands Manual*.

Procedure

1. Display the current linkset configuration using the **rtrv-ls** command. This is an example of the possible output.

```
rlghncxa03w 05-09-10 11:43:04 GMT EAGLE5 34.0.0

          L3T SLT          GWS GWS GWS
LSN      APCA  (SS7)  SCR N SET SET BEI LST LNKS ACT MES DIS SLSCI NIS
e1e2     001-207-000 none 1  1  no  B  6  off off off no  off
ls1305   000-005-000 none 1  1  no  A  1  off off off no  off
ls1307   000-007-000 none 1  1  no  A  1  off off off no  off
e1m1s1   001-001-001 none 1  1  no  A  7  off off off no  off
e1m1s2   001-001-002 none 1  1  no  A  7  off off off no  off
lsgw1103 003-002-004 none 1  1  no  A  1  off off off no  off

          L3T SLT          GWS GWS GWS
LSN      APCA  (X25)  SCR N SET SET BEI LST LNKS ACT MES DIS SLSCI NIS

          L3T SLT          GWS GWS GWS
LSN      APCI  (SS7)  SCR N SET SET BEI LST LNKS ACT MES DIS SLSCI NIS
e1e2i    1-207-0     none 1  1  no  B  4  off off off --- on
ls1315   0-015-0     none 1  1  no  A  1  off off off --- off
ls1317   0-017-0     none 1  1  no  A  1  off off off --- on
e1m2s1   1-011-1     none 1  1  no  A  7  off off off --- off
e1m2s2   1-011-2     none 1  1  no  A  7  off off off --- off

          L3T SLT          GWS GWS GWS
LSN      APCN  (SS7)  SCR N SET SET BEI LST LNKS ACT MES DIS SLSCI NIS

          L3T SLT          GWS GWS GWS
LSN      APCN24 (SS7)  SCR N SET SET BEI LST LNKS ACT MES DIS SLSCI NIS

          L3T SLT          GWS GWS GWS
LSN (CHINA) APCN  (SS7)  SCR N SET SET BEI LST LNKS ACT MES DIS SLSCI NIS

          L3T SLT          GWS GWS GWS
LSN (CHINA) APCN24 (SS7)  SCR N SET SET BEI LST LNKS ACT MES DIS SLSCI NIS

Link set table is (10 of 1024) 1% full.
```

2. Select a linkset whose adjacent point code is shown in the output of step 1 and is located in either the **APCA (SS7)**, **APCI (SS7)**, or **APCN (SS7)** fields. The adjacent point codes in these fields are in the SS7 domain. Display the signaling links in that linkset using the **rtrv-ls** command, specifying the linkset name of the linkset you wish to remove from the database. For this example, enter these commands.

```
rtrv-ls:lsn=ls1
```

This is an example of the possible output.

```
rlghncxa03w 05-09-17 11:43:04 GMT EAGLE5 34.0.0

          L3T SLT          GWS GWS GWS
LSN      APCA  (SS7)  SCR N SET SET BEI LST LNKS ACT MES DIS SLSCI NIS
ls1      240-012-004 scr1 1  1  yes a  4  off off off yes  off

          CLLI          TFATCABMLQ  MTPRSE  ASL8
rlghncbb001  2          no          no
```

SS7 Configuration

```

          L2T          L1          PCR PCR
LOC LINK SLC TYPE SET BPS MODE TSET ECM N1 N2
1205 b 0 LIMDS0 1 56000 --- --- BASIC --- -----
1213 b 1 LIMOCU 1 56000 --- --- BASIC --- -----
1211 a 2 LIMDS0 1 56000 --- --- BASIC --- -----
1207 b 3 LIMV35 1 64000 DCE OFF BASIC --- -----

          LP          ATM
LOC LINK SLC TYPE SET BPS TSEL VCI VPI LL
          LP          ATM          E1ATM
LOC LINK SLC TYPE SET BPS TSEL VCI VPI CRC4 SI SN
LOC LINK SLC TYPE IPLIML2
LOC LINK SLC TYPE

          L2T          PCR PCR E1 E1
LOC LINK SLC TYPE SET BPS ECM N1 N2 LOC PORT TS
          L2T          PCR PCR T1 T1
LOC LINK SLC TYPE SET BPS ECM N1 N2 LOC PORT TS

```

Link set table is (22 of 1024) 2% full

rtrv-ls:lsn=lsgw1103

This is an example of the possible output.

rlghncxa03w 05-09-17 11:43:04 GMT EAGLE5 34.0.0

```

          L3T SLT          GWS GWS GWS
LSN APCA (SS7) SCRN SET SET BEI LST LNKS ACT MES DIS SLSCI NIS
lsgw1103 003-002-004 none 1 1 no A 1 off off off no off

CLLI TFATCABMLQ MTPRSE ASL8
----- 1 no no

IPGWAPC MATELSN IPTPS LSUSEALM SLKUSEALM
yes ----- 10000 70 % 70 %

          L2T          L1          PCR PCR
LOC LINK SLC TYPE SET BPS MODE TSET ECM N1 N2
          LP          ATM
LOC LINK SLC TYPE SET BPS TSEL VCI VPI LL
          LP          ATM          E1ATM
LOC LINK SLC TYPE SET BPS TSEL VCI VPI CRC4 SI SN
LOC LINK SLC TYPE IPLIML2
LOC LINK SLC TYPE
1103 A 0 SS7IPGW

          L2T          PCR PCR E1 E1
LOC LINK SLC TYPE SET BPS ECM N1 N2 LOC PORT TS
          L2T          PCR PCR T1 T1
LOC LINK SLC TYPE SET BPS ECM N1 N2 LOC PORT TS

```

Link set table is (14 of 1024) 1% full

3. Display the routes in the database by using the `rtrv-rte` command, specifying the name of the linkset you wish to remove. For this example, enter these commands.

```
rtrv-rte:lsn=ls1
```

This is an example of the possible output.

```
rlghncxa03w 05-09-10 11:43:04 GMT EAGLE5 34.0.0
LSN          DPC          RC
ls1          240-012-004   10
             240-012-006   20
```

```
rtrv-rte:lsn=lsgw1103
```

This is an example of the possible output.

```
rlghncxa03w 05-09-10 11:43:04 GMT EAGLE5 34.0.0
LSN          DPC          RC
lsgw1103     003-002-004   10
```

If any routes reference the linkset to be removed, remove these routes by performing the “Removing a Route” procedure on page 3-189.

4. Deactivate the signaling links in the linkset using the `dact-slk` command. For this example, enter these commands.

```
dact-slk:loc=1205:link=b
```

```
dact-slk:loc=1207:link=b
```

```
dact-slk:loc=1211:link=a
```

```
dact-slk:loc=1213:link=b
```

```
dact-slk:loc=1103:link=a
```

When each of these commands have successfully completed, this message should appear.

```
rlghncxa03w 05-09-07 08:41:12 GMT EAGLE5 34.0.0
Deactivate Link message sent to card
```

5. Verify that the linkset is out-of-service maintenance disabled (OOS-MT-DSBLD) using the **rept-stat-ls** command, specifying the linkset name. For this example, enter these commands.

rept-stat-ls:lsn=ls1

This is an example of the possible output.

```
rlghncxa03w 05-09-23 13:35:08 GMT EAGLE5 34.0.0
LSN      APCA      PST      SST      AST
ls1      240-012-004   OOS-MT-DSBLD  Prohibit  -----
ALARM STATUS      = No Alarms
SCRSET  = scr1
GWSA    = ----
GWSM    = ----
GWSL    = ----
SLC SLK      SST      SLC SLK      SST
0  1205,B Unavail    8  ----,- UEQ
1  1213,B Unavail    9  ----,- UEQ
2  1211,A Unavail   10  ----,- UEQ
3  1207,B Unavail   11  ----,- UEQ
4  ----,- UEQ       12  ----,- UEQ
5  ----,- UEQ       13  ----,- UEQ
6  ----,- UEQ       14  ----,- UEQ
7  ----,- UEQ       15  ----,- UEQ
Command Completed.
```

rept-stat-ls:lsn=ls1

This is an example of the possible output.

```
rlghncxa03w 05-09-23 13:35:08 GMT EAGLE5 34.0.0
LSN      APCA      PST      SST      AST
lsgw1103 003-002-004   OOS-MT-DSBLD  Prohibit  -----
ALARM STATUS      = No Alarms
SCRSET  = scr1
GWSA    = ----
GWSM    = ----
GWSL    = ----
SLC SLK      SST      SLC SLK      SST
0  1103,A Unavail    8  ----,- UEQ
1  ----,- UEQ       9  ----,- UEQ
2  ----,- UEQ      10  ----,- UEQ
3  ----,- UEQ      11  ----,- UEQ
4  ----,- UEQ      12  ----,- UEQ
5  ----,- UEQ      13  ----,- UEQ
6  ----,- UEQ      14  ----,- UEQ
7  ----,- UEQ      15  ----,- UEQ
Command Completed.
```

6. If any signaling links in the linkset are the last signaling link on a card, the card must be placed out of service before that signaling link can be removed. Verify this by entering the `rtrv-slk` command and specifying each of the card locations shown in the output of step 2. Do not specify the `link` parameter. For this example, enter these commands.

```
rtrv-slk:loc=1205
```

This is an example of the possible output.

```
rlghncxa03w 05-09-19 21:17:04 GMT EAGLE5 34.0.0
                                L2T      L1
LOC LINK LSN          SLC TYPE  SET  BPS  MODE TSET  ECM  N1  N2
1205 B   ls1          0  LIMDS0  1   56000  --- ---  BASIC ---  -----
```

```
rtrv-slk:loc=1207
```

This is an example of the possible output.

```
rlghncxa03w 05-09-19 21:17:04 GMT EAGLE5 34.0.0
                                L2T      L1
LOC LINK LSN          SLC TYPE  SET  BPS  MODE TSET  ECM  N1  N2
1207 A   ls3          1  LIMV35  1   64000  DCE  OFF  BASIC ---  -----
1207 B   ls1          3  LIMV35  1   64000  DCE  OFF  BASIC ---  -----
```

```
rtrv-slk:loc=1211
```

This is an example of the possible output.

```
rlghncxa03w 05-09-19 21:17:04 GMT EAGLE5 34.0.0
                                L2T      L1
LOC LINK LSN          SLC TYPE  SET  BPS  MODE TSET  ECM  N1  N2
1211 A   ls1          2  LIMDS0  1   56000  --- ---  BASIC ---  -----
1211 B   ls2          0  LIMDS0  1   56000  --- ---  BASIC ---  -----
```

```
rtrv-slk:loc=1213
```

This is an example of the possible output.

```
rlghncxa03w 05-09-19 21:17:04 GMT EAGLE5 34.0.0
                                L2T      L1
LOC LINK LSN          SLC TYPE  SET  BPS  MODE TSET  ECM  N1  N2
1213 A   ls2          1  LIMOCU  1   56000  --- ---  BASIC ---  -----
1213 B   ls1          1  LIMOCU  1   56000  --- ---  BASIC ---  -----
```

```
rtrv-slk:loc=1103
```

This is an example of the possible output.

```
rlghncxa03w 05-09-19 21:17:04 GMT EAGLE5 34.0.0
LOC LINK LSN          SLC TYPE
1103 A   lsn1          0  SS7IPGW
```

- If the output of step 6 shows that any of the signaling links in the specified linkset are the last signaling links on the card, place that card out of service by using the **rmv-card** command, specifying the card location to be taken out of service. For this example, enter these commands.

```
rmv-card:loc=1205
```

When this command has successfully completed, this message should appear.

```
rlghncxa03w 05-09-07 11:11:28 GMT EAGLE5 34.0.0
Card has been inhibited.
```

```
rmv-card:loc=1103
```

When this command has successfully completed, this message should appear.

```
rlghncxa03w 05-09-07 11:11:28 GMT EAGLE5 34.0.0
Card has been inhibited.
```

- Remove all links in the linkset using the **dlt-slk** command. For this example, enter these commands.

```
dlt-slk:loc=1205:link=b
```

```
dlt-slk:loc=1207:link=b
```

```
dlt-slk:loc=1211:link=a
```

```
dlt-slk:loc=1213:link=b
```

```
dlt-slk:loc=1103:link=a
```

When each of these commands have successfully completed, this message should appear.

```
rlghncxa03w 05-09-07 08:41:17 GMT EAGLE5 34.0.0
DLT-SLK: MASP A - COMPLTD
```

NOTE: If the signaling links removed in step 8 were not assigned to either the SS7IPGW or IPGWI applications, skip steps 9, 10, and 11, and go to step 12.

- Display the IPGWx linksets by entering the **rept-stat-iptps** command. This is an example of the possible output.

```
rlghncxa03w 05-09-10 11:43:04 GMT EAGLE5 34.0.0
IP TPS USAGE REPORT
```

	THRESH	CONFIG		TPS	PEAK	PEAKTIMESTAMP

SYSTEM						
RLGHNCXA03W	100%	30000	TX:	7200	7600	04-06-10 11:40:04
			RCV:	7200	7600	04-06-10 11:40:04

LSN						
LSGW1101	80%	10000	TX:	7200	7600	04-06-10 11:40:04
			RCV:	7200	7600	04-06-10 11:40:04
LSGW1103	80%	10000	TX:	6700	7600	04-06-10 11:40:04
			RCV:	6500	7600	04-06-10 11:40:04
LSGW1105	80%	10000	TX:	7300	7450	04-06-10 11:40:04
			RCV:	7300	7450	04-06-10 11:40:04

Command Completed.

10. Enter the `rtrv-ls` command with one of the linkset names shown in step 9. This is to verify if the linkset being removed in this procedure is a mate to another IPGWx linkset.

Repeat this step until all the linksets in step 9 have been displayed, or a linkset is found that has the linkset being removed as a mate. For this example, enter this command.

```
rtrv-ls:lsn=lsgw1105
```

This is an example of the possible output.

```
rlghncxa03w 05-09-17 11:43:04 GMT EAGLE5 34.0.0

LSN          APCA  (SS7)  SCRN SET SET BEI LST LNKS ACT MES DIS SLSCI NIS
lsgw1105     009-002-003  none 1  1  no  A  1  off off off no  off

          L3T SLT          GWS GWS GWS
          SET SET BEI LST LNKS ACT MES DIS SLSCI NIS
          none 1  1  no  A  1  off off off no  off

CLLI          TFATCABMLQ MTPRSE ASL8
----- 1          no  no

IPGWAPC  MATELSN  IPTPS  LSUSEALM  SLKUSEALM
yes      lsgw1103  10000  70  %  70  %

LOC LINK SLC TYPE          L2T          L1          PCR PCR
          SET BPS          MODE TSET  ECM  N1  N2

LOC LINK SLC TYPE          LP          ATM
          SET BPS          TSEL          VCI          VPI  LL

LOC LINK SLC TYPE          LP          ATM          E1ATM
          SET BPS          TSEL          VCI  VPI  CRC4 SI SN

LOC LINK SLC TYPE          IPLIML2

LOC LINK SLC TYPE
1105 A  0  SS7IPGW

LOC LINK SLC TYPE          L2T          PCR PCR  E1  E1
          SET BPS          ECM  N1  N2  LOC  PORT TS

LOC LINK SLC TYPE          L2T          PCR PCR  T1  T1
          SET BPS          ECM  N1  N2  LOC  PORT TS

Link set table is ( 14 of 1024) 1% full
```

NOTE: If the `rtrv-ls` output in step 10 shows that the linkset being removed is not the mate of another IPGWx linkset, skip step 11 and go to step 12.

11. Remove the mate linkset assignment shown in step 10 by performing the "Configuring a Mate IPGWx Linkset" procedure in the *Database Administration Manual - IP⁷ Secure Gateway* using these parameters:

`:lsn` = the name of the linkset shown in the `LSN` field in step 10

`:matelsn` = the name of the linkset shown in the `MATELSN` field in step 10

`:action=delete`

12. Remove the linkset using the **dl~~t~~-ls** command. For this example, enter these commands.

```
dlt-ls:lsn=ls1
```

```
dlt-ls:lsn=lsgw1103
```

When each of these commands have successfully completed, this message should appear.

```
rlghncxa03w 05-09-17 16:03:12 GMT EAGLE5 34.0.0  
Link set table is ( 23 of 1024) 2% full  
DLT-LS: PSM A - COMPLTD
```

13. Verify the changes using the **r~~t~~rv-ls** command with the linkset name used in step 12. For this example, enter these commands.

```
rtrv-ls:lsn=lsn1
```

```
rtrv-ls:lsn=lsgw1103
```

If the removal of the linkset was successful, the following message is displayed.

```
E2346 Cmd Rej: Linkset not defined
```

14. Back up the new changes using the **chg-db:action=backup:dest=fixed** command. These messages should appear, the active Maintenance and Administration Subsystem Processor (MASP) appears first.

```
BACKUP (FIXED) : MASP A - Backup starts on active MASP.  
BACKUP (FIXED) : MASP A - Backup on active MASP to fixed disk complete.  
BACKUP (FIXED) : MASP A - Backup starts on standby MASP.  
BACKUP (FIXED) : MASP A - Backup on standby MASP to fixed disk complete.
```

Flowchart 3-3. Removing a Linkset Containing SS7 Signaling Links (Sheet 1 of 2)

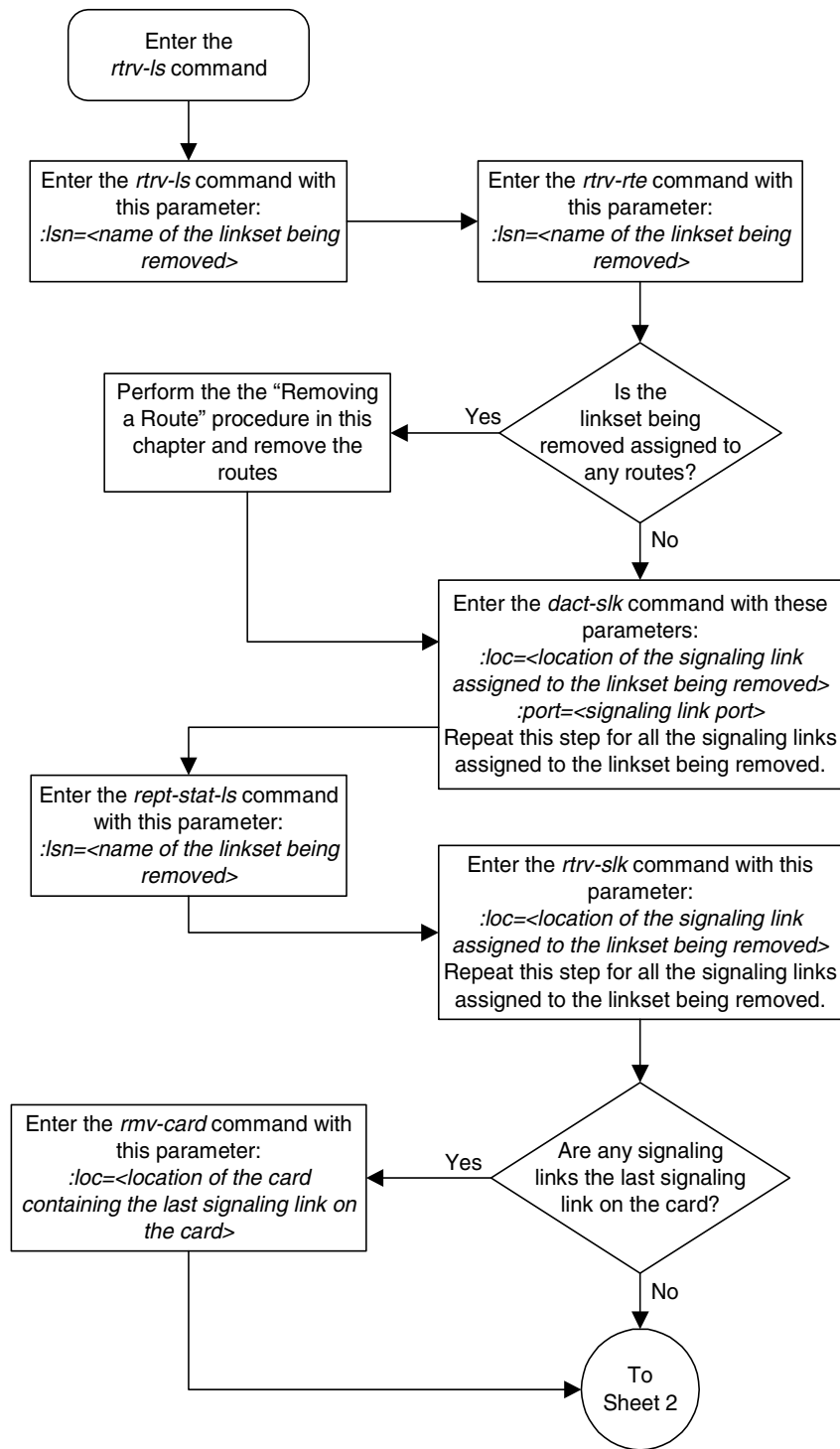

Flowchart 3-3. Removing a Linkset Containing SS7 Signaling Links (Sheet 2 of 2)

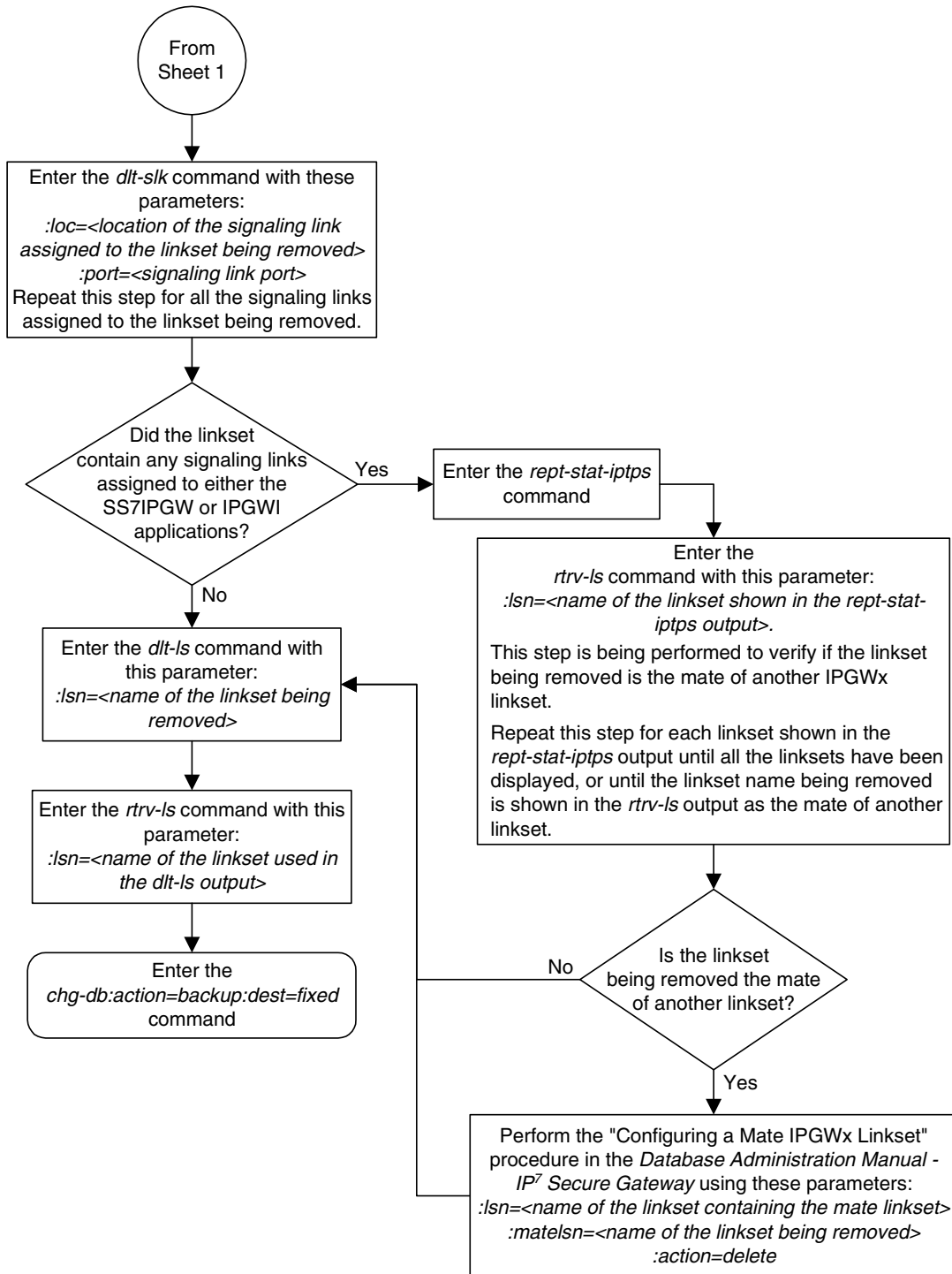

Changing an SS7 Linkset

This procedure is used to change the definition of linksets that contain SS7 signaling links using the **chg-ls** command without the **gmscrn**, **sapci**, **sapcn**, **sapcn24**, **iptps**, **lsusealm**, **slkusealm**, **matelsn**, and **action** parameters of the **chg-ls** command.

The **gmscrn** parameter is used for the GSM MAP Screening feature. To configure an SS7 linkset for the GSM MAP Screening feature, perform the “Configuring a Linkset for the GSM MAP Screening Feature,” in Chapter 5, “GSM MAP Screening Configuration,” in the *Database Administration Manual - Features*.

The **sapci**, **sapcn**, **sapcn24**, and **action** parameters are used for configuring secondary adjacent point codes for ITU linksets. For more information on these parameters, see the “Configuring an ITU Linkset with a Secondary Adjacent Point Code (SAPC)” procedure on page 3-113.

The **iptps**, **lsusealm**, **slkusealm**, **matelsn**, and **action** parameters are used to configure IPGWx linksets. To configure IPGWx linksets, perform one of these procedures in Chapter 3, “IP⁷ Secure Gateway Configuration Procedures,” in the *Database Administration Manual - IP⁷ Secure Gateway*.

- “Configuring an IPGWx Linkset”
- “Configuring a Mate IPGWx Linkset”

To change X.25 linksets, perform the “Changing an X.25 Linkset” procedure in the *Database Administration Manual – Features*.

The **chg-ls** command uses these parameters.

:lsn – The name of the linkset

:nlsn – The new name of the linkset

The linkset name can contain up to 10 characters, with the first character being a letter. However, the SEAS interface supports only eight characters. If this linkset is displayed on the SEAS interface and the linkset name contains more than eight characters, only the first eight characters in the linkset name are shown. If this linkset name contains more than eight characters, and is specified with the linkset commands on the SEAS interface, only the first eight characters can be specified.

:apc/apca/apci/apcn/apcn24 – Adjacent point code – the point code identifying the node that is next to the EAGLE 5 SAS. The adjacent point code can be one of the following types of point codes:

:apc/apca – ANSI point code

:apci – ITU-I point code, ITU-I spare point code

:apcn – 14-bit ITU-N point code, 14-bit ITU-N spare point code

:apcn24 – 24-bit ITU-N point code

NOTE: See “Point Code Formats” on page 2-4 for a definition of the point code types that are used on the EAGLE 5 SAS and for a definition of the different formats that can be used for ITU national point codes. Private point codes can be assigned only to IPGWx linksets. The procedures for configuring IPGWx linksets are in the *Database Administration Manual - IP⁷ Secure Gateway*.

:apctype – Specifies whether or not the linkset containing either a 14-bit ITU-N adjacent point code or a 24-bit ITU-N adjacent point code is being used in China (**:apctype=itunchina**) or in countries other than China (**:apctype=itun**). Signaling links in linksets with the **:apctype=itunchina** parameter are handled according to the specifications in *YD/N 068-1997, Technical Specification of National No.7 Signaling System - Message Transfer Part (MTP)*. Signaling links in linksets with the **:apctype=itun** parameter are handled according to the specifications in *ITU-T Q.2210 (07/96), Switching and Signaling, Broadband ISDN- Signaling Network Protocols*. The default value for the **:apctype** parameter is **itun**.

Linksets shown in section of the **rtrv-ls** output with the **LSN (CHINA)** column (and with either the **APCN** or **APCN24** column) have the **:apctype=itunchina** parameter assigned to them.

Linksets shown in section of the **rtrv-ls** output with the **LSN** column (and with either the **APCN** or **APCN24** column) have the **:apctype=itun** parameter assigned to them.

:lst – The linkset type of the specified linkset

:c11i – The Common Language Location Identifier assigned to this point code. The value of the **c11i** parameter is only displayed in the **rtrv-ls** command output when a specific linkset is being displayed with the **rtrv-ls:lsn=<linkset name>** command.

:sltset – The signaling link test message record to be associated with the linkset.

:l3tset – The level 3 timer set table. This parameter identifies which level three timer set is to be assigned to this linkset. Currently, only one is supported.

:scrn – The name of the screenset to be assigned to this linkset if gateway screening is to be used.

:gwsa – Gateway screening action determines whether gateway screening (GWS) is on or off for the specified link set.

:gwsm – Gateway screening messaging is used to turn on or off the display of messages generated for each screened message. When an MSU is rejected by gateway screening, a message is output to alert personnel of the event.

:gwsd – Gateway screening MSU discard is used to turn on or off the discarding of MSUs that bypass the gateway screening function due to load

shedding. Also use this parameter with the redirect function; MSUs that cannot be screened are discarded if you specify **gwsd=on**.

:bei – The broadcast exception indicator. This parameter indicates whether TFP (transfer prohibited) messages are allowed to be broadcast on the linkset. The **yes** parameter means TFPs are not broadcast. The **no** parameter means TFPs are broadcast.

:tfatcabmlq – the TFA/TCA broadcast minimum link quantity shows the minimum number of signaling links in the given link set (or in the combined link set in which it resides) that must be available for traffic. When the number of signaling links in the specified linkset is equal to or greater than the value of the **tfatcabmlq** parameter, the status of the routes that use the specified linkset is set to allowed and can carry traffic. Otherwise, these routes are restricted. The value of the **tfatcabmlq** parameter cannot exceed the total number of signaling links contained in the linkset. The system default value for the **tfatcabmlq** parameter is 0.

The value of the **tfatcabmlq** parameter is only displayed in the **rtrv-ls** command output when a specific linkset is being displayed with the **rtrv-ls:lsn=<linkset name>** command.

The **tfatcabmlq** parameter exists only in the **chg-ls** command and not the **ent-ls** command, because no links are assigned to the linkset when the linkset is first created with the **ent-ls** command. The default value for the **tfatcabmlq** parameter (**tfatcabmlq=0**) is entered for the linkset, and shown in the **rtrv-ls** output as 1, when a new linkset is added to the database.

When the **tfatcabmlq** parameter value is 0, the EAGLE 5 SAS broadcasts TFAs/TCAs only when 1/2 of the links in the linkset (or in the combined link set in which it resides) become available. The **tfatcabmlq** parameter value displayed in the **rtrv-ls** output is 1/2 of the number of signaling links contained in the linkset, or 1 when the linkset contains 0 to 3 signaling links. As signaling links are added or removed from the linkset, the **tfatcabmlq** parameter value will be changed automatically.

When the **lst=c** parameter is specified, or when the current (unchanged) **LST** value is **C**, the **tfatcabmlq** parameter cannot be specified unless the **LSRESTRICT** SS7 option is **on**. The state of the **LSRESTRICT** SS7 option is shown in the **rtrv-ss7opts** output.

:nis – specifies whether the National Spare for Network Indicator feature is on or off for the specific linkset. This feature allows the linkset to use the national spare value (3) for the network indicator code field in the service information octet (SIO) of the MSU for ANSI linksets and ITU national linksets (linksets containing either 14-bit ITU-N point codes or 24-bit ITU-N point codes). This parameter cannot be specified for ITU international linksets. The default value for the **nis** parameter is **off**.

For MSUs on incoming linksets, only those MSUs having the network indicator code values shown in Table 3-7 on page 3-77 are allowed into the EAGLE 5 SAS.

SS7 Configuration

For MSUs on outgoing linksets, the network indicator code value in the MSU is changed to either the national network indicator code value (2) or the national spare network indicator code value (3). If the `nis` parameter is set to `off`, the network indicator code value is set to 2.

These actions are summarized in Table 3-7 on page 3-77.

The actions described for this parameter apply only if the ITU National and International Spare Point Code Support feature is not enabled.

If the ITU National and International Spare Point Code Support feature is enabled, the `nis` parameter value is ignored for ITU-I and 14-bit ITU-N linksets. All the network indicator values are permitted on ITU-I and ITU-N linksets, and the network indicator value for transmission is based on the International/National and Spare/Non-Spare status of the DPC of the message.

Having the ITU National and International Spare Point Code Support feature enabled has no effect on ANSI and 24-bit ITU-N linksets. The `nis` parameter value determines which incoming network indicator spare bit values to permit, and what network indicator spare bit value should be transmitted.

Table 3-7. Actions of the National Spare for Network Indicator Feature

Linkset Type	Feature Disabled	Feature Enabled
Incoming ANSI Linkset	MSUs containing the national network indicator code (2) are allowed into the EAGLE 5 SAS.	MSUs containing these network indicator code values are allowed into the EAGLE 5 SAS. <ul style="list-style-type: none"> • National Network Indicator Code (2) • National Spare Network Indicator Code (3)
Outgoing ANSI Linkset	The network indicator code value in the MSU is set to the national network indicator code (2).	The network indicator code value in the MSU is set to the national spare network indicator code (3).
Incoming ITU National Linkset	MSUs containing these network indicator code values are allowed into the EAGLE 5 SAS. <ul style="list-style-type: none"> • International Network Indicator Code (0) • National Network Indicator Code (2) 	MSUs containing these network indicator code values are allowed into the EAGLE 5 SAS. <ul style="list-style-type: none"> • International Network Indicator Code (0) • National Network Indicator Code (2) • National Spare Network Indicator Code (3)
Outgoing ITU National Linkset	The network indicator code value in the MSU is set to the national network indicator code (2).	The network indicator code value in the MSU is set to the national spare network indicator code (3).

:itutfr – specifies whether or not ITU TFR (transfer restricted) procedures are being used on the linkset. This parameter applies only to linksets with ITU national adjacent point codes (linksets containing either 14-bit ITU-N point codes or 24-bit ITU-N point codes) and can be specified only for linksets with ITU national adjacent point codes. TFR procedures are used to redirect traffic away from a node that is having problems routing traffic to a destination. When a node determines that a destination is restricted, the node sends a TFR message informing the adjacent nodes about the destination's status. When a destination is restricted, the node should not be used to route messages to the destination even though it still has limited capability to do so. The values for this parameter are either **on** (ITU TFR procedures are enabled) or **off** (ITU TFR procedures are disabled).

NOTE: For more information on the **itutfr** parameter and ITU TFR procedures, see "ITU TFR Procedures" on page 3-33.

:mtpmse – shows if the node adjacent to the EAGLE 5 SAS is equipped with the MTP restart capability. The **mtpmse=yes** parameter can only be specified if the MTP restart feature is turned on for ANSI linksets (**MTPRS = on** in the **rtrv-feat** command output), or if the ITU MTP restart is on for ITU linksets (**ITUMTPRS=on** in the **rtrv-feat** command output). If the MTP restart feature is not turned on, or the APC of the linkset is in the X25 domain, the value of the **mtpmse** parameter defaults to **no**. The value of the **mtpmse** parameter value is not dependent on the value of the **mtpmsi** parameter (the MTP restart indicator) in the **chg-stpopts** command. The value of the **mtpmse** parameter is only displayed in the **rtrv-ls** command output when a specific linkset is being displayed with the **rtrv-ls:lsn=<linkset name>** command.

NOTE: For more information on the **mtpmse** parameter and MTP restart, see "MTP Restart" on page 3-24.

:slsci – indicates whether the 5-bit to 8-bit SLS conversion feature is used to select signaling links for outgoing messages on the specified link set. If the **slsci=yes** parameter is specified, the EAGLE 5 SAS replaces any 5-bit SLS values contained in received messages with a random 8-bit value before they are used by the EAGLE 5 SAS to select the outgoing signaling link in that linkset. The 5-bit to 8-bit SLS conversion is also controlled by the **slscnv** parameter of the **chg-stpopts** command. The **slscnv** parameter of the **chg-stpopts** command has three values: **on**, **off**, and **perl**.

The **slsci** parameter can only be specified for linksets with ANSI SS7 adjacent point codes.

:as18 – shows if the node adjacent to the EAGLE 5 SAS is sending MSUs with 8-bit SLSs. If the **as18=yes** parameter is specified with the **lst=a** parameter (a linkset containing access signaling links), this indicates that the originator of the MSUs is generating 8-bit SLSs. For other linkset types, the **as18=yes** parameter indicates that the adjacent node is converting 5-bit SLSs to 8-bit SLSs. The SLS in MSUs received by the EAGLE 5 SAS on a linkset that has the **as18=yes** parameter assigned to it will not be converted. These MSUs are assumed to contain 8-bit SLSs. If the **as18=no** parameter is specified for the

linkset, the SLS will be converted to an 8-bit SLS. The **as18** parameter can only be specified for linksets with ANSI SS7 adjacent point codes. The value of the **as18** parameter is only displayed in the **rtrv-ls** command output when a specific linkset is being displayed with the **rtrv-ls:lsn=<linkset name>** command.

NOTE: For more information on the **s1sci and **as18** parameters and 5-bit to 8-bit conversion, see “5-Bit to 8-Bit SLS Conversion” on page 3-26.**

:s1srsb – selects which bit (1 - 4) of the SLS field to use as the least significant bit for signaling link selection in the link set for all ITU messages.

:s1socbit – selects which bit (5 - 16) of the SLS field to use as the most significant bit for signaling link selection in the link set for all ITU messages.

NOTE: For more information on the **s1srsb and **s1socbit** parameters and ITU SLS enhancement, see “ITU SLS Enhancement” on page 3-29.**

:multgc – specifies whether multiple group codes are supported for the linkset. When this parameter value is **yes**, secondary adjacent point codes whose group codes are different from the adjacent point code of the linkset can be assigned to the linkset. If the parameter value is **no**, the group code of the secondary adjacent point code must be the same as the group code of the linkset’s adjacent point code. For more information on secondary adjacent point codes, go to the “Configuring an ITU Linkset with a Secondary Adjacent Point Code (SAPC)” procedure on page 3-113.

This parameter only applies to linksets whose adjacent point codes are either ITU international point codes or 14-bit ITU national point codes. All the signaling links in this linkset must be assigned to cards running the IPLIMI application. For more information on assigning signaling links to cards running the IPLIMI application, go to the “Adding an IP Signaling Link” procedure in the *Database Administration Manual - IP⁷ Secure Gateway*.

The ITU duplicate point code feature must be on before this parameter can be specified. Verify this with the **rtrv-feat** command. If the ITU duplicate point code feature is turned on, the **itupuppc** field should be set to **on**. If the ITU duplicate point code feature is not turned on, enter the **chg-feat:itupuppc=on** command.

NOTE: Once the ITU duplicate point code feature is turned on with the **chg-feat command, it cannot be turned off.**

The ITU duplicate point code feature must be purchased before you turn the feature on with the **chg-feat command. If you are not sure if you have purchased the ITU duplicate point code feature, contact your Tekelec Sales Representative or Account Representative.**

The EAGLE 5 SAS can contain 1024 linksets, with a maximum of 255 of these linksets being gateway linksets. A gateway linkset is a linkset that contains routes to a different network.

The linkset to be changed must exist in the database.

If the adjacent point code (APC) is changed, the new APC must be in the destination point code table and must be defined as a true point code in the destination point code table and cannot be an alias point code. The domain and point code type of the new APC must be the same as the APC being changed. For example, if the current adjacent point code is an ITU-I point code, the new adjacent point code must be an ITU-I point code. The new APC of the linkset cannot match the self ID of the EAGLE 5 SAS. The new APC must be a full point code and cannot be a cluster point code or a network routing point code.

Linksets containing E1 ATM signaling links or IPLIM SAALTALI signaling links cannot contain 24-bit ITU-N APCs or SAPCs. E1 ATM signaling links are identified by the value **LIME1ATM** in the **TYPE** column of the **rtrv-ls:lsn=<linkset name>** output. IPLIM SAALTALI signaling links are identified by the value **SAALTALI** in the **IPLIML2** column of the **rtrv-ls:lsn=<linkset name>** output.

The signaling link configuration of the linkset can be verified by entering the **rtrv-ls:lsn=<linkset name>** command specifying the linkset name as shown in step 3.

Use the **rtrv-dstn** command to verify that the new APC is in the destination point code table and to verify the domain of the new APC. If the new APC is not shown in the **rtrv-dstn** command output, go to the “Adding a Destination Point Code” procedure on page 2-191 procedures and add the APC to the destination point code table.

To change the APC of a linkset, all signaling links in the linkset must be in the OOS-MT-DSBLD state.

The domain of the linkset’s APC cannot be changed using the **chg-ls** command. For example, if the current domain of the APC is SS7, the new APC must also be in the SS7 domain. To change the domain of the linkset’s APC, the linkset must be removed from the database using the **dlr-ls** command and re-entered with the new APC in the different domain using the **ent-ls** command. To remove the SS7 linkset, go to the “Removing a Linkset Containing SS7 Signaling Links” procedure on page 3-63. To add the SS7 linkset, go to the “Adding an SS7 Linkset” procedure on page 3-17. To add an X.25 linkset, go to the “Adding an X.25 Linkset” procedure in the *Database Administration Manual – Features*.

The **gwsa**, **gwsn**, and **gwsd** parameters can only be specified if the **scrn** parameter is defined. Enter the **rtrv-ls** command to verify that the **scrn** parameter is defined for the specified linkset. If the **scrn** parameter is defined, a gateway screening screen set name is shown in the **SCRN** field of the output. This gateway screening screen set name must also be defined as a gateway screening screen set entity. This can be verified with the **rtrv-scrset** command.



CAUTION: When Gateway Screening is in the screen test mode, as defined by the linkset parameters **gwsa=off** and **gwsn=on**, the gateway screening action in the gateway screening stop action set specified by the **actname** parameter of the gateway screening screen set at the end of the gateway screening process will be performed.

The **chg-1s** command has a parameter, **gwsd**, that can allow the discarding of messages that should have gone through the gateway screening process, but could not. The **gwsd** parameter is only intended to be used with the database transport access (DTA) feature. If you are not using the DTA feature, the **gwsd** parameter should not be specified or should be set to **no** (**gwsd=no**).

If the **gwsa=off** parameter is specified, then the **gwsd=off** parameter must be specified.

To help manage congestion on signaling links, the EAGLE 5 SAS starts the level 3 T31 timer whenever a signaling link goes into congestion level 1 or congestion level 2. The congestion level that is associated with the level 3 T31 timer is set using the **chg-stpopts** command with the **mtpt31ctl** parameter and is displayed with the **MTPT31CTL** field in the **rtrv-stpopts** command output. When the level 3 timer T31 and the **chg-stpopts** command are first introduced to the EAGLE 5 SAS, the system default value for the **mtpt31ctl** parameter of the **chg-stpopts** command is 1, for congestion level 1, and the system default value for the level 3 T31 timer is 60 seconds. To change the value of the level 3 T31 timer, go to the "Changing Level 3 Timers" procedure on page 3-222. To change value of the **mtpt31ctl** parameter, enter the either **chg-stpopts:mtpt31ctl=1** or the **chg-stpopts:mtpt31ctl=2** command, depending on the current value of the **mtpt31ctl** parameter.

To help prevent the signaling link in the linkset from oscillating in out of service, the EAGLE 5 SAS starts the level 3 T32 timer. When the EAGLE 5 SAS begins restoring an out of service signaling link, the EAGLE 5 SAS starts the level 3 T32 timer. If the signaling link fails to get back into service before the level 3 T32 expires, the EAGLE 5 SAS does not attempt to continue to bring the signaling link into service until the level 3 T32 timer expires. Once the level 3 T32 timer expires, the EAGLE 5 SAS attempts to restore the signaling link into service. When the level 3 timer T32 is first introduced to the EAGLE 5 SAS, the system default value for the level 3 T32 timer is 60 seconds. To change the value of the level 3 T32 timer, go to the "Changing Level 3 Timers" procedure on page 3-222.

The word **SEAS** cannot be used as a value for the **scrn** parameter of the **chg-1s** command. The word **SEAS** is used in the **rtrv-1s** command output, in the **SCRN** field, to show gateway linksets created on the SEAS interface. A gateway linkset combines the functions of a gateway screening screen set and an SS7 linkset specifying the **gwsa=on** and **scrn** parameters. Like an EAGLE 5 SAS gateway screening screen set, a gateway linkset defines the screening references that are to be used to screen the messages on the linkset. It also defines the linkset whose messages are to be screened. A gateway linkset can only be configured from a SEAS terminal and not from an EAGLE 5 SAS terminal.

If the **c11i** parameter is specified with the **chg-1s** command, the value of the **c11i** parameter must match the CLLI value of the adjacent point code of the linkset. The CLLI value of the adjacent point code is shown in the **CLLI** field of the **rtrv-dstn** command.

The **c11i** parameter can only be specified with the **apc** or **apca** parameters.

If the **randsls** parameter of the **chg-stpopts** command is set to either **all** or **class0**, a maximum of 16 links continues to be supported in a single linkset to a destination. However, it is now possible to have up to 32 links in a combined linkset to a destination, with a maximum of 16 links per linkset. The 32 links is a change from the current EAGLE 5 SAS maximum of only 16 links per combined linkset, which is due to ITU protocol restrictions. If more than 16 links are used in a combined linkset, the operator needs to be aware that a maximum of 16 links can be used by non-Random SLS traffic over the linkset. The non-Random SLS traffic continues to operate under the rules of the ITU protocol. For more information on the Random SLS Generation feature, go to the “Configuring the System for Random SLS Generation” procedure on page 3-254.

Sample Linkset Configuration

In this procedure, the examples are used to change the definition of linksets **ls04** and **lsn5**. The attributes of linkset **ls04** that are changed in this example are the APC, the gateway screening screen set name, to turn on the gateway screening association with linkset **ls04**. The ITUTFR procedure parameter for linkset **lsn5** are changed from **off** to **on**. For any optional parameters not specified with the **chg-ls** command, the values for those parameters are not changed.

Canceling the RTRV-LS and RTRV-DSTN Commands

Because the **rtrv-ls** and **rtrv-dstn** commands used in this procedure can output information for a long period of time, the **rtrv-ls** and **rtrv-dstn** commands can be canceled and the output to the terminal stopped. There are three ways that the **rtrv-ls** and **rtrv-dstn** commands can be canceled.

- Press the **F9** function key on the keyboard at the terminal where the **rtrv-ls** or **rtrv-dstn** commands were entered.
- Enter the **canc-cmd** without the **trm** parameter at the terminal where the **rtrv-ls** or **rtrv-dstn** commands were entered.
- Enter the **canc-cmd:trm=<xx>**, where **<xx>** is the terminal where the **rtrv-ls** or **rtrv-dstn** commands were entered, from another terminal other than the terminal where the **rtrv-ls** or **rtrv-dstn** commands were entered. To enter the **canc-cmd:trm=<xx>** command, the terminal must allow Security Administration commands to be entered from it and the user must be allowed to enter Security Administration commands. The terminal’s permissions can be verified with the **rtrv-secu-trm** command. The user’s permissions can be verified with the **rtrv-user** or **rtrv-secu-user** commands.

For more information about the **canc-cmd** command, go to the *Commands Manual*.

Procedure

1. Display the current linkset configuration using the `rtrv-ls` command. This is an example of the possible output.

```
rlghncxa03w 05-09-10 11:43:04 GMT EAGLE5 34.0.0

LSN          APCA      (SS7)      L3T SLT          GWS GWS GWS
SCRN SET SET BEI LST LNKS ACT MES DIS SLSCI NIS
ele2         001-207-000 none 1 1 no B 6 off off off no off
ls1305      000-005-000 none 1 1 no A 1 off off off no off
ls1307      000-007-000 none 1 1 no A 1 off off off no off
elm1s1      001-001-001 none 1 1 no A 7 off off off no off
elm1s2      001-001-002 none 1 1 no A 7 off off off no off

LSN          APCA      (X25)      L3T SLT          GWS GWS GWS
SCRN SET SET BEI LST LNKS ACT MES DIS SLSCI NIS

LSN          APCI      (SS7)      L3T SLT          GWS GWS GWS
SCRN SET SET BEI LST LNKS ACT MES DIS SLSCI NIS
ele2i       1-207-0   none 1 1 no B 4 off off off --- on
ls1315      0-015-0   none 1 1 no A 1 off off off --- off
ls1317      0-017-0   none 1 1 no A 1 off off off --- on
elm2s1      1-011-1   none 1 1 no A 7 off off off --- off
elm2s2      1-011-2   none 1 1 no A 7 off off off --- off

LSN          APCN      (SS7)      L3T SLT          GWS GWS GWS
SCRN SET SET BEI LST LNKS ACT MES DIS SLSCI NIS

LSN          APCN24   (SS7)      L3T SLT          GWS GWS GWS
SCRN SET SET BEI LST LNKS ACT MES DIS SLSCI NIS

LSN (CHINA) APCN      (SS7)      L3T SLT          GWS GWS GWS
SCRN SET SET BEI LST LNKS ACT MES DIS SLSCI NIS

LSN (CHINA) APCN24 (SS7)      L3T SLT          GWS GWS GWS
SCRN SET SET BEI LST LNKS ACT MES DIS SLSCI NIS

Link set table is (10 of 1024) 1% full.
```

If the adjacent point code (APC) of the linkset is being changed, go to step 3. If the APC is not being changed, go to step 5. In this example, the APC of the linkset is being changed, so proceed to step 3.

2. Display the point code and capability point code of the EAGLE 5 SAS by using the `rtrv-sid` command. This is an example of the possible output.

```
rlghncxa03w 05-09-10 11:43:04 GMT EAGLE5 34.0.0

PCA          PCI          PCN          CLLI          PCTYPE
001-001-001 1-200-6      13482       rlghncxa03w  OTHER

CPCA
002-002-002      002-002-003      002-002-004      002-002-005
002-002-006      002-002-007      002-002-008      002-002-009
004-002-001      004-003-003      144-212-003

CPCA (LNP)
005-005-002      005-005-004      005-005-005
```

```

CPCI
1-001-1          1-001-2          1-001-3          1-001-4

CPCN
02091           02092           02094           02097
02191           02192           11177

```

3. Display the point codes in the destination point code table by using the **rtrv-dstn** command. This is an example of the possible output.

```

rlghncxa03w 05-09-10 11:43:04 GMT EAGLE5 34.0.0
DPCA          CLLI          BEI  ELEI  ALIASI          ALIASN/N24  DOMAIN
001-002-003  ls04ccli      yes  ---  -----  -----  SS7
002-002-100  ls01ccli      no   ---  -----  -----  SS7
002-007-008  ls06ccli      yes  ---  -----  -----  SS7
002-009-003  -----      no   ---  -----  -----  SS7
002-250-010  -----      no   ---  -----  -----  SS7
003-003-003  ls03ccli      yes  ---  -----  -----  SS7
003-020-100  -----      no   ---  -----  -----  SS7
004-004-004  ls02ccli      yes  ---  -----  -----  SS7
004-030-200  -----      no   ---  -----  -----  SS7
009-002-003  -----      no   ---  -----  -----  SS7
179-100-087  -----      yes  ---  -----  -----  SS7
200-050-176  -----      yes  ---  -----  -----  SS7
240-007-000  -----      yes  ---  -----  -----  SS7
240-012-004  rlghncbb001  yes  ---  1-111-1  11111  SS7
240-012-005  rlghncbb002  yes  ---  1-112-2  11112  SS7
240-012-006  rlghncbb003  yes  ---  1-112-3  11113  SS7
240-012-008  -----      yes  ---  1-113-5  11114  SS7
244-010-004  ls06ccli      no   ---  -----  -----  X25
244-012-005  ls07ccli      no   ---  -----  -----  X25
244-012-006  ls08ccli      no   ---  -----  -----  X25
244-012-007  -----      no   ---  -----  -----  X25
244-012-008  -----      no   ---  -----  -----  X25

DPCI          CLLI          BEI  ELEI  ALIASA          ALIASN/N24  DOMAIN
2-131-1      rlghncbb023  no   ---  222-210-000  12001  SS7
2-131-2      -----      no   ---  222-211-001  12002  SS7
2-131-3      -----      no   ---  222-211-002  12003  SS7
3-150-4      lsi7ccli      yes  ---  -----  -----  SS7

DPCN          CLLI          BEI  ELEI  ALIASA          ALIASI          DOMAIN
10685        lsn5ccli      yes  ---  -----  -----  SS7
11211        rlghncbb013  no   ---  222-200-200  2-121-1  SS7
11212        rlghncbb013  no   ---  222-200-201  2-121-2  SS7

DPCN24        CLLI          BEI  ELEI  ALIASA          ALIASI          DOMAIN

```

Destination table is (27 of 2000) 1% full

Alias table is (18 of 8000) 1% full

RTRV-DSTN: MASP A - COMPLTD

If the adjacent point code is not shown in the **rtrv-dstn** command output, go to the "Adding a Destination Point Code" procedure on page 2-191 and add the adjacent point code to the destination point code table.

NOTE: If the screen set assigned to the linkset is not being changed, or if the screen set that you wish to assign to the linkset is assigned to other linksets (shown in the `SCRN` field of the `rtrv-ls` command output in step 1), skip step 4 and go to step 5.

4. Verify that the gateway screening screen set that is to be assigned to the linkset is in the database by entering the `rtrv-scrset` command. This is an example of the possible output.

```
rlghncxa03w 05-09-28 16:37:05 GMT EAGLE5 34.0.0
ENTIRE GWS DATABASE IS 1% FULL
CDPA + AFTPC TABLES ARE 1% FULL
THERE ARE 243 SCREEN SETS AVAILABLE
```

```
THE FOLLOWING ARE OVER 80% FULL:
SCRN  NSFI      NSR/ACT  FULL  RULES  TABLES  DESTFLD

SCRN  NSFI      NSR/ACT  FULL  RULES  TABLES  DESTFLD
fld1  OPC        fld2     1%    5      4        NO
gws1  OPC        gws4     1%    9      7        NO
gws2  BLKOPC     gws5     1%    5      4        NO
ls01  SIO        ls02     1%    3      3        YES
scr1  OPC        opc1     1%    37     10       YES
scr2  OPC        opc2     2%    75     22       YES
scr3  OPC        opc3     2%    75     22       YES
scr4  OPC        opc1     51%   2075   22       NO
scr5  OPC        opc1     51%   2075   22       YES
scr6  OPC        opc1     51%   2075   22       NO
ss28  OPC        opc1     51%   2075   22       YES
wr1   SIO        iec      1%    6      5        YES
```

If you wish to examine the contents of a particular screen set, enter the `rtrv-scrset:scrn=<screen set name>` command specifying a screen set name shown in the `SCRN` field of either the `rtrv-scrset` command executed in this step or the `rtrv-ls` command executed in step 1. For this example, enter the `rtrv-scrset:scrn=scr1` command. This is an example of the possible output.

```
rtrv-scrset:scrn=scr1
rlghncxa03w 05-09-14 16:39:04 GMT EAGLE5 34.0.0
SCRN  NSFI      NSR/ACT  RULES  DESTFLD
scr1  OPC        opc1     3      Y
      BLKDPC   bkd2     2
      CGPA    cgp1     3
      TT      tt1      3
      TT      tt2      3
      TT      tt3      4
      CDPA    cdp1     3
      CDPA    cdp2     3
      CDPA    cdp3     4
      AFTPC   end1     9
```

The output of this command shows the screens that make up the screen set. These screens can be examined by entering the gateway screening retrieve command corresponding to the value in the `NSFI` field and specifying the screening reference name shown in the `NSR/ACT` field. For this example, you enter these commands to examine the screens in the screen set.

```
rtrv-scr-opc:sr=opc1
rtrv-scr-blkdpc:sr=bkd2
rtrv-scr-cgpa:sr=cgp1
rtrv-scr-tt:sr=tt1
rtrv-scr-tt:sr=tt2
rtrv-scr-tt:sr=tt3
rtrv-scr-cdpa:sr=cdp1
rtrv-scr-cdpa:sr=cdp2
rtrv-scr-cdpa:sr=cdp3
rtrv-scr-aftpc:sr=end1
```

If the screen set that you wish to assign to the linkset is not in the database, go to the "Adding a Screen Set" procedure in the *Database Administration Manual - Gateway Screening* and add the screen set to the database.

5. Display the current linkset configuration of the linkset to be changed using the `rtrv-ls` command with the linkset name. For this example, enter these commands.

```
rtrv-ls:lsn=ls04
```

This is an example of the possible output.

```
r1ghncxa03w 05-09-17 11:43:04 GMT EAGLES 34.0.0
```

```

LSN          APCA  (SS7)  SCR2  L3T  SLT  BEI  LST  LNKS  ACT  MES  DIS  SLSCI  NIS
ls04        001-002-003  scr2  1    1    no   a    4    off  off  off  yes   off

          CLLI          TFATCABMLQ  MTPRSE  ASL8  IPGWAPC
ls04clli          2          no      no    no

          L2T          L1          PCR  PCR
          SET  BPS    MODE  TSET  ECM  N1  N2
LOC  LINK  SLC  TYPE  SET  BPS    MODE  TSET  ECM  N1  N2
1205  b    0    LIMDS0  1    56000  ---  ---  BASIC  ---  ---
1213  b    1    LIMOCU  1    56000  ---  ---  BASIC  ---  ---
1211  a    2    LIMDS0  1    56000  ---  ---  BASIC  ---  ---
1207  b    3    LIMV35  1    64000  DCE  OFF  BASIC  ---  ---

          LP          ATM
          SET  BPS    TSEL          VCI  VPI  LL
LOC  LINK  SLC  TYPE  SET  BPS    TSEL          VCI  VPI  LL

          LP          ATM          E1ATM
          SET  BPS    TSEL          VCI  VPI  CRC4  SI  SN
LOC  LINK  SLC  TYPE  SET  BPS    TSEL          VCI  VPI  CRC4  SI  SN

          IPLIML2
LOC  LINK  SLC  TYPE

          L2T          PCR  PCR  E1  E1
          SET  BPS    ECM  N1  N2  LOC  PORT  TS
LOC  LINK  SLC  TYPE  SET  BPS    ECM  N1  N2  LOC  PORT  TS

          L2T          PCR  PCR  T1  T1
          SET  BPS    ECM  N1  N2  LOC  PORT  TS
LOC  LINK  SLC  TYPE  SET  BPS    ECM  N1  N2  LOC  PORT  TS

```

```
Link set table is ( 24 of 1024) 2% full
```

SS7 Configuration

rtrv-ls:lsn=lsn5

This is an example of the possible output.

rlghncxa03w 05-09-17 11:43:04 GMT EAGLE5 34.0.0

LSN	APCN	(SS7)	SCRN	SET	SET	BEI	LST	LNKS	ACT	MES	DIS	SLSCI	NIS
lsn5	10685		scr3	1	1	no	a	3	on	off	off	---	on

CLLI	TFATCABMLQ	MTPRSE	ASL8	SLSOCBIT	SLSRSB	ITUTFR
lsn5clli	1	no	no	none	1	off

GSMSCRN
off

LOC	LINK	SLC	TYPE	L2T	BPS	L1	TSET	ECM	PCR	PCR
2105	b	0	LIMDS0	SET	56000	---	---	BASIC	---	---
2113	b	1	LIMOCU	SET	56000	---	---	BASIC	---	---
2111	a	2	LIMDS0	SET	56000	---	---	BASIC	---	---

LOC	LINK	SLC	TYPE	LP	BPS	ATM	TSEL	VCI	VPI	LL
				SET						

LOC	LINK	SLC	TYPE	LP	BPS	ATM	TSEL	VCI	VPI	CRC4	SI	SN
				SET								

LOC LINK SLC TYPE IPLIML2

LOC LINK SLC TYPE

LOC	LINK	SLC	TYPE	L2T	BPS	ECM	PCR	PCR	E1	E1
				SET			N1	N2	LOC	PORT TS

LOC	LINK	SLC	TYPE	L2T	BPS	ECM	PCR	PCR	T1	T1
				SET			N1	N2	LOC	PORT TS

Link set table is (24 of 1024) 2% full

NOTE: If the **mtpmse=yes** parameter is not being specified for the linkset, skip steps 6 through 11, and go to step 12.

- If you wish to use either the ANSI MTP restart feature or the ITU MTP restart feature, enter the **rtrv-feat** command to verify that either of these features are on. The entry **MTPRS = on** in the **rtrv-feat** command output shows that the ANSI MTP restart feature is on. The entry **ITUMTPRS = on** in the **rtrv-feat** command output shows that the ITU MTP restart feature is on. In this example, both features are off.

NOTE: The **rtrv-feat** command output contains other fields that are not used by this procedure. If you wish to see all the fields displayed by the **rtrv-feat** command, see the **rtrv-feat** command description in the *Commands Manual*.

If both the ANSI and ITU MTP restart feature are on, skip steps 7 and 8 and go to step 9.

NOTE: If you are not going to turn the ANSI MTP restart feature on, or if the output of the `rtrv-feat` command in step 6 shows that the ANSI MTP restart feature is on (shown by the `MPTRS = on` entry), skip this step and go to step 8.

7. Turn the ANSI MTP restart feature on by entering this command.

```
chg-feat:mtprs=on
```

NOTE: Once the ANSI MTP restart feature is turned on with the `chg-feat` command, it cannot be turned off.

The ANSI MTP restart feature must be purchased before you turn the feature on with the `chg-feat` command. If you are not sure if you have purchased the ANSI MTP restart feature, contact your Tekelec Sales Representative or Account Representative.

When this command has successfully completed, this message should appear.

```
rlghncxa03w 05-09-10 11:43:04 GMT EAGLE5 34.0.0
CHG-FEAT: MASP A - COMPLTD
```

NOTE: If you are not going to turn the ITU MTP restart feature on, or if the output of the `rtrv-feat` command in step 6 shows that the ITU MTP restart feature is on (shown by the `ITUMPTRS = on` entry), skip this step and go to step 9.

8. Turn the ITU MTP restart feature on by entering this command.

```
chg-feat:itumtprs=on
```

NOTE: Once the ITU MTP restart feature is turned on with the `chg-feat` command, it cannot be turned off.

The ITU MTP restart feature must be purchased before you turn the feature on with the `chg-feat` command. If you are not sure if you have purchased the ITU MTP restart feature, contact your Tekelec Sales Representative or Account Representative.

When this command has successfully completed, this message should appear.

```
rlghncxa03w 05-09-10 11:43:04 GMT EAGLE5 34.0.0
CHG-FEAT: MASP A - COMPLTD
```

9. Enter the `rtrv-stpopts` command to display the value of the `mtprsi` and `mtprsit` parameters of the `chg-stpopts` command.

The `mtprsi` parameter either enables (`mtprsi=yes`) or disables (`mtprsi=no`) the MTP restart process on the EAGLE 5 SAS.

The `mtprsit` parameter (the MTP restart isolation timer) specifies the minimum amount of time that the EAGLE 5 SAS is isolated before the MTP restart process is started. The value of the `mtprsit` parameter is from 2 to 900 seconds, with a system default value of 5 seconds.

The value of the `mtprsi` parameter is shown in the `MTPRSI` field of the `rtrv-stpopts` command output. The value of the `mtprsit` parameter is shown in the `MTPRSIT` field of the `rtrv-stpopts` command output, and is shown in milliseconds.

This is an example of the possible output.

```
rlghncxa03w 05-09-17 16:02:05 GMT EAGLE5 34.0.0
STP OPTIONS
-----
MTPRSI          no
MTPRSIT         5000
```

NOTE: The `rtrv-stpopts` command output contains other fields that are not used by this procedure. If you wish to see all the fields displayed by the `rtrv-stpopts` command, see the `rtrv-stpopts` command description in the *Commands Manual*.

To change the value of the `MTPRSI` or the `MTPRSIT` fields, go to step 10. Otherwise, skip steps 10 and 11, and go to step 12.

10. Enable the MTP restart process on the EAGLE 5 SAS by changing the value of the `MTPRSI` field of the `rtrv-stpopts` command output. Enter the `chg-stpopts` command with the `mtprsi` parameter.

```
chg-stpopts:mtprsi=yes
```

If you wish to change the value of the MTP restart isolation timer, enter `chg-stpopts` command with the `mtprsit` parameter.

```
chg-stpopts:mtprsit=7500
```

If you wish to change the value of the MTP restart isolation timer and enable the MTP restart process, enter `chg-stpopts` command with both the `mtprsi=yes` and `mtprsit` parameters.

```
chg-stpopts:mtprsi=yes:mtprsit=7500
```

For this example, the MTP restart process is enabled and the value of the MTP restart isolation timer is changed.

When the `chg-stpopts` command has successfully completed, this message should appear.

```
rlghncxa03w 05-09-07 00:22:57 GMT EAGLE5 34.0.0
CHG-STPOPTS: MASP A - COMPLTD
```

11. Verify the changes using the `rtrv-stpopts` command. This is an example of the possible output.

```
rlghncxa03w 05-09-17 16:02:05 GMT EAGLE5 34.0.0
STP OPTIONS
-----
MTPRSI                yes
MTPRSIT               7500
```

NOTE: The `rtrv-stpopts` command output contains other fields that are not used by this procedure. If you wish to see all the fields displayed by the `rtrv-stpopts` command, see the `rtrv-stpopts` command description in the *Commands Manual*.

NOTE: If the `slsci` or `as18` parameters are not being specified for the linkset, skip steps 12 through 14, and go to step 15. The `slsci` and `as18` parameters can be specified only for linksets with ANSI APCs.

NOTE: If the `rtrv-stpopts` command was performed in steps 9 and 11, skip this step and go to step 13.

12. Display the existing value for the `slscnv` parameter by entering the `rtrv-stpopts` command. The value for the `slscnv` parameter is shown in the `SLSCNV` field. This is an example of the possible output.

```
rlghncxa03w 05-09-17 16:02:05 GMT EAGLE5 34.0.0
STP OPTIONS
-----
SLSCNV                on
```

NOTE: The `rtrv-stpopts` command output contains other fields that are not used by this procedure. If you wish to see all the fields displayed by the `rtrv-stpopts` command, see the `rtrv-stpopts` command description in the *Commands Manual*.

13. Change the `slscnv` parameter. For this example, the value of the `slscnv` parameter is being changed from `on` to `perls`. Enter this command.

```
chg-stpopts:slscnv=perls
```

When this command has successfully completed, this message should appear.

```
rlghncxa03w 05-09-07 00:22:57 GMT EAGLE5 34.0.0
CHG-STPOPTS: MASP A - COMPLTD
```

14. Verify the changes using the `rtrv-stpopts` command. This is an example of the possible output.

```
rlghncxa03w 05-09-17 16:02:05 GMT EAGLE5 34.0.0
STP OPTIONS
-----
SLSCNV                perls
```

NOTE: The `rtrv-stpopts` command output contains other fields that are not used by this procedure. If you wish to see all the fields displayed by the `rtrv-stpopts` command, see the `rtrv-stpopts` command description in the *Commands Manual*.

NOTE: If the `s1sobit` parameter is not being specified for the linkset, skip steps 15 and 16, and go to step 17. The `s1sobit` parameter can be specified only for linksets with either ITU-I or ITU-N APCs (either 14-bit or 24-bit ITU-N APCs).

NOTE: If the `rtrv-feat` command was performed in step 6, skip this step and go to step 16.

15. To use the `s1sobit` parameter with either the `chg-ls` command, the Use of the Other CIC Bit feature must be on. Enter the `rtrv-feat` command to verify that either of this feature is on. The entry `SLSOCB = on` in the `rtrv-feat` command output shows that this feature is on. In this example, the Use of the Other CIC Bit feature is off.

NOTE: The `rtrv-feat` command output contains other fields that are not used by this procedure. If you wish to see all the fields displayed by the `rtrv-feat` command, see the `rtrv-feat` command description in the *Commands Manual*.

NOTE: If the Use of the Other CIC Bit feature is on (`SLSOCB = on`), skip this step and go to step 17.

16. Turn the Use of the Other CIC Bit feature is on feature on by entering this command.

```
chg-feat:s1sob=on
```

NOTE: Once the Use of the Other CIC Bit feature is turned on with the `chg-feat` command, it cannot be turned off.

The Use of the Other CIC Bit feature must be purchased before you turn the feature on with the `chg-feat` command. If you are not sure if you have purchased the Use of the Other CIC Bit feature, contact your Tekelec Sales Representative or Account Representative.

When this command has successfully completed, this message should appear.

```
rlghncxa03w 05-09-10 11:43:04 GMT EAGLE5 34.0.0  
CHG-FEAT: MASP A - COMPLTD
```

NOTE: If the `multgc` parameter is not being specified for the linkset, skip steps 17, 18, 19, and 20, and go to step 21. If the `multgc` parameter value is being changed to `no`, skip steps 17, and 18, and go to step 19. The `multgc` parameter can be specified only for linksets with either ITU-I or 14-bit ITU-N APCs, and linksets that contain signaling links running the IPLIMI application.

NOTE: If the `rtrv-feat` command was performed in steps 6 or 15, skip this step and go to step 18.

17. To specify the `multgc=yes` parameter with the `chg-ls` command, the ITU Duplicate Point Code feature must be on. For the ITU Duplicate Point Code feature to be on, the Multiple Point Code feature must be on. Enter the `rtrv-feat` command to verify that either of these features are on. The entry `MPC = on` in the `rtrv-feat` command output shows that the Multiple Point Code feature is on. The entry `ITUDUPPC = on` in the `rtrv-feat` command output shows that the ITU Duplicate Point Code feature is on. In this example, both features are off.

NOTE: The `rtrv-feat` command output contains other fields that are not used by this procedure. If you wish to see all the fields displayed by the `rtrv-feat` command, see the `rtrv-feat` command description in the *Commands Manual*.

NOTE: If the ITU Duplicate Point Code feature is on (`ITUDUPPC = on`), skip this step and go to step 19.

18. Turn the ITU Duplicate Point Code feature on, and the Multiple Point Code feature if necessary, by entering one of these commands.

To turn the ITU Duplicate Point Code feature on only.

```
chg-feat:ituduppc=on
```

To turn both the ITU Duplicate Point Code and Multiple Point Code features on.

```
chg-feat:mpc=on:ituduppc=on
```

NOTE: Once the ITU Duplicate Point Code and Multiple Point Code features are turned on with the `chg-feat` command, they cannot be turned off.

The ITU Duplicate Point Code and Multiple Point Code features must be purchased before you turn either of these features on with the `chg-feat` command. If you are not sure if you have purchased these features, contact your Tekelec Sales Representative or Account Representative.

When this command has successfully completed, this message should appear.

```
rlghncxa03w 05-09-10 11:43:04 GMT EAGLE5 34.0.0
CHG-FEAT: MASP A - COMPLTD
```

NOTE: If the `multgc` parameter value is not being changed, or is being changed to `yes`, skip steps 19 and 20, and go to step 21.

19. If the `multgc` parameter value is changed to `no`, the linkset can contain only one secondary adjacent point code. An ITU international linkset can contain only one 14-bit ITU national secondary adjacent point code. If the ITU international linkset contains more than one 14-bit ITU national secondary adjacent point code, all but one of these 14-bit ITU national secondary adjacent point codes must be removed from the linkset. An ITU national linkset can contain only one ITU international secondary adjacent point code. All 14-bit ITU-N secondary adjacent point codes must be removed from the linkset. All routes to these secondary adjacent point codes must be removed from the database before the secondary adjacent point codes can be removed.

Display the routes using the secondary adjacent point code being removed from the linkset with the `rtrv-rte` command, specifying the secondary adjacent point code being removed as the value of the `dpc` parameter.

For this example, enter these commands.

```
rtrv-rte:dpcn=11213-de
```

This is an example of the possible output.

```
rlghncxa03w 05-09-07 11:43:04 GMT EAGLE5 34.0.0

DPCN          ALIASA          ALIASI  LSN          RC    APC
11213-de      -----          -----  lsn3         10    11213-de
                                           CLLI=-----
```

```
rtrv-rte:dpcn=12114-fr
```

This is an example of the possible output.

```
rlghncxa03w 05-09-07 11:43:04 GMT EAGLE5 34.0.0

DPCN          ALIASA          ALIASI  LSN          RC    APC
12114-fr      -----          -----  lsn3         10    12114-fr
                                           CLLI=-----
```

```
rtrv-rte:dpcn=12115-uk
```

This is an example of the possible output.

```
rlghncxa03w 05-09-07 11:43:04 GMT EAGLE5 34.0.0

DPCN          ALIASA          ALIASI  LSN          RC    APC
12115-uk      -----          -----  lsn3         10    12115-uk
                                           CLLI=-----
```

If the secondary adjacent point code is assigned to a route, that route must be removed from the database. Go to the "Removing a Route" procedure on page 3-189 to remove the route from the database.

20. Remove the secondary adjacent point codes specified in step 19 from the linkset with the `chg-ls` command with the `sapcn` and the `action=delete` parameters. For this example, enter these commands.

```
chg-ls:lsn=lsn3:sapcn=11213-de:action=delete
chg-ls:lsn=lsn3:sapcn=12114-fr:action=delete
chg-ls:lsn=lsn3:sapcn=12115-uk:action=delete
```

When the `chg-ls` command has successfully completed, this message should appear.

```
rlghncxa03w 05-09-17 16:23:21 GMT EAGLE5 34.0.0
Link set table is ( 13 of 255) 5% full
CHG-LS: MASP A - COMPLTD
```

NOTE: If the linkset type of the linkset (shown in the `LST` column in the `rtrv-ls` output) is `C`, or will be changed to `C` in this procedure, the linkset's `tfatcabmlq` parameter value can be changed only if the `LSRESTRICT` SS7 option is `ON`. If the linkset's `tfatcabmlq` parameter value is not being changed, or if the linkset type will be changed to or will remain (if unchanged) `A`, `B`, `D`, or `E`, skip steps 21 and 22, and go to step 23.

21. Display the existing value for the `lsrestrict` parameter by entering the `rtrv-ss7opts` command. This is an example of the possible output.

```
rlghncxa03w 05-09-17 16:02:05 GMT EAGLE5 34.0.0

SS7 OPTIONS
-----
LSRESTRICT          off
```

NOTE: The `rtrv-ss7opts` command output contains other fields that are not used by this procedure. If you wish to see all the fields displayed by the `rtrv-ss7opts` command, see the `rtrv-ss7opts` command description in the *Commands Manual*.

NOTE: If the `lsrestrict` parameter value shown in step 21 is `on`, skip this step and go to step 23.

22. Change the value of the `lsrestrict` parameter to `on` by entering this command.

```
chg-ss7opts:lsrestrict=on
```

When this command has successfully completed, this message should appear.

```
rlghncxa03w 05-09-07 00:22:57 GMT EAGLE5 34.0.0
CHG-SS7OPTS: MASP A - COMPLTD
```



CAUTION: Turning the `lsrestrict` option on changes the way the EAGLE 5 SAS routes messages by using the state of the route along with the cost of the route to determine the preferred route to use. With this option on, the preferred route is not the absolute lowest cost available route in the routeset. A route is considered available if its status is either `Allowed` or `Restricted`. If the state of the absolute lowest cost route in the routeset is `Restricted`, the preferred route is the lowest cost route in the

routeset whose status is Allowed. Make sure that you wish to have the EAGLE 5 SAS route messages in this manner before turning the `lsrestrict` option on.

23. Deactivate the signaling links in the linkset using the `dact-slk` command. For this example, enter these commands.

```
dact-slk:loc=1205:link=b
dact-slk:loc=1207:link=b
dact-slk:loc=1211:link=a
dact-slk:loc=1213:link=b
dact-slk:loc=2105:link=b
dact-slk:loc=2111:link=a
dact-slk:loc=2113:link=b
```

When each of these commands have successfully completed, this message should appear.

```
rlghncxa03w 05-09-07 08:41:12 GMT EAGLE5 34.0.0
Deactivate Link message sent to card
```

24. Change the linkset configuration using the `chg-ls` command and following these rules:

- The linkset being changed must be in the database – the linkset configuration is shown in the output of step 1.
- The new APC of the linkset must be in the destination point code table, but cannot be either the EAGLE 5 SAS's point code or the EAGLE 5 SAS's capability point code – shown in the outputs of steps 2 and 3.
- If a gateway screening screen set is specified for the linkset, the gateway screening screen set must be in the database – shown in the output of step 4.
- The `gwsa`, `gwsn`, and `gwsd` parameters can be specified only if the `scrn` parameter is specified.



CAUTION: When Gateway Screening is in the screen test mode, as defined by the linkset parameters `gwsa=off` and `gwsn=on`, the gateway screening action in the gateway screening stop action set specified by the `actname` parameter of the gateway screening screen set at the end of the gateway screening process will be performed.

- The `gwsd=on` parameter can be specified only with the `gwsa=on` parameter.
- See Table 3-4 on page 3-27 for the combinations of the `as18` and `s1sci` parameters, and the `s1scnv` STP option, and the results that these combinations produce. The `as18` and `s1sci` parameters can be specified only for linksets with ANSI APCs.

- The **nis=on** parameter cannot be specified for linksets with ITU-I adjacent point codes.
- The **mtpmse=yes** parameter cannot be specified if the linkset contain signaling links with the **iplim12** parameter assigned.
- The **multgc=yes** parameter can be specified only for linksets with either ITU-I or 14-bit ITU-N APCs, and linksets that contain signaling links running the IPLIMI application.
- The **itutfr=on** parameter can be specified only for linksets with ITU-N APCs (either 14-bit or 24-bit ITU-N APCs).
- If the **lst=c** parameter is specified, or if the current (unchanged) **LST** value is **C**, the **tfatcabmlq** parameter cannot be specified unless the **LSRESTRICT** SS7 option is **on**.
- The value of the **tfatcabmlq** parameter cannot exceed the number of signaling links assigned to the linkset.
- The **apcntype** parameter can be used only with 14-bit ITU-N or 24-bit ITU-N adjacent point codes.

For this example, enter these commands.

```
chg-ls:lsn=ls04:apca=240-070-000:scrn=scr7:gwsa=on:nis=on
```

```
chg-ls:lsn=lsn5:apca=10685:itutfr=on
```

When each of these commands has successfully completed, this message should appear.

```
rlghncxa03w 05-09-07 08:38:45 GMT EAGLE5 34.0.0
Link set table is ( 24 of 1024) 2% full
CHG-LS: MASP A - COMPLTD
```

25. Verify the changes using the **rtrv-ls** command, specifying the linkset name that was changed in step 24. For this example, enter this command.

```
rtrv-ls:lsn=ls04
```

This is an example of the possible output.

```
rlghncxa03w 05-09-17 11:43:04 GMT EAGLE5 34.0.0
```

LSN	APCA	(SS7)	SCRN	L3T SLT				LNKS	ACT	MES	DIS	SLSCI	NIS
				SET	SET	BEI	LST						
ls04	240-070-000		scr7	1	1	no	a	4	on	off	off	yes	on

CLLI	TFATCABMLQ	MTPRSE	ASL8	IPGWAPC

LOC	LINK	SLC	TYPE	L2T		L1		ECM	PCR	
				SET	BPS	MODE	TSET		N1	N2
1205	b	0	LIMDS0	1	56000	---	---	BASIC	---	-----
1213	b	1	LIMOCU	1	56000	---	---	BASIC	---	-----
1211	a	2	LIMDS0	1	56000	---	---	BASIC	---	-----
1207	b	3	LIMV35	1	64000	DCE	OFF	BASIC	---	-----

SS7 Configuration

```

LOC LINK SLC TYPE LP ATM
SET BPS TSEL VCI VPI LL

LOC LINK SLC TYPE LP ATM E1ATM
SET BPS TSEL VCI VPI CRC4 SI SN

LOC LINK SLC TYPE IPLIML2

LOC LINK SLC TYPE

LOC LINK SLC TYPE L2T PCR PCR E1 E1
SET BPS ECM N1 N2 LOC PORT TS

LOC LINK SLC TYPE L2T PCR PCR T1 T1
SET BPS ECM N1 N2 LOC PORT TS

```

Link set table is (24 of 1024) 2% full

rtrv-ls:lsn=lsn5

This is an example of the possible output.

rlghncxa03w 05-09-17 11:43:04 GMT EAGLE5 34.0.0

```

LSN APCN (SS7) L3T SLT GWS GWS GWS
scr3 1 1 no a 3 on off off --- on
lsn5 10685 scr3 1 1 no a 3 on off off --- on

CLLI TFATCABMLQ MTPRSE ASL8 SLSOCBIT SLSRSB ITUTFR
lsn5clli 1 no no none 1 on

GMSSCRN
off

```

```

LOC LINK SLC TYPE L2T L1 PCR PCR
SET BPS MODE TSET ECM N1 N2
2105 b 0 LIMDS0 1 56000 --- --- BASIC --- -----
2113 b 1 LIMOCU 1 56000 --- --- BASIC --- -----
2111 a 2 LIMDS0 1 56000 --- --- BASIC --- -----

LOC LINK SLC TYPE LP ATM
SET BPS TSEL VCI VPI LL

LOC LINK SLC TYPE LP ATM E1ATM
SET BPS TSEL VCI VPI CRC4 SI SN

LOC LINK SLC TYPE IPLIML2

LOC LINK SLC TYPE

LOC LINK SLC TYPE L2T PCR PCR E1 E1
SET BPS ECM N1 N2 LOC PORT TS

LOC LINK SLC TYPE L2T PCR PCR T1 T1
SET BPS ECM N1 N2 LOC PORT TS

```

Link set table is (24 of 1024) 2% full

26. Activate the signaling links that were deactivated in step 23 using the **act-slk** command. For this example, enter these commands.

```
act-slk:loc=1205:link=b
```

```
act-slk:loc=1207:link=b
```

```
act-slk:loc=1211:link=a
```

```
act-slk:loc=1213:link=b
```

```
act-slk:loc=2105:link=b
```

```
act-slk:loc=2111:link=a
```

```
act-slk:loc=2113:link=b
```

When each of these commands have successfully completed, this message should appear.

```
rlghncxa03w 05-09-07 08:41:12 GMT EAGLE5 34.0.0  
Activate Link message sent to card
```

27. Back up the new changes using the **chg-db:action=backup:dest=fixed** command. These messages should appear, the active Maintenance and Administration Subsystem Processor (MASP) appears first.

```
BACKUP (FIXED) : MASP A - Backup starts on active MASP.
```

```
BACKUP (FIXED) : MASP A - Backup on active MASP to fixed disk complete.
```

```
BACKUP (FIXED) : MASP A - Backup starts on standby MASP.
```

```
BACKUP (FIXED) : MASP A - Backup on standby MASP to fixed disk complete.
```

Flowchart 3-4. Changing an SS7 Linkset (Sheet 1 of 14)

NOTE: Note: This procedure can require that these features are enabled: ANSI MTP Restart, ITU MTP Restart, ITU National Duplicate Point Code, Multiple Point Code, and ITU SLS Enhancement. Before executing this procedure, make sure you have purchased the features you plan to enable. If you are not sure if you have purchased these features, contact your Tekelec Sales Representative or Account Representative.

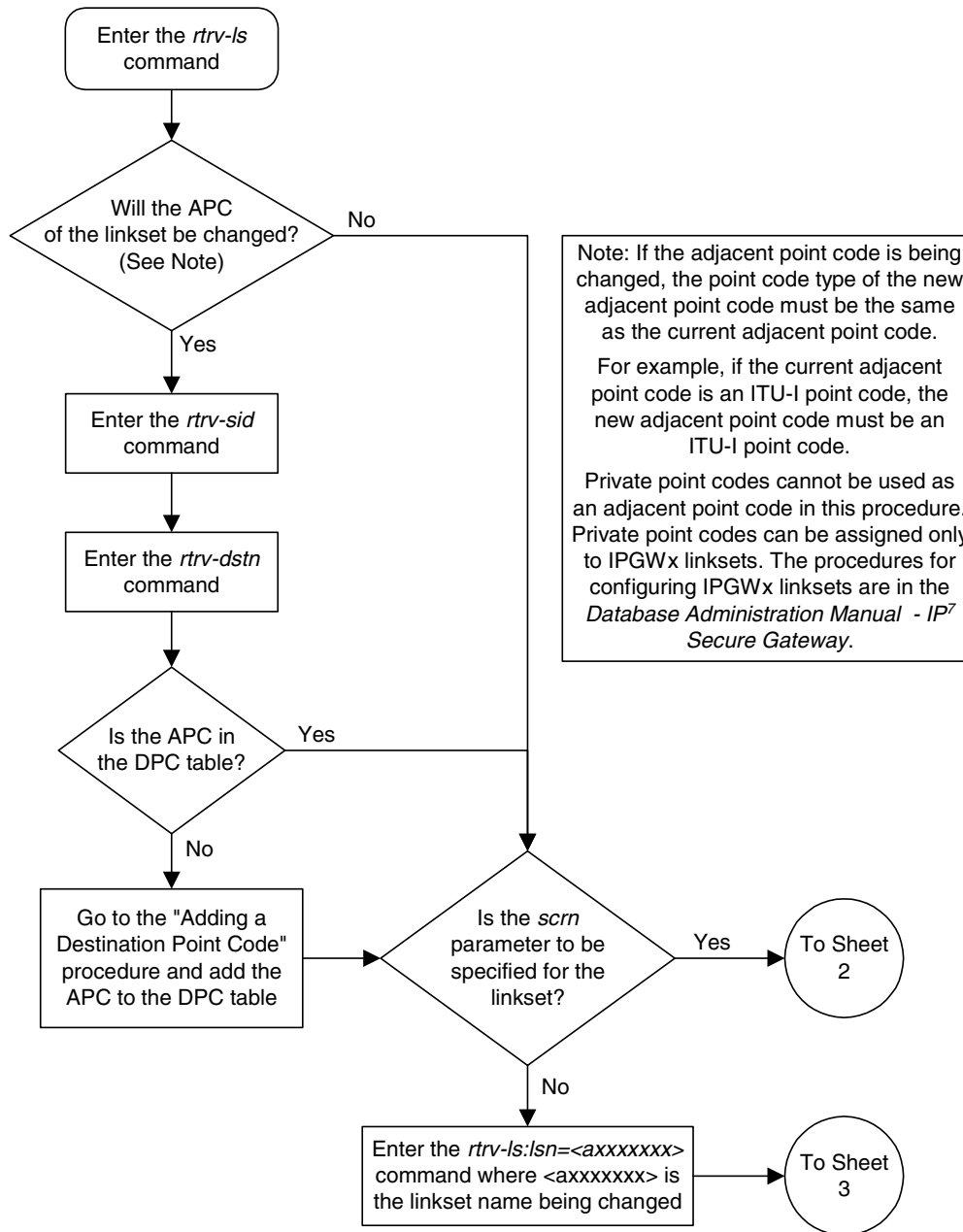

Flowchart 3-4. Changing an SS7 Linkset (Sheet 2 of 14)

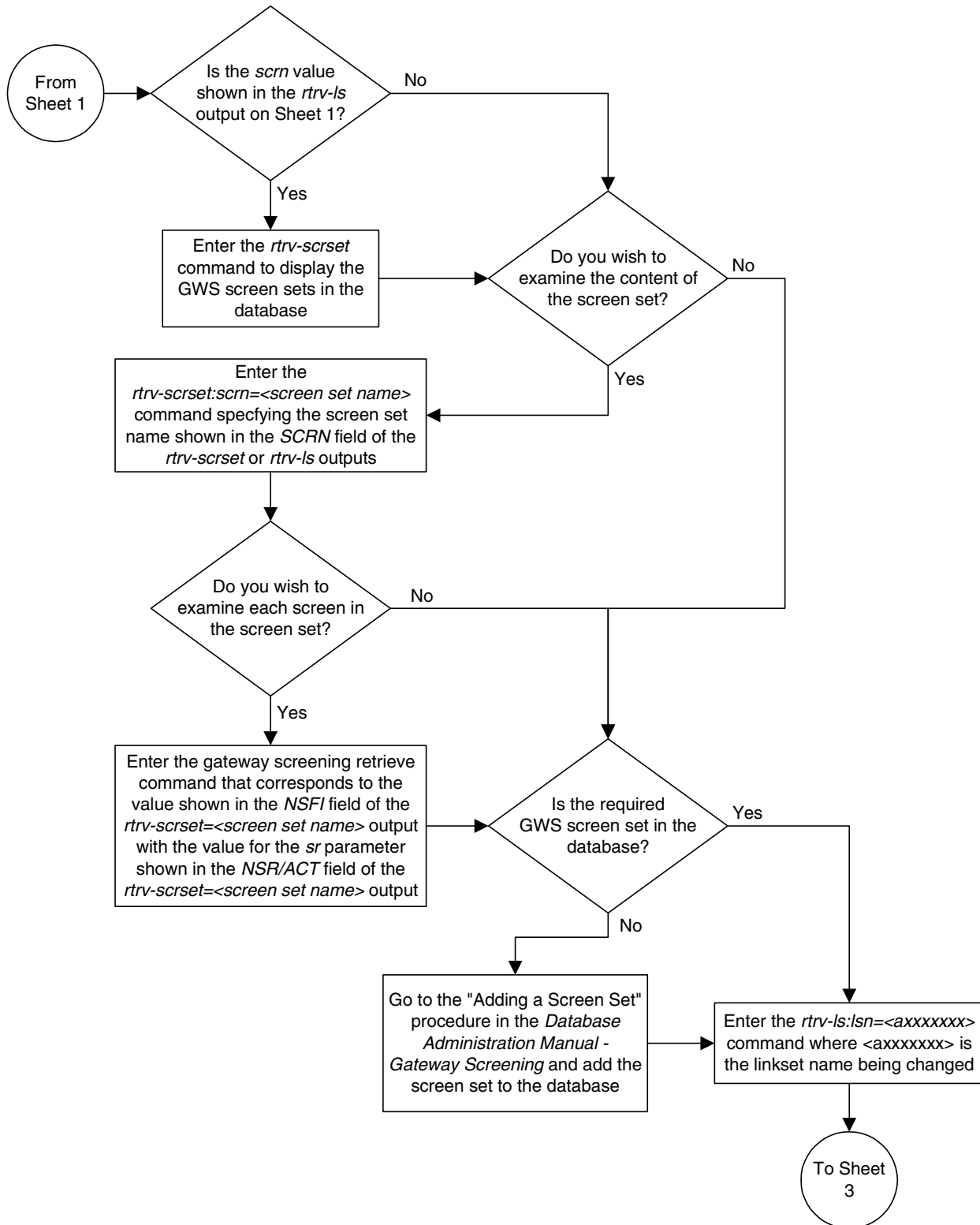

Flowchart 3-4. Changing an SS7 Linkset (Sheet 3 of 14)

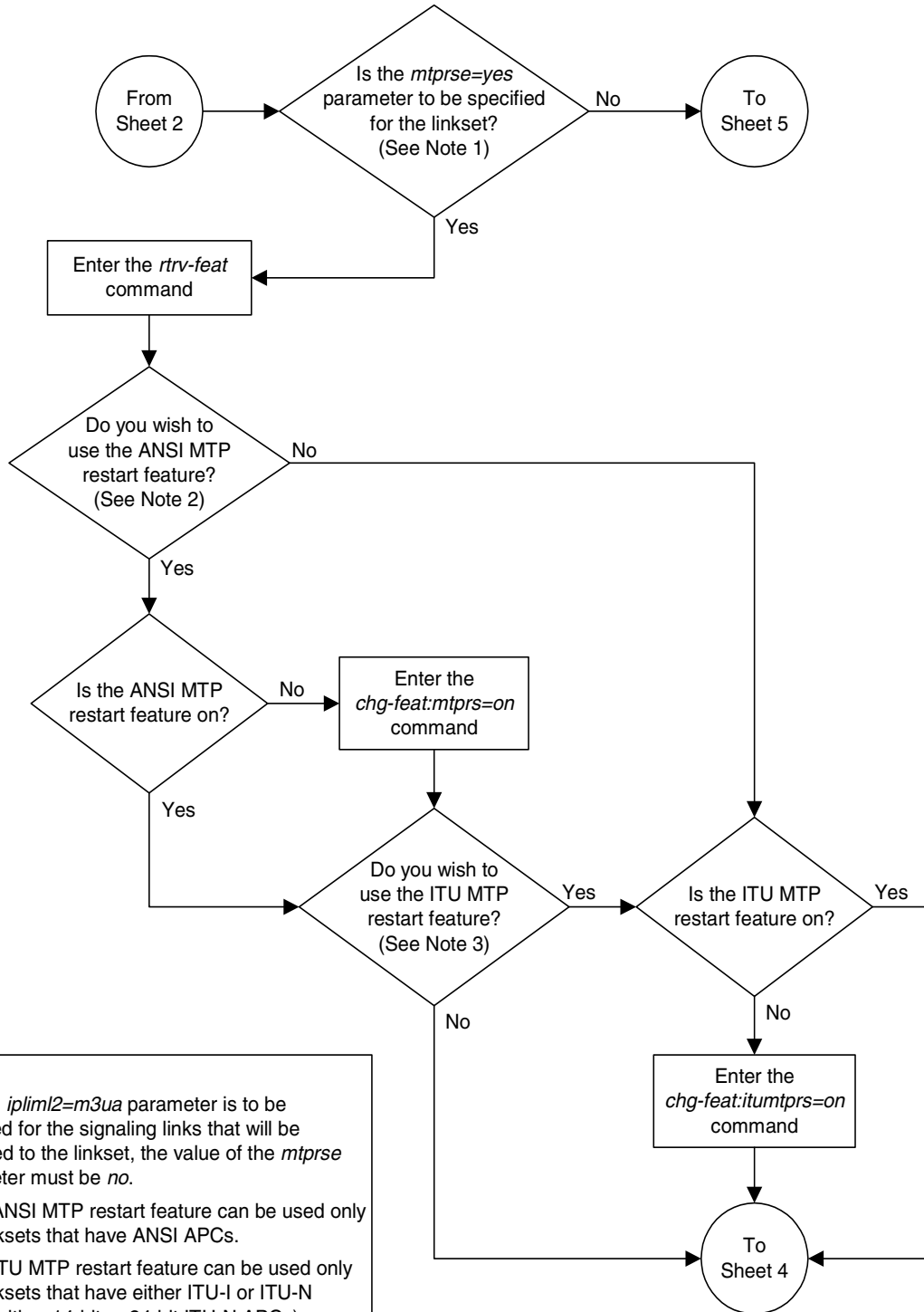

Notes:

1. If the *iplim2=m3ua* parameter is to be specified for the signaling links that will be assigned to the linkset, the value of the *mtrse* parameter must be *no*.
2. The ANSI MTP restart feature can be used only with linksets that have ANSI APCs.
3. The ITU MTP restart feature can be used only with linksets that have either ITU-I or ITU-N APCs (either 14-bit or 24-bit ITU-N APCs).

Flowchart 3-4. Changing an SS7 Linkset (Sheet 4 of 14)

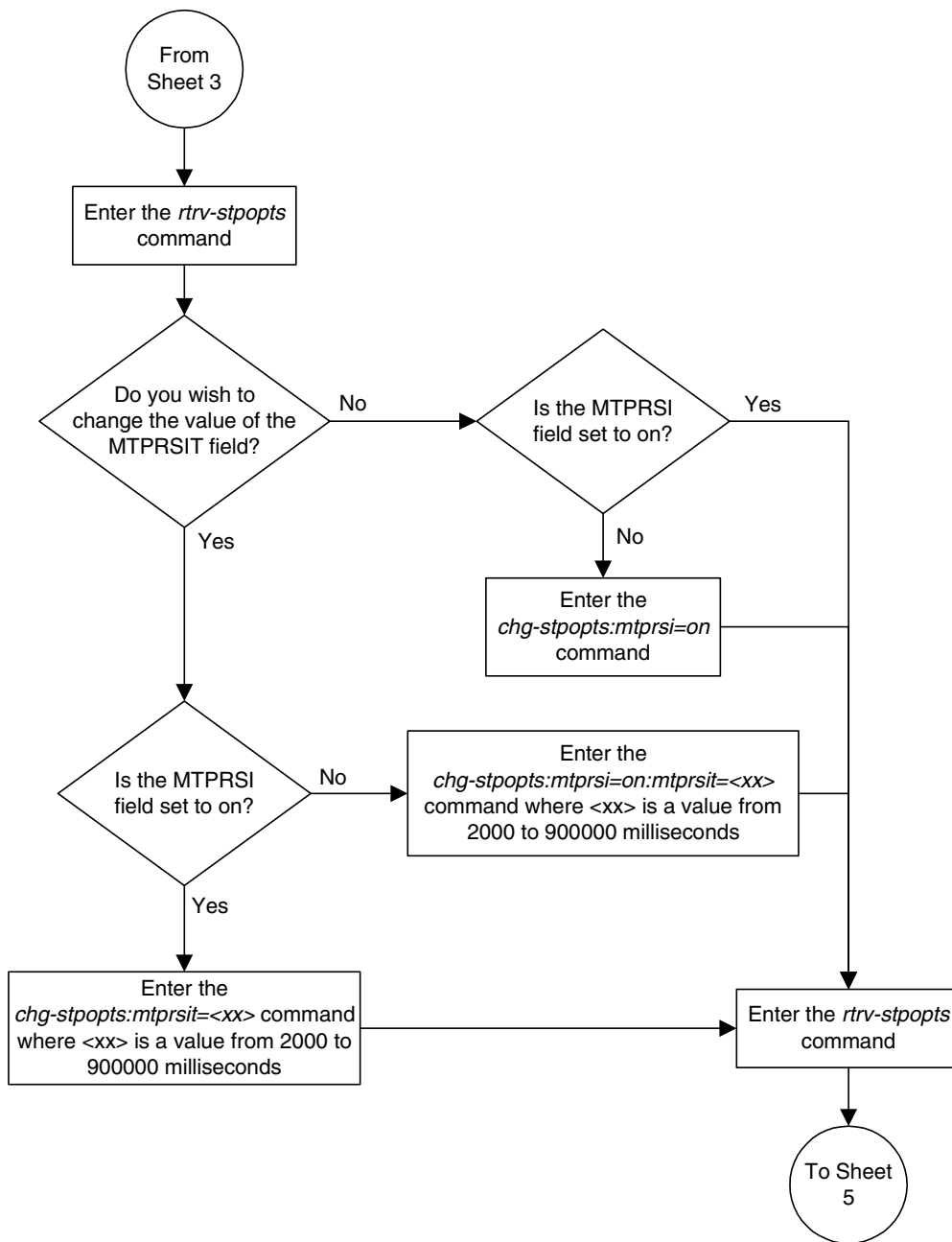

Flowchart 3-4. Changing an SS7 Linkset (Sheet 5 of 14)

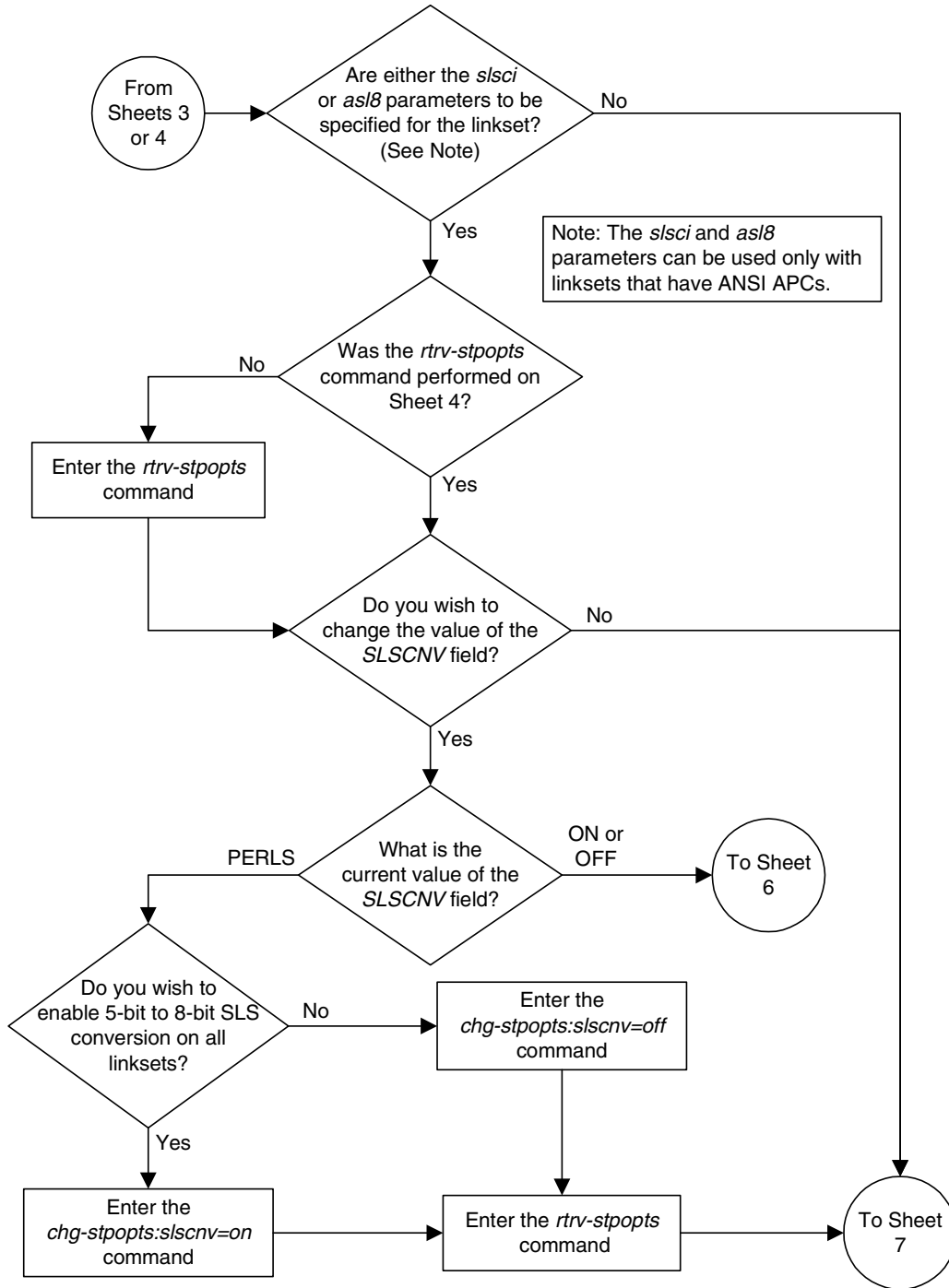

Flowchart 3-4. Changing an SS7 Linkset (Sheet 6 of 14)

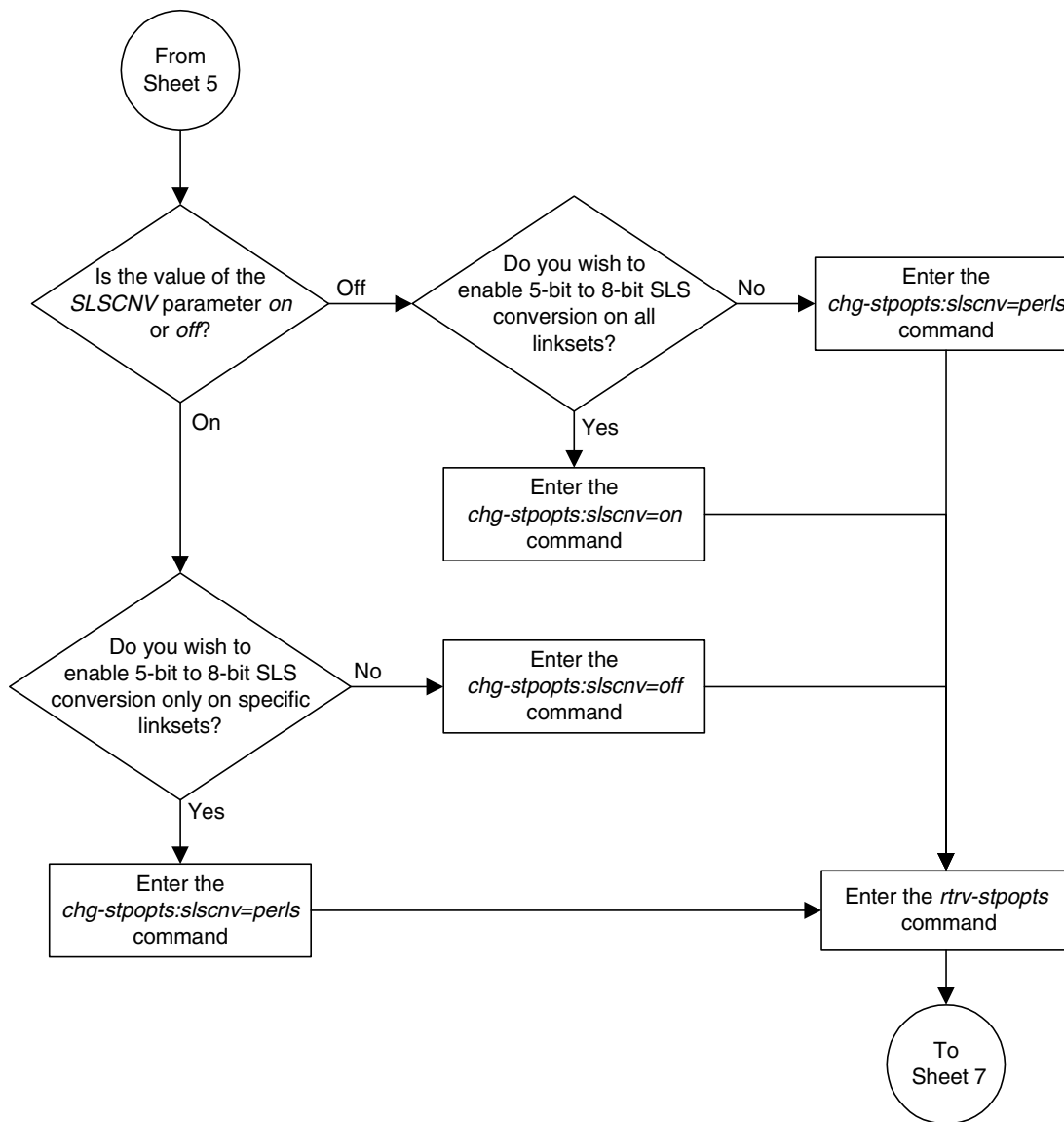

Flowchart 3-4. Changing an SS7 Linkset (Sheet 7 of 14)

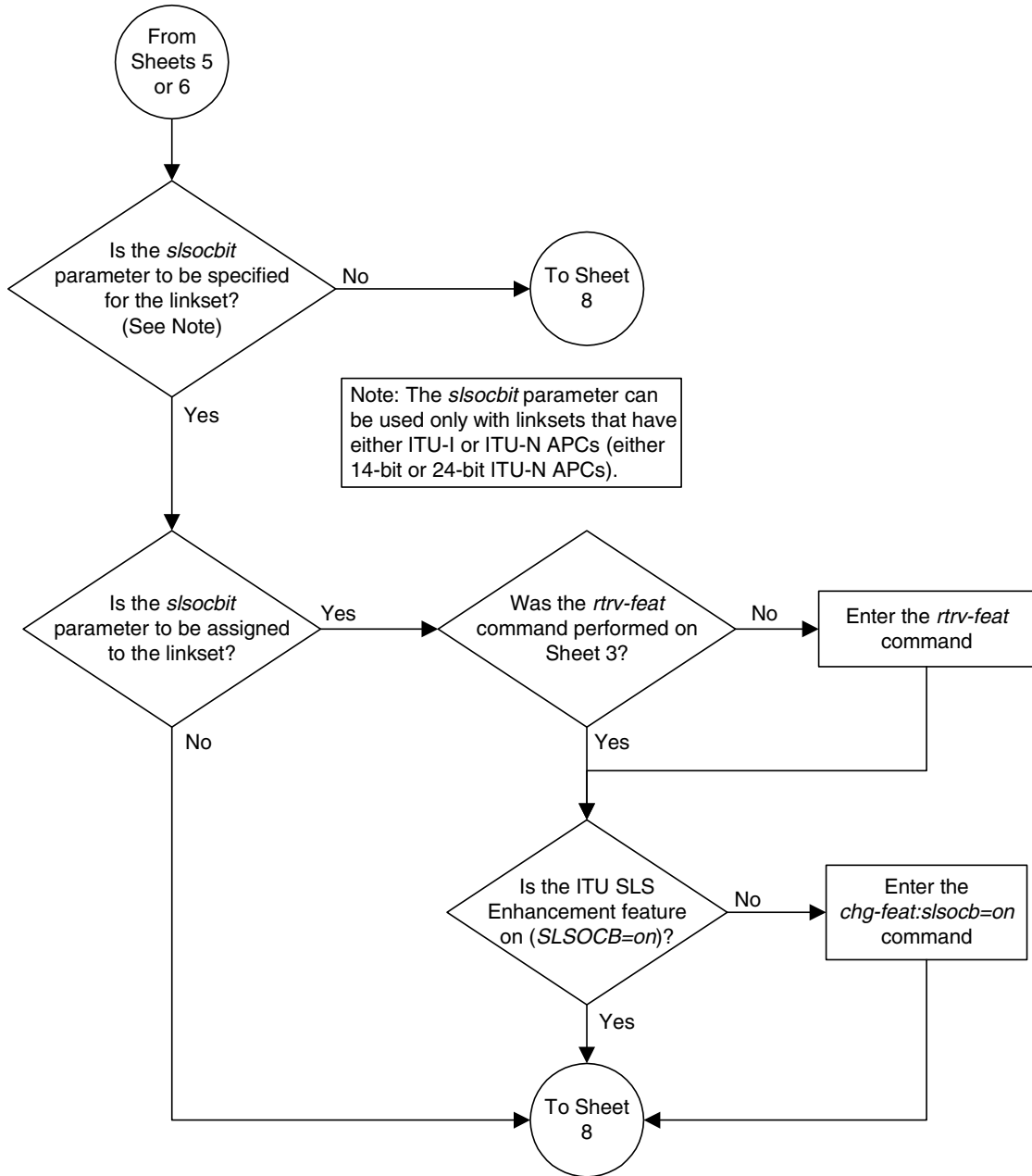

Flowchart 3-4. Changing an SS7 Linkset (Sheet 8 of 14)

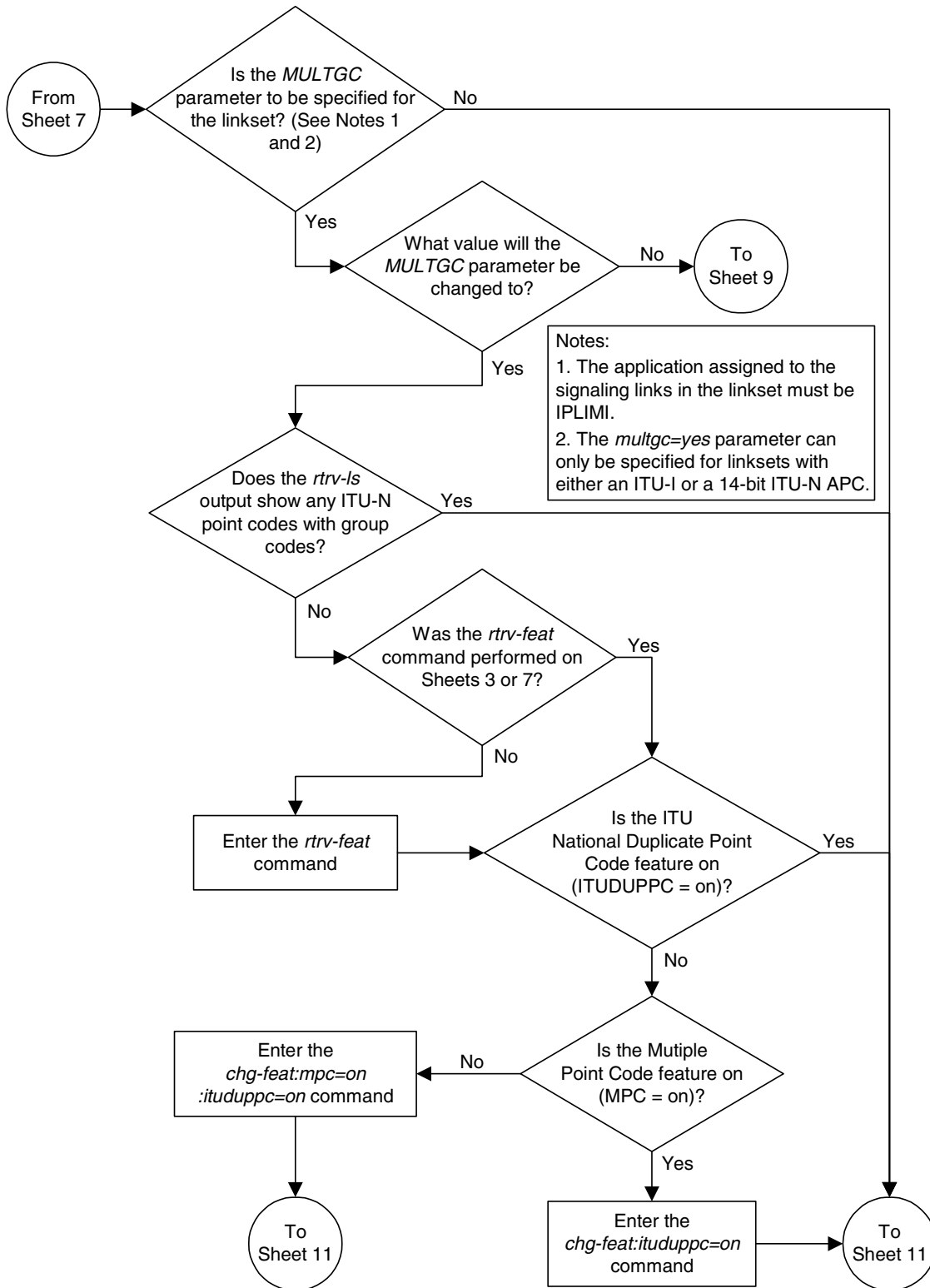

Flowchart 3-4. Changing an SS7 Linkset (Sheet 9 of 14)

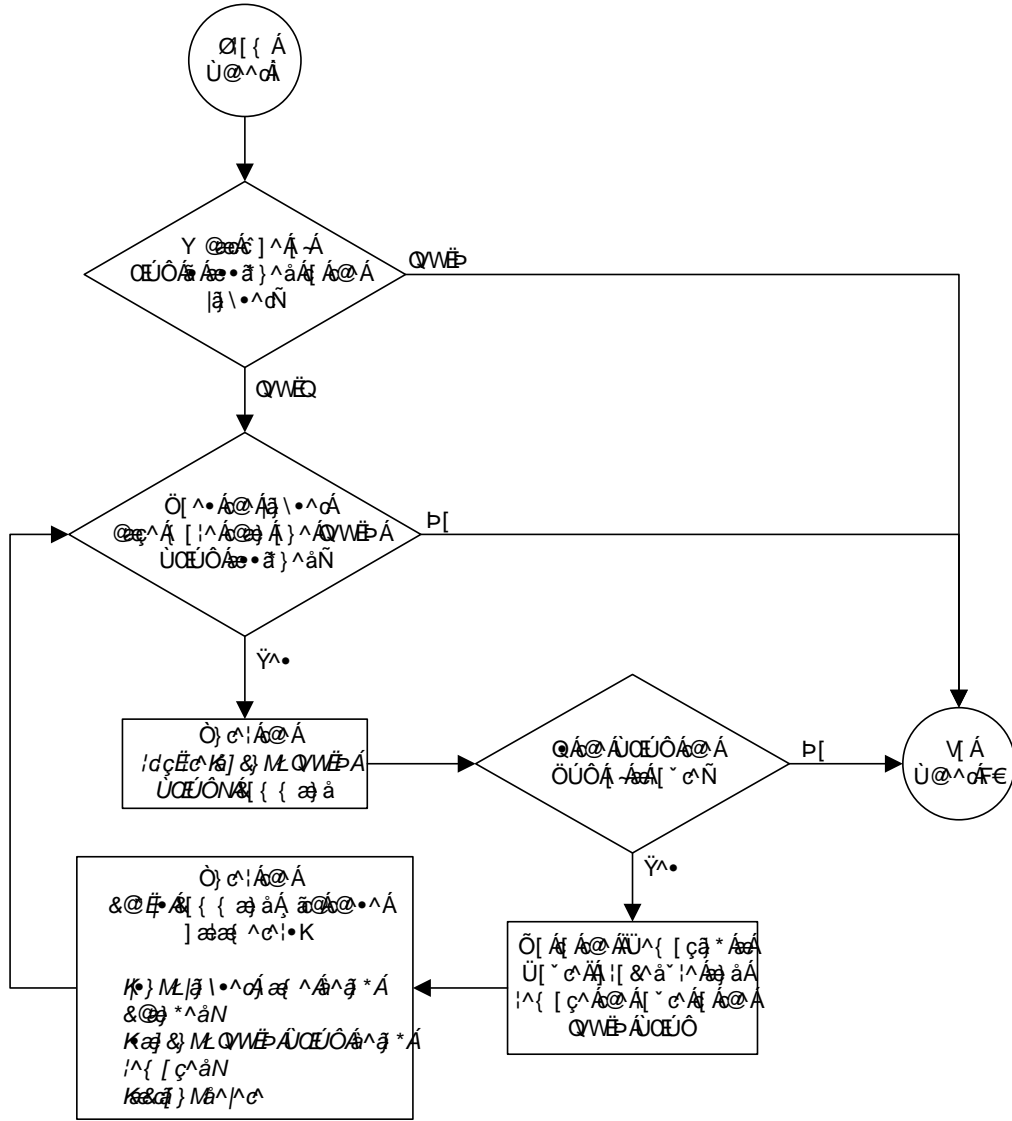

Flowchart 3-4. Changing an SS7 Linkset (Sheet 10 of 14)

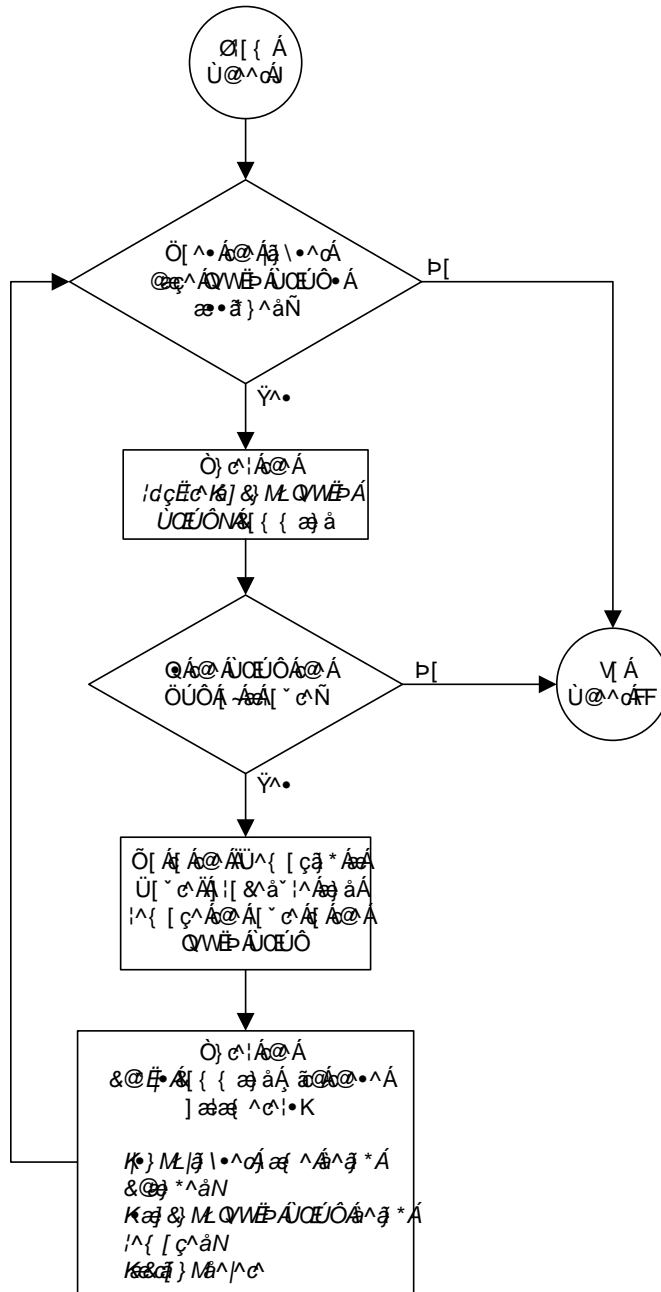

Flowchart 3-4. Changing an SS7 Linkset (Sheet 12 of 14)

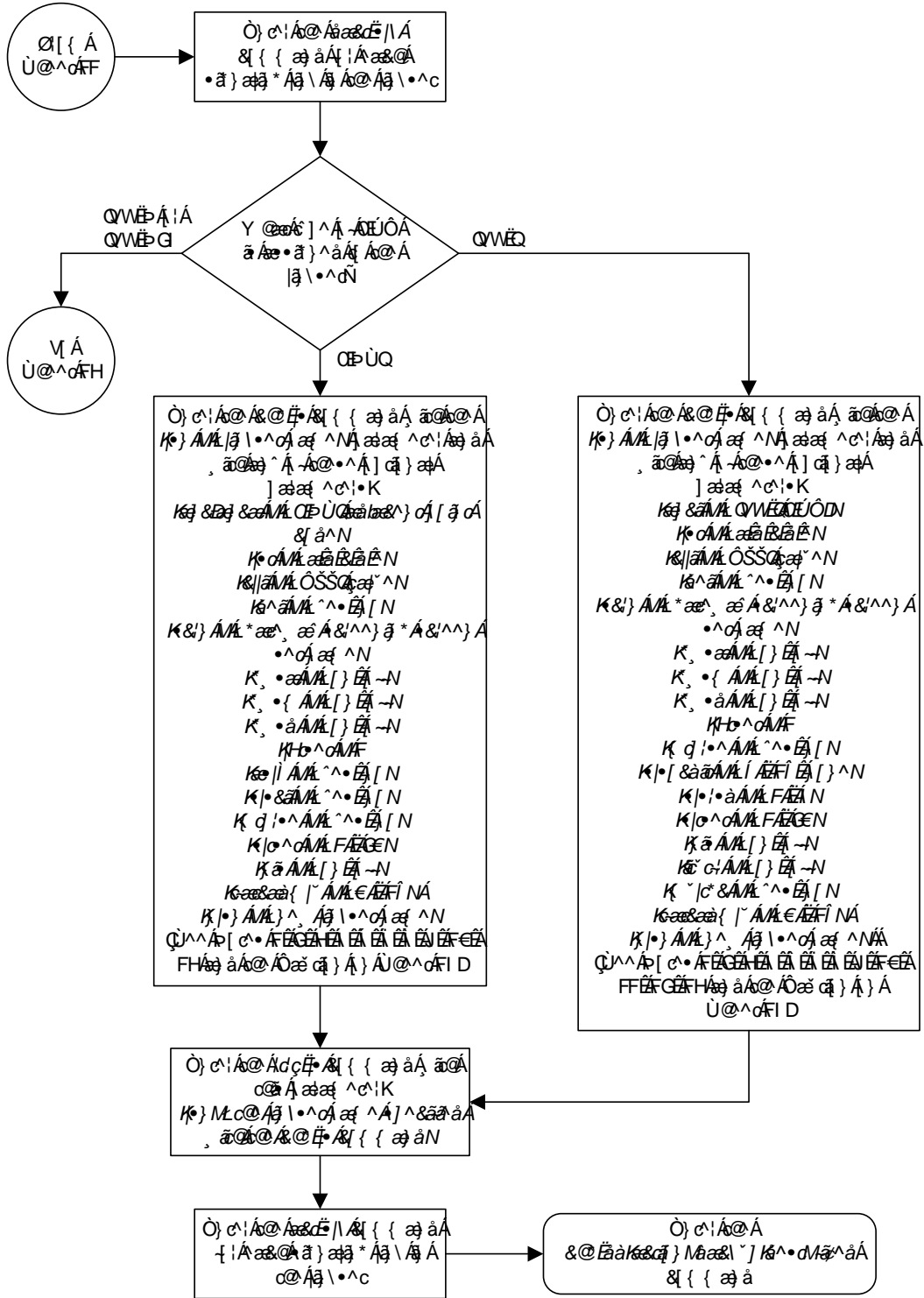

Configuring an ITU Linkset with a Secondary Adjacent Point Code (SAPC)

This procedure is used to configure a secondary adjacent point code for SS7 ITU linksets using the `lsn`, `sapci`, `sapcn`, `sapcn24`, and `action` parameters of the `chg-ls` command. Only these parameters can be specified in this procedure. The `chg-ls` command contains other parameters. These parameters are explained in more detail in the “Changing an SS7 Linkset” procedure on page 3-74 and in these procedures in the *Database Administration Manual - IP⁷ Secure Gateway*.

- “Configuring an IPGWx Linkset”
- “Configuring a Mate IPGWx Linkset”

The secondary adjacent point code is used to enhance the network management in the ITU international and ITU national nodes when messages from different countries to be routed over the same linkset.

The `lsn` parameter specifies the name of the linkset being changed.

The `sapci` parameter specifies the ITU international secondary adjacent point code.

The `sapcn` parameter specifies a 14-bit ITU national secondary adjacent point code.

The `sapcn24` parameter specifies a 24-bit ITU national secondary adjacent point code.

The `action` parameter specifies whether the secondary adjacent point code (`sapci`, `sapcn`, or `sapcn24`) is being added (`action=add`) to the linkset or removed (`action=delete`) from the linkset.

While the `multgc` parameter is not specified with the `chg-ls` command in this procedure, in addition to specifying whether or not multiple group codes are supported for the linkset, its value does help determine how secondary adjacent point codes are configured in the linkset.

When this parameter value is `yes`, and the APC of the linkset is a 14-bit ITU national point code, the linkset can contain one 14-bit ITU national secondary adjacent point code for each group code in the EAGLE 5 SAS, and one ITU international secondary adjacent point code. If the APC of the linkset is ITU international, the linkset can contain either one 14-bit ITU national secondary adjacent point code for each group code in the EAGLE 5 SAS, or only one 24-bit ITU national secondary adjacent point code, but no ITU international secondary adjacent point codes.

If the APC of the linkset is a 24-bit ITU national point code, the linkset contains only one ITU international secondary adjacent point code.

If the **multgc** parameter value is **no**, the linkset can contain only one secondary adjacent point code. An ITU international linkset can contain either a 14-bit ITU-N point code or a 24-bit ITU-N point code. An ITU national linkset, a linkset containing either a 14-bit APC or a 24-bit APC, can contain only an ITU international secondary adjacent point code.

The secondary adjacent point codes must be defined in the destination point code table and can be assigned only to linksets with ITU international or ITU national adjacent point codes, except linksets containing E1 ATM or IPLIM SAALTAI signaling links cannot contain 24-bit ITU national secondary adjacent point codes. Secondary adjacent point codes can be non-spare, spare, private, or private spare point codes. Private and private spare point codes can be specified only for IPGWI linksets (linksets containing IPGWI signaling links).

The secondary adjacent point code parameters (**sacpi**, **sapcn**, or **sapcn24**) and the **action** parameter must be specified together.

You cannot delete an SAPC with the **action** parameter when routes exist for its SS7 domain.

The values of the **multgc**, **sacpi**, **sapcn**, and **sapcn24** parameters are only displayed in the **rtrv-ls** command output when a specific linkset is being displayed with the **rtrv-ls:lsn=<linkset name>** command.

This examples used in this procedure are based on the information shown in Table 3-8.

Table 3-8. Secondary Adjacent Point Code Configuration Table

Linkset Names	SAPCI	SAPCN	ACTION
lsi3	N/A	11212-ge	add
lsn5	4-75-7	N/A	add
lsn3	3-150-5	N/A	delete

Canceling the RTRV-LS and RTRV-DSTN Commands

Because the **rtrv-ls** and **rtrv-dstn** commands used in this procedure can output information for a long period of time, the **rtrv-ls** and **rtrv-dstn** commands can be canceled and the output to the terminal stopped. There are three ways that the **rtrv-ls** and **rtrv-dstn** commands can be canceled.

- Press the **F9** function key on the keyboard at the terminal where the **rtrv-ls** or **rtrv-dstn** commands were entered.
- Enter the **canc-cmd** without the **trm** parameter at the terminal where the **rtrv-ls** or **rtrv-dstn** commands were entered.

- Enter the `canc-cmd:trm=<xx>`, where `<xx>` is the terminal where the `rtrv-ls` or `rtrv-dstn` commands were entered, from another terminal other than the terminal where the `rtrv-ls` or `rtrv-dstn` commands were entered. To enter the `canc-cmd:trm=<xx>` command, the terminal must allow Security Administration commands to be entered from it and the user must be allowed to enter Security Administration commands. The terminal's permissions can be verified with the `rtrv-secu-trm` command. The user's permissions can be verified with the `rtrv-user` or `rtrv-secu-user` commands.

For more information about the `canc-cmd` command, go to the *Commands Manual*.

Procedure

1. Display the current linkset configuration using the `rtrv-ls` command. This is an example of the possible output.

```
rlghncxa03w 05-09-10 11:43:04 GMT EAGLE5 34.0.0

LSN          APCA      (SS7)      L3T SLT          GWS GWS GWS
e1e2         001-207-000 none 1 1 no B 6 off off off no off
ls1305       000-005-000 none 1 1 no A 1 off off off no off
ls1307       000-007-000 none 1 1 no A 1 off off off no off
elm1s1       001-001-001 none 1 1 no A 7 off off off no off
elm1s2       001-001-002 none 1 1 no A 7 off off off no off

LSN          APCA      (X25)      L3T SLT          GWS GWS GWS
e1e2         001-207-000 none 1 1 no B 6 off off off no off
ls1305       000-005-000 none 1 1 no A 1 off off off no off
ls1307       000-007-000 none 1 1 no A 1 off off off no off
elm1s1       001-001-001 none 1 1 no A 7 off off off no off
elm1s2       001-001-002 none 1 1 no A 7 off off off no off

LSN          APCI      (SS7)      L3T SLT          GWS GWS GWS
e1e2i        1-207-0 none 1 1 no B 4 off off off --- on
ls1315       0-015-0 none 1 1 no A 1 off off off --- off
ls1317       0-017-0 none 1 1 no A 1 off off off --- on
elm2s1       1-011-1 none 1 1 no A 7 off off off --- off
elm2s2       1-011-2 none 1 1 no A 7 off off off --- off

LSN          APCN      (SS7)      L3T SLT          GWS GWS GWS
e1e2         001-207-000 none 1 1 no B 6 off off off no off
ls1305       000-005-000 none 1 1 no A 1 off off off no off
ls1307       000-007-000 none 1 1 no A 1 off off off no off
elm1s1       001-001-001 none 1 1 no A 7 off off off no off
elm1s2       001-001-002 none 1 1 no A 7 off off off no off

LSN          APCN24   (SS7)      L3T SLT          GWS GWS GWS
e1e2         001-207-000 none 1 1 no B 6 off off off no off
ls1305       000-005-000 none 1 1 no A 1 off off off no off
ls1307       000-007-000 none 1 1 no A 1 off off off no off
elm1s1       001-001-001 none 1 1 no A 7 off off off no off
elm1s2       001-001-002 none 1 1 no A 7 off off off no off

LSN (CHINA) APCN      (SS7)      L3T SLT          GWS GWS GWS
e1e2         001-207-000 none 1 1 no B 6 off off off no off
ls1305       000-005-000 none 1 1 no A 1 off off off no off
ls1307       000-007-000 none 1 1 no A 1 off off off no off
elm1s1       001-001-001 none 1 1 no A 7 off off off no off
elm1s2       001-001-002 none 1 1 no A 7 off off off no off

LSN (CHINA) APCN24 (SS7) L3T SLT          GWS GWS GWS
e1e2         001-207-000 none 1 1 no B 6 off off off no off
ls1305       000-005-000 none 1 1 no A 1 off off off no off
ls1307       000-007-000 none 1 1 no A 1 off off off no off
elm1s1       001-001-001 none 1 1 no A 7 off off off no off
elm1s2       001-001-002 none 1 1 no A 7 off off off no off

Link set table is (10 of 1024) 1% full.
```

2. Display the current linkset configuration of the linkset to be changed using the **rtrv-ls** command with the linkset name. For this example, enter this command.

```
rtrv-ls:lsn=lsi3
```

This is an example of the possible output.

```
rlghncxa03w 05-09-17 11:43:04 GMT EAGLE5 34.0.0

LSN          APCI  (SS7)  L3T SLT          GWS GWS GWS
lsi3         1-111-3  scr3 1   3   yes c   1   off off off --- ---

          CLLI          TFATCABMLQ  MTPRSE  ASL8   SLSRSB  MULTGC  ITUTFR
          ----- 1          ---    ---    7      yes    off

IPGWAPC
no

          LOC  LINK SLC TYPE          L2T          L1          PCR  PCR
          SET  BPS          MODE TSET  ECM  N1  N2
1317  A    0  IPGWI

          LOC  LINK SLC TYPE          LP          ATM          VCI  VPI  LL
          SET  BPS          TSEL          VCI  VPI  LL

          LOC  LINK SLC TYPE          LP          ATM          VCI  VPI  CRC4 SI SN
          SET  BPS          TSEL          VCI  VPI  CRC4 SI SN

          LOC  LINK SLC TYPE          IPLIML2

          LOC  LINK SLC TYPE

          LOC  LINK SLC TYPE          L2T          PCR  PCR  E1  E1
          SET  BPS          ECM  N1  N2  LOC  PORT TS

          LOC  LINK SLC TYPE          L2T          PCR  PCR  T1  T1
          SET  BPS          ECM  N1  N2  LOC  PORT TS

SAPCN
11211-uk
```

Link set table is (13 of 255) 5% full

```
rtrv-ls:lsn=lsn3
```

This is an example of the possible output.

```
rlghncxa03w 05-09-17 11:43:04 GMT EAGLE5 34.0.0

LSN          APCN  (SS7)  L3T SLT          GWS GWS GWS
lsn3         11113-ge  scr3 1   3   yes c   1   on  off off --- off

          CLLI          TFATCABMLQ  MTPRSE  ASL8   SLSOCB  MULTGC  ITUTFR
          ----- 1          ---    ---    7      yes    off

IPGWAPC
no

          LOC  LINK SLC TYPE          L2T          L1          PCR  PCR
          SET  BPS          MODE TSET  ECM  N1  N2
```

SS7 Configuration

```

1301 A 0 IPLIMI

LOC LINK SLC TYPE LP ATM
SET BPS TSEL VCI VPI LL

LOC LINK SLC TYPE LP ATM E1ATM
SET BPS TSEL VCI VPI CRC4 SI SN

LOC LINK SLC TYPE IPLIML2

LOC LINK SLC TYPE

LOC LINK SLC TYPE L2T PCR PCR E1 E1
SET BPS ECM N1 N2 LOC PORT TS

LOC LINK SLC TYPE L2T PCR PCR T1 T1
SET BPS ECM N1 N2 LOC PORT TS

SAPCI
3-150-5

SAPCN
11213-de

```

Link set table is (13 of 255) 5% full

rtrv-ls:lsn=lsn5

This is an example of the possible output.

rlghncxa03w 05-09-17 11:43:04 GMT EAGLE5 34.0.0

```

LSN APCN (SS7) SCRN L3T SLT GWS GWS GWS
lsn5 10685-fr scr1 1 3 yes a 1 off off off --- off

CLLI TFATCABMLQ MTPRSE ASL8 SLSOCB MULTGC ITUTFR
----- 1 --- --- 7 no off

IPGWAPC
no

LOC LINK SLC TYPE L2T L1 PCR PCR
SET BPS MODE TSET ECM N1 N2

1201 A 0 IPLIMI

LOC LINK SLC TYPE LP ATM
SET BPS TSEL VCI VPI LL

LOC LINK SLC TYPE LP ATM E1ATM
SET BPS TSEL VCI VPI CRC4 SI SN

LOC LINK SLC TYPE IPLIML2

LOC LINK SLC TYPE

LOC LINK SLC TYPE L2T PCR PCR E1 E1
SET BPS ECM N1 N2 LOC PORT TS

LOC LINK SLC TYPE L2T PCR PCR T1 T1
SET BPS ECM N1 N2 LOC PORT TS

```

Link set table is (13 of 255) 5% full

If 24-bit ITU-N secondary adjacent point codes are being added to the linkset, and the linkset specified in this step contains E1 ATM or IPLIM SAALTALI signaling links, choose another linkset from step 1 and repeat this step. Linksets containing E1 ATM or IPLIM SAALTALI signaling links cannot have 24-bit ITU-N secondary adjacent point codes.

NOTE: If you are not adding any secondary adjacent point codes to the linkset, skip steps 3 and 4, and go to step 5.

3. Display the point code and capability point code of the EAGLE 5 SAS by using the `rtrv-sid` command. This is an example of the possible output.

```
rlghncxa03w 05-09-10 11:43:04 GMT EAGLE5 34.0.0
PCA          PCI          PCN          CLLI          PCTYPE
001-001-001  3-150-4        12345-uk     rlghncxa03w   OTHER

CPCA
002-002-002      002-002-003      002-002-004      002-002-005
002-002-006      002-002-007      002-002-008      002-002-009
004-002-001      004-003-003      144-212-003

CPCI
1-001-1          1-001-2          1-001-3          1-001-4

CPCN
02091-uk        02092-uk        02094-uk        02097-uk
02191-uk        02192-uk        11177-uk
```

4. Display the point codes in the destination point code table by using the `rtrv-dstn` command. This is an example of the possible output.

```
rlghncxa03w 05-09-10 11:43:04 GMT EAGLE5 34.0.0
DPCA          CLLI          BEI  ELEI  ALIASI          ALIASN/N24  DOMAIN
001-002-003  ls04clli     yes  ---  -----  -----  SS7
001-002-003  ls04clli     yes  ---  -----  -----  SS7
002-002-100  ls01clli     no   ---  -----  -----  SS7
002-007-008  ls06clli     yes  ---  -----  -----  SS7
002-009-003  -----     no   ---  -----  -----  SS7
002-250-010  -----     no   ---  -----  -----  SS7
003-003-003  ls03clli     yes  ---  -----  -----  SS7
003-020-100  -----     no   ---  -----  -----  SS7
004-004-004  ls02clli     yes  ---  -----  -----  SS7
004-030-200  -----     no   ---  -----  -----  SS7
009-002-003  -----     no   ---  -----  -----  SS7
179-100-087  -----     yes  ---  -----  -----  SS7
200-050-176  -----     yes  ---  -----  -----  SS7
240-007-000  -----     yes  ---  -----  -----  SS7
240-012--004  rlghncbb001  yes  ---  1-111-1      11111      SS7
240-012-005  rlghncbb002  yes  ---  1-112-2      11112      SS7
240-012-008  -----     yes  ---  1-113-5      11114      SS7
244-010-004  ls06clli     no   ---  -----  -----  X25
244-012-005  ls07clli     no   ---  -----  -----  X25
244-012-006  ls08clli     no   ---  -----  -----  X25
244-012-007  -----     no   ---  -----  -----  X25
244-012-008  -----     no   ---  -----  -----  X25

DPCI          CLLI          BEI  ELEI  ALIASA          ALIASN/N24  DOMAIN
2-131-1      rlghncbb023  no   ---  222-210-000  12001      SS7
2-131-2      -----     no   ---  222-211-001  12002      SS7
```

SS7 Configuration

```
2-131-3      -----   no ---   222-211-002   12003   SS7
3-150-4      lsi7clli   yes ---   -----   -----   SS7

DPCN        CLLI        BEI ELEI   ALIASA        ALIASI        DOMAIN
10685       lsn5clli   yes ---   -----   -----   SS7
11211       rlghncbb013 no ---   222-200-200   2-121-1   SS7
11212       rlghncbb013 no ---   222-200-201   2-121-2   SS7

DPCN24      CLLI        BEI ELEI   ALIASA        ALIASI        DOMAIN
```

```
Destination table is (28 of 2000) 1% full
Alias table is (18 of 8000) 1% full
RTRV-DSTN: MASP A - COMPLTD
```

If a secondary adjacent point code is being added to the linkset, and the secondary adjacent point code is not shown in the `rtrv-dstn` command output, go to the “Adding a Destination Point Code” procedure on page 2-191 procedures and add the secondary adjacent point code to the destination point code table.

NOTE: If you are adding only ITU-I or 24-bit ITU-N secondary adjacent point codes, skip this step and go to step 6.

5. Display the secondary point codes in the destination point code table to verify any group codes that are assigned to 14-bit ITU-N secondary point codes in the database by using the `rtrv-spc` command. This is an example of the possible output.

```
rlghncxa03w 05-09-17 16:02:05 GMT EAGLE5 34.0.0
SPC (Secondary Point Codes)
```

```
SPCA
  001-010-010
  002-010-010
  003-010-010
  010-100-010
```

```
SPC-I
  1-253-5
  2-254-6
  3-255-7
  4-100-1
```

```
SPC-N
  5175-de
  6744-uk
  7673-ge
  7673-fr
```

```
SPC-N24
```

```
Secondary Point Code table is (12 of 40) 30% full
```

NOTE: If you are not removing a secondary adjacent point code from a linkset, skip this step and go to step 7.

6. Display the routes using the secondary adjacent point code being removed from the linkset with the `rtrv-rte` command, specifying the secondary adjacent point code being removed as the value of the `dpc` parameter.

For this example, enter this command.

```
rtrv-rte:dpci=3-150-5
```

This is an example of the possible output.

```
rlghncxa03w 05-09-07 11:43:04 GMT EAGLE5 34.0.0
DPCI      ALIASN/N24      ALIASA      LSN      RC      APC
3-150-5 -----          -----    lsn3      10      3-150-5
                                           CLLI=-----
```

If the secondary adjacent point code is assigned to a route, that route must be removed from the database. Go to the “Removing a Route” procedure on page 3-189 to remove the route from the database.

7. Perform one of these steps to configure the linkset with a secondary adjacent point code.
 - a. To add the secondary adjacent point code to the linkset, enter the `chg-ls` command with these parameters.

```
:lsn=<linkset name being changed>
```

```
:action=add
```

```
:sapci=<ITU-I secondary adjacent point code being added>
```

or

```
:sapcn=<14-bit ITU-N secondary adjacent point code being added>
```

or

```
:sapcn24=<24-bit ITU-N secondary adjacent point code being added>
```

If the value of the `multgc` parameter is `yes`, and the APC of the linkset is a 14-bit ITU national point code, the linkset can contain one 14-bit ITU national secondary adjacent point code for each group code in the EAGLE 5 SAS, and one ITU international secondary adjacent point code.

If the APC of the linkset is an ITU international point code, the linkset can contain either one 14-bit ITU national secondary adjacent point code for each group code in the EAGLE 5 SAS, or one 24-bit ITU national secondary adjacent point code, but no ITU international secondary adjacent point codes. If the APC of the linkset is a 24-bit ITU national point code, the linkset contains only one ITU international secondary adjacent point code. The output of the `rtrv-dstn` command in step 4 and the `rtrv-spc` command in step 5 shows the group codes in the database.

If the value of the `multgc` parameter is `no`, the linkset can contain only one secondary adjacent point code. An ITU international linkset can

contain either a 14-bit ITU-N point code or a 24-bit ITU-N point code. An ITU national linkset, a linkset containing either a 14-bit APC or a 24-bit APC, can contain only an ITU international secondary adjacent point code.

Secondary adjacent point codes can be non-spare, spare, private, or private spare point codes. Private and private spare point codes can be specified only for IPGWI linksets (linksets containing IPGWI signaling links).

- b. To remove the secondary adjacent point code from the linkset, enter the **chg-ls** command with these parameters.

```
:lsn=<linkset name being changed>
```

```
:action=delete
```

```
:sapci=<ITU-I secondary adjacent point code being removed>
```

or

```
:sapcn=<14-bit ITU-N secondary adjacent point code being added>
```

or

```
:sapcn24=<24-bit ITU-N secondary adjacent point code being added>
```

- c. If only one secondary adjacent point code can be assigned to the linkset, and that secondary adjacent point code is being replaced, perform step **b** to remove the existing secondary adjacent point code, then perform step **a** to add the new secondary adjacent point code.

For this example, enter these commands.

```
chg-ls:lsn=lsi3:sapcn=11212-ge:action=add
```

```
chg-ls:lsn=lsn3:sapci=4-75-7:action=add
```

```
chg-ls:lsn=lsn5:sapci=3-150-5:action=delete
```

When the **chg-ls** command has successfully completed, this message should appear.

```
rlghncxa03w 05-09-17 16:23:21 GMT EAGLE5 34.0.0  
Link set table is ( 13 of 255) 5% full  
CHG-LS: MASP A - COMPLTD
```

8. Verify the changes using the **rtrv-ls** command specifying the linkset name specified in step 7 with the **lsn** parameter. For this example, enter these commands.

```
rtrv-ls:lsn=lsi3
```

This is an example of the possible output.

```
rlghncxa03w 05-09-17 11:43:04 GMT EAGLE5 34.0.0

LSN          APCI  (SS7)  L3T SLT          GWS GWS GWS
lsi3         1-111-3  scr3 1   3   yes c   1   off off off --- ---

          CLLI          TFATCABMLQ  MTPRSE  ASL8   SLSRSB  MULTGC  ITUTFR
          ----- 1          ---    ---    7      yes    off

IPGWAPC
no

          L2T          L1          PCR  PCR
          SET  BPS    MODE TSET  ECM  N1  N2
LOC  LINK SLC TYPE
1317 A  0  IPGWI

          LP          ATM
          SET  BPS    TSEL          VCI  VPI  LL
LOC  LINK SLC TYPE
LOC  LINK SLC TYPE          LP          ATM          E1ATM
          SET  BPS    TSEL          VCI  VPI  CRC4 SI SN
LOC  LINK SLC TYPE          IPLIML2
LOC  LINK SLC TYPE

          L2T          PCR  PCR  E1  E1
          SET  BPS    ECM  N1  N2  LOC  PORT TS
LOC  LINK SLC TYPE
LOC  LINK SLC TYPE          L2T          PCR  PCR  T1  T1
          SET  BPS    ECM  N1  N2  LOC  PORT TS

SAPCN
11211-uk
11212-ge
```

Link set table is (13 of 255) 5% full

```
rtrv-ls:lsn=lsn3
```

This is an example of the possible output.

```
rlghncxa03w 05-09-17 11:43:04 GMT EAGLE5 34.0.0

LSN          APCN  (SS7)  L3T SLT          GWS GWS GWS
lsn3         11113-ge  scr3 1   3   yes c   1   on  off off --- off

          CLLI          TFATCABMLQ  MTPRSE  ASL8   SLSOCB  MULTGC  ITUTFR
          ----- 1          ---    ---    7      yes    off

IPGWAPC
no
```

SS7 Configuration

```

                L2T          L1          PCR PCR
LOC  LINK SLC TYPE  SET BPS  MODE TSET  ECM  N1  N2
1301 A    0  IPLIMI

                LP          ATM
LOC  LINK SLC TYPE  SET BPS  TSEL          VCI  VPI  LL

                LP          ATM          E1ATM
LOC  LINK SLC TYPE  SET BPS  TSEL          VCI  VPI  CRC4 SI SN
LOC  LINK SLC TYPE  IPLIML2
LOC  LINK SLC TYPE

                L2T          PCR PCR  E1  E1
LOC  LINK SLC TYPE  SET BPS  ECM  N1  N2  LOC  PORT TS

                L2T          PCR PCR  T1  T1
LOC  LINK SLC TYPE  SET BPS  ECM  N1  N2  LOC  PORT TS

SAPCN
11213-de

```

Link set table is (13 of 255) 5% full

rtrv-ls:lsn=lsn5

This is an example of the possible output.

rlghncxa03w 05-09-17 11:43:04 GMT EAGLE5 34.0.0

```

                L3T SLT          GWS GWS GWS
LSN          APCN  (SS7)  SCRNLST LNKS ACT MES DIS SLSCI NIS
lsn5         10685-fr  scr1 1  3  yes a  1  off off off  --- off

CLLI          TFATCABMLQ  MTPRSE  ASL8  SLSOCB  MULTGC  ITUTFR
----- 1          ---  ---  7  no  off

```

IPGWAPC
no

```

                L2T          L1          PCR PCR
LOC  LINK SLC TYPE  SET BPS  MODE TSET  ECM  N1  N2
1201 A    0  IPLIMI

                LP          ATM
LOC  LINK SLC TYPE  SET BPS  TSEL          VCI  VPI  LL

                LP          ATM          E1ATM
LOC  LINK SLC TYPE  SET BPS  TSEL          VCI  VPI  CRC4 SI SN
LOC  LINK SLC TYPE  IPLIML2
LOC  LINK SLC TYPE

                L2T          PCR PCR  E1  E1
LOC  LINK SLC TYPE  SET BPS  ECM  N1  N2  LOC  PORT TS

                L2T          PCR PCR  T1  T1
LOC  LINK SLC TYPE  SET BPS  ECM  N1  N2  LOC  PORT TS

SAPCI
4-75-7

```

Link set table is (13 of 255) 5% full

9. Back up the new changes using the **chg-db:action=backup:dest=fixed** command. These messages should appear, the active Maintenance and Administration Subsystem Processor (MASP) appears first.

```
BACKUP (FIXED) : MASP A - Backup starts on active MASP.  
BACKUP (FIXED) : MASP A - Backup on active MASP to fixed disk complete.  
BACKUP (FIXED) : MASP A - Backup starts on standby MASP.  
BACKUP (FIXED) : MASP A - Backup on standby MASP to fixed disk complete.
```

Flowchart 3-5. Configuring an ITU Linkset with a Secondary Adjacent Point Code (SAPC) (Sheet 1 of 5)

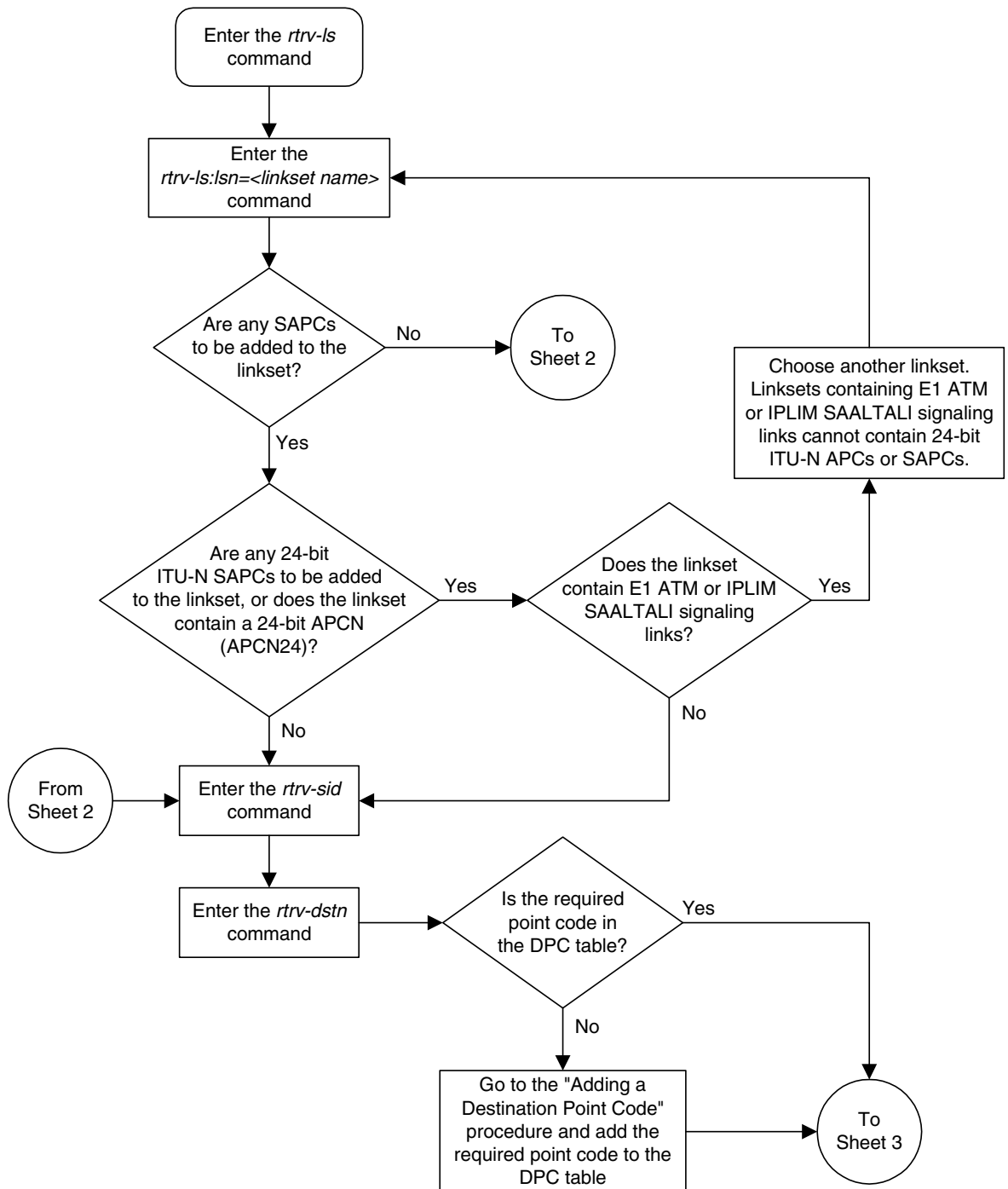

Flowchart 3-5. Configuring an ITU Linkset with a Secondary Adjacent Point Code (SAPC) (Sheet 2 of 5)

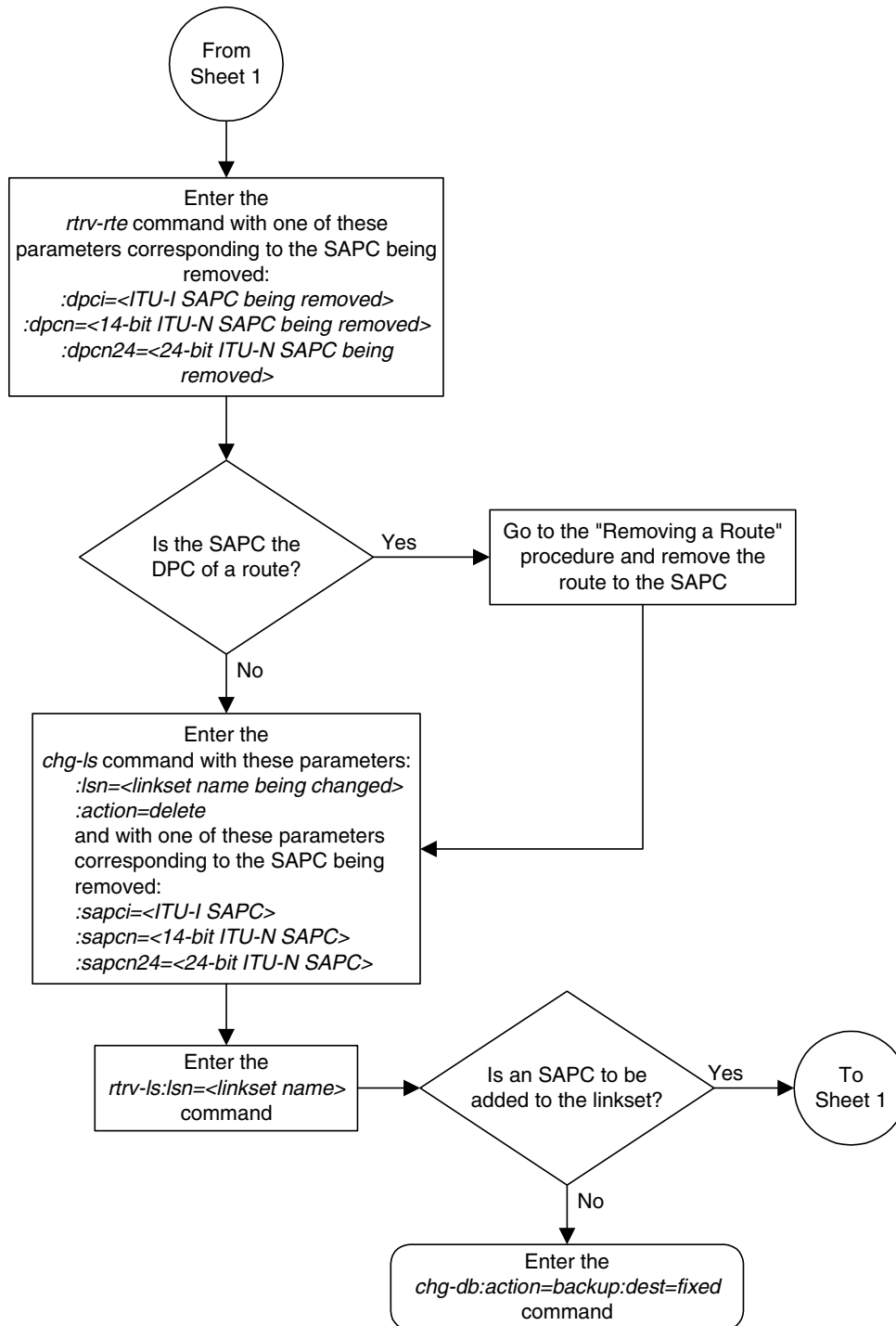

Flowchart 3-5. Configuring an ITU Linkset with a Secondary Adjacent Point Code (SAPC) (Sheet 3 of 5)

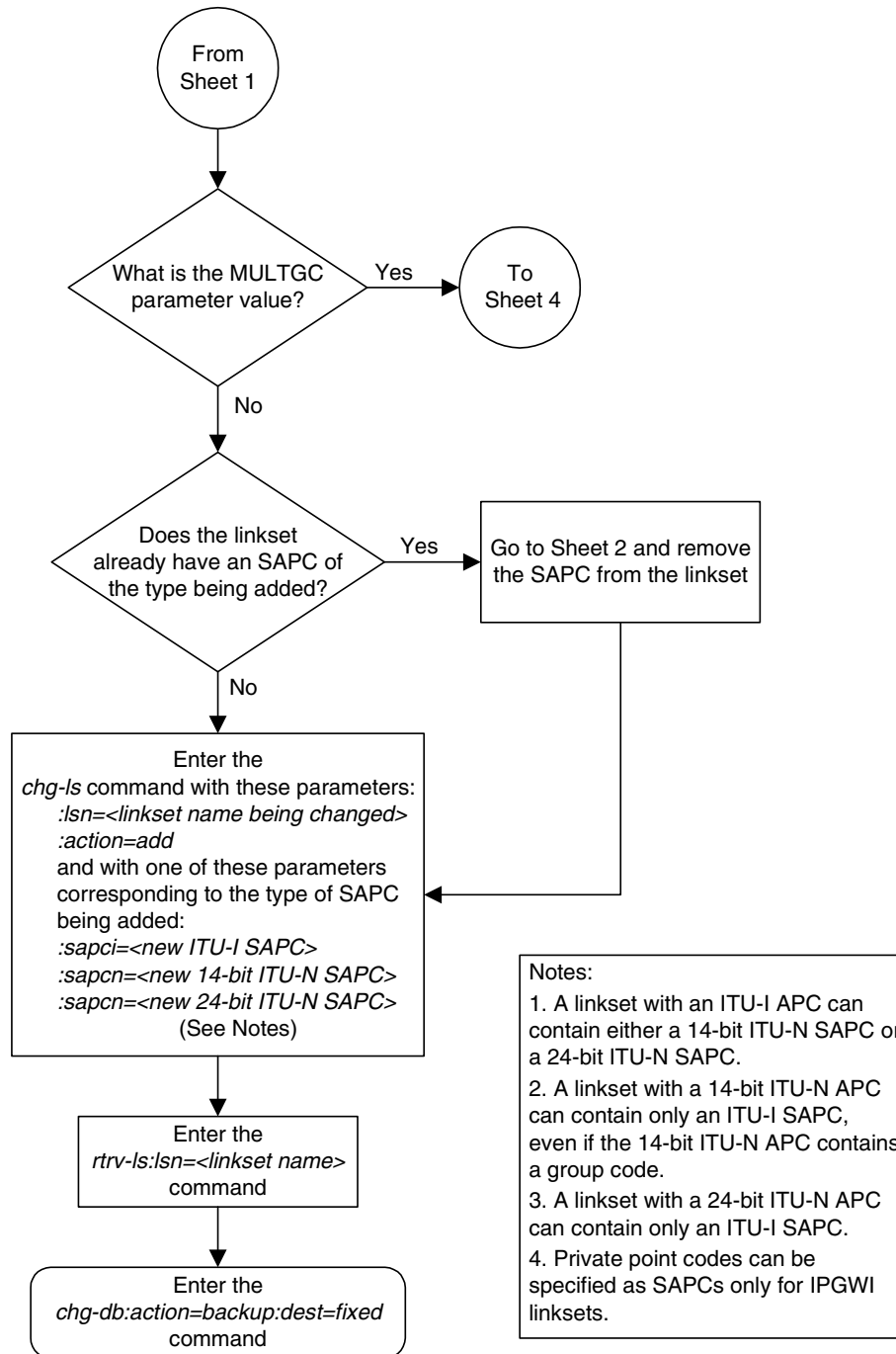

Flowchart 3-5. Configuring an ITU Linkset with a Secondary Adjacent Point Code (SAPC) (Sheet 4 of 5)

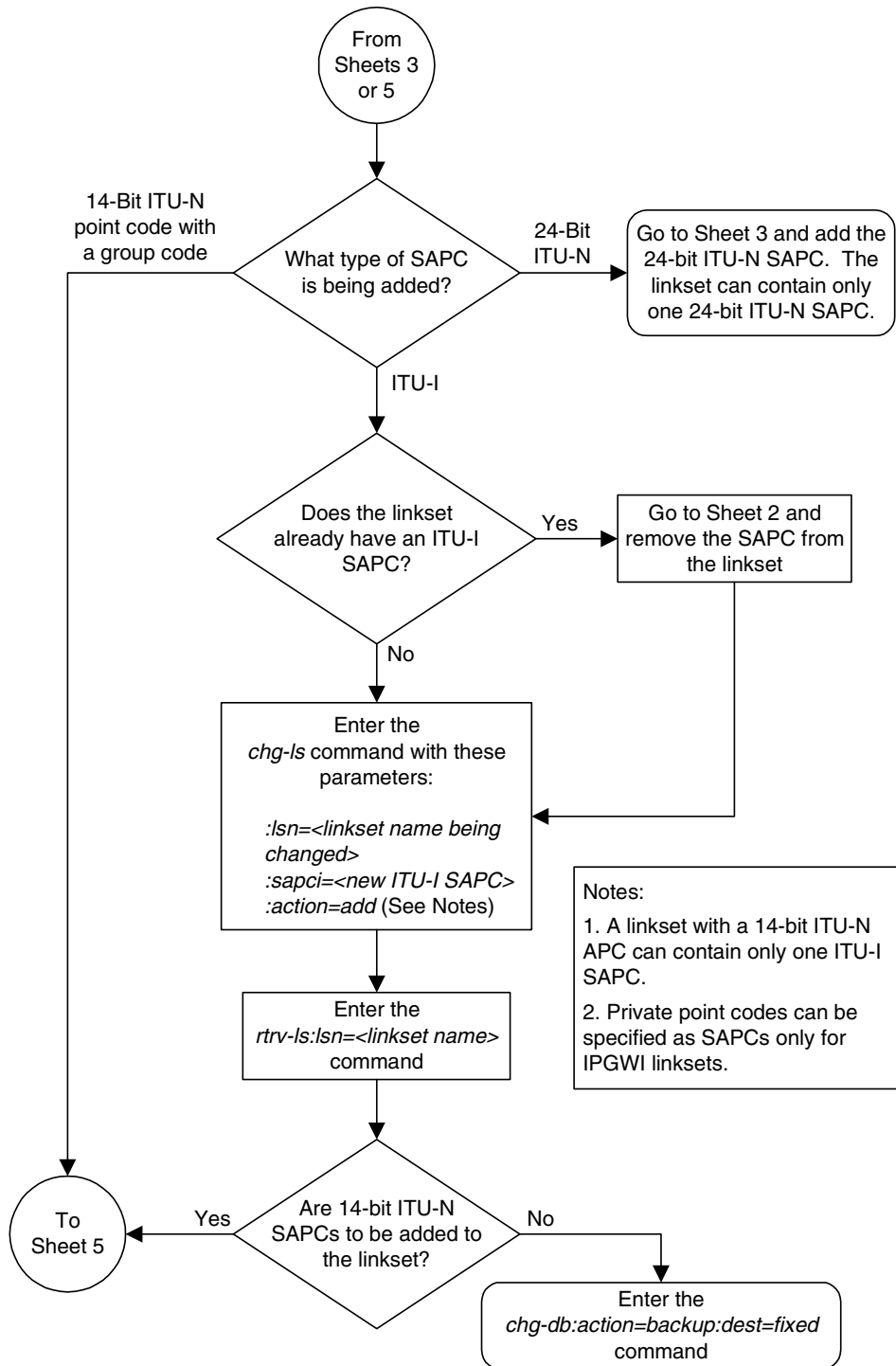

Flowchart 3-5. Configuring an ITU Linkset with a Secondary Adjacent Point Code (SAPC) (Sheet 5 of 5)

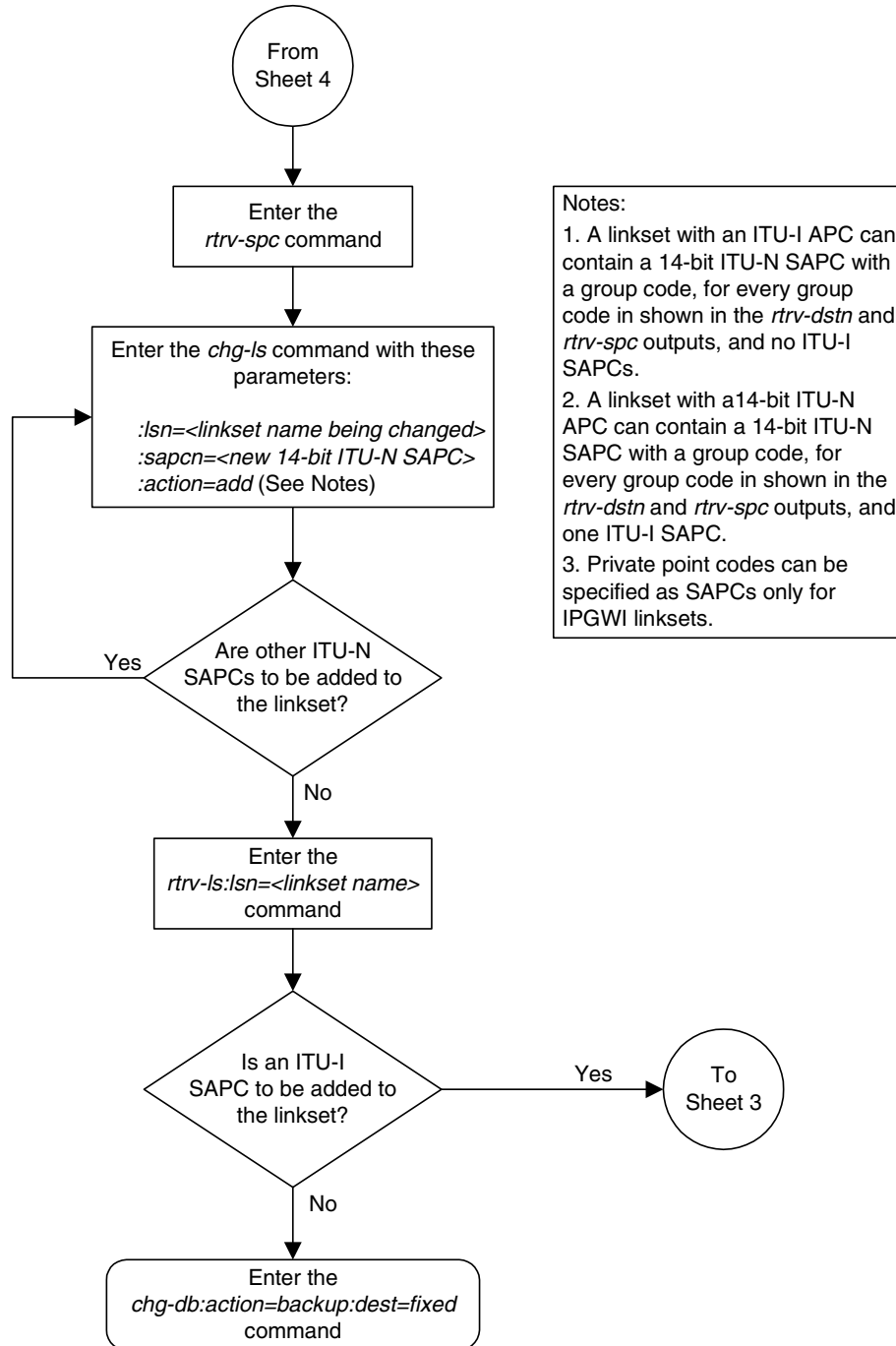

Adding an SS7 Signaling Link

This procedure is used to add an SS7 low-speed signaling link to the database using the `ent-slk` command. To add other types of signaling links to the database, go to one of these procedures:

- An E1 signaling link, perform the “Adding an E1 Signaling Link” procedure on page A-77.
- A T1 signaling link, perform the “Adding a T1 Signaling Link” procedure on page B-47.
- An ATM high-speed signaling link (ANSI or E1), perform the “Adding an ATM High-Speed Signaling Link” procedure on page C-34.
- An IP signaling link, go to the “Adding an IP Signaling Link” procedure in the *Database Administration Manual - IP⁷ Secure Gateway*.
- An X.25 signaling link, go to the “Adding an X.25 Signaling Link” procedure in the *Database Administration Manual – Features*.

The `ent-slk` command uses these parameters.

:loc – The card location of the LIM that the SS7 signaling link will be assigned to. The cards specified by this parameter are LIM-DS0, LIMOCU, LIMV.35.

:link – The signaling link on the card specified in the `loc` parameter.

:lsn – The name of the linkset that will contain the signaling link.

:slc – The signaling link code. The SLC must be unique within the linkset. It must be the same at both the EAGLE 5 SAS location and the distant node.

:l2tset – The level 2 timer set table. A signaling link may be assigned to any of the thirty tables. The type of linkset the signaling link is assigned to and the LIM’s application determines the value of the `l2tset` parameter. The level 2 timer set tables are defined in the “Changing Level 2 Timers” procedure on page 3-219. Table 3-9 on page 3-131 shows the `l2tset` parameter values.

Table 3-9. L2TSET Parameter Values

Type of Linkset	LIM's Application	L2TSET Parameter Value	L2TSET Parameter Default Value
ANSI linkset – Shown by this label in the rtrv-ls output. LSN APCA (SS7)	SS7ANSI	1 - 10	1
ITU linkset – Shown by one of these labels in the rtrv-ls output. LSN APCI (SS7) LSN APCN (SS7) LSN APCN24 (SS7)	CCS7ITU	11 - 20	11
ITU-N high-speed linkset for China – Shown by one of these labels in the rtrv-ls output. LSN (CHINA) APCN (SS7) LSN (CHINA) APCN24 (SS7)	CCS7ITU	21 - 25	21
ITU-N high-speed linkset for countries other than China – Shown by one of these labels in the rtrv-ls output. LSN APCN (SS7) LSN APCN24 (SS7)	CCS7ITU	26 - 30	26

:l1mode – The mode of operation used to select the link clocking source at layer 1. One end of a V.35 link must be DTE and the other end must be DCE.

:bps – The transmission rate for the link in bits per second.

:tset – Transmitter signal element timing

:ecm – Error correction method

:pcrn1 – The threshold of the number of MSUs available for retransmission. If the error correction method being used is PCR (**:ecm=pcr**), and this threshold is reached, no new MSUs or FISUs are sent. The retransmission cycle is continued up to the last MSU entered into the retransmission buffer in the order in which they were originally transmitted.

:pcrn2 – The threshold of the number of MSU octets available for retransmission. If the error correction method being used is PCR (**:ecm=pcr**), and this threshold is reached, no new MSUs or FISUs are sent. The retransmission cycle is continued up to the last MSU entered into the retransmission buffer in the order in which they were originally transmitted.

The `ent-slk` command also contains these parameters, `lpset`, `atmtsel`, `vci`, `vpi`, `ll`, `elatmcrc4`, `elatmsi`, `elatmsn`, `ts`, `elport`, `elloc`, `tlport`, `tlloc`, and `iplim12`. These parameters are used only for configuring ATM high-speed, E1, T1, and IP signaling links and are not used in this procedure. For more information on configuring E1 signaling links, go to the “Adding an E1 Signaling Link” procedure on page A-77. For more information on configuring T1 signaling links, go to the “Adding a T1 Signaling Link” procedure on page B-47. For more information on configuring an ATM high-speed signaling link (ANSI or E1), go to the “Adding a High-Speed LIM-ATM or an E1-ATM LIM” procedure on page C-31. For more information on configuring an IP signaling link go to the “Adding an IP Signaling Link” procedure in the *Database Administration Manual - IP⁷ Secure Gateway*.

These items must be configured in the database before an SS7 signaling link can be added:

- Shelf – see “Adding a Shelf” in the *Database Administration Manual - System Management*
- Card – see “Adding an SS7 LIM” in the *Database Administration Manual - System Management*
- Destination Point Code – see “Adding a Destination Point Code” on page 2-191
- Linkset – see “Adding an SS7 Linkset” on page 3-17.

Verify that the link has been physically installed (all cable connections have been made).

To configure the EAGLE 5 SAS to perform circular routing detection test on the signaling links, “Configuring Circular Route Detection” procedure on page 3-231.

NOTE: Circular route detection is not supported in ITU networks.

To provision a EAGLE 5 SAS with more than 700 signaling links, the EAGLE 5 SAS must have certain levels of hardware installed. See the “Requirements for EAGLE 5 SASs Containing more than 700 Signaling Links” section on page D-2 for more information on these hardware requirements.

The EAGLE 5 SAS can contain a mixture of low-speed, E1, T1, ATM high-speed, and IP signaling links. The “Determining the Number of High-Speed and Low-Speed Signaling Links” section on page D-2 describes how to determine the quantities of the different types of signaling links the EAGLE 5 SAS can have.

SS7 Signaling Link Parameter Combinations

Table 3-10 on page 3-133 shows the three types of SS7 signaling links that can be provisioned in the database with the `ent-slk` command in this procedure, and the parameters and values that can be used to provision each type of SS7 signaling link.

SS7 Configuration

Table 3-10. SS7 Signaling Link Parameter Combinations

Low-Speed Signaling Link ¹	MPL Signaling Link ¹
Mandatory Parameters	
:loc = location of the LIM with one of these applications: SS7ANSI, CCS7ITU; and one of these card types: LIMDS0, LIMOCU, LIMV35	:loc = location of the MPL with the SS7ANSI application and the LIMDS0 card type.
:link = A or B ⁸	:link = A, A1, A2, A3, B, B1, B2, or B3 ⁸
:lsn = linkset name ²	:lsn = linkset name ⁷
:slc = 0 - 15	:slc = 0 - 15
Optional Parameters	
:bps = 56000 or 64000 ³ default value = 56000	:bps = 56000 default value = 56000
:l2tset = See Table 3-9 on page 3-131	:l2tset = Table 3-9 on page 3-131
:ecm = basic or pcr default value = basic	:ecm = basic or pcr default value = basic
:pcrn1 = 1 - 127 ⁴ default value = 76	:pcrn1 = 1 - 127 ⁴ default value = 76
:pcrn2 = 300 - 35500 ⁴ default value = 3800	:pcrn2 = 300 - 35500 ⁴ default value = 3800
:l1mode = dte or dce ⁵ default value = dte	
:tset = on or off ^{5, 6} default value = off	
<p>Notes:</p> <ol style="list-style-type: none"> This procedure is not used to configure ATM, X.25, IP, E1, or T1 signaling links. To configure these types of links, perform one of these procedures: <ul style="list-style-type: none"> E1 signaling links – “Adding an E1 Signaling Link” procedure on page A-77. T1 signaling links – “Adding a T1 Signaling Link” procedure on page B-47. ATM signaling links – “Adding an ATM High-Speed Signaling Link” procedure on page C-34. IP signaling links – “Adding an IP Signaling Link” procedure in the <i>Database Administration Manual - IP⁷ Secure Gateway</i>. X.25 signaling links – “Adding an X.25 Signaling Link” procedure in the <i>Database Administration Manual - Features</i>. The linkset adjacent point code type (ITU/ANSI) must match the card's application (CCS7ITU/SS7ANSI). The domain of the linkset adjacent point code must be SS7. A linkset can contain a maximum of 16 signaling links. If the card type is LIMDS0 or LIMOCU, the value of this parameter must be 56000. All signaling links in a linkset must have the same transmission rate (bps parameter value). These parameters can be specified only with the ecm=pcr parameter. These parameters can be specified only if the card type is LIMV35. This parameter can be specified only with the l1mode=dce parameter. The linkset adjacent point code type must be ANSI. The domain of the linkset adjacent point code must be SS7. The port parameter can be used in place of the link parameter to specify the signaling link on the card. 	

Example Signaling Link Configuration

This examples used in this procedure are based on the example network shown in Figure 3-3 and Table 3-11.

Table 3-11. Low-Speed Signaling Link Configuration Table

SLK		LSN	SLC	TYPE	L2TSET	BPS
LOC	LINK					
1201	A	LS01	0	LIMDS0	1	----
1204	B	LS01	1	LIMDS0	1	----
1202	B	LS02	0	LIMV35	2	64000
1206	A	LS02	1	LIMV35	2	64000
1203	A	LS03	0	LIMDS0	3	----
1208	B	LS03	1	LIMDS0	3	----
1212	A	LS04	1	LIMV35	4	64000
1213	B	LS05	0	LIMDS0	5	----
1215	A	LS05	1	LIMDS0	5	----
1301	B	LS06	0	LIMV35	6	56000
1304	B	LS06	1	LIMV35	6	56000
1308	A	LS06	2	LIMV35	6	56000
1311	A	LS01	2	LIMDS0	1	----
1311	A1	LS05	2	LIMDS0	5	----
1311	B	LS03	2	LIMDS0	3	----
1311	B1	LS07	1	LIMDS0	7	----
1313	A	LS07	0	LIMDS0	7	----
1315	A	LSN5	0	LIMV35	11	64000
1317	A	LSI7	0	LIMV35	11	64000

Canceling the REPT-STAT-SLK and RTRV-SLK Commands

Because the `rept-stat-slk` and `rtrv-slk` commands used in this procedure can output information for a long period of time, the `rept-stat-slk` and `rtrv-slk` commands can be canceled and the output to the terminal stopped. There are three ways that the `rept-stat-slk` and `rtrv-slk` commands can be canceled.

- Press the **F9** function key on the keyboard at the terminal where the `rept-stat-slk` or `rtrv-slk` commands were entered.
- Enter the `canc-cmd` without the `trm` parameter at the terminal where the `rept-stat-slk` or `rtrv-slk` commands were entered.
- Enter the `canc-cmd:trm=<xx>`, where `<xx>` is the terminal where the `rept-stat-slk` or `rtrv-slk` commands were entered, from another terminal other than the terminal where the `rept-stat-slk` or `rtrv-slk` commands were entered. To enter the `canc-cmd:trm=<xx>` command, the terminal must allow Security Administration commands to be entered from it and the user must be allowed to enter Security Administration commands. The terminal's permissions can be verified with the `rtrv-secu-trm` command. The user's permissions can be verified with the `rtrv-user` or `rtrv-secu-user` commands.

For more information about the `canc-cmd` command, go to the *Commands Manual*.

Procedure

1. Display the current signaling link configuration using the `rtrv-slk` command. This is an example of the possible output.

```
rlghncxa03w 05-09-19 21:16:37 GMT EAGLE5 34.0.0
      L2T          L1          PCR  PCR
LOC LINK LSN      SLC TYPE  SET  BPS  MODE TSET  ECM  N1  N2
1201 B   lsa1      0  LIMDS0  1   56000  ---  ---  BASIC ---  -----
1203 B   lsa2      0  LIMDS0  1   56000  ---  ---  BASIC ---  -----
1205 A   lsa3      0  LIMV35  3   64000  DCE  ON   BASIC ---  -----
1207 A   lsn1207a  0  LIMDS0  1   56000  ---  ---  BASIC ---  -----
1207 B   lsn1207b  0  LIMDS0  1   56000  ---  ---  BASIC ---  -----
1214 A   lsn1214a  0  LIMV35  2   64000  DTE  ---  PCR   76  3800
1214 B   lsa3      1  LIMV35  3   64000  DCE  ON   BASIC ---  -----

      LP          ATM
LOC LINK LSN      SLC TYPE  SET  BPS  TSEL  VCI  VPI  LL

      LP          ATM
LOC LINK LSN      SLC TYPE  SET  BPS  TSEL  VCI  VPI  CRC4 SI SN
E1ATM

No Links Set up.

LOC LINK LSN      SLC TYPE  IPLIML2

No Links Set up.

LOC LINK LSN      SLC TYPE

No Links Set up.
```

```

LOC LINK LSN          SLC TYPE          L2T          PCR PCR  E1  E1
SET BPS      ECM    N1  N2    LOC PORT TS

```

No Links Set up.

```

LOC LINK LSN          SLC TYPE          L2T          PCR PCR  T1  T1
SET BPS      ECM    N1  N2    LOC PORT TS

```

No Links Set up.

SLK table is (7 of 1200) 1% full.

NOTE: If the `rtrv-slk` output in step 1 shows that the maximum number of signaling links is 1500, skip step 2 and go to step 3.

NOTE: If the `rtrv-slk` output in step 1 shows that the maximum number of signaling links is 1200, and the signaling link being added increases the number beyond 1200, do not perform step 2, but go to “Enabling the Large System # Links Controlled Feature” procedure on page 3-10 and enable the Large System # Links controlled feature for 1500 signaling links. Then go to step 3.

NOTE: If the `rtrv-slk` output in step 1 shows that the maximum number of signaling links is 1200, and the signaling link being added will not increase the number beyond 1200, skip step 2 and go to step 3.

2. Display the status of the Large System # Links controlled feature by entering the `rtrv-ctrl-feat` command. The following is an example of the possible output.

```

rlghncxa03w 05-09-28 21:15:37 GMT EAGLE5 34.0.0
The following features have been permanently enabled:

```

Feature Name	Partnum	Status	Quantity
IPGWx Signaling TPS	893012814	on	20000
ISUP Normalization	893000201	on	----
Command Class Management	893005801	on	----
LNP Short Message Service	893006601	on	----
Intermed GTT Load Sharing	893006901	on	----
XGTT Table Expansion	893006101	off	----
XMAP Table Expansion	893007701	off	----
HC-MIM SLK Capacity	893012707	on	64

The following features have been temporarily enabled:

Feature Name	Partnum	Status	Quantity	Trial Period Left
Zero entries found.				

The following features have expired temporary keys:

Feature Name	Partnum
Zero entries found.	

If the Large System # Links controlled feature is not enabled or on, go to “Enabling the Large System # Links Controlled Feature” procedure on page 3-10 and enable Large System # Links controlled feature for 1500 signaling links. Then go to step 3.

3. Display the cards in the database using the `rtrv-card` command. This is an example of the possible output.

```
rlghncxa03w 05-09-28 09:12:36 GMT EAGLE5 34.0.0
CARD   TYPE      APPL      LSET NAME      LINK SLC LSET NAME      LINK SLC
1101   TSM         SCCP
1102   TSM         GLS
1113   GSPM       EOAM
1114   TDM-A
1115   GSPM       EOAM
1116   TDM-B
1117   MDAL
1201   LIMDS0     SS7ANSI     lsa1           B      0
1202   LIMV35     SS7ANSI
1203   LIMDS0     SS7ANSI     lsa2           B      0
1204   LIMDS0     SS7ANSI
1205   LIMV35     SS7ANSI     lsa3           A      0
1206   LIMV35     SS7ANSI
1207   LIMDS0     SS7ANSI     lsn1207a      A      0     lsn1207b      B      0
1208   LIMDS0     SS7ANSI
1212   LIMV35     SS7ANSI
1213   LIMDS0     SS7ANSI
1214   LIMV35     SS7ANSI     lsn1214a      A      0     lsa3           B      1
1215   LIMDS0     SS7ANSI
1301   LIMV35     ATMANSI
1302   LIMATM     ATMANSI
1304   LIMV35     SS7ANSI
1305   LIMATM     ATMANSI
1308   LIMV35     SS7ANSI
1311   LIMDS0     SS7ANSI
1313   LIMDS0     SS7ANSI
1315   LIMV35     CCS7ITU
1317   LIMV35     CCS7ITU
1318   LIMATM     ATMANSI
```

If the required card is not in the database, go to the “Adding an SS7 LIM” procedure in the *Database Administration Manual - System Management* and add the card to the database.

4. Display the current linkset configuration using the `rtrv-ls` command. This is an example of the possible output.

```
rlghncxa03w 05-09-10 11:43:04 GMT EAGLE5 34.0.0

LSN          APCA   (SS7)  SCRN  SET  SET  BEI  LST  LNKS  ACT  MES  DIS  SLSCI  NIS
e1e2         001-207-000  none  1   1   no  B   6   off off off no  off
ls1305       000-005-000  none  1   1   no  A   1   off off off no  off
ls1307       000-007-000  none  1   1   no  A   1   off off off no  off
e1m1s1       001-001-001  none  1   1   no  A   7   off off off no  off
e1m1s2       001-001-002  none  1   1   no  A   7   off off off no  off

LSN          APCA   (X25)  SCRN  SET  SET  BEI  LST  LNKS  ACT  MES  DIS  SLSCI  NIS

LSN          APCI   (SS7)  SCRN  SET  SET  BEI  LST  LNKS  ACT  MES  DIS  SLSCI  NIS
e1e2i        1-207-0     none  1   1   no  B   4   off off off ---  on
ls1315       0-015-0     none  1   1   no  A   1   off off off ---  off
ls1317       0-017-0     none  1   1   no  A   1   off off off ---  on
e1m2s1       1-011-1     none  1   1   no  A   7   off off off ---  off
e1m2s2       1-011-2     none  1   1   no  A   7   off off off ---  off
```

```

LSN          APCN   (SS7)  L3T SLT          GWS GWS GWS
SCRN  SET SET BEI LST LNKS ACT MES DIS SLSCI NIS

LSN          APCN24 (SS7)  L3T SLT          GWS GWS GWS
SCRN  SET SET BEI LST LNKS ACT MES DIS SLSCI NIS

LSN (CHINA)  APCN   (SS7)  L3T SLT          GWS GWS GWS
SCRN  SET SET BEI LST LNKS ACT MES DIS SLSCI NIS

LSN (CHINA)  APCN24 (SS7)  L3T SLT          GWS GWS GWS
SCRN  SET SET BEI LST LNKS ACT MES DIS SLSCI NIS

```

Link set table is (10 of 1024) 1% full.

If the required linkset is not in the database, go to the “Adding an SS7 Linkset” procedure on page 3-17 and add the linkset to the database.

-
5. Add the signaling link to the database using the `ent-slk` command. Use Table 3-10 on page 3-133 as a guide for the parameters that can be specified with the `ent-slk` command. For this example, enter these commands.

```

ent-slk:loc=1201:link=a:lsn=ls01:slc=0:l2tset=1
ent-slk:loc=1202:link=b:lsn=ls02:slc=0:l2tset=2:bps=64000
ent-slk:loc=1203:link=a:lsn=ls03:slc=0:l2tset=3
ent-slk:loc=1204:link=b:lsn=ls01:slc=1:l2tset=1
ent-slk:loc=1206:link=a:lsn=ls02:slc=1:l2tset=2:bps=64000
ent-slk:loc=1208:link=b:lsn=ls03:slc=1:l2tset=3
ent-slk:loc=1212:link=a:lsn=ls04:slc=1:l2tset=4:bps=64000
ent-slk:loc=1213:link=b:lsn=ls05:slc=0:l2tset=5
ent-slk:loc=1215:link=a:lsn=ls05:slc=1:l2tset=5
ent-slk:loc=1301:link=b:lsn=ls06:slc=0:l2tset=6:bps=56000
ent-slk:loc=1304:link=b:lsn=ls06:slc=1:l2tset=6:bps=56000
ent-slk:loc=1308:link=a:lsn=ls06:slc=2:l2tset=6:bps=56000
ent-slk:loc=1313:link=a:lsn=ls07:slc=0:l2tset=7
ent-slk:loc=1311:link=a:lsn=ls01:slc=2:l2tset=1
ent-slk:loc=1311:link=a1:lsn=ls05:slc=2:l2tset=5
ent-slk:loc=1311:link=b:lsn=ls03:slc=2:l2tset=3
ent-slk:loc=1311:link=b1:lsn=ls07:slc=1:l2tset=7
ent-slk:loc=1315:link=a:lsn=lsn5:slc=0:l2tset=11:bps=64000
ent-slk:loc=1317:link=a:lsn=lsi7:slc=0:l2tset=11:bps=64000

```

When each of these commands have successfully completed, this message should appear.

```

rlghncxa03w 05-09-07 08:29:03 GMT  EAGLE5 34.0.0
ENT-SLK: MASP A - COMPLTD

```

6. Verify the changes using the `rtv-slk` command. This is an example of the possible output.

```

rlghncxa03w 05-09-19 21:16:37 GMT EAGLE5 34.0.0

LOC LINK LSN          SLC TYPE      L2T          L1          PCR  PCR
                SET  BPS  MODE TSET  ECM  N1  N2
1201 A   ls01          0 LIMDS0      1   56000 --- --- BASIC --- 
1201 B   lsa1          0 LIMDS0      1   56000 --- --- BASIC --- 
1202 B   ls02          0 LIMV35      2   64000 DTE --- BASIC --- 
1203 A   ls03          0 LIMDS0      3   56000 --- --- BASIC --- 
1203 B   lsa2          0 LIMDS0      1   56000 --- --- BASIC --- 
1204 B   ls01          1 LIMDS0      1   56000 --- --- BASIC --- 
1205 A   lsa3          0 LIMV35      4   64000 DCE ON  BASIC --- 
1206 A   ls02          1 LIMV35      2   64000 DTE --- BASIC --- 
1207 A   lsn1207a      0 LIMDS0      1   56000 --- --- BASIC --- 
1207 B   lsn1207b      0 LIMDS0      1   56000 --- --- BASIC --- 
1208 B   ls03          1 LIMDS0      3   56000 --- --- BASIC --- 
1212 A   ls04          0 LIMV35      4   64000 DTE --- BASIC --- 
1213 B   ls05          0 LIMDS0      5   56000 --- --- BASIC --- 
1214 A   lsn1214a      0 LIMV35      2   64000 DTE --- PCR  76  3800
1214 B   lsa3          1 LIMV35      4   64000 DCE ON  BASIC --- 
1215 A   ls05          1 LIMDS0      5   56000 --- --- BASIC --- 
1301 B   ls06          0 LIMV35      6   56000 DTE --- BASIC --- 
1304 B   ls06          1 LIMV35      6   56000 DTE --- BASIC --- 
1308 A   ls06          2 LIMV35      6   56000 DTE --- BASIC --- 
1311 A   ls01          2 LIMDS0      1   56000 --- --- BASIC --- 
1311 A1  ls05          2 LIMDS0      5   56000 --- --- BASIC --- 
1311 B   ls03          2 LIMDS0      3   56000 --- --- BASIC --- 
1311 B1  ls07          1 LIMDS0      7   56000 --- --- BASIC --- 
1313 A   ls07          0 LIMDS0      7   56000 --- --- BASIC --- 
1315 A   lsn5          0 LIMV35     11   64000 DTE OFF  BASIC --- 
1317 A   lsi7          0 LIMV35     11   64000 DTE OFF  BASIC --- 

LOC LINK LSN          SLC TYPE      LP          ATM          VCI  VPI  LL
                SET  BPS  TSEL
No Links Set up.

LOC LINK LSN          SLC TYPE      LP          ATM          E1ATM
                SET  BPS  TSEL  VCI  VPI  CRC4 SI  SN
No Links Set up.

LOC LINK LSN          SLC TYPE      IPLIML2
No Links Set up.

LOC LINK LSN          SLC TYPE
No Links Set up.

LOC LINK LSN          SLC TYPE      L2T          PCR  PCR  E1  E1
                SET  BPS  ECM  N1  N2  LOC  PORT  TS
No Links Set up.

LOC LINK LSN          SLC TYPE      L2T          PCR  PCR  T1  T1
                SET  BPS  ECM  N1  N2  LOC  PORT  TS
No Links Set up.

SLK table is (31 of 1500) 3% full.

```

7. If any cards contain the first signaling link on a card, those cards must be brought into service with the `rst-card` command, specifying the location of the card. For this example, enter these commands.

```
rst-card:loc=1202
rst-card:loc=1204
rst-card:loc=1206
rst-card:loc=1208
rst-card:loc=1212
rst-card:loc=1213
rst-card:loc=1215
rst-card:loc=1301
rst-card:loc=1304
rst-card:loc=1308
rst-card:loc=1311
rst-card:loc=1313
rst-card:loc=1315
rst-card:loc=1317
```

When each of these commands have successfully completed, this message should appear.

```
rlghncxa03w 05-09-23 13:05:05 GMT EAGLE5 34.0.0
Card has been allowed.
```

8. Activate all signaling links on the cards using the `act-slk` command, specifying the card location and signaling link specified in step 5. For this example, enter these commands.

```
act-slk:loc=1201:link=a
act-slk:loc=1201:link=b
act-slk:loc=1202:link=b
act-slk:loc=1203:link=a
act-slk:loc=1203:link=b
act-slk:loc=1204:link=b
act-slk:loc=1206:link=a
act-slk:loc=1208:link=b
act-slk:loc=1212:link=a
act-slk:loc=1213:link=b
act-slk:loc=1215:link=a
act-slk:loc=1301:link=b
act-slk:loc=1304:link=b
act-slk:loc=1308:link=a
act-slk:loc=1311:link=a
act-slk:loc=1311:link=a1
act-slk:loc=1311:link=b
```

```
act-slk:loc=1311:link=b1
act-slk:loc=1313:link=a
act-slk:loc=1315:link=a
act-slk:loc=1317:link=a
```

When each of these commands have successfully completed, this message should appear.

```
rlghncxa03w 05-09-07 08:31:24 GMT EAGLE5 34.0.0
Activate Link message sent to card
```

9. Check the status of the signaling links added in step 8 using the **rept-stat-slk** command. The state of each signaling link should be in service normal (IS-NR) after the link has completed alignment (shown in the **PST** field). This is an example of the possible output.

```
rlghncxa03w 05-09-19 21:16:37 GMT EAGLE5 34.0.0
SLK      LSN      CLLI      PST      SST      AST
1201,A   ls01      ls01c1li  IS-NR    Avail    ----
1201,B   lsa1      -----  IS-NR    Avail    ----
1202,B   ls02      ls02c1li  IS-NR    Avail    ----
1203,A   ls03      ls03c1li  IS-NR    Avail    ----
1203,B   lsa2      -----  IS-NR    Avail    ----
1204,B   ls01      ls01c1li  IS-NR    Avail    ----
1205,A   lsa3      -----  IS-NR    Avail    ----
1206,A   ls02      ls02c1li  IS-NR    Avail    ----
1207,A   lsn1207a -----  IS-NR    Avail    ----
1207,B   lsn1207b -----  IS-NR    Avail    ----
1208,B   ls03      ls03c1li  IS-NR    Avail    ----
1212,A   ls04      ls04c1li  IS-NR    Avail    ----
1213,B   ls05      lsn5c1li  IS-NR    Avail    ----
1214,A   lsn1214a -----  IS-NR    Avail    ----
1214,B   lsa3      -----  IS-NR    Avail    ----
1215,A   ls05      lsn5c1li  IS-NR    Avail    ----
1301,B   ls06      ls06c1li  IS-NR    Avail    ----
1304,B   ls06      ls06c1li  IS-NR    Avail    ----
1308,A   ls06      ls06c1li  IS-NR    Avail    ----
1311,A   ls01      ls01c1li  IS-NR    Avail    ----
1311,A1  ls05      lsn5c1li  IS-NR    Avail    ----
1311,B   ls03      ls03c1li  IS-NR    Avail    ----
1311,B1  ls07      ls07c1li  IS-NR    Avail    ----
1313,A   ls07      ls07c1li  IS-NR    Avail    ----
1315,A   lsn5      -----  IS-NR    Avail    ----
1317,A   lsi7      -----  IS-NR    Avail    ----
```

10. Back up the new changes using the **chg-db:action=backup:dest=fixed** command. These messages should appear, the active Maintenance and Administration Subsystem Processor (MASP) appears first.

```
BACKUP (FIXED) : MASP A - Backup starts on active MASP.
BACKUP (FIXED) : MASP A - Backup on active MASP to fixed disk complete.
BACKUP (FIXED) : MASP A - Backup starts on standby MASP.
BACKUP (FIXED) : MASP A - Backup on standby MASP to fixed disk complete.
```

Flowchart 3-6. Adding an SS7 Signaling Link (Sheet 1 of 3)

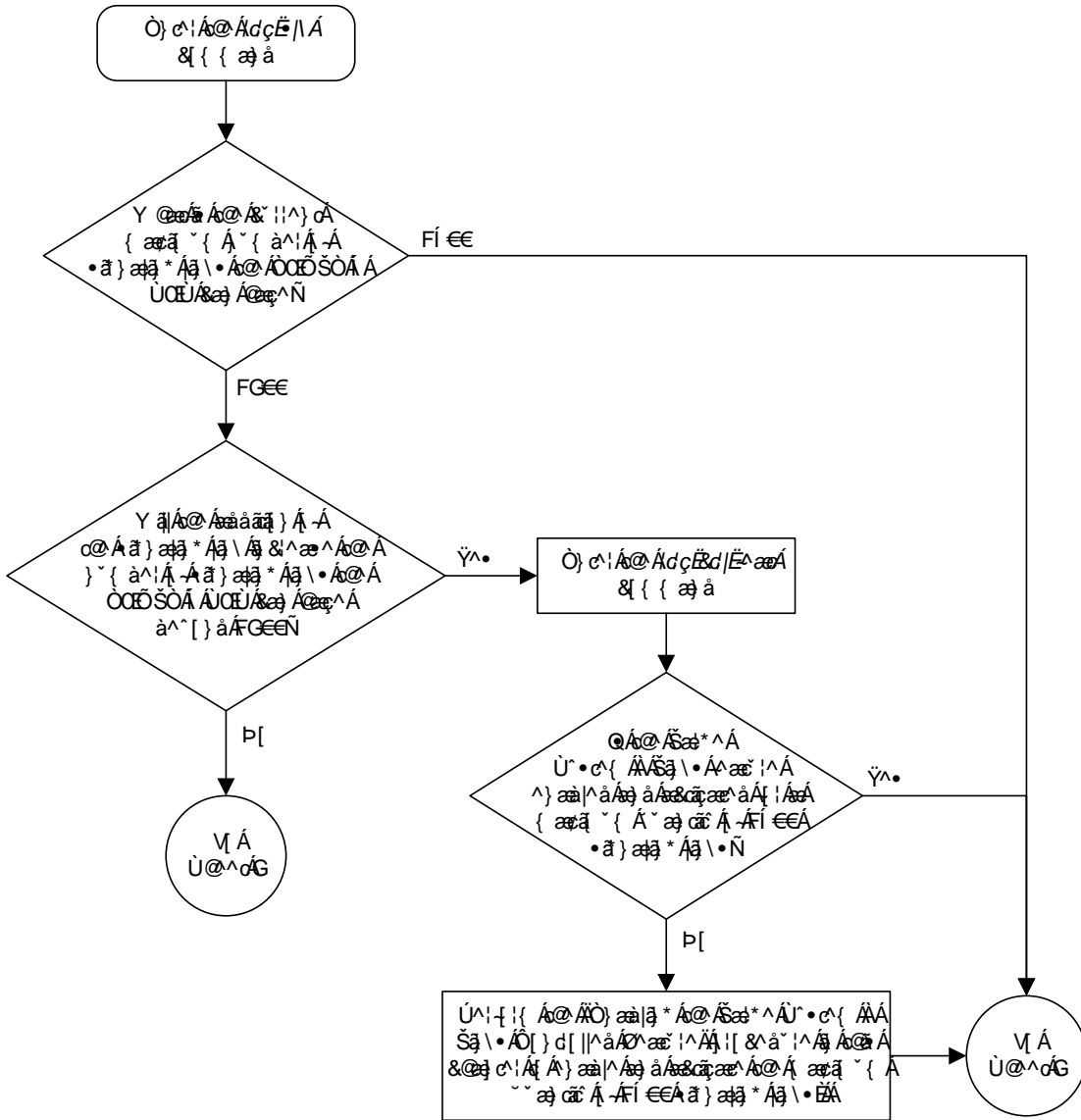

Flowchart 3-6. Adding an SS7 Signaling Link (Sheet 2 of 3)

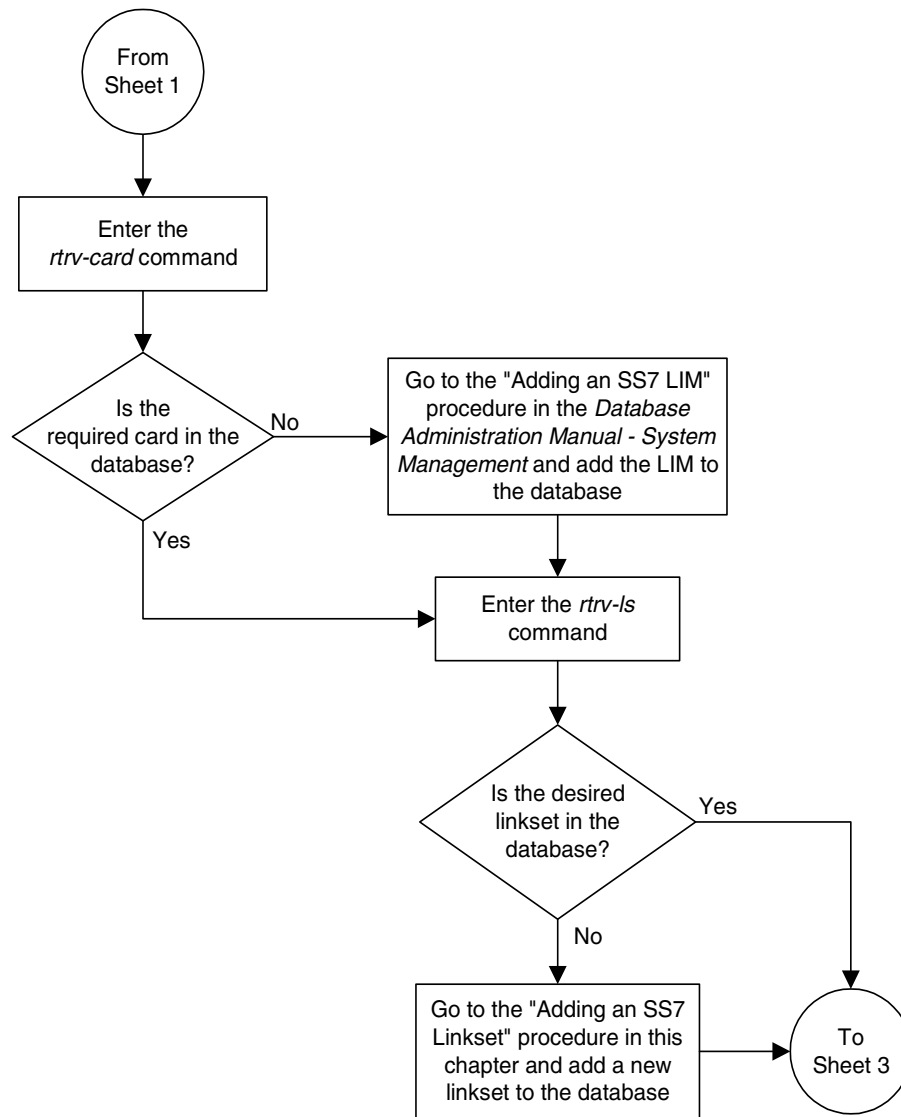

Flowchart 3-6. Adding an SS7 Signaling Link (Sheet 3 of 3)

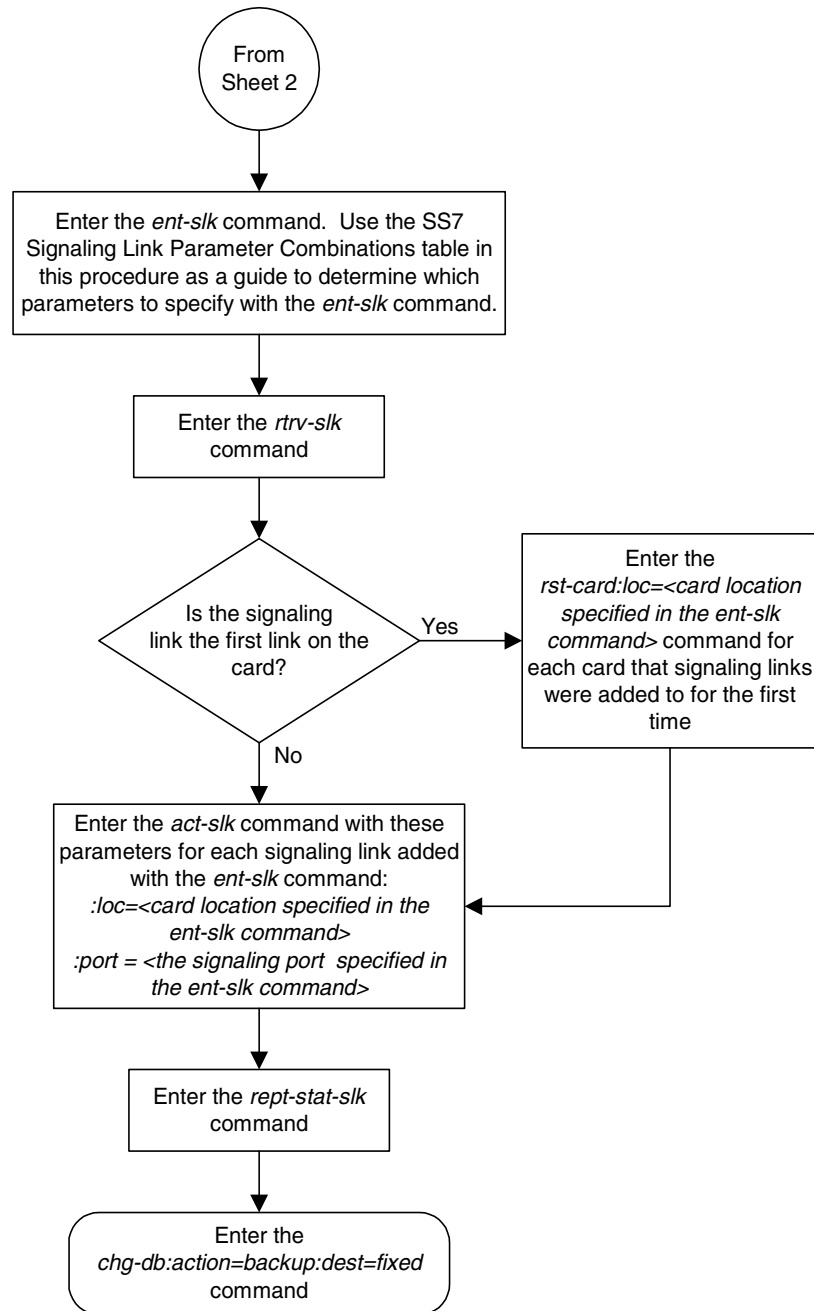

Removing an SS7 Signaling Link

This procedure is used to remove an SS7 low-speed, ATM, E1, E1 high-speed, or T1 signaling link from the database using the `dlt-slk` command. To remove other types of signaling links from the database, go to one of these procedures:

- An IP signaling link, go to the “Removing an IP Signaling Link” procedure in the *Database Administration Manual – IP⁷ Secure Gateway*.
- An X.25 signaling link, go to the “Removing an X.25 Signaling Link” procedure in the *Database Administration Manual – Features*.

The link to be removed must exist in the database. This can be verified in step 1.

The `dlt-slk` command uses these parameters.

- `:loc` – The card location of the LIM that the SS7 signaling link is assigned to.
- `:link` – The signaling link on the card specified in the `loc` parameter.
- `:force` – This parameter must be used to remove the last link in a linkset without having to remove all of the routes that referenced the linkset.

The `tfatcabmlq` parameter (TFA/TCA Broadcast Minimum Link Quantity), assigned to linksets, shows the minimum number of links in the given linkset (or in the combined link set in which it resides) that must be available for traffic. When the number of signaling links in the specified linkset is equal to or greater than the value of the `tfatcabmlq` parameter, the status of the routes that use the specified linkset is set to allowed and can carry traffic. Otherwise, these routes are restricted. The value of the `tfatcabmlq` parameter cannot exceed the total number of signaling links contained in the linkset.

The `dlt-slk` command makes sure that the number of signaling links assigned to a linkset is greater than or equal to the value of the `tfatcabmlq` parameter. If the number of signaling links associated with a linkset drops below the value of the `tfatcabmlq` parameter for that linkset, the `tfatcabmlq` value for that linkset is automatically decremented. The value of the `tfatcabmlq` parameter for a specified linkset can be verified using the `rtrv-ls:lsn=<linkset name>` command specifying the name of the linkset. The `tfatcabmlq` parameter value is shown in the `tfatcabmlq` field of the `rtrv-ls` command output.

The signaling link cannot be removed from the database if link fault sectionalization (LFS) tests are being performed on it. This can be verified using the `rept-stat-lfs` command.

Canceling the RTRV-SLK Command

Because the `rtrv-slk` command used in this procedure can output information for a long period of time, the `rtrv-slk` command can be canceled and the output to the terminal stopped. There are three ways that the `rtrv-slk` command can be canceled.

- Press the **F9** function key on the keyboard at the terminal where the `rtrv-slk` command was entered.
- Enter the `cancel-cmd` without the `trm` parameter at the terminal where the `rtrv-slk` command was entered.
- Enter the `cancel-cmd:trm=<xx>`, where `<xx>` is the terminal where the `rtrv-slk` command was entered, from another terminal other than the terminal where the `rtrv-slk` command was entered. To enter the `cancel-cmd:trm=<xx>` command, the terminal must allow Security Administration commands to be entered from it and the user must be allowed to enter Security Administration commands. The terminal's permissions can be verified with the `rtrv-secu-trm` command. The user's permissions can be verified with the `rtrv-user` or `rtrv-secu-user` commands.

For more information about the `cancel-cmd` command, go to the *Commands Manual*.

Procedure

1. Display the current link configuration using the `rtrv-slk` command. This is an example of the possible output.

```
rlghncxa03w 05-09-19 21:16:37 GMT EAGLE5 34.0.0
```

LOC	LINK	LSN	SLC	TYPE	L2T SET	BPS	L1 MODE	TSET	ECM	PCR N1	PCR N2
1201	A	ls01	0	LIMDS0	1	56000	---	---	BASIC	---	-----
1201	B	lsa1	0	LIMDS0	1	56000	---	---	BASIC	---	-----
1202	B	ls02	0	LIMV35	2	64000	DTE	---	BASIC	---	-----
1203	A	ls03	0	LIMDS0	3	56000	---	---	BASIC	---	-----
1203	B	lsa2	0	LIMDS0	1	56000	---	---	BASIC	---	-----
1204	A	ls01	1	LIMDS0	1	56000	---	---	BASIC	---	-----
1205	A	lsa3	0	LIMV35	4	64000	DCE	ON	BASIC	---	-----
1206	A	ls02	1	LIMV35	2	64000	DTE	---	BASIC	---	-----
1207	A	lsn1207a	0	LIMDS0	1	56000	---	---	BASIC	---	-----
1207	B	lsn1207b	0	LIMDS0	1	56000	---	---	BASIC	---	-----
1208	B	ls03	1	LIMDS0	3	56000	---	---	BASIC	---	-----
1212	A	ls04	0	LIMV35	4	64000	DTE	---	BASIC	---	-----
1213	B	ls05	0	LIMDS0	5	56000	---	---	BASIC	---	-----
1214	A	lsn1214a	0	LIMV35	2	64000	DTE	---	PCR	76	3800
1214	B	lsa3	1	LIMV35	4	64000	DCE	ON	BASIC	---	-----
1215	A	ls05	1	LIMDS0	5	56000	---	---	BASIC	---	-----
1301	B	ls06	0	LIMV35	6	56000	DTE	---	BASIC	---	-----
1304	B	ls06	1	LIMV35	6	56000	DTE	---	BASIC	---	-----
1308	A	ls06	2	LIMV35	6	56000	DTE	---	BASIC	---	-----
1311	A	ls01	2	LIMDS0	1	56000	---	---	BASIC	---	-----
1311	A1	ls05	2	LIMDS0	5	56000	---	---	BASIC	---	-----
1311	B	ls03	2	LIMDS0	3	56000	---	---	BASIC	---	-----
1311	B1	ls07	1	LIMDS0	7	56000	---	---	BASIC	---	-----
1313	A	ls07	0	LIMDS0	7	56000	---	---	BASIC	---	-----

SS7 Configuration

```

1315 A   lsn5           0 LIMV35  11  64000 DTE OFF  BASIC --- -----
1317 A   lsi7           0 LIMV35  11  64000 DTE OFF  BASIC --- -----

```

```

                LP           ATM
LOC LINK LSN      SLC TYPE  SET  BPS      TSEL      VCI      VPI      LL
1302 A   atmansi0    0 LIMATM  3  1544000 EXTERNAL  35      15      0
1305 A   atmansi1    0 LIMATM  4  1544000 INTERNAL  100     20      2
1318 A   atmansi0    1 LIMATM  9  1544000 LINE      150     25      4

```

```

                LP           ATM           E1ATM
LOC LINK LSN      SLC TYPE  SET  BPS      TSEL      VCI      VPI      CRC4  SI  SN
2101 A   atmitul    0 LIME1ATM 5  2.048M LINE    150     2      ON    1  20
2105 A   atmitul    1 LIME1ATM 5  2.048M LINE    35      15     ON    2  15

```

```

LOC LINK LSN      SLC TYPE      IPLIML2

```

No Links Set Up.

```

LOC LINK LSN      SLC TYPE

```

No Links Set Up.

```

                L2T           PCR  PCR      E1      E1
LOC LINK LSN      SLC TYPE  SET  BPS      ECM    N1   N2     LOC  PORT TS

```

No Links Set Up.

```

                L2T           PCR  PCR      T1      T1
LOC LINK LSN      SLC TYPE  SET  BPS      ECM    N1   N2     LOC  PORT TS

```

No Links Set Up.

SLK table is (31 of 1200) 3% full

2. Enter the **rept-stat-lfs** command to verify whether or not a link fault sectionalization test is being performed on the signaling link to be removed from the database. This is an example of the possible output.

```

rlghncxa03w 05-09-07 08:41:12 GMT EAGLE5 34.0.0
SLK      LBP  PATTERN      MAX-ERRORS  BIT_ERRORS  MAX-TIME  TEST-TIME
1201,A   5   B0247           56           30  01:00:00  00:00:50
1202,A   3   B511            56           27  01:00:00  00:01:05
1203,A   1   OCTET           56           12  01:00:00  00:02:07
1204,A   6   ALTERNATE       56           28  01:00:00  00:04:08
1205,A   2   B0247           56           36  01:00:00  00:03:05
1206,A   1   B0247           56           15  01:00:00  00:06:06
1207,A   3   B0247           56           19  01:00:00  00:02:04
1208,A   5   B0247           56           23  01:00:00  00:04:01
1208,B1  4   B0247           56           23  01:00:00  00:08:01

```

NOTE: If the `rept-stat-lfs` command output in step 2 shows that no LFS tests are being performed on the signaling link to be removed from the database, skip this step and go to step 4.

- Deactivate the LFS test being performed on the signaling link using the `dact-lbp` command, specifying the location signaling link being removed. For this example, enter this command.

```
dact-lbp:loc=1212:link=a
```

When this command has successfully completed, this message should appear.

```
rlghncxa03w 05-09-07 08:41:12 GMT EAGLE5 34.0.0
LOC = 1212 LINK = A
```

```
CLEAR STATUS = PASS, loop-back was cleared.
```

- Deactivate the link to be removed using the `dact-slk` command, using the output from step 1 to obtain the card location and signaling link information of the signaling link to be removed. For this example, enter this command.

```
dact-slk:loc=1212:link=a
```

When this command has successfully completed, this message should appear.

```
rlghncxa03w 05-09-07 08:41:12 GMT EAGLE5 34.0.0
Deactivate Link message sent to card
```

- Verify that the link is out of service - maintenance disabled (OOS-MT-DSBLD) using the `rept-stat-slk` command with the card location and signaling link. For this example, enter this command.

```
rept-stat-slk:loc=1212:link=a
```

This is an example of the possible output.

```
rlghncxa03w 05-09-23 13:06:25 GMT EAGLE5 34.0.0
SLK      LSN      CLLI      PST      SST      AST
1212,A  ls04      ls04clli  OOS-MT   Unavail  ----
  ALARM STATUS      = *   0235 REPT-LNK-MGTINH: local inhibited
  UNAVAIL REASON    = LI
```

- If the signaling link to be removed is the last signaling link on a card, the card must be inhibited before the signaling link is removed. Before entering the `dlt-slk` command, enter the `rmv-card` command and specify the location of the card to be inhibited. The card location is shown in the output of `rept-stat-slk` command executed in step 5. If the signaling link to be removed is not the last signaling link on the card, go to step 7.

In the example used for this procedure, the signaling link is the last signaling link on the card and must be inhibited. Enter this command.

```
rmv-card:loc=1212
```

When this command has successfully completed, this message should appear.

```
rlghncxa03w 05-09-07 08:41:12 GMT EAGLE5 34.0.0
Card has been inhibited.
```

SS7 Configuration

- Remove the signaling link from the EAGLE 5 SAS using the **dlt-slk** command. If there is only one signaling link in the linkset, the **force=yes** parameter must be specified to remove the signaling link.

In the example used in this procedure, the signaling link is the last signaling link in the linkset. Enter this command.

```
dlt-slk:loc=1212:link=a:force=yes
```

When this command has successfully completed, this message should appear.

```
rlghncxa03w 05-09-07 08:41:17 GMT EAGLE5 34.0.0
DLT-SLK: MASP A - COMPLTD
```

- Verify the changes using the **rtrv-slk** command. This is an example of the possible output.

```
rlghncxa03w 05-09-19 21:16:37 GMT EAGLE5 34.0.0
```

LOC	LINK	LSN	SLC	TYPE	SET	BPS	MODE	TSET	ECM	PCR	PCR
1201	A	ls01	0	LIMDS0	1	56000	---	---	BASIC	---	-----
1201	B	lsa1	0	LIMDS0	1	56000	---	---	BASIC	---	-----
1202	B	ls02	0	LIMV35	2	64000	DTE	---	BASIC	---	-----
1203	A	ls03	0	LIMDS0	3	56000	---	---	BASIC	---	-----
1203	B	lsa2	0	LIMDS0	1	56000	---	---	BASIC	---	-----
1204	B	ls01	1	LIMDS0	1	56000	---	---	BASIC	---	-----
1205	A	lsa3	0	LIMV35	4	64000	DCE	ON	BASIC	---	-----
1206	A	ls02	1	LIMV35	2	64000	DTE	---	BASIC	---	-----
1207	A	lsn1207a	0	LIMDS0	1	56000	---	---	BASIC	---	-----
1207	B	lsn1207b	0	LIMDS0	1	56000	---	---	BASIC	---	-----
1208	B	ls03	1	LIMDS0	3	56000	---	---	BASIC	---	-----
1213	B	ls05	0	LIMDS0	5	56000	---	---	BASIC	---	-----
1214	A	lsn1214a	0	LIMV35	2	64000	DTE	---	PCR	76	3800
1214	B	lsa3	1	LIMV35	4	64000	DCE	ON	BASIC	---	-----
1215	A	ls05	1	LIMDS0	5	56000	---	---	BASIC	---	-----
1301	B	ls06	0	LIMV35	6	56000	DTE	---	BASIC	---	-----
1304	B	ls06	1	LIMV35	6	56000	DTE	---	BASIC	---	-----
1308	A	ls06	2	LIMV35	6	56000	DTE	---	BASIC	---	-----
1311	A	ls01	2	LIMDS0	1	56000	---	---	BASIC	---	-----
1311	A1	ls05	2	LIMDS0	5	56000	---	---	BASIC	---	-----
1311	B	ls03	2	LIMDS0	3	56000	---	---	BASIC	---	-----
1311	B1	ls07	1	LIMDS0	7	56000	---	---	BASIC	---	-----
1313	A	ls07	0	LIMDS0	7	56000	---	---	BASIC	---	-----
1315	A	lsn5	0	LIMV35	11	64000	DTE	OFF	BASIC	---	-----
1317	A	lsi7	0	LIMV35	11	64000	DTE	OFF	BASIC	---	-----

LOC	LINK	LSN	SLC	TYPE	SET	BPS	ATM	VCI	VPI	LL
1302	A	atmansio	0	LIMATM	3	1544000	EXTERNAL	35	15	0
1305	A	atmansil	0	LIMATM	4	1544000	INTERNAL	100	20	2
1318	A	atmansio	1	LIMATM	9	1544000	LINE	150	25	4

LOC	LINK	LSN	SLC	TYPE	SET	BPS	ATM	VCI	VPI	CRC4	SI	SN
2101	A	atmitul	0	LIME1ATM	5	2.048M	LINE	150	2	ON	1	20
2105	A	atmitul	1	LIME1ATM	5	2.048M	LINE	35	15	ON	2	15

LOC	LINK	LSN	SLC	TYPE	IPLIML2
No Links Set up.					

```

LOC LINK LSN          SLC TYPE

LOC LINK LSN          SLC TYPE          L2T          PCR PCR  E1  E1
SET BPS          ECM  N1  N2  LOC PORT TS

No Links Set up.

LOC LINK LSN          SLC TYPE          L2T          PCR PCR  T1  T1
SET BPS          ECM  N1  N2  LOC PORT TS

No Links Set up.

SLK table is (31 of 1200) 3% full

```

-
9. Back up the new changes using the **chg-db:action=backup:dest=fixed** command. These messages should appear, the active Maintenance and Administration Subsystem Processor (MASP) appears first.

```

BACKUP (FIXED) : MASP A - Backup starts on active MASP.
BACKUP (FIXED) : MASP A - Backup on active MASP to fixed disk complete.
BACKUP (FIXED) : MASP A - Backup starts on standby MASP.
BACKUP (FIXED) : MASP A - Backup on standby MASP to fixed disk complete.

```

Flowchart 3-7. Removing an SS7 Signaling Link (Sheet 1 of 2)

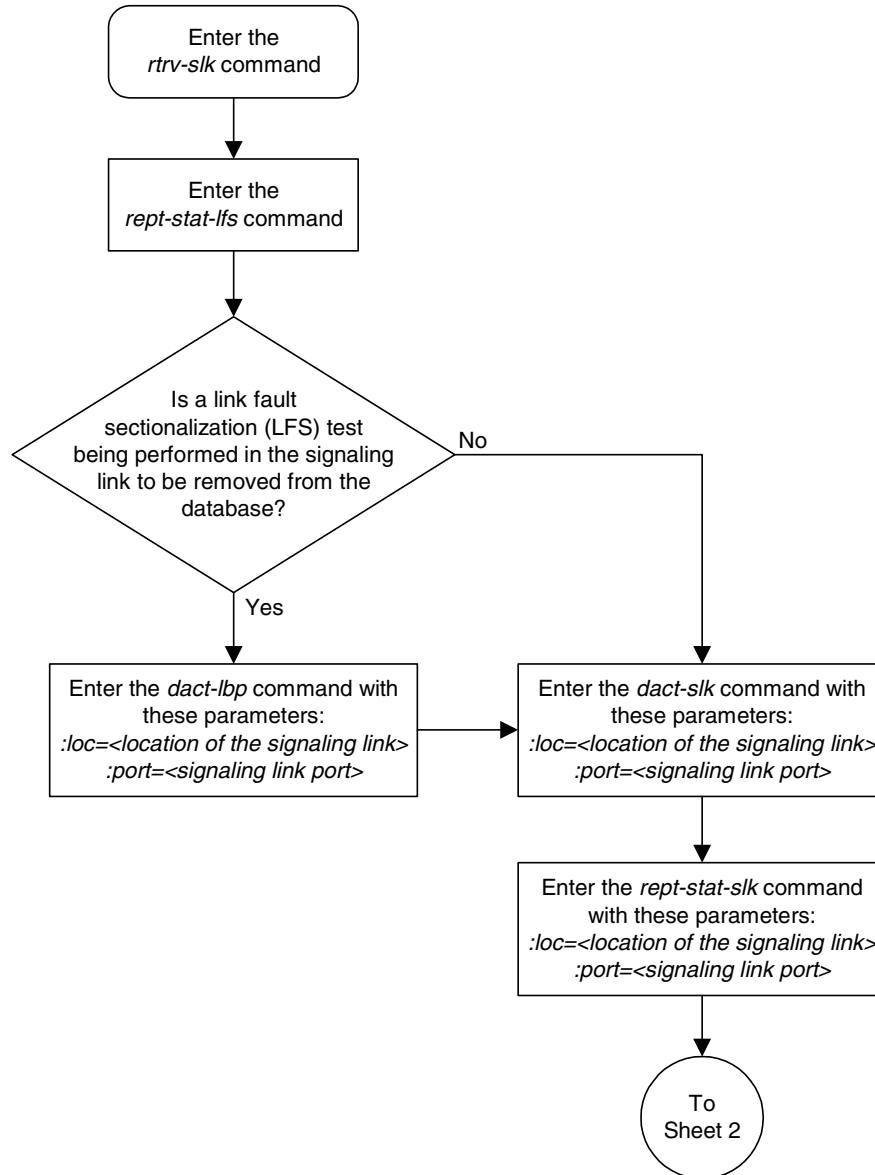

Flowchart 3-7. Removing an SS7 Signaling Link (Sheet 2 of 2)

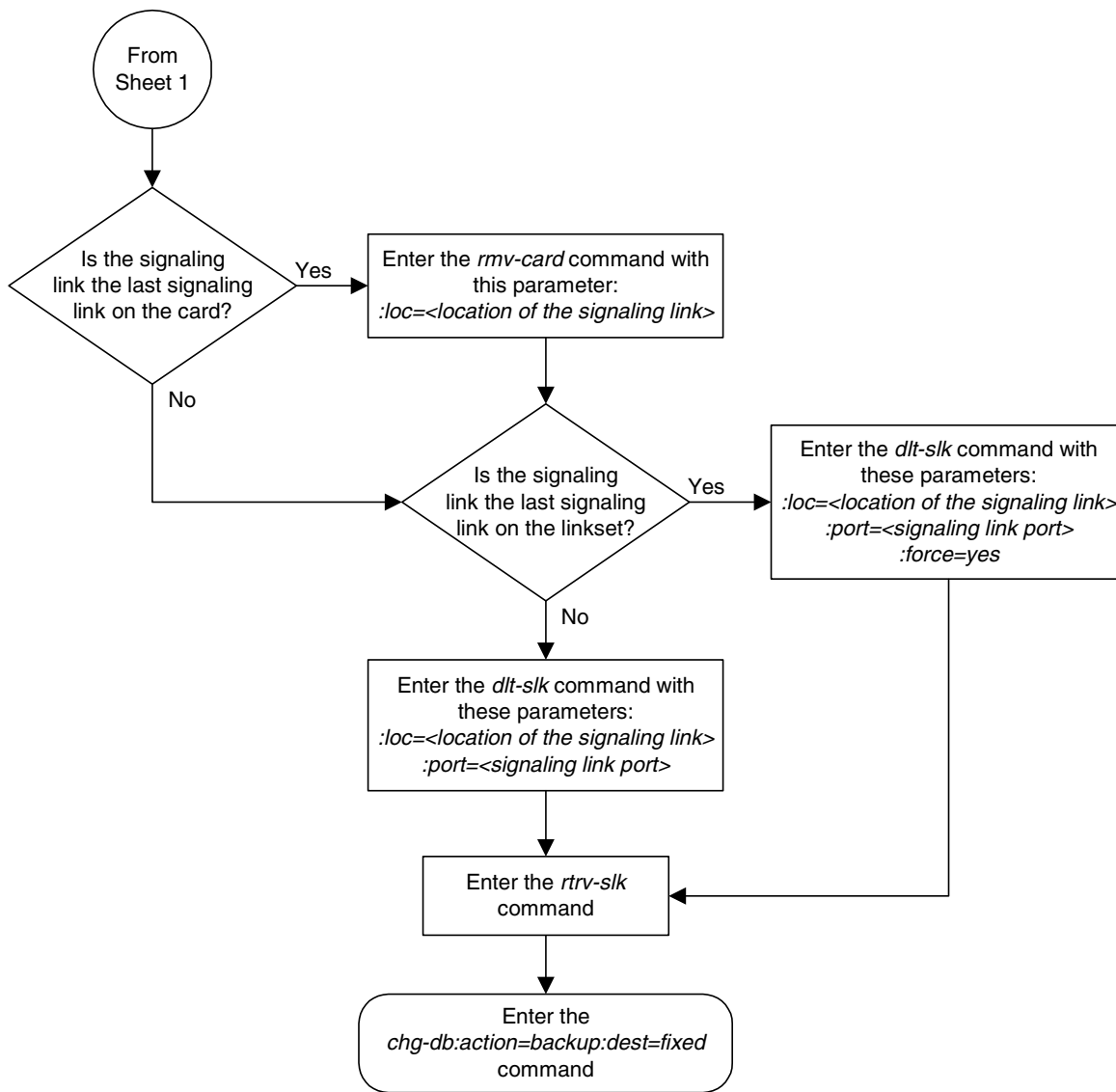

Adding a Route Containing an SS7 DPC

This procedure is used to add a route containing an SS7 DPC to the database using the `ent-rte` command. The routes configured in this procedure do not contain cluster point codes or X.25 point codes as DPCs, or IPGWx linksets. These routes are configured in these procedures:

- “Adding a Route Containing a Cluster Point Code” on page 3-164
- “Adding a Route Containing an IPGWx Linkset” on page 3-172
- “Adding a Route Containing an X.25 DPC” on page 3-181.

The `ent-rte` command uses these parameters.

`:dpc/dpca/dpci/dpcn/dpcn24` – The destination point code of the node that the traffic is bound for.

NOTE: See “Point Code Formats” on page 2-4 for a definition of the point code types that are used on the EAGLE 5 SAS and for a definition of the different formats that can be used for ITU national point codes.

`:lsn` – The name of the linkset that will carry the traffic bound for the node specified by the destination point code.

`:rc` – The relative cost (priority) for this route.

`:force` – This parameter allows a route to be added to the database even if the linkset to be assigned to the route does not have any signaling links in it.

These items must be configured in the database before a route can be added in this procedure:

- Destination point code (DPC) – see one of these procedures depending on the type of point code required:
 - For a Network Routing DPC – “Adding a Network Routing Point Code” on page 2-181.
 - For all other DPCs – “Adding a Destination Point Code” on page 2-191
- Linkset – see “Adding an SS7 Linkset” on page 3-17
- Link – see “Adding an SS7 Signaling Link” on page 3-130

The linkset assigned to this route must have an adjacent point code (APC) in the SS7 domain. The domain of the DPC is shown in the **DOMAIN** field in the output of the `rtrv-dstn` command.

The DPC of the route must be of the same format as the APC of the linkset being added to the route. That is, routes containing ANSI DPCs must have linksets with ANSI APCs; routes containing ITU-I DPCs must have linksets with ITU-I APCs; routes containing 14-bit ITU-N DPCs must have linksets with 14-bit ITU-N APCs; routes containing 24-bit ITU-N DPCs must have linksets with 24-bit ITU-N APCs. The DPC of the route must be defined as a true point code in the **rtrv-dstn** output. Alias point codes and secondary point codes cannot be used. True point codes are shown in the output of the **rtrv-dstn** command in the **DPCA**, **DPCI**, **DPCN**, or **DPCN24** fields. Private point codes cannot be used as the DPC of a route in this procedure. Routes that have private point codes as the DPC of a route can contain only IPGWx linksets. Perform the “Adding a Route Containing an IPGWx Linkset” on page 3-172 to add routes containing IPGWx linksets.

The DPC of the route is the destination point code to be reached by the route and is shown in the output of the **rtrv-rte** command in the **DPCA**, **DPCI**, **DPCN**, or **DPCN24** fields.

The **APCA**, **APCI**, **APCN**, and **APCN24** fields in the output of the **rtrv-rte** command show the point code of the node that is directly adjacent to the node in the route.

A linkset can only be entered once as a route for each DPC.

A maximum of six routes can be defined for each DPC.

A maximum of two linksets can be assigned the same cost. The cost of the route is defined by the **rc** parameter of the **ent-rte** command and is shown in the **RC** field in the output of the **rtrv-rte** command.

The **force=yes** parameter must be specified if the specified linkset has no signaling links assigned to it. Otherwise, each linkset must have at least one signaling link assigned to it.

The ANSI DPC (DPC/DPCA) of the route can use either a full point code or a network routing point code. ITU DPCs (DPCI, DPCN, and DPCN24) must use full point codes. For more information on network routing point codes, go to the “Network Routing” section on page 2-174.

If the DPC of the route is a member of a cluster point code, and the nested cluster allowed indicator (**ncal** parameter of either the **ent-dstn** or **chg-dstn** command) is set to no, then the route to the DPC must be the same as the route to the cluster point code. If the nested cluster allowed indicator is set to yes, the route to the member of the cluster does not have to be the same as the route to the cluster point code. For more information, see the “Nested Cluster Routing” section on page 2-135.

For routes containing 14-bit ITU National DPCs with group codes, if the linkset assigned to the route has the **MULTGTC** value set to **yes**, then 14-bit ITU National DPCs with group codes that are different from the linkset APC group code can be assigned to the route. If the **MULTGTC** value is set to **no**, then only 14-bit ITU National DPCs with group codes that are the same as the linkset APC group code can be assigned to the route.

Canceling the RTRV-LS, RTRV-DSTN, and RTRV-RTE Commands

Because the `rtrv-ls`, `rtrv-dstn`, and `rtrv-rte` commands used in this procedure can output information for a long period of time, the `rtrv-ls`, `rtrv-dstn`, and `rtrv-rte` commands can be canceled and the output to the terminal stopped. There are three ways that the `rtrv-ls`, `rtrv-dstn`, and `rtrv-rte` commands can be canceled.

- Press the **F9** function key on the keyboard at the terminal where the `rtrv-ls`, `rtrv-dstn`, or `rtrv-rte` commands were entered.
- Enter the `canc-cmd` without the `trm` parameter at the terminal where the `rtrv-ls`, `rtrv-dstn`, or `rtrv-rte` commands were entered.
- Enter the `canc-cmd:trm=<xx>`, where `<xx>` is the terminal where the `rtrv-ls`, `rtrv-dstn`, or `rtrv-rte` commands were entered, from another terminal other than the terminal where the `rtrv-ls`, `rtrv-dstn`, or `rtrv-rte` commands were entered. To enter the `canc-cmd:trm=<xx>` command, the terminal must allow Security Administration commands to be entered from it and the user must be allowed to enter Security Administration commands. The terminal's permissions can be verified with the `rtrv-secu-trm` command. The user's permissions can be verified with the `rtrv-user` or `rtrv-secu-user` commands.

For more information about the `canc-cmd` command, go to the *Commands Manual*.

Procedure

1. Display the current route configuration using the `rtrv-rte` command. This is an example of the possible output.

```
rlghncxa03w 05-09-07 11:43:04 GMT EAGLE5 34.0.0
  DPCA          ALIASI      ALIASN/N24    LSN           RC           APCA
  140-012-004   1-111-1      10-13-12-1   ls000001      10           240-012-002
                                     ls000002      10           240-012-002
                                     ls000003      20           240-012-002
                                     ls000004      30           240-012-002
                                     ls000005      40           240-012-002
                                     ls000006      50           240-012-002
                                     CLLI=dp1
  140-012-005  1-111-2     10-13-12-2   ls000001      10           240-012-002
                                     ls000002      10           240-012-002
                                     ls000003      20           240-012-002
                                     ls000004      30           240-012-002
                                     ls000005      40           240-012-002
                                     ls000006      50           240-012-002
                                     CLLI=dp2
  DPCI          ALIASN/N24    ALIASA       LSN           RC           APC
  2-234-5       11-13-3-3    240-111-111  ls100001      10           1-234-5
                                     ls100002      10           1-234-6
                                     ls100003      20           1-234-7
                                     ls100004      30           1-234-1
                                     ls100005      40           1-234-2
                                     ls100006      50           1-234-3
```

```

CLLI=idp1
DPCN          ALIASA          ALIASI  LSN          RC      APC
12-12-13-3    011-222-111    0-001-1  ls200001    10     10-13-9-3
              011-222-111    0-001-1  ls200002    10     10-13-10-0
              011-222-111    0-001-1  ls200003    20     10-13-10-1
              011-222-111    0-001-1  ls200004    30     10-13-10-2
              011-222-111    0-001-1  ls200005    40     10-13-10-3
              011-222-111    0-001-1  ls200006    50     10-13-11-0
CLLI=ndp1
DPCN24        ALIASA          ALIASI  LSN          RC      APC

```

2. Verify that the destination point code of the route is in the destination point code table by using the `rtrv-dstn` command. This is an example of the possible output.

```

rlghncxa03w 05-09-10 11:43:04 GMT EAGLE5 34.0.0
DPCA          CLLI          BEI  ELEI  ALIASI          ALIASN/N24  DOMAIN
001-002-003   ls04ccli     yes  ---  -----  -----  SS7
001-002-003   ls04ccli     yes  ---  -----  -----  SS7
002-002-100   ls01ccli     no   ---  -----  -----  SS7
002-007-008   ls06ccli     yes  ---  -----  -----  SS7
002-009-003   -----     no   ---  -----  -----  SS7
002-250-010   -----     no   ---  -----  -----  SS7
003-003-003   ls03ccli     yes  ---  -----  -----  SS7
003-020-100   -----     no   ---  -----  -----  SS7
004-004-004   ls02ccli     yes  ---  -----  -----  SS7
004-030-200   -----     no   ---  -----  -----  SS7
009-002-003   -----     no   ---  -----  -----  SS7
179-100-087   -----     yes  ---  -----  -----  SS7
200-050-176   -----     yes  ---  -----  -----  SS7
240-007-000   -----     yes  ---  -----  -----  SS7
240-012-004   rlghncbb001  yes  ---  1-111-1      11111      SS7
240-012-005   rlghncbb002  yes  ---  1-112-2      11112      SS7
240-012-006   rlghncbb003  yes  ---  1-112-3      11113      SS7
240-012-008   -----     yes  ---  1-113-5      11114      SS7
244-010-004   ls06ccli     no   ---  -----  -----  X25
244-012-005   ls07ccli     no   ---  -----  -----  X25
244-012-006   ls08ccli     no   ---  -----  -----  X25
244-012-007   -----     no   ---  -----  -----  X25
244-012-008   -----     no   ---  -----  -----  X25

DPCI          CLLI          BEI  ELEI  ALIASA          ALIASN/N24  DOMAIN
2-131-1       rlghncbb023  no   ---  222-210-000  12001      SS7
2-131-2       -----     no   ---  222-211-001  12002      SS7
2-131-3       -----     no   ---  222-211-002  12003      SS7
3-150-4       lsi7ccli     yes  ---  -----  -----  SS7

DPCN          CLLI          BEI  ELEI  ALIASA          ALIASI       DOMAIN
10685        lsn5ccli     yes  ---  -----  -----  SS7
11211        rlghncbb013  no   ---  222-200-200  2-121-1     SS7
11212        rlghncbb013  no   ---  222-200-201  2-121-2     SS7

DPCN24        CLLI          BEI  ELEI  ALIASA          ALIASI       DOMAIN

```

Destination table is (29 of 2000) 1% full

If the destination point code of the route being added in this procedure is not shown in the `rtrv-rte` and `rtrv-dstn` outputs, go to one of these procedures

in Chapter 2 and add the destination point code of the route to the destination point code table.

- For a Network Routing DPC – “Adding a Network Routing Point Code” on page 2-181.
- For all other DPCs – “Adding a Destination Point Code” on page 2-191

NOTE: If cluster point codes are not shown in steps 1 and 2, or if the DPC of the route being added is not a member of the cluster point code, skip this step and go to step 4.

3. Display the `ncai` parameter value assigned to the cluster point code using the `rtrv-dstn` command and specifying the cluster point code. If the `ncai` parameter value is `no`, then the route to the DPC must be the same as the route to the cluster point code. If the `ncai` parameter value is `yes`, the route to the member of the cluster does not have to be the same as the route to the cluster point code. The `ncai` value is shown in the `NCAI` field of the `rtrv-dstn` output. For this example, enter this command.

```
rtrv-dstn:dpc=111-011-*
```

This is an example of the possible output.

```
rlghncxa03w 05-09-28 21:16:37 GMT EAGLE5 34.0.0
  DPCA          CLLI          BEI ELEI  ALIASI          ALIASN/N24  DOMAIN
  111-011-*     rlghncbb000 yes yes  -----  -----  SS7

          SPC          NCAI
          -----  yes
```

Destination table is (12 of 2000) 1% full

If the `ncai` parameter value of the cluster point code is `no`, and you wish to change the `ncai` parameter value to `yes`, perform the “Changing the Attributes of a Cluster Point Code” procedure on page 2-161. If the `ncai` parameter value of the cluster point code is `no`, and you do not wish to change the `ncai` parameter value to `yes`, add a new DPC for the route by performing either the “Adding a Destination Point Code” procedure on page 2-191 or the “Adding a Network Routing Point Code” procedure on page 2-181.

4. Verify that the required linkset for the route is in the database by displaying the linksets in the database with the `rtrv-ls` command. This is an example of the possible output.

```
rlghncxa03w 05-09-10 11:43:04 GMT EAGLE5 34.0.0

          L3T SLT          GWS GWS GWS
LSN      APCA  (SS7)  SCRN SET SET BEI LST LNKS ACT MES DIS SLSCI NIS
ele2     001-207-000  none 1 1 no B 6 off off off no off
ls1305   000-005-000  none 1 1 no A 1 off off off no off
ls1307   000-007-000  none 1 1 no A 1 off off off no off
lsn7     002-002-002  none 1 1 no C 8 off off off no off
elm1s1   001-001-001  none 1 1 no A 7 off off off no off
elm1s2   001-001-002  none 1 1 no A 7 off off off no off
```

```

LSN          APCA   (X25)   SCR N SET SET BEI LST LNKS ACT MES DIS SLSCI NIS
                L3T SLT                GWS GWS GWS
LSN          APCI   (SS7)   SCR N SET SET BEI LST LNKS ACT MES DIS SLSCI NIS
ele2i        1-207-0   none 1  1  no  B  4  off off off --- on
ls1315       0-015-0   none 1  1  no  A  1  off off off --- off
ls1317       0-017-0   none 1  1  no  A  1  off off off --- on
ls7890       7-089-0   none 1  2  no  B  1  off off off --- off
e1m2s1      1-011-1   none 1  1  no  A  7  off off off --- off
e1m2s2      1-011-2   none 1  1  no  A  7  off off off --- off

LSN          APCN   (SS7)   SCR N SET SET BEI LST LNKS ACT MES DIS SLSCI NIS
                L3T SLT                GWS GWS GWS
LSN          APCN24 (SS7)   SCR N SET SET BEI LST LNKS ACT MES DIS SLSCI NIS
                L3T SLT                GWS GWS GWS
LSN (CHINA) APCN   (SS7)   SCR N SET SET BEI LST LNKS ACT MES DIS SLSCI NIS
                L3T SLT                GWS GWS GWS
LSN (CHINA) APCN24 (SS7)   SCR N SET SET BEI LST LNKS ACT MES DIS SLSCI NIS
                L3T SLT                GWS GWS GWS

```

Link set table is (12 of 1024) 1% full.

If the required linkset is not in the database, perform the “Adding an SS7 Linkset” procedure on page 3-17 and add the linkset to the database with the **ipgwapc=no** parameter value. The APC of the linkset cannot be a private point code. Skip step 5 and go to step 6.

5. Display each linkset being assigned to the route to verify the **multgc** and **ipgwapc** parameter values with the **rtrv-ls** command, specifying the name of the linkset that will be assigned to the route.

If the **multgc** linkset parameter value is **yes**, then 14-bit ITU National DPCs with group codes that are different from the linkset APC group code can be assigned to the route. If the **multgc** value is set to **no**, then only 14-bit ITU National DPCs with group codes that are the same as the linkset APC group code can be assigned to the route. The **multgc** value is shown in the **MULTGC** field of the **rtrv-ls** output.

Linksets that have the **ipgwapc=yes** parameter value are assigned to routes using the “Adding a Route Containing an IPGWx Linkset” procedure on page 3-172. If the linkset displayed in this step contains the **ipgwapc=yes** parameter, repeat this step with another linkset shown in step 4. If all the linksets have been displayed, and the **ipgwapc** value for all the linksets is **yes**, add the desired linkset by performing the “Adding an SS7 Linkset” procedure on page 3-17 with the **ipgwapc=no** parameter value. The APC of the linkset cannot be a private point code.

For this example, enter the following commands.

```
rtrv-ls:lsn=lsn7
```

This is an example of the possible output.

SS7 Configuration

rlghncxa03w 05-09-17 11:43:04 GMT EAGLE5 34.0.0

```

LSN          APCA  (SS7)  SCRN SET SET BEI LST LNKS ACT MES DIS SLSCI NIS
lsn7        002-002-002  none 1  1  no  C  8  off off off no  off
    
```

```

CLLI          TFATCABMLQ MTPRSE ASL8 GSMSCRN
----- 4          ---  no  off
    
```

```

IPGWAPC MATELSN  IPTPS LSUSEALM SLKUSEALM
no  -----  ---  ---  ---
    
```

LOC	PORT	SLC	TYPE	L2T SET	BPS	L1 MODE	TSET	ECM	PCR N1	PCR N2
1211	A	0	LIMDS0	1	56000	---	---	BASIC	---	---
1211	B	1	LIMDS0	1	56000	---	---	BASIC	---	---
1211	A1	2	LIMDS0	1	56000	---	---	BASIC	---	---
1211	A2	3	LIMDS0	1	56000	---	---	BASIC	---	---
1211	B2	4	LIMDS0	1	56000	---	---	BASIC	---	---
1211	B1	5	LIMDS0	1	56000	---	---	BASIC	---	---
1211	B3	6	LIMDS0	1	56000	---	---	BASIC	---	---
1211	A3	7	LIMDS0	1	56000	---	---	BASIC	---	---

LOC	PORT	SLC	TYPE	LP SET	BPS	ATM TSEL	VCI	VPI	LL

LOC	PORT	SLC	TYPE	LP SET	BPS	ATM TSEL	VCI	VPI	CRC4	SI	SN

LOC PORT SLC TYPE IPLIML2

LOC PORT SLC TYPE

LOC	PORT	SLC	TYPE	L2T SET	BPS	ECM	PCR N1	PCR N2	E1 LOC	E1 PORT	TS

LOC	PORT	SLC	TYPE	L2T SET	BPS	ECM	PCR N1	PCR N2	T1 LOC	T1 PORT	TS

Link set table is (12 of 1024) 1% full.

rtrv-ls:lsn=ls7890

rlghncxa03w 05-09-17 11:43:04 GMT EAGLE5 34.0.0

```

LSN          APCI  (SS7)  SCRN SET SET BEI LST LNKS ACT MES DIS SLSCI NIS
ls7890      7-089-0  none 1  2  no  B  1  off off off ---  off
    
```

```

CLLI          TFATCABMLQ MTPRSE ASL8 SLSRSB MULTGC ITUTFR
dtaclli      1          ---  ---  1  no  off
    
```

```

GSMSCRN
off
    
```

```

IPGWAPC MATELSN  IPTPS LSUSEALM SLKUSEALM
no  -----  ---  ---  ---
    
```

LOC	PORT	SLC	TYPE	L2T SET	BPS	L1 MODE	TSET	ECM	PCR N1	PCR N2
1103	A	0	LIMDS0	11	56000	---	---	BASIC	---	---

LOC	PORT	SLC	TYPE	LP SET	BPS	ATM TSEL	VCI	VPI	LL

```

          LP      ATM      E1ATM
LOC  PORT  SLC  TYPE  SET  BPS  TSEL  VCI  VPI  CRC4  SI  SN

LOC  PORT  SLC  TYPE  IPLIML2

LOC  PORT  SLC  TYPE

          L2T      PCR  PCR  E1  E1
LOC  PORT  SLC  TYPE  SET  BPS  ECM  N1  N2  LOC  PORT  TS

          L2T      PCR  PCR  T1  T1
LOC  PORT  SLC  TYPE  SET  BPS  ECM  N1  N2  LOC  PORT  TS

```

Link set table is (12 of 1024) 1% full.

6. Add the route using the **ent-rte** command. For this example, enter these commands.

```

ent-rte:dpca=002-002-200:lsn=lsn7:rc=10
ent-rte:dpci=7-089-0:lsn=ls7890:rc=20

```

When each of these commands have successfully completed, this message should appear.

```

rlghncxa03w 05-09-07 08:28:30 GMT  EAGLE5 34.0.0
ENT-RTE: MASP A - COMPLTD

```

7. Verify the changes using the **rtrv-rte** command, specifying the destination point code of the route. For this example, enter these commands.

```

rtrv-rte:dpca=002-002-200

```

This is an example of the possible output.

```

rlghncxa03w 05-09-07 11:43:04 GMT  EAGLE5 34.0.0

DPCA      ALIASI      ALIASN/N24  LSN      RC      APCA
002-002-002 ----- -----          lsn7      10      002-002-002
CLLI=-----

```

```

rtrv-rte:dpci=7-089-0:lsn=ls7890:rc=20

```

This is an example of the possible output.

```

rlghncxa03w 05-09-07 11:43:04 GMT  EAGLE5 34.0.0

DPCI      ALIASN/N24      ALIASA      LSN      RC      APC
7-089-0 ----- -----          ls7890    10      7-089-0
CLLI=dtaclli

```

8. Back up the new changes using the **chg-db:action=backup:dest=fixed** command. These messages should appear, the active Maintenance and Administration Subsystem Processor (MASP) appears first.

```

BACKUP (FIXED) : MASP A - Backup starts on active MASP.
BACKUP (FIXED) : MASP A - Backup on active MASP to fixed disk complete.
BACKUP (FIXED) : MASP A - Backup starts on standby MASP.
BACKUP (FIXED) : MASP A - Backup on standby MASP to fixed disk complete.

```

Flowchart 3-8. Adding a Route Containing an SS7 DPC (Sheet 1 of 3)

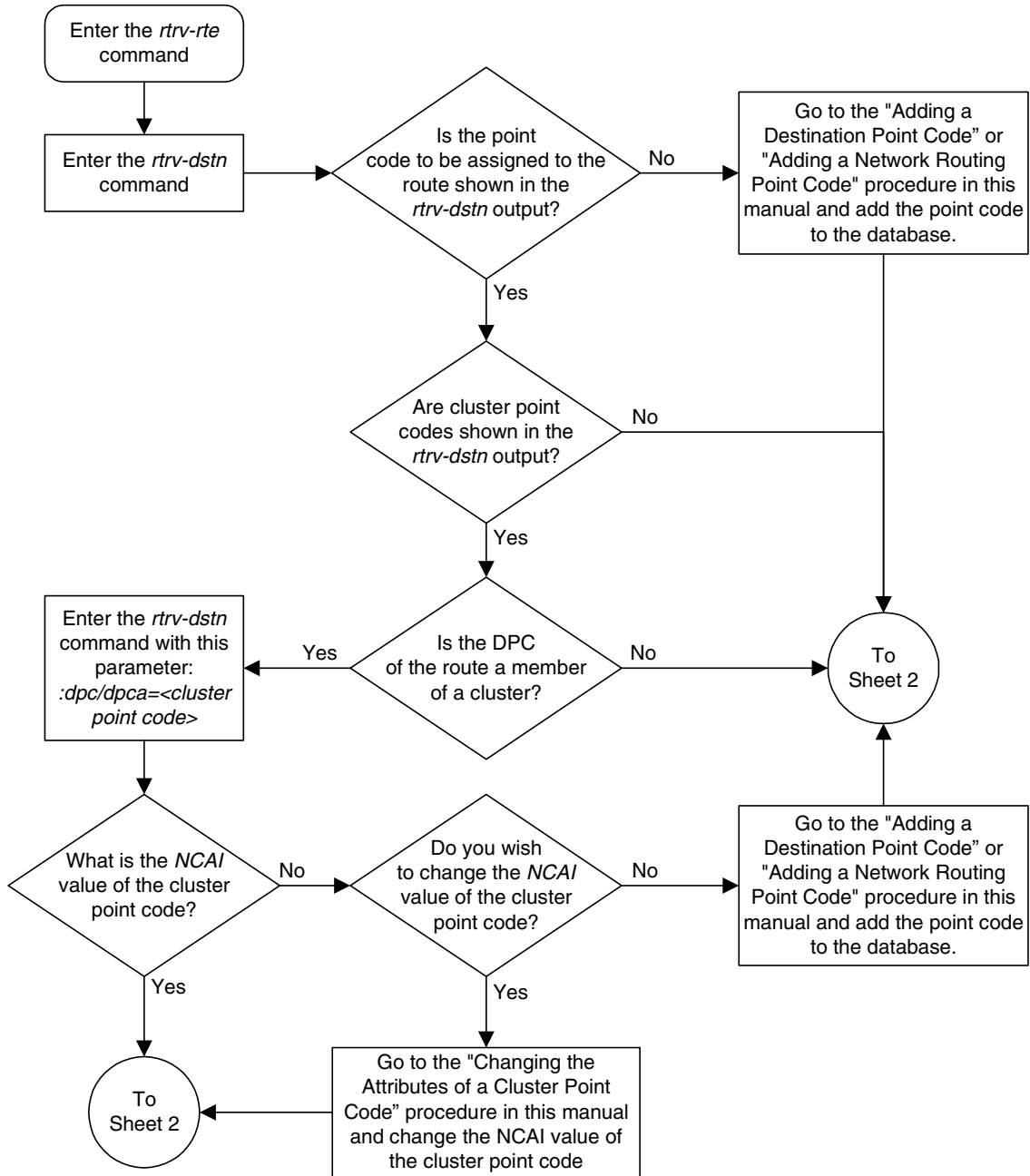

Flowchart 3-8. Adding a Route Containing an SS7 DPC (Sheet 2 of 3)

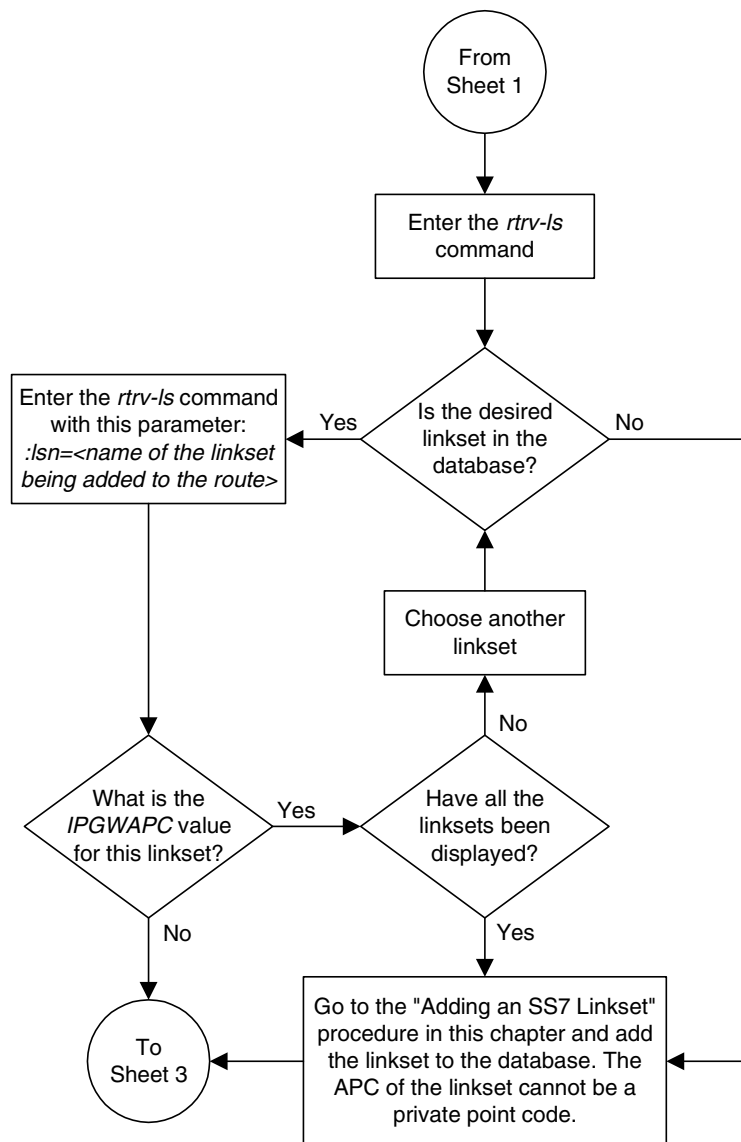

Flowchart 3-8. Adding a Route Containing an SS7 DPC (Sheet 3 of 3)

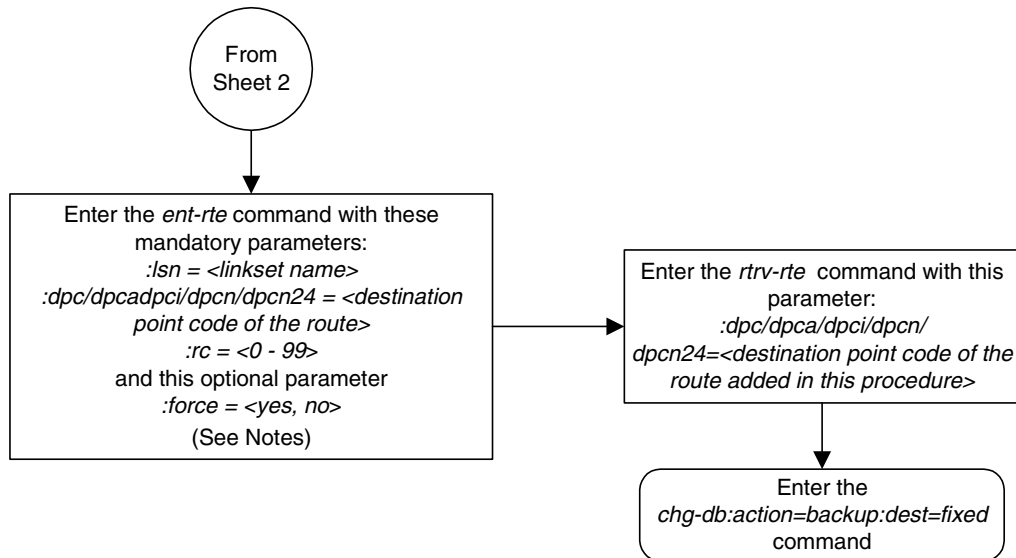

Notes:

1. The *force=yes* parameter must be specified if the linkset being assigned to the route has no signaling links assigned to it. Otherwise, each linkset must have at least one signaling link assigned to it.
2. A route can contain a maximum of six linksets.
3. A maximum of two linksets can be assigned the same *rc* parameter value.
4. If the DPC of the route is a member of a cluster point code, and the nested cluster allowed indicator (*ncal* parameter of either the *ent-dstn* or *chg-dstn* command) is set to no, then the route to the DPC must be the same as the route to the cluster point code. If the nested cluster allowed indicator is set to yes, the route to the member of the cluster does not have to be the same as the route to the cluster point code.
5. For routes containing 14-bit ITU National DPCs with group codes, if the linkset assigned to the route has the MULTGC value set to yes, then 14-bit ITU National DPCs with group codes that are different from the linkset APC group code can be assigned to the route. If the MULTGC value is set to no, then only 14-bit ITU National DPCs with group codes that are the same as the linkset APC group code can be assigned to the route.
6. The DPC of the route must be of the same format as the APC of the linkset being added to the route. That is, routes containing ANSI DPCs must have linksets with ANSI APCs; routes containing ITU-I DPCs must have linksets with ITU-I APCs; routes containing 14-bit ITU-N DPCs must have linksets with 14-bit ITU-N APCs; routes containing 24-bit ITU-N DPCs must have linksets with 24-bit ITU-N APCs. The DPC of the route must be defined as a true point code in the *rtrv-dstn* output. Alias point codes and secondary point codes cannot be used. True point codes are shown in the output of the *rtrv-dstn* command in the *DPCA*, *DPCI*, *DPCN*, or *DPCN24* fields.
7. Private point codes can be specified as the DPC of a route only if the linkset assigned to the route is an IPGWx linkset (a linkset that has the *ipgwapc=yes* parameter assigned to it).

Adding a Route Containing a Cluster Point Code

This procedure is used to add a route to the database containing a cluster point code as the DPC of the route using the `ent-rte` command. Routes that do not contain a cluster point code as the DPC of the route are configured in these procedures:

- “Adding a Route Containing an SS7 DPC” on page 3-153
- “Adding a Route Containing an IPGWx Linkset” on page 3-172
- “Adding a Route Containing an X.25 DPC” on page 3-181.

The `ent-rte` command uses these parameters.

`:dpc/dpca` - The destination point code (cluster point code) of the node that the traffic is bound for.

NOTE: See “Point Code Formats” on page 2-4 for a definition of the point code types that are used on the EAGLE 5 SAS

`:lsn` - The name of the linkset that will carry the traffic bound for the node specified by the destination point code.

`:rc` - The relative cost (priority) for this route.

`:force` - This parameter allows a route to be added to the database even if the linkset to be assigned to the route does not have any signaling links in it.

These items must be configured in the database before a route can be added:

- Destination point code (DPC) – see “Adding a Cluster Point Code” on page 2-142
- Linkset – see “Adding an SS7 Linkset” on page 3-17
- Link – see “Adding an SS7 Signaling Link” on page 3-130

The linkset assigned to this route must have an adjacent point code (APC) in the SS7 domain. The domain of the DPC is shown in the `DOMAIN` field in the output of the `rtrv-dstn` command.

The DPC of the route must be of the same format as the APC of the linkset being added to the route. That is, routes containing ANSI DPCs must have linksets with ANSI APCs; routes containing ITU-I DPCs must have linksets with ITU-I APCs; routes containing 14-bit ITU-N DPCs must have linksets with 14-bit ITU-N APCs; routes containing 24-bit ITU-N DPCs must have linksets with 24-bit ITU-N APCs. The DPC of the route must be defined as a true point code in the `rtrv-dstn` output. Alias point codes and secondary point codes cannot be used. True point codes are shown in the output of the `rtrv-dstn` command in the `DPCA`, `DPCI`, `DPCN`, or `DPCN24` fields. Private point codes cannot be used as the DPC of a route in this procedure. Routes that have private point codes as the DPC of a route can contain only IPGWx linksets. Perform the “Adding a Route Containing an IPGWx Linkset” on page 3-172 to add routes containing IPGWx linksets.

SS7 Configuration

The DPC of the route is the destination point code to be reached by the route and is shown in the output of the `rtrv-rte` command in the `DPCA`, `DPCI`, `DPCN`, or `DPCN24` fields.

The `APCA`, `APCI`, `APCN`, and `APCN24` fields in the output of the `rtrv-rte` command show the point code of the node that is directly adjacent to the node in the route.

A linkset can only be entered once as a route for each DPC.

A maximum of six routes can be defined for each DPC.

A maximum of two linksets can be assigned the same cost. The cost of the route is defined by the `rc` parameter of the `ent-rte` command and is shown in the `RC` field in the output of the `rtrv-rte` command.

The `force=yes` parameter must be specified if the specified linkset has no signaling links assigned to it. Otherwise, each linkset must have at least one signaling link assigned to it.

If the DPC of the route is a cluster point code, only linksets whose linkset type is either B, C, or D can be assigned to the route. The linkset type is shown in the `LST` field of the `rtrv-ls` command output. If the linkset type of the desired linkset is either A or E, one of three actions must be taken.

- Choose another linkset with the linkset type B, C, or D.
- Change the linkset type of an existing linkset – go to the “Changing an SS7 Linkset” procedure on page 3-74.
- Add a new linkset to the database with the necessary signaling links and the linkset type B, C, or D.
 - a. Go to the “Adding an SS7 Linkset” procedure on page 3-17 to add the linkset.
 - b. If the necessary signaling links are not in the database, go to the “Adding an SS7 Signaling Link” procedure on page 3-130 and add the signaling links to the database.

Canceling the `RTRV-LS`, `RTRV-DSTN`, and `RTRV-RTE` Commands

Because the `rtrv-ls`, `rtrv-dstn`, and `rtrv-rte` commands used in this procedure can output information for a long period of time, the `rtrv-ls`, `rtrv-dstn`, and `rtrv-rte` commands can be canceled and the output to the terminal stopped. There are three ways that the `rtrv-ls`, `rtrv-dstn`, and `rtrv-rte` commands can be canceled.

- Press the **F9** function key on the keyboard at the terminal where the `rtrv-ls`, `rtrv-dstn`, or `rtrv-rte` commands were entered.
- Enter the `canc-cmd` without the `trm` parameter at the terminal where the `rtrv-ls`, `rtrv-dstn`, or `rtrv-rte` commands were entered.

- Enter the `canc-cmd:trm=<xx>`, where `<xx>` is the terminal where the `rtrv-ls`, `rtrv-dstn`, or `rtrv-rte` commands were entered, from another terminal other than the terminal where the `rtrv-ls`, `rtrv-dstn`, or `rtrv-rte` commands were entered. To enter the `canc-cmd:trm=<xx>` command, the terminal must allow Security Administration commands to be entered from it and the user must be allowed to enter Security Administration commands. The terminal's permissions can be verified with the `rtrv-secu-trm` command. The user's permissions can be verified with the `rtrv-user` or `rtrv-secu-user` commands.

For more information about the `canc-cmd` command, go to the *Commands Manual*.

Procedure

- Display the current route configuration using the `rtrv-rte` command. This is an example of the possible output.

```
rlghncxa03w 05-09-07 11:43:04 GMT EAGLE5 34.0.0
  DPCA          ALIASI          ALIASN/N24    LSN          RC          APC
  140-012-004   1-111-1          10-13-12-1   ls000001    10          240-012-002
                                     ls000002    10          240-012-002
                                     ls000003    20          240-012-002
                                     ls000004    30          240-012-002
                                     ls000005    40          240-012-002
                                     ls000006    50          240-012-002
                                     CLLI=dp1
  140-012-005  1-111-2          10-13-12-2   ls000001    10          240-012-002
                                     ls000002    10          240-012-002
                                     ls000003    20          240-012-002
                                     ls000004    30          240-012-002
                                     ls000005    40          240-012-002
                                     ls000006    50          240-012-002
                                     CLLI=dp2
  DPCI          ALIASN/N24        ALIASA        LSN          RC          APC
  2-234-5       11-13-3-3        240-111-111  ls100001    10          1-234-5
                                     ls100002    10          1-234-6
                                     ls100003    20          1-234-7
                                     ls100004    30          1-234-1
                                     ls100005    40          1-234-2
                                     ls100006    50          1-234-3
                                     CLLI=idp1
  DPCN          ALIASA            ALIASI        LSN          RC          APC
  12-12-13-3   011-222-111     0-001-1      ls200001    10          10-13-9-3
                                     ls200002    10          10-13-10-0
                                     ls200003    20          10-13-10-1
                                     ls200004    30          10-13-10-2
                                     ls200005    40          10-13-10-3
                                     ls200006    50          10-13-11-0
                                     CLLI=ndp1
  DPCN24        ALIASA            ALIASI        LSN          RC          APC
```

If the cluster point code of the route being added in this procedure is not shown in the `rtrv-rte` output, perform the "Adding a Cluster Point Code" procedure on page 2-142 and add the cluster point code. Skip step 2 and go to step 3.

2. Display the **ncai** parameter value assigned to the cluster point code using the **rtrv-dstn** command and specifying the cluster point code. If the **ncai** parameter value is **no**, then the route to the DPC must be the same as the route to the cluster point code. If the **ncai** parameter value is **yes**, the route to the member of the cluster does not have to be the same as the route to the cluster point code. The **ncai** value is shown in the **NCAI** field of the **rtrv-dstn** output. For this example, enter this command.

rtrv-dstn:dPCA=111-011-*

This is an example of the possible output.

```
rlghncxa03w 05-09-28 21:16:37 GMT EAGLE5 34.0.0
DPCA          CLLI          BEI  ELEI  ALIASI          ALIASN/N24  DOMAIN
111-011-*     rlghncbb000 yes yes -----  -----  SS7

          SPC          NCAI
          -----  yes

Destination table is (12 of 2000) 1% full
```

3. Verify that the required linkset for the route is in the database by displaying the linksets in the database with the **rtrv-ls** command. This is an example of the possible output.

```
rlghncxa03w 05-09-10 11:43:04 GMT EAGLE5 34.0.0

          L3T  SLT          GWS  GWS  GWS
LSN      APCA  (SS7)  SCRN  SET  SET  BEI  LST  LNKS  ACT  MES  DIS  SLSCI  NIS
ele2     001-207-000  none  1   1   no  B   6   off  off  off  no   off
ls1305   000-005-000  none  1   1   no  A   1   off  off  off  no   off
ls1307   000-007-000  none  1   1   no  A   1   off  off  off  no   off
lsn7     002-002-002  none  1   1   no  C   8   off  off  off  no   off
elm1s1   001-001-001  none  1   1   no  A   7   off  off  off  no   off
elm1s2   001-001-002  none  1   1   no  A   7   off  off  off  no   off

          L3T  SLT          GWS  GWS  GWS
LSN      APCA  (X25)  SCRN  SET  SET  BEI  LST  LNKS  ACT  MES  DIS  SLSCI  NIS

          L3T  SLT          GWS  GWS  GWS
LSN      APCI  (SS7)  SCRN  SET  SET  BEI  LST  LNKS  ACT  MES  DIS  SLSCI  NIS
ele2i    1-207-0    none  1   1   no  B   4   off  off  off  ---  on
ls1315   0-015-0    none  1   1   no  A   1   off  off  off  ---  off
ls1317   0-017-0    none  1   1   no  A   1   off  off  off  ---  on
ls7890   7-089-0    none  1   2   no  B   1   off  off  off  ---  off
elm2s1   1-011-1    none  1   1   no  A   7   off  off  off  ---  off
elm2s2   1-011-2    none  1   1   no  A   7   off  off  off  ---  off

          L3T  SLT          GWS  GWS  GWS
LSN      APCN  (SS7)  SCRN  SET  SET  BEI  LST  LNKS  ACT  MES  DIS  SLSCI  NIS

          L3T  SLT          GWS  GWS  GWS
LSN      APCN24 (SS7)  SCRN  SET  SET  BEI  LST  LNKS  ACT  MES  DIS  SLSCI  NIS

          L3T  SLT          GWS  GWS  GWS
LSN (CHINA) APCN  (SS7)  SCRN  SET  SET  BEI  LST  LNKS  ACT  MES  DIS  SLSCI  NIS

          L3T  SLT          GWS  GWS  GWS
LSN (CHINA) APCN24 (SS7)  SCRN  SET  SET  BEI  LST  LNKS  ACT  MES  DIS  SLSCI  NIS

Link set table is (12 of 1024) 1% full.
```

The route containing a cluster point code can have only linksets with the linkset types B, C, or D assigned to it. If the required linkset is not in the database, perform the "Adding an SS7 Linkset" procedure on page 3-17 and add the linkset to the database with the **ipgwapc=no** parameter value and with the linkset types B, C, or D. The APC of the linkset cannot be a private point code. Skip step 4 and go to step 5.

4. Display each linkset being assigned to the route to verify the **ipgwapc** parameter values with the **rtrv-ls** command, specifying the name of the linkset that will be assigned to the route.

The **ipgwapc** linkset parameter value is **yes**, the DPC of the route cannot be a cluster point code. The **ipgwapc** value is shown in the **IPGWAPC** field of the **rtrv-ls** output.

If the linkset displayed in this step contains the **ipgwapc=yes** parameter, repeat this step with another linkset shown in step 3. If all the linksets have been displayed, and the **ipgwapc** value for all the linksets is **yes**, add the desired linkset by performing the "Adding an SS7 Linkset" procedure on page 3-17 with the **ipgwapc=no** parameter value and with the linkset types B, C, or D. The APC of the linkset cannot be a private point code.

For this example, enter the following command.

```
rtrv-ls:lsn=lsn7
```

This is an example of the possible output.

```
rlghncxa03w 05-09-17 11:43:04 GMT EAGLE5 34.0.0

LSN                APCA  (SS7)  SCRN SET SET BEI LST LNKS ACT MES DIS SLSCI NIS
lsn7                002-002-002 none 1  1  no  C   8   off off off no   off

CLLI                TFATCABMLQ MTPRSE ASL8  GSMSCRN
----- 4          ---   no   off

IPGWAPC MATELSN      IPTPS LSUSEALM SLKUSEALM
no      -----  ---  ---  ---

LOC  PORT  SLC  TYPE      L2T      L1      PCR  PCR
      SET  BPS  MODE  TSET  ECM  N1  N2
1211 A    0  LIMDS0  1  56000  ---  ---  BASIC ---  -----
1211 B    1  LIMDS0  1  56000  ---  ---  BASIC ---  -----
1211 A1   2  LIMDS0  1  56000  ---  ---  BASIC ---  -----
1211 A2   3  LIMDS0  1  56000  ---  ---  BASIC ---  -----
1211 B2   4  LIMDS0  1  56000  ---  ---  BASIC ---  -----
1211 B1   5  LIMDS0  1  56000  ---  ---  BASIC ---  -----
1211 B3   6  LIMDS0  1  56000  ---  ---  BASIC ---  -----
1211 A3   7  LIMDS0  1  56000  ---  ---  BASIC ---  -----

LOC  PORT  SLC  TYPE      LP      ATM
      SET  BPS  TSEL      VCI  VPI  LL
      LP      ATM
LOC  PORT  SLC  TYPE      SET  BPS  TSEL      VCI  VPI  CRC4 SI SN
LOC  PORT  SLC  TYPE      IPLIML2
```

SS7 Configuration

```
LOC  PORT  SLC  TYPE
```

```
LOC  PORT  SLC  TYPE      L2T      PCR  PCR  E1  E1
                        SET  BPS    ECM  N1  N2  LOC  PORT  TS
LOC  PORT  SLC  TYPE      L2T      PCR  PCR  T1  T1
                        SET  BPS    ECM  N1  N2  LOC  PORT  TS
```

```
Link set table is (12 of 1024) 1% full.
```

-
5. Add the route using the **ent-rte** command specifying the cluster point code as the DPC of the route. For this example, enter this command.

```
ent-rte:dPCA=111-011-*:lSn=lSn7:rc=10
```

When this command has successfully completed, this message should appear.

```
rlghncxa03w 05-09-07 08:28:30 GMT  EAGLE5 34.0.0
ENT-RTE: MASP A - COMPLTD
```

-
6. Verify the changes using the **rtrv-rte** command, specifying the destination point code of the route. For this example, enter these commands.

```
rtrv-rte:dPCA=111-011-*
```

This is an example of the possible output.

```
rlghncxa03w 05-09-07 11:43:04 GMT  EAGLE5 34.0.0

DPCA          ALIASI    ALIASN/N24    LSN          RC    APCA
111-011-*    -----    -----    lsn7         10    002-002-002
                        CLLI=-----
```

-
7. Back up the new changes using the **chg-db:action=backup:dest=fixed** command. These messages should appear, the active Maintenance and Administration Subsystem Processor (MASP) appears first.

```
BACKUP (FIXED) : MASP A - Backup starts on active MASP.
BACKUP (FIXED) : MASP A - Backup on active MASP to fixed disk complete.
BACKUP (FIXED) : MASP A - Backup starts on standby MASP.
BACKUP (FIXED) : MASP A - Backup on standby MASP to fixed disk complete.
```

Flowchart 3-9. Adding a Route Containing a Cluster Point Code (Sheet 1 of 2)

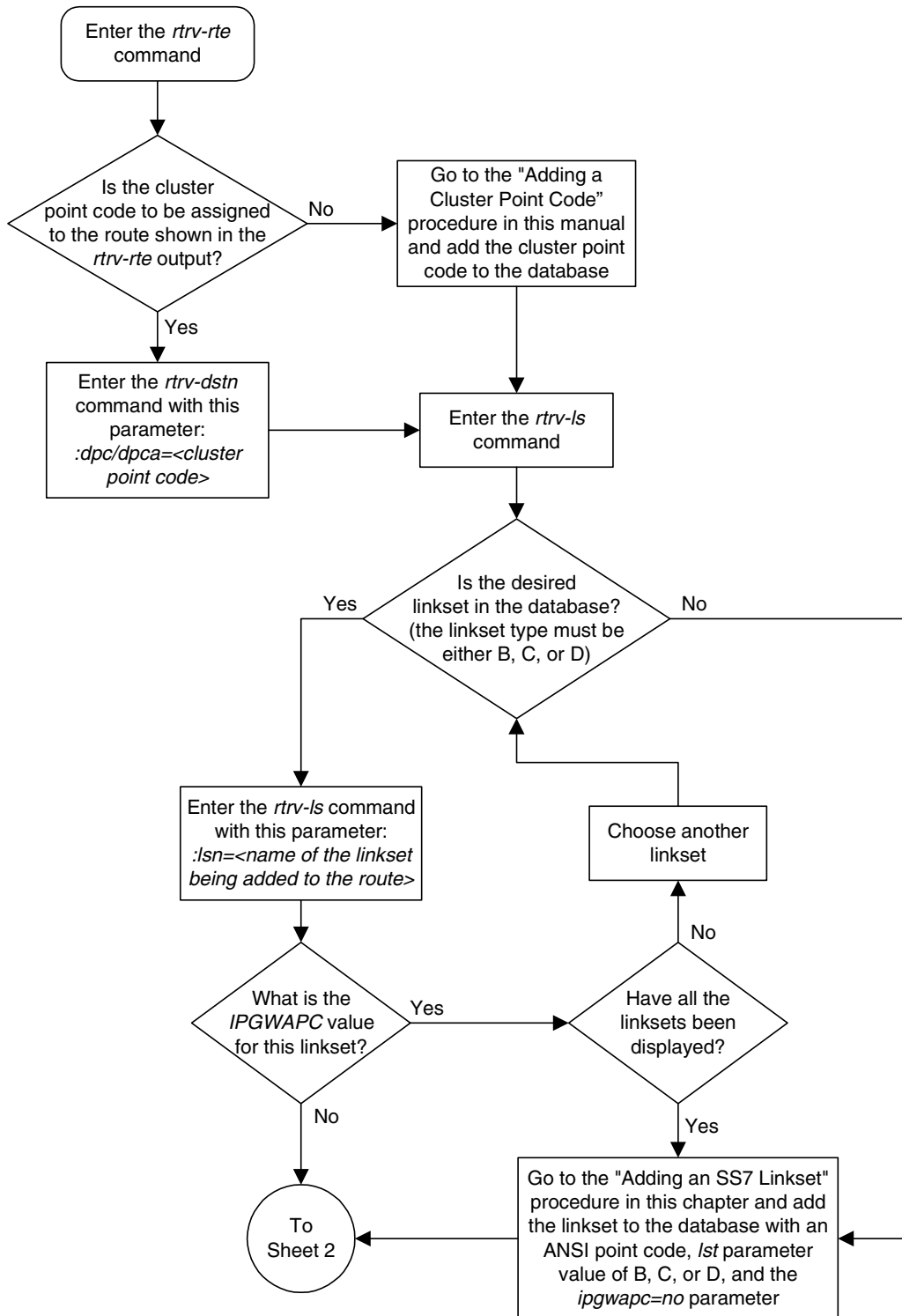

Flowchart 3-9. Adding a Route Containing a Cluster Point Code (Sheet 2 of 2)

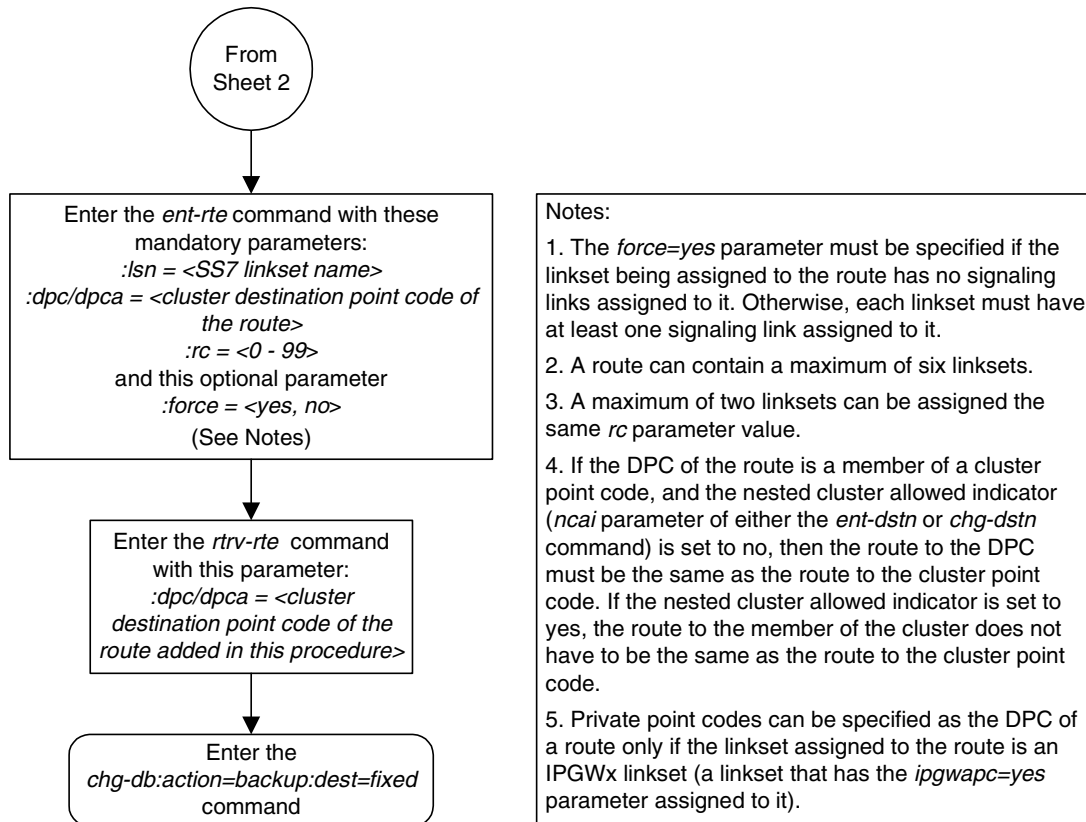

Adding a Route Containing an IPGWx Linkset

This procedure is used to add a route to the database containing an IPGWx linkset using the `ent-rte` command. Routes that do not contain IPGWx linksets are configured in these procedures:

- “Adding a Route Containing an SS7 DPC” on page 3-153
- “Adding a Route Containing a Cluster Point Code” on page 3-164
- “Adding a Route Containing an X.25 DPC” on page 3-181.

The `ent-rte` command uses these parameters.

`:dpc/dpca/dpci/dpcn/dpcn24` - The destination point code of the node that the traffic is bound for.

NOTE: See “Point Code Formats” on page 2-4 for a definition of the point code types that are used on the EAGLE 5 SAS and for a definition of the different formats that can be used for ITU national point codes.

`:lsn` - The name of the linkset that will carry the traffic bound for the node specified by the destination point code.

`:rc` - The relative cost (priority) for this route.

`:force` - This parameter allows a route to be added to the database even if the linkset to be assigned to the route does not have any signaling links in it.

These items must be configured in the database before a route can be added:

- Destination point code (DPC) – see “Adding a Destination Point Code” on page 2-191. The DPC of the route can be a private point code, but does not have to be.
- Linkset – see “Adding an SS7 Linkset” on page 3-17
- Link – see “Adding an SS7 Signaling Link” on page 3-130

The linkset assigned to this route must have an adjacent point code (APC) in the SS7 domain and must contain the `ipgwapc=yes` parameter value. The domain of the DPC is shown in the `DOMAIN` field in the output of the `rtrv-dstn` command. The `ipgwapc` parameter value is shown in the output of the `rtrv-ls:lsn=<linkset name>` command.

The DPC of the route must be of the same format as the APC of the linkset being added to the route. That is, routes containing ANSI DPCs must have linksets with ANSI APCs; routes containing ITU-I DPCs must have linksets with ITU-I APCs; routes containing 14-bit ITU-N DPCs must have linksets with 14-bit ITU-N APCs; routes containing 24-bit ITU-N DPCs must have linksets with 24-bit ITU-N APCs. The DPC of the route must be defined as a true point code in the `rtrv-dstn` output. Alias point codes and secondary point codes cannot be used. True point codes are shown in the output of the `rtrv-dstn` command in the `DPCA`, `DPCI`, `DPCN`, or `DPCN24` fields.

The DPC of the route is the destination point code to be reached by the route and is shown in the output of the `rtrv-rte` command in the `DPCA`, `DPCI`, `DPCN`, or `DPCN24` fields.

The `APCA`, `APCI`, `APCN`, and `APCN24` fields in the output of the `rtrv-rte` command show the point code of the node that is directly adjacent to the node in the route.

A linkset can only be entered once as a route for each DPC.

A maximum of six routes can be defined for each DPC.

A maximum of two linksets can be assigned the same cost. The cost of the route is defined by the `rc` parameter of the `ent-rte` command and is shown in the `RC` field in the output of the `rtrv-rte` command.

The `force=yes` parameter must be specified if the specified linkset has no signaling links assigned to it. Otherwise, each linkset must have at least one signaling link assigned to it.

The DPC of the route must be a full point code.

If the DPC of the route is a member of a cluster point code, and the nested cluster allowed indicator (`ncai` parameter of either the `ent-dstn` or `chg-dstn` command) is set to `no`, then the route to the DPC must be the same as the route to the cluster point code. If the nested cluster allowed indicator is set to `yes`, the route to the member of the cluster does not have to be the same as the route to the cluster point code. For more information, see the “Nested Cluster Routing” section on page 2-135.

For routes containing 14-bit ITU National DPCs with group codes, if the linkset assigned to the route has the `MULTGC` value set to `yes`, then 14-bit ITU National DPCs with group codes that are different from the linkset APC group code can be assigned to the route. If the `MULTGC` value is set to `no`, then only 14-bit ITU National DPCs with group codes that are the same as the linkset APC group code can be assigned to the route.

Canceling the `RTRV-LS`, `RTRV-DSTN`, and `RTRV-RTE` Commands

Because the `rtrv-ls`, `rtrv-dstn`, and `rtrv-rte` commands used in this procedure can output information for a long period of time, the `rtrv-ls`, `rtrv-dstn`, and `rtrv-rte` commands can be canceled and the output to the terminal stopped. There are three ways that the `rtrv-ls`, `rtrv-dstn`, and `rtrv-rte` commands can be canceled.

- Press the **F9** function key on the keyboard at the terminal where the `rtrv-ls`, `rtrv-dstn`, or `rtrv-rte` commands were entered.
- Enter the `canc-cmd` without the `trm` parameter at the terminal where the `rtrv-ls`, `rtrv-dstn`, or `rtrv-rte` commands were entered.
- Enter the `canc-cmd:trm=<xx>`, where `<xx>` is the terminal where the `rtrv-ls`, `rtrv-dstn`, or `rtrv-rte` commands were entered, from another

terminal other than the terminal where the `rtrv-ls`, `rtrv-dstn`, or `rtrv-rte` commands were entered. To enter the `canc-cmd:trm=<xx>` command, the terminal must allow Security Administration commands to be entered from it and the user must be allowed to enter Security Administration commands. The terminal's permissions can be verified with the `rtrv-secu-trm` command. The user's permissions can be verified with the `rtrv-user` or `rtrv-secu-user` commands.

For more information about the `canc-cmd` command, go to the *Commands Manual*.

Procedure

1. Display the current route configuration using the `rtrv-rte` command. This is an example of the possible output.

```
rlghncxa03w 05-09-07 11:43:04 GMT EAGLE5 34.0.0
DPCA          ALIASI          ALIASN/N24    LSN           RC           APCA
140-012-004   1-111-1          10-13-12-1   ls000001     10           240-012-002
              1s000002     10           240-012-002
              1s000003     20           240-012-002
              1s000004     30           240-012-002
              1s000005     40           240-012-002
              1s000006     50           240-012-002
              CLLI=dp1
140-012-005 1-111-2          10-13-12-2   ls000001     10           240-012-002
              1s000002     10           240-012-002
              1s000003     20           240-012-002
              1s000004     30           240-012-002
              1s000005     40           240-012-002
              1s000006     50           240-012-002
              CLLI=dp2
DPCI          ALIASN/N24        ALIASA        LSN           RC           APC
2-234-5       11-13-3-3        240-111-111  ls100001     10           1-234-5
              1s100002     10           1-234-6
              1s100003     20           1-234-7
              1s100004     30           1-234-1
              1s100005     40           1-234-2
              1s100006     50           1-234-3
              CLLI=idp1
DPCN          ALIASA            ALIASI        LSN           RC           APC
12-12-13-3   011-222-111     0-001-1      ls200001     10           10-13-9-3
              1s200002     10           10-13-10-0
              1s200003     20           10-13-10-1
              1s200004     30           10-13-10-2
              1s200005     40           10-13-10-3
              1s200006     50           10-13-11-0
              CLLI=ndp1
DPCN24        ALIASA            ALIASI        LSN           RC           APC
```

If the destination point code of the route being added in this procedure is not shown in the `rtrv-rte` output, perform the "Adding a Destination Point Code" procedure on page 2-191 and add the destination point code of the route to the destination point code table. This point code can be a private point code, but does not have to be a private point code.

NOTE: If cluster point codes are not shown in steps 1 and 2, or if the DPC of the route being added is not a member of the cluster point code, skip this step and go to step 4.

2. Display the **ncai** parameter value assigned to the cluster point code using the **rtrv-dstn** command and specifying the cluster point code. If the **ncai** parameter value is **no**, then the route to the DPC must be the same as the route to the cluster point code. If the **ncai** parameter value is **yes**, the route to the member of the cluster does not have to be the same as the route to the cluster point code. The **ncai** value is shown in the **NCAI** field of the **rtrv-dstn** output. For this example, enter this command.

```
rtrv-dstn:dPCA=111-011-*
```

This is an example of the possible output.

```
rlghncxa03w 05-09-28 21:16:37 GMT EAGLE5 34.0.0
DPCA          CLLI          BEI  ELEI  ALIASI          ALIASN/N24      DOMAIN
111-011-*     rlghncbb000 yes yes -----
                                     SPC          NCAI
                                     ----- yes
```

Destination table is (12 of 2000) 1% full

If the **ncai** parameter value of the cluster point code is **no**, and you wish to change the **ncai** parameter value to **yes**, perform the “Changing the Attributes of a Cluster Point Code” procedure on page 2-161. If the **ncai** parameter value of the cluster point code is **no**, and you do not wish to change the **ncai** parameter value to **yes**, add a new DPC for the route by performing either the “Adding a Destination Point Code” procedure on page 2-191 or the “Adding a Network Routing Point Code” procedure on page 2-181.

3. Verify that the required linkset for the route is in the database by displaying the linksets in the database with the **rtrv-ls** command. This is an example of the possible output.

```
rlghncxa03w 05-09-10 11:43:04 GMT EAGLE5 34.0.0

LSN          APCA      (SS7)  L3T SLT          GWS GWS GWS
e1e2         001-207-000 none 1 1 no B 6 off off off no off
ls1305       000-005-000 none 1 1 no A 1 off off off no off
ls1307       000-007-000 none 1 1 no A 1 off off off no off
lsn4         p-004-004-004 none 1 1 no A 6 off off off no off
elm1s1       001-001-001 none 1 1 no A 7 off off off no off
elm1s2       001-001-002 none 1 1 no A 7 off off off no off

LSN          APCA      (X25)  L3T SLT          GWS GWS GWS
e1e2         001-207-000 none 1 1 no B 6 off off off no off
ls1305       000-005-000 none 1 1 no A 1 off off off no off
ls1307       000-007-000 none 1 1 no A 1 off off off no off
lsn4         p-004-004-004 none 1 1 no A 6 off off off no off
elm1s1       001-001-001 none 1 1 no A 7 off off off no off
elm1s2       001-001-002 none 1 1 no A 7 off off off no off

LSN          APCI      (SS7)  L3T SLT          GWS GWS GWS
e1e2i        1-207-0 none 1 1 no B 4 off off off --- on
ls1315       0-015-0 none 1 1 no A 1 off off off --- off
ls1317       0-017-0 none 1 1 no A 1 off off off --- on
elm2s1       1-011-1 none 1 1 no A 7 off off off --- off
elm2s2       1-011-2 none 1 1 no A 7 off off off --- off
```

```

LSN                APCN    (SS7)  SCRN SET SET BEI LST LNKS ACT MES DIS SLSCI NIS
                L3T SLT                GWS GWS GWS
LSN                APCN24 (SS7)  SCRN SET SET BEI LST LNKS ACT MES DIS SLSCI NIS
                L3T SLT                GWS GWS GWS
LSN (CHINA) APCN    (SS7)  SCRN SET SET BEI LST LNKS ACT MES DIS SLSCI NIS
                L3T SLT                GWS GWS GWS
LSN (CHINA) APCN24 (SS7)  SCRN SET SET BEI LST LNKS ACT MES DIS SLSCI NIS
                L3T SLT                GWS GWS GWS

```

Link set table is (11 of 1024) 1% full.

If the required linkset is not in the database, perform the “Configuring an IPGWx Linkset” procedure in the *Database Administration Manual - IP^v Secure Gateway* and add the IPGWx linkset to the database.

If the required linkset is shown in the `rtrv-ls` output, and the APC of the linkset is a private point code, skip step 4 and go to step 5.

4. Display each linkset being assigned to the route to verify the `multgc` and `ipgwapc` parameter values with the `rtrv-ls` command, specifying the name of the linkset that will be assigned to the route.

If the `multgc` linkset parameter value is `yes`, then 14-bit ITU National DPCs with group codes that are different from the linkset APC group code can be assigned to the route. If the `multgc` value is set to `no`, then only 14-bit ITU National DPCs with group codes that are the same as the linkset APC group code can be assigned to the route. The `multgc` value is shown in the `MULTGC` field of the `rtrv-ls` output.

If the linkset displayed in this step contains the `ipgwapc=no` parameter, repeat this step with another linkset shown in step 3. If all the linksets have been displayed, and the `ipgwapc` value for all the linksets is `no`, add the desired linkset by perform the “Configuring an IPGWx Linkset” procedure in the *Database Administration Manual - IP^v Secure Gateway* and add the IPGWx linkset to the database.

For this example, enter the following commands.

```
rtrv-ls:lsn=lsn4
```

This is an example of the possible output.

```

rlghncxa03w 05-09-11 11:06:27 GMT 34.0.0

LSN                APCA    (SS7)  SCRN SET SET BEI LST LNKS ACT MES DIS SLSCI NIS
lsn4                p-004-004-004  none 1  1  no  A  6  off off off no  off
                L3T SLT                GWS GWS GWS
                CLLI                TFATCABMLQ MTPRSE ASL8 GSMSCRN
                ----- 3          ---  no  off
                IPGWAPC MATELSN  IPTPS LSUSEALM SLKUSEALM
                yes      ----- 100  100  % 80  %

```

SS7 Configuration

```

          L2T          L1          PCR PCR
LOC PORT SLC TYPE    SET BPS    MODE TSET  ECM  N1  N2

          LP          ATM
LOC PORT SLC TYPE    SET BPS    TSEL      VCI  VPI  LL

          LP          ATM          E1ATM
LOC PORT SLC TYPE    SET BPS    TSEL      VCI  VPI  CRC4 SI SN

LOC PORT SLC TYPE    IPLIML2

LOC PORT SLC TYPE
1107 A      0  SS7IPGW
1205 A      1  SS7IPGW
1305 A      2  SS7IPGW
1303 A      3  SS7IPGW
1307 A      4  SS7IPGW
1311 A      5  SS7IPGW

          L2T          PCR PCR  E1  E1
LOC PORT SLC TYPE    SET BPS    ECM  N1  N2  LOC PORT TS

          L2T          PCR PCR  T1  T1
LOC PORT SLC TYPE    SET BPS    ECM  N1  N2  LOC PORT TS

```

Link set table is (16 of 1024) 1% full.

5. Add the route using the **ent-rte** command with the IPGWx linkset. For this example, enter this command.

```
ent-rte:dPCA=p-004-004-004:lsn=lsn4:rc=10
```

When this command has successfully completed, this message should appear.

```
rlghncxa03w 05-09-07 08:28:30 GMT  EAGLE5 34.0.0
ENT-RTE: MASP A - COMPLTD
```

6. Verify the changes using the **rtrv-rte** command, specifying the destination point code of the route. For this example, enter this command.

```
rtrv-rte:dPCA=p-004-004-004
```

This is an example of the possible output.

```
rlghncxa03w 05-09-07 11:43:04 GMT  EAGLE5 34.0.0

  DPCA          ALIASI          ALIASN/N24    LSN          RC    APCA
p-004-004-004  -----  s-00444-aa    lsn4          10    p-004-004-004
                                   CLLI=-----
```

7. Back up the new changes using the **chg-db:action=backup:dest=fixed** command. These messages should appear, the active Maintenance and Administration Subsystem Processor (MASP) appears first.

```
BACKUP (FIXED) : MASP A - Backup starts on active MASP.
BACKUP (FIXED) : MASP A - Backup on active MASP to fixed disk complete.
BACKUP (FIXED) : MASP A - Backup starts on standby MASP.
BACKUP (FIXED) : MASP A - Backup on standby MASP to fixed disk complete.
```

Flowchart 3-10. Adding a Route Containing an IPGWx Linkset (Sheet 1 of 3)

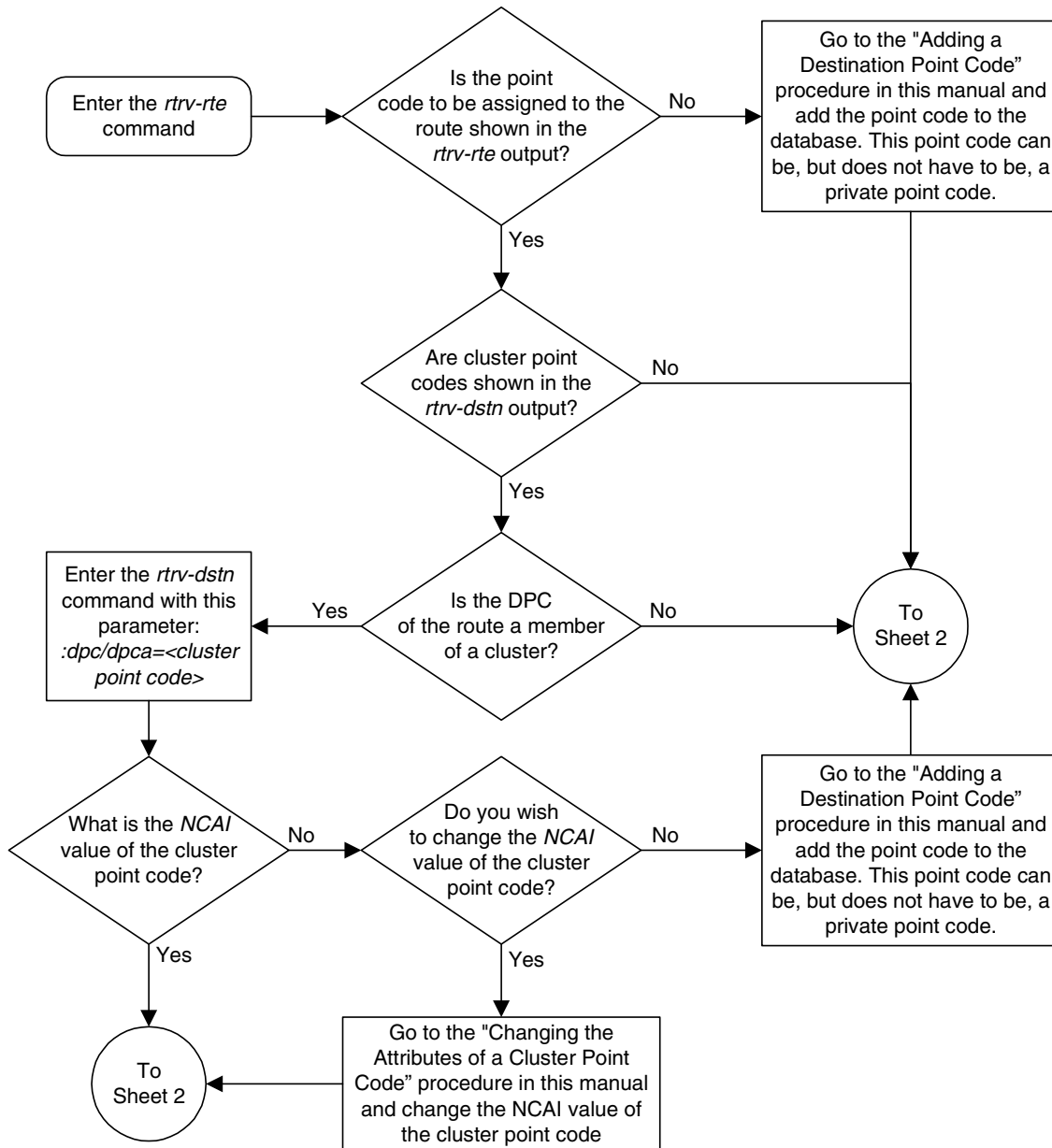

Flowchart 3-10. Adding a Route Containing an IPGWx Linkset (Sheet 2 of 3)

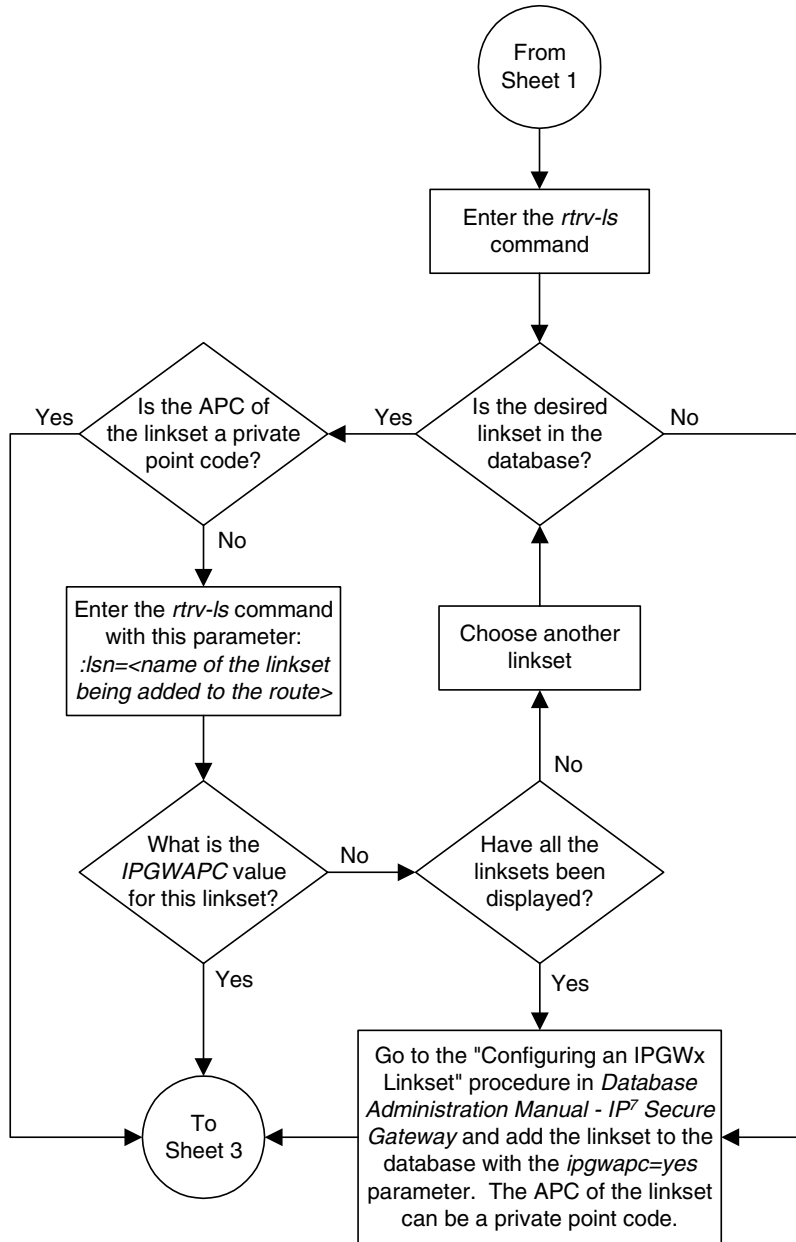

Flowchart 3-10. Adding a Route Containing an IPGWx Linkset (Sheet 3 of 3)

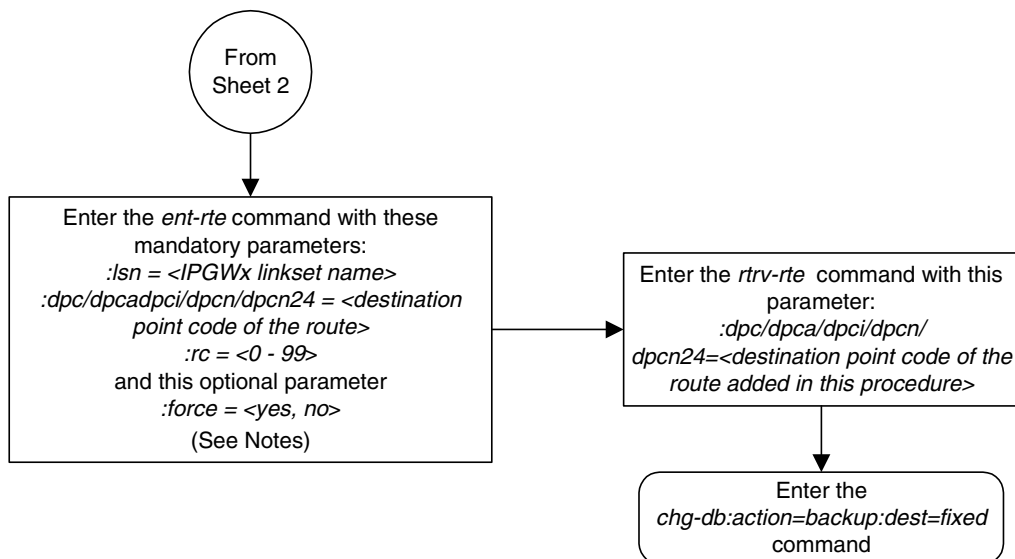

Notes:

1. The *force=yes* parameter must be specified if the linkset being assigned to the route has no signaling links assigned to it. Otherwise, each linkset must have at least one signaling link assigned to it.
2. A route can contain a maximum of six linksets.
3. For an SS7 route, a maximum of two linksets can be assigned the same *rc* parameter value.
4. If the DPC of the route is a member of a cluster point code, and the nested cluster allowed indicator (*ncal* parameter of either the *ent-dstn* or *chg-dstn* command) is set to no, then the route to the DPC must be the same as the route to the cluster point code. If the nested cluster allowed indicator is set to yes, the route to the member of the cluster does not have to be the same as the route to the cluster point code.
5. For routes containing 14-bit ITU National DPCs with group codes, if the linkset assigned to the route has the MULTGC value set to yes, then 14-bit ITU National DPCs with group codes that are different from the linkset APC group code can be assigned to the route. If the MULTGC value is set to no, then only 14-bit ITU National DPCs with group codes that are the same as the linkset APC group code can be assigned to the route.
6. The DPC of the route must be of the same format as the APC of the linkset being added to the route. That is, routes containing ANSI DPCs must have linksets with ANSI APCs; routes containing ITU-I DPCs must have linksets with ITU-I APCs; routes containing 14-bit ITU-N DPCs must have linksets with 14-bit ITU-N APCs; routes containing 24-bit ITU-N DPCs must have linksets with 24-bit ITU-N APCs. The DPC of the route must be defined as a true point code in the *rtv-dstn* output. Alias point codes and secondary point codes cannot be used. True point codes are shown in the output of the *rtv-dstn* command in the *DPCA*, *DPCI*, *DPCN*, or *DPCN24* fields.
7. Private point codes can be specified as the DPC of a route only if the linkset assigned to the route is an IPGWx linkset (a linkset that has the *ipgwapc=yes* parameter assigned to it).

Adding a Route Containing an X.25 DPC

This procedure is used to add a route to the database containing an X.25 point code as the DPC of the route using the `ent-rte` command. Routes that do not contain an X.25 point code as the DPC of the route are configured in these procedures:

- “Adding a Route Containing an SS7 DPC” on page 3-153
- “Adding a Route Containing a Cluster Point Code” on page 3-164
- “Adding a Route Containing an IPGWx Linkset” on page 3-172.

The `ent-rte` command uses these parameters.

:dpc/dpca – The X.25 destination point code of the node that the traffic is bound for.

NOTE: See “Point Code Formats” on page 2-4 for a definition of the point code types that are used on the EAGLE 5 SAS.

:lsn – The name of the linkset that will carry the traffic bound for the node specified by the destination point code.

:rc – The relative cost (priority) for this route.

:force – This parameter allows a route to be added to the database even if the linkset to be assigned to the route does not have any signaling links in it.

These items must be configured in the database before a route can be added:

- X.25 Destination point code (DPC) – see “Adding a Destination Point Code” on page 2-191.
- X.25 Linkset – see “Adding an X.25 Linkset” procedure in the *Database Administration Manual – Features*.
- X.25 Signaling Link – see “Adding an X.25 Signaling Link” procedure in the *Database Administration Manual – Features*.
- X.25 destination (if an X.25 route is to be added) – see the “Adding an X.25 Gateway Destination” procedure in the *Database Administration Manual – Features*.

The linkset assigned to this route must have an APC in the X.25 domain. The domain of the DPC is shown in the **DOMAIN** field in the output of the `rtrv-dstn` command.

If the destination of a route (**DPC/DPCA**) is in the X.25 domain, no routes to that destination can be assigned the same cost value (**RC**) in the same routeset. If two routes in a routeset were assigned the same cost value, this creates a combined linkset and combined linksets to DPCs in the X.25 domain are not allowed.

The DPC of the route is the destination point code to be reached by the route and is shown in the output of the `rtrv-rte` command in the **DPCA** field.

A linkset can only be entered once as a route for each DPC.

A maximum of six routes can be defined for each DPC.

The **force=yes** parameter must be specified if the specified linkset has no signaling links assigned to it. Otherwise, each linkset must have at least one signaling link assigned to it.

If the route is assigned a DPC that is in the X.25 domain, then that DPC must be assigned to at least one X.25 destination.

If the DPC of the route is a member of a cluster point code, and the nested cluster allowed indicator (**ncai** parameter of either the **ent-dstn** or **chg-dstn** command) is set to no, then the route to the DPC must be the same as the route to the cluster point code. If the nested cluster allowed indicator is set to yes, the route to the member of the cluster does not have to be the same as the route to the cluster point code. For more information, see the “Nested Cluster Routing” section on page 2-135.

Canceling the **RTRV-LS**, **RTRV-DSTN**, and **RTRV-RTE** Commands

Because the **rtrv-ls**, **rtrv-dstn**, and **rtrv-rte** commands used in this procedure can output information for a long period of time, the **rtrv-ls**, **rtrv-dstn**, and **rtrv-rte** commands can be canceled and the output to the terminal stopped. There are three ways that the **rtrv-ls**, **rtrv-dstn**, and **rtrv-rte** commands can be canceled.

- Press the **F9** function key on the keyboard at the terminal where the **rtrv-ls**, **rtrv-dstn**, or **rtrv-rte** commands were entered.
- Enter the **canc-cmd** without the **trm** parameter at the terminal where the **rtrv-ls**, **rtrv-dstn**, or **rtrv-rte** commands were entered.
- Enter the **canc-cmd:trm=<xx>**, where **<xx>** is the terminal where the **rtrv-ls**, **rtrv-dstn**, or **rtrv-rte** commands were entered, from another terminal other than the terminal where the **rtrv-ls**, **rtrv-dstn**, or **rtrv-rte** commands were entered. To enter the **canc-cmd:trm=<xx>** command, the terminal must allow Security Administration commands to be entered from it and the user must be allowed to enter Security Administration commands. The terminal's permissions can be verified with the **rtrv-secu-trm** command. The user's permissions can be verified with the **rtrv-user** or **rtrv-secu-user** commands.

For more information about the **canc-cmd** command, go to the *Commands Manual*.

Procedure

1. Display the current route configuration using the `rtrv-rte` command. This is an example of the possible output.

```

rlghncxa03w 05-09-07 11:43:04 GMT EAGLE5 34.0.0
  DPCA          ALIASI      ALIASN/N24    LSN          RC      APCA
  140-012-004   1-111-1      10-13-12-1   ls000001    10     240-012-002
                                     ls000002    10     240-012-002
                                     ls000003    20     240-012-002
                                     ls000004    30     240-012-002
                                     ls000005    40     240-012-002
                                     ls000006    50     240-012-002
                                     CLLI=dp1
  140-012-005   1-111-2      10-13-12-2   ls000001    10     240-012-002
                                     ls000002    10     240-012-002
                                     ls000003    20     240-012-002
                                     ls000004    30     240-012-002
                                     ls000005    40     240-012-002
                                     ls000006    50     240-012-002
                                     CLLI=dp2

  DPCI          ALIASN/N24      ALIASA        LSN          RC      APC
  2-234-5       11-13-3-3     240-111-111  ls100001    10     1-234-5
                                     ls100002    10     1-234-6
                                     ls100003    20     1-234-7
                                     ls100004    30     1-234-1
                                     ls100005    40     1-234-2
                                     ls100006    50     1-234-3
                                     CLLI=idp1

  DPCN          ALIASA          ALIASI        LSN          RC      APC
  12-12-13-3   011-222-111   0-001-1      ls200001    10     10-13-9-3
                                     ls200002    10     10-13-10-0
                                     ls200003    20     10-13-10-1
                                     ls200004    30     10-13-10-2
                                     ls200005    40     10-13-10-3
                                     ls200006    50     10-13-11-0
                                     CLLI=ndp1

  DPCN24        ALIASA          ALIASI        LSN          RC      APC

```

2. Verify that the destination point code of the route is in the destination point code table by using the `rtrv-dstn` command. This is an example of the possible output.

```

rlghncxa03w 05-09-10 11:43:04 GMT EAGLE5 34.0.0
  DPCA          CLLI          BEI ELEI      ALIASI      ALIASN/N24  DOMAIN
  001-002-003   ls04clli     yes --- -----  -----    SS7
  001-002-003   ls04clli     yes --- -----  -----    SS7
  002-002-100   ls01clli     no  --- -----  -----    SS7
  002-007-008   ls06clli     yes --- -----  -----    SS7
  002-009-003   -----     no  --- -----  -----    SS7
  002-250-010   -----     no  --- -----  -----    SS7
  003-003-003   ls03clli     yes --- -----  -----    SS7
  003-020-100   -----     no  --- -----  -----    SS7
  004-004-004   ls02clli     yes --- -----  -----    SS7
  004-030-200   -----     no  --- -----  -----    SS7
  009-002-003   -----     no  --- -----  -----    SS7

```

```

179-100-087 ----- yes --- ----- SS7
200-050-176 ----- yes --- ----- SS7
240-007-000 ----- yes --- ----- SS7
240-012-004 rlghncbb001 yes --- 1-111-1 11111 SS7
240-012-005 rlghncbb002 yes --- 1-112-2 11112 SS7
240-012-006 rlghncbb003 yes --- 1-112-3 11113 SS7
240-012-008 ----- yes --- 1-113-5 11114 SS7
244-010-004 ls06clli no --- ----- X25
244-012-005 ls07clli no --- ----- X25
244-012-006 ls08clli no --- ----- X25
244-012-007 ----- no --- ----- X25
244-012-008 ----- no --- ----- X25

DPCI      CLLI      BEI  ELEI  ALIASA      ALIASN/N24  DOMAIN
2-131-1   rlghncbb023 no --- 222-210-000 12001 SS7
2-131-2   ----- no --- 222-211-001 12002 SS7
2-131-3   ----- no --- 222-211-002 12003 SS7
3-150-4   lsi7clli  yes --- ----- SS7

DPCN      CLLI      BEI  ELEI  ALIASA      ALIASI      DOMAIN
10685    lsn5clli  yes --- ----- SS7
11211    rlghncbb013 no --- 222-200-200 2-121-1 SS7
11212    rlghncbb013 no --- 222-200-201 2-121-2 SS7

DPCN24    CLLI      BEI  ELEI  ALIASA      ALIASI      DOMAIN

```

Destination table is (29 of 2000) 1% full

If the X.25 destination point code of the route being added in this procedure is not shown in the **rtrv-dstn** output, perform the "Adding a Destination Point Code" on page 2-191 to add the X.25 destination point code to the database.

NOTE: If cluster point codes are not shown in steps 1 and 2, or if the DPC of the route being added is not a member of the cluster point code, skip this step and go to step 4.

3. Display the **ncai** parameter value assigned to the cluster point code using the **rtrv-dstn** command and specifying the cluster point code. If the **ncai** parameter value is **no**, then the route to the DPC must be the same as the route to the cluster point code. If the **ncai** parameter value is **yes**, the route to the member of the cluster does not have to be the same as the route to the cluster point code. The **ncai** value is shown in the **NCAI** field of the **rtrv-dstn** output. For this example, enter this command.

```
rtrv-dstn:dpca=111-011-*
```

This is an example of the possible output.

```

rlghncxa03w 05-09-28 21:16:37 GMT EAGLE5 34.0.0
  DPCA      CLLI      BEI  ELEI  ALIASI      ALIASN/N24  DOMAIN
  111-011-*  rlghncbb000 yes yes ----- SS7

          SPC      NCAI
          ----- yes

```

Destination table is (12 of 2000) 1% full

If the **ncai** parameter value of the cluster point code is **no**, and you wish to change the **ncai** parameter value to **yes**, perform the "Changing the Attributes of a Cluster Point Code" procedure on page 2-161. If the **ncai**

parameter value of the cluster point code is **no**, and you do not wish to change the **ncai** parameter value to **yes**, add a new DPC for the route by performing either the “Adding a Destination Point Code” procedure on page 2-191 or the “Adding a Network Routing Point Code” procedure on page 2-181.

4. Verify that the required linkset for the route is in the database by displaying the linksets in the database with the **rtrv-ls** command. This is an example of the possible output.

```
rlghncxa03w 05-09-10 11:43:04 GMT EAGLE5 34.0.0
```

LSN	APCA	(SS7)	SCRN	SET	SET	BEI	LST	LNKS	GWS	GWS	GWS	SLSCI	NIS
ele2	001-207-000		none	1	1	no	B	6	off	off	off	no	off
ls1305	000-005-000		none	1	1	no	A	1	off	off	off	no	off
ls1307	000-007-000		none	1	1	no	A	1	off	off	off	no	off
elm1s1	001-001-001		none	1	1	no	A	7	off	off	off	no	off
elm1s2	001-001-002		none	1	1	no	A	7	off	off	off	no	off

LSN	APCA	(X25)	SCRN	SET	SET	BEI	LST	LNKS	GWS	GWS	GWS	SLSCI	NIS
LSN	APCI	(SS7)	SCRN	SET	SET	BEI	LST	LNKS	ACT	MES	DIS	SLSCI	NIS
ele2i	1-207-0		none	1	1	no	B	4	off	off	off	---	on
ls1315	0-015-0		none	1	1	no	A	1	off	off	off	---	off
ls1317	0-017-0		none	1	1	no	A	1	off	off	off	---	on
elm2s1	1-011-1		none	1	1	no	A	7	off	off	off	---	off
elm2s2	1-011-2		none	1	1	no	A	7	off	off	off	---	off

LSN	APCN	(SS7)	SCRN	SET	SET	BEI	LST	LNKS	GWS	GWS	GWS	SLSCI	NIS
LSN	APCN24	(SS7)	SCRN	SET	SET	BEI	LST	LNKS	ACT	MES	DIS	SLSCI	NIS

LSN (CHINA)	APCN	(SS7)	SCRN	SET	SET	BEI	LST	LNKS	GWS	GWS	GWS	SLSCI	NIS
LSN (CHINA)	APCN24	(SS7)	SCRN	SET	SET	BEI	LST	LNKS	ACT	MES	DIS	SLSCI	NIS

Link set table is (10 of 1024) 1% full.

If the required linkset is not in the database, perform the “Adding an X.25 Linkset” procedure in the *Database Administration Manual - Features* and add the linkset to the database.

5. Add the route using the **ent-rte** command specifying the X.25 DPC. For this example, enter this command.

```
ent-rte:dpc=p-004-004-004:lsn=lsn4:rc=10
```

When this command has successfully completed, this message should appear.

```
rlghncxa03w 05-09-07 08:28:30 GMT EAGLE5 34.0.0
ENT-RTE: MASP A - COMPLTD
```

6. Verify the changes using the **rtrv-rte** command, specifying the destination point code of the route. For this example, enter this command.

```
rtrv-rte:dpca=p-004-004-004
```

This is an example of the possible output.

```
rlghncxa03w 05-09-07 11:43:04 GMT EAGLE5 34.0.0
```

DPCA	ALIASI	ALIASN/N24	LSN	RC	APCA
p-004-004-004	-----	s-00444-aa	lsn4	10	p-004-004-004
					CLLI=-----

7. Back up the new changes using the **chg-db:action=backup:dest=fixed** command. These messages should appear, the active Maintenance and Administration Subsystem Processor (MASP) appears first.

```
BACKUP (FIXED) : MASP A - Backup starts on active MASP.
BACKUP (FIXED) : MASP A - Backup on active MASP to fixed disk complete.
BACKUP (FIXED) : MASP A - Backup starts on standby MASP.
BACKUP (FIXED) : MASP A - Backup on standby MASP to fixed disk complete.
```

Flowchart 3-11. Adding a Route Containing an X.25 DPC (Sheet 1 of 2)

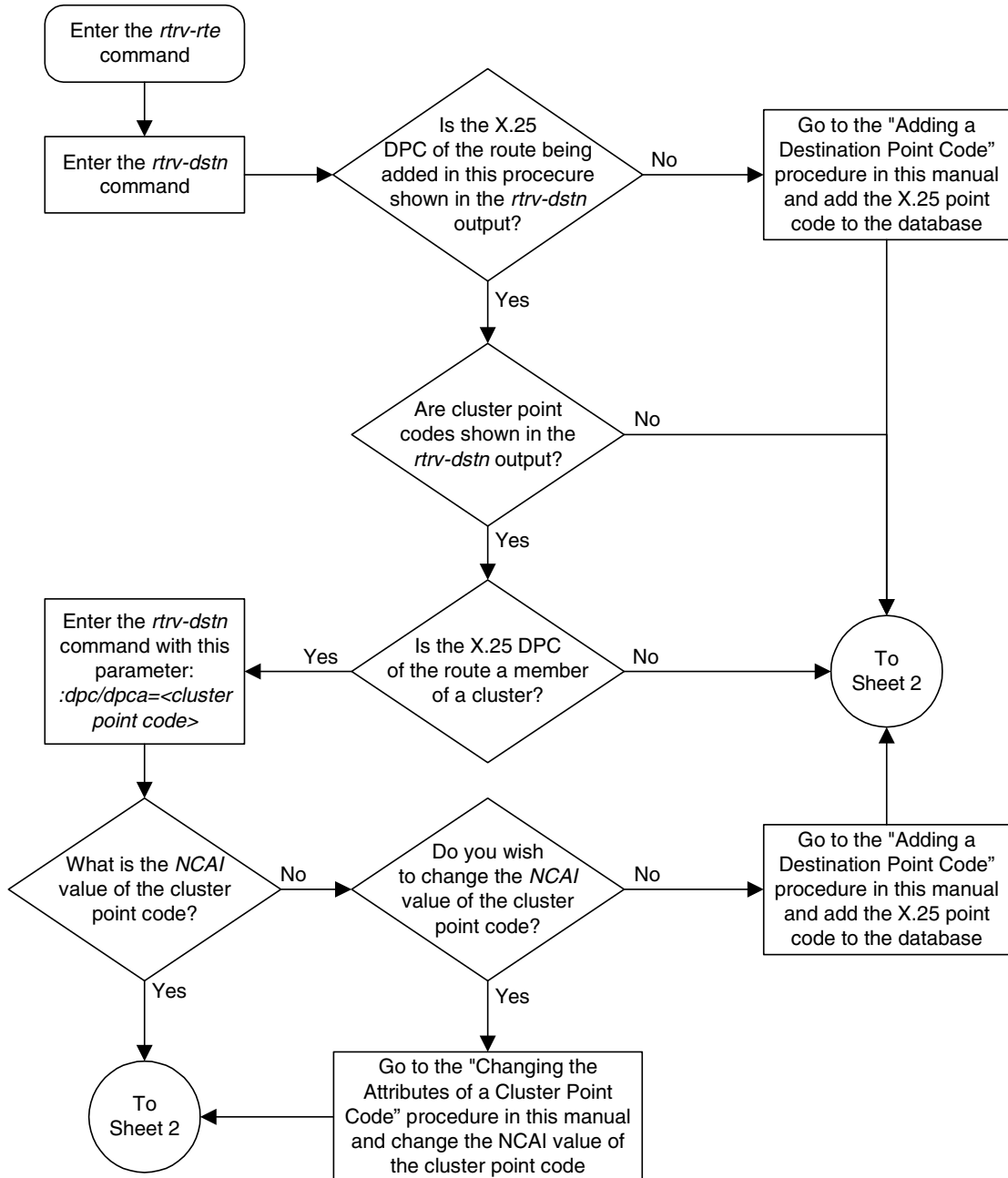

Flowchart 3-11. Adding a Route Containing an X.25 DPC (Sheet 2 of 2)

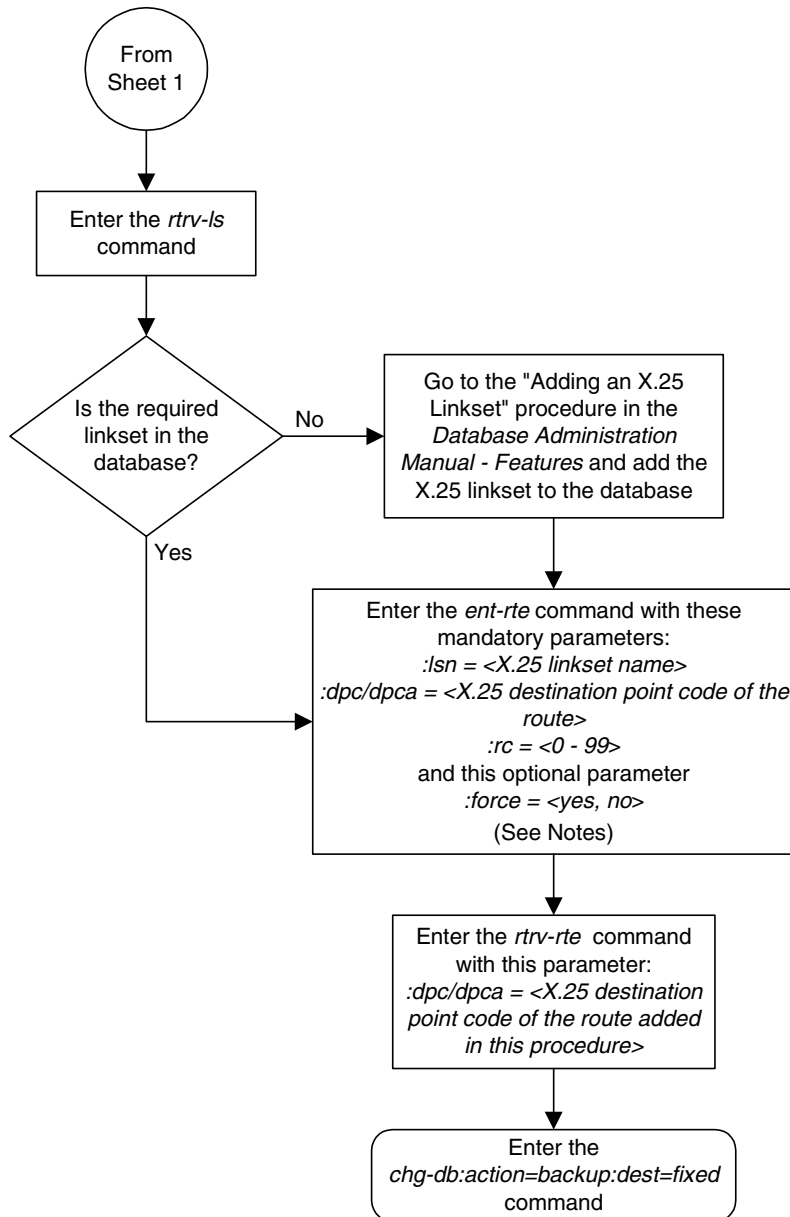

Notes:

1. The *force=yes* parameter must be specified if the linkset being assigned to the route has no signaling links assigned to it. Otherwise, each linkset must have at least one signaling link assigned to it.
2. A route can contain a maximum of six linksets.
3. The *rc* parameter values for all X.25 linksets assigned to this route cannot be equal.
4. Private point codes can be specified as the DPC of a route only if the linkset assigned to the route is an IPGWx linkset (a linkset that has the *ipgwapc=yes* parameter assigned to it).

Removing a Route

This procedure is used to remove a route from the database using the `dlt-rte` command.

The `dlt-rte` command uses these parameters.

`:dpc/dpca/dpci/dpcn/dpcn24` – The destination point code of the node that the traffic is bound for.

NOTE: See “Point Code Formats” on page 2-4 for a definition of the point code types that are used on the EAGLE 5 SAS and for a definition of the different formats that can be used for ITU national point codes.

`:lsn` – The name of the linkset that carries the traffic bound for the node specified by the destination point code.

`:all` – Are all routes associated with the DPC to be removed

The route to be removed must exist in the database. This can be verified in step 1.

The last route to a DPC cannot be removed if it is reference by a mated application or concerned signaling point code group. If this condition exists, the command to remove the route from the database is rejected. Before removing the last route to a DPC from the database, enter the `rtrv-cspc` and `rtrv-map` commands to verify if the DPC to the route being removed from the database is referenced by either mated applications or concerned signaling point code groups. If `rtrv-cspc` command output shows a reference to the DPC of the route being removed by this procedure (in the `PCA`, `PCI`, `PCN`, or `PCN24` fields), go to the “Removing Concerned Signaling Point Codes” procedure in the *Database Administration Manual – Features*. If the `rtrv-map` command output shows a reference to the DPC of the route being removed by this procedure (shown in the `PCA`, `PCI`, `PCN`, or `PCN24` fields), go to the “Removing a Mated Application” procedure in the *Database Administration Manual – Features*.

The last route to a DPC cannot be removed from the database if it is referenced by an X.25 route. Use the `rtrv-x25-dstn` command to verify which point codes (the `SS7 DPC` field) are assigned to each X.25 address (the `X25 ADDR` field). Use the `rtrv-x25-rte` to verify which X.25 address is assigned to each X.25 route (shown in the `X25 ADDR` or `SS7 ADDR` fields). If an X.25 route is referencing the destination of the route to be removed from the database, go to the “Removing an X.25 Route” procedure in the *Database Administration Manual – Features*.

The last route to a destination (Route DPC) cannot be removed if that route is referenced by the gateway screening redirect function's DPC parameter. Use the **rtrv-gws-redirect** command to verify the DPC used for the gateway screening redirect function. If the gateway screening redirect function is referencing the destination of the route to be removed from the database, change the gateway screening redirect function's DPC with the "Changing the Gateway Screening Redirect Parameters" procedures in the *Database Administration Manual – Features*. The gateway screening redirect function can also be disabled by using the "Disabling the Gateway Screening Redirect Function" procedure in the *Database Administration Manual – Features*.

Either the **lsn** or **all=yes** parameters must be specified with the **dlt-rte** command. If the **all=no** parameter is specified, the **lsn** parameter must be specified. If the **lsn** parameter is specified, the linkset must be defined in the database as a route to the specified route DPC. The linkset name is shown in the **LSN** field of the **rtrv-rte** command output.

The route assigned to a full point code DPC cannot be removed from the database if that DPC is a member of a cluster point code in the database if the network cluster allowed indicator (**ncai** parameter of either the **ent-dstn** or **chg-dstn** command) is set to no. If the nested cluster allowed indicator is set to yes, the route to the full point code DPC that is a member of a cluster point code can be removed from the database, but the route to the cluster point code will not be removed from the database, even if the cluster point code and the full point code are assigned to the same route. When the route to the member of the cluster point code is removed from the database, the member of the cluster point code assumes all the attributes of the cluster point code and will use the same routes that are assigned to the cluster point code.

If a route assigned to a cluster point code is removed from the database, all routes to any members of that cluster are also removed from the database if the network cluster allowed indicator is set to no. If the nested cluster allowed indicator is set to yes, the route to the cluster point code can be removed from the database, but any routes to any point codes that are members of the cluster point code remain in the database, even if the cluster point code and its members are assigned to the same route. For more information, see the "Nested Cluster Routing" section on page 2-135.

The destination point code of the route being removed from the database cannot be in the mated relay node (MRN) table. Verify this by entering the **rtrv-mrn** command, specifying the destination point code of the route being removed from the database. If the destination point code of the route is shown in the **rtrv-mrn** command output, remove the point code from the MRN table, by executing the "Removing an MRN Group or MRN Group Entry" procedure in the *Database Administration Manual – Features*.

The examples in this procedure are used to remove all routes to DPC **003-003-003** from the database.

Canceling the RTRV-RTE Command

Because the `rtrv-rte` command used in this procedure can output information for a long period of time, the `rtrv-rte` command can be canceled and the output to the terminal stopped. There are three ways that the `rtrv-rte` command can be canceled.

- Press the **F9** function key on the keyboard at the terminal where the `rtrv-rte` command was entered.
- Enter the `canc-cmd` without the `trm` parameter at the terminal where the `rtrv-rte` command was entered.
- Enter the `canc-cmd:trm=<xx>`, where `<xx>` is the terminal where the `rtrv-rte` command was entered, from another terminal other than the terminal where the `rtrv-rte` command was entered. To enter the `canc-cmd:trm=<xx>` command, the terminal must allow Security Administration commands to be entered from it and the user must be allowed to enter Security Administration commands. The terminal's permissions can be verified with the `rtrv-secu-trm` command. The user's permissions can be verified with the `rtrv-user` or `rtrv-secu-user` commands.

For more information about the `canc-cmd` command, go to the *Commands Manual*.

Procedure

1. Display the current route configuration using the `rtrv-rte` command. This is an example of the possible output.

```
rlghncxa03w 05-09-07 11:43:04 GMT EAGLE5 34.0.0

      DPCA          ALIASI          ALIASN/N24      LSN          RC          APCA
001-002-003 -----
                                -----          ls04          10          001-002-003
                                           CLLI=ls04c1li
002-002-100 -----
                                -----          ls01          10          002-002-100
                                           ls02          20          004-004-004
                                           ls03          30          003-003-003
                                           CLLI=ls01c1li
002-007-008 -----
                                -----          ls06          10          002-007-008
                                           CLLI=ls06c1li
002-009-003 -----
                                -----          ls05          10          002-009-003
                                           CLLI=-----
003-003-003 -----
                                -----          ls03          10          003-003-003
                                           ls01          20          002-002-100
                                           ls02          30          004-004-004
                                           CLLI=ls03c1li
004-004-004 -----
                                -----          ls02          10          004-004-004
                                           ls01          20          002-002-100
                                           ls03          30          003-003-003
                                           CLLI=ls02c1li
009-002-003 -----
                                -----          ls07          10          009-002-003
                                           CLLI=-----
```

```

140-012-004    1-111-1      11121      ls000001  10  240-012-002
               1-111-1      11121      ls000002  10  240-012-002
               1-111-1      11121      ls000003  20  240-012-002
               1-111-1      11121      ls000004  30  240-012-002
               1-111-1      11121      ls000005  40  240-012-002
               1-111-1      11121      ls000006  50  240-012-002
               CLLI=dp1
140-012-005    1-111-2      11122      ls000001  10  240-012-002
               1-111-2      11122      ls000002  10  240-012-002
               1-111-2      11122      ls000003  20  240-012-002
               1-111-2      11122      ls000004  30  240-012-002
               1-111-2      11122      ls000005  40  240-012-002
               1-111-2      11122      ls000006  50  240-012-002
               CLLI=dp2
179-100-087    -----
200-050-176    -----
               atmansi0  10  179-100-087
               CLLI=-----
               atmansi1  10  200-050-176
               CLLI=-----

DPCI          ALIASN/N24      ALIASA      LSN          RC          APC
2-234-5       11-13-3-3          240-111-111 ls100001     10          1-234-5
               11-13-3-3          240-111-111 ls100002     10          1-234-6
               11-13-3-3          240-111-111 ls100003     20          1-234-7
               11-13-3-3          240-111-111 ls100004     30          1-234-1
               11-13-3-3          240-111-111 ls100005     40          1-234-2
               11-13-3-3          240-111-111 ls100006     50          1-234-3
               CLLI=idp1
3-150-4       -----
               lsi7          10          3-150-4
               CLLI=lsi7clli

DPCN          ALIASA          ALIASI      LSN          RC          APC
10685         -----
13111         011-222-111 0-001-1      ls200001     10          11111
               011-222-111 0-001-1      ls200002     10          11112
               011-222-111 0-001-1      ls200003     20          11113
               011-222-111 0-001-1      ls200004     30          11114
               011-222-111 0-001-1      ls200005     40          11115
               011-222-111 0-001-1      ls200006     50          11116
               CLLI=ndp1

DPCN24        ALIASA          ALIASI      LSN          RC          APC

```

- Verify that the GTT feature is on, by entering the `rtrv-feat` command. If the GTT feature is on, the `GTT` field should be set to `on`.

NOTE: The `rtrv-feat` command output contains other fields that are not used by this procedure. If you wish to see all the fields displayed by the `rtrv-feat` command, see the `rtrv-feat` command description in the *Commands Manual*.

NOTE: If the GTT feature is off, skip steps 3 through 9, and go to step 10.

3. Display the mated applications in the database, using the **rtrv-map** command and the DPC of the route being removed from the database. For this example, enter this command.

```
rtrv-map:pca=003-003-003
```

This is an example of the possible output.

```
rlghncxa03w 05-09-07 00:34:31 GMT EAGLE5 34.0.0
MAP TABLE IS 1 % FULL (5 of 1024)

PCA          SSN RC MULT |-----MATE-----| SRM MRC GRP NAME SSO
                PCA          SSN RC MULT
003-003-003  252 10 SOL          --- --- GRP01    OFF
```

If the DPC of the route is shown in the **rtrv-map** command output (in the **PCA**, **PCI**, **PCN**, **PCN24**, **MPCA**, **MPCI**, **MCPN**, or **MPCN24** fields), go to the “Removing a Mated Application” procedure in the *Database Administration Manual - Global Title Translation*, and remove the remove the point code from the mated application that references the DPC of the route.

4. Display the group names in the database using the **rtrv-cspc** command. This is an example of the possible output.

```
rlghncxa03w 05-09-07 00:27:31 GMT EAGLE5 34.0.0
CSPC GRP   NETWORK          PERCENT FULL
GRP01     ANSI              3%
GRP02     ITU-I                81%
GRP03     ITU-N                54%
GRP04     ANSI                 42%
GRP05     ANSI                 15%
GRP10     ANSI                 15%
GRP15     ANSI                 15%
```

5. Display the point codes in the CSPC group shown in step 4, in the **GRP NAME** field, using the **rtrv-cspc** command with the CSPC group name whose point codes are the same network type as the DPC of the route being removed. Repeat this step until all CSPC groups with the same network type as the DPC of the route have been displayed. For this example, enter this command.

```
rtrv-cspc:grp=grp01
```

This is an example of the possible output.

```
rlghncxa03w 05-09-07 00:28:31 GMT EAGLE5 34.0.0
CSPC GRP   PC          TYPE
GRP01     003-003-003    A
          009-009-009    A
```

If the DPC of the route is in the CSPC group, go to the “Removing Concerned Signaling Point Codes” procedure in the *Database Administration Manual - Global Title Translation* and remove the point code from the CSPC group that references the DPC of the route.

6. Display the status of the Intermediate GTT Load Sharing (IGTTLS) controlled feature by entering this command.

```
rtrv-ctrl-feat:partnum=893006901
```

The following is an example of the possible output.

```
rlghncxa03w 05-09-28 21:15:37 GMT EAGLE5 34.0.0
The following features have been permanently enabled:
```

Feature Name	Partnum	Status	Quantity
INTERMED GTT LOAD SHARING	893006901	off	----

The following features have been temporarily enabled:

Feature Name	Partnum	Status	Quantity	Trial Period Left
Zero entries found.				

The following features have expired temporary keys:

Feature Name	Partnum
Zero entries found.	

NOTE: If the IGTTLS feature is not enabled, skip steps 7 and 8, and go to step 9.

7. Display the mated relay node (MRN) groups in the database, using the **rtrv-mrn** command. This is an example of the possible output.

```
rlghncxa03w 01-09-07 00:34:31 GMT EAGLE5 34.0.0
5-5-5
```

PC	RC
5-5-5	10
6-1-1	20
6-1-2	30
6-1-3	40
6-1-4	50

PC	RC
6-1-5	60
6-1-6	70
6-1-7	80
6-1-8	90

7-7-7

PC	RC
7-7-7	10
8-1-1	20
8-1-2	30
8-1-3	40
8-1-4	50

PC	RC
8-1-5	60
8-1-6	70
8-1-7	80
8-1-8	90

NOTE: If the DPC of the route is not shown in the `rtrv-mrn` output in step 8, skip this step and go to step 9.

8. Go to the "Removing an MRN Group or MRN Group Entry" procedure in the *Database Administration Manual - Global Title Translation*, and remove the remove the point code from the MRN group that references the DPC of the route.

NOTE: If the X.25 feature is off, skip steps 10 and 11, and go to step 12. If the DPC of the route is an ITU-I or ITU-N point code, skip steps 10, 11, 12, 13, and 14, and go to step 15.

9. Verify whether or not the DPC of the route is assigned to an X.25 destination by entering the `rtrv-x25-dstn` command. This is an example of the possible output.

```
rlghncxa03w 05-09-28 21:16:37 EDT EAGLE5 34.0.0
X25 ADDR          SS7 DPC          SSN
11101             244-020-004    005
220525586456772  244-020-005    002
33301             244-020-006    006
423423045656767  244-020-007    112
55501             244-020-008    005
X.25 DSTN TABLE IS 1 % FULL
```

If the X.25 DPC is assigned to an X.25 destination, go to step 8. Otherwise skip step 8, and go to step 9.

10. Verify whether or not the X.25 destination is assigned to an X.25 route by entering the `rtrv-x25-rte` command. This is an example of the possible output.

```
rlghncxa03w 05-09-28 21:16:37 EDT EAGLE5 34.0.0
X25 ADDR          SS7 ADDR          TYPE  LOC  PORT  LC  RT  LC2NM
11101             44401             pvc   1205 a     01  pc  no
220525586456772  342342341234567  pvc   1201 a     02  xpc yes
33301             44401             svca  1207 a     --  pc  no
33302             55501             svca  1207 a     --  pc  no
423423045656767  34223422845      svca  1202 a     --  pc  no
X.25 ROUTE TABLE IS 1 % FULL
```

If the `rtrv-x25-rte` command output shows X.25 routes using the X.25 destinations assigned to the DPC of the route being removed from the database, go to the "Removing an X.25 Route" procedure in the *Database Administration Manual - Features* to remove the X.25 routes that are using the X.25 destinations assigned to the DPC of the route.

After the X.25 routes have been removed from the database, or if no X.25 routes are using the X.25 destinations assigned to the X.25 DPC, go to the "Removing an X.25 Gateway Destination" procedure in the *Database Administration Manual - Features* and remove the X.25 destinations assigned to the DPC from the database.

11. Verify whether or not the DPC of the route is referenced by the gateway screening redirect function by entering the `rtrv-gws-redirect` command. The following is an example of the possible output.

```
rlghncxa03w 05-09-07 00:17:31 GMT EAGLE5 34.0.0
```

```
ENABLED DPC          RI  SSN  TT      GTA
on      003-003-003  GT  15   225    9105551212
```

If the DPC of the route is shown in the **DPC** field, go to the “Changing the Gateway Screening Redirect Parameters” procedure in the *Database Administration Manual - Features* and change the gateway screening redirect function’s DPC.

12. Verify whether or not the DPC of the route is a member of a cluster point code by entering the `rtrv-dstn` command with the value of the `dpca` parameter containing the network and cluster values of the DPC of the route, and three asterisks (***) for the network-cluster member value of the point code. For this example, enter this command.

```
rtrv-dstn:dpca=003-003-***
```

This is an example of the possible output.

```
rlghncxa03w 05-09-17 16:00:32 GMT EAGLE5 34.0.0
  DPCA          CLLI          BEI  ELEI    ALIASI          ALIASN/N24    DOMAIN
  003-003-*     rlghncbb333  yes  no     -----        -----      SS7
  003-003-003   rlghncbb334  no   ---    1-112-3        10-13-10-1    SS7
  003-003-200   rlghncbb335  no   ---    1-117-3        10-13-11-1    SS7
  003-003-225   rlghncbb336  no   ---    -----        -----      SS7

          SPC          NCAI
          -----      no
```

```
Destination table is (11 of 2000) 1% full
```

```
Alias table is (6 of 8000) 1% full
```

```
RTRV-DSTN: MASP A - COMPLTD
```

- If the DPC of the route is not a member of a cluster point code, go to step 15.
If the DPC of the route is a member of a cluster point code, go to step 14.

13. Display the attributes of the cluster point code by entering the **rtrv-dstn** command with the cluster point code value. For this example, enter this command.

rtrv-dstn:dpca=003-003-*

This is an example of the possible output.

```
rlghncxa03w 05-09-28 21:16:37 GMT EAGLE5 34.0.0
  DPCA          CLLI          BEI ELEI  ALIASI          ALIASN/N24  DOMAIN
  003-003-*    rlghncbb333 yes no  -----  -----  SS7

          SPC          NCAI
          -----  no
```

```
Destination table is (11 of 2000) 1% full
Alias table is (6 of 8000) 1% full
RTRV-DSTN: MASP A - COMPLTD
```

If the value of the **NCAI** field is **yes**, go to step 14.

If the value of the **NCAI** field is **no**, the route to the DPC (if the DPC is not a cluster point code) cannot be removed. To remove the route to this DPC, go to the "Changing the Attributes of a Cluster Point Code" procedure on page 2-161 and change the **NCAI** field value of the cluster point code to **yes**.

14. Remove the routes from the database using the **dlt-rte** command. For this example, enter this command.

dlt-rte:dpca=003-003-003:all=yes

A specific route to a DPC can be removed from the database. To do this, specify the **lsn** parameter instead of the **all** parameter and the linkset name of the route you wish to remove. For this example, enter this command.

dlt-rte:dpca=003-003-003:lsn=ls01

If the **NCAI** field value in step 14 is no, and was not changed, enter the **dlt-rte** command specifying the cluster point code as the value of the **dpca** parameter. For this example, enter this command.

dlt-rte:dpca=003-003-*:all=yes

When either of these commands have successfully completed, this message should appear.

```
rlghncxa03w 05-09-07 08:45:54 GMT EAGLE5 34.0.0
DLT-RTE: MASP A - COMPLTD
```

15. Verify the changes using the `rtrv-rte` command, specifying the destination point code of the route. For this example, enter this command.

```
rtrv-rte:dpc=003-003-003
```

If all routes to the DPC were removed in step 14, this is an example of the possible output.

```
rlghncxa03w 05-09-10 11:43:04 GMT EAGLE5 34.0.0
  DPCA          ALIASI          ALIASN/N24    LSN          RC          APCA
  003-003-003  -----
                                           CLLI=ls03clli
```

If a specific route to the DPC was removed in step 14, this is an example of the possible output.

```
rlghncxa03w 05-09-10 11:43:04 GMT EAGLE5 34.0.0
  DPCA          ALIASI          ALIASN/N24    LSN          RC          APCA
  003-003-003  -----
                                           ls03         10         003-003-003
                                           ls02         30         004-004-004
                                           CLLI=ls03clli
```

16. Back up the new changes using the `chg-db:action=backup:dest=fixed` command. These messages should appear, the active Maintenance and Administration Subsystem Processor (MASP) appears first.

```
BACKUP (FIXED) : MASP A - Backup starts on active MASP.
BACKUP (FIXED) : MASP A - Backup on active MASP to fixed disk complete.
BACKUP (FIXED) : MASP A - Backup starts on standby MASP.
BACKUP (FIXED) : MASP A - Backup on standby MASP to fixed disk complete.
```

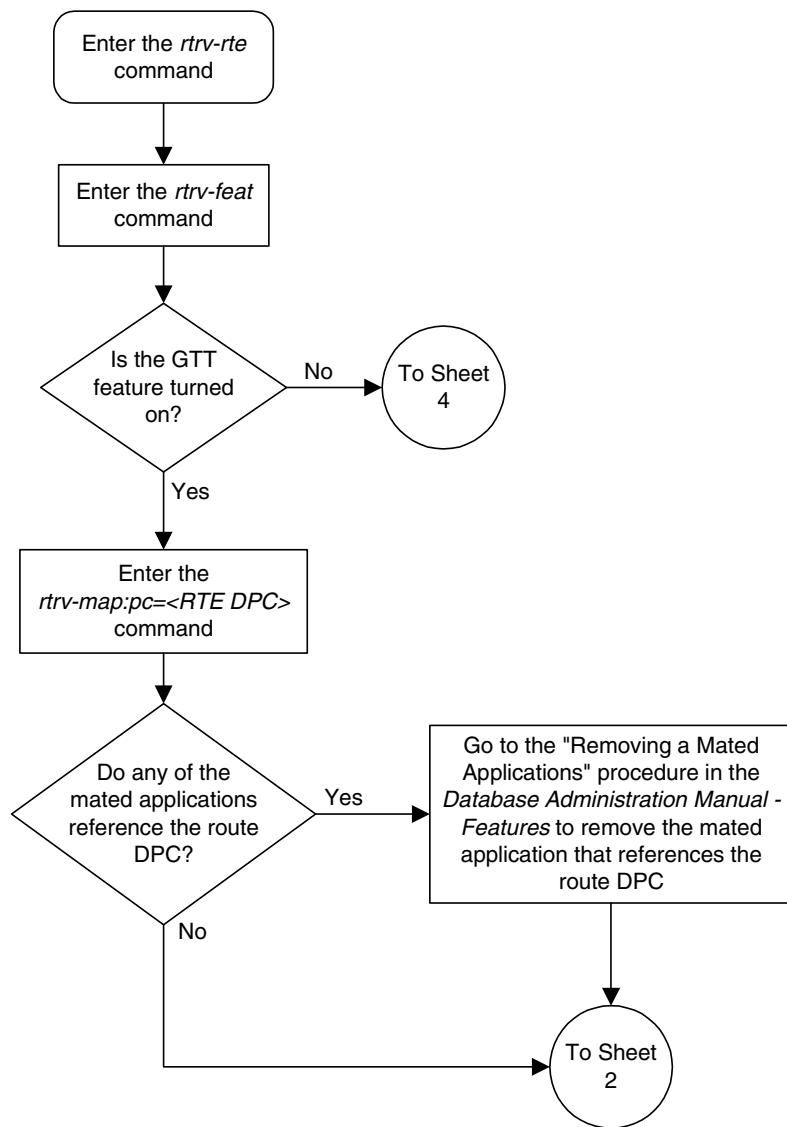

Flowchart 3-12. Removing a Route (Sheet 1 of 7)

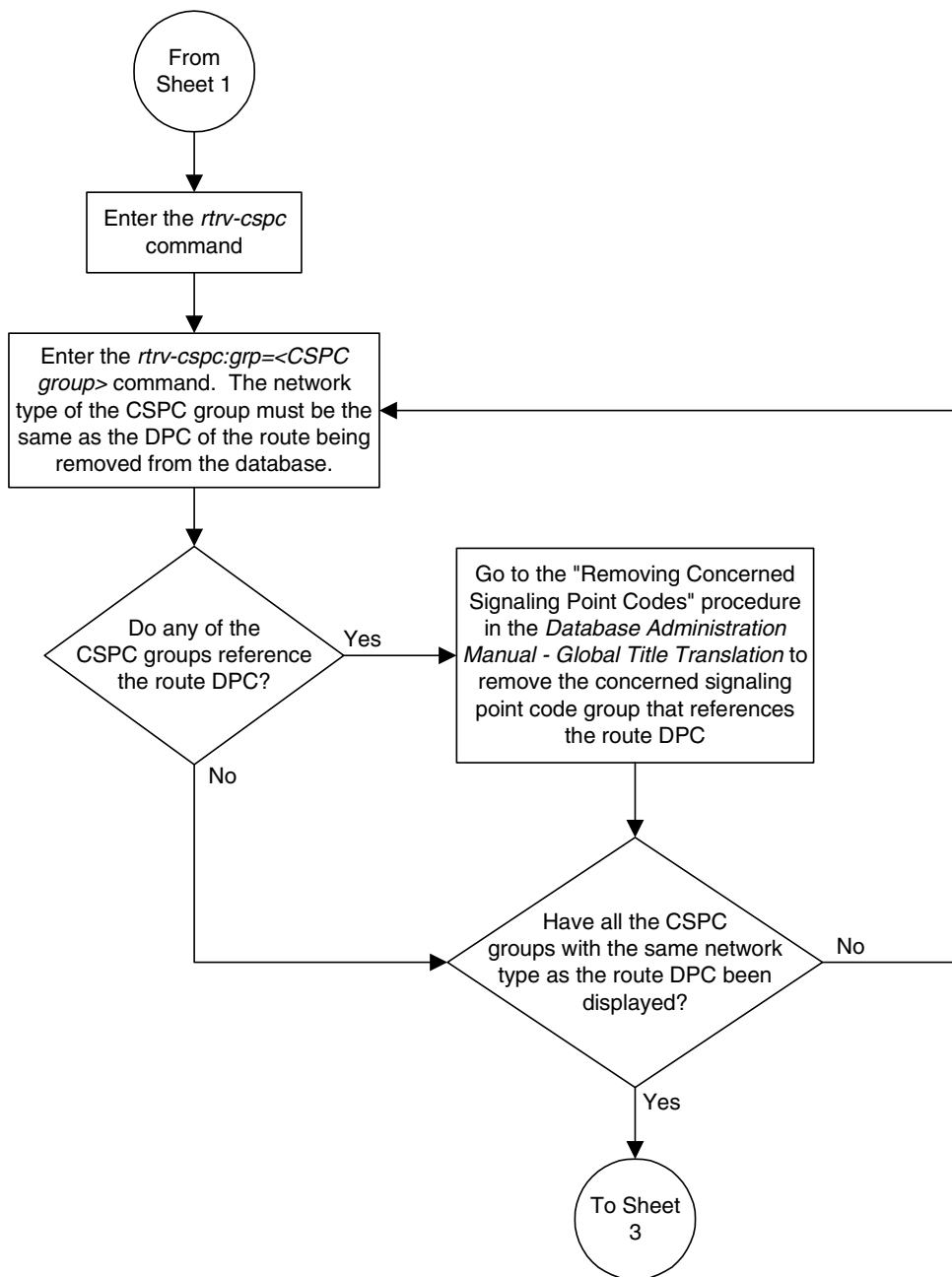

Flowchart 3-12. Removing a Route (Sheet 2 of 7)

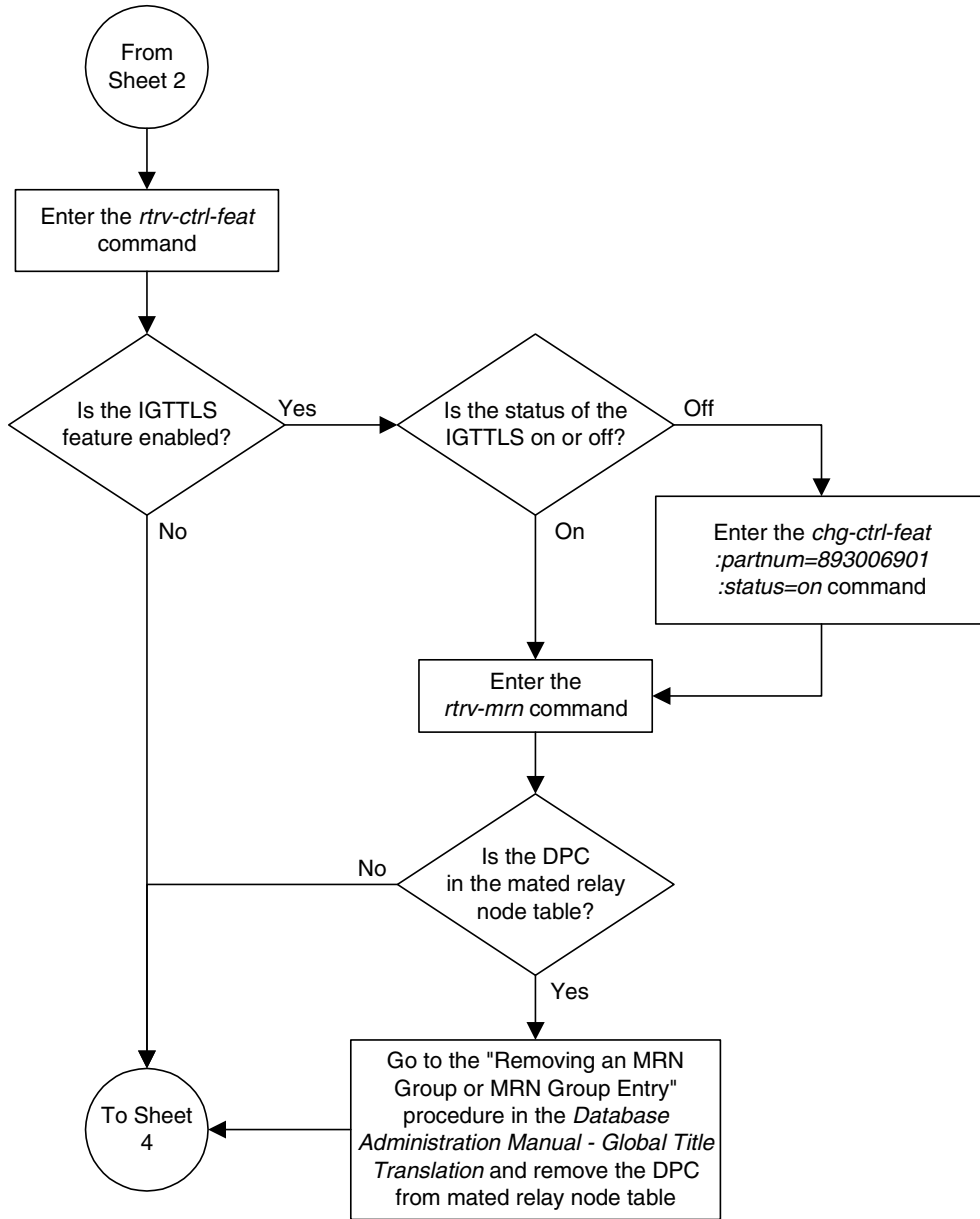

Flowchart 3-12. Removing a Route (Sheet 3 of 7)



Flowchart 3-12. Removing a Route (Sheet 4 of 7)

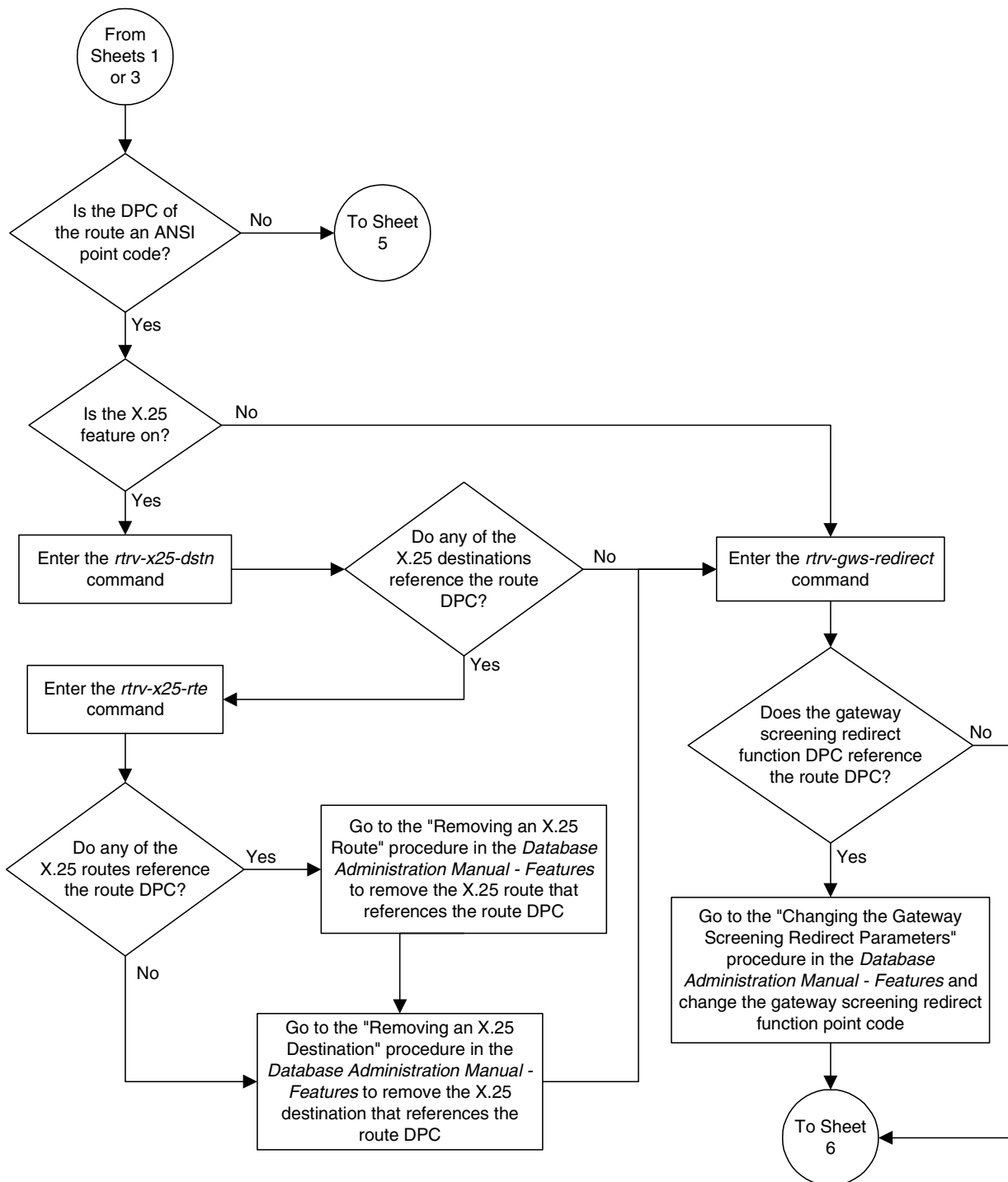

Flowchart 3-12. Removing a Route (Sheet 5 of 7)

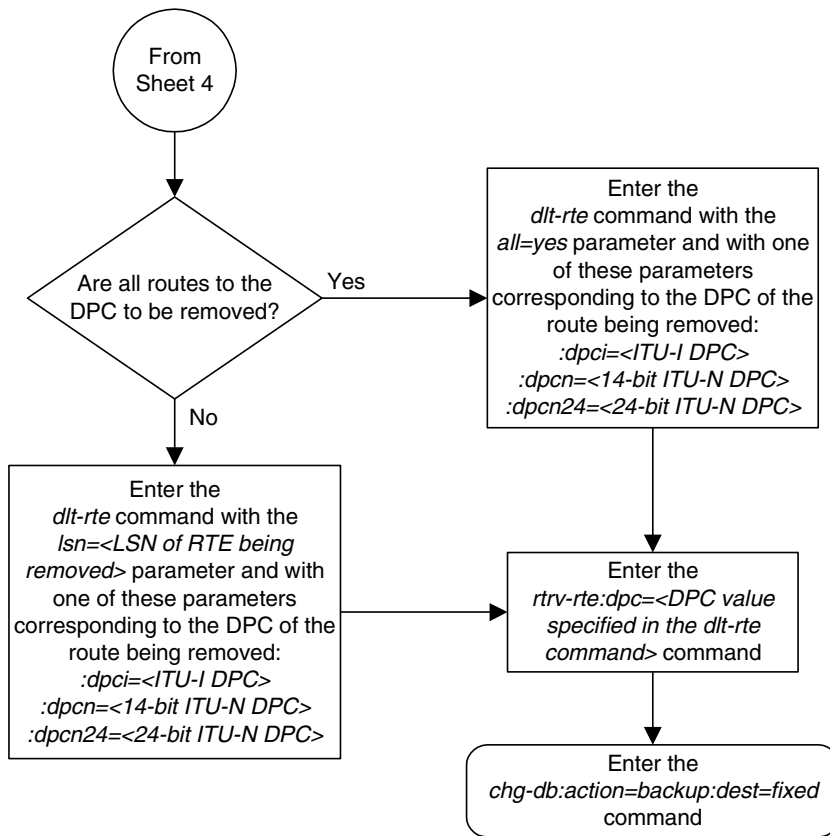

Flowchart 3-12. Removing a Route (Sheet 6 of 7)

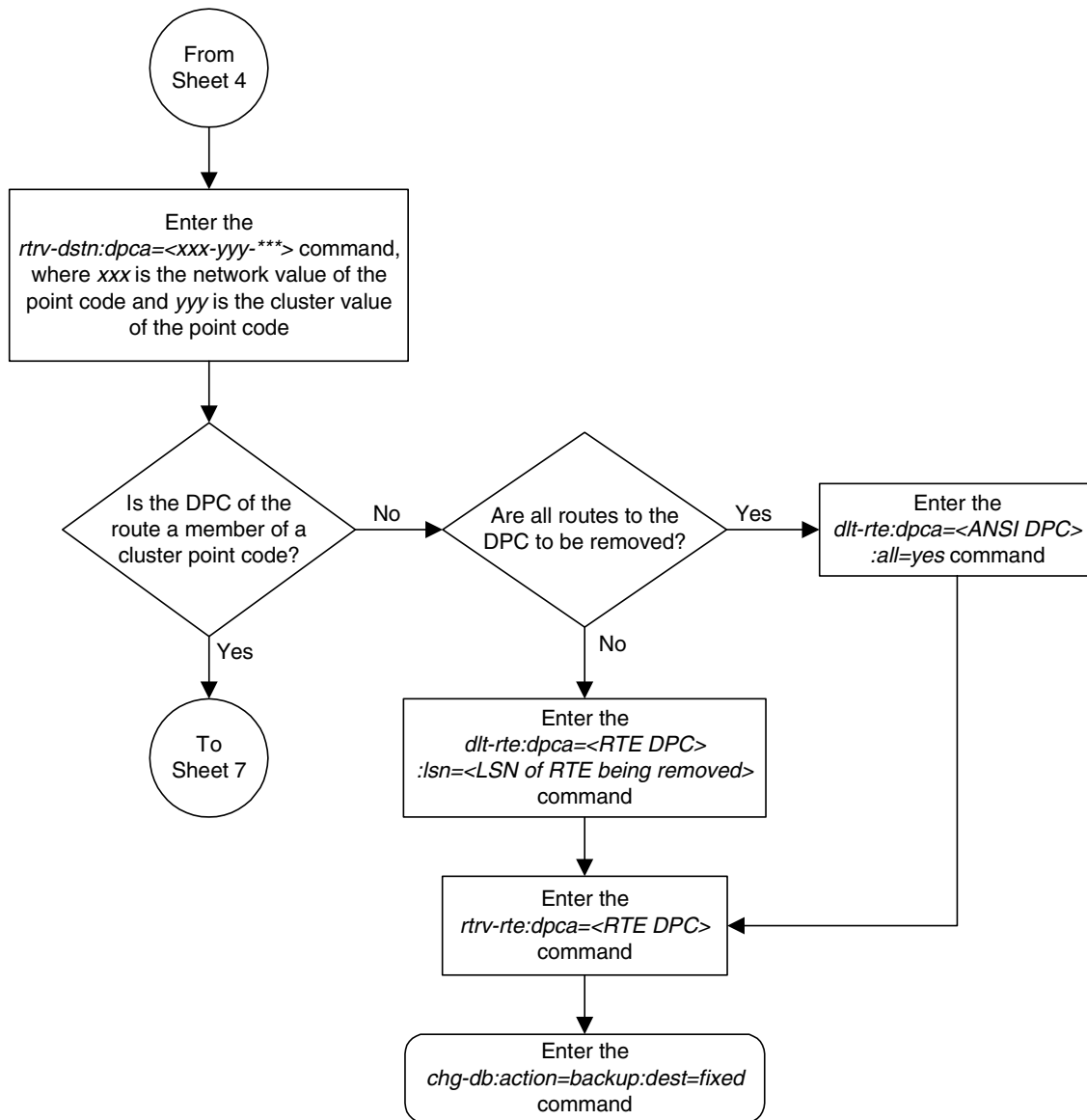

Flowchart 3-12. Removing a Route (Sheet 7 of 7)

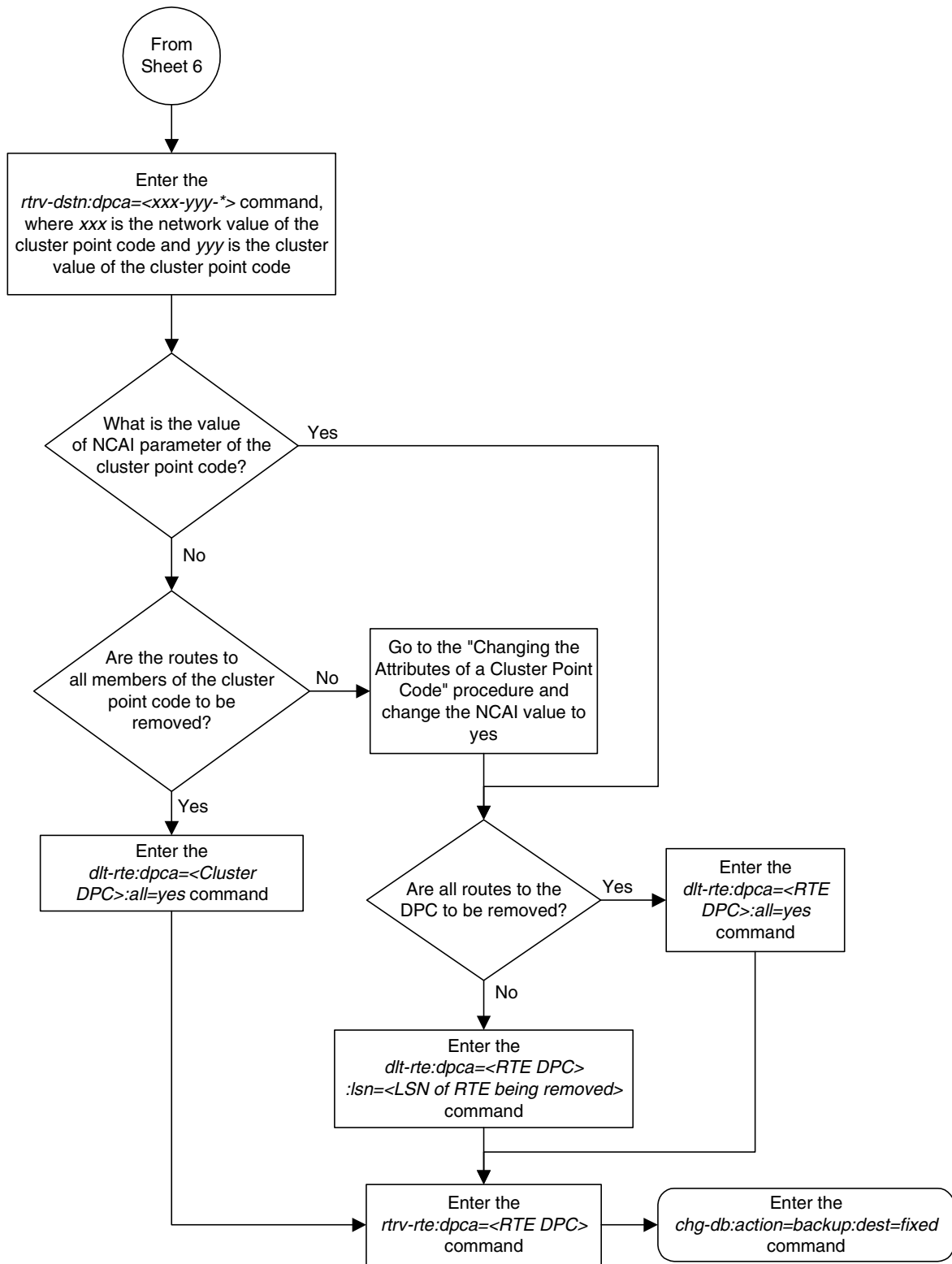

Changing a Route

This procedure is used to change the relative cost of a route in the database using the **chg-rte** command.

The **chg-rte** command uses these parameters.

:dpc/dpca/dpci/dpcn/dpcn24 – The destination point code of the node that the traffic is bound for.

NOTE: See “Point Code Formats” on page 2-4 for a definition of the point code types that are used on the EAGLE 5 SAS and for a definition of the different formats that can be used for ITU national point codes.

:lsn – The name of the linkset that will carry the traffic bound for the node specified by the destination point code.

:rc – The relative cost (priority) for this route.

:nlsn – The name of the new linkset that will carry the traffic bound for the node specified by the destination point code.

The route to be changed must exist in the database. This can be verified in step 1.

A maximum of two linksets can be assigned the same cost. The cost of the route is defined by the **rc** parameter of the **chg-rte** command and is shown in the **RC** field in the output of the **rtrv-rte** command.

The linkset name specified by the **lsn** parameter must be defined in the database as a route.

The examples in this procedure are used to change the relative cost assigned to the linkset **ls01** for the route to DPC 003-003-003 in the database to change the name of linkset **ls01** to **lsa2**.

If the destination of a route (**DPC/DPCA**) is in the X.25 domain, no routes to that destination can be assigned the same cost value (**RC**) in the same routeset. If two routes in a routeset were assigned the same cost value, this creates a combined linkset and combined linksets to DPCs in the X.25 domain are not allowed.

The ANSI DPC (**DPC/DPCA**) of the route can use either a full point code, a cluster point code, or a network routing point code. ITU DPCs (**DPCI** and **DPCN** - 14-bit or 24-bit **DPCNs**) must use full point codes. For more information on full and cluster point codes, go to the “Cluster Routing and Management Diversity (CRMD)” section on page 2-119. For more information on network routing point codes, go to the “Network Routing” section on page 2-174.

SS7 Configuration

The DPC of the route must be of the same format as the APC of the linkset being added to the route. That is, routes containing ANSI DPCs must have linksets with ANSI APCs; routes containing ITU-I DPCs must have linksets with ITU-I APCs; routes containing 14-bit ITU-N DPCs must have linksets with 14-bit ITU-N APCs; routes containing 24-bit ITU-N DPCs must have linksets with 24-bit ITU-N APCs. The DPC of the route must be defined as a true point code in the **rtrv-dstn** output. Alias point codes and secondary point codes cannot be used. True point codes are shown in the output of the **rtrv-dstn** command in the **DPCA**, **DPCI**, **DPCN**, or **DPCN24** fields.

Either the **n1sn** or **rc** parameters, or both, must be specified with the **chg-rte** command. If neither of these parameters are specified, the command is rejected.

The new linkset specified by the **n1sn** parameter cannot be assigned to any existing routes. If the new linkset is assigned to any existing routes, the command is rejected. This can be verified with the **rtrv-rte** command.

The linkset specified by the **n1sn** parameter must be in the database and must contain at least one signaling link. This can be verified with the **rtrv-ls** command and specifying the name of the linkset with the **1sn** parameter.

If the DPC of the route is a cluster point code, only linksets, specified with either the **1sn** or **n1sn** parameters, whose linkset type is either B, C, or D can be assigned to the route. The linkset type is shown in the **LST** field of the **rtrv-ls** command output. If the linkset type of the desired linkset is either A or E, one of three actions must be taken.

- Choose another linkset with the linkset type B, C, or D.
- Change the linkset type of an existing linkset – go to the “Changing an SS7 Linkset” procedure on page 3-74.
- Add a new linkset to the database with the necessary signaling links and the linkset type B, C, or D.
 - a. Go to the “Adding an SS7 Linkset” procedure on page 3-17 to add the linkset.
 - b. If the necessary signaling links are not in the database, go to the “Adding an SS7 Signaling Link” procedure on page 3-130 and add the signaling links to the database.

If the DPC of the route is a private point code, the new linkset specified for the route being changed must be an IPGWx linkset (a linkset containing the **ipgwapc=yes** parameter value).

If the DPC of the route is a member of a cluster point code, and the nested cluster allowed indicator (**ncai** parameter of either the **ent-dstn** or **chg-dstn** command) is set to **no**, then all destinations in the cluster have the same route as the cluster point code, with the same attributes as the route to the cluster point code. If the nested cluster allowed indicator is set to **yes**, then the routes to the members of the cluster point code, and the attributes of these routes, can be different from the route to the cluster point code. For more information, see the “Nested Cluster Routing” section on page 2-135.

For routes containing 14-bit ITU National DPCs with group codes, if the linkset assigned to the route has the **MULTGC** value set to **yes**, then 14-bit ITU National DPCs with group codes that are different from the linkset APC group code can be assigned to the route. If the **MULTGC** value is set to **no**, then only 14-bit ITU National DPCs with group codes that are the same as the linkset APC group code can be assigned to the route.

Canceling the **RTRV-LS** and **RTRV-RTE** Commands

Because the **rtrv-ls** and **rtrv-rte** commands used in this procedure can output information for a long period of time, the **rtrv-ls** and **rtrv-rte** commands can be canceled and the output to the terminal stopped. There are three ways that the **rtrv-ls** and **rtrv-rte** commands can be canceled.

- Press the **F9** function key on the keyboard at the terminal where the **rtrv-ls** or **rtrv-rte** commands were entered.
- Enter the **canc-cmd** without the **trm** parameter at the terminal where the **rtrv-ls** or **rtrv-rte** commands were entered.
- Enter the **canc-cmd:trm=<xx>**, where **<xx>** is the terminal where the **rtrv-ls** or **rtrv-rte** commands were entered, from another terminal other than the terminal where the **rtrv-ls** or **rtrv-rte** commands were entered. To enter the **canc-cmd:trm=<xx>** command, the terminal must allow Security Administration commands to be entered from it and the user must be allowed to enter Security Administration commands. The terminal’s permissions can be verified with the **rtrv-secu-trm** command. The user’s permissions can be verified with the **rtrv-user** or **rtrv-secu-user** commands.

For more information about the **canc-cmd** command, go to the *Commands Manual*.

Procedure

1. Display the current route configuration using the `rtrv-rte` command. This is an example of the possible output.

```

rlghncxa03w 05-09-07 11:43:04 GMT EAGLE5 34.0.0
  DPCA          ALIASI      ALIASN/N24    LSN          RC    APCA
001-002-003 -----
                                ls04          10    001-002-003
                                CLLI=ls04clli
002-002-100 -----
                                ls01          10    002-002-100
                                ls02          20    004-004-004
                                ls03          30    003-003-003
                                CLLI=ls01clli
002-007-008 -----
                                ls06          10    002-007-008
                                CLLI=ls06clli
002-009-003 -----
                                ls05          10    002-009-003
                                CLLI=-----
003-003-003 -----
                                ls03          10    003-003-003
                                ls01          20    002-002-100
                                ls02          30    004-004-004
                                CLLI=ls03clli
004-004-004 -----
                                ls02          10    004-004-004
                                ls01          20    002-002-100
                                ls03          30    003-003-003
                                CLLI=ls02clli
009-002-003 -----
                                ls07          10    009-002-003
                                CLLI=-----
140-012-004  1-111-1      11121      ls000001    10    240-012-002
                                ls000002    10    240-012-002
                                ls000003    20    240-012-002
                                ls000004    30    240-012-002
                                ls000005    40    240-012-002
                                ls000006    50    240-012-002
                                CLLI=dp1
140-012-005  1-111-2      11122      ls000001    10    240-012-002
                                ls000002    10    240-012-002
                                ls000003    20    240-012-002
                                ls000004    30    240-012-002
                                ls000005    40    240-012-002
                                ls000006    50    240-012-002
                                CLLI=dp2
179-100-087 -----
                                atmansi0    10    179-100-087
                                CLLI=-----
200-050-176 -----
                                atmansi1    10    200-050-176
                                CLLI=-----

  DPCI          ALIASN/N24    ALIASA      LSN          RC    APC
2-234-5      11-13-3-3      240-111-111 ls100001    10    1-234-5
                                ls100002    10    1-234-6
                                ls100003    20    1-234-7
                                ls100004    30    1-234-1
                                ls100005    40    1-234-2
                                ls100006    50    1-234-3
                                CLLI=idp1
3-150-4 -----
                                lsi7          10    3-150-4
                                CLLI=lsi7clli

  DPCN          ALIASA      ALIASI      LSN          RC    APC
10685 -----
                                lsn5          10    10685
                                CLLI=lsi5clli

```

```

13111          011-222-111 0-001-1          ls200001  10  11111
                                           ls200002  10  11112
                                           ls200003  20  11113
                                           ls200004  30  11114
                                           ls200005  40  11115
                                           ls200006  50  11116
                                           CLLI=ndp1

```

```

DPCN24          ALIASA          ALIASI  LSN          RC          APC

```

2. If the linkset name is being changed, display the linksets in the database with the `rtrv-ls` command. This is an example of the possible output. If the linkset name is not being changed, go to step 3.

```
rlghncxa03w 05-09-10 11:43:04 GMT EAGLE5 34.0.0
```

```

                L3T SLT                GWS GWS GWS
LSN          APCA  (SS7)  SCRN SET SET BEI LST LNKS ACT MES DIS SLSCI NIS
e1e2         001-207-000  none 1  1  no B  6  off off off no  off
ls1305       000-005-000  none 1  1  no A  1  off off off no  off
ls1307       000-007-000  none 1  1  no A  1  off off off no  off
e1m1s1      001-001-001  none 1  1  no A  7  off off off no  off
e1m1s2      001-001-002  none 1  1  no A  7  off off off no  off

```

```

                L3T SLT                GWS GWS GWS
LSN          APCA  (X25)  SCRN SET SET BEI LST LNKS ACT MES DIS SLSCI NIS

```

```

                L3T SLT                GWS GWS GWS
LSN          APCI  (SS7)  SCRN SET SET BEI LST LNKS ACT MES DIS SLSCI NIS
e1e2i       1-207-0      none 1  1  no B  4  off off off --- on
ls1315      0-015-0      none 1  1  no A  1  off off off --- off
ls1317      0-017-0      none 1  1  no A  1  off off off --- on
e1m2s1     1-011-1      none 1  1  no A  7  off off off --- off
e1m2s2     1-011-2      none 1  1  no A  7  off off off --- off

```

```

                L3T SLT                GWS GWS GWS
LSN          APCN  (SS7)  SCRN SET SET BEI LST LNKS ACT MES DIS SLSCI NIS

```

```

                L3T SLT                GWS GWS GWS
LSN          APCN24 (SS7)  SCRN SET SET BEI LST LNKS ACT MES DIS SLSCI NIS

```

```

                L3T SLT                GWS GWS GWS
LSN (CHINA) APCN  (SS7)  SCRN SET SET BEI LST LNKS ACT MES DIS SLSCI NIS

```

```

                L3T SLT                GWS GWS GWS
LSN (CHINA) APCN24 (SS7)  SCRN SET SET BEI LST LNKS ACT MES DIS SLSCI NIS

```

Link set table is (10 of 1024) 1% full.

If the new linkset to be added to the route is shown in the `rtrv-ls` output, skip step 3 and go to step 4.

If the new linkset to be added to the route is not shown in the `rtrv-ls` output, and the DPC of the route is not an ANSI point code, add the new linkset by performing the “Adding an SS7 Linkset” procedure on page 3-17. After the linkset has been added, go to step 4.

If the new linkset to be added to the route is not shown in the `rtrv-ls` output, and the DPC of the route is an ANSI point code, go to step 3.

- The ANSI DPC of the route can be either an SS7 or X.25 point code. Verify the domain of the ANSI DPC (SS7 or X.25) by entering the `rtrv-dstn` command with the DPC of the route. For this example, enter this command.

```
rtrv-dstn:dpca=003-003-003
```

This is an example of the possible output.

```
rlghncxa03w 05-09-28 21:16:37 GMT EAGLE5 34.0.0
  DPCA          CLLI          BEI ELEI  ALIASI          ALIASN/N24      DOMAIN
  003-003-003  ----- yes no  -----          -----          SS7

                SPC          NCAI
                -----          no
```

```
Destination table is (12 of 2000) 1% full
Alias table is (6 of 8000) 1% full
RTRV-DSTN: MASP A - COMPLTD
```

If the domain of the point code is SS7, add the new linkset by performing the “Adding an SS7 Linkset” procedure on page 3-17.

If the domain of the point code is X.25, add the new linkset by performing the “Adding an X.25 Linkset” procedure in the *Database Administration Manual - Features*.

NOTE: If the DPC of the route is not a cluster point code, skip step 4 and go to step 5.

- Display the `ncai` parameter value assigned to the cluster point code using the `rtrv-dstn` command and specifying the cluster point code. If the `ncai` parameter value is `no`, then the route to the DPC must be the same as the route to the cluster point code. If the `ncai` parameter value is `yes`, the route to the member of the cluster does not have to be the same as the route to the cluster point code. The `ncai` value is shown in the `NCAI` field of the `rtrv-dstn` output. For this example, enter this command.

```
rtrv-dstn:dpca=111-011-*
```

This is an example of the possible output.

```
rlghncxa03w 05-09-28 21:16:37 GMT EAGLE5 34.0.0
  DPCA          CLLI          BEI ELEI  ALIASI          ALIASN/N24      DOMAIN
  111-011-*    rlghncbb000 yes yes  -----          -----          SS7

                SPC          NCAI
                -----          yes
```

```
Destination table is (12 of 2000) 1% full
Alias table is (6 of 8000) 1% full
RTRV-DSTN: MASP A - COMPLTD
```

NOTE: If the DPC of the route is not a cluster point code, a 14-bit ITU-N point code with group codes, or a private point code, skip this step and go to step 6.

5. Display each linkset being assigned to the route to verify the **multgc** and **ipgwapc** parameter values with the **rtrv-ls** command, specifying the name of the linkset that will be assigned to the route.

If the **multgc** linkset parameter value is **yes**, then 14-bit ITU National DPCs with group codes that are different from the linkset APC group code can be assigned to the route. If the **multgc** value is set to **no**, then only 14-bit ITU National DPCs with group codes that are the same as the linkset APC group code can be assigned to the route. The **multgc** value is shown in the **MULTGC** field of the **rtrv-ls** output.

The **ipgwapc** linkset parameter value is **yes**, the DPC of the route cannot be a cluster point code. The **ipgwapc** value is shown in the **IPGWAPC** field of the **rtrv-ls** output.

If the DPC of the route is a private point code, the new linkset specified for the route being changed must be an IPGWx linkset (a linkset containing the **ipgwapc=yes** parameter value).

For this example, enter the following commands.

```
rtrv-ls:lsn=ls1317
```

This is an example of the possible output.

```
rlghncxa03w 05-09-17 11:43:04 GMT EAGLE5 34.0.0

LSN          APCI  (SS7)  SCRN SET SET BEI LST LNKS ACT MES DIS SLSCI NIS
ls1317      0-017-0      none 1  1  no  A  1  off off off ---  on

          CLLI          TFATCABMLQ MTPRSE ASL8  SLRSRB ITUTFR IPGWAPC
          -----  1          no      ---  1      off    yes

          LOC LINK SLC TYPE          L2T          L1          PCR PCR
          1317 A      0  IPGWI      SET  BPS      MODE TSET  ECM  N1  N2

          LOC LINK SLC TYPE          LP          ATM          VCI  VPI  LL
          LOC LINK SLC TYPE          SET  BPS      TSEL          VCI  VPI  LL

          LOC LINK SLC TYPE          LP          ATM          VCI  VPI  CRC4 SI SN
          LOC LINK SLC TYPE          SET  BPS      TSEL          VCI  VPI  CRC4 SI SN

          LOC LINK SLC TYPE          IPLIML2

          LOC LINK SLC TYPE

          LOC LINK SLC TYPE          L2T          PCR PCR  E1  E1
          1317 A      0  IPGWI      SET  BPS      ECM  N1  N2  LOC  PORT TS

          LOC LINK SLC TYPE          L2T          PCR PCR  T1  T1
          LOC LINK SLC TYPE          SET  BPS      ECM  N1  N2  LOC  PORT TS

SAPCN
00136
```

Link set table is (10 of 1024) 1% full.

SS7 Configuration

rtrv-ls:lsn=ele2i

This is an example of the possible output.

rlghncxa03w 05-09-10 11:43:04 GMT EAGLE5 34.0.0

LSN	APCI	(SS7)	SCRN	L3T	SLT	BEI	LST	LNKS	ACT	MES	DIS	SLSCI	NIS
ele2i	1-202-0		none	1	1	no	B	10	off	off	off	---	on

CLLI	TFATCABMLQ	MTPRSE	ASL8	SLSRSB	ITUTFR	IPGWAPC
-----	5	no	---	1	off	no

LOC	LINK	SLC	TYPE	L2T	BPS	L1	TSET	ECM	PCR	PCR
				SET		MODE			N1	N2

LOC	LINK	SLC	TYPE	LP	BPS	ATM	TSEL	VCI	VPI	LL
				SET						

LOC	LINK	SLC	TYPE	LP	BPS	ATM	TSEL	VCI	VPI	E1ATM	CRC4	SI	SN
				SET									

LOC	LINK	SLC	TYPE	IPLIML2
1311	A	0	IPLIMI	SAALTALI
1313	A	1	IPLIMI	SAALTALI
1311	B	2	IPLIMI	SAALTALI
1313	B	3	IPLIMI	SAALTALI

LOC LINK SLC TYPE

LOC	LINK	SLC	TYPE	L2T	BPS	ECM	PCR	PCR	E1	E1	
				SET			N1	N2	LOC	PORT	TS

LOC	LINK	SLC	TYPE	L2T	BPS	ECM	PCR	PCR	T1	T1	
				SET			N1	N2	LOC	PORT	TS

SAPCN
03664

Link set table is (10 of 1024) 1% full.

6. Change the route configuration in the database using the **chg-rte** command. For this example, enter this command.

chg-rte:dPCA=003-003-003:lsn=ls01:rc=50:nlsn=lsa2

When this command has successfully completed, this message should appear.

rlghncxa03w 05-09-07 08:45:54 GMT EAGLE5 34.0.0
CHG-RTE: MASP A - COMPLTD

7. Verify the changes using the **rtrv-rte** command, specifying the destination point code of the route. For this example, enter this command.

```
rtrv-rte:dPCA=003-003-003
```

This is an example of the possible output.

```
rlghncxa03w 05-09-07 11:43:04 GMT EAGLE5 34.0.0
  DPCA          ALIASI          ALIASN/N24    LSN          RC          APCA
  003-003-003  -----  -----  ls03         10         003-003-003
                                     ls01         20         002-002-100
                                     ls02         30         004-004-004
                                               CLLI=ls03cli
```

8. Back up the new changes using the **chg-db:action=backup:dest=fixed** command. These messages should appear, the active Maintenance and Administration Subsystem Processor (MASP) appears first.

```
BACKUP (FIXED) : MASP A - Backup starts on active MASP.
BACKUP (FIXED) : MASP A - Backup on active MASP to fixed disk complete.
BACKUP (FIXED) : MASP A - Backup starts on standby MASP.
BACKUP (FIXED) : MASP A - Backup on standby MASP to fixed disk complete.
```

Flowchart 3-13. Changing a Route (Sheet 1 of 4)

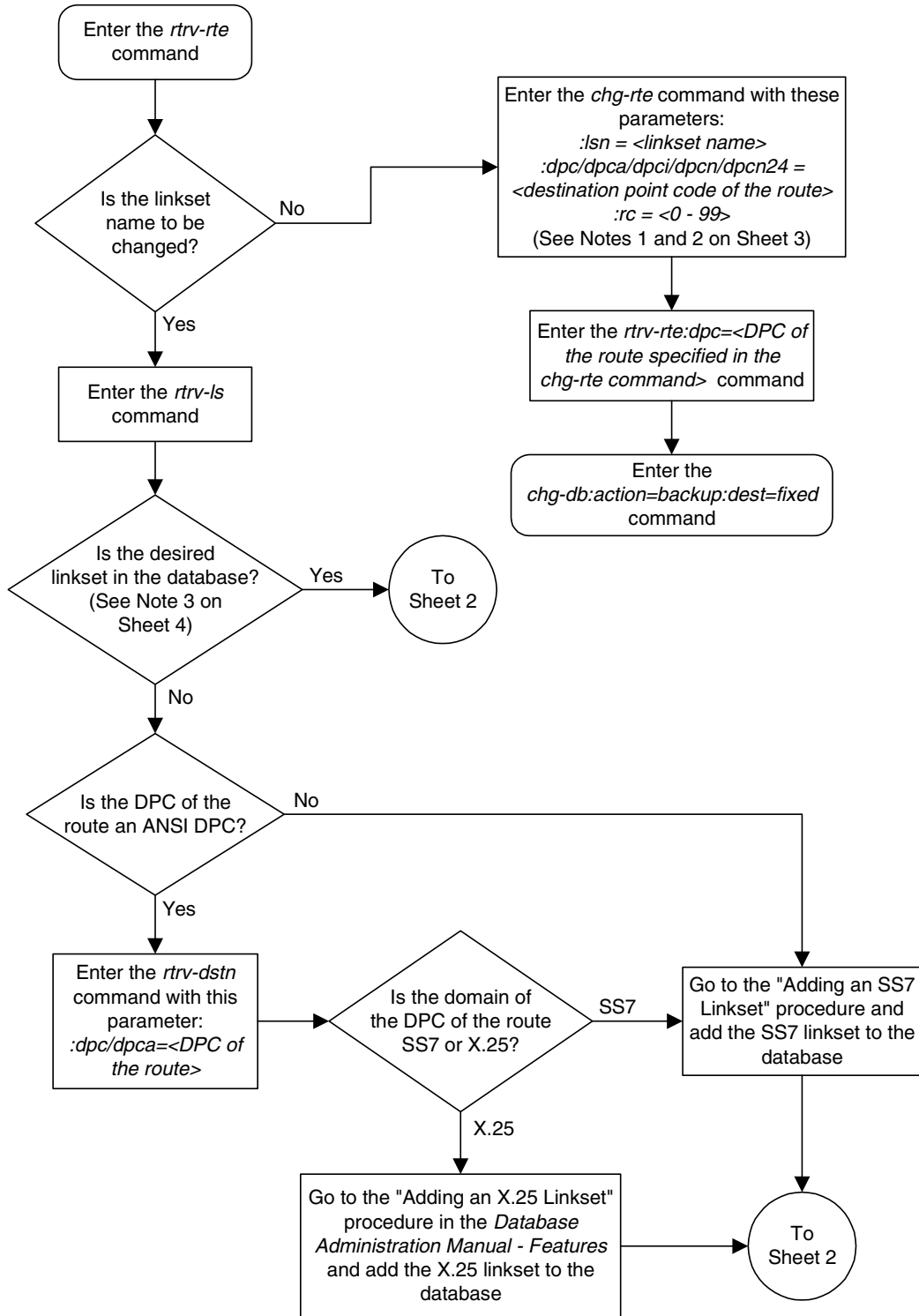

Flowchart 3-13. Changing a Route (Sheet 2 of 4)

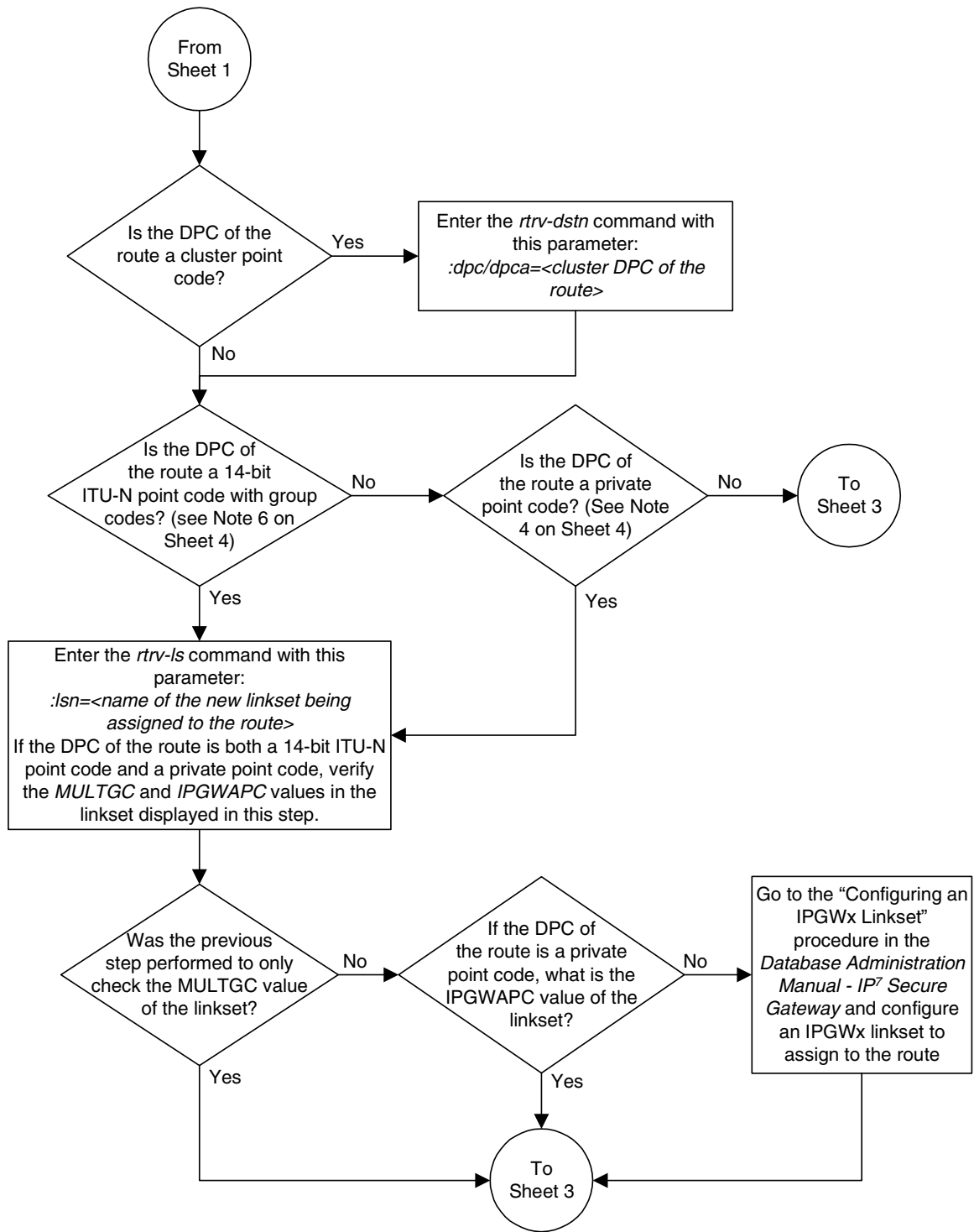

Flowchart 3-13. Changing a Route (Sheet 3 of 4)

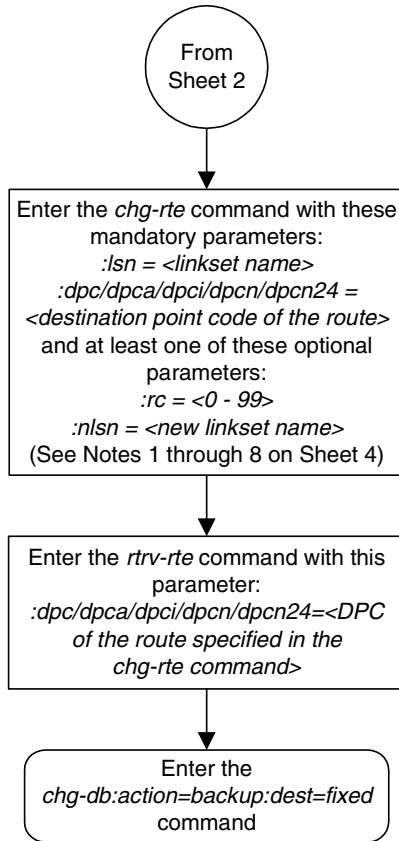

Flowchart 3-13. Changing a Route (Sheet 4 of 4)**Notes:**

1. For an SS7 route, a maximum of two linksets can be assigned the same *rc* parameter value.
2. For an X.25 route, the *rc* parameter values for all linksets cannot be equal.
3. If the DPC of the route is a cluster point code, the link set type of the linkset assigned to the route must be either B, C, or D.
4. If the DPC of the route is a private point code, the *ipgwapc* value of the new linkset must be *yes*.
5. If the DPC of the route is a member of a cluster point code, and the nested cluster allowed indicator (*ncai* parameter of either the *ent-dstn* or *chg-dstn* command) is set to *no*, then the route to the DPC must be the same as the route to the cluster point code. If the nested cluster allowed indicator is set to *yes*, the route to the member of the cluster does not have to be the same as the route to the cluster point code.
6. For routes containing 14-bit ITU National DPCs with group codes, if the linkset assigned to the route has the MULTGC value set to *yes*, then the group code of the linkset's APC can be different from the group code of the route's DPC. If the MULTGC value is set to *no*, then the group code of the linkset's APC must be the same as the group code of the route's DPC.
7. If the DPC of the route is a cluster point code, the linksets that will be assigned to the route, with the *nlsn* parameter, cannot specify the *ipgwapc=yes* parameter.
8. The DPC of the route must be of the same format as the APC of the linkset being added to the route. That is, routes containing ANSI DPCs must have linksets with ANSI APCs; routes containing ITU-I DPCs must have linksets with ITU-I APCs; routes containing 14-bit ITU-N DPCs must have linksets with 14-bit ITU-N APCs; routes containing 24-bit ITU-N DPCs must have linksets with 24-bit ITU-N APCs.

Changing Level 2 Timers

This procedure is used to change the values of a level 2 timer set using the **chg-12t** command.

The **12tset** parameter specifies the level 2 timer set that is being changed. The EAGLE 5 SAS contains 30 level 2 timer sets that signaling links can be assigned to. Level 2 timer sets are assigned to different types of signaling links as shown in Table 3-12.

Table 3-12. Level 2 Timer Sets

Level 2 Timer Set (12tset Parameter Value)	Type of Signaling Link
1 - 10	Low-speed ANSI signaling links
11 - 20	Low-speed ITU signaling links
21 - 25	ITU-N high-speed signaling links for China
26 - 30	ITU-N high-speed signaling links for areas other than China

Each level 2 timer set contains seven timers. Table 3-13 defines the timers and their values.

Table 3-13. Level 2 Timer Values

Level 2 Timers	Level 2 Timer Sets 1 - 10 (in milliseconds)	Level 2 Timer Sets 11 - 20 (in milliseconds)	Level 2 Timer Sets 21 - 25 (in milliseconds)	Level 2 Timer Sets 26 - 30 (in milliseconds)
Timer 1 – Aligned ready (τ_1 parameter)	5000 - 20000 System Default - 13000	40000 - 50000 System Default - 40000	25000 - 350000 System Default - 150000	25000 - 350000 System Default - 150000
Timer 2 – Not aligned (τ_2 parameter)	5000 - 30000 System Default - 11500	5000 - 150000 System Default - 30000	5000 - 150000 System Default - 130000	5000 - 150000 System Default - 130000
Timer 3 – Aligned (τ_3 parameter)	5000 - 20000 System Default - 11500	1000 - 2000 System Default - 2000	1000 - 2000 System Default - 1000	1000 - 2000 System Default - 1000
Timer 4 – Normal proving period (τ_{4npp} parameter)	500 - 5000 System Default - 2300	7500 - 9500 System Default - 8200	3000 - 70000 System Default - 30000	3000 - 70000 System Default - 30000
Timer 4 – Emergency proving period (τ_{4ep} parameter)	200 - 1000 System Default - 600	400 - 600 System Default - 500	400 - 600 System Default - 500	400 - 600 System Default - 500
Timer 5 – Sending SIB (τ_5 parameter)	40 - 500 System Default - 100	80 - 120 System Default - 100	80 - 120 System Default - 100	80 - 120 System Default - 100
Timer 6 – Remote congestion (τ_6 parameter)	1000 - 10000 System Default - 4000	3000 - 6000 System Default - 4000	3000 - 6000 System Default - 5000	3000 - 6000 System Default - 5000
Timer 7 – Excessive delay of acknowledgment (τ_7 parameter)	200 - 3000 System Default - 1500	500 - 2000 System Default - 1500	500 - 2000 System Default - 800	500 - 2000 System Default - 800

The examples in this procedure are used to change the values of the level 2 timer set number 2.

Procedure

1. Display the values of the level 2 timer set you wish to change. Use the `rtrv-12t` command, specifying the level 2 timer set to be changed. For this example, enter this command.

```
rtrv-12t:12tset=2
```

NOTE: Timer sets are individual sets of timer configurations; each link is assigned one of these timer sets. This allows different links to have different level 2 timer settings. This is an example of the possible output.

```
rlghncxa03w 05-09-07 08:39:46 GMT EAGLE5 34.0.0
L2T TIMERS (IN SECONDS)
L2TSET T1    T2    T3    T4NPP  T4EPP  T5    T6    T7
2       10.0  20.0  20.0  5.0    1.00   0.50 10.0  3.0
```

2. Change the values of the level 2 timer in this set using the `chg-12t` command. Refer to Table 3-13 on page 3-219 for the values that can be used with the `chg-12t` command. For this example, the values of the level 2 timer set number 2 that are being changed are T2 and T6. To change these two values, enter this command.

```
chg-12t:12tset=2:t2=15000:t6=5000
```

When this command has successfully completed, this message should appear.

```
rlghncxa03w 05-09-07 08:39:36 GMT EAGLE5 34.0.0
CHG-L2T: MASP A - COMPLTD
```

3. Verify the changes using the `rtrv-12t` command, specifying the level 2 timer set that has been changed. For this example, enter this command.

```
rtrv-12t:12tset=2
```

This is an example of the possible output.

```
rlghncxa03w 05-09-07 08:39:46 GMT EAGLE5 34.0.0
L2T TIMERS (IN SECONDS)
L2TSET T1    T2    T3    T4NPP  T4EPP  T5    T6    T7
2       10.0  15.0  20.0  5.0    1.00   0.50 5.0   3.0
```

4. Back up the new changes using the `chg-db:action=backup:dest=fixed` command. These messages should appear, the active Maintenance and Administration Subsystem Processor (MASP) appears first.

```
BACKUP (FIXED) : MASP A - Backup starts on active MASP.
BACKUP (FIXED) : MASP A - Backup on active MASP to fixed disk complete.
BACKUP (FIXED) : MASP A - Backup starts on standby MASP.
BACKUP (FIXED) : MASP A - Backup on standby MASP to fixed disk complete.
```

Flowchart 3-14. Changing the Level 2 Timers

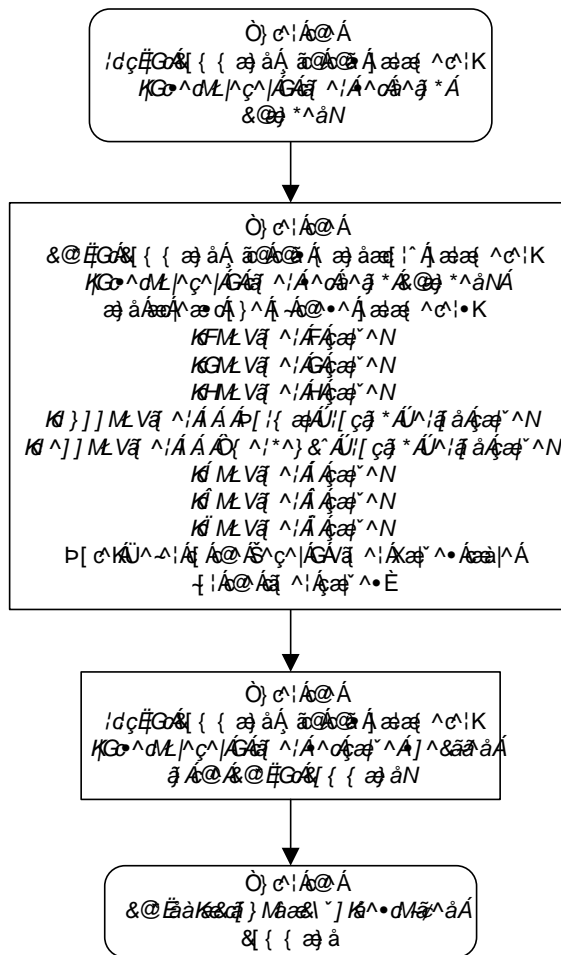

Changing Level 3 Timers

This procedure is used to change the values of the level 3 timers using the `chg-13t` command. The level 3 timers apply to both ANSI and ITU linksets, except as noted for the specific timer.

NOTE: Only one level 3 timer set exists.

The level 3 timers are defined as follows:

- : **t1** – Timer 1 – Delay to avoid message mis-sequencing on changeover. Values - 100-2000 milliseconds; system default value - 800 milliseconds.
- : **t2** – Timer 2 – Waiting for changeover acknowledgment. Values - 100-3000 milliseconds; system default value - 1400 milliseconds.
- : **t3** – Timer 3 – Time controlled diversion – delay to avoid mis-sequencing on changeback. Values - 100 - 2000 milliseconds; system default value - 800 milliseconds.
- : **t4** – Timer 4 – Waiting for changeback acknowledgment (1st attempt). Values - 100-2000 milliseconds; system default value - 800 milliseconds.
- : **t5** – Timer 5 – Waiting for changeback acknowledgment (2nd attempt). Values - 100-2000 milliseconds; system default value - 800 milliseconds.
- : **t6** – Timer 6 – Delay to avoid message mis-sequencing on controlled rerouting. Values - 100-2000 milliseconds; system default values - 800 milliseconds.
- : **t7** – Timer 7 – Waiting for signaling data link connection acknowledgment. Values - 100-3000 milliseconds; system default value - 1000 milliseconds.
- : **t8** – Timer 8 – Transfer-prohibited (TFP) inhibited timer (transient solution). Values - 500-2000 milliseconds; system default value - 800 milliseconds.
- : **t10** – Timer 10 – Waiting to repeat signaling-route-set-test (SRST) message. Values - 20000-90000 milliseconds; system default value - 30000 milliseconds.
- : **t11** – Timer 11 – Transfer-restricted timer. Values - 1000-90000 milliseconds; system default - 30000 milliseconds.
- : **t12** – Timer 12 – Waiting for uninhibit acknowledgment. Values - 100-2000 milliseconds; system default value - 800 milliseconds.
- : **t13** – Timer 13 – Waiting for force uninhibit. Values - 100-2000 milliseconds; system default value - 800 milliseconds.
- : **t14** – Timer 14 – Waiting for inhibition acknowledgment. Values - 200-4000 milliseconds; system default value - 2000 milliseconds.
- : **t15** – Timer 15 – Waiting to repeat signaling route set congestion test (RSCT). Values - 200-4000 milliseconds; system default value - 3000 milliseconds.
- : **t16** – Timer 16 – Waiting for route set congestion (RSC) status update. Values - 200-3000 milliseconds; system default value - 1400 milliseconds.

:t17 – Timer 17 – Delay to avoid oscillation of initial alignment failure and link restart. Values - 500-2000 milliseconds; system default value - 800 milliseconds.

:t18 – Timer 18 – ANSI linksets – Repeat TFR once by response method. Values - 2000-20000 milliseconds; system default value - 10000 milliseconds.

:it18 – Timer 18 – ITU linksets – Timer within a signaling point whose MTP restarts to supervise the receipt of routing information and activation of the link and linkset. Values - 19000-50000 milliseconds; system default value - 50000 milliseconds.

:t19 – Timer 19 – ANSI linksets – Failed link craft referral timer. Values - 30000-600000 milliseconds; system default value - 480000 milliseconds.

:it19 – Timer 19 – ITU linksets – Supervision timer during MTP restart to avoid ping of TFP, TFR1, and TRA messages. Values - 67000-69000 milliseconds; system default value - 67000 milliseconds.

:t20 – Timer 20 – ANSI linksets – Waiting to repeat local inhibit test. The value of the **t20** parameter overwrites the value of the **it22** parameter. Values - 90000-120000 milliseconds; system default value - 90000 milliseconds.

:it20 – Timer 20 – ITU linksets – Overall MTP restart timer at the signaling point whose MTP restarts. Values - 59000-61000 milliseconds; system default value - 59000 milliseconds.

:it20 – Timer 20 – ITU linksets – Waiting to repeat local inhibit test (**it22** parameter). Values - 59000-61000 milliseconds; system default value - 59000 milliseconds.

:t21 – Timer 21 – ANSI linksets – Waiting to repeat remote inhibit test. The value of the **t21** parameter overwrites the value of the **it23** parameter. Values - 90000-120000 milliseconds; system default value - 90000 milliseconds.

:it21 – Timer 21 – ITU linksets – Overall MTP restart timer at a signaling point adjacent to one whose MTP restarts. Values - 63000-65000 milliseconds; system default value - 63000 milliseconds.

:t22 – Timer 22 – ANSI linksets – the amount of time the restarting node waits for the signaling links to become available. This parameter is used when the MTP restart feature is turned on. Values - 10000-60000 milliseconds; system default value - 10000 milliseconds.

:it22 – Timer 22 – ITU linksets – Waiting to repeat local inhibit test. The value of the **it22** parameter overwrites the value of the **t20** parameter. Values - 180000-360000 milliseconds; system default value - 90000 milliseconds.

:t23 – Timer 23 – ANSI linksets – the amount of time the restarting node waits to receive the TRA message. This parameter is used when the MTP restart feature is turned on. Values - 9000-100000 milliseconds; system default value - 10000 milliseconds.

: **it23** – Timer 23 – ITU linksets – Waiting to repeat remote inhibit test. The value of the **it23** parameter overwrites the value of the **t21** parameter. Values - 180000-360000 milliseconds; system default value - 90000 milliseconds.

: **t24** – Timer 24 – ANSI linksets – the amount of time the restarting node waits to broadcast all TRA messages. This parameter is used when the MTP restart feature is turned on. Values - 9000-60000 milliseconds; system default value - 10000 milliseconds.

: **t25** – Timer 25 – ANSI linksets – the amount of time the adjacent node waits for the TRA message. This parameter is used when the MTP restart feature is turned on. Values - 30000-35000 milliseconds; system default value - 30000 milliseconds.

: **t26** – Timer 26 – ANSI linksets – the amount of time the restarting node waits to repeat the TRW message. This parameter is used when the MTP restart feature is turned on. Values - 12000-15000 milliseconds; system default value - 12000 milliseconds.

: **t28** – Timer 28 – ANSI linksets – the amount of time the adjacent node waits for the TRW message. This parameter is used when the MTP restart feature is turned on. Values - 3000-35000 milliseconds; system default value - 3000 milliseconds.

: **t29** – Timer 29 – ANSI linksets – this timer is started when a TRA message is sent in response to an unexpected TRA/TRW message or when the MTP restart process has completed. Any TRA/TRW messages received while the T29 timer is running are ignored. This parameter is used when the MTP restart feature is turned on. Values - 60000-65000 milliseconds; system default value - 60000 milliseconds.

: **t30** – Timer 30 – ANSI linksets – the amount of time between sending TFPs/TFRs in response to an unexpected TRA/TRW message. This parameter is used when the MTP restart feature is turned on. Values - 30000-35000 milliseconds; system default values - 30000 milliseconds.

: **t31** – Timer 31 – ANSI linksets – False link congestion detection timer. Values - 10000-120000 milliseconds; system default value - 60000 milliseconds.

: **t32** –Timer 32 – ANSI linksets – Link oscillation timer - Procedure A. Values - 60000-120000 milliseconds; system default values - 60000 milliseconds.

NOTE: The timer values can be entered as milliseconds or seconds.

It is possible that a problem on a signaling link can cause one signaling link in a linkset to go into congestion, even though the traffic on the linkset is not high enough to cause congestion. For example, if a link has a large number of retransmissions, the throughput of the signaling link could drop enough to cause congestion on that signaling link. To help prevent this from happening, the EAGLE 5 SAS starts the level 3 T31 timer whenever a signaling link goes into congestion. If the signaling link remains in the same congestion state until the level 3 T31 timer expires, the signaling link is removed from service. The signaling link becomes unaligned, then the alignment procedure is started.

SS7 Configuration

The congestion level that starts the level 3 T31 timer can be set to either congestion level 1 or congestion level 2 using the **chg-stpopts** command with the **mtpt31ctl** parameter. This congestion level can be verified with the **rtrv-stpopts** command and is shown in the **MTPT31CTL** field. The level 3 T31 timer is started when the signaling link reaches this congestion level or a higher level. An increase in congestion level or abatement to a lower congestion level restarts the timer. When the congestion level goes below the congestion level configured in the **chg-stpopts** command, the level 3 T31 timer is stopped. If the level 3 T31 timer expires and the signaling link's congestion level has not changed, the signaling link is restarted.

For example, if the level 3 T31 timer is set at 60 seconds and a signaling link goes into congestion level 1, the level 3 T31 timer is started. If, after 45 seconds, the signaling link's congestion increases to level 2, the timer is restarted to 60 seconds. If the signaling link remains at congestion level 2 for 60 seconds, the signaling link is taken out of service and it becomes unaligned. Then the alignment procedure is started, and the EAGLE 5 SAS attempts to realign the signaling link. The level 3 T31 timer can only be assigned to ANSI SS7 linksets and signaling links.

The level 3 T32 timer helps to prevent a signaling link from oscillating in and out of service. When the EAGLE 5 SAS begins restoring an out of service signaling link, the EAGLE 5 SAS starts the level 3 T32 timer. If the signaling link fails to get back into service before the level 3 T32 expires, the EAGLE 5 SAS does not attempt to continue to bring the signaling link into service until the level 3 T32 timer expires. Once the level 3 T32 timer expires, the EAGLE 5 SAS attempts to restore the signaling link into service.

The level 3 T32 timer is only started after a signaling link fails, not when a signaling link is manually deactivated. When a signaling link is manually taken out of service using the **dact-slk** command, the level 3 T32 timer is stopped, if it is running. When the signaling link is brought back into service using the **act-slk** command, the level 3 T32 timer is not started. The level 3 T32 timer is not started when a new signaling link is first aligned. The level 3 T32 timer can only be assigned to ANSI SS7 linksets and signaling links.

The **13tset** parameter specifies the level 3 timer set. For any level 3 timer parameters not specified with the **chg-13t** command, the values for those parameters are not changed.

Procedure

1. Display the values for the level 3 timer set using the **rtrv-13t** command. This is an example of the possible output.

```
rlghncxa03w 05-09-17 16:03:12 GMT EAGLE5 34.0.0
LEVEL 3 TIMERS (IN SECONDS)

L3TSET   T1      T2      T3      T4      T5      T6      T7
   1     2.0    3.0    2.0    2.0    2.0    2.0    3.0

          T8      T9      T10     T11     T12     T13     T14
          2.0    --     90.0   90.0   2.0    2.0    4.0

          T15     T16     T17     T18     IT18    T19     IT19
          4.0    3.0    2.0    20.0   19.0   600.0   67.0

T20/IT22 IT20    T21/IT23 IT21    T22     T23     T24
120.0    59.0    120.0   63.0   10.0   10.0   10.0

          T25     T26     T27     T28     T29     T30     T31
          30.0   12.0    --     3.0    60.0   30.0   60.0

          T32
          60.0
```

2. Change the values of the level 3 timer set using the **chg-13t** command. For this example, the level 3 timer values that are being changed are T10, T11, T19, T20, and T21. To change these timer values, enter this command.

```
chg-13t:13tset=1:t10=40.0:t11=50.0:t19=480.0:t20=100.0
:t21=100.0
```

When this command has successfully completed, this message should appear.

```
rlghncxa03w 05-09-07 08:41:51 GMT EAGLE5 34.0.0
CHG-L3T: MASP A - COMPLTD
```

3. Verify the changes using the **rtrv-13t** command. This is an example of the possible output.

```
rlghncxa03w 05-09-17 16:03:12 GMT EAGLE5 34.0.0
LEVEL 3 TIMERS (IN SECONDS)

L3TSET   T1      T2      T3      T4      T5      T6      T7
   1     2.0    3.0    2.0    2.0    2.0    2.0    3.0

          T8      T9      T10     T11     T12     T13     T14
          2.0    --     40.0   50.0   2.0    2.0    4.0

          T15     T16     T17     T18     IT18    T19     IT19
          4.0    3.0    2.0    20.0   19.0   480.0   67.0

T20/IT22 IT20    T21/IT23 IT21    T22     T23     T24
100.0    59.0    100.0   63.0   10.0   10.0   10.0

          T25     T26     T27     T28     T29     T30     T31
          30.0   12.0    --     3.0    60.0   30.0   60.0

          T32
          60.0
```

4. Back up the new changes using the `chg-db:action=backup:dest=fixed` command. These messages should appear, the active Maintenance and Administration Subsystem Processor (MASP) appears first.

```

BACKUP (FIXED) : MASP A - Backup starts on active MASP.
BACKUP (FIXED) : MASP A - Backup on active MASP to fixed disk complete.
BACKUP (FIXED) : MASP A - Backup starts on standby MASP.
BACKUP (FIXED) : MASP A - Backup on standby MASP to fixed disk complete.
    
```

Flowchart 3-15. Changing the Level 3 Timers

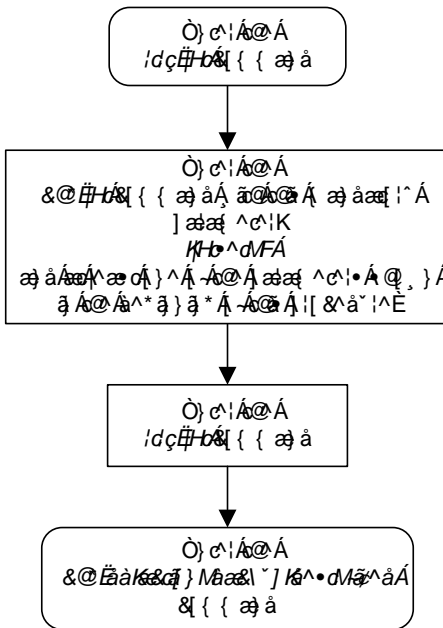

Changing a Signaling Link Test Message

This procedure is used to change an SLTM (signaling link test message) using the `chg-slt` command.

The `chg-slt` command uses these parameters.

- `:sltset` – The signaling link test message record number in the SLTM table.
- `:t1` – The T1 timer for repeating the SLTM after a failure
- `:t2` – The T2 timer for the SLTM period
- `:enabled` – Enables the signaling link test message.
- `:mode` – The SLTM mode to be used when sending test messages.
- `:pattern` – The test pattern to be sent with a signaling link test message.

Procedure

1. Display the SLTM record to be changed using the `rtrv-slt` command. This is an example of the possible output.

```
rlghncxa03w 05-09-07 00:21:24 GMT EAGLE5 34.0.0
SLTM PARAMETERS
SLTSET  T1   T2   MODE   ENABLED  PATTERN
1       9.0  60.0  SPECIAL ON      AA2233445566778899AABBCCDDEEFF
2       12.0 30.0  SPECIAL OFF     F01234BCDE
3       4.0  50.0  REGULAR ON      CC2233445566778899AABBCCDDEEFF
4       6.0  90.0  SPECIAL OFF     BB23446789BCABEFG
5       6.0  90.0  SPECIAL OFF     BB23446789BCABEFG
6       6.0  90.0  SPECIAL OFF     BB23446789BCABEFG
7       6.0  90.0  SPECIAL OFF     BB23446789BCABEFG
8       6.0  90.0  SPECIAL OFF     BB23446789BCABEFG
9       6.0  90.0  REGULAR OFF     BB23446789BCABEFG
10      6.0  90.0  REGULAR OFF     BB23446789BCABEFG
11      6.0  90.0  REGULAR OFF     BB23446789BCABEFG
12      4.0  50.0  SPECIAL ON      FFEEDDCCBAA998877665544332211
13      4.0  50.0  SPECIAL ON      EE22334455
14      6.0  90.0  SPECIAL ON      AABBCCDD
15      6.0  90.0  REGULAR ON      AABBCCDD
16      6.0  90.0  REGULAR ON      AABBCCDD
17      6.0  90.0  REGULAR ON      AABBCCDD
18      6.0  90.0  SPECIAL ON      AABBCCDD
19      6.0  90.0  SPECIAL ON      AABBCCDD
20      6.0  90.0  SPECIAL ON      AABBCCDD
```

SS7 Configuration

2. Change the SLTM record using the **chg-slt** command. For this example, signaling link test message 2 is being changed to these values:

T1 = 10.0

T2 = 50.0

MODE = REGULAR

ENABLED = ON

PATTERN = AB987654321

To make these changes, enter this command.

```
chg-slt:sltset=2:t1=10.0:t2=50.0:mode=regular:enabled=on  
:pattern=ab987654321
```

When this command has successfully completed, this message should appear.

```
rlghncxa03w 05-09-07 00:22:57 GMT EAGLE5 34.0.0  
CHG-SLT: MASP A - COMPLTD
```

3. Verify the changes using the **rtrv-slt** command, specifying the SLTM record. This is an example of the possible output.

```
rlghncxa03w 05-09-07 00:23:35 GMT EAGLE5 34.0.0  
SLTM PARAMETERS  
SLTSET T1 T2 MODE ENABLED PATTERN  
2 10.0 50.0 REGULAR ON AB987654321
```

4. Back up the new changes using the **chg-db:action=backup:dest=fixed** command. These messages should appear, the active Maintenance and Administration Subsystem Processor (MASP) appears first.

```
BACKUP (FIXED) : MASP A - Backup starts on active MASP.  
BACKUP (FIXED) : MASP A - Backup on active MASP to fixed disk complete.  
BACKUP (FIXED) : MASP A - Backup starts on standby MASP.  
BACKUP (FIXED) : MASP A - Backup on standby MASP to fixed disk complete.
```

Configuring Circular Route Detection

NOTE: Circular route detection is not supported in ITU networks.

This procedure is used to configure the EAGLE 5 SAS to detect circular routing with the **chg-stpopts** command. The **chg-stpopts** command uses these parameters to detect circular routing in the EAGLE 5 SAS.

:mtp1ti – is the circular routing detection test feature is on or off?

:mtp1tctdpcq – the number of DPCs that the circular route test message is sent to.

:mtp1tst – the duration of the circular route test detection procedures, in milliseconds (the MTPLTST timer).

These parameters are optional. For any parameters not specified with the **chg-stpopts** command, the values for these parameters are not changed.

When the **chg-stpopts** command is first introduced to the EAGLE 5 SAS, the default values for these parameters are: **mtp1ti=yes**, **mtp1tctdpcq=3**, and **mtp1tst=10000**.

For this example, the circular route detection procedures remain enabled, the number of most frequently occurring DPCs is changed from 3 to 6, and the duration of the circular route detection procedures is changed from 10000 milliseconds to 18000 milliseconds.

The EAGLE 5 SAS automatically tests for circular routing when congestion occurs on an ANSI signaling link. The circular route detection test cannot be performed for ITU or X25 signaling links. If the routing data is configured incorrectly, or is corrupted, MSUs could be routed in an endless circular route. The incorrect routing data could be on the EAGLE 5 SAS or at a remote node. With the addition of cluster routing and E links, the danger of circular routing is greater.

The EAGLE 5 SAS starts the test when a signaling link reaches onset congestion threshold 1. The EAGLE 5 SAS only runs the test for one signaling link per linkset. If a second signaling link in the same linkset goes into congestion, the EAGLE 5 SAS does not start a new test. Each time the signaling link's congestion level increases, the test is restarted. The LIM that contains the congested signaling link determines which DPCs have the most MSUs transmitted on the signaling link. The LIM then transmits a circular routing test message to the DPCs that have sent the most MSUs. The number of DPCs that the circular route test message is sent to is from 3 to 10. A circular routing test message is a routeset congestion test message with priority of 3.

If any LIM receives one of the test messages before the MTPLTST timer expires, the EAGLE 5 SAS performs these actions.

- Marks the destination as prohibited due to circular routing.
- Broadcasts TFPs for the destination.
- Reports that circular routing was detected for the destination.
- Raises a critical alarm.

The destination remains prohibited until it is manually allowed using the **rst-dstn** (reset destination) command.

If the destination is a cluster point code entry in the routing table, then an exception list (x-list) entry is created for the destination. If the cluster has the exception list exclusion indicator set to yes (meaning do not create x-lists for that cluster), then an x-list is not created, an UAM is generated, and a critical alarm is raised for the cluster. The critical alarm can be cleared by entering the **rst-dstn** command for the cluster.

If an x-list entry needs to be created, but the provisioned number of x-lists are already used, extra buffer space, equal to 100 entries in the routing table, is used to create the x-list. If this extra buffer space is also full, no x-list is created, a UAM is generated, and a critical alarm is raised for the cluster.

When a point code is prohibited due to circular routing, the EAGLE 5 SAS ignores TFX/TCx management messages for that point code. The EAGLE 5 SAS does not send routeset test messages for the point code. The EAGLE 5 SAS discards any MSUs received for the point code and sends response method TFPs or TCPs.

When EAGLE 5 SAS detects circular routing for a destination, it sets the circular routing flag for the destination in the routing table. The **rst-dstn** command clears this flag. Once the circular routing flag is cleared, the status of the destination depends on what type of entry is used.

- If the destination is a member of a cluster for which EAGLE 5 SAS performs full point code routing only, all routes to the destination are marked as allowed and the destination's status is allowed. The EAGLE 5 SAS broadcasts TFAs for the destination.
- If the destination has a full point code entry in the routing table, and there is also an entry for the point code's cluster, then each route used by the point code that is also used by the cluster entry assumes the status of the route for the cluster entry. Each route used by the point code that is not used by the cluster assumes the status of the cluster's route set. The EAGLE 5 SAS then determines the point codes route set status and broadcasts TFA/TFR if the point code becomes allowed or restricted.

If the **rst-dstn** command is entered for an x-list entry with the circular routing flag set, the x-list entry is deleted. The point code's status becomes the same as the cluster entry's status.

Procedure

1. Display the existing values for the circular route test parameters by entering the `rtrv-stpopts` command. The value for the circular route test parameters is shown in the `MTPLTI`, `MTPLTCTDPCQ`, `MTPLTST` fields. This is an example of the possible output.

```
rlghncxa03w 05-09-17 16:02:05 GMT EAGLE5 34.0.0
STP OPTIONS
-----
MTPLTI                yes
MTPLTCTDPCQ          3
MTPLTST              10000
```

NOTE: The `rtrv-stpopts` command output contains other fields that are not used by this procedure. If you wish to see all the fields displayed by the `rtrv-stpopts` command, see the `rtrv-stpopts` command description in the *Commands Manual*.

2. Change the circular routing detection parameters. For this example, enter this command.

```
chg-stpopts:mtplctdpcq=6:mtpltst=18000
```

When this command has successfully completed, this message should appear.

```
rlghncxa03w 05-09-07 00:22:57 GMT EAGLE5 34.0.0
CHG-STPOPTS: MASP A - COMPLTD
```

3. Verify the changes using the `rtrv-stpopts` command. This is an example of the possible output.

```
rlghncxa03w 05-09-17 16:02:05 GMT EAGLE5 34.0.0
STP OPTIONS
-----
MTPLTI                yes
MTPLTCTDPCQ          6
MTPLTST              18000
```

NOTE: The `rtrv-stpopts` command output contains other fields that are not used by this procedure. If you wish to see all the fields displayed by the `rtrv-stpopts` command, see the `rtrv-stpopts` command description in the *Commands Manual*.

- Back up the new changes using the `chg-db:action=backup:dest=fixed` command. These messages should appear, the active Maintenance and Administration Subsystem Processor (MASP) appears first.

```

BACKUP (FIXED) : MASP A - Backup starts on active MASP.
BACKUP (FIXED) : MASP A - Backup on active MASP to fixed disk complete.
BACKUP (FIXED) : MASP A - Backup starts on standby MASP.
BACKUP (FIXED) : MASP A - Backup on standby MASP to fixed disk complete.
    
```

Flowchart 3-17. Configuring the System to Detect Circular Routing

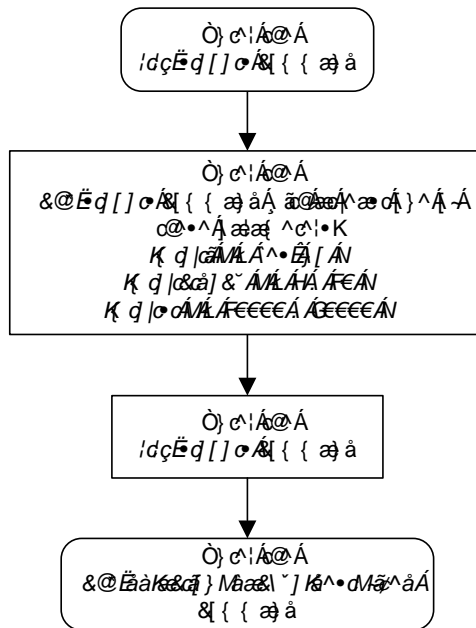

Configuring the TFA/TFR Pacing Rate

NOTE: The pacing rate feature is not supported in ITU networks.

This procedure is used to configure the rate that the EAGLE 5 SAS sends the TFR and TFA messages, or the pacing rate. The pacing rate is configured with the **tfatfrpr** parameter of the **chg-stpopts** command. The value of the **tfatfrpr** parameter is from 0 to 1 second and can be set in 0.1 second intervals. When the **chg-stpopts** command is first introduced to the EAGLE 5 SAS, the default value for the **tfatfrpr** parameter is 1 second. A value of 0 for the **tfatfrpr** parameter indicates that the pacing should stop. The pacing of TFR/TCR is stopped and all remaining TFR/TCR are broadcast at once if the current alternate route used to route traffic to the affected point code is in danger of congestion. The value of the **tfatfrpr** parameter in the **chg-stpopts** command is entered and displayed in the **rtrv-stpopts** command output in milliseconds.

These parameters of the **chg-stpopts** command are optional. For any parameters not specified with the **chg-stpopts** command, the values for these parameters are not changed.

For this example, the TFA/TFR pacing rate is changed from 1 second to 0.5 seconds (1000 milliseconds to 500 milliseconds).

When the status of the route is changed to allowed (when the route was restricted) or restricted (when the route was prohibited), a burst of rerouted traffic can occur on that route, thus congesting the route. To help keep this from happening, the EAGLE 5 SAS can control the rate that it broadcasts TFR and TFA messages to adjacent signaling points. This can regulate the amount of traffic the adjacent signaling points can send to the EAGLE 5 SAS when the route becomes allowed or restricted.

The TFA/TCA and TFR/TCR messages for each affected point code are sent in groups of 20%. For each time period defined by the pacing rate, a group of 20% of the messages that are to be sent to the adjacent signaling points are broadcast to those signaling points.

This feature applies only to ANSI signaling links. The pacing is not done towards ITU networks.

If the destination becomes inaccessible or accessible before all of the TFR/TCR messages are broadcasted, then the remaining TFR/TCR messages are not sent.

TFA/TFC messages for multiple affected destinations are sent in parallel.

The broadcast of TFA/TFR messages sent about X.25 pseudo point codes is controlled by this feature.

Procedure

1. Display the existing values for the TFA/TFR pacing rate parameter by entering the `rtrv-stpopts` command. The value for the TFA/TFR pacing rate parameter is shown in the `TFATFRPR` field, and is shown in milliseconds. This is an example of the possible output.

```
rlghncxa03w 05-09-17 16:02:05 GMT EAGLE5 34.0.0
STP OPTIONS
-----
TFATFRPR          1000
```

NOTE: The `rtrv-stpopts` command output contains other fields that are not used by this procedure. If you wish to see all the fields displayed by the `rtrv-stpopts` command, see the `rtrv-stpopts` command description in the *Commands Manual*.

2. Change the TFA/TFR pacing rate parameter. For this example, enter this command.

```
chg-stpopts:tfatfrpr=500
```

When this command has successfully completed, this message should appear.

```
rlghncxa03w 05-09-07 00:22:57 GMT EAGLE5 34.0.0
CHG-STPOPTS: MASP A - COMPLTD
```

3. Verify the changes using the `rtrv-stpopts` command. This is an example of the possible output.

```
rlghncxa03w 05-09-17 16:02:05 GMT EAGLE5 34.0.0
STP OPTIONS
-----
TFATFRPR          500
```

NOTE: The `rtrv-stpopts` command output contains other fields that are not used by this procedure. If you wish to see all the fields displayed by the `rtrv-stpopts` command, see the `rtrv-stpopts` command description in the *Commands Manual*.

4. Back up the new changes using the `chg-db:action=backup:dest=fixed` command. These messages should appear, the active Maintenance and Administration Subsystem Processor (MASP) appears first.

```
BACKUP (FIXED) : MASP A - Backup starts on active MASP.
BACKUP (FIXED) : MASP A - Backup on active MASP to fixed disk complete.
BACKUP (FIXED) : MASP A - Backup starts on standby MASP.
BACKUP (FIXED) : MASP A - Backup on standby MASP to fixed disk complete.
```

Configuring the Frequency of RST Messages on Low Priority Routes

This procedure is used to configure the frequency that signaling-route-set-test messages are sent for routes of lower priority than the current route. The frequency is configured with the `mtplprst` and `mtpt10alt` parameters of the `chg-stpopts` command.

:mtplprst – turns on or off the routeset test message for lower priority routes capability. The values for this parameter is **yes** or **no**. The default value for this parameter is **yes**.

:mtpt10alt – the timer to control the frequency that the routeset test messages are sent. The values for this parameter are from 20000 to 10,000,000 milliseconds (20 - 10,000 seconds). The default value for this parameter is equal to the value of the level 3 T10 timer. The value of the level 3 T10 timer is shown in the `T10` field of the `rtrv-13t` command output.

The value of the `mtpt10alt` parameter must be equal to or greater than the value of the level 3 T10 timer.

When the `mtplprst=no` parameter is specified with the `chg-stpopts` command, the EAGLE 5 SAS does not send routeset test messages for the lower priority routes. When the `mtplprst=yes` parameter is specified, the EAGLE 5 SAS sends routeset test messages at intervals specified by the value of the `mtpt10alt` parameter.

These parameters of the `chg-stpopts` command are optional. For any parameters not specified with the `chg-stpopts` command, the values for these parameters are not changed.

For this example, the sending the signaling-route-set-test messages for the low priority routes is turned on, and the frequency of sending these messages is changed from 20 seconds to 120 seconds (20,000 milliseconds to 120,000 milliseconds).

Procedure

1. Display the existing values for the `mtplprst` and `mtpt10alt` parameters by entering the `rtrv-stpopts` command. The value for the `mtplprst` and `mtpt10alt` parameters is shown in the `MTPLPRST` and `MTPT10ALT` fields, and the value of the `mtpt10alt` parameter is shown in milliseconds.

This is an example of the possible output.

```
rlghncxa03w 05-09-17 16:02:05 GMT EAGLE5 34.0.0
STP OPTIONS
-----
MTPLPRST          no
MTPT10ALT         30000
```

NOTE: The `rtrv-stpopts` command output contains other fields that are not used by this procedure. If you wish to see all the fields displayed by the `rtrv-stpopts` command, see the `rtrv-stpopts` command description in the *Commands Manual*.

2. Display the values for the level 3 timer set using the `rtrv-13t` command. The values of the level 3 timers are shown in seconds. This is an example of the possible output.

```
rlghncxa03w 05-09-17 16:03:12 GMT EAGLE5 34.0.0
LEVEL 3 TIMERS (IN SECONDS)

L3TSET   T1      T2      T3      T4      T5      T6      T7
      1   2.0    3.0    2.0    2.0    2.0    2.0    3.0

          T8      T9      T10     T11     T12     T13     T14
          2.0    --    90.0   90.0    2.0    2.0    4.0

          T15     T16     T17     T18     IT18    T19     IT19
          4.0    3.0    2.0    20.0    19.0   600.0   67.0

      T20/IT22  IT20    T21/IT23  IT21     T22     T23     T24
      120.0    59.0   120.0    63.0    10.0    10.0    10.0

          T25     T26     T27     T28     T29     T30     T31
          30.0   12.0    --     3.0    60.0    30.0    60.0

          T32
          60.0
```

3. Change the `mtplprst` and `mtpt10alt` parameters. For this example, enter this command.

```
chg-stpopts:mtplprst=yes:mtpt10alt=120000
```

When this command has successfully completed, this message should appear.

```
rlghncxa03w 05-09-07 00:22:57 GMT EAGLE5 34.0.0
CHG-STPOPTS: MASP A - COMPLTD
```

4. Verify the changes using the `rtrv-stpopts` command. This is an example of the possible output.

```
rlghncxa03w 05-09-17 16:02:05 GMT EAGLE5 34.0.0
STP OPTIONS
-----
MTPLPRST           yes
MTPT10ALT         120000
```

NOTE: The `rtrv-stpopts` command output contains other fields that are not used by this procedure. If you wish to see all the fields displayed by the `rtrv-stpopts` command, see the `rtrv-stpopts` command description in the *Commands Manual*.

5. Back up the new changes using the `chg-db:action=backup:dest=fixed` command. These messages should appear, the active Maintenance and Administration Subsystem Processor (MASP) appears first.

```
BACKUP (FIXED) : MASP A - Backup starts on active MASP.
BACKUP (FIXED) : MASP A - Backup on active MASP to fixed disk complete.
BACKUP (FIXED) : MASP A - Backup starts on standby MASP.
BACKUP (FIXED) : MASP A - Backup on standby MASP to fixed disk complete.
```

Adding Remote Loopback Points

This procedure is used to add remote loopback points to be used by the link fault sectionalization feature to the database, using the **ent-1bp** command. The **ent-1bp** command uses these parameters.

:loc – The card location of the signaling link to be tested.

:link – The signaling link on the card specified in the **loc** parameter to be tested.

:1bp – Identifies the far-end loopback point that lies along a SS7 signaling link path between the EAGLE 5 SAS up to and including the target device.

:clli – The CLLI code or other mnemonic identifier used to describe the specified loopback point.

:rle – The remote link element to be looped back for testing.

:rep – The number of link elements of the same type, not including the target device, that lies between the EAGLE 5 SAS and the link element to be tested.

:fst – The type of link fault sectionalization loopback test to be performed.

To add remote loopback points to the database, the link fault sectionalization feature must be turned on.

The DS0 and network element interface (NEI) link elements do not support non-latching loopbacks

If the remote link element to be tested is a network element interface (NEI), the value of the **rep** parameter must be zero.

The **rep** parameter can only be specified for a link fault sectionalization latching loopback test

The signaling link being tested can be assigned to one of these card types as defined by the **type** parameter of the **ent-card** command:

- **limds0** (multi-port LIM - P/N 870-2061-XX or LIM-AINF card - P/N 870-1488-XX)
- **limt1** (E1/T1 MIM - P/N 870-2198-XX or HC MIM - P/N 870-2671-01)
- **limch** (E1/T1 MIM - configured as a T1 channel card - P/N 870-2198-XX)

Any signaling link can be selected for testing, as long as the signaling link being tested is equipped. The LIMs must be assigned to either the **ss7ansi** or **ccs7itu** application. Use the **rtrv-card** command to verify the card type and the application.

The specified loopback point cannot already be in the database.

The loopback point ID value cannot exceed a previously defined network element interface loopback point value.

Only one network element interface loopback point can be defined for each SS7 signaling link.

A network element interface (NEI) loopback point must be defined as the terminating SS7 signaling link component.

The value specified for the **rep** parameter must be greater than the value of the **rep** parameter assigned to the previous loopback point and less than any **rep** parameter values for any subsequent loopback points, if any are defined. For example, the signaling link on card 1215, link B, has 5 loopback points defined (see the **rtrv-lbp** command output in step 2). The value of the **rep** parameter used for loopback point 5 must be greater than the **rep** parameter value used for loopback point 3, and less than the **rep** parameter value used for loopback point 7.

The link fault sectionalization feature must be turned on. Verify this by entering the **rtrv-feat** command. If the link fault sectionalization feature is off, shown by the entry **LFS = off** in the output of the **rtrv-feat** command, it can be turned on by entering the **chg-feat:lfs=on** command.

NOTE: Once the link fault sectionalization feature is turned on with the chg-feat command, it cannot be turned off.

The link fault sectionalization feature must be purchased before you turn the feature on with the chg-feat command. If you are not sure if you have purchased the link fault sectionalization feature, contact your Tekelec Sales Representative or Account Representative.

Refer to Appendix A of the *Commands Manual* for a summary of loopback testing commands and functions.

The examples used in this procedure are based on the example network shown in Figure 3-3 and Table 3-14.

Table 3-14. Loopback Point Configuration Table

SLK		LBP	RLE	REP	LFST
LOC	LINK				
1204	B	3	DS0	0	LLT
		6	DS0	4	LLT
		9	NEI	0	LLT

Canceling the RTRV-SLK Command

Because the `rtrv-slk` command used in this procedure can output information for a long period of time, the `rtrv-slk` command can be canceled and the output to the terminal stopped. There are three ways that the `rtrv-slk` command can be canceled.

- Press the **F9** function key on the keyboard at the terminal where the `rtrv-slk` command was entered.
- Enter the `canc-cmd` without the `trm` parameter at the terminal where the `rtrv-slk` command was entered.
- Enter the `canc-cmd:trm=<xx>`, where `<xx>` is the terminal where the `rtrv-slk` command was entered, from another terminal other than the terminal where the `rtrv-slk` command was entered. To enter the `canc-cmd:trm=<xx>` command, the terminal must allow Security Administration commands to be entered from it and the user must be allowed to enter Security Administration commands. The terminal's permissions can be verified with the `rtrv-secu-trm` command. The user's permissions can be verified with the `rtrv-user` or `rtrv-secu-user` commands.

For more information about the `canc-cmd` command, go to the *Commands Manual*.

Procedure

1. Display the signaling links in the database by entering the `rtrv-slk` command. This is an example of the possible output.

```
rlghncxa03w 05-09-19 21:16:37 GMT EAGLE5 34.0.0
          L2T          L1          PCR PCR
LOC LINK LSN          SLC TYPE    SET BPS    MODE TSET  ECM  N1  N2
1201 A  ls01          0 LIMDS0    1 56000 --- ---  BASIC ---  ---
1201 B  lsa1          0 LIMDS0    1 56000 --- ---  BASIC ---  ---
1202 B  ls02          0 LIMV35    2 64000 DTE ---  BASIC ---  ---
1203 A  ls03          0 LIMDS0    3 56000 --- ---  BASIC ---  ---
1203 B  lsa2          0 LIMDS0    1 56000 --- ---  BASIC ---  ---
1204 B  ls01          1 LIMDS0    1 56000 --- ---  BASIC ---  ---
1205 A  lsa3          0 LIMV35    4 64000 DCE ON   BASIC ---  ---
1206 A  ls02          1 LIMV35    2 64000 DTE ---  BASIC ---  ---
1207 A  lsn1207a       0 LIMDS0    1 56000 --- ---  BASIC ---  ---
1207 B  lsn1207b       0 LIMDS0    1 56000 --- ---  BASIC ---  ---
1208 B  ls03          1 LIMDS0    3 56000 --- ---  BASIC ---  ---
1212 A  ls04          0 LIMV35    4 64000 DTE ---  BASIC ---  ---
1213 B  ls05          0 LIMDS0    5 56000 --- ---  BASIC ---  ---
1214 A  lsn1214a       0 LIMV35    2 64000 DTE ---  PCR  76 3800
1214 B  lsa3          1 LIMV35    4 64000 DCE ON   BASIC ---  ---
1215 A  ls05          1 LIMDS0    5 56000 --- ---  BASIC ---  ---
1301 B  ls06          0 LIMV35    6 56000 DTE ---  BASIC ---  ---
1304 B  ls06          1 LIMV35    6 56000 DTE ---  BASIC ---  ---
1308 A  ls06          2 LIMV35    6 56000 DTE ---  BASIC ---  ---
1311 A  ls01          2 LIMDS0    1 56000 --- ---  BASIC ---  ---
1311 A1 ls05          2 LIMDS0    5 56000 --- ---  BASIC ---  ---
1311 B  ls03          2 LIMDS0    3 56000 --- ---  BASIC ---  ---
1311 B1 ls07          1 LIMDS0    7 56000 --- ---  BASIC ---  ---
1313 A  ls07          0 LIMDS0    7 56000 --- ---  BASIC ---  ---
```

```
1315 A   lsn5           0 LIMV35 11 64000 DTE OFF BASIC --- -----
1317 A   lsi7           0 LIMV35 11 64000 DTE OFF BASIC --- -----
```

```

                LP           ATM
LOC LINK LSN      SLC TYPE   SET BPS   TSEL   VCI   VPI   LL
1302 A   atmansi0  0 LIMATM  3 1544000 EXTERNAL 35   15   0
1305 A   atmansi1  0 LIMATM  4 1544000 INTERNAL 100  20   2
1318 A   atmansi0  1 LIMATM  9 1544000 LINE     150  25   4

```

```

                LP           ATM           E1ATM
LOC LINK LSN      SLC TYPE   SET BPS   TSEL   VCI   VPI   CRC4 SI SN
2101 A   atmitul1  0 LIME1ATM 5 2.048M LINE  150  2   ON   1 20
2105 A   atmitul1  1 LIME1ATM 5 2.048M LINE  35   15   ON   2 15

```

```
LOC LINK LSN      SLC TYPE   IPLIML2
```

No Links Set up.

```
LOC LINK LSN      SLC TYPE
```

No Links Set up.

```

                L2T           PCR PCR   E1   E1
LOC LINK LSN      SLC TYPE   SET BPS   ECM  N1  N2  LOC PORT TS

```

No Links Set up.

```

                L2T           PCR PCR   T1   T1
LOC LINK LSN      SLC TYPE   SET BPS   ECM  N1  N2  LOC PORT TS

```

No Links Set up.

SLK table is (31 of 1200) 3% full

2. Display the existing loopback point values by entering the `rtv-lbp` command. This is an example of the possible output.

```
rlghncxa03w 05-09-17 16:02:05 GMT EAGLE5 34.0.0
LOC LINK LBP RLE REP CLLI      LFST
1201 A   1   DS0  0 ----- LLT
        7   OCU  0 ----- NLT
        9   NEI  0 ----- LLT

1203 B   2   DS0  0 ----- LLT
        3   DS0  4 ----- LLT
        4   NEI  0 ----- LLT

1207 B   1   DS0  0 ----- LLT
        6   NEI  0 ----- LLT

1215 A   1   DS0  0 ----- LLT
        3   DS0  4 ----- LLT
        5   DS0  5 ----- LLT
        7   DS0  8 ----- LLT
        9   NEI  0 ----- LLT
```

3. Add the loopback point to the database, using the `ent-lbp` command. For this example, enter these commands.

```
ent-lbp:loc=1204:link=b:lbp=3:rle=ds0:rep=0:lfst=llt
```

```
ent-lbp:loc=1204:link=b:lbp=6:rle=ds0:rep=4:lfst=llt
```

```
ent-lbp:loc=1204:link=b:lbp=9:rle=nei:rep=0:lfst=llt
```

When each of these commands have completed, this message should appear.

```
rlghncxa03w 05-09-07 00:22:57 GMT EAGLE5 34.0.0
ENT-LBP: MASP A - COMPLTD
```

4. Verify the changes using the `rtrv-lbp` command. This is an example of the possible output.

```
rlghncxa03w 05-09-17 16:02:05 GMT EAGLE5 34.0.0
LOC  LINK  LBP  RLE  REP  CLLI  LFST
1201  A      1   DS0  0  -----  LLT
      7   OCU  0  -----  NLT
      9   NEI  0  -----  LLT

1203  B      2   DS0  0  -----  LLT
      3   DS0  4  -----  LLT
      4   NEI  0  -----  LLT

1204  B      3   DS0  0  -----  LLT
      6   DS0  4  -----  LLT
      9   NEI  0  -----  LLT

1207  B      1   DS0  0  -----  LLT
      6   NEI  0  -----  LLT

1215  A      1   DS0  0  -----  LLT
      3   DS0  4  -----  LLT
      5   DS0  5  -----  LLT
      7   DS0  8  -----  LLT
      9   NEI  0  -----  LLT
```

5. Back up the new changes using the `chg-db:action=backup:dest=fixed` command. These messages should appear, the active Maintenance and Administration Subsystem Processor (MASP) appears first.

```
BACKUP (FIXED) : MASP A - Backup starts on active MASP.
BACKUP (FIXED) : MASP A - Backup on active MASP to fixed disk complete.
BACKUP (FIXED) : MASP A - Backup starts on standby MASP.
BACKUP (FIXED) : MASP A - Backup on standby MASP to fixed disk complete.
```

Flowchart 3-20. Adding Remote Loopback Points

NOTE: Before executing this procedure, make sure you have purchased the link fault sectionalization feature. If you are not sure if you have purchased the link fault sectionalization feature, contact your Tekelec Sales Representative or Account Representative.

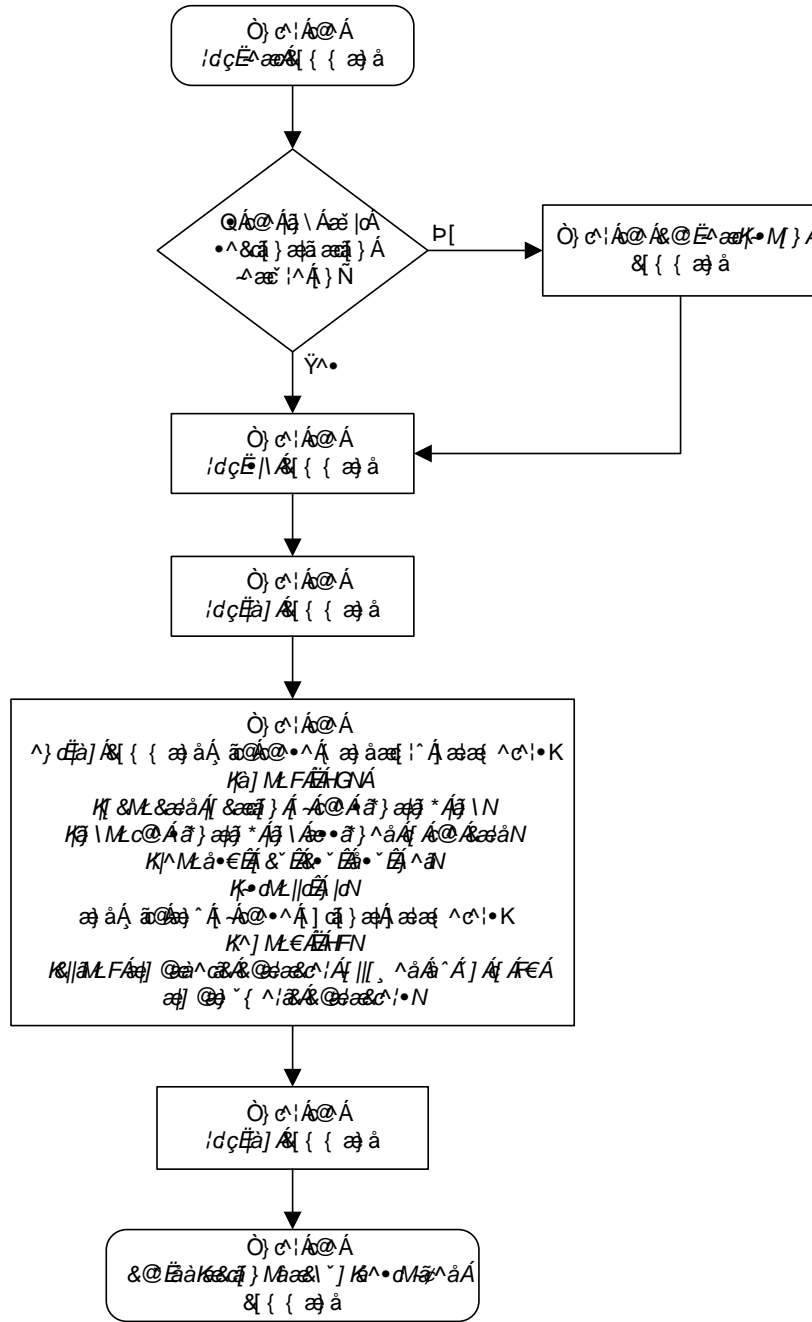

Removing Remote Loopback Points

This procedure is used to remove remote loopback points used by the link fault sectionalization feature from the database, using the `dlt-lbp` command. The `dlt-lbp` command uses these parameters.

`:loc` – The card location of the signaling link to be tested.

`:link` – The signaling link on the card specified in the `loc` parameter.

`:lbp` – Identifies the far-end loopback point that lies along a SS7 signaling link path between the EAGLE 5 SAS up to and including the target device.

`:all` – Are all loopback points for the specified signaling link to be removed

The specified loopback point must be in the database.

Either the `lbp` or `all` parameters must be specified, but not both.

This examples used in this procedure are used to remove the remote loopback point 5 on the signaling link assigned to card 1215, link B.

Procedure

1. Display the existing loopback point values by entering the `rtrv-lbp` command. This is an example of the possible output.

```
rlghncxa03w 05-09-17 16:02:05 GMT EAGLE5 34.0.0
LOC  LINK  LBP  RLE  REP  CLLI  LFAST
1201  A      1   DS0  0  -----  LLT
      7   OCU  0  -----  NLT
      9   NEI  0  -----  LLT

1203  B      2   DS0  0  -----  LLT
      3   DS0  4  -----  LLT
      4   NEI  0  -----  LLT

1204  B      3   DS0  0  -----  LLT
      6   DS0  4  -----  LLT
      9   NEI  0  -----  LLT

1207  B      1   DS0  0  -----  LLT
      6   NEI  0  -----  LLT

1215  A      1   DS0  0  -----  LLT
      3   DS0  4  -----  LLT
      5   DS0  5  -----  LLT
      7   DS0  8  -----  LLT
      9   NEI  0  -----  LLT
```

- Remove the loopback point from the database, using the `dlt-lbp` command. For this example, enter this command.

```
dlt-lbp:loc=1215:link=b:lbp=5
```

If all the loopback points on the signaling link are to be removed from the database, enter this command.

```
dlt-lbp:loc=1215:link=b:all=yes
```

When the command has completed, this message should appear.

```
rlghncxa03w 05-09-07 00:22:57 GMT EAGLE5 34.0.0
DLT-LBP: MASP A - COMPLTD
```

- Verify the changes using the `rtrv-lbp` command. This is an example of the possible output.

```
rlghncxa03w 05-09-17 16:02:05 GMT EAGLE5 34.0.0
LOC  LINK  LBP  RLE  REP  CLLI  LFST
1201  A      1    DS0  0    -----  LLT
      7    OCU  0    -----  NLT
      9    NEI  0    -----  LLT

1203  B      2    DS0  0    -----  LLT
      3    DS0  4    -----  LLT
      4    NEI  0    -----  LLT

1204  B      3    DS0  0    -----  LLT
      6    DS0  4    -----  LLT
      9    NEI  0    -----  LLT

1207  B      1    DS0  0    -----  LLT
      6    NEI  0    -----  LLT

1215  A      1    DS0  0    -----  LLT
      3    DS0  4    -----  LLT
      7    DS0  8    -----  LLT
      9    NEI  0    -----  LLT
```

If the `all=yes` parameter was specified in step 2, this is an example of the possible output.

```
rlghncxa03w 05-09-17 16:02:05 GMT EAGLE5 34.0.0
LOC  LINK  LBP  RLE  REP  CLLI  LFST
1201  A      1    DS0  0    -----  LLT
      7    OCU  0    -----  NLT
      9    NEI  0    -----  LLT

1203  B      2    DS0  0    -----  LLT
      3    DS0  4    -----  LLT
      4    NEI  0    -----  LLT

1204  B      3    DS0  0    -----  LLT
      6    DS0  4    -----  LLT
      9    NEI  0    -----  LLT

1207  B      1    DS0  0    -----  LLT
      6    NEI  0    -----  LLT
```

Changing Remote Loopback Points

This procedure is used to change the values of the remote loopback points to be used by the link fault sectionalization feature in the database, using the **chg-lbp** command. The **chg-lbp** command uses these parameters.

- :loc** – The card location of the signaling link to be tested.
- :link** – The signaling link on the card specified in the **loc** parameter.
- :lbp** – Identifies the far-end loopback point that lies along a SS7 signaling link path between the EAGLE 5 SAS up to and including the target device.
- :cli** – The CLI code or other mnemonic identifier used to describe the specified loopback point.
- :rle** – The remote link element to be looped back for testing.
- :rep** – The number of link elements of the same type, not including the target device, that lies between the EAGLE 5 SAS and the link element to be tested.
- :fst** – The type of link fault sectionalization loopback test to be performed.

The DS0 and network element interface (NEI) link elements do not support non-latching loopbacks

If the remote link element to be tested is a network element interface (NEI), the value of the **rep** parameter must be zero.

The **rep** parameter can only be specified for a link fault sectionalization latching loopback test

The specified loopback point must be in the database.

The loopback point ID value cannot exceed a previously defined network element interface loopback point value.

Only one network element interface loopback point can be defined for each SS7 signaling link.

A network element interface (NEI) loopback point must be defined as the terminating SS7 signaling link component.

The value specified for the **rep** parameter must be greater than the value of the **rep** parameter assigned to the previous loopback point and less than any **rep** parameter values for any subsequent loopback points, if any are defined. For example, the signaling link on card 1215, link B, has 5 loopback points defined (see the **rtrv-lbp** command output in step 1). The value of the **rep** parameter used for loopback point 5 must be greater than the **rep** parameter value used for loopback point 3, and less than the **rep** parameter value used for loopback point 7.

Refer to Appendix A of the *Commands Manual* for a summary of loopback testing commands and functions.

The examples used in this procedure are based on the example network shown in Figure 3-3 and are used to change the values of the **rep** and **rle** parameters (**rep=4**, **rle=ds0**) for loopback point 6 on the signaling link assigned to card 1204, link B, to a repetition count of 10 (**rep=10**) and the RLE to CSU (**rle=csu**).

Procedure

1. Display the existing loopback point values by entering the **rtrv-lbp** command. This is an example of the possible output.

```
rlghncxa03w 05-09-17 16:02:05 GMT EAGLE5 34.0.0
LOC  LINK  LBP  RLE  REP  CLLI  LFST
1201  A      1   DS0  0  -----  LLT
      7   OCU  0  -----  NLT
      9   NEI  0  -----  LLT

1203  B      2   DS0  0  -----  LLT
      3   DS0  4  -----  LLT
      4   NEI  0  -----  LLT

1204  B      3   DS0  0  -----  LLT
      6   DS0  4  -----  LLT
      9   NEI  0  -----  LLT

1207  B      1   DS0  0  -----  LLT
      6   NEI  0  -----  LLT

1215  A      1   DS0  0  -----  LLT
      3   DS0  4  -----  LLT
      5   DS0  5  -----  LLT
      7   DS0  8  -----  LLT
      9   NEI  0  -----  LLT
```

2. Change the loopback point values in the database, using the **chg-lbp** command. For this example, enter this command.

chg-lbp:loc=1204:link=b:lbp=6:rle=csu:rep=10

When the command has completed, this message should appear.

```
rlghncxa03w 05-09-07 00:22:57 GMT EAGLE5 34.0.0
CHG-LBP: MASP A - COMPLTD
```

3. Verify the changes using the **rtrv-lbp** command. This is an example of the possible output.

```

rlghncxa03w 05-09-17 16:02:05 GMT EAGLE5 34.0.0
LOC  LINK  LBP  RLE  REP  CLLI  LFST
1201  A    1    DS0  0  -----  LLT
      7    OCU  0  -----  NLT
      9    NEI  0  -----  LLT

1203  B    2    DS0  0  -----  LLT
      3    DS0  4  -----  LLT
      4    NEI  0  -----  LLT

1204  B    3    DS0  0  -----  LLT
      6    CSU 10  -----  LLT
      9    NEI  0  -----  LLT

1207  B    1    DS0  0  -----  LLT
      6    NEI  0  -----  LLT

1215  A    1    DS0  0  -----  LLT
      3    DS0  4  -----  LLT
      5    DS0  5  -----  LLT
      7    DS0  8  -----  LLT
      9    NEI  0  -----  LLT

```

4. Back up the new changes using the **chg-db:action=backup:dest=fixed** command. These messages should appear, the active Maintenance and Administration Subsystem Processor (MASP) appears first.

```

BACKUP (FIXED) : MASP A - Backup starts on active MASP.
BACKUP (FIXED) : MASP A - Backup on active MASP to fixed disk complete.
BACKUP (FIXED) : MASP A - Backup starts on standby MASP.
BACKUP (FIXED) : MASP A - Backup on standby MASP to fixed disk complete.

```

Configuring the System for Random SLS Generation

The Random SLS Generation feature can alleviate problems of the EAGLE 5 SAS not load-sharing between all links within a linkset.

The ITU protocol uses a 4 bit Signaling Link Selection (SLS) field with no modification of SLS values by intermediate nodes and a one-to-one mapping of SLS values to signaling links. These rules can be overly restrictive in situations where they are not necessary.

The feature allows the user to have the EAGLE 5 SAS ignore the incoming SLS value and randomly generate a new 8-bit SLS value to select an outgoing linkset and a link. The original 4-bit SLS value is not changed and is still contained in the outgoing message. The newly generated SLS is used for link selection only. Messages destined for a particular destination are randomly distributed across all the links to that destination using an internally generated random 8-bit SLS. This means that this feature does not follow the ITU protocol requiring that all messages with the same SLS value must use the same signaling link. Also, correct sequencing of Class 1 messages is not guaranteed. Random SLS generation applies to all Class 0 and Class 1 SCCP messages. Random SLS generation is not required to support ISUP messages.

This feature is implemented with one of these values for the `randsls` parameter of the `chg-stpopts` command.

- `class0` - Applies the Random SLS feature to Class 0 ITU SCCP messages and associated service. For example, Random SLS Generation would apply to Class 0 UDT, XUDT, and UDTS, XUUDTS messages. Class 1 messages would still use the standard ITU method for link selection.
- `all` - Applies the Random SLS feature to all ITU SCCP messages
- `off` - Turns off the Random SLS feature.



CAUTION: If the `randsls` parameter value of the `chg-stpopts` command is `all`, thus activating the Random SLS feature for Class 1 ITU SCCP messages, and the value of the `class1seq` parameter of the `chg-sccpopts` command is `on`, there is no guarantee that UDT/XUDT ITU Class 1 messages are delivered to the remote node in the order in which they were received. To ensure that Class 1 UDT/XUDT ITU messages are delivered to the remote node in the order in which they were received, the `randsls` parameter value should be set to either `off` or `class0` if the value of the `class1seq` parameter of the `chg-sccpopts` command is `on`.

The settings for this feature are independent of the ITU SLS Enhancement feature settings for individual linksets. These settings are defined by the `s1socbit` (Use of the Other CIC BIT capability) and `s1srsb` (SLS Bit Rotation capability) parameters of the `ent-1s` and `chg-1s` commands. The `rand1s` parameter, however, overrides the `s1srsb` parameter for SCCP messages. These parameters are described in greater detail in the *Commands Manual* and in the "ITU SLS Enhancement" section on page 3-29. Note that the `ent-1s` or `chg-1s` commands do not prevent the user from provisioning the `s1srsb` parameter.

With the implementation of this feature, a maximum of 16 links continues to be supported in a single linkset to a destination. However, it is now possible to have up to 32 links in a combined linkset to a destination, with a maximum of 16 links per linkset. The 32 links is a change from the current EAGLE 5 SAS maximum of only 16 links per combined linkset, which is due to ITU protocol restrictions. If more than 16 links are used in a combined linkset, the operator needs to be aware that a maximum of 16 links can be used by non-Random SLS traffic over the linkset. The non-Random SLS traffic continues to operate under the rules of the ITU protocol.

Figure 3-23 shows an example of a combined linkset from node A to nodes B and C, with 8 links per linkset. Since 8 bits allows for values 0-255 (decimal), the figure shows how these values are internally mapped to the links of the combined linkset. For ease of reading, not all values are shown.

Flowchart 3-23. Random SLS Mapping to a Combined Linkset

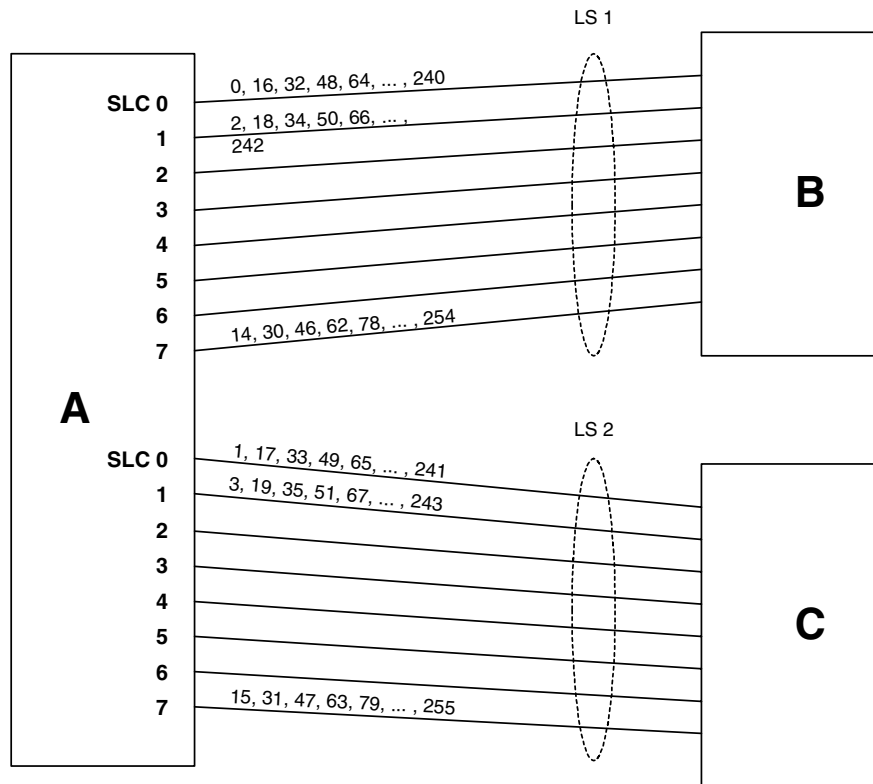
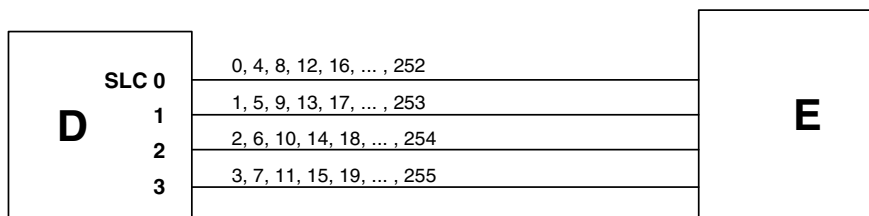

Figure 3-7 shows the mapping for a 4-link single linkset between nodes D and E. When an MSU is to be transmitted, a random 8 bit SLS is generated internally and a link is selected according to this predetermined mapping.

Figure 3-7. Random SLS Mapping to a Single Linkset



The 4 bit SLS in the outgoing message is equal to the SLS that the EAGLE 5 SAS received. There is no change to the SLS value in the SS7 message.

In a non-failure condition, the process for mapping the internally generated SLS values to SLC (Signaling Link Code) values for specific links is as follows:

1. A “random” 8-bit SLS value is generated. In reality, a single table of 256 unique SLS values, initially generated in random order, exists in the EAGLE 5 SAS. A counter is maintained for each linkset in the EAGLE 5 SAS that causes the linkset to cycle through the random values in the table as messages are routed out on that linkset. For a combined linkset, the counter for the first linkset in the EAGLE 5 SAS's linkset table is used.
2. For a combined linkset, the first bit is used to select the linkset and then is ignored when selecting the SLC. For a single linkset, the first bit is used when selecting the SLC. In all cases, the fifth bit is ignored when selecting the SLC. This is due to internal ANSI-based processing in the EAGLE 5 SAS.
3. The changed SLS value (with fifth and possibly also first bits ignored) is then divided by the number of links in the linkset (not a combined linkset) and the remainder gives the SLC value. For example, in Figure 3-23 on page 3-255, the SLS value 78 is mapped to SLC 7 in linkset LS1 as follows:
 - a. The binary equivalent for decimal number 78 is 01001110.
 - b. The fifth bit is ignored leaving the binary number 0101110.
 - c. The least significant bit is used to select linkset LS1 and is then ignored, leaving the binary number 010111.
 - d. The decimal equivalent of the binary number 010111 is 23. When the number 23 is divided by the number of links in the linkset, in this example, eight, a remainder of seven remains, thus SLC 7 on linkset LS1 is chosen for the outgoing message.

SS7 Configuration

In the example shown in Figure 3-7 on page 3-256, the SLS value 78 is mapped to SLC 2 in LS1 (the only linkset) as follows:

- a. The binary equivalent for decimal number 78 is 01001110.
- b. The fifth bit is ignored leaving the binary number 0101110.
- c. The decimal equivalent of the binary number 0101110 is 46. When the number 46 is divided by the number of links in the linkset, in this example, four, a remainder of two remains, thus SLC 2 on linkset LS1 is chosen for the outgoing message.

Table 3-15 on page 3-257 shows the mapping for a combined linkset with 16 links in each linkset. This table is discussed in more detail in the next section.

Link failure scenarios

In any situation where a link is failed, SLS values that were mapped to that link are remapped to other links of the linkset or combined linkset. This is done in the reverse order that the SLS values were originally mapped to links, of course skipping the failed link. Subsequent link failures will have their SLS values, along with SLS values from the prior failures, remapped in the same way. The odd/even mapping rule for combined linksets does not apply to the remapped SLS values under failure conditions. This is to continue to achieve the best possible load balance across all links. No MSUs should be discarded in any case.

For example, Table 3-15 shows how the internal 8-bit SLS values are distributed for a combined linkset with 16 links per linkset. It also shows what happens when one or two of the links fail. As this example shows, the SLS values that are identical after the fifth bit is dropped (for example, 0 and 16, 192 and 208, etc.) are remapped to the same link. This is why in this example the 8 different SLS values from the first failed link are remapped to only 4 links and not 8.

Table 3-15. Failure Scenarios for a 32-Link Combined Linkset

Linkset /SLC	Normal SLS Mapping	SLS Mapping for Single Link Failure	SLS Mapping for Dual Link Failure
LS1/0	0 16 64 80 128 144 192 208	Failed	Failed
LS1/1	2 18 66 82 130 146 194 210	Same as Normal SLS Mapping	Same as Normal SLS Mapping
LS1/7	14 30 78 94 142 158 206 222	Same as Normal SLS Mapping	Same as Normal SLS Mapping
LS1/8	32 48 96 112 160 176 224 240	Same as Normal SLS Mapping	Same as Normal SLS Mapping
LS1/9	34 50 98 114 162 178 226 242	Same as Normal SLS Mapping	Same as Normal SLS Mapping
LS1/12	40 56 104 120 168 184 232 248	Same as Normal SLS Mapping	40 56 ... 248 225 241

Table 3-15. Failure Scenarios for a 32-Link Combined Linkset (Continued)

Linkset /SLC	Normal SLS Mapping	SLS Mapping for Single Link Failure	SLS Mapping for Dual Link Failure
LS1/13	42 58 106 122 170 186 234 250	Same as Normal SLS Mapping	42 58 ... 250 161 177
LS1/14	44 60 108 124 172 188 236 252	44 60 ... 252 192 208	44 60 ... 252 97 113
LS1/15	46 62 110 126 174 190 238 254	46 62 ... 254 64 80	46 62 ... 254 33 49
LS2/0	1 17 65 81 129 145 193 208	Same as Normal SLS Mapping	Same as Normal SLS Mapping
LS2/7	15 31 79 95 143 159 207 223	Same as Normal SLS Mapping	Same as Normal SLS Mapping
LS2/8	33 49 97 113 161 177 225 241	Same as Normal SLS Mapping	Failed
LS2/12	41 57 105 121 169 185 233 249	Same as Normal SLS Mapping	41 57 ... 249 192 208
LS2/13	43 59 107 123 171 187 235 251	Same as Normal SLS Mapping	43 59 ... 251 128 144
LS2/14	45 61 109 125 173 189 237 253	45 61 ... 253 128 144	45 61 ... 253 64 80
LS2/15	47 63 111 127 175 191 239 255	47 63 ... 255 0 16	47 63 ... 255 0 16

Because of the large number of internal SLS values being remapped across the relatively small number of links, traffic is essentially evenly distributed across the remaining links. This is true in all cases, regardless of the original number of links or the number of failed links.

Procedure

1. Display the existing values for the `randsls` parameter by entering the `rtrv-stpopts` command. The value for the `randsls` parameter is shown in the `RANDSLS` field.

This is an example of the possible output.

```
rlghncxa03w 05-09-17 16:02:05 GMT EAGLE5 34.0.0
STP OPTIONS
-----
RANDSLS          class0
```

NOTE: The `rtrv-stpopts` command output contains other fields that are not used by this procedure. If you wish to see all the fields displayed by the `rtrv-stpopts` command, see the `rtrv-stpopts` command description in the *Commands Manual*.

NOTE: If the `rands1s=all` parameter will not be specified with the `chg-stpopts` command, skip this step and step 3, and go to step 4.

2. Verify the value of the `class1seq` parameter of the `chg-sccpopts` command by entering the `rtrv-sccpopts` command. This is an example of the possible output.

```
rlghncxa03w 05-09-17 16:02:05 GMT EAGLE5 34.0.0
```

```
SCCP OPTIONS
-----
CLASS1SEQ          on
```

If the value of the `class1seq` parameter is `on`, the `rands1s=all` parameter of the `chg-stpopts` command should not be used. The `class1seq=on` parameter allows UDT/XUDT Class 1 ITU messages to be delivered to the remote node in the order that they were received. Using the `rands1s=all` parameter with the `class1seq=on` parameter does not guarantee that UDT/XUDT Class1 ITU messages are delivered to the remote node in the order that they were received.

If you wish to continue delivering UDT/XUDT Class 1 ITU messages to the remote node in the order that they were received, or if the value of the `class1seq` parameter of the `chg-sccpopts` command is `off`, skip step 3 and go to step 4.

If you do not wish to continue delivering UDT/XUDT Class 1 ITU messages to the remote node in the order that they were received, go to step 3.

3. Change the value of the `class1seq` parameter of the `chg-sccpopts` command by entering this command.

```
chg-sccpopts:class1seq=off
```

When this command has successfully completed, this message should appear.

```
rlghncxa03w 05-09-07 00:22:57 GMT EAGLE5 34.0.0
CHG-STPOPTS: MASP A - COMPLTD
```

4. Change the `rands1s` parameter value. For this example, enter this command.

```
chg-stpopts:rands1s=all
```

When this command has successfully completed, this message should appear.

```
rlghncxa03w 05-09-07 00:22:57 GMT EAGLE5 34.0.0
CHG-STPOPTS: MASP A - COMPLTD
```

5. Verify the changes using the `rtrv-stpopts` command. This is an example of the possible output.

```
rlghncxa03w 05-09-17 16:02:05 GMT EAGLE5 34.0.0  
STP OPTIONS
```

```
-----  
RANDSLS          all
```

NOTE: The `rtrv-stpopts` command output contains other fields that are not used by this procedure. If you wish to see all the fields displayed by the `rtrv-stpopts` command, see the `rtrv-stpopts` command description in the *Commands Manual*.

6. Back up the new changes using the `chg-db:action=backup:dest=fixed` command. These messages should appear, the active Maintenance and Administration Subsystem Processor (MASP) appears first.

```
BACKUP (FIXED) : MASP A - Backup starts on active MASP.  
BACKUP (FIXED) : MASP A - Backup on active MASP to fixed disk complete.  
BACKUP (FIXED) : MASP A - Backup starts on standby MASP.  
BACKUP (FIXED) : MASP A - Backup on standby MASP to fixed disk complete.
```

Flowchart 3-24. Configuring the System for Random SLS Generation (Sheet 1 of 2)

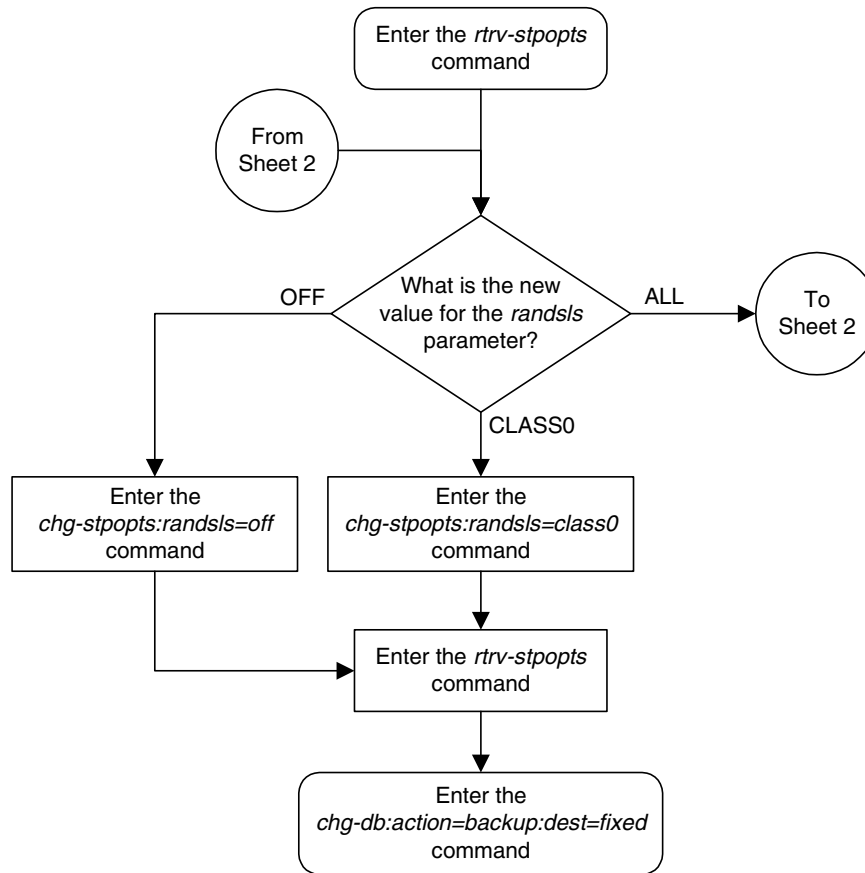

Flowchart 3-24. Configuring the System for Random SLS Generation (Sheet 2 of 2)

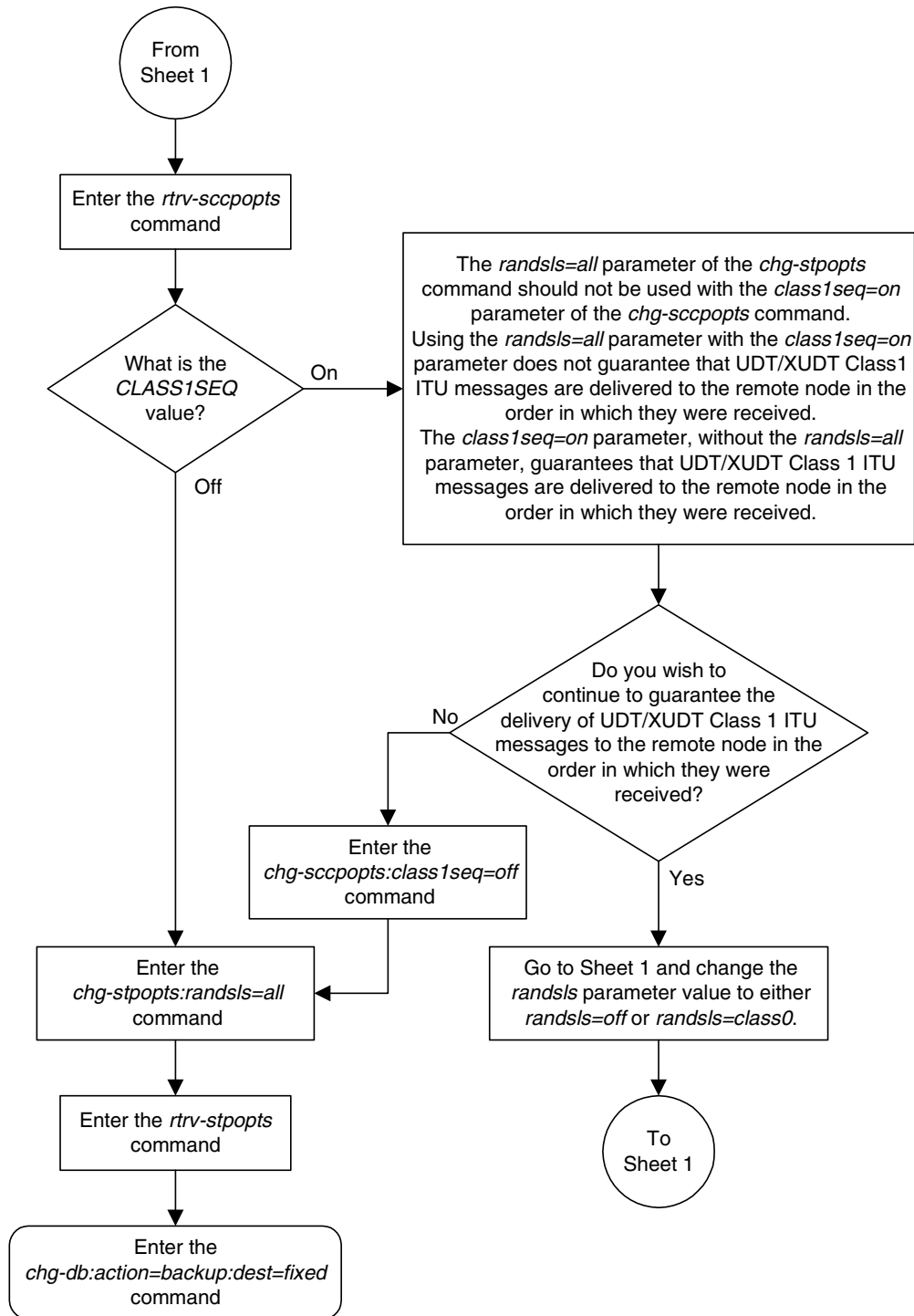

Configuring the Options for the TDM Global Timing Interface

This procedure is used to configure the options for the TDM Global Timing Interface using the `hsc1ksrc` and `hsc1k11` parameters of the `chg-stpopts` command and the following parameters.

- `:hsc1ksrc` – the source of the high-speed master clock.
- `rs422` – T1 (1544 KHz) or E1 (2048 KHz) RS-422 clock interface
- `t1framed` – T1 framed clocking as defined in ANSI T1.101, *Synchronization Interface Standard*, 1999.
- `t1unframed` – T1 unframed clocking as defined in ANSI T1.102, *Digital Hierarchy Electrical Signals*, 1987.
- `e1framed` – E1 framed clocking as defined in section 9 of ITU-T Recommendation G.703, *Physical/Electrical Characteristics of Hierarchical Digital Interfaces*, October 1998.
- `e1unframed` – E1 unframed clocking as defined in section 13 of ITU-T Recommendation G.703, *Physical/Electrical Characteristics of Hierarchical Digital Interfaces*, October 1998.

`:hsc1k11` – sets the gain of the LIU (line interface unit) of the TDM when the `hsc1ksrc` parameter value is either `t1unframed`, `t1unframed`, `e1framed`, or `e1unframed`.

- `longhaul` – high gain for the LIU
- `shorthaul` – low gain for the LIU



CAUTION: Changing these options changes the external master clock source for all E1, T1, ANSI ATM, or E1 ATM high-speed signaling links using external timing.

`:force` - allows the `hsc1ksrc` parameter to be changed if the status of the high-speed clocks is valid. The `force` parameter must be specified when the EAGLE 5 SAS contains valid high-speed clocks. The `force` parameter can be specified only if the `hsc1ksrc` parameter is specified. The `force` parameter has only one value - `yes`. The status of the high-speed clocks is shown by the `rept-stat-clk` command.

When the EAGLE 5 SAS is delivered to the user, the values of the `hsc1ksrc` and `hsc1k11` parameters are set to these values:

- `hsc1ksrc` – `rs422`
- `hsc1k11` – `longhaul`

Either of these values can be changed only if the part number of both TDMs in card locations 1114 and 1116 is 870-0774-15 or later. If the part numbers of the TDMs are not correct, the TDMs with the incorrect part numbers must be replaced with TDM part number 870-0774-15 or later.



CAUTION: Contact the Customer Care Center, refer to “Customer Care Center” on page 1-8 for the contact information, before replacing the TDMs.

If the EAGLE 5 SAS does not contain LIMDS0 cards, but contains TDM part numbers 870-0774-15 or later, the clock source for the TSC (Time Slot Counter) synchronization feature used by the Integrated Sentinel can be generated from the high-speed master clock source. An external BITS clock is not required.

If an external BITS clock is connected to a EAGLE 5 SAS without LIMDS0 cards, but with TDM part numbers 870-0774-15 or later, the external BITS clock is used as the clock source for the TSC (Time Slot Counter) synchronization feature. If the external BITS clock fails, the clock source for the TSC synchronization feature is generated from the high-speed master clock source.

If LIMDS0 cards are present in the EAGLE 5 SAS, the external BITS clock is required for timing of the DS0 signaling links and for TSC (Time Slot Counter) synchronization used by the Integrated Sentinel. If the EAGLE 5 SAS also contains TDM part numbers 870-0774-15 or later along with the LIMDS0 cards, this procedure can be used to select the source of the high-speed master clock for the high-speed links using external timing. The high-speed master clock source cannot be used to generate the clock source for any low-speed links and for the TSC (Time Slot Counter) synchronization feature.

Procedure

1. Display the existing values for the `hsc1ksrc` and `hsc1k11` parameters by entering the `rtrv-stpopts` command. The value for the `hsc1ksrc` and `hsc1k11` parameters is shown in the `HSCLKSRC` and `HSCLKLL` fields.

This is an example of the possible output.

```
rlghncxa03w 05-09-17 16:02:05 GMT EAGLE5 34.0.0
STP OPTIONS
-----
HSCLKSRC          RS422
HSCLKLL          LONGHAUL
```

NOTE: The `rtrv-stpopts` command output contains other fields that are not used by this procedure. If you wish to see all the fields displayed by the `rtrv-stpopts` command, see the `rtrv-stpopts` command description in the *Commands Manual*.

NOTE: If either the **HSCLKSRC** or **HSCLKLL** values in step 1 are not the system default values for these parameters (**HSCLKSRC - RS422, HSCLKLL - LONGHAUL**), skip step 2 and go to step 3.

2. Visually verify the part numbers of the TDMs in card location 1114 and 1116. To change these options, the part number of both TDMs must be 870-0774-15 or later. If the part number of one or both TDMs is not 870-0774-15 or later, the TDM with the incorrect part number must be replaced with TDMs with the correct part number.



CAUTION: Contact the Customer Care Center, refer to “Customer Care Center” on page 1-8 for the contact information, before replacing the TDMs.

3. Verify the status of the high-speed clocks by entering the **rept-stat-clk** command. This is an example of the possible output.

```

rlghncxa03w 05-09-01 11:34:04 GMT EAGLE5 34.0.0
CARD LOC = 1114 (Standby )   CARD LOC = 1116 (Active )
PRIMARY BITS   = Active     PRIMARY BITS   = Active
SECONDARY BITS = Idle       SECONDARY BITS = Idle
HS PRIMARY CLK = Active     HS PRIMARY CLK = Active
HS SECONDARY CLK = Idle     HS SECONDARY CLK = Idle
HS CLK TYPE    = RS422      HS CLK TYPE    = RS422
HS CLK LINELEN = LONGHAUL   HS CLK LINELEN = LONGHAUL

                                PST          SST          AST
SYSTEM CLOCK                   IS-NR          Active     -----
ALARM STATUS                    = No Alarms.
# Cards using CLK A = 009      # Cards with bad CLK A = 000
# Cards using CLK B = 000      # Cards with bad CLK B = 000
# Cards using CLK I = 000

                                PST          SST          AST
HS SYSTEM CLOCK                 IS-NR          Active     -----
ALARM STATUS                    = No Alarms.
# Cards using HS CLK A = 002   # Cards with bad HS CLK A = 000
# Cards using HS CLK B = 000   # Cards with bad HS CLK B = 000
# Cards using HS CLK I = 000

Command Completed.
    
```

If the **rept-stat-clk** output does not show any high-speed clocks (**HS SYSTEM CLOCK, HS PRIMARY CLK, HS SECONDARY CLK, HS CLK TYPE, and HS CLK LINELEN** fields), the EAGLE 5 SAS does not contain any cards that are capable of using high-speed master timing.

- Change either the `hsclksrc` or `hsclkll` parameter values, or both parameter values. For this example, enter this command.

```
chg-stpopts:hsclksrc=tlunframed:hsclkll=shorthaul:force=yes
```

Note: If the `rept-stat-clk` output in step 3 shows valid high-speed clocks, and the `hsclksrc` parameter is specified with the `chg-stpopts` command, the `force=yes` parameter must be specified with the `chg-stpopts` command.



CAUTION: Changing these options changes the external master clock source for all E1, T1, ANSI ATM, or E1 ATM high-speed signaling links using external timing.

When this command has successfully completed, this message should appear.

```
rlghncxa03w 05-09-07 00:22:57 GMT EAGLE5 34.0.0
CHG-STPOPTS: MASP A - COMPLTD
```

- Verify the changes using the `rtrv-stpopts` command. This is an example of the possible output.

```
rlghncxa03w 05-09-17 16:02:05 GMT EAGLE5 34.0.0
STP OPTIONS
```

```
-----
HSCLKSRC      TIUNFRAMED
HSCLKLL      SHORTHHAUL
```

NOTE: The `rtrv-stpopts` command output contains other fields that are not used by this procedure. If you wish to see all the fields displayed by the `rtrv-stpopts` command, see the `rtrv-stpopts` command description in the *Commands Manual*.

- Back up the new changes using the `chg-db:action=backup:dest=fixed` command. These messages should appear, the active Maintenance and Administration Subsystem Processor (MASP) appears first.

```
BACKUP (FIXED) : MASP A - Backup starts on active MASP.
BACKUP (FIXED) : MASP A - Backup on active MASP to fixed disk complete.
BACKUP (FIXED) : MASP A - Backup starts on standby MASP.
BACKUP (FIXED) : MASP A - Backup on standby MASP to fixed disk complete.
```

Flowchart 3-25. Configuring the Options for the TDM Global Timing Interface (Sheet 2 of 2)

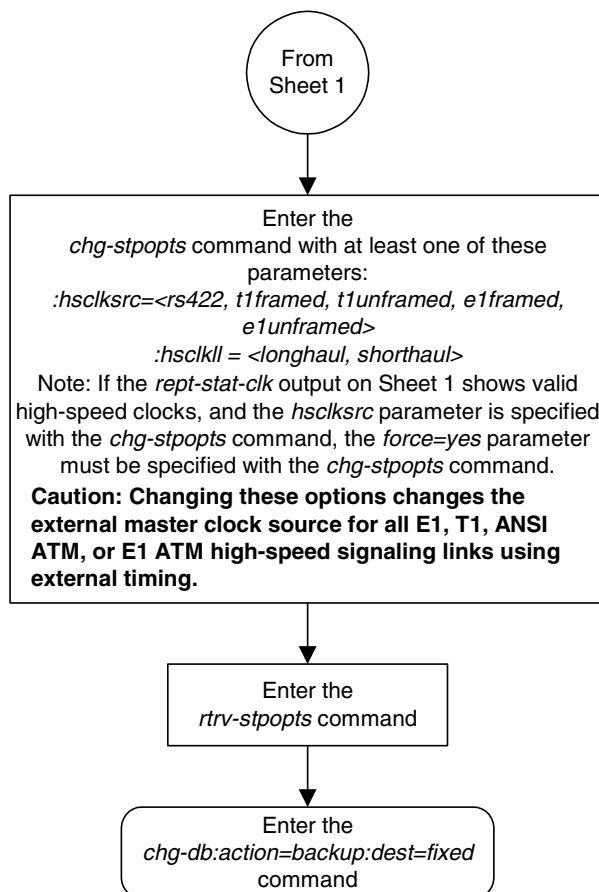

Configuring the Restricted Linkset Option

This procedure is used to configure the restricted linkset option using the `chg-ss7opts` command with the `lsrestrict` parameter. The `lsrestrict` parameter has two values:

- `on` – enables the `lsrestrict` option
- `off` – disables the `lsrestrict` option.

When a large linkset (a linkset containing more than three links) first becomes available, there may not be enough available links to carry the normal amount of traffic on the linkset. The EAGLE 5 SAS sends response method TFA/TFRs when the number of links within a linkset, specified by the `tfatcabmlq` parameter for that linkset, are active and available to carry traffic. This was designed to prevent congestion on the newly available linksets. Internally in the EAGLE 5 SAS, if a single link within a lower cost route is active, the EAGLE 5 SAS attempts to route traffic over the lower cost route. If no traffic or small amounts of traffic are arriving due to the issuance of a TFR, then no congestion should occur.

However, this behavior applies only to traffic destined for remote nodes and not to traffic destined for the EAGLE 5 SAS itself. Typically, messages that are global title routed are destined for the EAGLE 5 SAS's true, secondary or capability point code. The existing congestion prevention mechanism does not prevent traffic destined for EAGLE 5 SAS to be controlled by the linkset's `tfatcabmlq` parameter. This is because TFX messages have an affected point code field that is the far end destination point code and not the EAGLE 5 SAS's point code, so traffic destined for EAGLE 5 SAS continues to arrive for the restricted destination. It is not feasible to place EAGLE 5 SAS's point code in the affected destination field as this would affect all traffic destined for EAGLE 5 SAS and not just traffic over a specific route.

With the `lsrestrict=off` option, the EAGLE 5 SAS continues to route traffic in this manner.

The `lsrestrict=on` option enhances the EAGLE 5 SAS's existing behavior of the linkset's `tfatcabmlq` parameter and allow the state of the route combined with the cost value of the route to determine the preferred route to use.

Turning the `lsrestrict` option on changes the way the EAGLE 5 SAS routes messages by using the state of the route along with the cost of the route to determine the preferred route to use. With this option on, the preferred route is not the absolute lowest cost available route in the routeset. A route is considered available if its status is either Allowed or Restricted. If the state of the absolute lowest cost route in the routeset is Restricted, the preferred route is the lowest cost route in the routeset whose status is Allowed. Make sure that you wish to have the EAGLE 5 SAS route messages in this manner before turning the `lsrestrict` option on.

In previous releases, a C linkset's `tfatcabmlq` parameter is not configurable and set to 1 (the linkset is allowed when the first link is available). This is because the C linkset is designed for message trafficking between the mate STP's and would allow these messages to be transferred as soon as the first link in the C linkset was available. The `lsrestrict=on` option allows the `tfatcabmlq` parameter value for a C linkset to be from 0 to 16, just as any other linkset.

With the `lsrestrict=off` option, the `tfatcabmlq` parameter value for a C linkset is set to 1 and cannot be changed.

When a linkset that was previously prohibited becomes restricted (that is, the number of links that became available is less than the required number of links as specified by the linkset's `tfatcabmlq` parameter) the following events occur when the `lsrestrict` option is `on`:

1. The EAGLE 5 SAS does not broadcast TFAs.
2. Point codes that were previously prohibited and use the linkset as a lower cost route are marked restricted. The EAGLE 5 SAS continues to broadcast TFRs.
3. Point codes that were previously restricted and use the linkset as a least cost route remain restricted. The EAGLE 5 SAS does not broadcast any TFX message. For these point codes, RSRT will respond to RSP messages with a TFR, and will not respond to RSR messages.
4. The EAGLE 5 SAS marks the linkset as restricted.
5. If a higher cost route is available, the EAGLE 5 SAS routes the traffic over the higher cost route.

Once the required number of links are available for the linkset, the following events occur when the `lsrestrict` option is `on`:

1. The EAGLE 5 SAS marks the previously prohibited/restricted point codes as allowed that use the linkset as a lower cost route (unless the point code's nonadjacent status is prohibited).
2. The EAGLE 5 SAS does not broadcast TFAs for the newly allowed point codes, but responds to RSR/RSP messages with a TFA.
3. The EAGLE 5 SAS marks the linkset as allowed. The appropriate changeback procedures are performed and traffic is processed normally.

Canceling the RTRV-LS Command

Because the `rtrv-ls` command used in this procedure can output information for a long period of time, the `rtrv-ls` command can be canceled and the output to the terminal stopped. There are three ways that the `rtrv-ls` command can be canceled.

- Press the **F9** function key on the keyboard at the terminal where the `rtrv-ls` command was entered.
- Enter the `canc-cmd` without the `trm` parameter at the terminal where the `rtrv-ls` command was entered.
- Enter the `canc-cmd:trm=<xx>`, where `<xx>` is the terminal where the `rtrv-ls` command was entered, from another terminal other than the terminal where the `rtrv-ls` command was entered. To enter the `canc-cmd:trm=<xx>` command, the terminal must allow Security Administration commands to be entered from it and the user must be allowed to enter Security Administration commands. The terminal's permissions can be verified with the `rtrv-secu-trm` command. The user's permissions can be verified with the `rtrv-user` or `rtrv-secu-user` commands.

For more information about the `canc-cmd` command, go to the *Commands Manual*.

Procedure

1. Display the existing value for the `lsrestrict` parameter by entering the `rtrv-ss7opts` command. This is an example of the possible output.

```
rlghncxa03w 05-09-17 16:02:05 GMT EAGLE5 34.0.0
```

```
SS7 OPTIONS
-----
LSRESTRICT          off
```

NOTE: The `rtrv-ss7opts` command output contains other fields that are not used by this procedure. If you wish to see all the fields displayed by the `rtrv-ss7opts` command, see the `rtrv-ss7opts` command description in the *Commands Manual*.

NOTE: If the `lsrestrict` parameter value in step 1 is `off`, skip steps 2 and 3, and go to step 4.

2. Display the linksets in the database by entering the `rtrv-ls` command. This is an example of the possible output.

```
rlghncxa03w 05-09-10 11:43:04 GMT EAGLE5 34.0.0
```

LSN	APCA (SS7)	SCRN	L3T SLT		BEI	LST	LNKS	GWS			SLSCI	NIS
			SET	SET				ACT	MES	DIS		
e1e2	001-207-000	none	1	1	no	B	6	off	off	off	no	off
ls05	002-009-003	scr2	1	1	no	C	4	on	off	on	no	off
ls1305	000-005-000	none	1	1	no	A	1	off	off	off	no	off
ls1307	000-007-000	none	1	1	no	A	1	off	off	off	no	off
e1m1s1	001-001-001	none	1	1	no	A	7	off	off	off	no	off

```

e1m1s2      001-001-002  none  1   1   no  A   7   off off off no   off

LSN          APCA   (X25)  SCRN  SET SET BEI LST LNKS ACT MES DIS SLSCI NIS

           L3T SLT                GWS GWS GWS
LSN          APCI   (SS7)  SCRN  SET SET BEI LST LNKS ACT MES DIS SLSCI NIS
e1e2i       1-207-0      none  1   1   no  B   4   off off off ---  on
ls1315      0-015-0      none  1   1   no  A   1   off off off ---  off
ls1317      0-017-0      none  1   1   no  A   1   off off off ---  on
e1m2s1      1-011-1      none  1   1   no  A   7   off off off ---  off
e1m2s2      1-011-2      none  1   1   no  A   7   off off off ---  off

LSN          APCN   (SS7)  SCRN  SET SET BEI LST LNKS ACT MES DIS SLSCI NIS

           L3T SLT                GWS GWS GWS
LSN          APCN24 (SS7)  SCRN  SET SET BEI LST LNKS ACT MES DIS SLSCI NIS

           L3T SLT                GWS GWS GWS
LSN (CHINA)  APCN   (SS7)  SCRN  SET SET BEI LST LNKS ACT MES DIS SLSCI NIS

           L3T SLT                GWS GWS GWS
LSN (CHINA)  APCN24 (SS7)  SCRN  SET SET BEI LST LNKS ACT MES DIS SLSCI NIS

```

Link set table is (11 of 1024) 1% full.

NOTE: If there are no C linksets (linksets with the value c in the LST column) shown in the `rtrv-ls` output in step 2, skip step 3 and go to step 4.

3. Change the `tfatcabmlq` parameter value for one of the C linksets shown in step 2 to 0 using the `chg-ls` command. For this example, enter this command.

```
chg-ls:lsn=ls05:tfatcabmlq=0
```

When this command has successfully completed, this message should appear.

```

rlghncxa03w 05-09-07 08:38:45 GMT EAGLE5 34.0.0
Link set table is ( 11 of 1024) 1% full
CHG-LS: MASP A - COMPLTD

```

After the `chg-ls` command has been performed, repeat step 3 with the name of another C linkset shown in step 2.

When all the C linksets have been changed, go to step 4.

NOTE: When the `tfatcabmlq` parameter is set to 0, its value in the `rtrv-ls:lsn=<linkset name>` output is shown as 1/2 of the number of signaling links contained in the linkset.

4. Change the value of the `lsrestrict` parameter.

If the current value of the `lsrestrict` parameter is off, enter this command.

```
chg-ss7opts:lsrestrict=on
```

If the current value of the `lsrestrict` parameter is on, enter this command.

```
chg-ss7opts:lsrestrict=off
```

When this command has successfully completed, this message should appear.

```
rlghncxa03w 05-09-07 00:22:57 GMT EAGLE5 34.0.0
CHG-SS7OPTS: MASP A - COMPLTD
```



CAUTION: Turning the `lsrestrict` option on changes the way the EAGLE 5 SAS routes messages by using the state of the route along with the cost of the route to determine the preferred route to use. With this option on, the preferred route is not the absolute lowest cost available route in the routeset. A route is considered available if its status is either Allowed or Restricted. If the state of the absolute lowest cost route in the routeset is Restricted, the preferred route is the lowest cost route in the routeset whose status is Allowed. Make sure that you wish to have the EAGLE 5 SAS route messages in this manner before turning the `lsrestrict` option on.

5. Verify the changes using the `rtrv-ss7opts` command. This is an example of the possible output.

```
rlghncxa03w 05-09-17 16:02:05 GMT EAGLE5 34.0.0

SS7 OPTIONS
-----
LSRESTRICT      on
```

NOTE: The `rtrv-ss7opts` command output contains other fields that are not used by this procedure. If you wish to see all the fields displayed by the `rtrv-ss7opts` command, see the `rtrv-ss7opts` command description in the *Commands Manual*.

6. Back up the new changes using the `chg-db:action=backup:dest=fixed` command. These messages should appear, the active Maintenance and Administration Subsystem Processor (MASP) appears first.

```
BACKUP (FIXED) : MASP A - Backup starts on active MASP.
BACKUP (FIXED) : MASP A - Backup on active MASP to fixed disk complete.
BACKUP (FIXED) : MASP A - Backup starts on standby MASP.
BACKUP (FIXED) : MASP A - Backup on standby MASP to fixed disk complete.
```

Flowchart 3-26. Configuring the Restricted Linkset Option (Sheet 1 of 2)

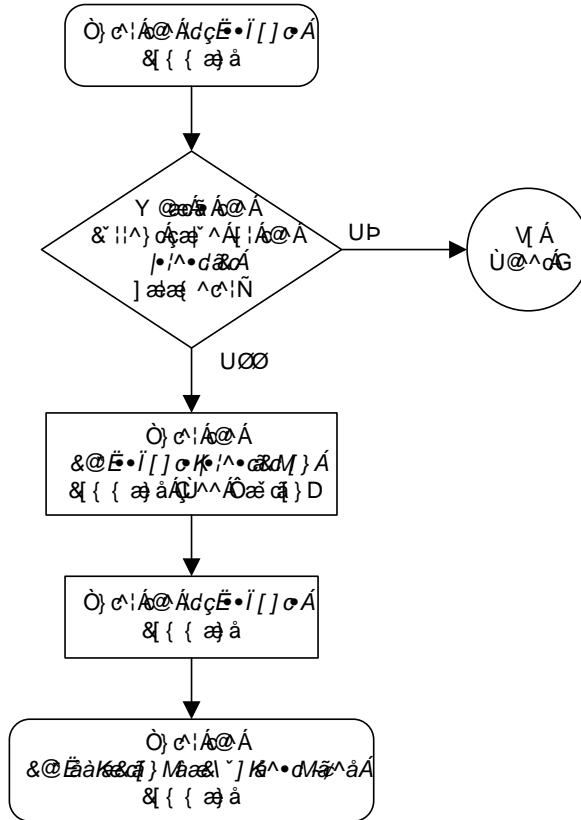

7 U hçb. V !} æ * A@A/^•dæA] ç} A} A@æ * ^•A@A æ A@AØØSÒA ÅUCEJÁ[~ e•Á { ^••æ^•A•A•æ * A@AæA•A@A[~ eAæ] * A æ@æ&[•o! A@A[~ eAæ^e!{ æ^A @A!^•!!^aA[~ eAæ^A^EY æ@æA] ç} A} EæA!^•!!^aA[~ eAæA[ç@æA•[~ eA [~ ^•o&[•oæææ^A[~ eAæA[~ e^•dæA[~ eA&[•æ^!^aæææ^!AæAææ•A æAæ@!A[~ ^aA!A^•dæAæAæAæAæAæA[~ eA[~ ^•o&[•oA[~ eAæA [~ e^•o&A^•dæAæAæA[~ eA!^•!!^aA[~ eAæA[~ ^•o&[•oA[~ eAæA[~ e^•o&A @•^Aææ^AæA[~ ^aAææ^A!^AæA[~ A æ @æAæA@AØØSÒA ÅUCEJÁ[~ eA { ^••æ^•A•A•æ } ^!A^!^A{ } æ * A@A/^•dæA] ç} A} E

Flowchart 3-26. Configuring the Restricted Linkset Option (Sheet 2 of 2)

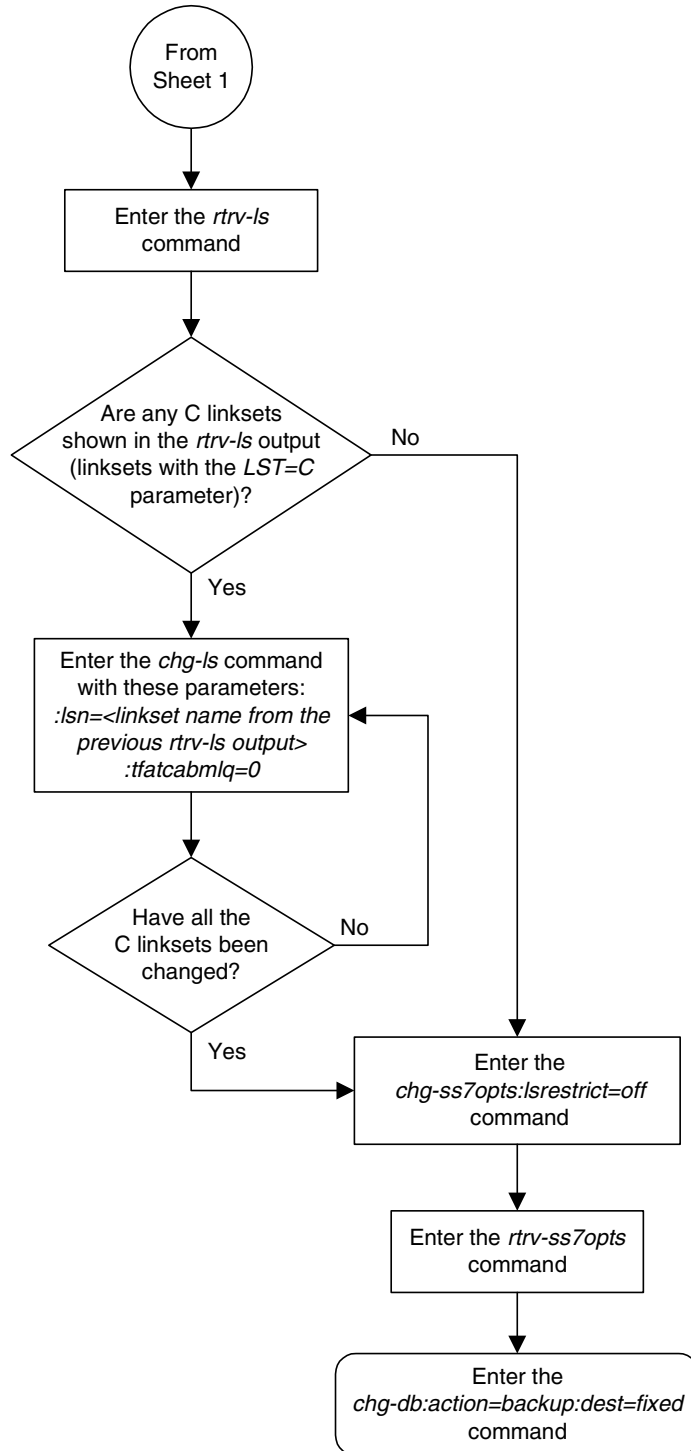

Configuring the Options for Handling TFCs on ITU-I and ITU-N Networks

This procedure is used to configure the options for handling TFCs on ITU-I and ITU-N networks using the `chg-ss7opts` command with these two parameters:

:discardtfc – This parameter specifies that the EAGLE 5 SAS discards TFC traffic received from an ITU-I network (`discardtfc=on`), or does not discard TFC traffic received from an ITU-I network (`discardtfc=off`). The system default value for this parameter is `off`.

:discardtfcn – This parameter specifies that the EAGLE 5 SAS discards TFC traffic received from an ITU-N network (`discardtfcn=on`), or does not discard TFC traffic received from an ITU-N network (`discardtfcn=off`). The system default value for this parameter is `off`.

Procedure

1. Display the existing values for the `discardtfc` and `discardtfcn` parameters by entering the `rtrv-ss7opts` command. This is an example of the possible output.

```
rlghncxa03w 05-09-17 16:02:05 GMT EAGLE5 34.0.0
```

```
SS7 OPTIONS
-----
DISCARDTFCI          off
DISCARDTFCN          off
```

NOTE: The `rtrv-ss7opts` command output contains other fields that are not used by this procedure. If you wish to see all the fields displayed by the `rtrv-ss7opts` command, see the `rtrv-ss7opts` command description in the *Commands Manual*.

2. Change the value of the `discardtfc` and `discardtfcn` parameters.

The values of these parameters is either `on` or `off`. The value specified in this step cannot be the same as the value shown in step 1.

If you wish to change the value of the `discardtfc` parameter, specify the `discardtfc` parameter with the `chg-ss7opts` command. For this example, enter this command.

```
chg-ss7opts:discardtfc=on
```

If you wish to change the value of the `discardtfcn` parameter, specify the `discardtfcn` parameter with the `chg-ss7opts` command. For this example, enter this command.

```
chg-ss7opts:discardtfcn=on
```

If you wish to change the value of both the `discardtfc` and `discardtfcn` parameters, specify the `discardtfc` and `discardtfcn` parameters with the `chg-ss7opts` command. For this example, enter this command.

```
chg-ss7opts:discardtfc=on:discardtfcn=on
```

When this command has successfully completed, this message should appear.

```
rlghncxa03w 05-09-07 00:22:57 GMT EAGLE5 34.0.0
CHG-SS7OPTS: MASP A - COMPLTD
```

3. Verify the changes using the `rtrv-ss7opts` command. This is an example of the possible output.

```
rlghncxa03w 05-09-17 16:02:05 GMT EAGLE5 34.0.0
```

```
SS7 OPTIONS
-----
DISCARDTFCI          on
DISCARDTFCN          on
```

NOTE: The `rtrv-ss7opts` command output contains other fields that are not used by this procedure. If you wish to see all the fields displayed by the `rtrv-ss7opts` command, see the `rtrv-ss7opts` command description in the *Commands Manual*.

4. Back up the new changes using the `chg-db:action=backup:dest=fixed` command. These messages should appear, the active Maintenance and Administration Subsystem Processor (MASP) appears first.

```
BACKUP (FIXED) : MASP A - Backup starts on active MASP.
BACKUP (FIXED) : MASP A - Backup on active MASP to fixed disk complete.
BACKUP (FIXED) : MASP A - Backup starts on standby MASP.
BACKUP (FIXED) : MASP A - Backup on standby MASP to fixed disk complete.
```

Changing the HC MIM Temperature Alarm Thresholds

This procedure is used to change the temperature alarm thresholds for the HC MIMs using the `chg-th-alm` command and these parameters.

:thermallv1c – The Celsius temperature threshold, from 60 to 76 degrees Celsius, at which major alarm UAM 0078 is generated. UAM 0078 is generated to alert the user that corrective action needs to be performed to prevent the HC MIM from overheating.

:thermallv2c – The Celsius temperature threshold, from 61 to 82 degrees Celsius, at which critical alarm UAM 0077 is generated. When this threshold is reached, the HC MIM is powered down, and all traffic on the signalling links assigned to the HC MIM is lost.

:thermallv1f – The Fahrenheit temperature threshold, from 140 to 167 degrees Fahrenheit, at which major alarm UAM 0078 is generated. UAM 0078 is generated to alert the user that corrective action needs to be performed to prevent the HC MIM from overheating.

:thermallv2f – The Fahrenheit temperature threshold, from 142 to 180 degrees Fahrenheit, at which critical alarm UAM 0077 is generated. When this threshold is reached, the HC MIM is powered down, and all traffic on the signalling links assigned to the HC MIM is lost.

For more information on these alarms, go to the *Maintenance Manual*.

The `chg-th-alm` command contains other optional parameters. These parameters are not shown here because they are not necessary to provision the HC MIM temperature alarm thresholds. These parameters are explained in more detail in the *Commands Manual*.

Procedure

1. Display the current HC MIM temperature alarm thresholds in the database by entering the `rtrv-th-alm` command. This is an example of the possible output.

```
rlghncxa03w 05-09-28 09:12:36 GMT EAGLE5 34.0.0
Thermal Alarm Level 1:          75 Degrees Celsius
Thermal Alarm Level 2:          82 Degrees Celsius
Command Executed
```

NOTE: The `rtrv-th-alm` command output contains other fields that are not used in this procedure. If you wish to see all the fields displayed by the `rtrv-th-alm` command, see the `rtrv-th-alm` command description in the *Commands Manual*.

2. Change the temperature alarm thresholds by entering the **chg-th-alm** command with at least one of the temperature alarm threshold parameters.

The temperature can be entered as a Fahrenheit temperature. The EAGLE 5 SAS converts the Fahrenheit temperature to a Celsius temperature. The temperature is displayed in the **rtrv-th-alm** output as a Celsius temperature.

If a Celsius temperature value is specified, the **thermallv2c** parameter value shown in the **rtrv-th-alm** output after the **chg-th-alm** command has been executed must be greater than the **thermallv1c** parameter value shown in the **rtrv-th-alm** output.

If both Fahrenheit temperature values are specified, the **thermallv2f** parameter value must be greater than the **thermallv1f** parameter value.

If only the **thermallv1f** parameter is specified, the **thermallv1f** parameter value must be less than the Fahrenheit equivalent of the **thermallv2c** parameter value shown in the **rtrv-th-alm** output.

If only the **thermallv2f** parameter is specified, the **thermallv2f** parameter value must be greater than the Fahrenheit equivalent of the **thermallv1c** parameter value shown in the **rtrv-th-alm** output.

If a temperature parameter is not specified with the **chg-th-alm** command, that parameter value will not be changed. The system default values for the temperature parameters are:

- **:thermallv1c = 75**
- **:thermallv2c = 82**
- **:thermallv1f = 167**
- **:thermallv2f = 180.**

NOTE: Values for the **thermallv1f** and **thermallv2f** parameters cannot be specified if these values convert to the same Celsius temperature value. For example, the **thermallv1f=146** and **thermallv2f=147** parameters cannot be specified because both values convert to 63 degrees Celsius.

For this example, enter this command.

```
chg-th-alm:thermallv1c=70:thermallv2c=77
```

If these temperature values are entered as Fahrenheit temperatures, enter this command.

```
chg-th-alm:thermallv1f=158:thermallv2f=171
```

When this command has successfully completed, this message should appear.

```
rlghncxa03w 05-09-28 09:12:36 GMT EAGLE5 34.0.0
CHG-TH-ALM: MASP A - COMPLTD
```

SS7 Configuration

3. Verify the changes using the `rtrv-th-alm` command. This is an example of the possible output.

```
rlghncxa03w 05-09-28 09:12:36 GMT EAGLE5 34.0.0
Thermal Alarm Level 1:          70 Degrees Celsius
Thermal Alarm Level 2:          77 Degrees Celsius
Command Executed
```

NOTE: The `rtrv-th-alm` command output contains other fields that are not used in this procedure. If you wish to see all the fields displayed by the `rtrv-th-alm` command, see the `rtrv-th-alm` command description in the *Commands Manual*.

4. Backup the new changes using the `chg-db:action=backup:dest=fixed` command. These messages should appear, the active Maintenance and Administration Subsystem Processor (MASP) appears first.

```
BACKUP (FIXED) : MASP A - Backup starts on active MASP.
BACKUP (FIXED) : MASP A - Backup on active MASP to fixed disk complete.
BACKUP (FIXED) : MASP A - Backup starts on standby MASP.
BACKUP (FIXED) : MASP A - Backup on standby MASP to fixed disk complete.
```

A

E1 Interface

Introduction.....	A-2
Determining the Configuration.....	A-8
Adding a LIM-E1 Card.....	A-14
Removing a LIM-E1 Card.....	A-24
Adding Channelized and non-Channel Bridged E1 Ports.....	A-28
Adding Channel Bridged E1 Ports.....	A-37
Adding Unchannelized E1 Ports.....	A-45
Removing the E1 Interface Parameters.....	A-59
Changing the Attributes of an E1 Port.....	A-62
Adding an E1 Signaling Link.....	A-77

Introduction

The E1 interface terminates or distributes E1 facility signals for the purpose of processing the SS7 signaling links carried by the E1 carrier. The E1 interface can be either a LIM-E1 card, an E1/T1 MIM card, or an HC MIM as shown in Figures A-1, A-2, and A-3. The E1/T1 MIM or HC MIM can also be used as a T1 interface. This appendix describes how an E1 interface is configured using either the LIM-E1 card, the E1/T1 MIM card, or HC MIM. The T1 interface configuration is described in Appendix B, "T1 Interface."

NOTE: The procedures in this appendix are used only to configure E1 signaling links on the LIM-E1 card, E1/T1 MIM card, or HC MIM. To configure an E1 high-speed signaling link (on the LIME1ATM card), go to the "Adding an ATM High-Speed Signaling Link" procedure on page C-34.

The LIM-E1 card contains only two signaling links. The E1/T1 MIM card contains up to eight signaling links and allows the EAGLE 5 SAS to contain more than 500 signaling links.

Figure A-1. LIM-E1 Block Diagram

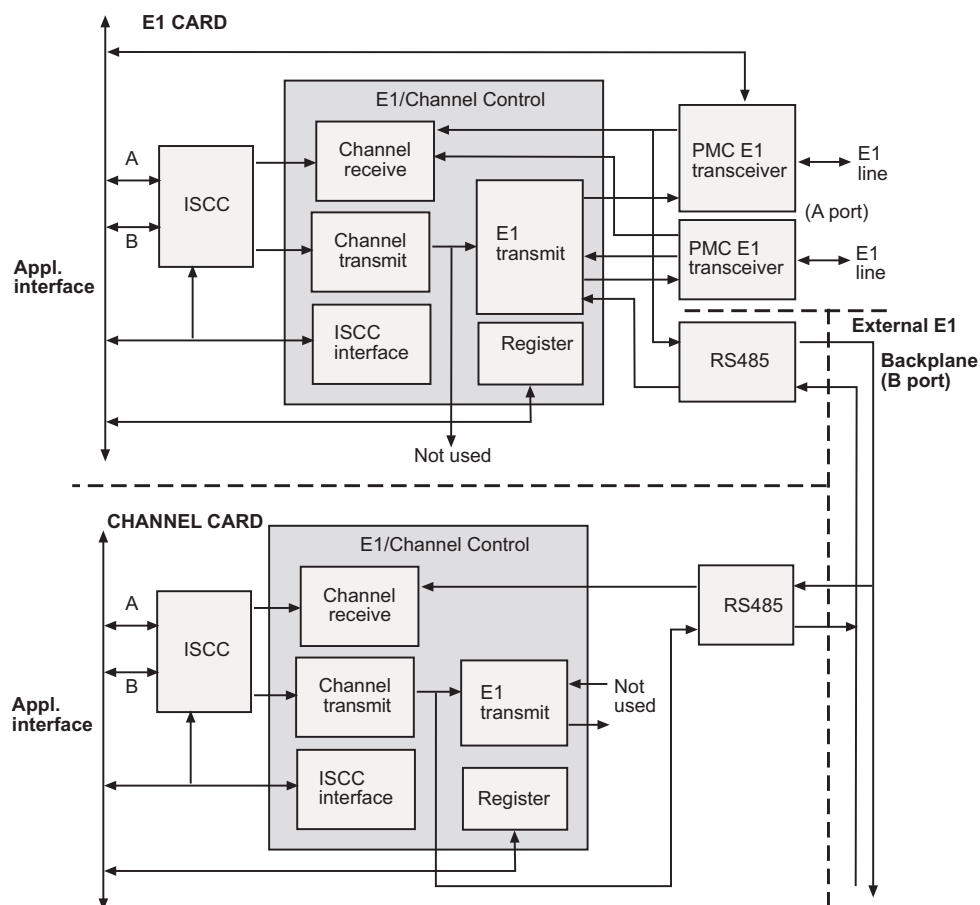

E1 Interface

Figure A-2. E1/T1 MIM Block Diagram

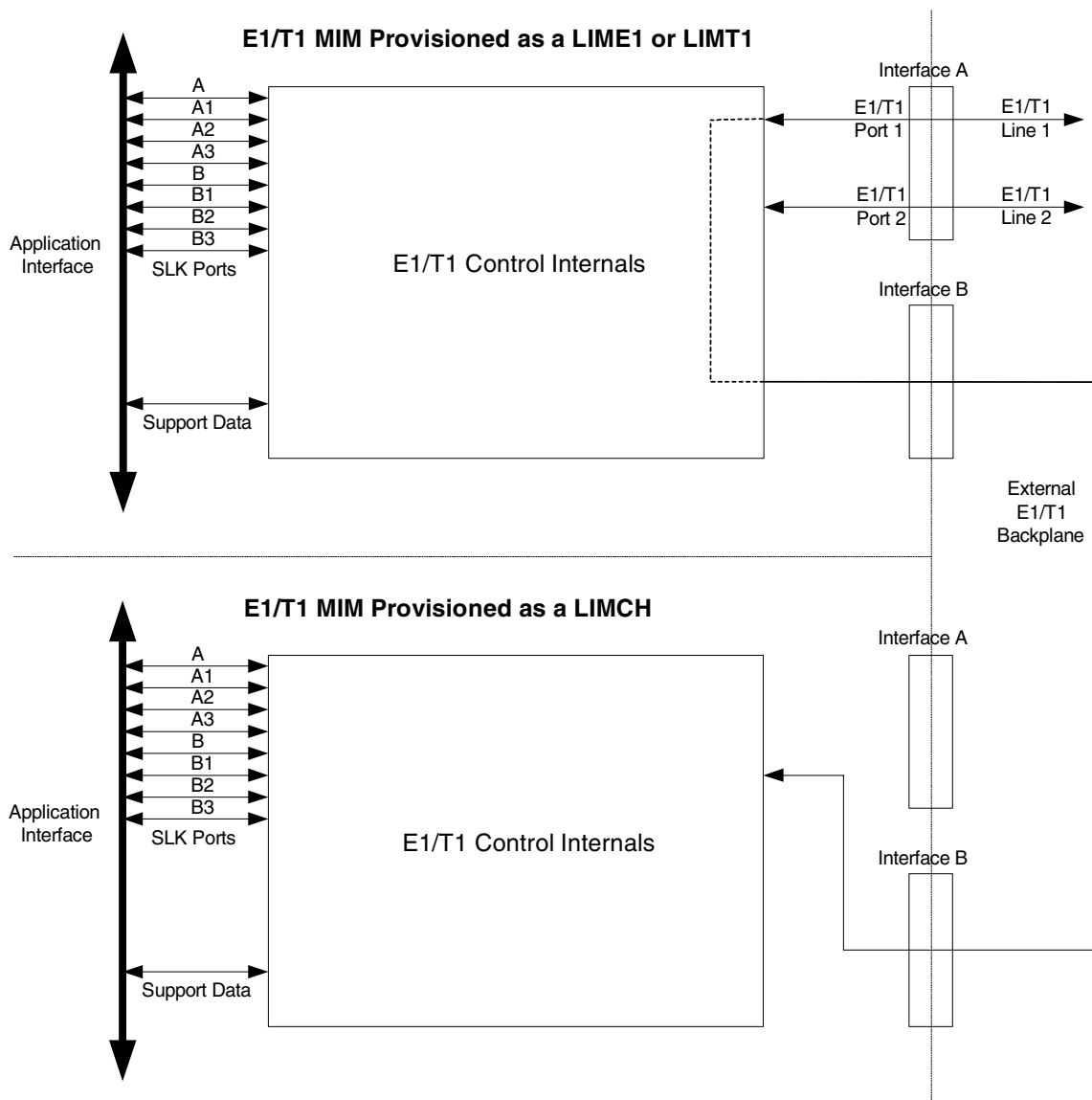
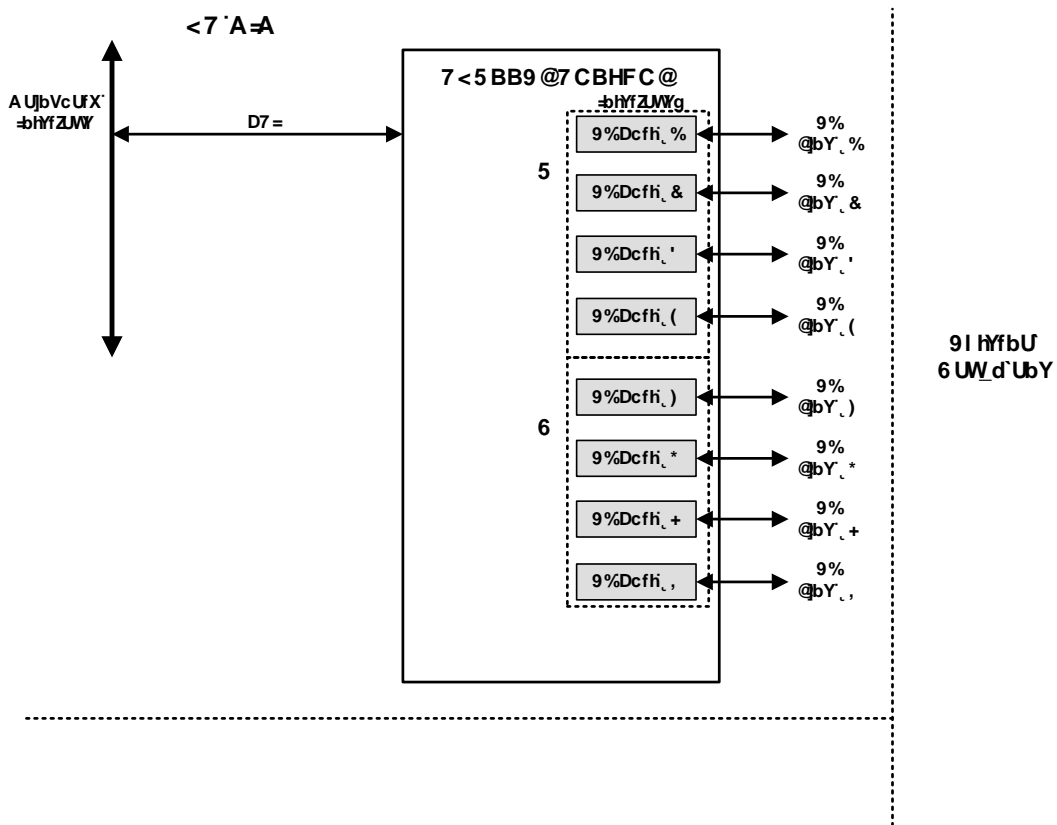

Figure A-3. HC MIM Block Diagram



E1 Interface

Table A-1 provides an overview of the functions of the E1 card and the channel card.

Table A-1. Functional Overview of the E1 and Channel Card

Card	Function
E1	<ul style="list-style-type: none">• Connectivity of both E1 interfaces to a 120 Ohm or 75 Ohm E1 interface. An external adapter is required for the 75 Ohm interface.• Processing up to a total of eight (only two if a LIM-E1 card is being used) time slots from the E1 interfaces• Interface E1 port 1 through an external backplane to channel cards for processing of additional time slots
Channel	<ul style="list-style-type: none">• Processing up to eight (only two if a LIM-E1 card configured as a channel card is being used) time slots from the E1 interface• Interface through an external backplane to an E1 card to process up to eight (only two if a LIM-E1 card configured as a channel card is being used) time slots

Configured as an E1 Card

Configured as an E1 card, two separate and independent E1 inputs can be terminated on an E1 card. If a LIM-E1 card is being used, one or two bi-directional channels are extracted from the E1 inputs and processed as SS7 signaling links. If an E1/T1 MIM is being used, one to eight bi-directional channels are extracted from the E1 inputs and processed as SS7 signaling links. Implemented as E1 Link Interface Modules, up to thirty two separate and independent E1 inputs can be terminated in an Extension Shelf. The LIME1 card can support signaling links transmitting at either 56 kbps or 64 kbps.

Configured as a Channel Card

In an Extension shelf equipped with an E1 cabling backplane, an E1 card terminates one or two E1 inputs and connects the E1 port 1 input to one of eight available busses on the E1 cabling backplane. Channel cards also connected to the E1 cabling backplane are able to extract any eight (or two if a LIM-E1 card configured as a channel card is being used) signaling channels from the same E1 port 1 input. In this manner, up to 31 E1 channels can be used for signaling - the 32nd channel is reserved for E1 synchronization. The LIME1 card can support signaling links transmitting at either 56 kbps or 64 kbps.

NOTE: An HC MIM cannot be used as a channel card.

High Capacity Multi-Channel Interface Module (HC MIM)

The High Capacity Multi-Channel Interface Module (HC MIM) provides access to eight E1 ports residing on backplane connectors A and B. Each data stream consists of 31 E1 DS0 signaling links assigned in a time-division multiplex manner. Each channel occupies a unique timeslot in the data stream and can be selected as a local signaling link on the interface card. A maximum of 64 E1 signaling links can be assigned to an HC MIM.

To support the processing of signaling channels that are intermixed on trunks with voice or data channels, the HC MIM allows E1 ports to be channel bridged. This allows better utilization of E1 bandwidth without dedicating entire trunks to signaling.

Figure A-4. Channel Bridging

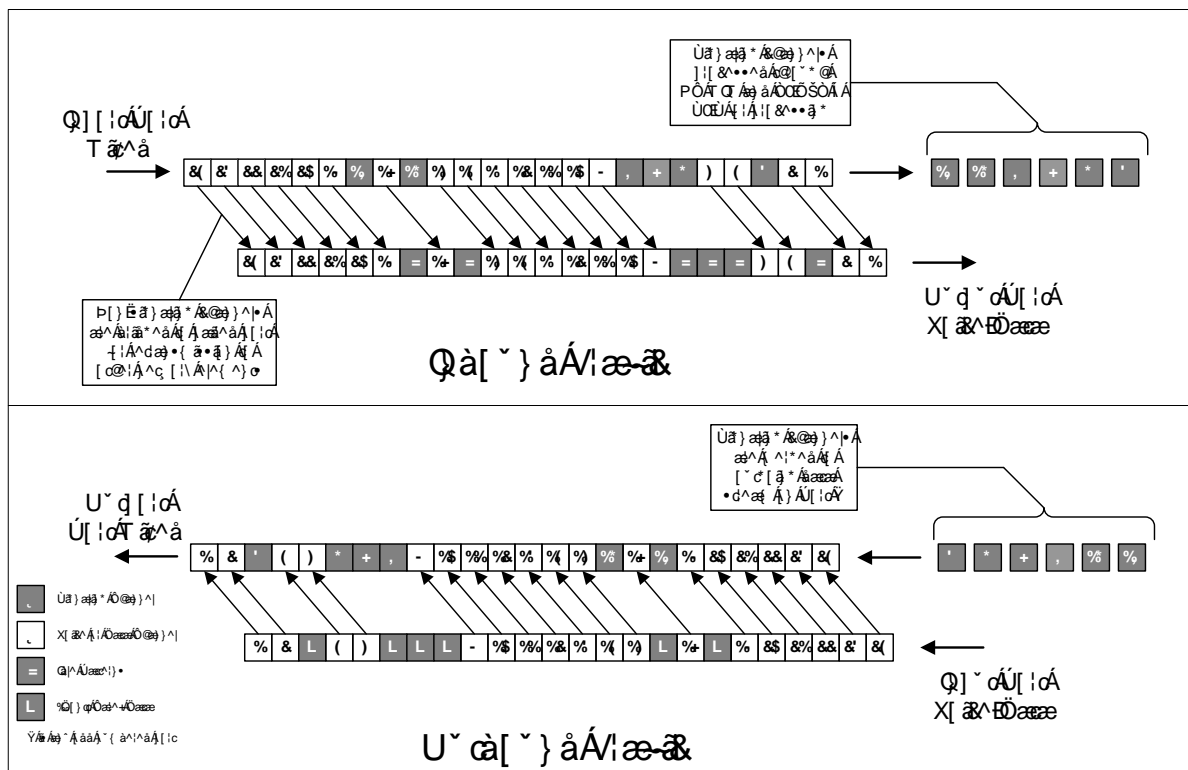

Channel bridging is implemented by pairing odd and even E1 ports. The E1 port selected for channel bridging is the odd numbered port (1, 3, 5, 7). When the E1 port is selected for channel bridging, it is paired with its adjacent even numbered port (2, 4, 6, 8) as shown in Table A-2.

Table A-2. Channel Bridging E1 Port Pairing

Odd Numbered E1 Port (Bridging Master)	Even Numbered E1 Port Bridged to the Odd Numbered E1 Port (Bridging Slave)
1	2
3	4
5	6
7	8

By pairing E1 ports, the adjacent even numbered E1 port could be used to allow data received on the bridging master (odd) E1 port to reach downstream network elements. This interface is a bi-directional interface so data is also able to enter the bridging slave (even) E1 port and leave the EAGLE 5 SAS through the bridging master (odd) E1 port. There is a 1 to 1 correspondence between the timeslots on the bridging master and slave E1 ports.

In order to use channel bridging without facility errors, both E1 ports (bridging master and slave) must be synchronous (timed off the same clock source). This may be accomplished in one of the following ways:

- The bridging master E1 port and the bridging slave E1 port use timing recovered from each other (using the `e1tsel=recovered` parameter with either the `ent-e1` or `chg-e1` command). When provisioning channel bridged E1 port, only the bridging master E1 port is provisioned with the `ent-e1` or `chg-e1` command. The bridging slave E1 port is automatically provisioned with the same attributes as the bridging master E1 port.
- Both the bridging master and slave E1 ports are using an external clock source (using the `e1tsel=external` parameter when provisioning the channel bridged E1 port with either the `ent-e1` or `chg-e1` command).

Any other methods used for timing could cause problems on the E1 trunk and are not be supported.

Idle patterns on the shadow channels, that is, the timeslots located on the bridging slave E1 port that have been not been dropped from the bridging master E1 port, are provided by the EAGLE 5 SAS. All other idle timeslots that are not dropped by the EAGLE 5 SAS must contain an idle pattern provided by the remote network elements connected to both E1 ports (bridging master and slave). Without these patterns on the idle timeslots, instability of the E1 signaling link may occur.

Provisioning of signaling links on the bridging slave E1 port is not allowed while the bridging master E1 port is channel bridged.

Determining the Configuration

External Interface Descriptions

The E1 Interface Backplane provides a method for extending individual E1 channels from the E1-configured cards to any channel-configured cards in use. Note the following issues regarding the E1 backplane:

- Only one E1-configured card may be plugged into each bus on the backplane.
- When installing non-E1 cards on the shelf equipped with the E1 interface backplane, ensure that none of the slots to be used are cabled to the E1 interface backplane. If a non-E1 card is installed in a slot that is connected to the E1 backplane, all E1 cards on that bus may fail.
- Only one E1 card may be connected (via the B port) to each bus of the E1 cabling backplane, and all SS7 links derived from any particular E1 must be processed on the same shelf on which the incoming E1 is terminated.
- Due to cable congestion, Tekelec does not recommend use of the E1 cabling backplane on the control shelf.
- If the control shelf is used, a maximum of 20 E1 interfaces can be utilized in the control shelf.

The E1 backplane is impedance-controlled for 120 Ohms and is designed for use with RS-485 transmission characteristics.

Descriptions of the E1 hardware and the procedures for installing the E1 hardware are contained in the *Hardware Manual - EAGLE 5 SAS* and *Installation Manual - EAGLE 5 SAS*.

E1 Cards Containing DIP Switches

The EAGLE 5 SAS can contain E1 cards with DIP switches. These switches were used in previous releases to configure the E1 parameters that are now configured by these commands:

- **ent-e1** – Adding E1 interface parameter information
- **chg-e1** – Changing E1 interface parameter information
- **ent-slk** – Adding a signaling link.

In this release, these switches are not used and the settings on these switches are ignored by the EAGLE 5 SAS.

E1 Interface

For more information on the `ent-e1`, `chg-e1`, and `ent-slk` commands, go to the *Commands Manual*, or see these procedures in this appendix:

- “Adding Channelized and non-Channel Bridged E1 Ports” procedure on page A-28
- “Changing the Attributes of an E1 Port” procedure on page A-62
- “Adding an E1 Signaling Link” procedure on page A-77.

The procedure for removing an E1 signaling link is the same as removing an SS7 signaling link, so to remove an E1 signaling link from the database, go to the “Removing an SS7 Signaling Link” procedure on page 3-145.

Possible Configurations

The E1 backplane was designed to allow the maximum number of possible customer setups. It allows the customer to choose between several levels of diversity and convenience. Configurations depend on the number of cards configured as E1 cards versus the number of cards configured as channel cards. The level of diversity required by the customer also affects the configuration requirements. Note that all signals labelled “E1 input” may be one or two E1 ports depending on the cable used.

Support of Two E1 Ports

The E1 card will support two E1 ports, which are independently configurable. On an E1 card, E1 port 1 will support channel cards. The second port of that E1 card will only support up to a maximum of eight (two for a LIM-E1 card) time slots and will not support channel cards.

Clocking Options

Each E1 interface must independently operate in one of two clocking modes. When configured as a channel card, an E1 card is required for the channel card’s clocking source.

- Slave Timing - The default receive clock on the LIM-E1 card will be used as the source of the transmit clock.
- Master Timing - The transmit clock of the LIM-E1 card will originate on this board. The oscillator on the board provides the clock source. *Note the oscillator is less accurate than the network clock.*

The Master Timing feature allows an E1 signaling link to take its high-speed clock reference directly from an external high-speed master clock source.

Support of E1 Framing Options

The E1 interfaces will independently support the following E1 framing options. Selection of these options will be made by the `crc4` and `cas` parameters of either the `ent-e1` or `chg-e1` commands.

- Clear Channel Signaling (CCS)
- Channel Associated Signaling (CAS)
- Cyclic Redundancy Check (CRC4)

The following provide for zero bit suppression: HDB-3 (High Density Bipolar encoding of order 3).

On any given E1 card, CCS and CAS are mutually exclusive and cannot be used together. However, CRC4 may be added to either CCS or CAS.

LIM-E1 Card to Channel Card Interface

Whether the E1/channel card is operating as an E1 card or a channel card, the card will map any eight channels (only 2 channels when the LIM-E1/channel card is being used) from the E1 interfaces to an HDLC controller (ports A, B, A1, B1, A2, B2, A3, B3 for the E1/T1 MIM card, or ports A and B for the LIM-E1 card). These channels could be dropped either both from E1 port 1 or one from E1 port 1 and the other from E1 port 2. When the E1/channel card is configured as an E1 card, it will support the external E1 cabling backplane interface from E1 port 1 (*E1 port 2 will not have this capability*) to additional E1/channel cards, within the same shelf, configured as channel cards. Idle time slots not assigned to an E1 card or a channel card will be filled with a one's pattern.

Channel Support

The E1/channel card will independently support either 56 kbps or 64 kbps on any channel.

Configuring the Signaling Links

The main consideration for the provisioning of E1s is to determine the number of E1s existing in the network and the equipment needed for grooming into the EAGLE 5 SAS. To utilize the flexibility of the E1 interface feature, you may want to determine the minimum number of E1 cards needed to process the total number of SS7 links and then consider diversity for reliability reasons.

E1 Interface

Use the following points as guidelines when considering diversity for E1:

- If possible, no two E1s containing links from a common link set should be on the same E1/dual port channel card.
- If possible, no two E1s containing links from a common link set should be on adjacent E1/dual port channel cards where they are powered from the same fuse position.
- If possible, no two E1s containing links from a common link set should be terminated on the same shelf because of the shelf clock cabling, and is only an issue if using master clocking sync to the network
- If possible, no two links in a link set should arrive at the EAGLE 5 SAS on the same E1.
- If possible, for link sets containing more than two links, you should minimize the number of links in that link set on any given E1.
- Customers may also wish to mix the LIM V.35 or LIM OCU in any shelf as needed for site requirements.

As an example, consider a network to be groomed into the EAGLE 5 SAS consisting of 30 E1s with a total number of 100 links where the largest link set size is 8. The most efficient way to provision the EAGLE 5 SAS would be to have four extension shelves equipped with the E1 cabling backplane, one E1 card, and 12 channel cards per shelf. Utilizing one B bus on each shelf, 25 signaling links would be terminated on each shelf for a total of 100. *This is also the minimum number of E1 cards required for this example.*

With the same example but using the third and fifth bullets above as a consideration, the EAGLE 5 SAS would be provisioned with eight extension shelves equipped with the E1 cabling backplane. Four of the shelves would be equipped with one E1 card and six channel cards, and the other four shelves would be equipped with one E1 card and five channel cards. *Since the largest link set size is eight, a total of eight E1 cards is required.* Utilizing one B bus on each shelf, 13 signaling links would be terminated on each shelf with six channel cards, and 12 signaling links would be terminated on each shelf with five channel cards.

NOTE: When retrieving link information from the database, the links for an E1 or channel card is not displayed until after the card is allowed.

E1 Interface Configuration Procedures

This appendix contains these procedures because they contain information specific to the E1 Interface:

- “Adding a LIM-E1 Card” on page A-14
- “Removing a LIM-E1 Card” on page A-24
- “Adding Channelized and non-Channel Bridged E1 Ports” on page A-28
- “Adding Channel Bridged E1 Ports” on page A-37
- “Adding Unchannelized E1 Ports” on page A-45
- “Removing the E1 Interface Parameters” on page A-59
- “Changing the Attributes of an E1 Port” on page A-62
- “Adding an E1 Signaling Link” on page A-77

Procedures for configuring the linksets and routes, for removing SS7 signaling links (which includes E1 signaling links), and for configuring the HC MIM temperature alarms are contained in Chapter 3, “SS7 Configuration.” These procedures contain no information that is specific to the E1 interface, therefore, are not included in this appendix.

The procedures contained in this appendix use a variety of commands. If more information on these commands is needed, go to the *Commands Manual* to find the required information.

Adding a LIM-E1 Card

The LIM-E1 card is provisioned in the database using the `ent-card` command. This card can be provisioned as either an E1 card or a channel card. The card being provisioned in the database can be one of these cards shown in Table A-4.

Table A-4. E1 Card Part Numbers

Card Type	Part Number
LIM-E1	870-1379-XX
E1/T1 MIM	870-2198-XX
HC MIM	870-2671-01

The `ent-card` command uses these parameters.

`:loc` – The location of the card being added to the database.

NOTE: The HC MIM can be inserted only in a odd-numbered card location. The HC MIM will not power up if it is inserted in an even-numbered card location. All the E1 backplane cabling should be removed from the B connector for the slot that the HC MIM will occupy.

The HC MIM occupies two card locations, so the even numbered card location adjacent to the odd numbered slot where the HC MIM has been inserted must be empty, as shown in Table A-5. The HC MIM is connected to the network through the odd numbered card slot connector.

Table A-5. HC MIM Card Locations

Location of the HC MIM	Empty Card Location	Location of the HC MIM	Empty Card Location
Slot 01	Slot 02	Slot 11	Slot 12
Slot 03	Slot 04	Slot 13	Slot 14
Slot 05	Slot 06	Slot 15	Slot 16
Slot 07	Slot 08	Slot 17	Slot 18

`:type` – The type of card being added to the database. For this procedure, the value of this parameter is `lime1` (E1 card) or `limch` (channel card).

NOTE: The HC MIM cannot be provisioned as a channel card.

`:app1` – The application software or GPL that is assigned to the card. For this procedure, the value of this parameter is either `ccs7itu` or `ss7ansi`.

`:force` – Allow the LIM to be added to the database even if there are not enough cards running the SCCP GPL (TSM) or running the VSCCP GPL (DSM) in the EAGLE 5 SAS to support the number of LIMs in the EAGLE 5 SAS. This parameter is obsolete and is no longer used.

The shelf to which the card is to be added, must already be in the database. This can be verified with the `rtrv-shlf` command. If the shelf is not in the database, see the “Adding a Shelf” procedure in the *Database Administration Manual - System Management*.

If an HC MIM is being provisioned in this procedure, the FAN feature must be turned on. If the FAN feature is not turned on, the HC MIM will be auto-inhibited when the HC MIM is inserted into the shelf. The status of the FAN feature is shown in the `rtrv-feat` command output.

If an HC MIM is being provisioned in this procedure, HIPR cards must be installed into card locations 9 and 10 in the shelf that the HC MIM will occupy. If HIPR cards are not installed in the shelf that the HC MIM will occupy, the HC MIM will be auto-inhibited when the HC MIM is inserted into the shelf. Enter the `rept-stat-gpl:gpl=hipr` command to verify whether or not HIPR cards are installed in the same shelf as the HC MIM being provisioned in this procedure.

The examples in this procedure are used to add the LIM-E1 cards in card locations 1201, 1202, 1203, 1204, 1211, and 1212 to the database.

Procedure

1. Display the cards in the EAGLE 5 SAS using the `rtrv-card` command. This is an example of the possible output.

```
rlghncxa03w 05-09-28 09:12:36 GMT EAGLE5 34.0.0
CARD  TYPE      APPL      LSET NAME  LINK SLC  LSET NAME  LINK SLC
1101   TSM          SCCP
1102   TSM          GLS
1113   GSPM         EOAM
1114   TDM-A
1115   GSPM         EOAM
1116   TDM-B
1117   MDAL
1305   LIMOCU       CCS7ITU   sp6        A    0    sp7        B    0
1306   LIMOCU       CCS7ITU   nsp3       A    0    nsp4       B    0
1307   LIMOCU       CCS7ITU   nsp1       A    0
1308   LIMOCU       CCS7ITU   nsp1       A    1
1316   ACMENET      STPLAN
1314   LIMOCU       CCS7ITU   sp7        A    1    sp5        B    0
1317   TSM          SCCP
```

The cards should be distributed throughout the EAGLE 5 SAS for proper power distribution. Refer to the *Installation Manual - EAGLE 5 SAS* for the shelf power distribution.

2. Verify that the correct hardware has been installed on the EAGLE 5 SAS to support the LIM-E1 card as shown in the *Installation Manual - EAGLE 5 SAS*.
-

3. Physically verify that the E1 card has been installed into the card location that will be specified in step 8. If the E1 card is an HC MIM, make sure the HC MIM is installed according to the card location requirements shown in Table A-5 on page A-14. If a card is installed and provisioned in the even numbered card location adjacent to the desired odd numbered card, either choose another card location to install and provision the HC MIM, or remove the card in the even-numbered card location by performing the appropriate procedure shown in Table A-6.

NOTE: Channel cards must be installed in the same shelf as the E1 card that is servicing the timeslots on those channel cards.

Table A-6. Card Removal Procedures

Card Application	Procedure
SS7ANSI, ATMANSI, CCS7ITU, ATMITU	"Removing an SS7 LIM" in Chapter 4, "System Configuration Procedures" in the <i>Database Administration Manual - System Management</i> . "Removing a LIM-E1 Card" on page A-24 "Removing a LIM-T1 Card" on page B-20
SS7GX25	"Removing an X.25 LIM" in Chapter 2, "X.25 Gateway Configuration," in the <i>Database Administration Manual - Features</i>
SCCP	"Removing an SCCP Card" in Chapter 2, "Global Title Translation (GTT) Configuration," in the <i>Database Administration Manual - Global Title Translation</i> "Removing an SCCP Card" in the <i>LNP Feature Activation Guide</i>
VSCCP	
GLS	"Removing a GLS Card" in Chapter 2, "Gateway Screening (GWS) Overview," in the <i>Database Administration Manual - Gateway Screening</i>
STPLAN, VXWSLAN	"Removing an STP LAN Card" in Chapter 3, "STP LAN Configuration," in the <i>Database Administration Manual - Features</i>
EBDADCM	"Removing the DCM Applied to LSMS BLM-Based Operations" in the <i>LNP Feature Activation Guide</i>
EBDABLM	"Removing the BLM Applied to LSMS BLM-Based Operations" in the <i>LNP Feature Activation Guide</i>
IPLIM, IPLIMI, SS7IPGW, IPGWI	"Removing an IP Card" in Chapter 3, "IP ⁷ Secure Gateway Configuration Procedures," in the <i>Database Administration Manual - IP⁷ Secure Gateway</i>
EROUTE	"Removing an STC Card" in Chapter 6, "Eagle Support for Integrated Sentinel Configuration," in the <i>Database Administration Manual - Features</i>
MCP	"Removing an MCPM" in Chapter 4, "System Configuration Procedures" in the <i>Database Administration Manual - System Management</i> .
IPS	"Removing an IPSM" in Chapter 4, "System Configuration Procedures" in the <i>Database Administration Manual - System Management</i> .

NOTE: If the LIM-E1 card being added in this procedure is not an HC MIM, skip steps 4 through 7 and go to step 8.

4. Verify whether or not that the Fan feature is on, by entering the `rtrv-feat` command. If the global title translation feature is on, the entry `FAN = on` appears in the `rtrv-feat` command output.

NOTE: The `rtrv-feat` command output contains other fields that are not used by this procedure. If you wish to see all the fields displayed by the `rtrv-feat` command, see the `rtrv-feat` command description in the *Commands Manual*.

If the Fan feature is on, skip step 5, and go to step 6.

5. Turn the Fan feature on by entering this command.

```
chg-feat:fan=on
```

NOTE: Once the Fan feature is turned on with the `chg-feat` command, it cannot be turned off.

The Fan feature must be purchased before you turn this feature on with the `chg-feat` command. If you are not sure if you have purchased the Fan feature, contact your Tekelec Sales Representative or Account Representative.

When the `chg-feat` has successfully completed, this message appears.

```
rlghncxa03w 05-09-28 11:43:04 GMT EAGLE5 34.0.0  
CHG-FEAT: MASP A - COMPLTD
```

6. The shelf containing the HC MIM being added in this procedure must have fans installed. Verify whether or not fans are installed on the shelf.

If the fans are installed, go to step 7.

If the fans are not installed on the shelf containing the HC MIM, go to the *Installation Manual - EAGLE 5 SAS* and install the fans. Once the fans have been installed and tested, go to step 7. The fans must be working properly before an HC MIM can be placed in the EAGLE 5 SAS.

7. Verify that HIPR cards are installed in card locations 9 and 10 in the shelf containing the HC MIM being added in this procedure. Enter this command.

```
rept-stat-gpl:gpl=hipr
```

This is an example of the possible output.

```
rlghncxa03w 05-09-01 11:40:26 GMT EAGLE5 34.0.0
GPL          CARD          RUNNING          APPROVED          TRIAL
HIPR         1109          125-002-000          125-002-000          125-003-000
HIPR         1110          125-002-000          125-002-000          125-003-000
HIPR         1209          125-002-000          125-002-000          125-003-000
HIPR         1210          125-002-000          125-002-000          125-003-000
HIPR         1309          125-002-000          125-002-000          125-003-000
HIPR         1310          125-002-000          125-002-000          125-003-000
HIPR         2109          125-002-000          125-002-000          125-003-000
HIPR         2110          125-002-000          125-002-000          125-003-000
Command Completed
```

If HIPR cards are installed in the shelf containing the HC MIM, go to step 8.

If HIPR cards are not installed on the shelf containing the HC MIM, go to the *Installation Manual - EAGLE 5 SAS* and install the HIPR cards. Once the HIPR cards have been installed, go to step 8.

8. Add the card using the **ent-card** command. If the LIM-E1 card is an HC MIM, the HC MIM can be only in a odd-numbered card location, and cannot be provisioned as a channel card.

For this example, enter these commands.

```
ent-card:loc=1201:type=lime1:appl=ccs7itu
ent-card:loc=1202:type=limch:appl=ccs7itu
ent-card:loc=1203:type=lime1:appl=ccs7itu
ent-card:loc=1204:type=limch:appl=ccs7itu
ent-card:loc=1211:type=lime1:appl=ccs7itu
ent-card:loc=1212:type=limch:appl=ccs7itu
```

When each of these commands have successfully completed, this message should appear.

```
rlghncxa03w 05-09-12 09:12:36 GMT EAGLE5 34.0.0
ENT-CARD: MASP A - COMPLTD
```

9. Verify the changes using the **rtrv-card** command with the card location specified in step 8. For this example, enter these commands.

rtrv-card:loc=1201

This is an example of the possible output.

```
rlghncxa03w 05-09-28 09:12:36 GMT EAGLE5 34.0.0
CARD  TYPE      APPL      LSET NAME  LINK SLC LSET NAME  LINK SLC
1201  LIME1      CCS7ITU
```

rtrv-card:loc=1202

This is an example of the possible output.

```
rlghncxa03w 05-09-28 09:12:36 GMT EAGLE5 34.0.0
CARD  TYPE      APPL      LSET NAME  LINK SLC LSET NAME  LINK SLC
1202  LIMCH      CCS7ITU
```

rtrv-card:loc=1203

This is an example of the possible output.

```
rlghncxa03w 05-09-28 09:12:36 GMT EAGLE5 34.0.0
CARD  TYPE      APPL      LSET NAME  LINK SLC LSET NAME  LINK SLC
1203  LIME1      CCS7ITU
```

rtrv-card:loc=1204

This is an example of the possible output.

```
rlghncxa03w 05-09-28 09:12:36 GMT EAGLE5 34.0.0
CARD  TYPE      APPL      LSET NAME  LINK SLC LSET NAME  LINK SLC
1204  LIMCH      CCS7ITU
```

rtrv-card:loc=1211

This is an example of the possible output.

```
rlghncxa03w 05-09-28 09:12:36 GMT EAGLE5 34.0.0
CARD  TYPE      APPL      LSET NAME  LINK SLC LSET NAME  LINK SLC
1211  LIME1      CCS7ITU
```

rtrv-card:loc=1212

This is an example of the possible output.

```
rlghncxa03w 05-09-28 09:12:36 GMT EAGLE5 34.0.0
CARD  TYPE      APPL      LSET NAME  LINK SLC LSET NAME  LINK SLC
1212  LIMCH      CCS7ITU
```

10. Backup the new changes using the **chg-db:action=backup:dest=fixed** command. These messages should appear, the active Maintenance and Administration Subsystem Processor (MASP) appears first.

```
BACKUP (FIXED) : MASP A - Backup starts on active MASP.
BACKUP (FIXED) : MASP A - Backup on active MASP to fixed disk complete.
BACKUP (FIXED) : MASP A - Backup starts on standby MASP.
BACKUP (FIXED) : MASP A - Backup on standby MASP to fixed disk complete.
```

Flowchart A-1. Adding a LIM-E1 Card (Sheet 2 of 4)

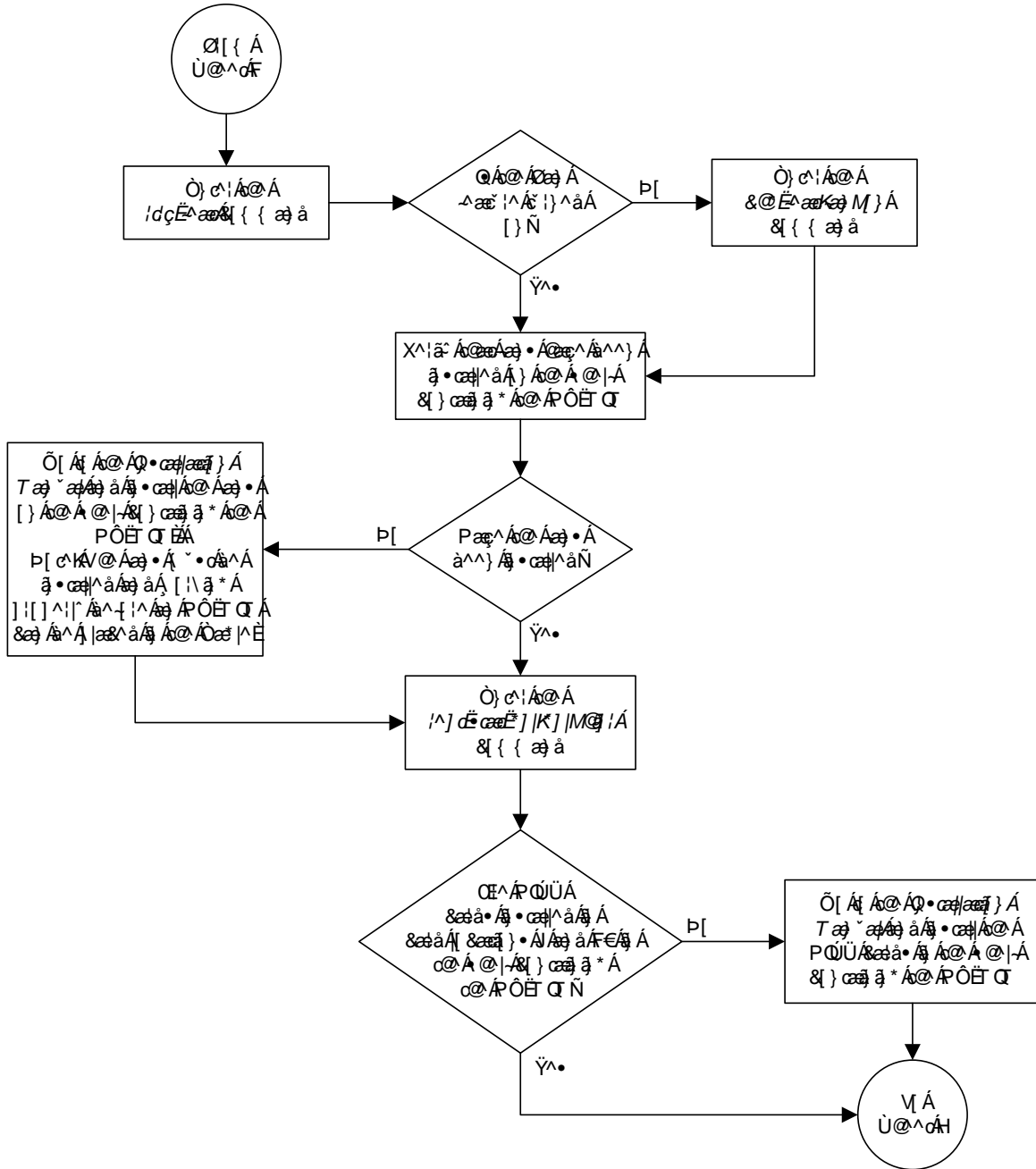

Flowchart A-1. Adding a LIM-E1 Card (Sheet 4 of 4)

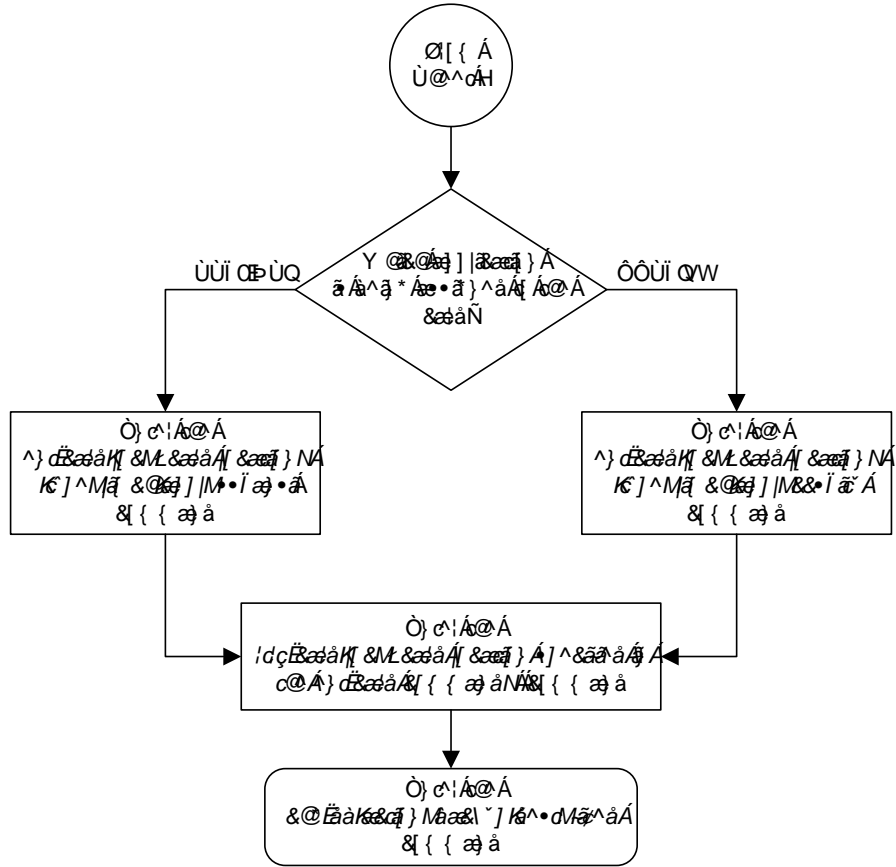

Removing a LIM-E1 Card

This procedure is used to remove either an E1 card or a channel card from the database using the `dlc-card` command. The card being removed must exist in the database.

If an E1 card is being removed, then no E1 interfaces can be assigned to the card. This can be verified with the `rtrv-e1` command. Go to the "Removing the E1 Interface Parameters" procedure on page A-59 to remove the E1 interfaces assigned to the E1 card being removed from the database.

If only a channel card is being removed from the database, then no SS7 signaling links can be assigned to the card. This can be verified with the `rtrv-slk` command. Go to the "Removing an SS7 Signaling Link" procedure on page 3-145 to remove the signaling links assigned to the channel card being removed from the database.



CAUTION: If the E1 card or channel card is the last SS7 LIM in service, removing this card from the database will cause SS7 traffic to be lost and isolate the EAGLE 5 SAS from the network.

The examples in this procedure are used to remove the E1 cards in card locations 1202 and 1203.

Procedure

1. Display the cards in the database using the `rtrv-card` command. This is an example of the possible output.

```
r1ghncxa03w 05-09-28 09:12:36 GMT EAGLE5 34.0.0
CARD  TYPE      APPL      LSET NAME  LINK SLC  LSET NAME  LINK SLC
1101  TSM          SCCP
1102  TSM          GLS
1113  GSPM         EOAM
1114  TDM-A
1115  GSPM         EOAM
1116  TDM-B
1117  MDAL
1201  LIME1        CCS7ITU  lsne12     A      0
1202  LIMCH        CCS7ITU  lsne12     A      1
1203  LIME1        CCS7ITU  lsne13
1204  LIMCH        CCS7ITU  lsne13
1211  LIME1        CCS7ITU  lsne145    A      0
1212  LIMCH        CCS7ITU  lsne145    A      1  lsne145    A2     2
1305  LIMOCU       CCS7ITU  sp6         A      0  sp7         B      0
1306  LIMOCU       CCS7ITU  nsp3        A      0  nsp4        B      0
1307  LIMOCU       CCS7ITU  nsp1        A      0
1308  LIMOCU       CCS7ITU  nsp1        A      1
1316  ACMENET     STPLAN
1314  LIMOCU       CCS7ITU  sp7         A      1  sp5         B      0
1317  TSM          SCCP
```

NOTE: If an E1 card is being removed from the database, skip this step and go to step 3.

2. Display the signaling links on the channel card you wish to remove by entering the `rtrv-slk` command, specifying the card location shown in the `rtrv-card` command output. For this example, enter this command.

`rtrv-slk:loc=1202`

This is an example of the possible output.

```
rlghncxa03w 05-09-19 21:17:04 GMT EAGLE5 34.0.0
                                L2T                                PCR PCR  E1  E1
LOC LINK LSN          SLC TYPE      SET  BPS    ECM  N1  N2   LOC PORT TS
1202 A  lsne12        1  LIMCH      1   64000 BASIC ---  ---- 1201 2   1
```

Go to the “Removing an SS7 Signaling Link” procedure on page 3-145 to remove the signaling links assigned to the channel card.

NOTE: If only a channel card is being removed from the database, skip this step and go to step 4.

3. Display the E1 interfaces assigned to the E1 card being removed from the database using the `rtrv-e1` command with no parameters. This is an example of the possible output.

```
rlghncxa03w 05-09-19 21:17:04 GMT EAGLE5 34.0.0
                                E1                                LINK  MINSU
LOC  PORT  CRC4  CAS  ENCODE  E1TSEL  SI  SN  CHANBRDG  CLASS  RATE
1201 2    ON   OFF  HDB3    LINE    0  0  -----  CHAN  ----
1203 1    OFF  ON   HDB3    EXTERNAL 3  6  -----  CHAN  ----
```

Go to the “Removing the E1 Interface Parameters” procedure on page A-59 to remove the E1 interfaces assigned to the E1 card.

4. Remove the card using the `dlt-card` command. The `dlt-card` command has only one parameter, `loc`, which is the location of the card. For this example, enter these commands.

`dlt-card:loc=1201`

`dlt-card:loc=1203`

When these commands have successfully completed, this message should appear.

```
rlghncxa03w 05-09-12 09:12:36 GMT EAGLE5 34.0.0
DLT-CARD: MASP A - COMPLTD
```

5. Verify the changes using the **rtrv-card** command specifying the card that was removed in step 4. For this example, enter these commands.

```
rtrv-card:loc=1201
```

```
rtrv-card:loc=1202
```

When these commands have successfully completed, this message should appear.

```
E2144 Cmd Rej: Location invalid for hardware configuration
```

6. Back up the new changes using the **chg-db:action=backup:dest=fixed** command. These messages should appear, the active Maintenance and Administration Subsystem Processor (MASP) appears first.

```
BACKUP (FIXED) : MASP A - Backup starts on active MASP.
```

```
BACKUP (FIXED) : MASP A - Backup on active MASP to fixed disk complete.
```

```
BACKUP (FIXED) : MASP A - Backup starts on standby MASP.
```

```
BACKUP (FIXED) : MASP A - Backup on standby MASP to fixed disk complete.
```

Flowchart A-2. Removing a LIM-E1 Card

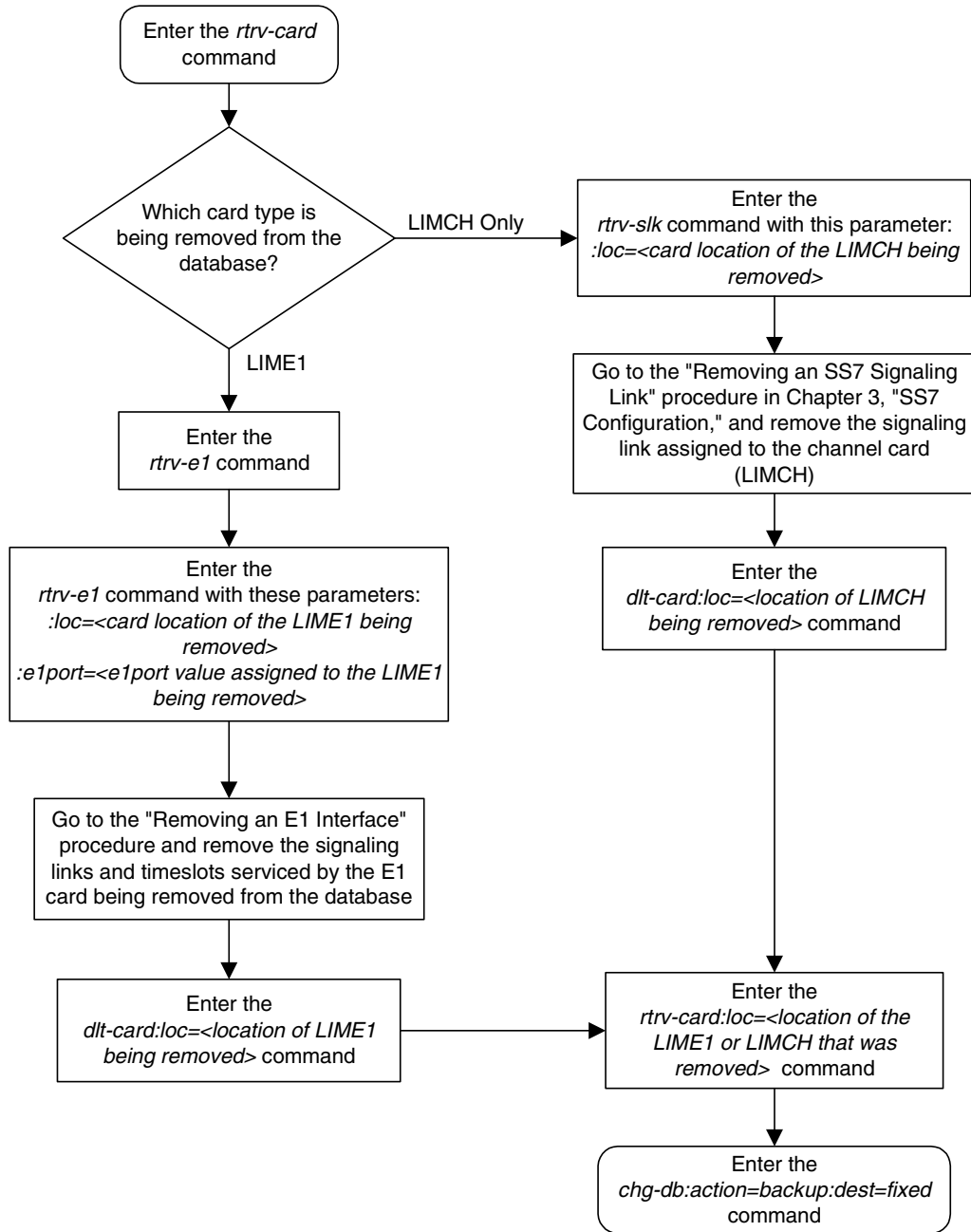

Adding Channelized and non-Channel Bridged E1 Ports

The channelized and non-channel bridged E1 ports are provisioned in the database using the **ent-e1** command using these parameters.

:loc – The location of the E1 card (card type **1ime1**) that is servicing the E1 signaling link. The location of a channel card (card type **1imch**) cannot be specified for this parameter.

:e1port – The E1 port on the E1 card used to service the E1 signaling link. The **e1port** value cannot already be assigned to the E1 card specified by the **loc** parameter.

:crc4 – Specifies whether or not CRC4 is enabled on the E1 signaling link. The default value is **on (crc4=on)**.

:cas – Specifies whether CAS or CCS is used on the E1 signaling link. CAS is enabled with the **cas=on** parameter. CCS is enabled with the **cas=off** parameter. The default value is CCS enabled (**cas=off**). The **cas=on** parameter cannot be specified for an HC MIM.

:encode – Specifies the type of encoding or decoding that is used on the E1 signaling link, either HDB3 or AMI. The default value is HDB3 encoding (**encode=hdb3**). AMI encoding can be specified only for an E1/T1 MIM or for an HC MIM.

:eltse1 – The timing source for the E1 signaling link, master (**external**), slave (**line**), or **recovered**. The default value is slave timing (**eltse1=line**).

The **recovered** timing source can be used only with the **chanbrdg=on** parameter and cannot be used in this procedure.

NOTE: To use an external high-speed master clock source other than RS-422, TDMs 870-0774-15 or later must be installed in card locations 1114 and 1116, and the TDM Global Timing Interface options must be configured. For more information, see the “Configuring the Options for the TDM Global Timing Interface” procedure on page 3-263.

:si – Specifies the value of the two spare international bits of NFAS data, from 0 to 3. The default value is 0 (**si=0**).

:sn – Specifies the value of the five spare national bits of NFAS data, from 0 to 31. The default value is 0 (**sn=0**).

The **ent-e1** command contains other parameters that are not used in this procedure. These parameters and their usage are described in these sections:

- **eltse1=recovered, chanbrdg,** and **force=yes** – “Adding Channel Bridged E1 Ports” procedure on page A-37.
- **linkclass** and **minsurate** – “Adding Unchannelized E1 Ports” procedure on page A-45.

The E1 card specified in this procedure must be in the database. This can be verified with the **rtrv-card** command.

E1 Interface

If the **cas=on** parameter is specified with the **ent-e1** command, timeslot 16 cannot be used when the E1 signaling link is provisioned with the **ent-s1k** command in the “Adding an E1 Signaling Link” procedure on page A-77.

The E1 card cannot contain channelized and unchannelized E1 ports.

Procedure

1. Display the existing E1 interfaces in the database using the **rtrv-e1** command with no parameters. This is an example of the possible output.

```
rlghncxa03w 05-09-19 21:17:04 GMT EAGLE5 34.0.0
```

E1										LINK	MINSU
LOC	PORT	CRC4	CAS	ENCODE	E1TSEL	SI	SN	CHANBRDG	CLASS	RATE	
1201	1	ON	OFF	HDB3	EXTERNAL	2	6	-----	CHAN	----	
1201	2	ON	OFF	HDB3	EXTERNAL	3	5	-----	CHAN	----	
1202	1	ON	OFF	HDB3	EXTERNAL	1	10	-----	CHAN	----	
1203	1	ON	OFF	HDB3	EXTERNAL	1	11	-----	CHAN	----	
1203	2	ON	OFF	HDB3	EXTERNAL	3	7	-----	CHAN	----	
1204	1	ON	OFF	HDB3	EXTERNAL	3	8	-----	CHAN	----	
1211	2	ON	OFF	HDB3	EXTERNAL	0	0	-----	CHAN	----	
1212	1	ON	OFF	HDB3	EXTERNAL	1	1	-----	CHAN	----	
1213	1	ON	OFF	HDB3	EXTERNAL	2	2	-----	CHAN	----	
1213	5	ON	OFF	HDB3	EXTERNAL	3	3	-----	CHAN	----	

If the E1 card that the E1 port is being assigned to in this procedure is not shown in the **rtrv-e1** output, or if the E1 card has unchannelized E1 ports assigned to it, go to step 2 to verify if there are any E1 cards in the database that have no E1 ports assigned to them.

If the **rtrv-e1** output shows that the E1 card has channel bridged E1 ports assigned to it, or that E1 ports 3, 4, 5, 6, 7, or 8 are assigned to the E1 card, the E1 card is an HC MIM. Go to step 3 and add the E1 port with the parameters allowed for an HC MIM.

If the **rtrv-e1** output shows that the E1 card does not have channel bridged E1 ports assigned to it, or that E1 ports 3, 4, 5, 6, 7, or 8 are not assigned to the E1 card, verify the type of E1 card that the E1 port will be assigned to. The E1 card types and their part numbers are shown in Table A-4 on page A-14. If the E1 card is an HC MIM, go to step 3 and add the E1 port with the parameters allowed for an HC MIM. If the E1 card is either a LIM-E1 card or an E1/T1 MIM, go to step 3 and add the E1 port with the parameters allowed for either a LIM-E1 card or an E1/T1 MIM.

If the E1 card you wish to use in this procedure has all the E1 ports that are allowed to be assigned to it, select another E1 card to add the E1 port to, or go to step 2 to verify if there are any E1 cards in the database that have no E1 ports assigned to them. Table A-7 shown the number of E1 ports that are allowed for the different E1 card types.

Table A-7. Maximum Number of E1 Ports

E1 Card Types	Maximum Number of E1 Ports
LIM-E1	2
E1/T1 MIM	2
HC MIM	8

2. Display the cards in the EAGLE 5 SAS using the `rtrv-card` command. This is an example of the possible output.

```

rlghncxa03w 05-09-28 09:12:36 GMT EAGLE5 34.0.0
CARD  TYPE      APPL      LSET NAME  LINK SLC LSET NAME  LINK SLC
1101  TSM          SCCP
1102  TSM          GLS
1113  GSPM        EOAM
1114  TDM-A
1115  GSPM        EOAM
1116  TDM-B
1117  MDAL
1201  LIME1       CCS7ITU  lsn1      A    13  lsn1      B    12
1202  LIMCH       CCS7ITU  lsn1      A    0   lsn1      B    8
1203  LIME1       CCS7ITU  lsn1      A1   4   lsn1      B1   9
1204  LIMCH       CCS7ITU  lsn1      A2   5   lsn1      A3   6
1211  LIME1       CCS7ITU  lsn1      A    14
1212  LIMCH       CCS7ITU  lsn1      A    10  lsn1      B    11
1213  LIME1       CCS7ITU  lsn1      A4   1   lsn1      A5   7
      lsn1      B5   2   lsn1      A6   3
1305  LIMOCU      CCS7ITU  sp6       A    0   sp7       B    0
1306  LIMOCU      CCS7ITU  nsp3      A    0   nsp4      B    0
1307  LIMOCU      CCS7ITU  nsp1      A    0
1308  LIMOCU      CCS7ITU  nsp1      A    1
1316  ACMENET     STPLAN
1314  LIMOCU      CCS7ITU  sp7       A    1   sp5       B    0
1317  TSM          SCCP

```

If the desired E1 card is not shown in the `rtrv-card` output, perform the Table on page A-14 and add the desired E1 card. If you wish to assign E1 ports 3, 4, 5, 6, 7, or 8 to the E1 card, the E1 card being added must be an HC MIM. If the new E1 card is an HC MIM, go to step 3 and add the E1 port with the parameters allowed for an HC MIM. If the new E1 card is either a LIM-E1 card or an E1/T1 MIM, go to step 3 and add the E1 port with the parameters allowed for either a LIM-E1 card or an E1/T1 MIM.

If the desired E1 card is shown in the `rtrv-card` output, verify the type of E1 card that the E1 port will be assigned to. The E1 card types and their part numbers are shown in Table A-4 on page A-14. If the E1 card is an HC MIM, go to step 3 and add the E1 port with the parameters allowed for an HC MIM. If the E1 card is either a LIM-E1 card or an E1/T1 MIM, go to step 3 and add the E1 port with the parameters allowed for either a LIM-E1 card or an E1/T1 MIM.

E1 Interface

3. Add the new E1 interface information to the database using the `ent-e1` command and the parameter combinations shown in Table A-8, based on the type of E1 card being used.

Table A-8. E1 Interface Parameter Combinations

LIM-E1 Card	E1/T1 MIM	HC MIM without Channel Bridging
Mandatory Parameters		
:loc=location of the E1 card	:loc=location of the E1 card	:loc=location of the E1 card
:e1port=1, 2	:e1port=1, 2	:e1port=1, 2, 3, 4, 5, 6, 7, 8
Optional Parameters		
:cas=on, off Default value = off	:cas=on, off Default value = off	:cas=off Default value = off
:crc4=on, off Default value = on	:crc4=on, off Default value = on	:crc4=on, off Default value = on
:encode=hdb3 Default value = hdb3	:encode=ami, hdb3 Default value = hdb3	:encode=ami, hdb3 Default value = hdb3
:si=0 - 3 Default value = 0	:si=0 - 3 Default value = 0	:si=0 - 3 Default value = 0
:sn=0 - 31 Default value = 0	:sn=0 - 31 Default value = 0	:sn=0 - 31 Default value = 0
:e1tsel=line, external Default value = line	:e1tsel=line, external Default value = line	:e1tsel=line, external Default value = line
Notes: 1. Channel cards cannot be specified with the <code>ent-e1</code> command. 2. To configure the E1 port for master timing, use the <code>e1tsel=external</code> parameter. 3. The <code>linkclass=chan</code> parameter configures a channelized E1 port. Specifying the <code>linkclass=chan</code> parameter in this procedure is unnecessary as this is the default value for the <code>linkclass</code> parameter.		

For this example, enter these commands.

```
ent-e1:loc=1203:e1port=2:encode=hdb3:e1tsel=line:si=1:sn=7
```

```
ent-e1:loc=1211:e1port=2:crc4=on:encode=hdb3:e1tsel=line
```

When each of these commands have successfully completed, this message should appear.

```
rlghncxa03w 05-09-12 09:12:36 GMT EAGLE5 34.0.0
ENT-E1: MASP A - COMPLTD
```

4. Verify the changes using the **rtrv-e1** command specifying the card location and the **e1port** value specified in step 3. For this example, enter these commands.

```
rtrv-e1:loc=1203:e1port=2
```

This is an example of the possible output.

```
rlghncxa03w 05-09-28 09:12:36 GMT EAGLE5 34.0.0
```

E1									LINK	MINSU
LOC	PORT	CRC4	CAS	ENCODE	E1TSEL	SI	SN	CHANBRDG	CLASS	RATE
1203	2	OFF	OFF	HDB3	LINE	1	7	-----	CHAN	----
TS0	(N/A)	TS8	-----	TS16	-----	TS24	-----			
TS1	-----	TS9	-----	TS17	-----	TS25	-----			
TS2	-----	TS10	-----	TS18	-----	TS26	-----			
TS3	-----	TS11	-----	TS19	-----	TS27	-----			
TS4	-----	TS12	-----	TS20	-----	TS28	-----			
TS5	-----	TS13	-----	TS21	-----	TS29	-----			
TS6	-----	TS14	-----	TS22	-----	TS30	-----			
TS7	-----	TS15	-----	TS23	-----	TS31	-----			

```
rtrv-e1:loc=1211:e1port=2
```

This is an example of the possible output.

```
rlghncxa03w 05-09-28 09:12:36 GMT EAGLE5 34.0.0
```

E1									LINK	MINSU
LOC	PORT	CRC4	CAS	ENCODE	E1TSEL	SI	SN	CHANBRDG	CLASS	RATE
1211	2	ON	OFF	HDB3	LINE	0	0	-----	CHAN	----
TS0	(N/A)	TS8	-----	TS16	-----	TS24	-----			
TS1	-----	TS9	-----	TS17	-----	TS25	-----			
TS2	-----	TS10	-----	TS18	-----	TS26	-----			
TS3	-----	TS11	-----	TS19	-----	TS27	-----			
TS4	-----	TS12	-----	TS20	-----	TS28	-----			
TS5	-----	TS13	-----	TS21	-----	TS29	-----			
TS6	-----	TS14	-----	TS22	-----	TS30	-----			
TS7	-----	TS15	-----	TS23	-----	TS31	-----			

5. Backup the new changes using the **chg-db:action=backup:dest=fixed** command. These messages should appear, the active Maintenance and Administration Subsystem Processor (MASP) appears first.

```
BACKUP (FIXED) : MASP A - Backup starts on active MASP.
BACKUP (FIXED) : MASP A - Backup on active MASP to fixed disk complete.
BACKUP (FIXED) : MASP A - Backup starts on standby MASP.
BACKUP (FIXED) : MASP A - Backup on standby MASP to fixed disk complete.
```

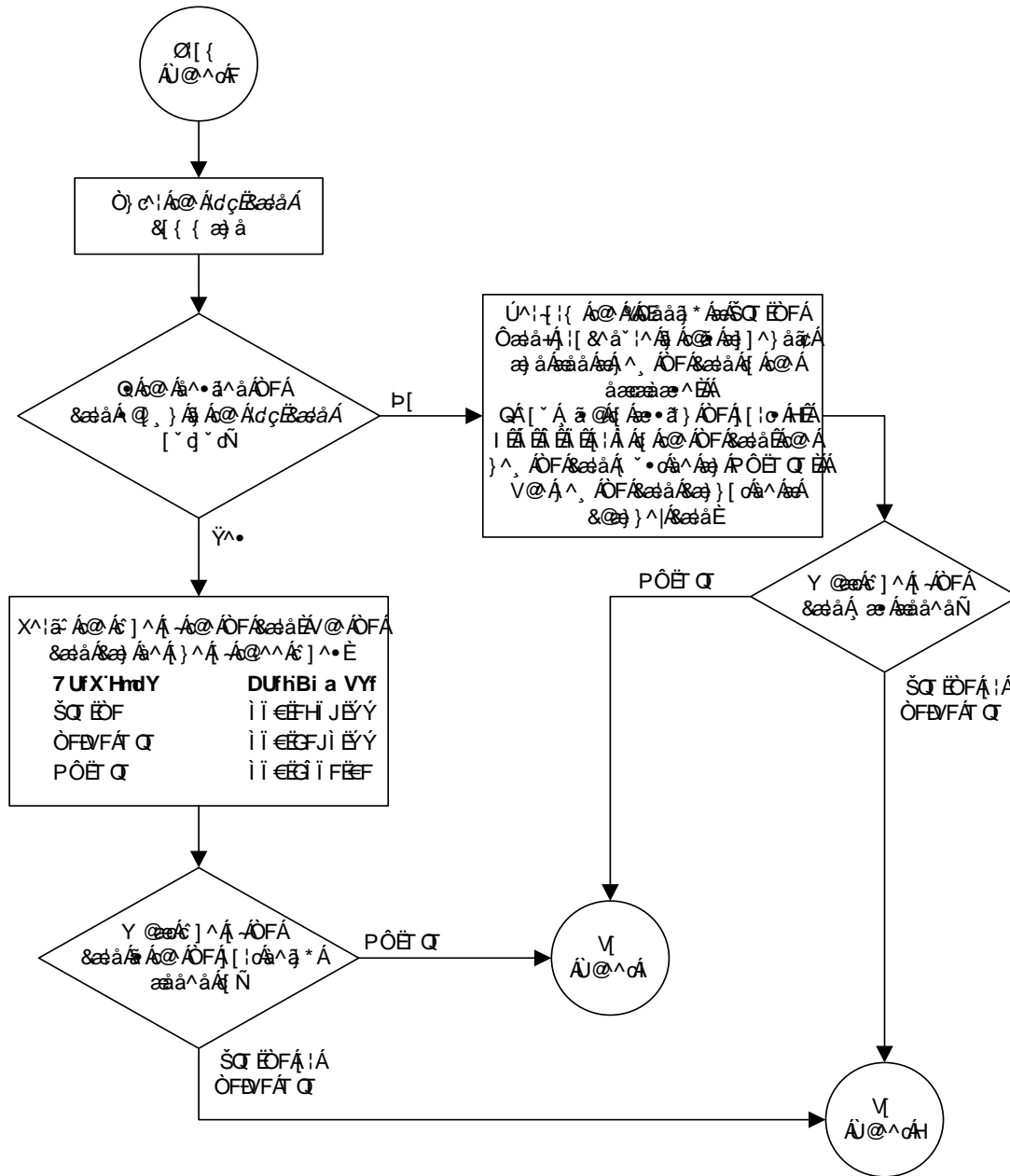

Flowchart A-3. Adding Channelized and non-Channel Bridged E1 Ports
(Sheet 2 of 4)

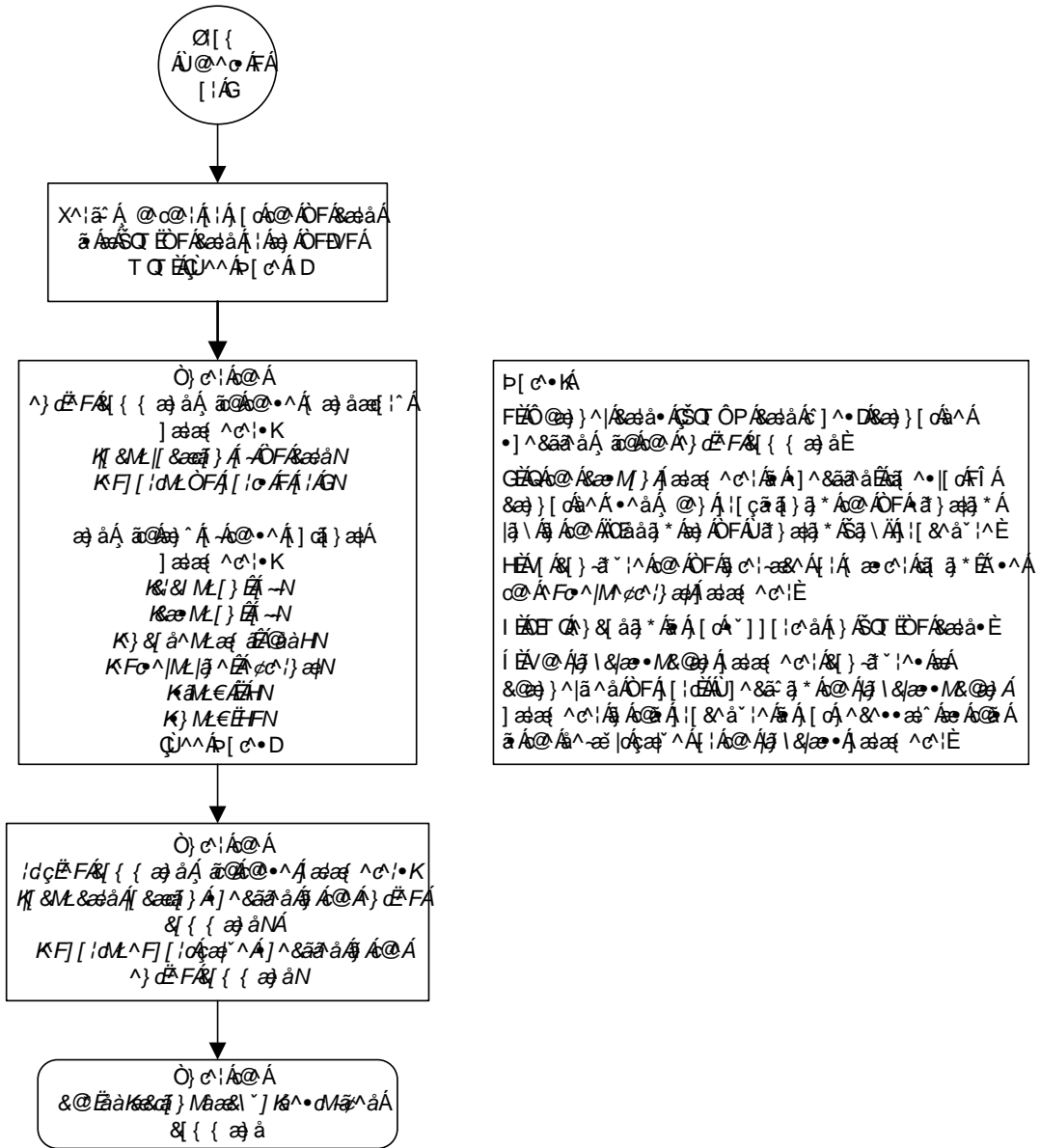

Flowchart A-3. Adding Channelized and non-Channel Bridged E1 Ports
(Sheet 3 of 4)

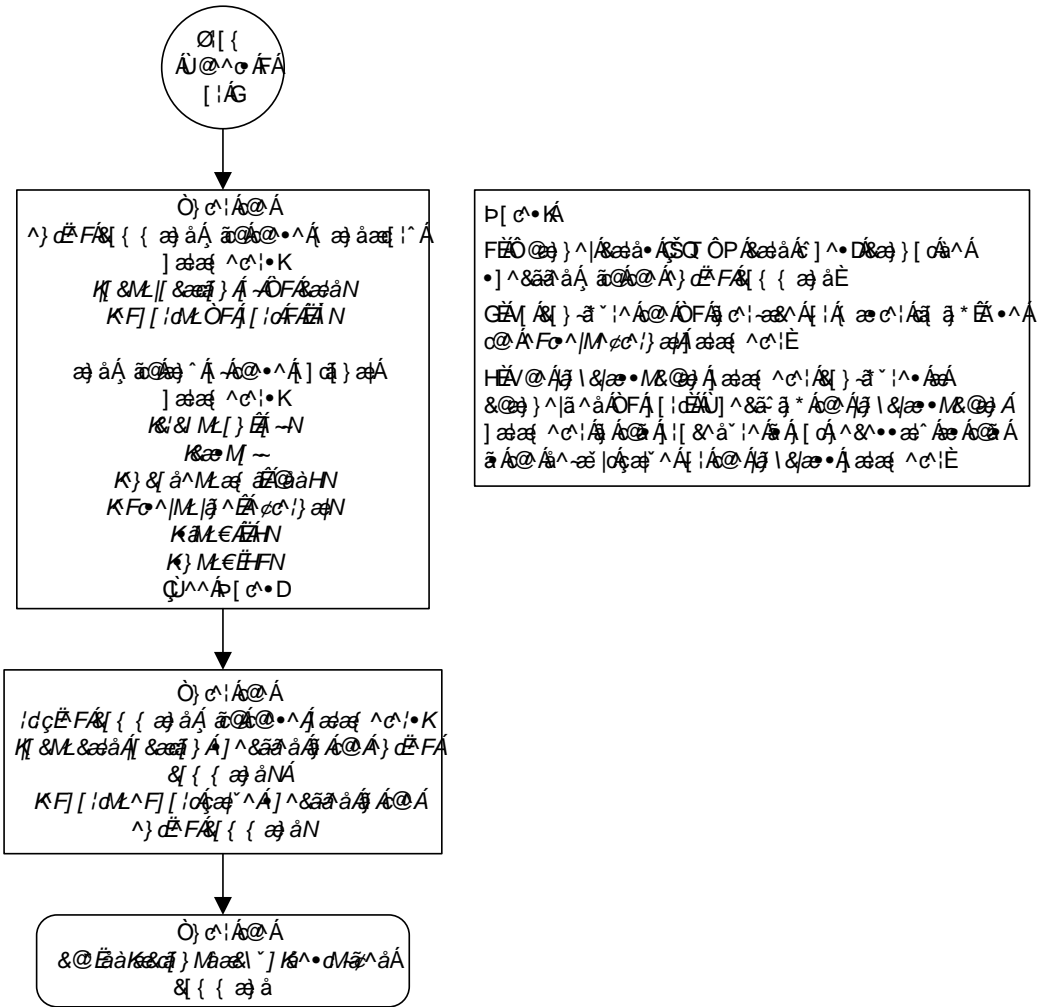

Flowchart A-3. Adding Channelized and non-Channel Bridged E1 Ports
(Sheet 4 of 4)



Adding Channel Bridged E1 Ports

The channel bridged E1 ports are provisioned in the database using the `ent-e1` command using these parameters.

:loc – The location of the E1 card (card type `line1`) that is servicing the E1 signaling link. The E1 card must be an HC MIM. The location of a channel card (card type `lmch`) cannot be specified for this parameter.

:e1port – The E1 port on the E1 card used to service the E1 signaling link. The `e1port` value cannot already be assigned to the E1 card specified by the `loc` parameter.

:crc4 – Specifies whether or not CRC4 is enabled on the E1 signaling link. The default value is `on (crc4=on)`.

:cas – Specifies whether CAS or CCS is used on the E1 signaling link. CAS is enabled with the `cas=on` parameter. CCS is enabled with the `cas=off` parameter. The default value is CCS enabled (`cas=off`). The `cas=on` parameter cannot be specified for an HC MIM.

:encode – Specifies the type of encoding or decoding that is used on the E1 signaling link, either HDB3 or AMI. The default value is HDB3 encoding (`encode=hdb3`).

:e1tsel – The timing source for the E1 signaling link, master (`external`) or `recovered`. The default value is slave timing (`e1tsel=line`) which cannot be used for a channel bridged E1 port.

The `recovered` timing source can be used only with the `chanbrdg=on` parameter and uses the even numbered member of the bridged-pair as a clock source, ensuring that port in the pair can recover the timing from its partner.

NOTE: To use an external high-speed master clock source other than RS-422, TDMs 870-0774-15 or later must be installed in card locations 1114 and 1116, and the TDM Global Timing Interface options must be configured. For more information, see the “Configuring the Options for the TDM Global Timing Interface” procedure on page 3-263.

:si – Specifies the value of the two spare international bits of NFAS data, from 0 to 3. The default value is 0 (`si=0`).

:sn – Specifies the value of the five spare national bits of NFAS data, from 0 to 31. The default value is 0 (`sn=0`).

:chanbrdg – Specifies whether or not the odd numbered E1 port specified in this procedure is channel bridged to its adjacent even numbered E1 port. Table A-9 on page A-38 shows the E1 ports that can be specified with the `chanbrdg=on` parameter and the even-numbered E1 ports that are bridged to the odd numbered E1 port.

Table A-9. Channel Bridging Ports

Odd Numbered E1 Port	Even Numbered Bridged E1 Port
1	2
3	4
5	6
7	8

:force=yes – Required when the even numbered E1 port being channel bridged is provisioned in the database before this procedure is performed.

The **ent-e1** command contains the **linkclass** and **minsurate** parameters that are not used in this procedure. These parameters and their usage are described in the “Adding Unchannelized E1 Ports” procedure on page A-45.

The E1 card specified in this procedure must be in the database. This can be verified with the **rtrv-card** command.

The E1 card cannot contain channelized and un-channelized E1 ports.

Procedure

1. Display the cards in the EAGLE 5 SAS using the **rtrv-card** command. This is an example of the possible output.

```
rlghncxa03w 05-09-28 09:12:36 GMT EAGLE5 34.0.0
CARD  TYPE      APPL      LSET NAME  LINK SLC LSET NAME  LINK SLC
1101  TSM          SCCP
1102  TSM          GLS
1113  GSPM        EOAM
1114  TDM-A
1115  GSPM        EOAM
1116  TDM-B
1117  MDAL
1201  LIME1       CCS7ITU  lsn1      A    13  lsn1      B    12
1202  LIMCH       CCS7ITU  lsn1      A    0   lsn1      B    8
1203  LIME1       CCS7ITU  lsn1      A1   4   lsn1      B1   9
1204  LIMCH       CCS7ITU  lsn1      A2   5   lsn1      A3   6
1211  LIME1       CCS7ITU  lsn1      A    14
1212  LIMCH       CCS7ITU  lsn1      A    10  lsn1      B    11
1213  LIME1       CCS7ITU  lsn1      A4   1   lsn1      A5   7
      LIME1       CCS7ITU  lsn1      B5   2   lsn1      A6   3
1305  LIMOCU      CCS7ITU  sp6       A    0   sp7       B    0
1306  LIMOCU      CCS7ITU  nsp3      A    0   nsp4      B    0
1307  LIMOCU      CCS7ITU  nsp1      A    0
1308  LIMOCU      CCS7ITU  nsp1      A    1
1316  ACMENET     STPLAN
1314  LIMOCU      CCS7ITU  sp7       A    1   sp5       B    0
1317  TSM          SCCP
```

If there no LIME1 cards shown in the **rtrv-card** output, perform the “Adding a LIM-E1 Card” procedure on page A-14 and add an HC MIM to the database. Skip step 2 and go to step 3.

E1 Interface

2. Display the existing E1 interfaces in the database using the `rtrv-e1` command with no parameters. This is an example of the possible output.

```
rlghncxa03w 05-09-19 21:17:04 GMT EAGLE5 34.0.0
```

E1									LINK	MINSU
LOC	PORT	CRC4	CAS	ENCODE	E1TSEL	SI	SN	CHANBRDG	CLASS	RATE
1201	1	ON	OFF	HDB3	EXTERNAL	2	6	-----	CHAN	----
1201	2	ON	OFF	HDB3	EXTERNAL	3	5	-----	CHAN	----
1202	1	ON	OFF	HDB3	EXTERNAL	1	10	-----	CHAN	----
1203	1	ON	OFF	HDB3	EXTERNAL	1	11	-----	CHAN	----
1203	2	ON	OFF	HDB3	EXTERNAL	3	7	-----	CHAN	----
1204	1	ON	OFF	HDB3	EXTERNAL	3	8	-----	CHAN	----
1211	2	ON	OFF	HDB3	EXTERNAL	0	0	-----	CHAN	----
1212	1	ON	OFF	HDB3	EXTERNAL	1	1	-----	CHAN	----
1213	1	ON	OFF	HDB3	EXTERNAL	2	2	-----	CHAN	----
1213	5	ON	OFF	HDB3	EXTERNAL	3	3	-----	CHAN	----

Channel bridged E1 ports cannot be added to an E1 card containing unchannelized E1 ports. If the E1 card contains unchannelized E1 ports, choose another E1 card from step 1 and repeat step 2, or add a new HC MIM by performing the “Adding a LIM-E1 Card” procedure on page A-14.

If the `rtrv-e1` output shows that the E1 card has E1 ports 3, 4, 5, 6, 7, or 8 assigned to it, or that E1 ports on the E1 card are channel bridged, skip this step and go to step 3.

If the `rtrv-e1` output shows that the E1 card does not have E1 ports 3, 4, 5, 6, 7, or 8 assigned to it, or that E1 ports on the E1 card are not channel bridged, verify that the E1 card that the channel bridged E1 port will be assigned to is an HC MIM. The part number of the HC MIM is 870-2671-01. If the E1 card is not an HC MIM, add a new HC MIM by performing the “Adding a LIM-E1 Card” procedure on page A-14.

NOTE: If a new HC MIM was added in step 2, skip step 3, and go to 4.

3. Display the E1 signaling links in the EAGLE 5 SAS by entering this command.

```
rtrv-slk:class=e1
```

This is an example of the possible output.

```
rlghncxa03w 05-09-19 21:17:04 GMT EAGLE5 34.0.0
```

LOC	LINK	LSN	SLC	TYPE	L2T SET	BPS	ECM	PCR N1	PCR N2	E1 LOC	E1 PORT	TS
1201	A	lsn1	13	LIME1	1	56000	BASIC	---	-----	1201	2	25
1201	B	lsn1	12	LIME1	1	56000	BASIC	---	-----	1201	1	20
1202	A	lsn1	0	LIMCH	1	56000	BASIC	---	-----	1201	1	5
1202	B	lsn1	8	LIMCH	1	56000	BASIC	---	-----	1201	1	1
1203	A1	lsn1	4	LIME1	1	56000	BASIC	---	-----	1203	2	20
1203	B1	lsn1	9	LIME1	1	56000	BASIC	---	-----	1203	1	2
1204	A2	lsn1	5	LIMCH	1	56000	BASIC	---	-----	1203	1	21
1204	A3	lsn1	6	LIMCH	1	56000	BASIC	---	-----	1203	1	22
1211	A	lsn1	14	LIME1	1	56000	BASIC	---	-----	1211	1	7
1212	A	lsn1	10	LIMCH	1	56000	BASIC	---	-----	1211	1	28
1212	B	lsn1	11	LIMCH	1	56000	BASIC	---	-----	1211	1	25
1213	A4	lsn1	1	LIME1	1	56000	BASIC	---	-----	1213	1	17
1213	A5	lsn1	7	LIME1	1	56000	BASIC	---	-----	1213	5	23
1213	B5	lsn1	2	LIME1	1	56000	BASIC	---	-----	1213	1	24
1213	A6	lsn1	3	LIME1	1	56000	BASIC	---	-----	1213	5	19

If an even numbered E1 port is to be channel bridged, and that E1 port is assigned to signaling links, these signaling links must be removed before the E1 port can be channel bridged. Perform the "Removing an SS7 Signaling Link" procedure on page 3-145 and remove these signaling links. After the signaling links have been removed, go to step 4.

If the even numbered E1 port to be channel bridged is not assigned to signaling links, go to step 4.

E1 Interface

4. Add the new E1 interface information to the database using the `ent-e1` command and the parameter combinations shown in Table A-10.

Table A-10. Channel Bridged E1 Port Combinations

Mandatory Parameters	
:loc=location of the E1 card	:e1tsel=external, recovered
:e1port=1, 3, 5, 7	:chanbrdg=on
Optional Parameters	
:cas=off Default value = off	:si=0 - 3 Default value = 0
:crc4=on, off Default value = on	:sn=0 - 31 Default value = 0
:encode=ami, hdb3 Default value = hdb3	:force=yes
Notes: 1. Channel cards cannot be specified with the <code>ent-e1</code> command. 2. To configure the E1 port for master timing, use the <code>e1tsel=external</code> parameter. 3. The <code>linkclass=chan</code> parameter configures a channelized E1 port. Specifying the <code>linkclass=chan</code> parameter in this procedure is unnecessary as this is the default value for the <code>linkclass</code> parameter. 4. The E1 card cannot contain channelized and un-channelized E1 ports. 5. The <code>force=yes</code> parameter must be used when the even numbered port being channel bridged is shown in the <code>rtrv-e1</code> output in step 2. If the even numbered port being channel bridged is not shown in the <code>rtrv-e1</code> output in step 2, the <code>force=yes</code> parameter cannot be used.	

For this example, enter these commands.

```
ent-e1:loc=1301:e1port=1:encode=hdb3:e1tsel=external:si=1:sn=7:
chanbrdg=on
```

```
ent-e1:loc=1303:e1port=1:crc4=on:encode=hdb3:e1tsel=recovered
:chanbrdg=on
```

When each of these commands have successfully completed, this message should appear.

```
rlghncxa03w 05-09-12 09:12:36 GMT EAGLE5 34.0.0
ENT-E1: MASP A - COMPLTD
```

5. Verify the changes using the **rtrv-e1** command specifying the card location and the **e1port** value specified in step 5. For this example, enter these commands.

```
rtrv-e1:loc=1301:e1port=1
```

This is an example of the possible output.

```
rlghncxa03w 05-09-28 09:12:36 GMT EAGLE5 34.0.0
```

E1									LINK	MINSU
LOC	PORT	CRC4	CAS	ENCODE	E1TSEL	SI	SN	CHANBRDG	CLASS	RATE
1301	1	OFF	OFF	HDB3	EXTERNAL	1	7	MASTER	CHAN	----
TS0	(N/A)	TS8	-----	TS16	-----	TS24	-----			
TS1	-----	TS9	-----	TS17	-----	TS25	-----			
TS2	-----	TS10	-----	TS18	-----	TS26	-----			
TS3	-----	TS11	-----	TS19	-----	TS27	-----			
TS4	-----	TS12	-----	TS20	-----	TS28	-----			
TS5	-----	TS13	-----	TS21	-----	TS29	-----			
TS6	-----	TS14	-----	TS22	-----	TS30	-----			
TS7	-----	TS15	-----	TS23	-----	TS31	-----			

```
rtrv-e1:loc=1303:e1port=1
```

This is an example of the possible output.

```
rlghncxa03w 05-09-28 09:12:36 GMT EAGLE5 34.0.0
```

E1									LINK	MINSU
LOC	PORT	CRC4	CAS	ENCODE	E1TSEL	SI	SN	CHANBRDG	CLASS	RATE
1303	1	ON	OFF	HDB3	RECOVERED	0	0	MASTER	CHAN	----
TS0	(N/A)	TS8	-----	TS16	-----	TS24	-----			
TS1	-----	TS9	-----	TS17	-----	TS25	-----			
TS2	-----	TS10	-----	TS18	-----	TS26	-----			
TS3	-----	TS11	-----	TS19	-----	TS27	-----			
TS4	-----	TS12	-----	TS20	-----	TS28	-----			
TS5	-----	TS13	-----	TS21	-----	TS29	-----			
TS6	-----	TS14	-----	TS22	-----	TS30	-----			
TS7	-----	TS15	-----	TS23	-----	TS31	-----			

6. Backup the new changes using the **chg-db:action=backup:dest=fixed** command. These messages should appear, the active Maintenance and Administration Subsystem Processor (MASP) appears first.

```
BACKUP (FIXED) : MASP A - Backup starts on active MASP.
BACKUP (FIXED) : MASP A - Backup on active MASP to fixed disk complete.
BACKUP (FIXED) : MASP A - Backup starts on standby MASP.
BACKUP (FIXED) : MASP A - Backup on standby MASP to fixed disk complete.
```

Adding Unchannelized E1 Ports

The E1 interface parameters are provisioned in the database using the `ent-e1` command using these parameters.

:loc – The location of the E1 card (card type `line1`) that is servicing the E1 signaling link. The E1 card must be an HC MIM card. The location of a channel card (card type `lmch`) cannot be specified for this parameter.

:e1port – The E1 port on the E1 card used to service the E1 signaling link. The `e1port` value cannot already be assigned to the E1 card specified by the `loc` parameter.

:crc4 – Specifies whether or not CRC4 is enabled on the E1 signaling link. The default value is `on (crc4=on)`.

:cas – Specifies whether CAS or CCS is used on the E1 signaling link. CAS is enabled with the `cas=on` parameter. CCS is enabled with the `cas=off` parameter. The default value is CCS enabled (`cas=off`). The `cas=on` parameter cannot be specified for an HC MIM.

:encode – Specifies the type of encoding or decoding that is used on the E1 signaling link, either HDB3 or AMI. The default value is HDB3 encoding (`encode=hdb3`).

:e1tse1 – The timing source for the E1 signaling link, master (`external`) or slave (`line`). The default value is slave timing (`e1tse1=line`).

NOTE: To use an external high-speed master clock source other than RS-422, TDMs 870-0774-15 or later must be installed in card locations 1114 and 1116, and the TDM Global Timing Interface options must be configured. For more information, see the “Configuring the Options for the TDM Global Timing Interface” procedure on page 3-263.

:si – Specifies the value of the two spare international bits of NFAS data, from 0 to 3. The default value is 0 (`si=0`).

:sn – Specifies the value of the five spare national bits of NFAS data, from 0 to 31. The default value is 0 (`sn=0`).

:linkclass – Indicates whether the E1 port supports channelized (`linkclass=chan`) or un-channelized (`linkclass=unchan`) E1 signaling links.

:minsurate – Specifies the minimum number of signaling units (FISUs and LSSUs) per second that are transmitted on the outbound E1 signaling link during idle periods or when there is an unused portion of the link’s bandwidth. The value of this parameter is from 500 to 2000 signaling units per second, with the default value of 1000 signaling units per second. The `minsurate` parameter can be specified only when an unchannelized E1 port (`linkclass=unchan` parameter) is being configured.

The `ent-e1` command contains the `eltsel=recovered`, `chanbrdg`, and `force=yes` parameters. These parameters are not used in this procedure. These parameters and their usage are described in the “Adding Channel Bridged E1 Ports” procedure on page A-37.

The E1 card specified in this procedure must be in the database. This can be verified with the `rtrv-card` command.

Procedure

1. Display the cards in the EAGLE 5 SAS using the `rtrv-card` command. This is an example of the possible output.

```
rlghncxa03w 05-09-28 09:12:36 GMT EAGLE5 34.0.0
CARD  TYPE      APPL      LSET NAME  LINK SLC LSET NAME  LINK SLC
1101  TSM           SCCP
1102  TSM           GLS
1113  GSPM         EOAM
1114  TDM-A
1115  GSPM         EOAM
1116  TDM-B
1117  MDAL
1201  LIME1       CCS7ITU  lsn1      A    13  lsn1      B    12
1202  LIMCH       CCS7ITU  lsn1      A    0   lsn1      B    8
1203  LIME1       CCS7ITU  lsn1      A1   4   lsn1      B1   9
1204  LIMCH       CCS7ITU  lsn1      A2   5   lsn1      A3   6
1211  LIME1       CCS7ITU  lsn1      A    14
1212  LIMCH       CCS7ITU  lsn1      A    10  lsn1      B    11
1213  LIME1       CCS7ITU  lsn1      A4   1   lsn1      A5   7
                   lsn1      B5   2   lsn1      A6   3
1305  LIMOCU      CCS7ITU  sp6       A    0   sp7       B    0
1306  LIMOCU      CCS7ITU  nsp3      A    0   nsp4      B    0
1307  LIMOCU      CCS7ITU  nsp1      A    0
1308  LIMOCU      CCS7ITU  nsp1      A    1
1316  ACMENET     STPLAN
1314  LIMOCU      CCS7ITU  sp7       A    1   sp5       B    0
1317  TSM           SCCP
```

If there no LIME1 cards shown in the `rtrv-card` output, perform the “Adding a LIM-E1 Card” procedure on page A-14 and add an HC MIM to the database. Skip step 2 and go to step 3.

2. Display the existing E1 interfaces in the database using the **rtrv-e1** command with no parameters. This is an example of the possible output.

```
rlghncxa03w 05-09-19 21:17:04 GMT EAGLE5 34.0.0
```

E1									LINK	MINSU
LOC	PORT	CRC4	CAS	ENCODE	E1TSEL	SI	SN	CHANBRDG	CLASS	RATE
1201	1	ON	OFF	HDB3	EXTERNAL	2	6	-----	CHAN	----
1201	2	ON	OFF	HDB3	EXTERNAL	3	5	-----	CHAN	----
1202	1	ON	OFF	HDB3	EXTERNAL	1	10	-----	CHAN	----
1203	1	ON	OFF	HDB3	EXTERNAL	1	11	-----	CHAN	----
1203	2	ON	OFF	HDB3	EXTERNAL	3	7	-----	CHAN	----
1204	1	ON	OFF	HDB3	EXTERNAL	3	8	-----	CHAN	----
1211	2	ON	OFF	HDB3	EXTERNAL	0	0	-----	CHAN	----
1212	1	ON	OFF	HDB3	EXTERNAL	1	1	-----	CHAN	----
1213	1	ON	OFF	HDB3	EXTERNAL	2	2	-----	CHAN	----
1213	5	ON	OFF	HDB3	EXTERNAL	3	3	-----	CHAN	----

The EAGLE 5 SAS can contain a maximum of 64 unchannelized E1 ports. If the **rtrv-e1** output shows that there are 64 unchannelized E1 ports, no other unchannelized E1 ports can be added and this procedure cannot be performed.

If no E1 ports are assigned to the E1 card you wish to use in this procedure, verify that the E1 card is an HC MIM. The part number of the HC MIM is 870-2671-01. If the E1 card is not an HC MIM, either select another E1 card from the **rtrv-e1** output, or add a new HC MIM by performing the “Adding a LIM-E1 Card” procedure on page A-14.

If the E1 card is an HC MIM, go to step 3.

If E1 ports are assigned to the E1 card you wish to use in this procedure, and the E1 ports on the E1 card are channelized, unchannelized E1 ports cannot be assigned to this E1 card. Unchannelized E1 ports cannot be assigned to an E1 card that contains channelized E1 ports. If the E1 ports on the E1 card are channelized, either select another E1 card from the **rtrv-e1** output, or add a new HC MIM by performing the “Adding a LIM-E1 Card” procedure on page A-14. If all the E1 ports shown in the **rtrv-e1** output are channelized, add a new HC MIM by performing the “Adding a LIM-E1 Card” procedure on page A-14.

If any the E1 ports shown in the **rtrv-e1** output are not channelized, either select another E1 card from the **rtrv-e1** output that contains only one unchannelized E1 port, or add a new HC MIM by performing the “Adding a LIM-E1 Card” procedure on page A-14. The E1 card can contain a maximum of two unchannelized E1 ports. If the E1 card you wish to use in this procedure contains only one unchannelized E1 port, go to step 3.

3. Display the status of the SE-HSL SLK Capacity feature by entering the **rtrv-ctrl-feat** command. The following is an example of the possible output.

```
rlghncxa03w 05-09-28 21:15:37 GMT EAGLE5 34.0.0
The following features have been permanently enabled:
```

Feature Name	Partnum	Status	Quantity
IPGWx Signaling TPS	893012814	on	20000
ISUP Normalization	893000201	on	----
Command Class Management	893005801	on	----
LNP Short Message Service	893006601	on	----
Intermed GTT Load Sharing	893006901	on	----
XGTT Table Expansion	893006101	on	400000
XMAP Table Expansion	893007701	on	3000
HC-MIM SLK Capacity	893012707	on	64

The following features have been temporarily enabled:

Feature Name	Partnum	Status	Quantity	Trial Period Left
Zero entries found.				

The following features have expired temporary keys:

Feature Name	Partnum
Zero entries found.	

If the SE-HSL SLK Capacity feature is enabled, the entry **SE-HSL SLK Capacity** is shown in the **rtrv-ctrl-feat** output with a quantity of 4, 8, 16, 24, 32, 40, 48, 56 or 64. This quantity is the number of unchannelized E1 signaling links, and the number of unchannelized E1 ports, the EAGLE 5 SAS can contain. If the addition of the unchannelized E1 port in this procedure will not exceed the enabled unchannelized E1 signaling link quantity, go to step 10. If the addition of the unchannelized E1 port in this procedure will exceed the enabled unchannelized E1 signaling link quantity, increase the enabled unchannelized E1 signaling link quantity by performing step 8.

If the SE-HSL SLK Capacity feature is not enabled, go to step 4.

NOTE: If the **rtrv-ctrl-feat** output in step 3 shows any controlled features, skip steps 4 through 7, and go to step 8. If the **rtrv-ctrl-feat** output shows only the IPGWx Signaling TPS feature with a quantity of 200 and the HC-MIM SLK Capacity feature with a quantity of 64, steps 4 through 7 must be performed.

4. Display the serial number in the database with the **rtrv-serial-num** command. This is an example of the possible output.

```
rlghncxa03w 05-09-28 21:15:37 GMT EAGLE5 34.0.0
System serial number = nt00001231
```

System serial number is not locked.

```
rlghncxa03w 05-09-28 21:15:37 GMT EAGLE5 34.0.0
Command Completed
```

NOTE: If the serial number is correct and locked, skip steps 5, 6, and 7, and go to step 8. If the serial number is correct but not locked, skip steps 5 and 6, and go to step 7. If the serial number is not correct, but is locked, the unchannelized E1 signaling link (SE-HSL SLK Capacity feature) quantity cannot be enabled and the remainder of this procedure cannot be performed. Contact the Customer Care Center to get an incorrect and locked serial number changed. Refer to "Customer Care Center" on page 1-8 for the contact information. The serial number can be found on a label affixed to the control shelf (shelf 1100).

5. Enter the correct serial number into the database using the `ent-serial-num` command with the `serial` parameter.

For this example, enter this command.

```
ent-serial-num:serial=<EAGLE 5 SAS's correct serial number>
```

When this command has successfully completed, the following message should appear.

```
rlghncxa03w 05-09-28 21:15:37 GMT EAGLE5 34.0.0
ENT-SERIAL-NUM: MASP A - COMPLTD
```

6. Verify that the serial number entered in step 5 was entered correctly using the `rtrv-serial-num` command. This is an example of the possible output.

```
rlghncxa03w 05-09-28 21:15:37 GMT EAGLE5 34.0.0
System serial number = nt00001231
```

System serial number is not locked.

```
rlghncxa03w 05-09-28 21:15:37 GMT EAGLE5 34.0.0
Command Completed
```

If the serial number was not entered correctly, repeat steps 4 and 5 and re-enter the correct serial number.

7. Lock the serial number in the database by entering the `ent-serial-num` command with the serial number shown in step 4, if the serial number shown in step 4 is correct, or with the serial number shown in step 6, if the serial number was changed in step 5, and with the `lock=yes` parameter.

For this example, enter this command.

```
ent-serial-num:serial=<EAGLE 5 SAS's serial number>:lock=yes
```

When this command has successfully completed, the following message should appear.

```
rlghncxa03w 05-09-28 21:15:37 GMT EAGLE5 34.0.0
ENT-SERIAL-NUM: MASP A - COMPLTD
```

8. Enable the SE-HSL SLK Capacity feature by entering the `enable-ctrl-feat` command specifying the part number for the desired unchannelized E1 signaling link quantity and the feature access key. The unchannelized E1 signaling link quantity part numbers are shown in Table A-11.

Table A-11. Unchannelized E1 Signaling Link Quantity Part Numbers

Unchannelized E1 Signaling Link Quantity	Part Number
4	893013001
8	893013002
16	893013003
24	893013004
32	893013005
40	893013006
48	893013007
56	893013008
64	893013009

For this example, enter this command.

```
enable-ctrl-feat:partnum=893013001:fak=<feature access key>
```

NOTE: A temporary feature access key cannot be specified to enable the unchannelized E1 signaling link quantity.

NOTE: The value for the feature access key (the `fak` parameter) is provided by Tekelec. If you do not have the feature access key for the unchannelized E1 signaling link quantity, contact your Tekelec Sales Representative or Account Representative.

When the `enable-ctrl-feat` command has successfully completed, this message should appear.

```
rlghncxa03w 05-09-28 21:15:37 GMT EAGLE5 34.0.0
ENABLE-CTRL-FEAT: MASP B - COMPLTD
```

- Verify the changes by entering the `rtrv-ctrl-feat` command with the unchannelized E1 signaling link quantity (SE-HSL SLK Capacity feature) part number specified in step 8. Enter this command.

rtrv-ctrl-feat:partnum=893013001

The following is an example of the possible output.

```
rlghncxa03w 05-09-28 21:15:37 GMT EAGLE5 34.0.0
The following features have been permanently enabled:
```

Feature Name	Partnum	Status	Quantity
SE-HSL SLK Capacity	893013001	on	4

The following features have been temporarily enabled:

Feature Name	Partnum	Status	Quantity	Trial Period Left
Zero entries found.				

The following features have expired temporary keys:

Feature Name	Partnum
Zero entries found.	

- Add the unchannelized E1 port to the database using the `ent-e1` command and the parameter combinations shown in Table A-12.

Table A-12. Unchannelized E1 Port Parameter Combinations

Mandatory Parameters	
:loc=card location of the HC MIM	:linkclass=unchan
:e1port=1, 2, 3, 4, 5, 6, 7, 8	:e1tsel=line, external
Optional Parameters	
:cas=off Default value = off	:si=0 - 3 Default value = 0
:crc4=on, off Default value = on	:sn=0 - 31 Default value = 0
:encode=ami, hdb3 Default value = hdb3	:minsurate=500 - 2000 Default value = 1000

For this example, enter these commands.

```
ent-e1:loc=1305:e1port=2:encode=hdb3:e1tsel=line:si=1:sn=7
:linkclass=unchan
```

```
ent-e1:loc=1307:e1port=2:crc4=on:encode=hdb3:e1tsel=external
:linkclass=unchan
```

When each of these commands have successfully completed, this message should appear.

```
rlghncxa03w 05-09-12 09:12:36 GMT EAGLE5 34.0.0
ENT-E1: MASP A - COMPLTD
```

11. Verify the changes using the **rtrv-e1** command specifying the card location and the **e1port** value specified in step 10. For this example, enter these commands.

```
rtrv-e1:loc=1305:e1port=2
```

This is an example of the possible output.

```
rlghncxa03w 05-09-28 09:12:36 GMT EAGLE5 34.0.0
```

E1										LINK	MINSU
LOC	PORT	CRC4	CAS	ENCODE	E1TSEL	SI	SN	CHANBRDG	CLASS	RATE	
1305	2	OFF	OFF	HDB3	LINE	1	7	-----	UNCHAN	1000	

```
rtrv-e1:loc=1307:e1port=2
```

This is an example of the possible output.

```
rlghncxa03w 05-09-28 09:12:36 GMT EAGLE5 34.0.0
```

E1										LINK	MINSU
LOC	PORT	CRC4	CAS	ENCODE	E1TSEL	SI	SN	CHANBRDG	CLASS	RATE	
1307	2	ON	OFF	HDB3	EXTERNAL	0	0	-----	UNCHAN	1000	

12. Backup the new changes using the **chg-db:action=backup:dest=fixed** command. These messages should appear, the active Maintenance and Administration Subsystem Processor (MASP) appears first.

```
BACKUP (FIXED) : MASP A - Backup starts on active MASP.
BACKUP (FIXED) : MASP A - Backup on active MASP to fixed disk complete.
BACKUP (FIXED) : MASP A - Backup starts on standby MASP.
BACKUP (FIXED) : MASP A - Backup on standby MASP to fixed disk complete.
```

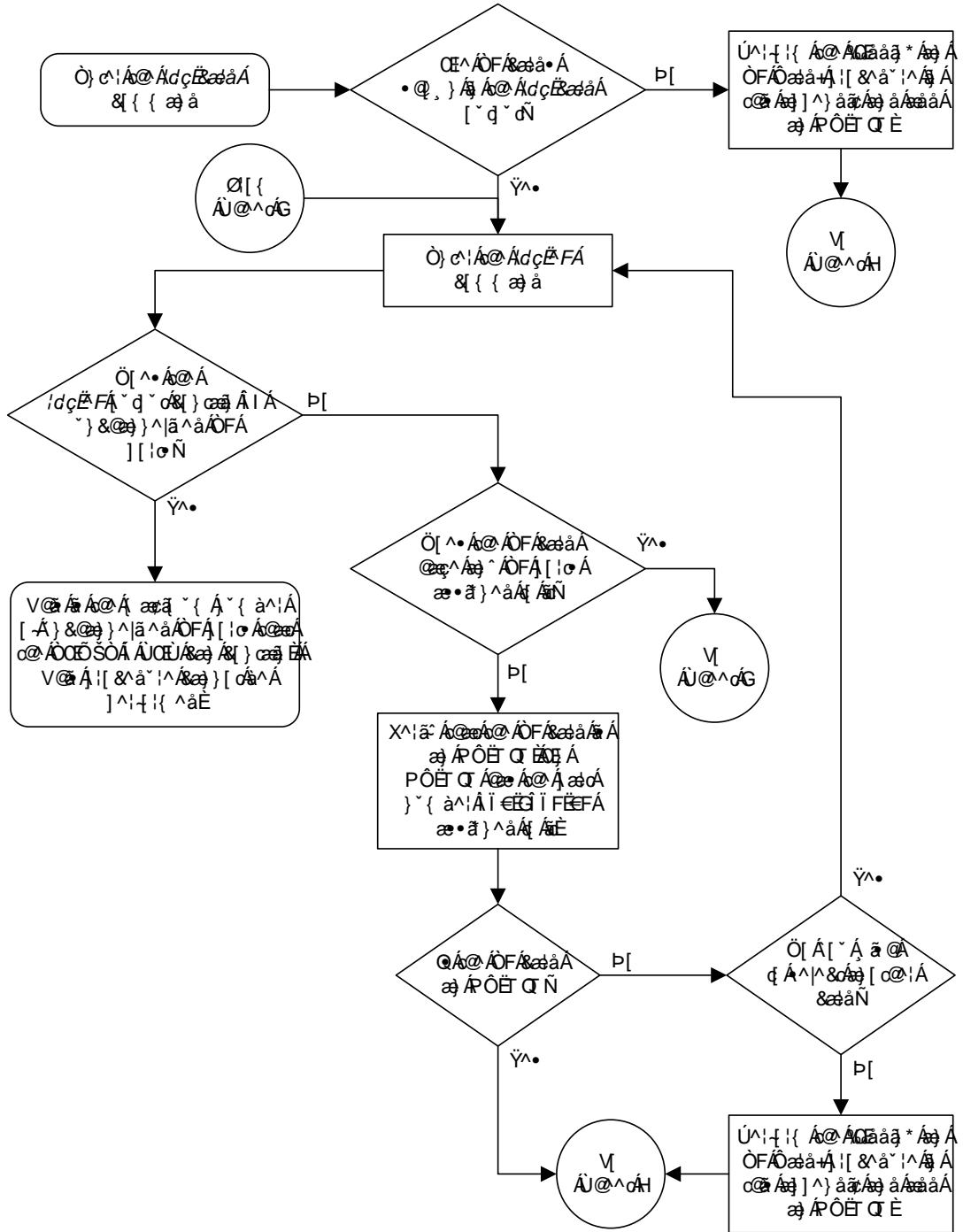

Flowchart A-3. Adding Unchanneled E1 Ports (Sheet 1 of 6)

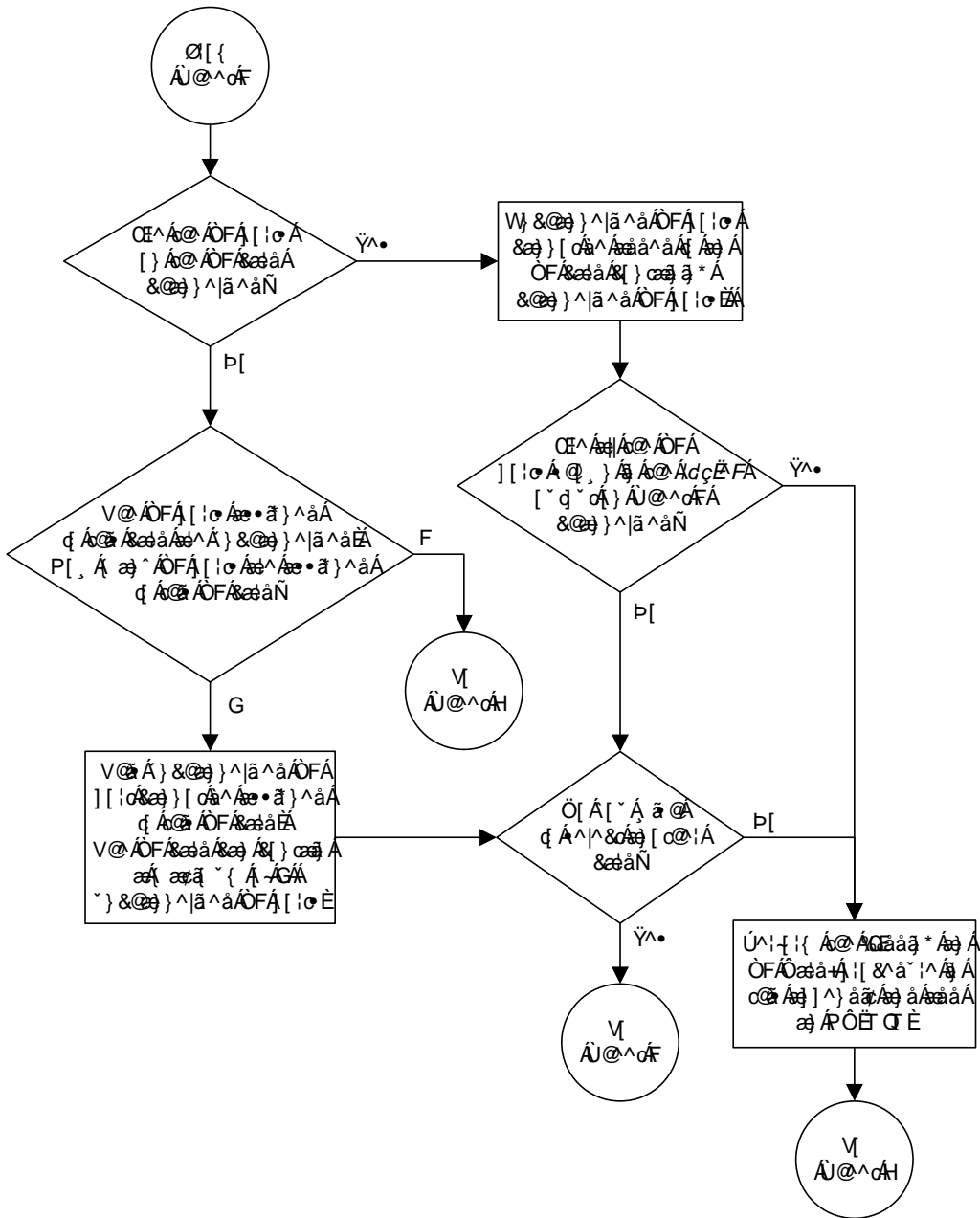

Flowchart A-3. Adding Unchannelized E1 Ports (Sheet 2 of 6)

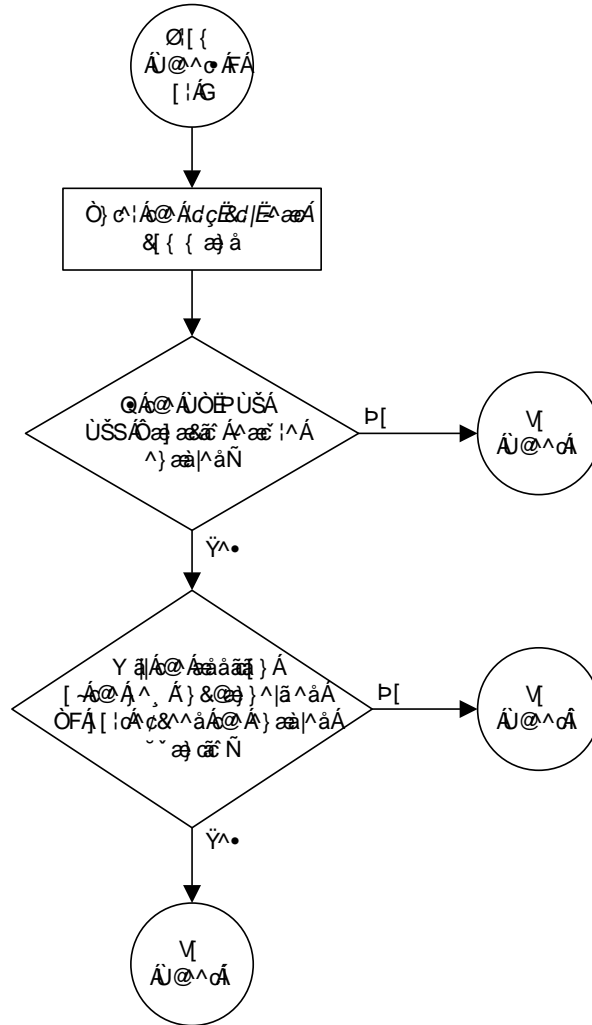

Flowchart A-3. Adding Unchannelized E1 Ports (Sheet 3 of 6)



Flowchart A-3. Adding Unchannelized E1 Ports (Sheet 5 of 6)

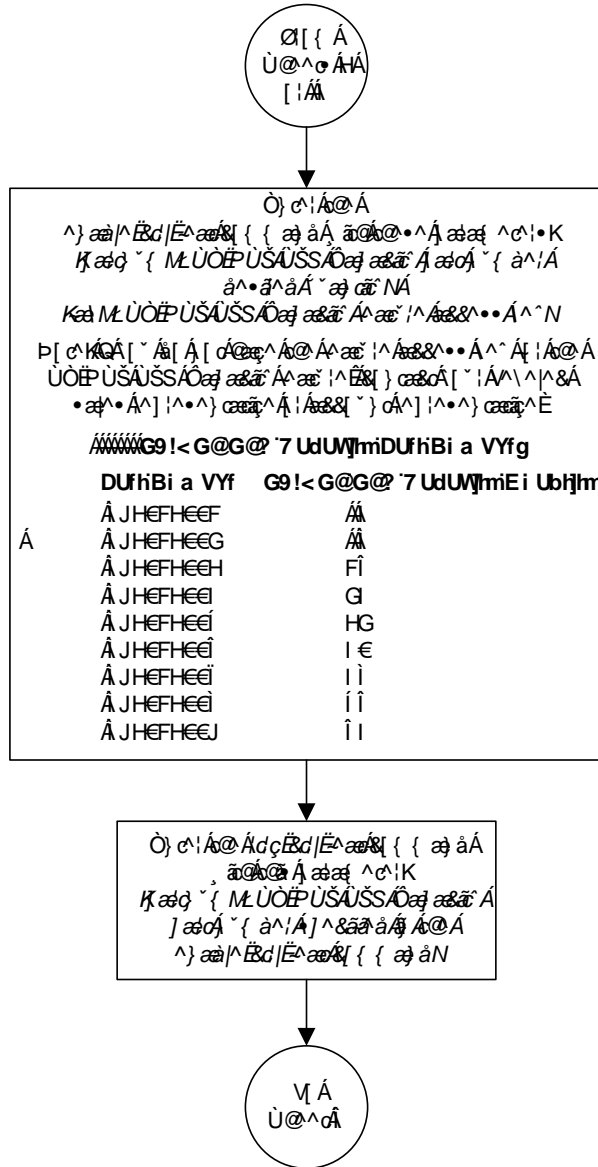

Flowchart A-3. Adding Unchannelized E1 Ports (Sheet 6 of 6)

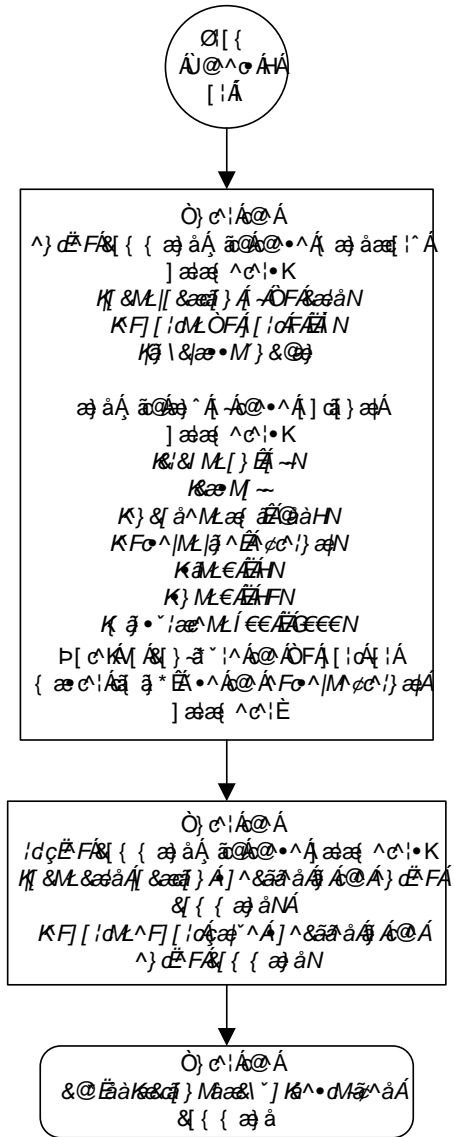

Removing the E1 Interface Parameters

This procedure is used to remove an E1 interface from the database using the `dl1t-e1` command using these parameters.

`:loc` – The location of the E1 card (card type `line1`) containing the E1 interface being removed.

`:e1port` – The E1 port on the E1 card containing the E1 interface being removed.

The E1 interface to be removed must exist in the database. This can be verified in step 1.

To remove the E1 interface information contained on an E1 card, all signaling links serviced by that E1 card must be removed from the database. This can be verified with the `rtrv-e1` command, specifying the card location and `E1PORT` on the E1 card, and the `rtrv-slk` command, specifying the location of any cards (E1 or channel cards) shown in the `rtrv-e1` output. If there are any signaling links being serviced by the E1 card, go to the “Removing an SS7 Signaling Link” procedure on page 3-145 and remove these signaling links.

Even numbered E1 ports cannot be removed if the even numbered E1 port is channel bridged. Remove the corresponding odd numbered E1 port (see Table A-5 on page A-14) to remove the even numbered channel bridged E1 port.

Procedure

1. Display the existing E1 interfaces in the database using the `rtrv-e1` command with no parameters. This is an example of the possible output.

```
rlghncxa03w 05-09-19 21:17:04 GMT EAGLE5 34.0.0
```

E1									LINK	MINSU
LOC	PORT	CRC4	CAS	ENCODE	E1TSEL	SI	SN	CHANBRDG	CLASS	RATE
1201	2	ON	OFF	HDB3	EXTERNAL	3	5	-----	CHAN	----
1203	2	OFF	OFF	HDB3	LINE	1	7	-----	CHAN	----
1211	2	ON	OFF	HDB3	LINE	0	0	-----	CHAN	----

If the E1 port being removed is an even numbered E1 port and is channel bridged, select the corresponding odd numbered E1 port to remove (see Table A-5 on page A-14) and go to step 2.

If the even numbered E1 port is not channel bridged, it can be removed with the `dl1t-e1` command. go to step 2.

2. Display the timeslots that are serviced by the E1 card containing the E1 interface information to be removed using the **rtrv-e1** command specifying the card location and the **e1port** value from step 1. For this example, enter this command.

```
rtrv-e1:loc=1201:e1port=2
```

This is an example of the possible output.

```
rlghncxa03w 05-09-28 09:12:36 GMT EAGLE5 34.0.0
```

E1										LINK	MINSU
LOC	PORT	CRC4	CAS	ENCODE	E1TSEL	SI	SN	CHANBRDG	CLASS	RATE	
1201	2	ON	OFF	HDB3	EXTERNAL	3	5	-----	CHAN	----	
TS0	(N/A)	TS8	-----	TS16	-----	TS24	-----				
TS1	1201,A	TS9	-----	TS17	-----	TS25	-----				
TS2	-----	TS10	-----	TS18	-----	TS26	-----				
TS3	-----	TS11	-----	TS19	-----	TS27	-----				
TS4	-----	TS12	-----	TS20	-----	TS28	-----				
TS5	1202,A	TS13	-----	TS21	-----	TS29	-----				
TS6	-----	TS14	-----	TS22	-----	TS30	-----				
TS7	-----	TS15	-----	TS23	-----	TS31	-----				

If this step shows any timeslots that are serviced by the E1 card, go to the “Removing an SS7 Signaling Link” procedure on page 3-145 and remove the timeslots and signaling links serviced by the E1 card.

3. Remove the E1 interface information to the database using the **dl1-e1** command specifying the card location of the E1 card and the E1PORT on that card. For this example, enter these commands.

```
dl1-e1:loc=1201:e1port=2
```

When this command has successfully completed, this message should appear.

```
rlghncxa03w 05-09-12 09:12:36 GMT EAGLE5 34.0.0
DLT-E1: MASP A - COMPLTD
```

4. Verify the changes using the **rtrv-e1** command with no parameters. This is an example of the possible output.

```
rlghncxa03w 05-09-19 21:17:04 GMT EAGLE5 34.0.0
```

E1										LINK	MINSU
LOC	PORT	CRC4	CAS	ENCODE	E1TSEL	SI	SN	CHANBRDG	CLASS	RATE	
1203	2	OFF	OFF	HDB3	LINE	1	7	-----	CHAN	----	
1211	2	ON	OFF	HDB3	LINE	0	0	-----	CHAN	----	

5. Backup the new changes using the **chg-db:action=backup:dest=fixed** command. These messages should appear, the active Maintenance and Administration Subsystem Processor (MASP) appears first.

```
BACKUP (FIXED) : MASP A - Backup starts on active MASP.
BACKUP (FIXED) : MASP A - Backup on active MASP to fixed disk complete.
BACKUP (FIXED) : MASP A - Backup starts on standby MASP.
BACKUP (FIXED) : MASP A - Backup on standby MASP to fixed disk complete.
```

Changing the Attributes of an E1 Port

This procedure is used to change the existing E1 interface parameters using the **chg-e1** command using these parameters.

- :loc** – The location of the E1 card (card type **lime1**) that is servicing the E1 signaling link. The location of a channel card (card type **limch**) cannot be specified for this parameter. The E1 card can be either a LIM-E1, an E1/T1 MIM, or an HC MIM.
- :elport** – The E1 port being changed in this procedure.
- :crc4** – Specifies whether or not CRC4 is enabled on the E1 signaling link.
- :cas** – Specifies whether CAS or CCS is used on the E1 signaling link. CAS is enabled with the **cas=on** parameter. CCS is enabled with the **cas=off** parameter. The **cas=on** parameter cannot be specified for an HC MIM.
- :encode** – Specifies the type of encoding or decoding that is used on the E1 signaling link, either HDB3 or AMI. AMI encoding can be specified only for an E1/T1 MIM or for an HC MIM.
- :eltsel** – The timing source for the E1 signaling link, master (**external**), slave (**line**), or **recovered**.

The **recovered** timing source can be used only with the **chanbrdg=on** parameter and uses the even numbered member of the bridged-pair as a clock source, ensuring that port in the pair can recover the timing from its partner.

NOTE: To use an external high-speed master clock source other than RS-422, TDMs 870-0774-15 or later must be installed in card locations 1114 and 1116, and the TDM Global Timing Interface options must be configured. For more information, see the “Configuring the Options for the TDM Global Timing Interface” procedure on page 3-263.

- :si** – Specifies the value of the two spare international bits of NFAS data, from 0 to 3.
- :sn** – Specifies the value of the five spare national bits of NFAS data, from 0 to 31.
- :chanbrdg** – Specifies whether or not the odd numbered E1 port specified in this procedure is channel bridged to its adjacent even numbered E1 port. Table A-13 on page A-63 shows the E1 ports that can be specified with the **chanbrdg=on** parameter and the even-numbered E1 ports that are bridged to the odd numbered E1 port.

E1 Interface

Table A-13. Channel Bridging Ports

Odd Numbered E1 Port	Even Numbered Bridged E1 Port
1	2
3	4
5	6
7	8

:force=yes – required when the even numbered E1 port being channel bridged is provisioned in the database before this procedure is performed.

:minsurate – Specifies the minimum number of signaling units (FISUs and LSSUs) per second that are transmitted on the outbound E1 signaling link during idle periods or when there is an unused portion of the link's bandwidth. The value of this parameter is from 500 to 2000 signaling units per second, with the default value of 1000 signaling units per second. The **minsurate** parameter can be specified only for an unchannelized E1 port (**linkclass=unchan** parameter).

The E1 card specified in this procedure must be in the database. This can be verified with the **rtrv-e1** command.

If either the **crc4**, **cas**, **encode**, or **e1tsel** values are being changed, all the signaling links serviced by the E1 card must be taken out of service.

If the signaling link being serviced by the E1 card is using timeslot 16, the **cas=on** parameter cannot be specified with the **chg-e1** command.

Procedure

1. Display the existing E1 interfaces in the database using the **rtrv-e1** command with no parameters. This is an example of the possible output.

```
rlghncxa03w 05-09-19 21:17:04 GMT EAGLE5 34.0.0
```

E1								LINK	MINSU	
LOC	PORT	CRC4	CAS	ENCODE	E1TSEL	SI	SN	CHANBRDG	CLASS	RATE
1201	2	ON	OFF	HDB3	EXTERNAL	3	5	-----	CHAN	----
1203	2	OFF	OFF	HDB3	LINE	1	7	-----	CHAN	----
1211	2	ON	OFF	HDB3	LINE	0	0	-----	CHAN	----

NOTE: If the `crc4`, `cas`, `encode`, or `e1tsel` parameters are being changed in this procedure, perform steps 2, 3, and 4. If these parameter values are not being changed, skip steps 2, 3, and 4 and go to step 5. If the E1 port is channel bridged and will remain channel bridged, or if the E1 port will be channel bridged in this procedure, the `e1tsel` value must be either `external` or `recovered`, and the `cas` value must be `off`.

2. Display the timeslots that are serviced by the E1 card containing the E1 interface information to be changed using the `rtrv-e1` command specifying the card location and the `e1port` value from step 1. For this example, enter this command.

```
rtrv-e1:loc=1201:e1port=2
```

This is an example of the possible output.

```
rlghncxa03w 05-09-28 09:12:36 GMT EAGLE5 34.0.0
```

E1									LINK	MINSU
LOC	PORT	CRC4	CAS	ENCODE	E1TSEL	SI	SN	CHANBRDG	CLASS	RATE
1201	2	ON	OFF	HDB3	EXTERNAL	3	5	-----	CHAN	----
TS0	(N/A)	TS8	-----	TS16	-----	TS24	-----			
TS1	1201,A	TS9	-----	TS17	-----	TS25	-----			
TS2	-----	TS10	-----	TS18	-----	TS26	-----			
TS3	-----	TS11	-----	TS19	-----	TS27	-----			
TS4	-----	TS12	-----	TS20	-----	TS28	-----			
TS5	1202,A	TS13	-----	TS21	-----	TS29	-----			
TS6	-----	TS14	-----	TS22	-----	TS30	-----			
TS7	-----	TS15	-----	TS23	-----	TS31	-----			

3. Check the status of the signaling links shown in step 2 using the `rept-stat-slk` command with the card location and signaling link. For this example, enter these commands.

```
rept-stat-slk:loc=1201:link=a
```

This is an example of the possible output.

```
rlghncxa03w 05-09-23 13:06:25 GMT EAGLE5 34.0.0
SLK   LSN      CLLI      PST      SST      AST
1201,A lsne12  ----- IS-NR      Avail    ----
ALARM STATUS      = No Alarms
UNAVAIL REASON    = --
E1 status         = 1201, RCVRY-E1F:FAC-E1 Port 2 available
```

```
rept-stat-slk:loc=1202:link=a
```

This is an example of the possible output.

```
rlghncxa03w 05-09-23 13:06:25 GMT EAGLE5 34.0.0
SLK   LSN      CLLI      PST      SST      AST
1202,A lsne12  ----- IS-NR      Avail    ----
ALARM STATUS      = No Alarms
UNAVAIL REASON    = --
E1 status         = 1201, RCVRY-E1F:FAC-E1 Port 1 available
```

NOTE: If the signaling links shown in step 3 are out of service, skip step 4 and go to step 5.

4. Deactivate the signaling links shown in step 3 using the `dact -slk` command. For this example, enter these commands.

```
dact-slk:loc=1201:link=a
```

```
dact-slk:loc=1202:link=a
```

When each of these commands have successfully completed, this message should appear.

```
rlghncxa03w 05-09-07 08:41:12 GMT EAGLE5 34.0.0  
Deactivate Link message sent to card
```

NOTE: If the `chanbrdg` value is on, E1 ports 3, 4, 5, 6, 7, or 8 are assigned to the E1 card, or if the `linkclass` parameter value for the E1 port is `unchan`, skip steps 5 and 6, and go to step 7. The `chanbrdg` parameter cannot be specified for unchannelized E1 ports (`linkclass=unchan`).

5. Only E1 ports assigned to HC MIM cards can be channel bridged. Verify that the card is an HC MIM. If the E1 card is an HC MIM, go to step 6.

If the E1 card is not an HC MIM, the E1 port cannot be channel bridged. Go back to step 1 and perform this procedure again. If there are no HC MIMs in the database, go to step 7 and change other parameters for this E1 port.

If E1 ports 3, 4, 5, 6, 7, or 8 are assigned to the E1 card, the E1 card is an HC MIM. Go to step 6.

NOTE: If the adjacent E1 port (see Table A-13 on page A-63) is not shown in the `rtrv-e1` output in step 1, or if the `chanbrdg` value is not being changed, skip this step and go to step 7.

6. Display the E1 signaling links in the database by entering this command.

```
rtrv-slk:class=e1
```

This is an example of the possible output.

```
rlghncxa03w 05-09-19 21:17:04 GMT EAGLE5 34.0.0
```

LOC	LINK	LSN	SLC	TYPE	L2T SET	BPS	ECM	PCR N1	PCR N2	E1 LOC	E1 PORT	TS
1201	A	lsn1	13	LIME1	1	56000	BASIC	---	-----	1201	2	25
1201	B	lsn1	12	LIME1	1	56000	BASIC	---	-----	1201	1	20
1202	A	lsn1	0	LIMCH	1	56000	BASIC	---	-----	1201	1	5
1202	B	lsn1	8	LIMCH	1	56000	BASIC	---	-----	1201	1	1
1203	A1	lsn1	4	LIME1	1	56000	BASIC	---	-----	1203	2	20
1203	B1	lsn1	9	LIME1	1	56000	BASIC	---	-----	1203	1	2
1204	A2	lsn1	5	LIMCH	1	56000	BASIC	---	-----	1203	1	21
1204	A3	lsn1	6	LIMCH	1	56000	BASIC	---	-----	1203	1	22
1211	A	lsn1	14	LIME1	1	56000	BASIC	---	-----	1211	1	7
1212	A	lsn1	10	LIMCH	1	56000	BASIC	---	-----	1211	1	28
1212	B	lsn1	11	LIMCH	1	56000	BASIC	---	-----	1211	1	25
1213	A4	lsn1	1	LIME1	1	56000	BASIC	---	-----	1213	1	17
1213	A5	lsn1	7	LIME1	1	56000	BASIC	---	-----	1213	5	23
1213	B5	lsn1	2	LIME1	1	56000	BASIC	---	-----	1213	1	24
1213	A6	lsn1	3	LIME1	1	56000	BASIC	---	-----	1213	5	19

If an even numbered E1 port is to be channel bridged, and that E1 port is assigned to signaling links, these signaling links must be removed before the E1 port can be channel bridged. Perform the "Removing an SS7 Signaling Link" procedure on page 3-145 and remove these signaling links. After the signaling links have been removed, go to step 7.

If the even numbered E1 port to be channel bridged is not assigned to signaling links, go to step 7.

E1 Interface

- Change the E1 interface information using the `chg-e1` command and the parameter combinations shown in Table A-14, based on the type of E1 card being used.

Table A-14. E1 Interface Parameter Combinations

LIM-E1 Card	E1/T1 MIM	HC MIM		
		Non-Channel Bridged E1 Ports (<code>linkclass</code> parameter value is <code>chan</code>)	Channel Bridged E1 Ports	Unchannelized E1 Ports (<code>linkclass</code> parameter value is <code>unchan</code>)
Mandatory Parameters				
:loc=location of the E1 card	:loc=location of the E1 card	:loc=location of the E1 card	:loc=location of the E1 card	:loc=location of the E1 card
:e1port=E1 port being changed, either 1 or 2	:e1port=E1 port being changed, either 1 or 2	:e1port=E1 port being changed, either 1, 2, 3, 4, 5, 6, 7, or 8 ¹	:e1port=E1 port being changed, either 1, 3, 5, or 7	:e1port=E1 port being changed, either 1, 2, 3, 4, 5, 6, 7, or 8
Optional Parameters				
:cas=on, off	:cas=on, off	:cas=off	:cas=off	:cas=off
:crc4=on, off	:crc4=on, off	:crc4=on, off	:crc4=on, off	:crc4=on, off
:encode=hdb3	:encode=ami, hdb3	:encode=ami, hdb3	:encode=ami, hdb3	:encode=ami, hdb3
:si=0 - 3	:si=0 - 3	:si=0 - 3	:si=0 - 3	:si=0 - 3
:sn=0 - 31	:sn=0 - 31	:sn=0 - 31	:sn=0 - 31	:sn=0 - 31
:e1tsel=line, external	:e1tsel=line, external	:e1tsel=line, external	:e1tsel=external, recovered	:e1tsel=line, external
		:chanbrdg=off	:chanbrdg=on	:minsurate=500 - 2000
			:force=yes ²	
<p>Notes:</p> <ol style="list-style-type: none"> If the current E1 port is channel bridged, the <code>e1port</code> value can either 1, 3, 5, or 7. The <code>force=yes</code> parameter must be used when the even numbered port being channel bridged is shown in the <code>rtrv-e1</code> output in step 1. If the even numbered port being channel bridged is not shown in the <code>rtrv-e1</code> output in step 1, the <code>force=yes</code> parameter cannot be used. 				

For this example, enter this command.

```
chg-e1:loc=1201:e1port=2:crc4=off:encode=hdb3:si=1:sn=9
```

NOTE: If the output of step 2 shows that timeslot 16 is being serviced by the E1 card, the `cas=on` parameter cannot be specified with the `chg-e1` command.

When this command has successfully completed, this message should appear.

```
rlghncxa03w 05-09-12 09:12:36 GMT EAGLE5 34.0.0
ENT-E1: MASP A - COMPLTD
```

- Verify the changes using the `rtrv-e1` command specifying the card location and the `e1port` value specified in step 7. For this example, enter these commands.

```
rtrv-e1:loc=1201:e1port=2
```

This is an example of the possible output.

```
rlghncxa03w 05-09-28 09:12:36 GMT EAGLE5 34.0.0
```

E1									LINK	MINSU
LOC	PORT	CRC4	CAS	ENCODE	E1TSEL	SI	SN	CHANBRDG	CLASS	RATE
1201	2	OFF	OFF	HDB3	EXTERNAL	1	9	-----	CHAN	----
TS0	(N/A)	TS8	-----	TS16	-----	TS24	-----			
TS1	1201,A	TS9	-----	TS17	-----	TS25	-----			
TS2	-----	TS10	-----	TS18	-----	TS26	-----			
TS3	-----	TS11	-----	TS19	-----	TS27	-----			
TS4	-----	TS12	-----	TS20	-----	TS28	-----			
TS5	1202,A	TS13	-----	TS21	-----	TS29	-----			
TS6	-----	TS14	-----	TS22	-----	TS30	-----			
TS7	-----	TS15	-----	TS23	-----	TS31	-----			

NOTE: If the signaling links were not deactivated in step 4, skip this step and go to step 10.

- Activate the signaling links that were deactivated in step 4 using the `act-slk` command. For this example, enter these commands.

```
act-slk:loc=1201:link=a
```

```
act-slk:loc=1202:link=a
```

When each of these commands have successfully completed, this message should appear.

```
rlghncxa03w 05-09-07 08:41:12 GMT EAGLE5 34.0.0
Activate Link message sent to card
```

- Backup the new changes using the `chg-db:action=backup:dest=fixed` command. These messages should appear, the active Maintenance and Administration Subsystem Processor (MASP) appears first.

```
BACKUP (FIXED) : MASP A - Backup starts on active MASP.
BACKUP (FIXED) : MASP A - Backup on active MASP to fixed disk complete.
BACKUP (FIXED) : MASP A - Backup starts on standby MASP.
BACKUP (FIXED) : MASP A - Backup on standby MASP to fixed disk complete.
```

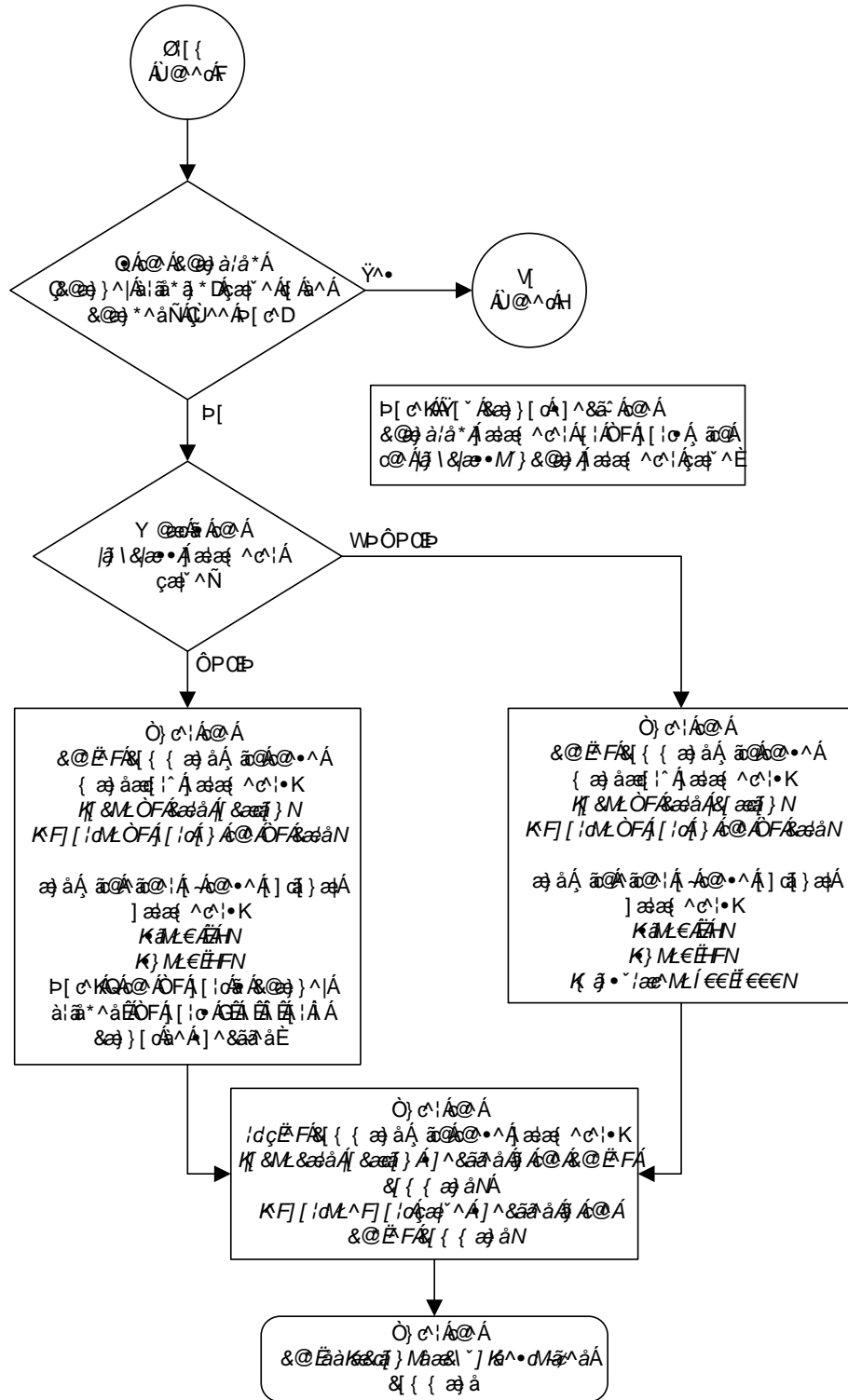

Flowchart A-5. Changing the Attributes of an E1 Port (Sheet 2 of 8)

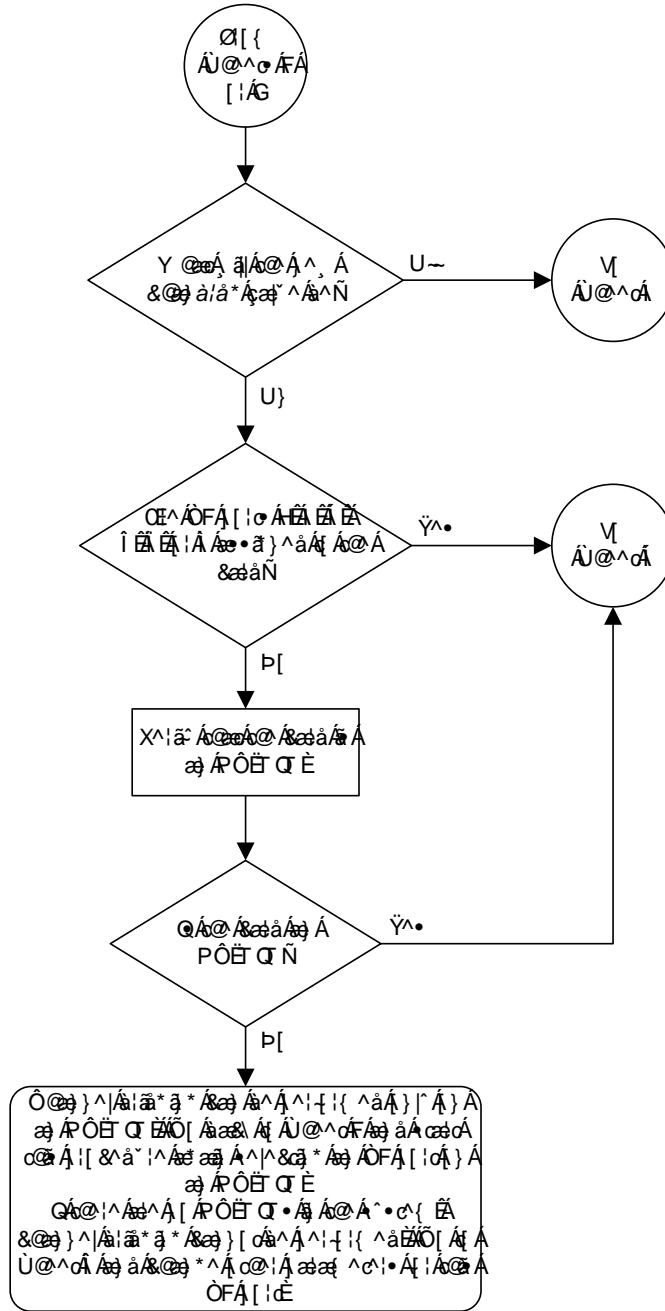

Flowchart A-5. Changing the Attributes of an E1 Port (Sheet 3 of 8)

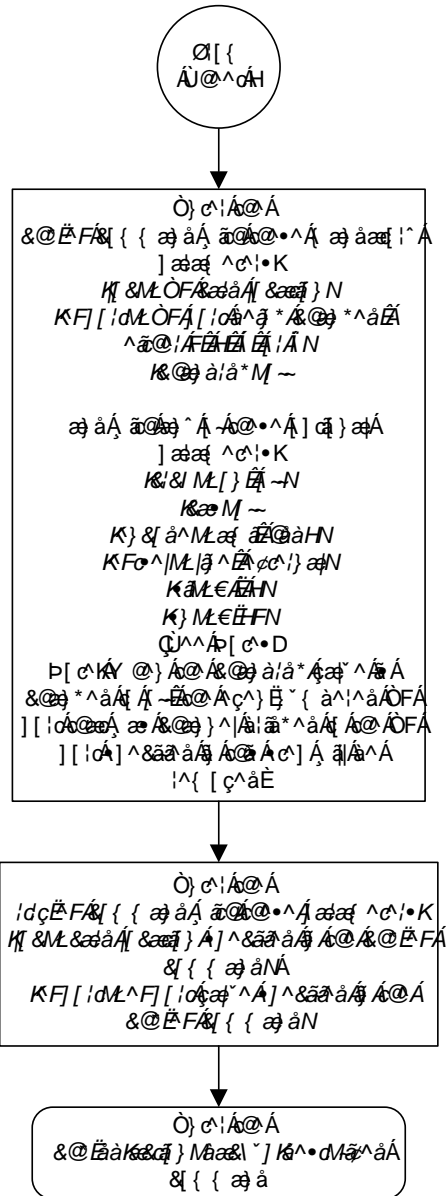

Flowchart A-5. Changing the Attributes of an E1 Port (Sheet 4 of 8)



Flowchart A-5. Changing the Attributes of an E1 Port (Sheet 5 of 8)

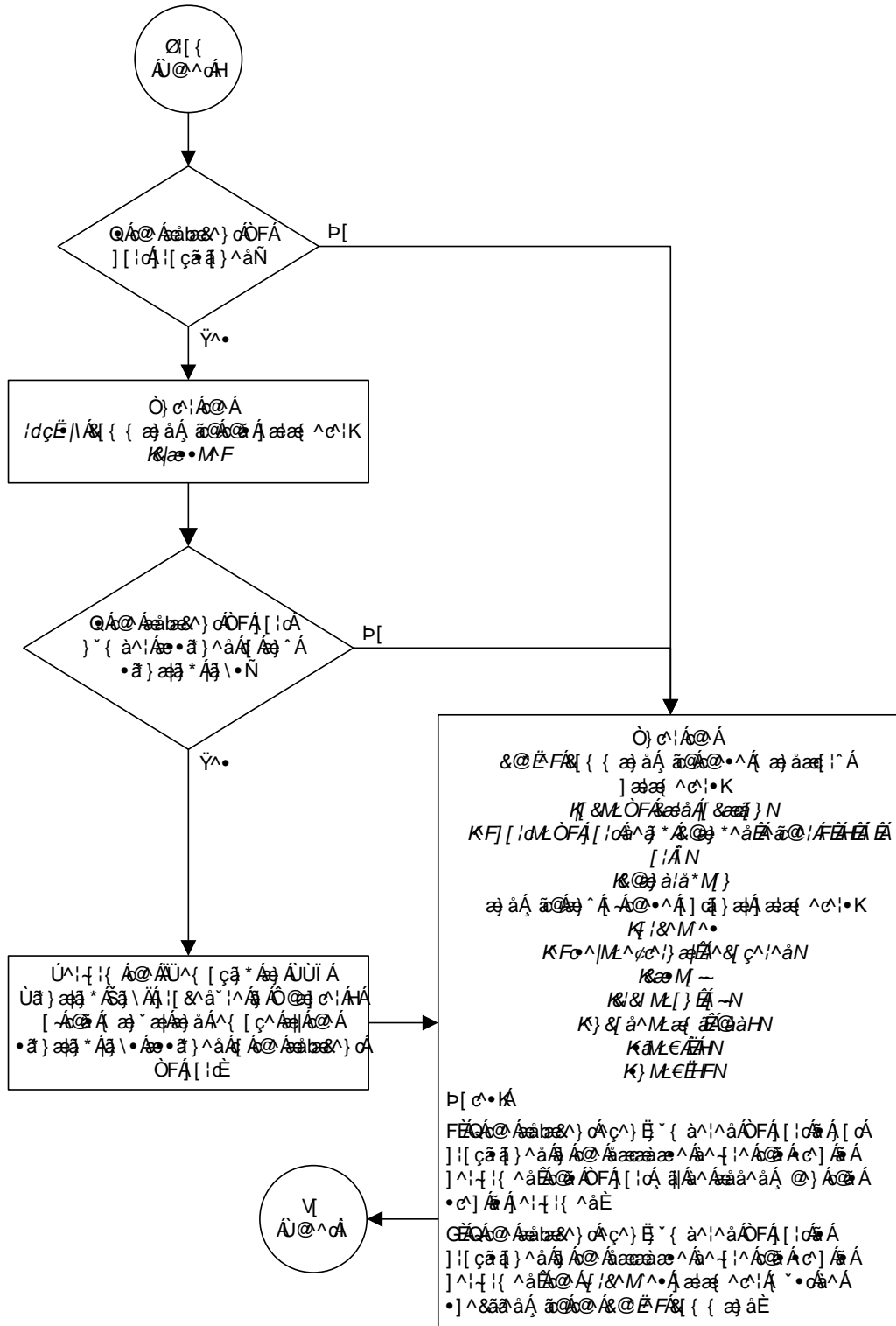

Flowchart A-5. Changing the Attributes of an E1 Port (Sheet 6 of 8)

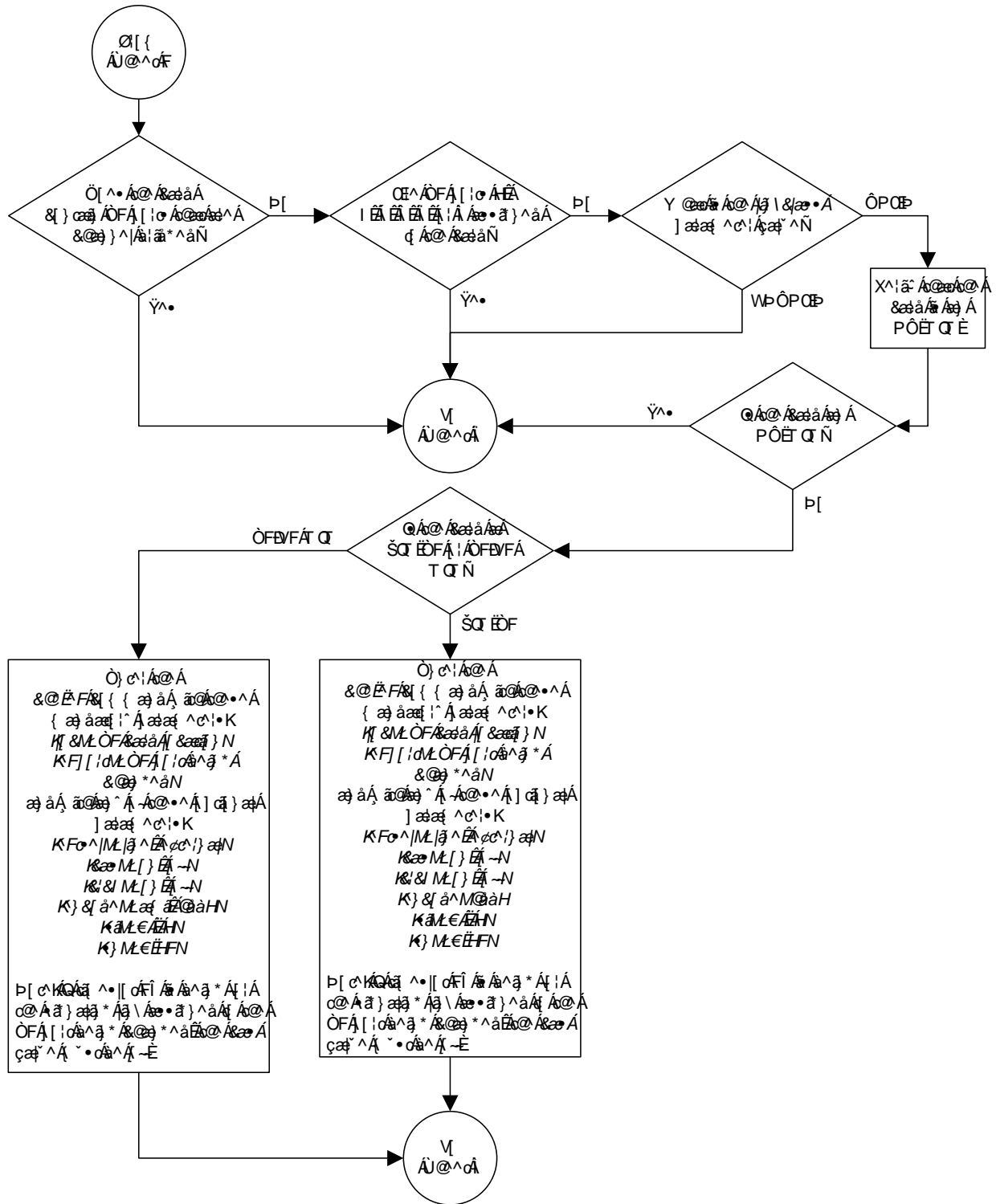

Flowchart A-5. Changing the Attributes of an E1 Port (Sheet 7 of 8)

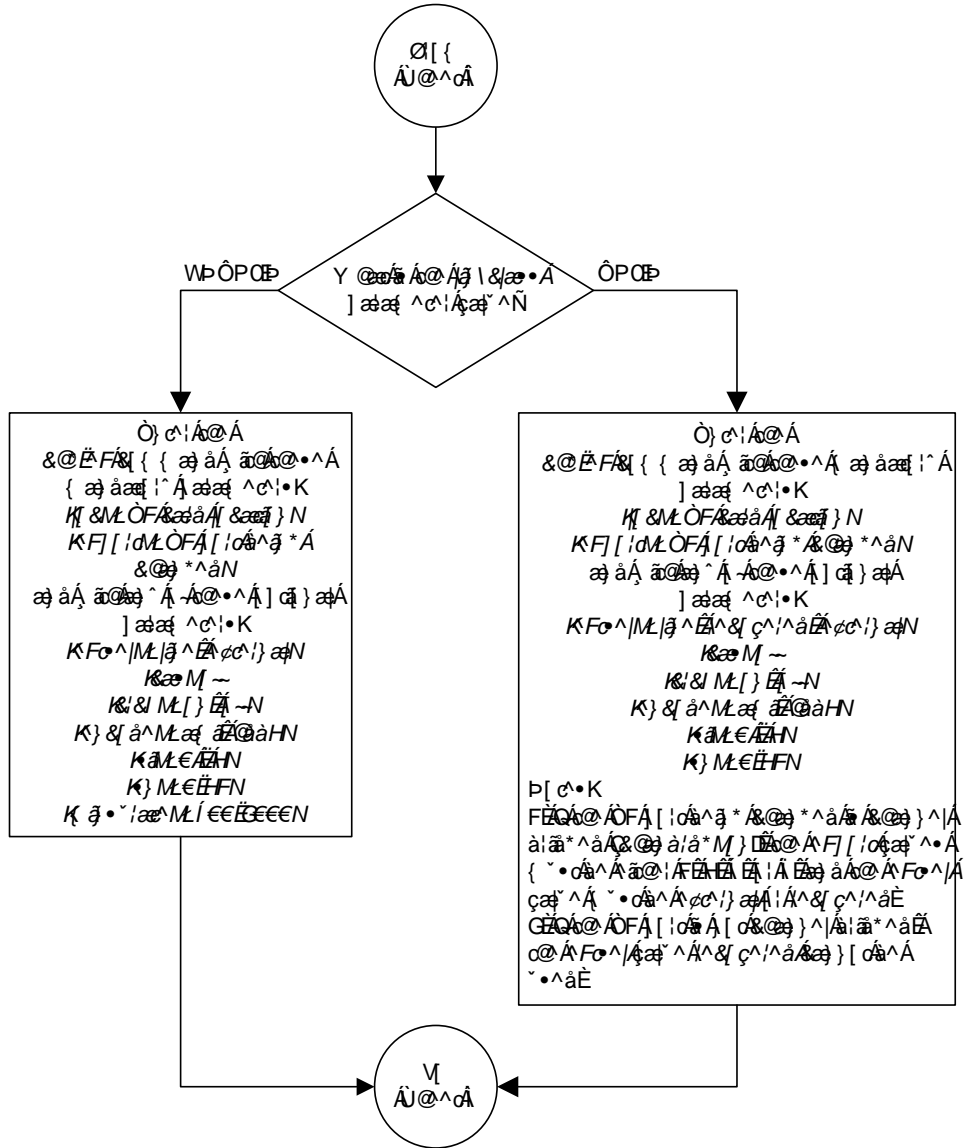

Adding an E1 Signaling Link

This procedure is used to add an E1 signaling link to the database using the **ent-slk** command and these parameters.

:loc – The card location of the card that the E1 signaling link will be assigned to.

:link – The signaling link on the card specified in the **loc** parameter.

:lsn – The name of the linkset that will contain the signaling link.

:slc – The signaling link code. The SLC must be unique within the linkset. It must be the same at both the EAGLE 5 SAS location and the distant node.

:bps – The transmission rate for the link in bits per second.

:ecm – Error correction method, either **basic** or **pcr**. The default value for this parameter is **basic**.

:pcrn1 – The threshold of the number of MSUs available for retransmission. If the error correction method being used is PCR (**:ecm=pcr**), and this threshold is reached, no new MSUs or FISUs are sent. The retransmission cycle is continued up to the last MSU entered into the retransmission buffer in the order in which they were originally transmitted.

:pcrn2 – The threshold of the number of MSU octets available for retransmission. If the error correction method being used is PCR (**:ecm=pcr**), and this threshold is reached, no new MSUs or FISUs are sent. The retransmission cycle is continued up to the last MSU entered into the retransmission buffer in the order in which they were originally transmitted.

:ts – The timeslot on the E1 card or channel card being used for the E1 signaling link.

:e1port – The E1 port on the E1 card that is servicing the timeslot selected for the E1 signaling link.

:e1loc – The location of the E1 card servicing the timeslot selected for the E1 signaling link. This parameter can be specified only when provisioning E1 signaling links on channel cards.

:l2tset – The level 2 timer set table assigned to the E1 signaling link. The type of linkset the E1 signaling link is assigned to and the E1 card's application determines the value of the **l2tset** parameter. The level 2 timer set tables are defined in the "Changing Level 2 Timers" procedure on page 3-219. Table A-15 on page A-78 shows the **l2tset** parameter values.

Table A-15. L2TSET Parameter Values

Type of Linkset	E1 Card's Application	L2TSET Parameter Value	L2TSET Parameter Default Value
ANSI linkset – Shown by this label in the <code>rtrv-ls</code> output. LSN APCA (SS7)	SS7ANSI	1 - 10	1
ITU linkset – Shown by one of these labels in the <code>rtrv-ls</code> output. LSN APCI (SS7) LSN APCN (SS7) LSN APCN24 (SS7)	CCS7ITU	11 - 20	11
ITU-N high-speed linkset for China – Shown by one of these labels in the <code>rtrv-ls</code> output. LSN (CHINA) APCN (SS7) LSN (CHINA) APCN24 (SS7)	CCS7ITU	21 - 25	21
ITU-N high-speed linkset for countries other than China – Shown by one of these labels in the <code>rtrv-ls</code> output. LSN APCN (SS7) LSN APCN24 (SS7)	CCS7ITU	26 - 30	26

The `ent-slk` command contains other optional parameters that can be used to configure a signaling link. These parameters are not shown here because they are not necessary to provision an E1 signaling link. These parameters are explained in more detail in the “Adding an SS7 Signaling Link” procedure on page 3-130, or in the `ent-slk` command description in the *Commands Manual*.

These items must be configured in the database before an E1 signaling link can be added:

- Shelf – see “Adding a Shelf” in the *Database Administration Manual - System Management*
- E1 Card (card type `lime1`) or Channel Card (card type `limch`) running either the `ss7ansi` or `ccs7itu` applications – see “Adding a LIM-E1 Card” procedure on page A-14
- Destination Point Code – see the “Adding a Destination Point Code” procedure on page 2-191.
- Linkset – “Adding an SS7 Linkset” procedure on page 3-17.

Verify that the link has been physically installed (all cable connections have been made).

E1 Interface

Timeslot 16 (**ts=16**) cannot be specified for an E1 signaling link if the E1 interface servicing this link has CAS enabled. This is shown by the entry **on** in the **CAS** field of the **rtrv-e1** output.

If the E1 signaling link is assigned to a channel card (card type **limch**), the **e1port** parameter cannot be specified. The **e1port** parameter value defaults to 1.

All E1 signaling links in a linkset can use either the 56000 or 64000 transmission rate. The transmission rate for the E1 signaling links in the linkset do not have to be the same.

The values for the **ts** parameter must be from 1 to 31.

The linkset must be in the database. The number of signaling links in a linkset cannot exceed 16. This can be verified with the **rtrv-ls** command.

The APC of the linkset assigned to the signaling link must be in the SS7 domain. Use the **rtrv-dstn** command to verify the domain of the APC of the linkset.

The **pcrn1** or **pcrn2** parameters can only be specified if the **ecm=pcr** parameter is specified.

If the E1 signaling link is being assigned to an unchannelized E1 port (shown by the entry **UNCHAN** in the **LINKCLASS** field in the **rtrv-e1** output), you cannot specify the **ts** parameter. The **link** parameter value must be either **a** or **b**. The transmission rate (**bps** parameter) for an unchannelized E1 signaling link is 1984000 bits per second. The **bps** parameter is optional, and if not specified with the **ent-slk** command, the **bps** parameter value defaults to 1984000 bits per seconds.

If the E1 signaling link is being assigned to a channel bridged E1 port (shown by the entries **MASTER** or **SLAVE** in the **CHANBRDG** field in the **rtrv-e1** output), the E1 port value for the signaling link must be the odd numbered (**MASTER**) E1 port.

If the E1 card is not an HC MIM, a maximum of 2 or 8 E1 signaling links can be assigned to the card. The range of **link** parameter values is dependent on the type of E1 card the signaling link is assigned to. If the E1 card is a LIM-E1 card, the **link** parameter values are either A or B, allowing a maximum of 2 signaling links on the card. If the E1 card is an E1/T1 MIM, the **link** parameter values are A - A3, or B - B3, allowing a maximum of 8 signaling links on the card.

If the E1 signaling link is being assigned to a channelized E1 port (shown by the entry **CHAN** in the **LINKCLASS** field in the **rtrv-e1** output) on an HC MIM, the **link** parameter values are A - A31 or B - B31. An HC MIM can contain a maximum of 64 channelized E1 signaling links.

To configure the EAGLE 5 SAS to perform circular routing detection test on the signaling links, "Configuring Circular Route Detection" procedure on page 3-231.

NOTE: Circular route detection is not supported in ITU networks.

To provision a EAGLE 5 SAS with more than 700 signaling links, the EAGLE 5 SAS must have certain levels of hardware installed. See the “Requirements for EAGLE 5 SASs Containing more than 700 Signaling Links” section on page D-2 for more information on these hardware requirements.

The EAGLE 5 SAS can contain a mixture of low-speed, E1, T1, ATM high-speed, and IP signalling links. The “Determining the Number of High-Speed and Low-Speed Signaling Links” section on page D-2 describes how to determine the quantities of the different types of signaling links the EAGLE 5 SAS can have.

Configuring Signaling Links on LIM-E1 Cards

The main consideration for the provisioning of LIM-E1 cards into the EAGLE 5 SAS is to determine the number of LIM-E1 cards existing in the network and the equipment needed for expanding the signaling link capacity of the EAGLE 5 SAS. To utilize the flexibility of the E1 interface feature, you may want to determine the minimum number of LIM-E1 cards needed to process the total number of SS7 links and then consider diversity for reliability reasons.

Use the following points as guidelines when considering diversity for E1:

- If possible, no two LIM-E1 cards containing links from a common link set should be on the same E1/dual port Channel Card.
- If possible, no two LIM-E1 cards containing links from a common link set should be on adjacent E1/dual port Channel Cards where they are powered from the same fuse position.
- If possible, no two LIM-E1 cards containing links from a common link set should be terminated on the same shelf because of the shelf clock cabling, and is only an issue if using master clocking sync to the network
- If possible, no two links in a link set should arrive at the EAGLE 5 SAS on the same LIM-E1 card.
- If possible, for link sets containing more than two links, you should minimize the number of links in that link set on any given LIM-E1 card.

As an example, consider a network consisting of 30 LIM-E1 cards with a total number of 100 links where the largest link set size is 8. The most efficient way to provision the EAGLE 5 SAS would be to have 4 extension shelves equipped with the E1 Cabling Backplane, 1 E1 Card, and 12 Channel Cards per shelf. Utilizing 1 “B” bus on each shelf, 25 signaling links would be terminated on each shelf for a total of 100. *This is also the minimum number of LIM-E1 Cards required for this example.*

With the same example but using the third and fifth bullets above as a consideration, the EAGLE 5 SAS would be provisioned with 8 extension shelves equipped with the E1 Cabling Backplane. Four of the shelves would be equipped with 1 E1 Card and 6 Channel Cards, and the other 4 shelves would be equipped with 1 E1 Card and 5 Channel Cards. *Since the largest link set size is 8, a total of 8 LIM-E1 Cards is required. Utilizing 1 “B” bus on each shelf, 13 signaling links*

E1 Interface

would be terminated on each shelf with 6 Channel Cards, and 12 signaling links would be terminated on each shelf with 5 Channel Cards.

Example Signaling Link Configuration

This examples used in this procedure are based on Tables A-16.

Table A-16. E1 Signaling Link Configuration Table

SLK		LSN	SLC	TYPE	BPS	TS	E1PORT	E1LOC
LOC	LINK							
1201	A	LSNE12	0	LIME1	64000	1	2	N/A
1202	A	LSNE12	1	LIMCH	64000	5	1	1201
1203	A	LSNE13	0	LIME1	64000	8	2	N/A
1204	A	LSNE13	1	LIMCH	64000	12	1	1203
1211	A	LSNE145	0	LIME1	56000	10	2	N/A
1212	A	LSNE145	1	LIMCH	56000	14	1	1211
1212	A	LSNE145	2	LIMCH	56000	20	1	1211
1301	A	LSN6	0	LIME1	1984000	N/A	4	N/A
1303	B	LSN7	0	LIME1	1984000	N/A	7	N/A

Canceling the `rept-stat-slk` and `rtrv-slk` Commands

Because the `rept-stat-slk` and `rtrv-slk` commands used in this procedure can output information for a long period of time, the `rept-stat-slk` and `rtrv-slk` commands can be canceled and the output to the terminal stopped. There are three ways that the `rept-stat-slk` and `rtrv-slk` commands can be canceled.

- Press the **F9** function key on the keyboard at the terminal where the `rept-stat-slk` or `rtrv-slk` commands were entered.
- Enter the `canc-cmd` without the `trm` parameter at the terminal where the `rept-stat-slk` or `rtrv-slk` commands were entered.
- Enter the `canc-cmd:trm=<xx>`, where `<xx>` is the terminal where the `rept-stat-slk` or `rtrv-slk` commands were entered, from another terminal other than the terminal where the `rept-stat-slk` or `rtrv-slk` commands were entered. To enter the `canc-cmd:trm=<xx>` command, the terminal must allow Security Administration commands to be entered from it and the user must be allowed to enter Security Administration commands. The terminal's permissions can be verified with the `rtrv-secu-trm` command. The user's permissions can be verified with the `rtrv-user` or `rtrv-secu-user` commands.

For more information about the `canc-cmd` command, go to the *Commands Manual*.

Procedure

1. Display the cards in the database using the `rtrv-card` command. This is an example of the possible output.

```
rlghncxa03w 05-09-28 09:12:36 GMT EAGLE5 34.0.0
CARD   TYPE      APPL      LSET NAME   LINK SLC LSET NAME   LINK SLC
1101   TSM          SCCP
1102   TSM          GLS
1113   GSPM         EOAM
1114   TDM-A
1115   GSPM         EOAM
1116   TDM-B
1117   MDAL
1201   LIME1        CCS7ITU
1202   LIMCH        CCS7ITU
1203   LIME1        CCS7ITU
1204   LIMCH        CCS7ITU
1211   LIME1        CCS7ITU
1212   LIMCH        CCS7ITU
1305   LIMOCU       CCS7ITU   sp6        A      0      sp7        B      0
1306   LIMOCU       CCS7ITU   nsp3       A      0      nsp4       B      0
1307   LIMOCU       CCS7ITU   nsp1       A      0
1308   LIMOCU       CCS7ITU   nsp1       A      1
1316   ACMENET     STPLAN
1314   LIMOCU       CCS7ITU   sp7        A      1      sp5        B      0
1317   TSM          SCCP
```

If the required E1 card or channel card is not in the database, go to the “Adding a LIM-E1 Card” procedure on page A-14 and add the required cards to the database.

2. Display the current linkset configuration using the `rtrv-ls` command. This is an example of the possible output.

```

rlghncxa03w 05-09-10 11:43:04 GMT EAGLE5 34.0.0
                                     L3T SLT                               GWS GWS GWS
LSN          APCA   (SS7)  SCRN  SET SET BEI LST LNKS  ACT MES DIS SLSCI NIS
lsnt145      150-075-038  scr4  1  1  yes a  0    on  on  off ---  ---
lsnt265      200-150-067  scr2  1  1  yes a  3    on  on  off ---  ---

                                     L3T SLT                               GWS GWS GWS
LSN          APCA   (X25)  SCRN  SET SET BEI LST LNKS  ACT MES DIS SLSCI NIS

                                     L3T SLT                               GWS GWS GWS
LSN          APCI   (SS7)  SCRN  SET SET BEI LST LNKS  ACT MES DIS SLSCI NIS
lsne12       2-150-7      scr1  1  1  no  a  2    on  on  off ---  ---
lsne145      4-049-3      scr1  1  1  no  a  3    on  on  off ---  ---
sp5          1-111-3      scr3  1  3  yes c  1    off off off ---  ---
sp6          1-111-1      scr1  1  1  yes a  1    off off off ---  ---
sp7          1-111-2      scr2  1  2  no  a  2    on  on  on  ---  ---

                                     L3T SLT                               GWS GWS GWS
LSN          APCN   (SS7)  SCRN  SET SET BEI LST LNKS  ACT MES DIS SLSCI NIS
lsne13       14950      scr1  1  1  no  a  2    on  on  off ---  off
nsp1         11111      scr1  1  1  yes a  2    off off off ---  off
nsp3         11112      scr2  1  2  no  a  1    on  on  on  ---  off
nsp4         11113      scr3  1  3  yes c  1    off off off ---  off

                                     L3T SLT                               GWS GWS GWS
LSN          APCN24 (SS7)  SCRN  SET SET BEI LST LNKS  ACT MES DIS SLSCI NIS

                                     L3T SLT                               GWS GWS GWS
LSN (CHINA) APCN   (SS7)  SCRN  SET SET BEI LST LNKS  ACT MES DIS SLSCI NIS

                                     L3T SLT                               GWS GWS GWS
LSN (CHINA) APCN24 (SS7)  SCRN  SET SET BEI LST LNKS  ACT MES DIS SLSCI NIS

Link set table is ( 11 of 1024) 1% full

```

If the required linkset is not in the database, go to the “Adding an SS7 Linkset” procedure on page 3-17 and add the required linkset to the database.

3. Display the current signaling link configuration using the `rtrv-slk` command. This is an example of the possible output.

```

rlghncxa03w 05-09-19 21:16:37 GMT EAGLE5 34.0.0

LOC LINK LSN          SLC TYPE      L2T          L1          PCR  PCR
                   SET  BPS      MODE TSET  ECM  N1  N2
1305 A   sp6          0  LIMOCU      1  56000  --- ---  BASIC ---  -----
1305 B   sp7          0  LIMOCU      1  64000  DTE ---  PCR   76  3800
1306 A   nsp3         0  LIMOCU      1  56000  --- ---  BASIC ---  -----
1306 B   nsp4         0  LIMOCU      1  56000  --- ---  BASIC ---  -----
1307 A   nsp1         0  LIMOCU      1  56000  --- ---  BASIC ---  -----
1308 A   nsp1         1  LIMOCU      1  56000  --- ---  BASIC ---  -----
1314 A   sp7          1  LIMOCU      2  64000  DTE ---  PCR   76  3800
1314 B   sp5          0  LIMOCU      3  64000  DCE  ON  BASIC ---  -----

LOC LINK LSN          SLC TYPE      LP          ATM
                   SET  BPS      TSEL          VCI  VPI  LL
LOC LINK LSN          SLC TYPE      LP          ATM          E1ATM
                   SET  BPS      TSEL          VCI  VPI  CRC4 SI SN
No Links Set up.

LOC LINK LSN          SLC TYPE      IPLIML2
No Links Set up.

LOC LINK LSN          SLC TYPE
No Links Set up.

LOC LINK LSN          SLC TYPE      L2T          PCR  PCR  E1  E1
                   SET  BPS      ECM  N1  N2  LOC  PORT TS
No Links Set up.

LOC LINK LSN          SLC TYPE      L2T          PCR  PCR  T1  T1
                   SET  BPS      ECM  N1  N2  LOC  PORT TS
No Links Set up.

SLK table is (8 of 1200) 1% full.

```

NOTE: If the `rtrv-slk` output in step 3 shows that the maximum number of signaling links is 1500, skip step 4 and go to step 5.

NOTE: If the `rtrv-slk` output in step 3 shows that the maximum number of signaling links is 1200, and the signaling link being added increases the number beyond 1200, do not perform step 4, but go to “Enabling the Large System # Links Controlled Feature” procedure on page 3-10 and enable the Large System # Links controlled feature for 1500 signaling links. Then go to step 5.

NOTE: If the `rtrv-slk` output in step 3 shows that the maximum number of signaling links is 1200, and the signaling link being added will not increase the number beyond 1200, skip step 4 and go to step 5.

4. Display the status of the Large System # Links controlled feature by entering the `rtrv-ctrl-feat` command. The following is an example of the possible output.

```
rlghncxa03w 05-09-28 21:15:37 GMT EAGLE5 34.0.0
The following features have been permanently enabled:
```

Feature Name	Partnum	Status	Quantity
IPGWx Signaling TPS	893012814	on	20000
ISUP Normalization	893000201	on	----
Command Class Management	893005801	on	----
LNP Short Message Service	893006601	on	----
Intermed GTT Load Sharing	893006901	on	----
XGTT Table Expansion	893006101	on	400000
XMAP Table Expansion	893007701	on	3000
HC-MIM SLK Capacity	893012707	on	64

```
The following features have been temporarily enabled:
```

Feature Name	Partnum	Status	Quantity	Trial Period Left
Zero entries found.				

```
The following features have expired temporary keys:
```

Feature Name	Partnum
Zero entries found.	

If the Large System # Links controlled feature is not enabled or on, go to “Enabling the Large System # Links Controlled Feature” procedure on page 3-10 and enable Large System # Links controlled feature for 1500 signaling links. Then go to step 5.

5. Display the E1 interfaces that will be assigned to the E1 signaling link using the `rtrv-e1` command with no parameters. This is an example of the possible output.

```
rlghncxa03w 05-09-19 21:17:04 GMT EAGLE5 34.0.0
```

LOC	PORT	CRC4	CAS	ENCODE	E1TSEL	SI	SN	CHANBRDG	LINK	MINSU
1201	2	ON	OFF	HDB3	LINE	0	0	-----	CHAN	----
1203	1	OFF	ON	HDB3	EXTERNAL	3	6	-----	CHAN	----
1211	2	ON	OFF	HDB3	LINE	0	0	-----	CHAN	----

If the desired E1 port and E1 card combination are not shown in the `rtrv-e1` output, add the E1 port and E1 card combination to the database by performing the one of these procedures:

- “Adding Channelized and non-Channel Bridged E1 Ports” procedure on page A-28.
- “Adding Channel Bridged E1 Ports” procedure on page A-37.
- “Adding Unchannelized E1 Ports” procedure on page A-45.

If a new E1 card was added in these procedures and that card is an HC MIM, skip step 6 and go to step 7.

NOTE: If the card the signaling link is being assigned to is a channel card, skip step 6, and go to step 7.

6. If any of the following conditions are shown in the `rtrv-e1` output in step 5, the card is an HC MIM.
- a. The `linkclass=unchan` parameter is assigned to the E1 port that will be assigned to the E1 signaling link. Go to step 7.
 - b. If the E1 port that will be assigned to the E1 signaling link is channel bridged. Go to step 7.
 - c. If E1 ports 3, 4, 5, 6, 7, or 8 are assigned to the E1 card that will be assigned to the E1 signaling link. Go to step 7.

If conditions a, b, or c are not shown in the `rtrv-e1` output, verify the type of E1 card.

-
7. Add the E1 signaling links using the `ent-slk` command.

If the output of step 5 shows that CAS is enabled for the E1 interface (shown by the entry `on` in the `CAS` field), timeslot 16 cannot be specified for the E1 signaling link.

The link parameter value is dependent on the type of card the E1 signaling link is assigned to. Table A-17 shows the link parameter values.

Table A-17. Link Parameter Values

Type of Card	Link Parameter Values
LIM-E1	A or B
E1/T1 MIM	A - A3, B - B3
HC MIM	A - A31, B - B31
HC MIM containing an unchannelized E1 port	A or B

If the E1 signaling link is being assigned to an unchannelized E1 port (shown by the entries **UNCHAN** in the **LINKCLASS** field in the **rtrv-e1** output), you cannot specify the **ts** parameter. The transmission rate (**bps** parameter) for an unchannelized E1 signaling link is 1984000 bits per second. The **bps** parameter is optional, and if not specified with the **ent-slk** command, the **bps** parameter value defaults to 1984000 bits per seconds.

It is recommended that unchannelized E1 signaling links are assigned to linksets that do not contain other types of signaling links.

For this example, enter these commands.

```
ent-slk:loc=1201:link=a:lsn=lsne12:slc=0:bps=64000:ts=1
:elport=2
ent-slk:loc=1202:link=a:lsn=lsne12:slc=1:bps=64000:ts=5
:elloc=1201
ent-slk:loc=1203:link=a:lsn=lsne13:slc=0:bps=64000:ts=8
:elport=2
ent-slk:loc=1204:link=a:lsn=lsne13:slc=1:bps=64000:ts=12
:elloc=1203
ent-slk:loc=1211:link=a:lsn=lsne145:slc=0:bps=56000:ts=10
:elport=2
ent-slk:loc=1212:link=a:lsn=lsne145:slc=1:bps=56000:ts=14
:elloc=1211
ent-slk:loc=1212:link=a2:lsn=lsne145:slc=2:bps=56000:ts=20
:elloc=1211
ent-slk:loc=1301:link=a:lsn=lsn6:slc=0:elport=4
ent-slk:loc=1303:link=b:lsn=lsn7:slc=0:elport=7
```

When each of these commands have successfully completed, this message should appear.

```
rlghncxa03w 05-09-07 08:29:03 GMT EAGLE5 34.0.0
ENT-SLK: MASP A - COMPLTD
```

8. Verify the changes using the **rtrv-slk** command, specifying the card location and signaling link entered in step 7. This is an example of the possible output.

rtrv-slk:loc=1201:link=a

This is an example of the possible output.

```
rlghncxa03w 05-09-19 21:17:04 GMT EAGLE5 34.0.0
                                L2T                    PCR PCR E1 E1
LOC LINK LSN          SLC TYPE  SET BPS   ECM  N1  N2  LOC PORT TS
1201 A  lsne12        0 LIME1   1  64000 BASIC ---  ----- 1201 2  1
```

rtrv-slk:loc=1202:link=a

This is an example of the possible output.

```
rlghncxa03w 05-09-19 21:17:04 GMT EAGLE5 34.0.0
                                L2T                    PCR PCR E1 E1
LOC LINK LSN          SLC TYPE  SET BPS   ECM  N1  N2  LOC PORT TS
1202 A  lsne12        1 LIMCH   1  64000 BASIC ---  ----- 1201 1  5
```

rtrv-slk:loc=1203:link=a

This is an example of the possible output.

```
rlghncxa03w 05-09-19 21:17:04 GMT EAGLE5 34.0.0
                                L2T                    PCR PCR E1 E1
LOC LINK LSN          SLC TYPE  SET BPS   ECM  N1  N2  LOC PORT TS
1203 A  lsne13        0 LIME1   1  64000 BASIC ---  ----- 1203 2  8
```

rtrv-slk:loc=1204:link=a

This is an example of the possible output.

```
rlghncxa03w 05-09-19 21:17:04 GMT EAGLE5 34.0.0
                                L2T                    PCR PCR E1 E1
LOC LINK LSN          SLC TYPE  SET BPS   ECM  N1  N2  LOC PORT TS
1204 A  lsne13        1 LIMCH   1  64000 BASIC ---  ----- 1203 1  12
```

rtrv-slk:loc=1211:link=a

This is an example of the possible output.

```
rlghncxa03w 05-09-19 21:17:04 GMT EAGLE5 34.0.0
                                L2T                    PCR PCR E1 E1
LOC LINK LSN          SLC TYPE  SET BPS   ECM  N1  N2  LOC PORT TS
1211 A  lsne145       0 LIME1   1  56000 BASIC ---  ----- 1211 2  10
```

rtrv-slk:loc=1212:link=a

This is an example of the possible output.

```
rlghncxa03w 05-09-19 21:17:04 GMT EAGLE5 34.0.0
                                L2T                    PCR PCR E1 E1
LOC LINK LSN          SLC TYPE  SET BPS   ECM  N1  N2  LOC PORT TS
1212 A  lsne145       1 LIMCH   1  56000 BASIC ---  ----- 1211 1  14
```

rtrv-slk:loc=1212:link=a2

This is an example of the possible output.

```
rlghncxa03w 05-09-19 21:17:04 GMT EAGLE5 34.0.0
                                L2T                    PCR PCR E1 E1
LOC LINK LSN          SLC TYPE  SET BPS   ECM  N1  N2  LOC PORT TS
1212 A2 lsne145       2 LIMCH   1  56000 BASIC ---  ----- 1211 1  20
```

E1 Interface

```
rtrv-slk:loc=1301:link=a
```

This is an example of the possible output.

```
rlghncxa03w 05-09-19 21:17:04 GMT EAGLE5 34.0.0
                                L2T                PCR  PCR  E1  E1
LOC  LINK LSN          SLC TYPE      SET  BPS    ECM  N1  N2  LOC  PORT TS
1301 A  lsn6          0  LIME1        1   1.984M BASIC ---  ---- 1301 4  --
```

```
rtrv-slk:loc=1303:link=b
```

This is an example of the possible output.

```
rlghncxa03w 05-09-19 21:17:04 GMT EAGLE5 34.0.0
                                L2T                PCR  PCR  E1  E1
LOC  LINK LSN          SLC TYPE      SET  BPS    ECM  N1  N2  LOC  PORT TS
1303 B  lsn7          0  LIME1        1   1.984M BASIC ---  ---- 1303 7  --
```

9. If any cards contain the first signaling link on a card, those cards must be brought into service with the **rst-card** command, specifying the location of the card. For this example, enter these commands.

```
rst-card:loc=1201
```

```
rst-card:loc=1202
```

```
rst-card:loc=1203
```

```
rst-card:loc=1204
```

```
rst-card:loc=1211
```

```
rst-card:loc=1212
```

```
rst-card:loc=1301
```

```
rst-card:loc=1303
```

When each of these commands have successfully completed, this message should appear.

```
rlghncxa03w 05-09-23 13:05:05 GMT EAGLE5 34.0.0
Card has been allowed.
```

10. Activate all signaling links on the cards using the **act-slk** command, specifying the card location and signaling link specified in step 7. For this example, enter these commands.

```
act-slk:loc=1201:link=a
```

```
act-slk:loc=1202:link=a
```

```
act-slk:loc=1203:link=a
```

```
act-slk:loc=1204:link=a
```

```
act-slk:loc=1211:link=a
```

```
act-slk:loc=1212:link=a
```

```
act-slk:loc=1212:link=a2
```

```
act-slk:loc=1301:link=a
```

```
act-slk:loc=1303:link=b
```

When each of these commands have successfully completed, this message should appear.

```
rlghncxa03w 05-09-07 08:31:24 GMT EAGLE5 34.0.0
Activate Link message sent to card
```

11. Check the status of the signaling links added in step 7 using the **rept-stat-slk** command with the card location and signaling link. The state of each signaling link should be in service normal (IS-NR) after the link has completed alignment (shown in the **PST** field). For this example, enter these commands.

```
rept-stat-slk:loc=1201:link=a
```

This is an example of the possible output.

```
rlghncxa03w 05-09-23 13:06:25 GMT EAGLE5 34.0.0
SLK      LSN      CLLI      PST      SST      AST
1201,A  lsne12    -----  IS-NR    Avail    ----
  ALARM STATUS      = No Alarms
  UNAVAIL REASON    = --
  E1 status         = 1201, RCVRY-E1F:FAC-E1 Port 2 available
```

```
rept-stat-slk:loc=1202:link=a
```

This is an example of the possible output.

```
rlghncxa03w 05-09-23 13:06:25 GMT EAGLE5 34.0.0
SLK      LSN      CLLI      PST      SST      AST
1202,A  lsne12    -----  IS-NR    Avail    ----
  ALARM STATUS      = No Alarms
  UNAVAIL REASON    = --
  E1 status         = 1201, RCVRY-E1F:FAC-E1 Port 1 available
```

```
rept-stat-slk:loc=1203:link=a
```

This is an example of the possible output.

```
rlghncxa03w 05-09-23 13:06:25 GMT EAGLE5 34.0.0
SLK      LSN      CLLI      PST      SST      AST
1203,A  lsne12    -----  IS-NR    Avail    ----
  ALARM STATUS      = No Alarms
  UNAVAIL REASON    = --
  E1 status         = 1203, RCVRY-E1F:FAC-E1 Port 2 available
```

```
rept-stat-slk:loc=1204:link=a
```

This is an example of the possible output.

```
rlghncxa03w 05-09-23 13:06:25 GMT EAGLE5 34.0.0
SLK      LSN      CLLI      PST      SST      AST
1204,A  lsne12    -----  IS-NR    Avail    ----
  ALARM STATUS      = No Alarms
  UNAVAIL REASON    = --
  E1 status         = 1203, RCVRY-E1F:FAC-E1 Port 1 available
```

```
rept-stat-slk:loc=1211:link=a
```

This is an example of the possible output.

```
rlghncxa03w 05-09-23 13:06:25 GMT EAGLE5 34.0.0
SLK      LSN      CLLI      PST      SST      AST
1211,A  lsne145   -----  IS-NR    Avail    ----
  ALARM STATUS      = No Alarms
  UNAVAIL REASON    = --
  E1 status         = 1211, RCVRY-E1F:FAC-E1 Port 2 available
```

E1 Interface

rept-stat-slk:loc=1212:link=a

This is an example of the possible output.

```
rlghncxa03w 05-09-23 13:06:25 GMT EAGLE5 34.0.0
SLK      LSN      CLLI      PST      SST      AST
1212,A  lsne145  -----  IS-NR    Avail    ----
  ALARM STATUS      = No Alarms
  UNAVAIL REASON    = --
  E1 status         = 1211, RCVRY-E1F:FAC-E1 Port 1 available
```

rept-stat-slk:loc=1212:link=a2

This is an example of the possible output.

```
rlghncxa03w 05-09-23 13:06:25 GMT EAGLE5 34.0.0
SLK      LSN      CLLI      PST      SST      AST
1212,A2 lsne145  -----  IS-NR    Avail    ----
  ALARM STATUS      = No Alarms
  UNAVAIL REASON    = --
  E1 status         = 1211, RCVRY-E1F:FAC-E1 Port 1 available
```

rept-stat-slk:loc=1301:link=a

This is an example of the possible output.

```
rlghncxa03w 05-09-23 13:06:25 GMT EAGLE5 34.0.0
SLK      LSN      CLLI      PST      SST      AST
1303,A  lsn6     -----  IS-NR    Avail    ----
  ALARM STATUS      = No Alarms
  UNAVAIL REASON    = --
  E1 status         = 1301, RCVRY-E1F:FAC-E1 Port 4 available
```

rept-stat-slk:loc=1303:link=b

This is an example of the possible output.

```
rlghncxa03w 05-09-23 13:06:25 GMT EAGLE5 34.0.0
SLK      LSN      CLLI      PST      SST      AST
1303,B  lsn7     -----  IS-NR    Avail    ----
  ALARM STATUS      = No Alarms
  UNAVAIL REASON    = --
  E1 status         = 1303, RCVRY-E1F:FAC-E1 Port 7 available
```

-
12. Backup the new changes using the **chg-db:action=backup:dest=fixed** command. These messages should appear, the active Maintenance and Administration Subsystem Processor (MASP) appears first.

```
BACKUP (FIXED) : MASP A - Backup starts on active MASP.
BACKUP (FIXED) : MASP A - Backup on active MASP to fixed disk complete.
BACKUP (FIXED) : MASP A - Backup starts on standby MASP.
BACKUP (FIXED) : MASP A - Backup on standby MASP to fixed disk complete.
```

Flowchart A-6. Adding an E1 Signaling Link (Sheet 1 of 6)

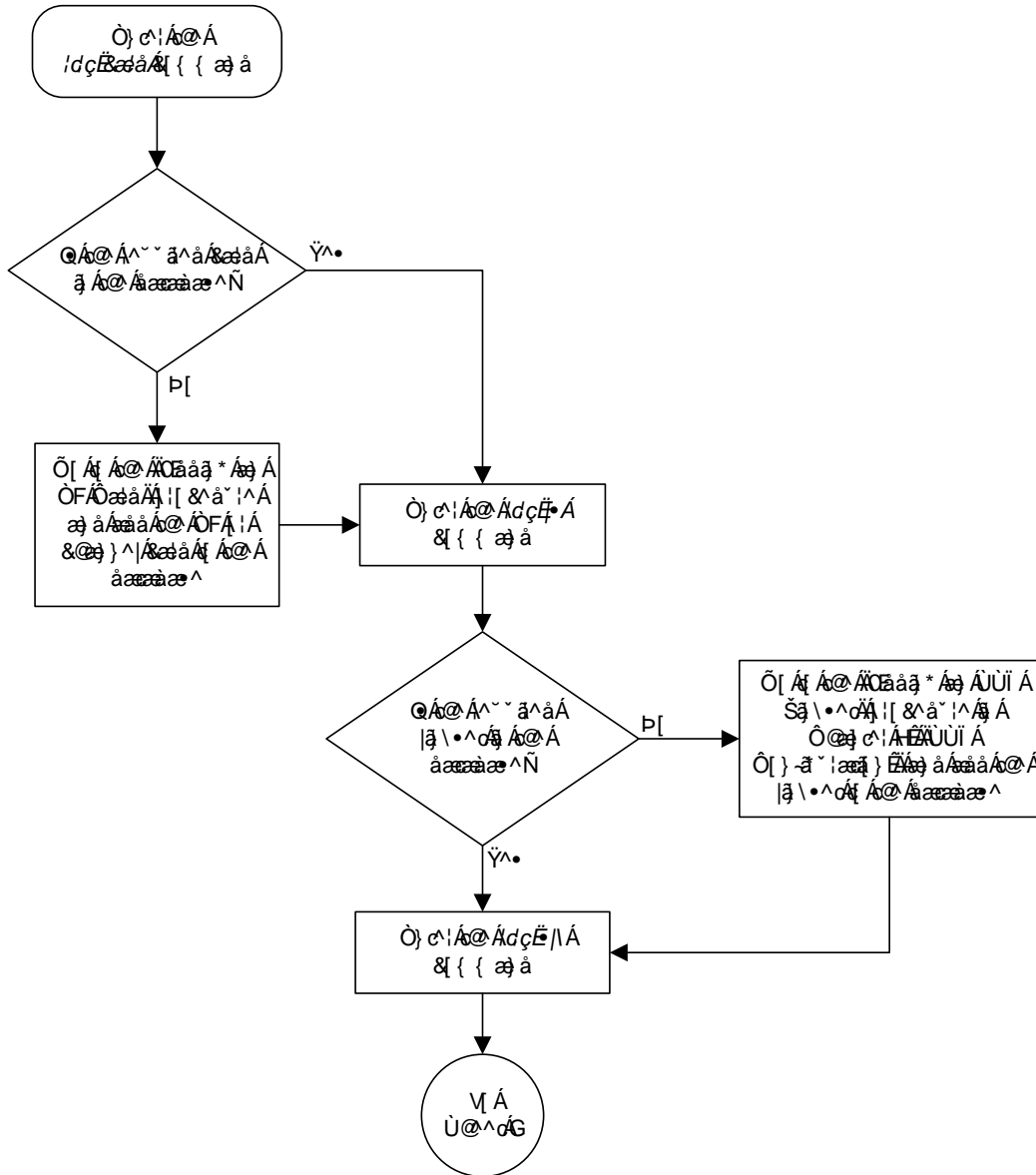

Flowchart A-6. Adding an E1 Signaling Link (Sheet 3 of 6)

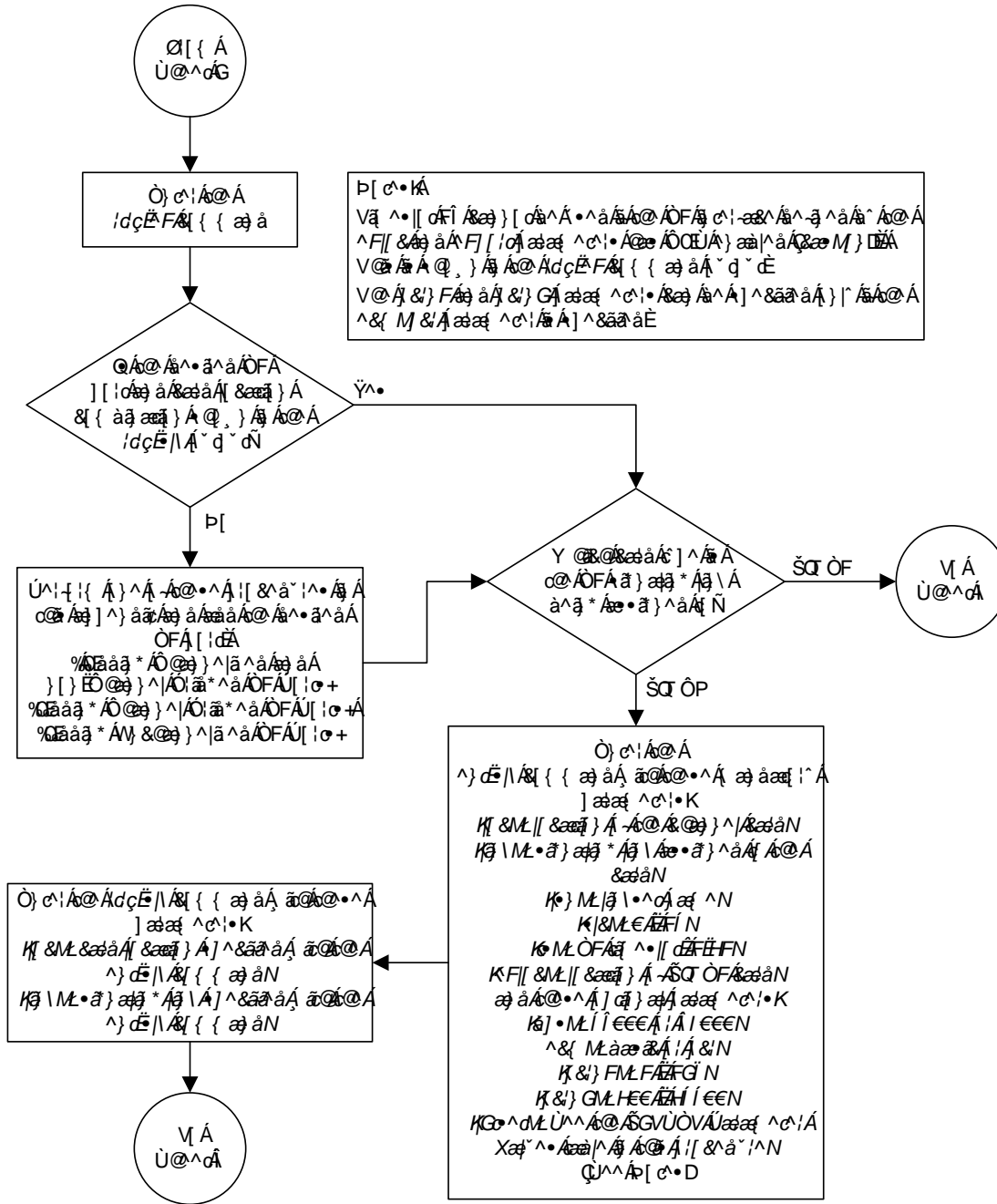

Flowchart A-6. Adding an E1 Signaling Link (Sheet 6 of 6)

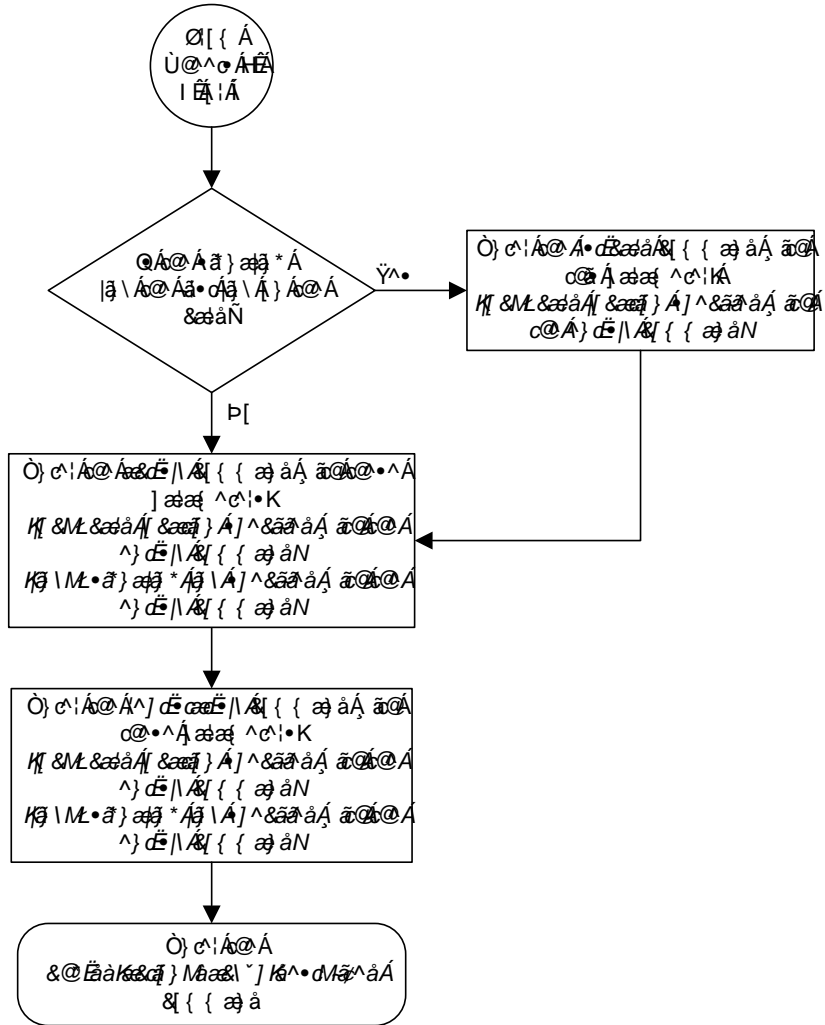

B

T1 Interface

Introduction.....	B-2
Determining the Configuration.....	B-7
Adding a LIM-T1 Card.....	B-11
Removing a LIM-T1 Card.....	B-20
Adding the T1 Interface Parameters.....	B-24
Removing the T1 Interface Parameters.....	B-33
Changing the T1 Interface Parameters.....	B-36
Adding a T1 Signaling Link.....	B-47

Introduction

The T1 interface terminates or distributes T1 facility signals for the purpose of processing the SS7 signaling links carried by the T1 carrier. The T1 interface can be either an E1/T1 MIM or an HC MIM as shown in Figures B-1 and B-2. The E1/T1 MIM or HC MIM can also be used as an E1 interface. This appendix describes how the T1 interface is configured. The E1 interface configuration is described in Appendix A, "E1 Interface." The E1/T1 MIM contain up to eight signaling links and allows the EAGLE 5 SAS to contain more than 500 signaling links.

Figure B-1. E1/T1 MIM Block Diagram

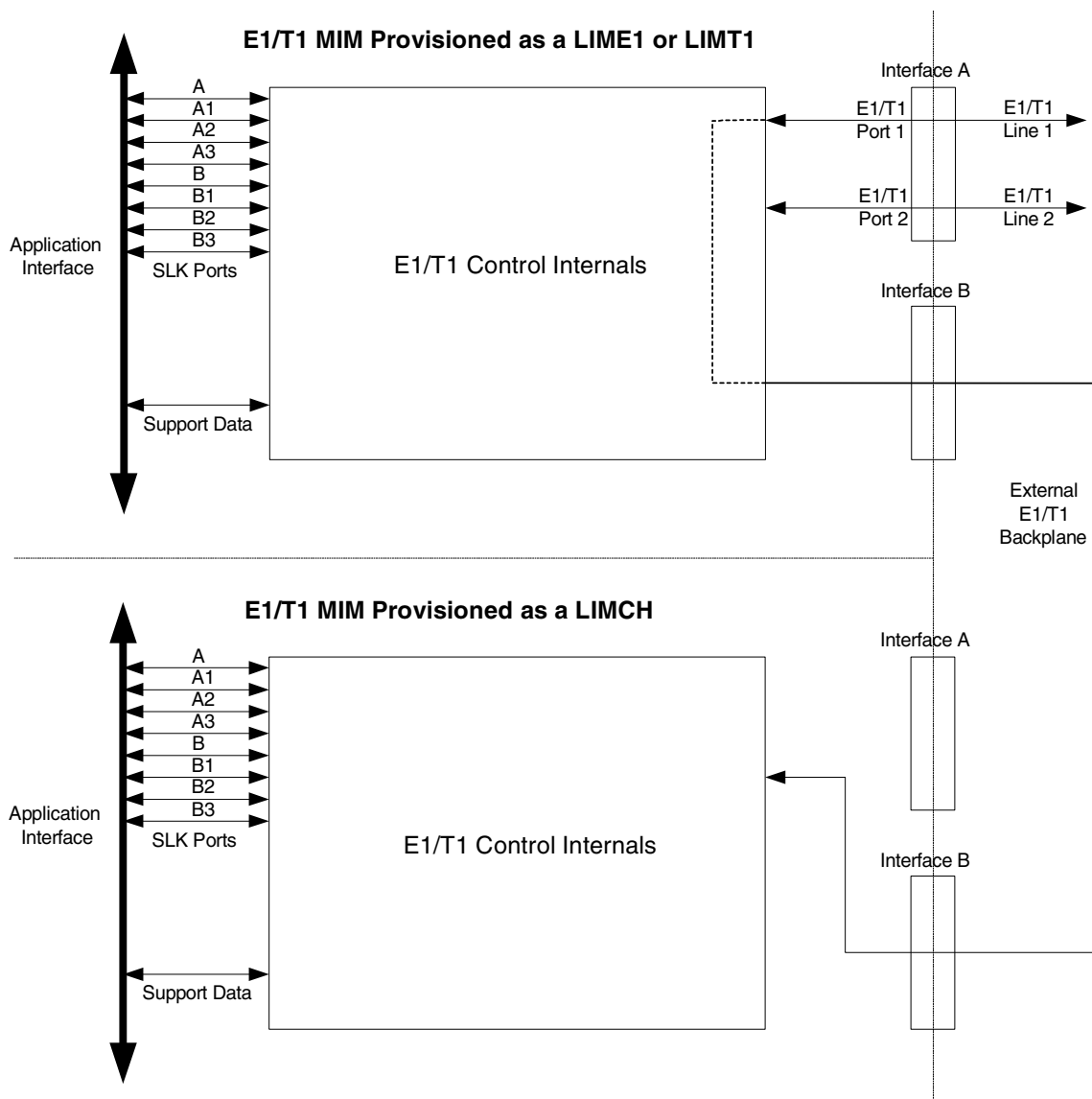

Figure B-2. HC MIM Block Diagram

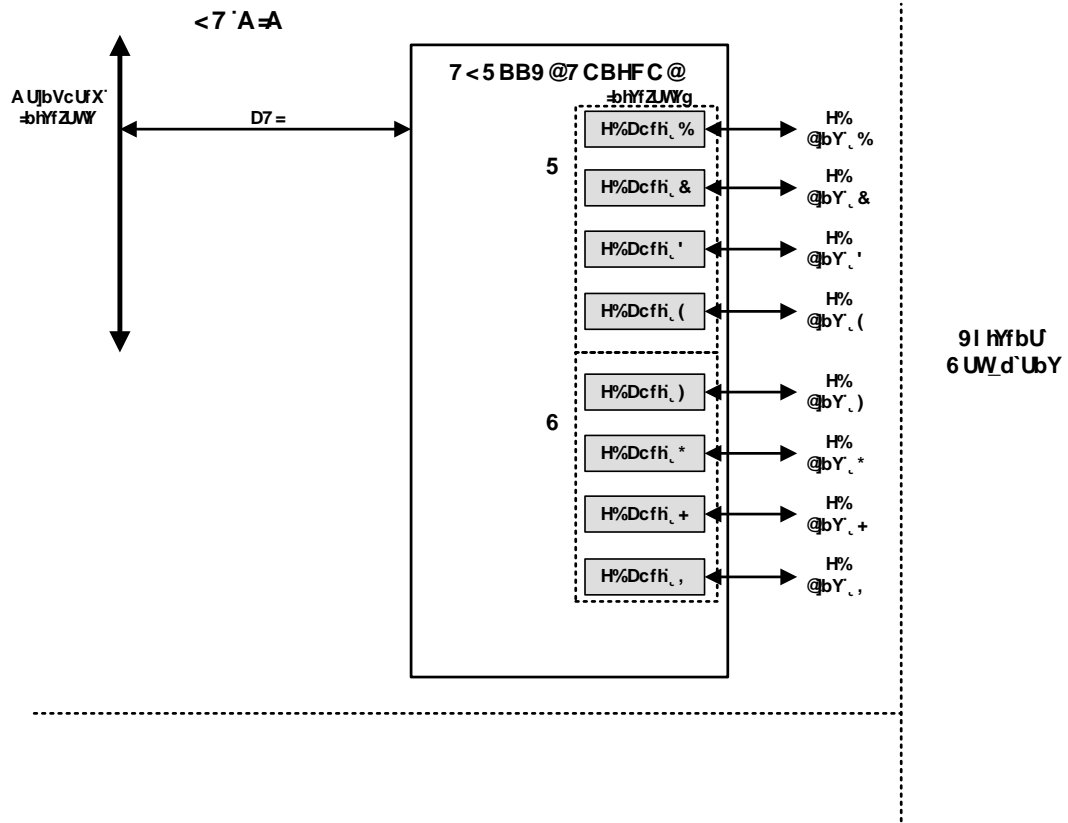

Table B-1 provides an overview of the functions of the T1 card and the channel card.

Table B-1. Functional Overview of the T1 and Channel Card

Card	Function
T1	<ul style="list-style-type: none"> • Connectivity of both T1 interfaces to a 100 Ohm interface. • Processing of a total of eight time slots from the T1 interfaces • Interface T1 port 1 through an external backplane to channel cards for processing of additional time slots
Channel	<ul style="list-style-type: none"> • Processing of eight time slots from the T1 interface • Interface through an external backplane to a T1 card to process eight time slots

Configured as a T1 Card

Configured as a T1 card, two separate and independent T1 inputs can be terminated on a T1/channel card. From one or two bi-directional T1 facility inputs, one to eight bi-directional channels are extracted and processed as SS7 signaling links. Implemented as T1 Link Interface Modules, up to 24 separate and independent T1 inputs can be terminated in an extension shelf. The transmission rate of signaling links on the MIM card must be 56 kbps.

Configured as a Channel Card

In an extension shelf equipped with the T1 backplane, a T1 configured card terminates one or two T1 inputs and connects the T1 port 1 input to one of eight available busses on the T1 cabling backplane. Other T1 cards configured as channel cards also connected to the T1 cabling backplane are able to extract any eight signaling channels from the same T1 port 1 input. The transmission rate of signaling links on the MIM card configured as a channel card must be 56 kbps.

NOTE: An HC MIM cannot be used as a channel card.

High Capacity Multi-Channel Interface Module (HC MIM)

The High Capacity Multi-Channel Interface Module (HC MIM) provides access to eight T1 ports residing on backplane connectors A and B. Each data stream consists of 24 T1 DS0 signaling links assigned in a time-division multiplex manner. Each channel occupies a unique timeslot in the data stream and can be selected as a local signaling link on the interface card. A maximum of 64 T1 signaling links can be assigned to an HC MIM.

To support the processing of signaling channels that are intermixed on trunks with voice or data channels, the HC MIM allows T1 ports to be channel bridged. This allows better utilization of T1 bandwidth without dedicating entire trunks to signaling.

Figure B-3. Channel Bridging

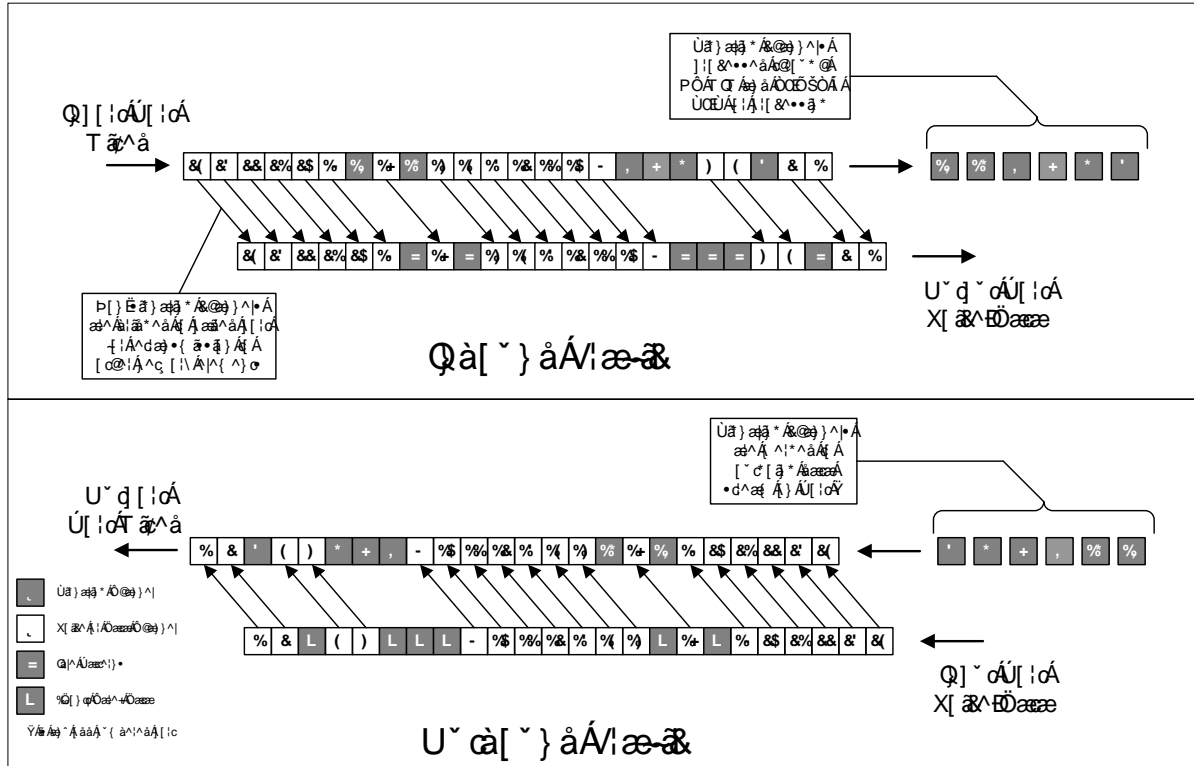

Channel bridging is implemented by pairing odd and even T1 ports. The T1 port selected for channel bridging is the odd numbered port (1, 3, 5, 7). When the T1 port is selected for channel bridging, it is paired with its adjacent even numbered port (2, 4, 6, 8) as shown in Table B-2.

Table B-2. Channel Bridging T1 Port Pairing

Odd Numbered T1 Port (Bridging Master)	Even Numbered T1 Port Bridged to the Odd Numbered T1 Port (Bridging Slave)
1	2
3	4
5	6
7	8

By pairing T1 ports, the adjacent even numbered T1 port could be used to allow data received on the bridging master (odd) T1 port to reach downstream network elements. This interface is a bi-directional interface so data is also able to enter the bridging slave (even) T1 port and leave the EAGLE 5 SAS through the bridging master (odd) T1 port. There is a 1 to 1 correspondence between the timeslots on the bridging master and slave T1 ports.

In order to use channel bridging without facility errors, both T1 ports (bridging master and slave) must be synchronous (timed off the same clock source). This may be accomplished in one of the following ways:

- The bridging master T1 port and the bridging slave T1 port use timing recovered from each other (using the `t1tsel=recovered` parameter with either the `ent-t1` or `chg-t1` command). When provisioning channel bridged T1 port, only the bridging master T1 port is provisioned with the `ent-t1` or `chg-t1` command. The bridging slave T1 port is automatically provisioned with the same attributes as the bridging master T1 port.
- Both the bridging master and slave T1 ports are using an external clock source (using the `t1tsel=external` parameter when provisioning the channel bridged T1 port with either the `ent-t1` or `chg-t1` command).

Any other methods used for timing could cause problems on the T1 trunk and are not be supported.

Idle patterns on the shadow channels, that is, the timeslots located on the bridging slave T1 port that have been not been dropped from the bridging master T1 port, are provided by the EAGLE 5 SAS. All other idle timeslots that are not dropped by the EAGLE 5 SAS must contain an idle pattern provided by the remote network elements connected to both T1 ports (bridging master and slave). Without these patterns on the idle timeslots, instability of the T1 signaling link may occur.

Provisioning of signaling links on the bridging slave T1 port is not allowed while the bridging master T1 port is channel bridged.

Determining the Configuration

External Interface Descriptions

The T1 backplane provides a method for extending individual T1 channels from the T1-configured cards to any channel-configured cards in use. Note the following issues regarding the T1 backplane:

- Only one T1-configured card may be plugged into each bus on the backplane.
- When installing non-T1 cards on the shelf equipped with the T1 interface backplane, ensure that none of the slots to be used are cabled to the T1 interface backplane. If a non-T1 card is installed in a slot that is connected to the T1 backplane, all T1 cards on that bus may fail.
- Only one T1 card may be connected (via the B port) to each bus of the T1 backplane, and all SS7 links derived from any particular T1 must be processed on the same shelf on which the incoming T1 is terminated.
- Due to cable congestion, Tekelec does not recommend use of the T1 cabling backplane on the control shelf.
- If the control shelf is used, a maximum of 20 T1 interfaces can be utilized in the control shelf.

Descriptions of the T1 hardware and the procedures for installing the T1 hardware are contained in the *Hardware Manual - EAGLE 5 SAS* and *Installation Manual - EAGLE 5 SAS*.

The procedure for removing a T1 signaling link is the same as removing an SS7 signaling link, so to remove a T1 signaling link from the database, go to the "Removing an SS7 Signaling Link" procedure on page 3-145.

Possible Configurations

The T1 backplane was designed to allow the maximum number of possible customer setups. It allows the customer to choose between several levels of diversity and convenience. Configurations depend on the number of cards configured as T1 cards versus the number of cards configured as channel cards. The level of diversity required by the customer also affects the configuration requirements. Note that all signals labeled "T1 input" may be one or two T1 ports depending on the cable used.

Support of Two T1 Ports

The E1/T1 MIM will support two T1 ports, which are independently configurable. On a T1 card, T1 port 1 will support channel cards. The second port of that T1 card will only support up to a maximum of eight time slots and will not support channel cards.

Clocking Options

Each T1 interface must independently operate in one of two clocking modes. When configured as a channel card, a T1 card is required for the channel card's clocking source.

- Slave Timing - The default receive clock on the LIM-T1 card will be used as the source of the transmit clock.
- Master Timing - The transmit clock of the LIM-T1 card. The Master Timing feature allows a T1 signaling link to take its high-speed clock reference directly from an external high-speed master clock source.

Support of T1 Framing Options

The T1 interfaces independently support either the SF (superframe format) or ESF (extended superframe format) T1 framing options. Selection of these options is made by the `framing` parameter of either the `ent-t1` or `chg-t1` commands.

LIM-T1 Card to Channel Card Interface

Whether the T1 card is operating as a T1 card or a channel card, the card will map any eight channels from the T1 interfaces to an HDLC controller (ports A, B, A1, A2, A3, B1, B2, B3). These eight channels could be dropped either both from T1 port 1 or one from T1 port 1 and the other from T1 port 2. When the T1 card is configured as a T1 card, it will support the external T1 cabling backplane interface from T1 port 1 (*T1 port 2 will not have this capability*) to additional T1 cards, within the same shelf, configured as channel cards. Idle time slots not assigned to a T1 card or a channel card will be filled with a one's pattern.

T1 Interface Configuration Procedures

This appendix contains these procedures because they contain information specific to the T1 Interface:

- “Adding a LIM-T1 Card” on page B-11
- “Removing a LIM-T1 Card” on page B-20
- “Adding the T1 Interface Parameters” on page B-24
- “Removing the T1 Interface Parameters” on page B-33
- “Changing the T1 Interface Parameters” on page B-36
- “Adding a T1 Signaling Link” on page B-47

Procedures for configuring the linksets and routes, for removing SS7 signaling links (which includes T1 signaling links), and for configuring the HC MIM temperature alarms are contained in Chapter 3, “SS7 Configuration.” These procedures contain no information that is specific to the T1 interface, therefore, are not included in this appendix.

The procedures contained in this appendix use a variety of commands. If more information on these commands is needed, go to the *Commands Manual* to find the required information.

Adding a LIM-T1 Card

The LIM-T1 card is provisioned in the database using the `ent-card` command. This card can be provisioned as either a T1 card or a channel card. The card being provisioned in the database can be one of these cards shown in Table B-4.

Table B-4. T1 Card Part Numbers

Card Type	Part Number
E1/T1 MIM	870-2198-XX
HC MIM	870-2671-01

The `ent-card` command uses these parameters.

`:loc` – The location of the card being added to the database.

NOTE: The HC MIM can be inserted only in a odd-numbered card location. The HC MIM will not power up if it is inserted in an even-numbered card location. All the T1 backplane cabling should be removed from the B connector for the slot that the HC MIM will occupy.

The HC MIM occupies two card locations, so the even numbered card location adjacent to the odd numbered slot where the HC MIM has been inserted must be empty, as shown in Table B-5. The HC MIM is connected to the network through the odd numbered card slot connector.

Table B-5. HC MIM Card Locations

Location of the HC MIM	Empty Card Location	Location of the HC MIM	Empty Card Location
Slot 01	Slot 02	Slot 11	Slot 12
Slot 03	Slot 04	Slot 13	Slot 14
Slot 05	Slot 06	Slot 15	Slot 16
Slot 07	Slot 08	Slot 17	Slot 18

`:type` – The type of card being added to the database. For this procedure, the value of this parameter is `limt1` (T1 card) or `limch` (channel card).

NOTE: The HC MIM cannot be provisioned as a channel card.

`:app1` – The application software or GPL that is assigned to the card. For this procedure, the value of this parameter is either `ccs7itu` or `ss7ansi`.

`:force` – Allow the LIM to be added to the database even if there are not enough cards running the SCCP GPL (TSM) or running the VSCCP GPL (DSM) in the EAGLE 5 SAS to support the number of LIMs in the EAGLE 5 SAS. This parameter is obsolete and is no longer used.

The shelf to which the card is to be added, must already be in the database. This can be verified with the `rtrv-shlf` command. If the shelf is not in the database, see the “Adding a Shelf” procedure in the *Database Administration Manual - System Management*.

If an HC MIM is being provisioned in this procedure, the FAN feature must be turned on. If the FAN feature is not turned on, the HC MIM will be auto-inhibited when the HC MIM is inserted into the shelf. The status of the FAN feature is shown in the `rtrv-feat` command output.

If an HC MIM is being provisioned in this procedure, HIPR cards must be installed into card locations 9 and 10 in the shelf that the HC MIM will occupy. If HIPR cards are not installed in the shelf that the HC MIM will occupy, the HC MIM will be auto-inhibited when the HC MIM is inserted into the shelf. Enter the `rept-stat-gpl:gpl=hipr` command to verify whether or not HIPR cards are installed in the same shelf as the HC MIM being provisioned in this procedure.

The examples in this procedure are used to add the LIM-T1 cards in card locations 1215 and 1216 to the database.

Procedure

1. Display the cards in the EAGLE 5 SAS using the `rtrv-card` command. This is an example of the possible output.

```
rlghncxa03w 05-09-28 09:12:36 GMT EAGLE5 34.0.0
CARD  TYPE      APPL      LSET NAME   LINK SLC LSET NAME   LINK SLC
1101  TSM           SCCP
1102  TSM           GLS
1113  GSPM         EOAM
1114  TDM-A
1115  GSPM         EOAM
1116  TDM-B
1117  MDAL
1201  LIMV35      CCS7ITU  lsne12      A      0
1202  LIMV35      CCS7ITU  lsne12      A      1
1203  LIMV35      CCS7ITU  lsne13      A      0
1204  LIMV35      CCS7ITU  lsne13      A      1
1207  LIMT1       SS7ANSI  lsnt265     A      0
1208  LIMCH       SS7ANSI  lsnt265     A      1  lsnt265     A2     2
1211  LIMT1       CCS7ITU  lsne145     A      0
1212  LIMCH       CCS7ITU  lsne145     A      1  lsne145     A2     2
1305  LIMOCU      CCS7ITU  sp6         A      0  sp7         B      0
1306  LIMOCU      CCS7ITU  nsp3        A      0  nsp4        B      0
1307  LIMOCU      CCS7ITU  nsp1        A      0
1308  LIMOCU      CCS7ITU  nsp1        A      1
1316  ACMENET     STPLAN
1314  LIMOCU      CCS7ITU  sp7         A      1  sp5         B      0
1317  TSM           SCCP
```

The cards should be distributed throughout the EAGLE 5 SAS for proper power distribution. Refer to the *Installation Manual - EAGLE 5 SAS* for the shelf power distribution.

2. Verify that the correct hardware has been installed on the EAGLE 5 SAS to support the LIM-T1 card as shown in the *Installation Manual - EAGLE 5 SAS*.
-
3. Physically verify that the E1 card has been installed into the card location that will be specified in step 8. If the E1 card is an HC MIM, make sure the HC MIM is installed according to the card location requirements shown in Table B-5 on page B-11. If a card is installed and provisioned in the even numbered card location adjacent to the desired odd numbered card, either choose another card location to install and provision the HC MIM, or remove the card in the even-numbered card location by performing the appropriate procedure shown in Table B-6.

NOTE: Channel cards must be installed in the same shelf as the E1 card that is servicing the timeslots on those channel cards.

Table B-6. Card Removal Procedures

Card Application	Procedure
SS7ANSI, ATMANSI, CCS7ITU, ATMITU	"Removing an SS7 LIM" in Chapter 4, "System Configuration Procedures" in the <i>Database Administration Manual - System Management</i> . "Adding a LIM-E1 Card" on page A-14 "Removing a LIM-T1 Card" on page B-20
SS7GX25	"Removing an X.25 LIM" in Chapter 2, "X.25 Gateway Configuration," in the <i>Database Administration Manual - Features</i>
SCCP	"Removing an SCCP Card" in Chapter 2, "Global Title Translation (GTT) Configuration," in the <i>Database Administration Manual - Global Title Translation</i> "Removing an SCCP Card" in the <i>LNP Feature Activation Guide</i>
VSCCP	
GLS	"Removing a GLS Card" in Chapter 2, "Gateway Screening (GWS) Overview," in the <i>Database Administration Manual - Gateway Screening</i>
STPLAN, VXWSLAN	"Removing an STP LAN Card" in Chapter 3, "STP LAN Configuration," in the <i>Database Administration Manual - Features</i>
EBDADCM	"Removing the DCM Applied to LSMS BLM-Based Operations" in the <i>LNP Feature Activation Guide</i>
EBDABLM	"Removing the BLM Applied to LSMS BLM-Based Operations" in the <i>LNP Feature Activation Guide</i>
IPLIM, IPLIMI, SS7IPGW, IPGWI	"Removing an IP Card" in Chapter 3, "IP ⁷ Secure Gateway Configuration Procedures," in the <i>Database Administration Manual - IP⁷ Secure Gateway</i>
EROUTE	"Removing an STC Card" in Chapter 6, "Eagle Support for Integrated Sentinel Configuration," in the <i>Database Administration Manual - Features</i>
MCP	"Removing an MCPM" in Chapter 4, "System Configuration Procedures" in the <i>Database Administration Manual - System Management</i> .
IPS	"Removing an IPSM" in Chapter 4, "System Configuration Procedures" in the <i>Database Administration Manual - System Management</i> .

NOTE: If the LIM-T1 card being added in this procedure is not an HC MIM, skip steps 4 through 7 and go to step 8.

4. Verify whether or not that the Fan feature is on, by entering the `rtrv-feat` command. If the global title translation feature is on, the entry `FAN = on` appears in the `rtrv-feat` command output.

NOTE: The `rtrv-feat` command output contains other fields that are not used by this procedure. If you wish to see all the fields displayed by the `rtrv-feat` command, see the `rtrv-feat` command description in the *Commands Manual*.

If the Fan feature is on, skip step 5, and go to step 6.

5. Turn the Fan feature on by entering this command.

`chg-feat:FAN=on`

NOTE: Once the Fan feature is turned on with the `chg-feat` command, it cannot be turned off.

The Fan feature must be purchased before you turn this feature on with the `chg-feat` command. If you are not sure if you have purchased the Fan feature, contact your Tekelec Sales Representative or Account Representative.

When the `chg-feat` has successfully completed, this message appears.

```
rlghncxa03w 05-09-28 11:43:04 GMT EAGLE5 34.0.0
CHG-FEAT: MASP A - COMPLTD
```

6. The shelf containing the HC MIM being added in this procedure must have fans installed. Verify whether or not fans are installed on the shelf.

If the fans are installed, go to step 7.

If the fans are not installed on the shelf containing the HC MIM, go to the *Installation Manual - EAGLE 5 SAS* and install the fans. Once the fans have been installed, and tested, go to step 7. The fans must be working properly before an HC MIM can be placed in the EAGLE 5 SAS.

- Verify that HIPR cards are installed in card locations 9 and 10 in the shelf containing the HC MIM being added in this procedure. Enter this command.

```
rept-stat-gpl:gpl=hipr
```

This is an example of the possible output.

```
rlghncxa03w 05-09-01 11:40:26 GMT EAGLE5 34.0.0
GPL          CARD          RUNNING          APPROVED          TRIAL
HIPR         1109          125-002-000    125-002-000    125-003-000
HIPR         1110          125-002-000    125-002-000    125-003-000
HIPR         1209          125-002-000    125-002-000    125-003-000
HIPR         1210          125-002-000    125-002-000    125-003-000
HIPR         1309          125-002-000    125-002-000    125-003-000
HIPR         1310          125-002-000    125-002-000    125-003-000
HIPR         2109          125-002-000    125-002-000    125-003-000
HIPR         2110          125-002-000    125-002-000    125-003-000
Command Completed
```

If HIPR cards are installed in the shelf containing the HC MIM, go to step 8.

If HIPR cards are not installed on the shelf containing the HC MIM, go to the *Installation Manual - EAGLE 5 SAS* and install the HIPR cards. Once the HIPR cards have been installed, go to step 8.

- Add the card using the **ent-card** command. If the LIM-T1 card is an HC MIM, the HC MIM can be only in a odd-numbered card location, and cannot be provisioned as a channel card.

For this example, enter these commands.

```
ent-card:loc=1215:type=limt1:appl=ss7ansi
```

```
ent-card:loc=1216:type=limch:appl=ss7ansi
```

When each of these commands have successfully completed, this message should appear.

```
rlghncxa03w 05-09-12 09:12:36 GMT EAGLE5 34.0.0
ENT-CARD: MASP A - COMPLTD
```

- Verify the changes using the **rtrv-card** command with the card location specified in step 8. For this example, enter these commands.

```
rtrv-card:loc=1215
```

This is an example of the possible output.

```
rlghncxa03w 05-09-28 09:12:36 GMT EAGLE5 34.0.0
CARD  TYPE      APPL      LSET NAME      LINK SLC LSET NAME      LINK SLC
1215  LIMT1      SS7ANSI
```

```
rtrv-card:loc=1216
```

This is an example of the possible output.

```
rlghncxa03w 05-09-28 09:12:36 GMT EAGLE5 34.0.0
CARD  TYPE      APPL      LSET NAME      LINK SLC LSET NAME      LINK SLC
1216  LIMCH      SS7ANSI
```

Flowchart B-1. Adding a LIM-T1 Card (Sheet 4 of 4)

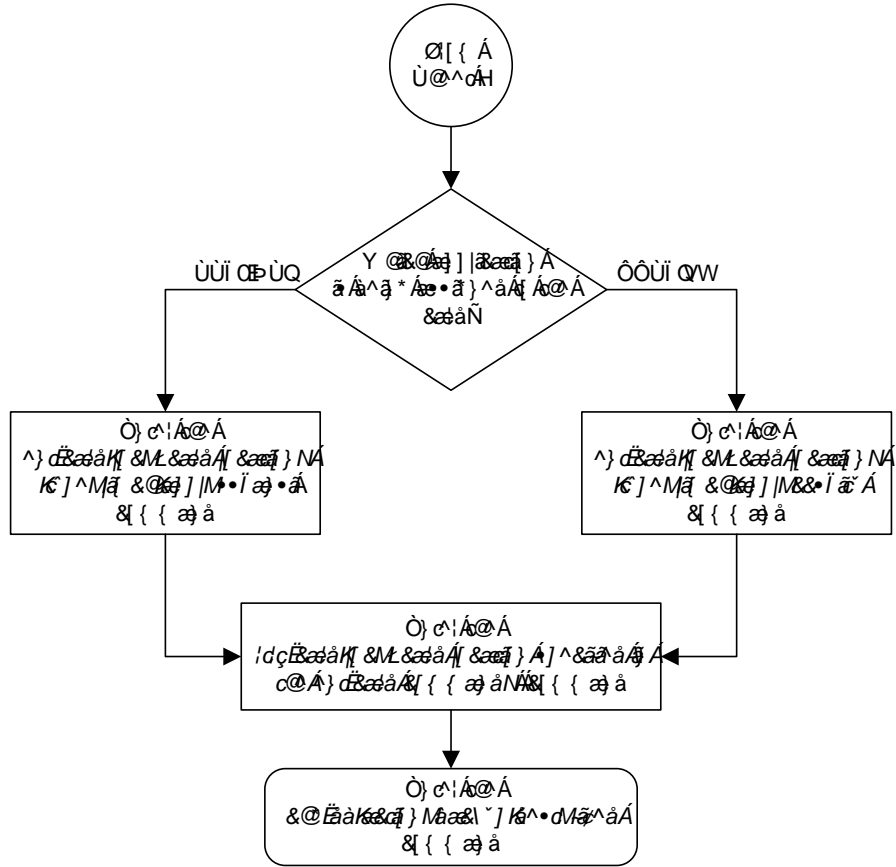

Removing a LIM-T1 Card

This procedure is used to remove either a T1 card or a channel card from the database using the `dlc-card` command. The card being removed must exist in the database.

If a T1 card is being removed, then no T1 interfaces can be assigned to the card. This can be verified with the `rtrv-t1` command. Go to the “Removing the T1 Interface Parameters” procedure on page B-33 to remove the T1 interfaces assigned to the T1 card being removed from the database.

If only a channel card is being removed from the database, then no SS7 signaling links can be assigned to the card. This can be verified with the `rtrv-slk` command. Go to the “Removing an SS7 Signaling Link” procedure on page 3-145 to remove the signaling links assigned to the channel card being removed from the database.



CAUTION: If the T1 card or channel card is the last SS7 LIM in service, removing this card from the database will cause SS7 traffic to be lost and isolate the EAGLE 5 SAS from the network.

The examples in this procedure are used to remove the T1 cards in card locations 1207 and 1208.

Procedure

1. Display the cards in the database using the `rtrv-card` command. This is an example of the possible output.

```
rlghncxa03w 05-09-28 09:12:36 GMT EAGLE5 34.0.0
CARD  TYPE      APPL      LSET NAME  LINK SLC LSET NAME  LINK SLC
1101  TSM          SCCP
1102  TSM          GLS
1113  GSPM        EOAM
1114  TDM-A
1115  GSPM        EOAM
1116  TDM-B
1117  MDAL
1201  LIMV35      CCS7ITU  lsne12     A      0
1202  LIMV35      CCS7ITU  lsne12     A      1
1203  LIMV35      CCS7ITU  lsne13     A      0
1204  LIMV35      CCS7ITU  lsne13     A      1
1207  LIMT1       SS7ANSI  lsnt265    A      0
1208  LIMCH       SS7ANSI  lsnt265    A      1  lsnt265    A2     2
1211  LIME1       CCS7ITU  lsne145    A      0
1212  LIMCH       CCS7ITU  lsne145    A      1  lsne145    A2     2
1215  LIMT1       SS7ANSI  lsnt145    A      0
1216  LIMCH       SS7ANSI  lsnt145    A      1  lsnt145    A2     2
1305  LIMOCU      CCS7ITU  sp6        A      0  sp7        B      0
1306  LIMOCU      CCS7ITU  nsp3       A      0  nsp4       B      0
1307  LIMOCU      CCS7ITU  nsp1       A      0
1308  LIMOCU      CCS7ITU  nsp1       A      1
1316  ACMENET     STPLAN
1314  LIMOCU      CCS7ITU  sp7        A      1  sp5        B      0
1317  TSM          SCCP
```

NOTE: If a T1 card is being removed from the database, skip this step and go to step 3.

2. Display the signaling links on the channel card you wish to remove by entering the **rtrv-slk** command, specifying the card location shown in the **rtrv-card** command output. For this example, enter this command.

rtrv-slk:loc=1208

This is an example of the possible output.

```
rlghncxa03w 05-09-19 21:17:04 GMT EAGLE5 34.0.0
                                L2T                PCR PCR  T1  T1
LOC LINK LSN          SLC TYPE      SET BPS   ECM  N1  N2  LOC PORT TS
1208 A  lsnt265       1 LIMCH      1  56000 BASIC ---  ---- 1207 1   6
1208 A2 lsnt265       2 LIMCH      1  56000 BASIC ---  ---- 1207 1  17
```

Go to the “Removing an SS7 Signaling Link” procedure on page 3-145 to remove the signaling links assigned to the channel card.

NOTE: If only a channel card is being removed from the database, skip this step and go to step 4.

3. Display the T1 interfaces assigned to the T1 card being removed from the database using the **rtrv-t1** command with no parameters. This is an example of the possible output.

```
rlghncxa03w 05-09-19 21:17:04 GMT EAGLE5 34.0.0

LOC  T1PORT ENCODE  T1TSEL  FRAMING LL  CHANBRDG
1207  1      AMI     EXTERNAL ESF    50  -----
1215  2      B8ZS    LINE    SF     100  -----
```

Go to the “Removing the T1 Interface Parameters” procedure on page B-33 to remove the T1 interfaces assigned to the T1 card.

4. Remove the card using the **dlt-card** command. The **dlt-card** command has only one parameter, **loc**, which is the location of the card. For this example, enter these commands.

dlt-card:loc=1207

dlt-card:loc=1208

When these commands have successfully completed, this message should appear.

```
rlghncxa03w 05-09-12 09:12:36 GMT EAGLE5 34.0.0
DLT-CARD: MASP A - COMPLTD
```

5. Verify the changes using the **rtrv-card** command specifying the card that was removed in step 4. For this example, enter these commands.

rtrv-card:loc=1207

rtrv-card:loc=1208

When these commands have successfully completed, this message should appear.

```
E2144 Cmd Rej: Location invalid for hardware configuration
```

6. Back up the new changes using the **chg-db:action=backup:dest=fixed** command. These messages should appear, the active Maintenance and Administration Subsystem Processor (MASP) appears first.

```
BACKUP (FIXED) : MASP A - Backup starts on active MASP.  
BACKUP (FIXED) : MASP A - Backup on active MASP to fixed disk complete.  
BACKUP (FIXED) : MASP A - Backup starts on standby MASP.  
BACKUP (FIXED) : MASP A - Backup on standby MASP to fixed disk complete.
```

Flowchart B-2. Removing a LIM-T1 Card

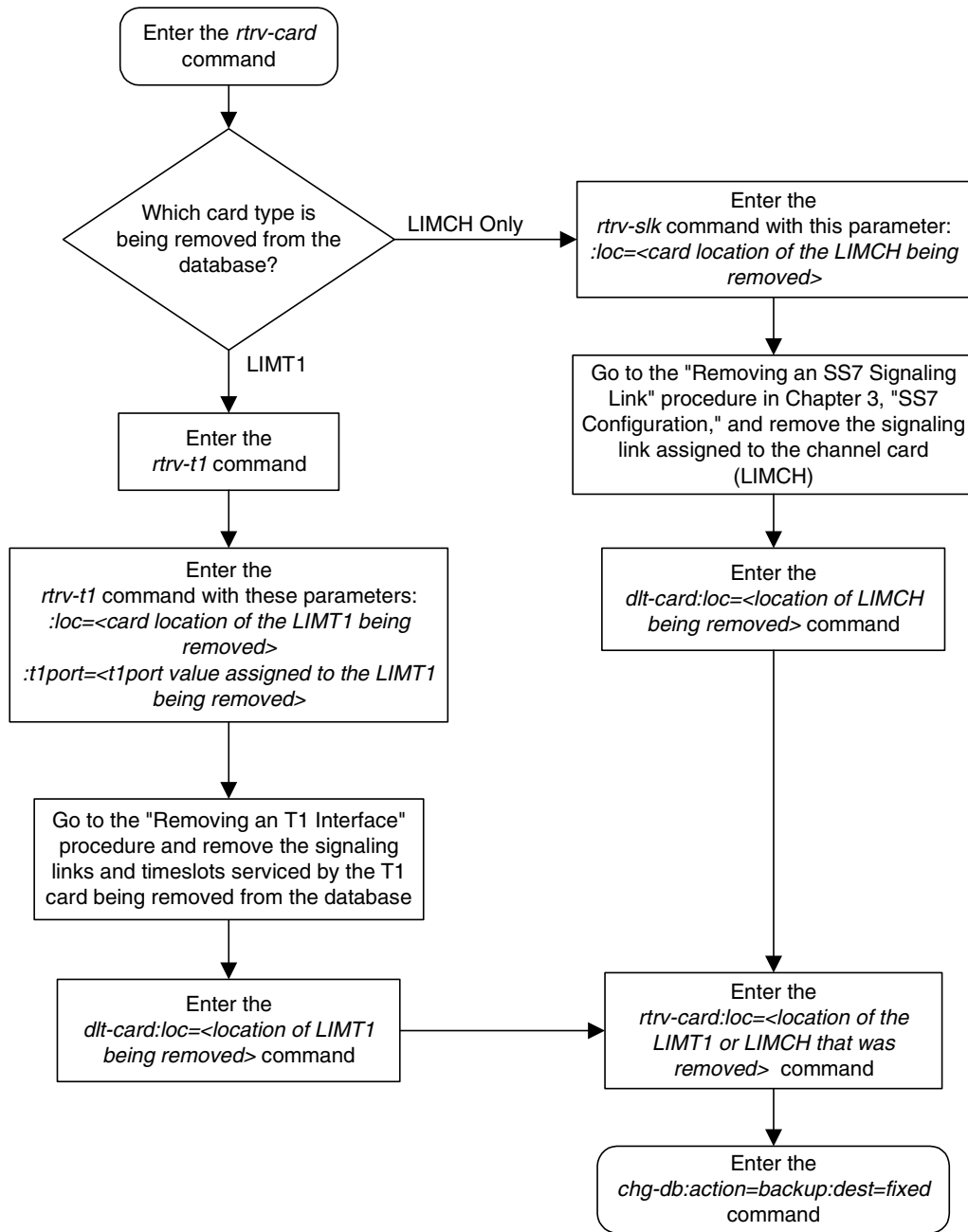

Adding the T1 Interface Parameters

The T1 interface parameters are provisioned in the database using the **ent-t1** command using these parameters.

:loc – The location of the T1 card (card type **1imt1**) that is servicing the T1 signaling link. The location of a channel card (card type **1imch**) cannot be specified for this parameter.

:t1port – The T1 port on the T1 card used to service the T1 signaling link. The **t1port** value cannot already be assigned to the T1 card specified by the **loc** parameter.

:encode – Specifies the type of encoding or decoding that is used on the T1 signaling link, either B8ZS or AMI. The default value is B8ZS encoding (**encode=b8zs**).

:t1tsel – The timing source for the T1 signaling link, master (**external**) or slave (**line**) or **recovered**. The default value is slave timing (**t1tsel=line**).

The **recovered** timing source can be used only with the **chanbrdg=on** parameter and uses the even numbered member of the bridged-pair as a clock source, ensuring that both T1 ports are using the same clock for line stability.

NOTE: To use an external high-speed master clock source other than RS-422, TDMs 870-0774-15 or later must be installed in card locations 1114 and 1116, and the TDM Global Timing Interface options must be configured. For more information, see the “Configuring the Options for the TDM Global Timing Interface” procedure on page 3-263.

:framing – Specifies the framing format to be used on the TI signaling link, either **sf** or **esf**. The default value is **sf** (**framing=sf**).

:11 – The length of the cable, in feet, used for the T1 signaling link. The value of the **11** parameter is from 0 to 655. The default value for this parameter is 133.

:chanbrdg – Specifies whether or not the odd numbered T1 port specified in this procedure is channel bridged to its adjacent even numbered T1 port. Table B-7 on page B-24 shows the T1 ports that can be specified with the **chanbrdg=on** parameter and the even-numbered T1 ports that are bridged to the odd numbered T1 port.

Table B-7. Channel Bridging Ports

Odd Numbered T1 Port	Even Numbered Bridged T1 Port
1	2
3	4
5	6
7	8

T1 Interface

:force=yes – required when the even numbered T1 port being channel bridged is provisioned in the database before this procedure is performed.

The T1 card specified in this procedure must be in the database. This can be verified with the **rtrv-card** command.

Procedure

1. Display the cards in the EAGLE 5 SAS using the **rtrv-card** command. This is an example of the possible output.

```
rlghncxa03w 05-09-28 09:12:36 GMT EAGLE5 34.0.0
CARD  TYPE      APPL      LSET NAME  LINK SLC LSET NAME  LINK SLC
1101  TSM          SCCP
1102  TSM          GLS
1113  GSPM         EOAM
1114  TDM-A
1115  GSPM         EOAM
1116  TDM-B
1117  MDAL
1201  LIMV35       CCS7ITU   lsne12     A    0
1202  LIMV35       CCS7ITU   lsne12     A    1
1203  LIMV35       CCS7ITU   lsne13     A    0
1204  LIMV35       CCS7ITU   lsne13     A    1
1207  LIMT1        SS7ANSI   lsnt265    A    0
1208  LIMCH        SS7ANSI   lsnt265    A    1  lsnt265    A2   2
1211  LIME1        CCS7ITU   lsne145    A    0
1212  LIMCH        CCS7ITU   lsne145    A    1  lsne145    A2   2
1215  LIMT1        SS7ANSI
1216  LIMCH        SS7ANSI
1305  LIMOCU       CCS7ITU   sp6         A    0    sp7         B    0
1306  LIMOCU       CCS7ITU   nsp3        A    0    nsp4        B    0
1307  LIMOCU       CCS7ITU   nsp1        A    0
1308  LIMOCU       CCS7ITU   nsp1        A    1
1316  ACMENET      STPLAN
1314  LIMOCU       CCS7ITU   sp7         A    1    sp5         B    0
1317  TSM          SCCP
```

2. Display the existing T1 interfaces in the database using the **rtrv-t1** command with no parameters. This is an example of the possible output.

```
rlghncxa03w 05-09-19 21:17:04 GMT EAGLE5 34.0.0
LOC  T1PORT ENCODE  T1TSEL  FRAMING  LL  CHANBRDG
1207  1      AMI      EXTERNAL  ESF  50  -----
```

NOTE: If the `rtrv-t1` output in step 2 shows that the T1 card has T1 ports 3, 4, 5, 6, 7, or 8 assigned to it, or that T1 ports on the T1 card are channel bridged, skip this step and go to step 4.

3. Verify whether or not the T1 card is an HC MIM. The HC MIM has part number 870-2671-01 assigned to it.

If the T1 card is an HC MIM, go to step 4.

If the T1 card is not an HC MIM, skip step 4, and go to step 5.

NOTE: If the T1 port being added in this procedure is not being channel bridged, skip step 4, and go to 5.

4. Display the T1 signaling links in the EAGLE 5 SAS by entering this command.

```
rtrv-slk:class=t1
```

This is an example of the possible output.

```
rlghncxa03w 05-09-19 21:17:04 GMT EAGLE5 34.0.0
```

LOC	LINK	LSN	SLC	TYPE	L2T SET	BPS	ECM	PCR N1	PCR N2	T1 LOC	T1 PORT	T1 TS
1207	A	lsnt256	0	LIMT1	1	56000	BASIC	---	-----	1207	2	2
1208	A	lsnt256	1	LIMCH	1	56000	BASIC	---	-----	1207	1	4
1208	A2	lsnt256	2	LIMCH	1	56000	BASIC	---	-----	1207	1	6

If an even numbered T1 port is to be channel bridged, and that T1 port is assigned to signaling links, these signaling links must be removed before the T1 port can be channel bridged. Perform the "Removing an SS7 Signaling Link" procedure on page 3-145 and remove these signaling links. After the signaling links have been removed, go to step 5.

If the even numbered T1 port to be channel bridged is not assigned to signaling links, go to step 5.

T1 Interface

5. Add the new T1 interface information to the database using the `ent-t1` command and the parameter combinations shown in Table B-8, based on the type of T1 card being used.

Table B-8. T1 Interface Parameter Combinations

E1/T1 MIM	HC MIM without Channel Bridging	HC MIM with Channel Bridging
Mandatory Parameters		
:loc=location of the T1 card	:loc=location of the T1 card	:loc=location of the T1 card
:t1port=1, 2	:t1port=1, 2, 3, 4, 5, 6, 7, 8	:t1port=1, 3, 5, 7
	:t1tsel=line, external	:t1tsel=external, recovered
		:chanbrdg=on
Optional Parameters		
:encode=ami, b8zs Default value = b8zs	:encode=ami, b8zs Default value = b8zs	:encode=ami, b8zs Default value = b8zs
:framing=sf, esf Default value = sf	:framing=sf, esf Default value = sf	:framing=sf, esf Default value = sf
:ll=0 - 655 Default value = 133	:ll=0 - 655 Default value = 133	:ll=0 - 655 Default value = 133
:t1tsel=line, external Default value = line		:force=yes (See Note)
Note: The force=yes parameter is used only when the even numbered port being channel bridged is shown in the <code>rtrv-t1</code> output in step 2.		

For this example, enter these commands.

```
ent-t1:loc=1215:t1port=2:encode=b8zs:t1tsel=line
:framing=sf:ll=100
```

When this command has successfully completed, this message should appear.

```
rlghncxa03w 05-09-12 09:12:36 GMT EAGLE5 34.0.0
ENT-T1: MASP A - COMPLTD
```

6. Verify the changes using the `rtrv-t1` command specifying the card location and the `t1port` value specified in step 5. For this example, enter these commands.

```
rtrv-t1:loc=1215:t1port=2
```

This is an example of the possible output.

```
rlghncxa03w 05-09-28 09:12:36 GMT EAGLE5 34.0.0
```

LOC	T1PORT	ENCODE	T1TSEL	FRAMING	LL	CHANBRDG
1215	2	B8ZS	LINE	SF	100	-----
TS0	(N/A)	TS8	-----	TS16	-----	
TS1	-----	TS9	-----	TS17	-----	
TS2	-----	TS10	-----	TS18	-----	
TS3	-----	TS11	-----	TS19	-----	
TS4	-----	TS12	-----	TS20	-----	
TS5	-----	TS13	-----	TS21	-----	
TS6	-----	TS14	-----	TS22	-----	
TS7	-----	TS15	-----	TS23	-----	

7. Backup the new changes using the `chg-db:action=backup:dest=fixed` command. These messages should appear, the active Maintenance and Administration Subsystem Processor (MASP) appears first.

```
BACKUP (FIXED) : MASP A - Backup starts on active MASP.
BACKUP (FIXED) : MASP A - Backup on active MASP to fixed disk complete.
BACKUP (FIXED) : MASP A - Backup starts on standby MASP.
BACKUP (FIXED) : MASP A - Backup on standby MASP to fixed disk complete.
```

Flowchart B-3. Adding the T1 Interface Parameters (Sheet 1 of 4)

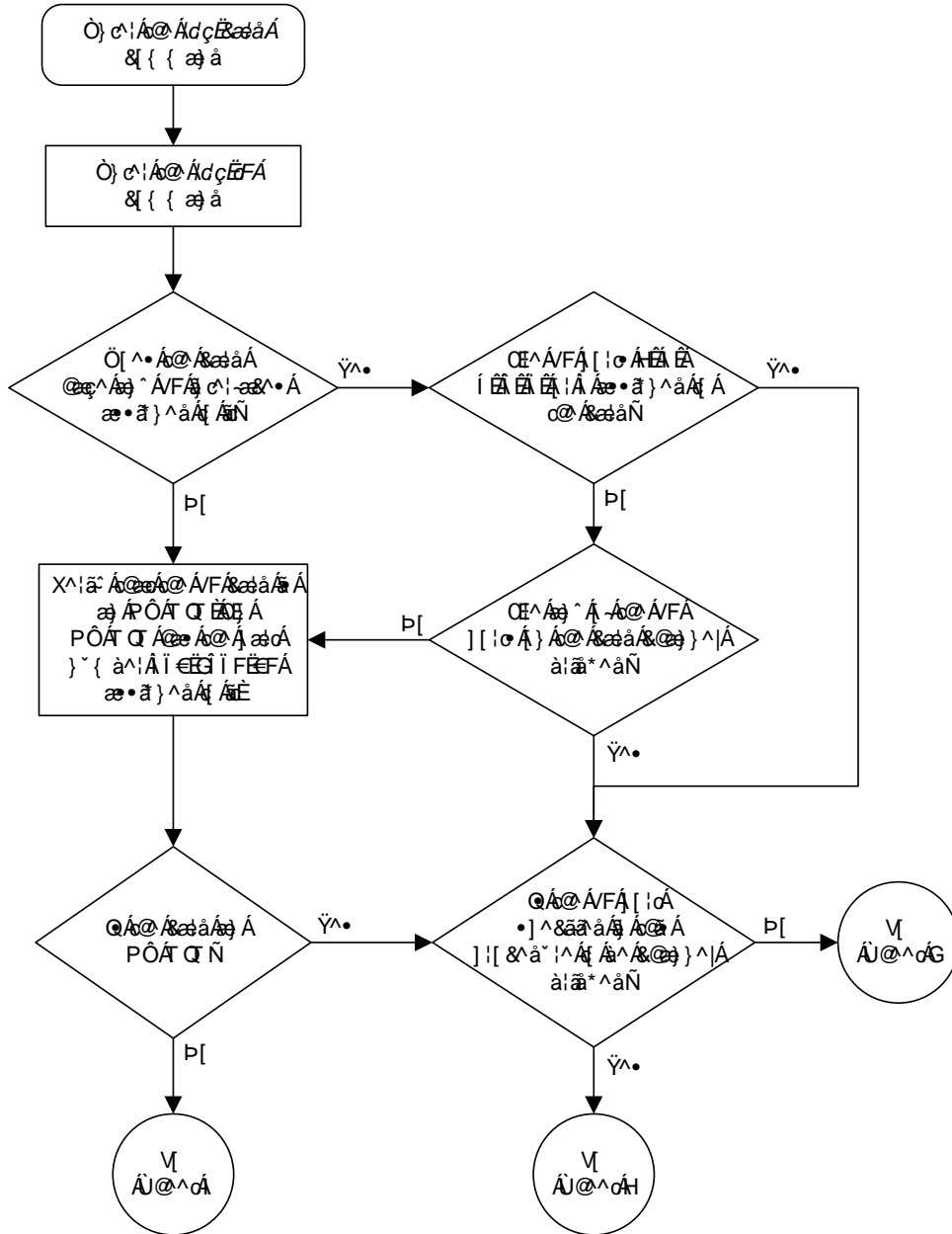

Flowchart B-3. Adding the T1 Interface Parameters (Sheet 2 of 4)

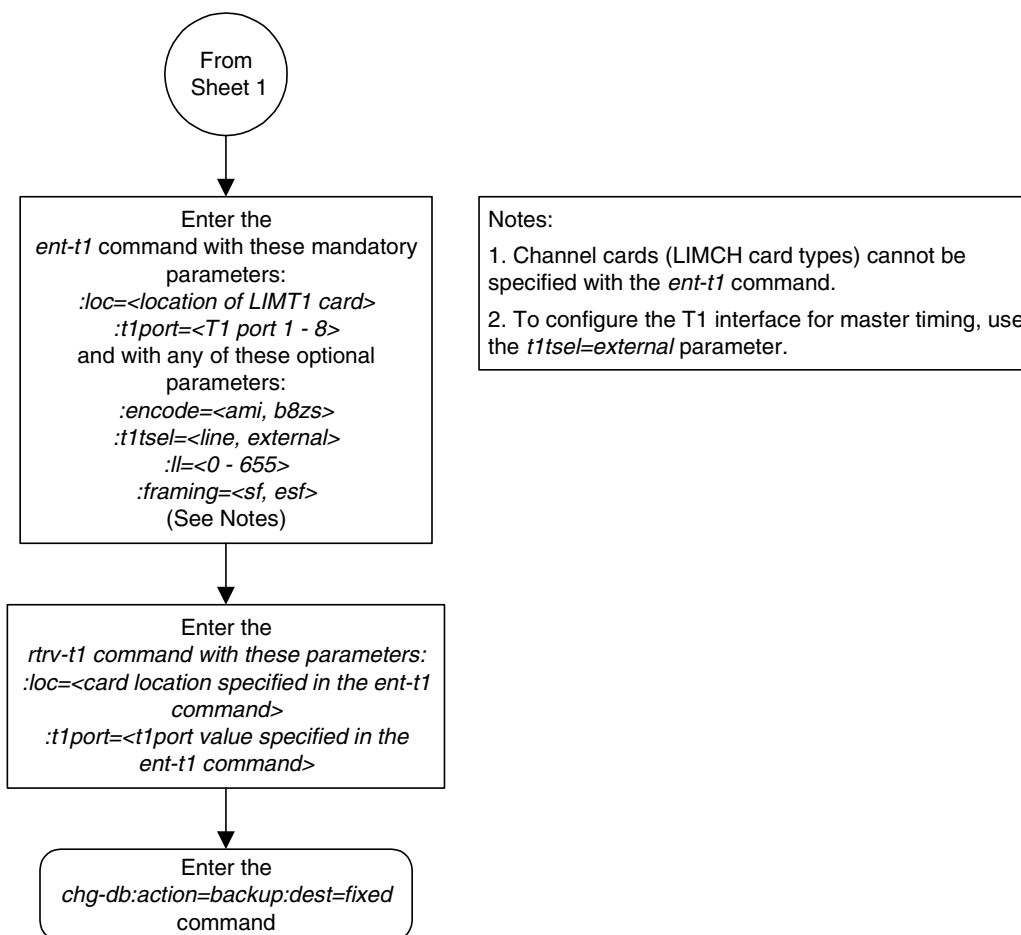

Flowchart B-3. Adding the T1 Interface Parameters (Sheet 3 of 4)

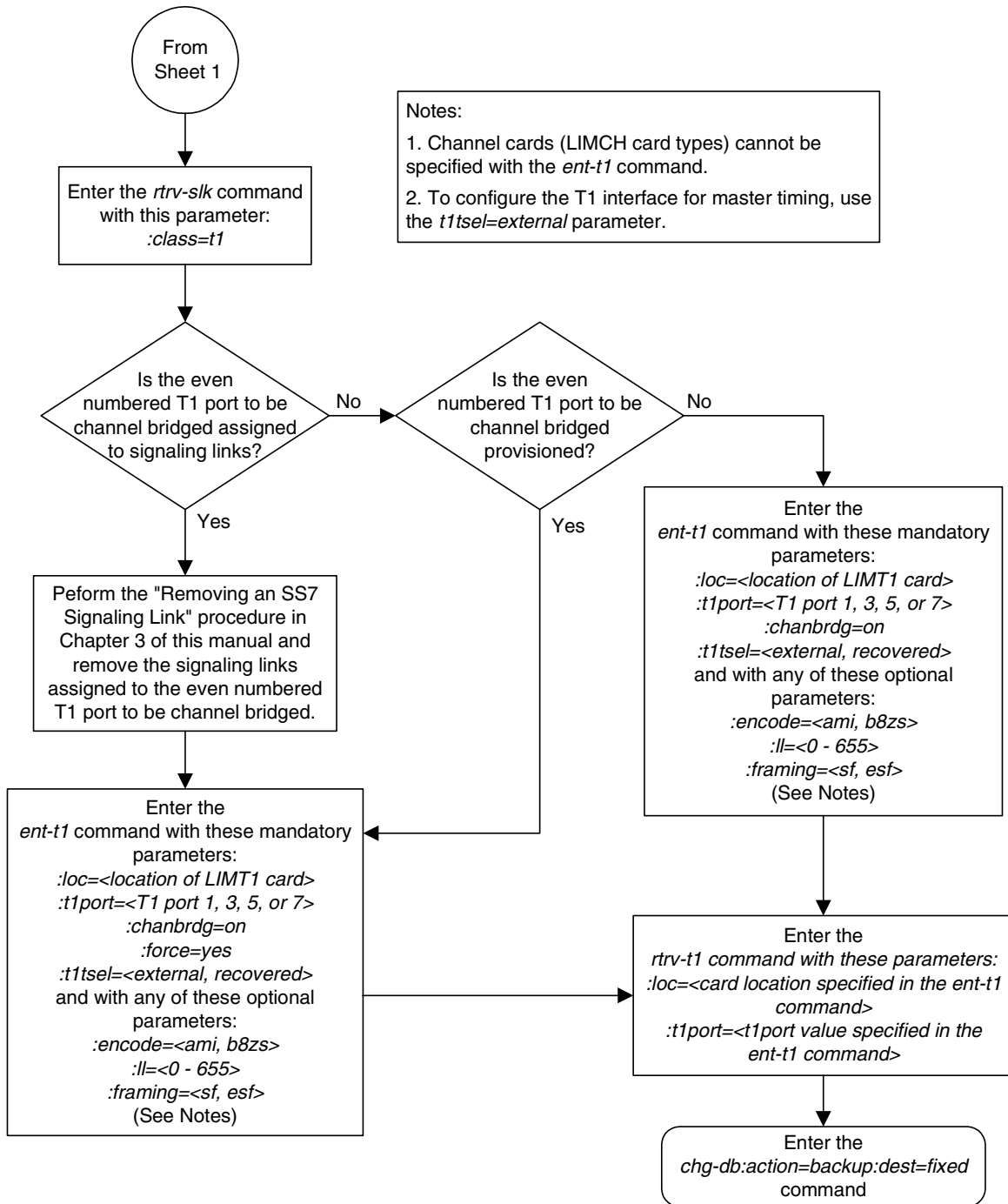

Flowchart B-3. Adding the T1 Interface Parameters (Sheet 4 of 4)

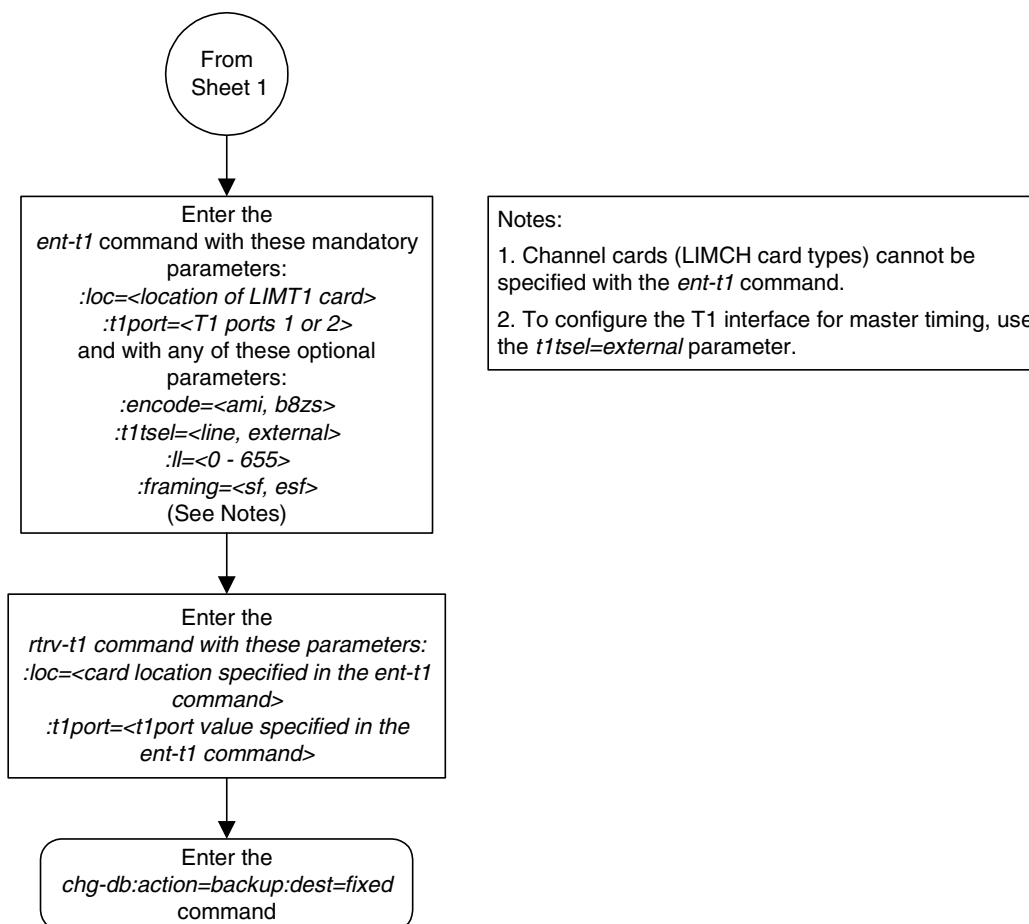

Removing the T1 Interface Parameters

This procedure is used to remove a T1 interface from the database using the **dlt-t1** command using these parameters.

:loc – The location of the T1 card (card type **limt1**) containing the T1 interface being removed.

:t1port – The T1 port on the T1 card containing the T1 interface being removed.

The T1 interface to be removed must exist in the database. This can be verified in step 1.

To remove the T1 interface information contained on a T1 card, all signaling links serviced by that T1 card must be removed from the database. This can be verified with the **rtrv-t1** command, specifying the card location and T1PORT on the T1 card, and the **rtrv-slk** command, specifying the location of any cards (T1 or channel cards) shown in the **rtrv-t1** output. If there are any signaling links being serviced by the T1 card, go to the “Removing an SS7 Signaling Link” procedure on page 3-145 and remove these signaling links.

Even numbered T1 ports cannot be removed if the even numbered T1 port is channel bridged. Remove the corresponding odd numbered T1 port (see Table B-7 on page B-24) to remove the even numbered channel bridged T1 port.

Procedure

1. Display the existing T1 interfaces in the database using the **rtrv-t1** command with no parameters. This is an example of the possible output.

```
rlghncxa03w 05-09-19 21:17:04 GMT EAGLE5 34.0.0
```

LOC	T1PORT	ENCODE	T1TSEL	FRAMING	LL	CHANBRDG
1207	1	AMI	EXTERNAL	ESF	50	-----
1215	2	B8ZS	LINE	SF	100	-----

If the T1 port being removed is an even numbered T1 port and is channel bridged, select the corresponding odd numbered T1 port to remove (see Table B-7 on page B-24) and go to step 2.

If the even numbered T1 port is not channel bridged, it can be removed with the **dlt-t1** command. go to step 2.

2. Display the timeslots that are serviced by the T1 card containing the T1 interface information to be removed using the **rtrv-t1** command specifying the card location and the **t1port** value from step 1. For this example, enter this command.

```
rtrv-t1:loc=1207:t1port=1
```

This is an example of the possible output.

```
rlghncxa03w 05-09-28 09:12:36 GMT EAGLE5 34.0.0

LOC   T1PORT ENCODE  T1TSEL   FRAMING  LL   CHANBRDG
1207  1       AMI      EXTERNAL ESF      50   -----

TS0   (N/A)   TS8      ----- TS16     -----
TS1   ----- TS9      ----- TS17     1208,A2
TS2   1207,A TS10     ----- TS18     -----
TS3   ----- TS11     ----- TS19     -----
TS4   ----- TS12     ----- TS20     -----
TS5   ----- TS13     ----- TS21     -----
TS6   1208,A TS14     ----- TS22     -----
TS7   ----- TS15     ----- TS23     -----
```

If this step shows any timeslots that are serviced by the T1 card, go to the “Removing an SS7 Signaling Link” procedure on page 3-145 and remove the timeslots and signaling links serviced by the T1 card.

-
3. Remove the T1 interface information to the database using the **dlt-t1** command specifying the card location of the T1 card and the T1 port on that card. For this example, enter these commands.

```
dlt-t1:loc=1207:t1port=1
```

When this command has successfully completed, this message should appear.

```
rlghncxa03w 05-09-12 09:12:36 GMT EAGLE5 34.0.0
DLT-T1: MASP A - COMPLTD
```

-
4. Verify the changes using the **rtrv-t1** command with no parameters. This is an example of the possible output.

```
rlghncxa03w 05-09-19 21:17:04 GMT EAGLE5 34.0.0

LOC   T1PORT ENCODE  T1TSEL   FRAMING  LL   CHANBRDG
1215  2       B8ZS    LINE     SF       100  -----
```

-
5. Backup the new changes using the **chg-db:action=backup:dest=fixed** command. These messages should appear, the active Maintenance and Administration Subsystem Processor (MASP) appears first.

```
BACKUP (FIXED) : MASP A - Backup starts on active MASP.
BACKUP (FIXED) : MASP A - Backup on active MASP to fixed disk complete.
BACKUP (FIXED) : MASP A - Backup starts on standby MASP.
BACKUP (FIXED) : MASP A - Backup on standby MASP to fixed disk complete.
```

Flowchart B-4. Removing the T1 Interface Parameters

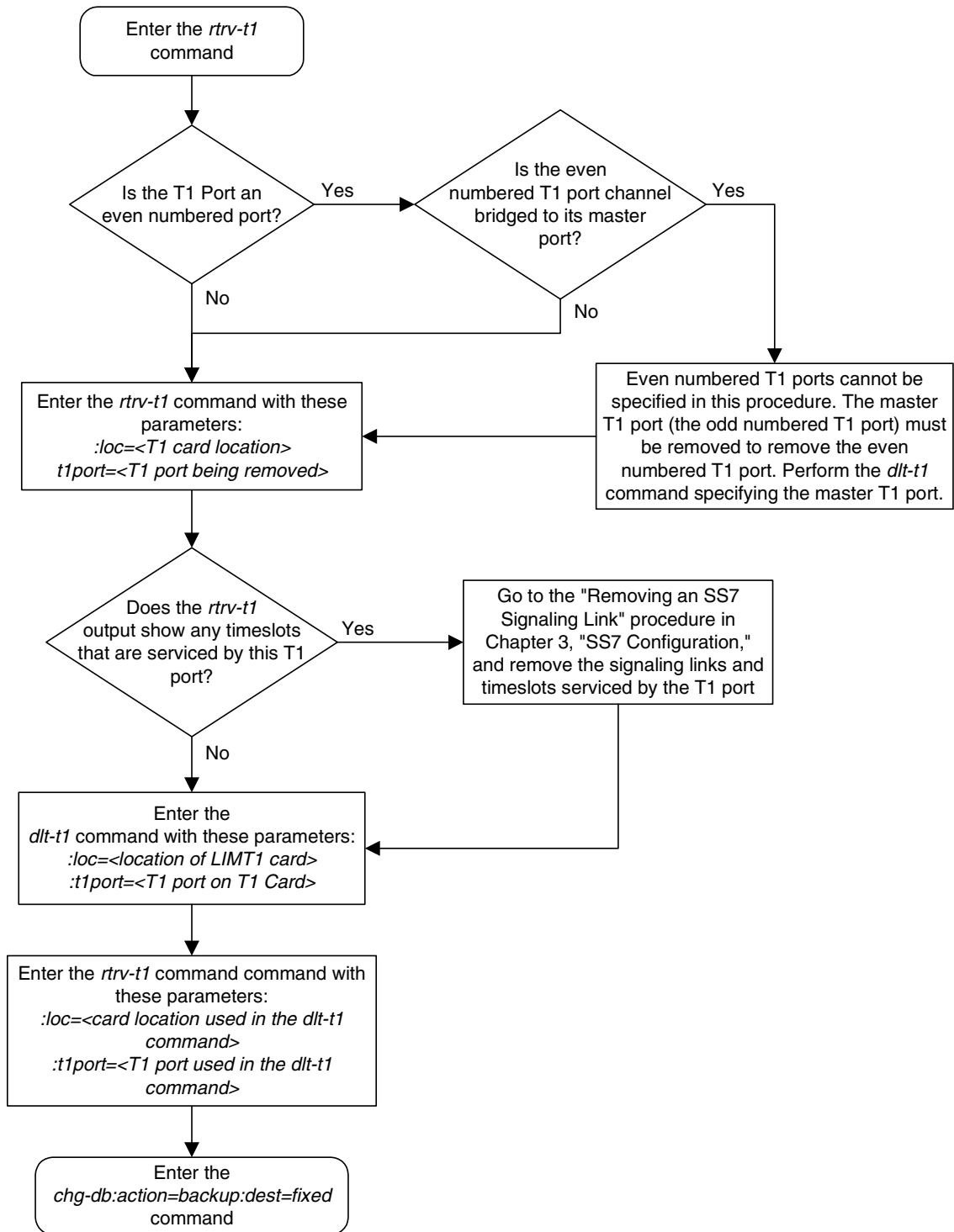

Changing the T1 Interface Parameters

This procedure is used to change the existing T1 interface parameters using the `chg-t1` command using these parameters.

:loc – The location of the T1 card (card type `1imt1`) that is servicing the T1 signaling link. The location of a channel card (card type `1imch`) cannot be specified for this parameter.

:t1port – The T1 port on the T1 card used to service the T1 signaling link. The `t1port` value cannot already be assigned to the T1 card specified by the `loc` parameter.

:encode – Specifies the type of encoding or decoding that is used on the T1 signaling link, either B8ZS or AMI.

:t1tsel – The timing source for the T1 signaling link, master (`external`) or slave (`line`), or `recovered`.

The `recovered` timing source can be used only with the `chanbrdg=on` parameter and uses the even numbered member of the bridged-pair as a clock source, ensuring that both T1 ports are using the same clock for line stability.

NOTE: To use an external high-speed master clock source other than RS-422, TDMs 870-0774-15 or later must be installed in card locations 1114 and 1116, and the TDM Global Timing Interface options must be configured. For more information, see the “Configuring the Options for the TDM Global Timing Interface” procedure on page 3-263.

:framing – Specifies the framing format to be used on the T1 signaling link, either `sf` or `esf`.

:11 – The length of the cable, in feet, used for the T1 signaling link. The value of the `11` parameter is from 0 to 655.

:chanbrdg – Specifies whether or not the odd numbered T1 port specified in this procedure is channel bridged to its adjacent even numbered T1 port. Table B-9 on page B-36 shows the T1 ports that can be specified with the `chanbrdg=on` parameter and the even-numbered T1 ports that are bridged to the odd numbered T1 port.

Table B-9. Channel Bridging Ports

Odd Numbered T1 Port	Even Numbered Bridged T1 Port
1	2
3	4
5	6
7	8

T1 Interface

:force=yes – required when the even numbered T1 port being channel bridged is provisioned in the database before this procedure is performed.

The T1 card specified in this procedure must be in the database. This can be verified with the **rtrv-card** command.

The signaling links serviced by the T1 card must be taken out of service before any changes can be made to the T1 interface parameters.

Procedure

1. Display the existing T1 interfaces in the database using the **rtrv-t1** command with no parameters. This is an example of the possible output.

```
rlghncxa03w 05-09-19 21:17:04 GMT EAGLE5 34.0.0

LOC  T1PORT ENCODE  T1TSEL   FRAMING  LL   CHANBRDG
1207  1       AMI      EXTERNAL ESF      50   -----
1215  2       B8ZS    LINE     SF       100  -----
```

2. Display the timeslots that are serviced by the T1 card containing the T1 interface information to be changed using the **rtrv-t1** command specifying the card location and the **t1port** value from step 1. For this example, enter this command.

rtrv-t1:loc=1215:t1port=2

This is an example of the possible output.

```
rlghncxa03w 05-09-28 09:12:36 GMT EAGLE5 34.0.0

LOC  T1PORT ENCODE  T1TSEL   FRAMING  LL   CHANBRDG
1215  2       B8ZS    LINE     SF       50   -----

TS0  (N/A)   TS8     -----  TS16    -----
TS1  -----  TS9     -----  TS17    -----
TS2  -----  TS10    1215,A  TS18    -----
TS3  -----  TS11    -----  TS19    -----
TS4  -----  TS12    -----  TS20    1216,A2
TS5  -----  TS13    -----  TS21    -----
TS6  -----  TS14    1216,A  TS22    -----
TS7  -----  TS15    -----  TS23    -----
```

3. Check the status of the signaling links shown in step 2 using the **rept-stat-slk** command with the card location and signaling link. For this example, enter these commands.

rept-stat-slk:loc=1215:link=a

This is an example of the possible output.

```
rlghncxa03w 05-09-23 13:06:25 GMT EAGLE5 34.0.0
SLK   LSN      CLLI      PST      SST      AST
1215,A lsnt145  -----  IS-NR    Avail    ----
ALARM STATUS      = No Alarms
UNAVAIL REASON    = --
T1 status         = 1215, RCVRY-T1F:FAC-T1 Port 2 available
```

```
rept-stat-slk:loc=1216:link=a
```

This is an example of the possible output.

```
rlghncxa03w 05-09-23 13:06:25 GMT EAGLE5 34.0.0
SLK      LSN      CLLI      PST      SST      AST
1216,A  lsnt145  -----  IS-NR      Avail  ----
  ALARM STATUS      = No Alarms
  UNAVAIL REASON    = --
  T1 status          = 1215, RCVRY-T1F:FAC-T1 Port 1 available
```

```
rept-stat-slk:loc=1216:link=a2
```

This is an example of the possible output.

```
rlghncxa03w 05-09-23 13:06:25 GMT EAGLE5 34.0.0
SLK      LSN      CLLI      PST      SST      AST
1216,A2 lsnt145  -----  IS-NR      Avail  ----
  ALARM STATUS      = No Alarms
  UNAVAIL REASON    = --
  T1 status          = 1215, RCVRY-T1F:FAC-T1 Port 1 available
```

4. Deactivate the signaling links shown in step 3 using the `dact-slk` command. For this example, enter these commands.

```
dact-slk:loc=1215:link=a
```

```
dact-slk:loc=1216:link=a
```

```
dact-slk:loc=1216:link=a2
```

When each of these commands have successfully completed, this message should appear.

```
rlghncxa03w 05-09-07 08:41:12 GMT EAGLE5 34.0.0
Deactivate Link message sent to card
```

NOTE: If the `chanbrdg` value will be changed to `off`, skip steps 5 and 6, and go to step 7.

5. If T1 ports 3, 4, 5, 6, 7, or 8 are not assigned to the T1 card, verify that the card is an HC MIM. Only T1 ports assigned to HC MIM cards can be channel bridged. If the T1 card is an HC MIM, go to step 6.

If the T1 card is not an HC MIM, the T1 port cannot be channel bridged. Go back to step 1 and perform this procedure again. If there are no HC MIMs in the database, go to step 7 and change other parameters for this T1 port.

If T1 ports 3, 4, 5, 6, 7, or 8 are assigned to the T1 card, the T1 card is an HC MIM. Go to step 6.

T1 Interface

NOTE: If the adjacent T1 port (see Table B-9 on page B-36) is not shown in the `rtrv-t1` output in step 1, or if the `chanbrdg` value is not being changed, skip this step and go to step 7.

6. Display the T1 signaling links in the database by entering this command.

```
rtrv-slk:class=t1
```

This is an example of the possible output.

```
rlghncxa03w 05-09-19 21:17:04 GMT EAGLE5 34.0.0
```

LOC	LINK	LSN	SLC	TYPE	L2T SET	BPS	ECM	PCR N1	PCR N2	T1 LOC	T1 PORT	TS
1207	A	lsnt256	0	LIMT1	1	56000	BASIC	---	-----	1207	2	2
1208	A	lsnt256	1	LIMCH	1	56000	BASIC	---	-----	1207	1	4
1208	A2	lsnt256	2	LIMCH	1	56000	BASIC	---	-----	1207	1	6

If an even numbered T1 port is to be channel bridged, and that T1 port is assigned to signaling links, these signaling links must be removed before the T1 port can be channel bridged. Perform the “Removing an SS7 Signaling Link” procedure on page 3-145 and remove these signaling links. After the signaling links have been removed, go to step 7.

If the even numbered T1 port to be channel bridged is not assigned to signaling links, go to step 7.

7. Change the T1 interface information using the `chg-t1` command and the parameter combinations shown in Table B-10, based on the type of T1 card being used.

Table B-10. T1 Interface Parameter Combinations

E1/T1 MIM	HC MIM	
Mandatory Parameters		
:loc=location of the T1 card	:loc=location of the T1 card	:loc=location of the T1 card
:t1port=T1 port being changed, either 1 or 2	:t1port=T1 port being changed, either 1, 2, 3, 4, 5, 6, 7, or 8 ¹	:t1port=T1 port being changed, either 1, 3, 5, or 7
Optional Parameters		
:encode=ami, b8zs	:encode=ami, b8zs	:encode=ami, b8zs
:ll=0 - 655	:ll=0 - 655	:ll=0 - 655
:framing=sf, esf	:framing=sf, esf	:framing=sf, esf
:t1tsel=line, external	:t1tsel=line, external	:t1tsel=external, recovered
	:chanbrdg=off	:chanbrdg=on
		:force=yes ²

Table B-10. T1 Interface Parameter Combinations

E1/T1 MIM	HC MIM
Notes: 1. If the current T1 port is channel bridged, the t1port value can either 1, 3, 5, or 7. 2. The force=yes parameter is used only when the even numbered port being channel bridged is shown in the rtrv-t1 output in step 1.	

For this example, enter this command.

```
chg-t1:loc=1215:t1port=2:encode=ami:framing=esf
```

When this command has successfully completed, this message should appear.

```
rlghncxa03w 05-09-12 09:12:36 GMT EAGLE5 34.0.0
ENT-T1: MASP A - COMPLTD
```

8. Verify the changes using the **rtrv-t1** command specifying the card location and the **t1port** value specified in step 7. For this example, enter these commands.

```
rtrv-t1:loc=1215:t1port=2
```

This is an example of the possible output.

```
rlghncxa03w 05-09-28 09:12:36 GMT EAGLE5 34.0.0

LOC   T1PORT ENCODE  T1TSEL   FRAMING  LL   CHANBRDG
1215  2       AMI      LINE     ESF       100  -----

TS0   (N/A)   TS8      -----  TS16      -----
TS1   -----  TS9      -----  TS17      -----
TS2   -----  TS10     1215,A   TS18      -----
TS3   -----  TS11     -----  TS19      -----
TS4   -----  TS12     -----  TS20     1216,A2
TS5   -----  TS13     -----  TS21      -----
TS6   -----  TS14     1216,A   TS22      -----
TS7   -----  TS15     -----  TS23      -----
```

NOTE: If the signaling links were not deactivated in step 4, skip this step and go to step 10.

9. Activate the signaling links that were deactivated in step 4 using the **act-slk** command. For this example, enter these commands.

```
act-slk:loc=1215:link=a
```

```
act-slk:loc=1216:link=a
```

```
act-slk:loc=1216:link=a2
```

When each of these commands have successfully completed, this message should appear.

```
rlghncxa03w 05-09-07 08:41:12 GMT EAGLE5 34.0.0
Activate Link message sent to card
```

- Backup the new changes using the `chg-db:action=backup:dest=fixed` command. These messages should appear, the active Maintenance and Administration Subsystem Processor (MASP) appears first.

```

BACKUP (FIXED) : MASP A - Backup starts on active MASP.
BACKUP (FIXED) : MASP A - Backup on active MASP to fixed disk complete.
BACKUP (FIXED) : MASP A - Backup starts on standby MASP.
BACKUP (FIXED) : MASP A - Backup on standby MASP to fixed disk complete.
    
```

Flowchart B-5. Changing the T1 Interface Parameters (Sheet 1 of 6)

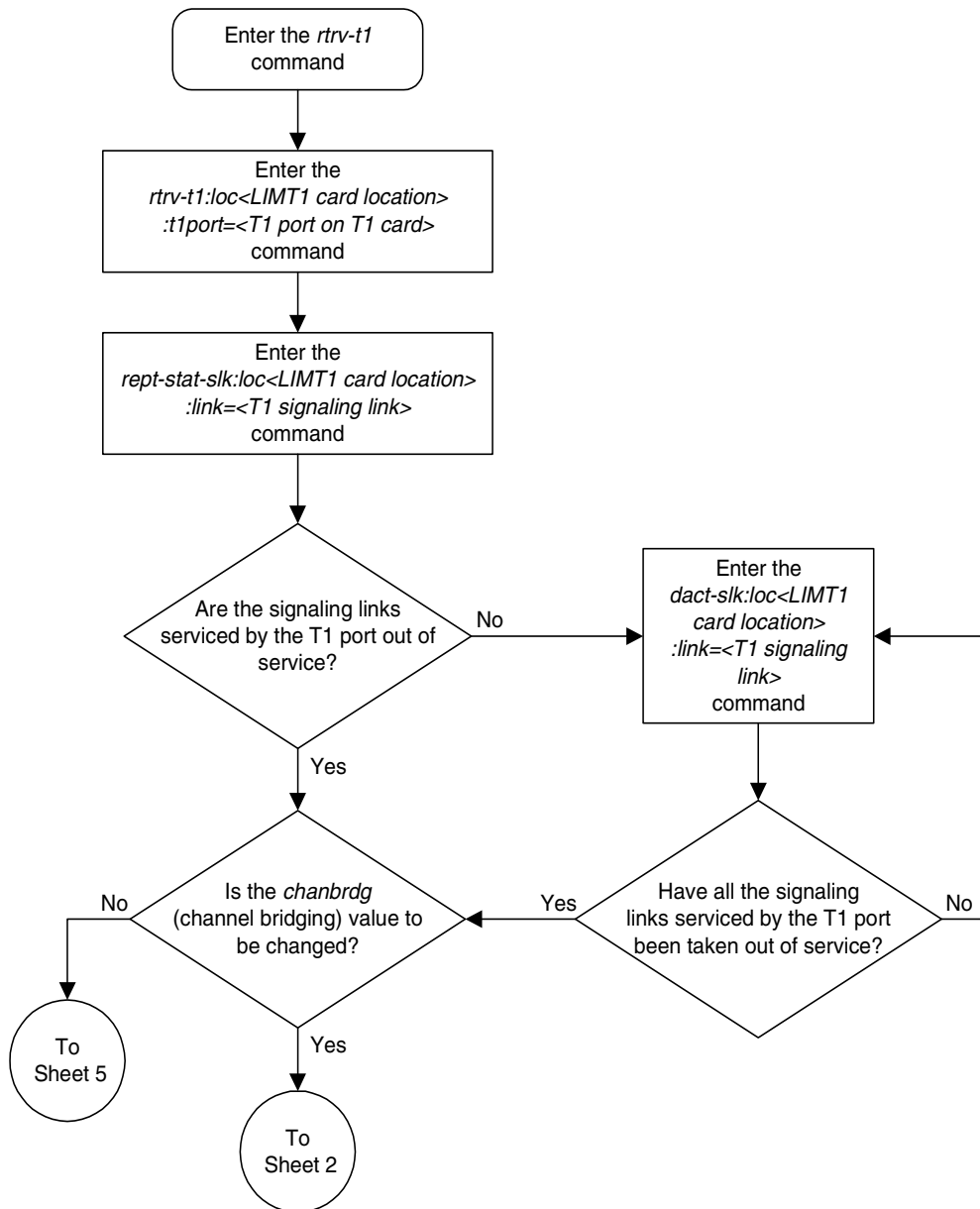

Flowchart B-5. Changing the T1 Interface Parameters (Sheet 3 of 6)

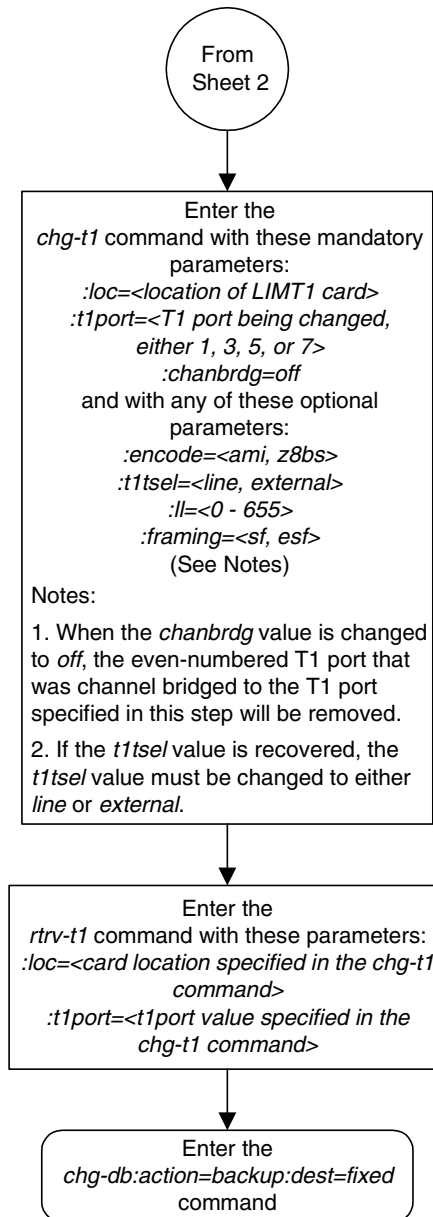

Flowchart B-5. Changing the T1 Interface Parameters (Sheet 4 of 6)

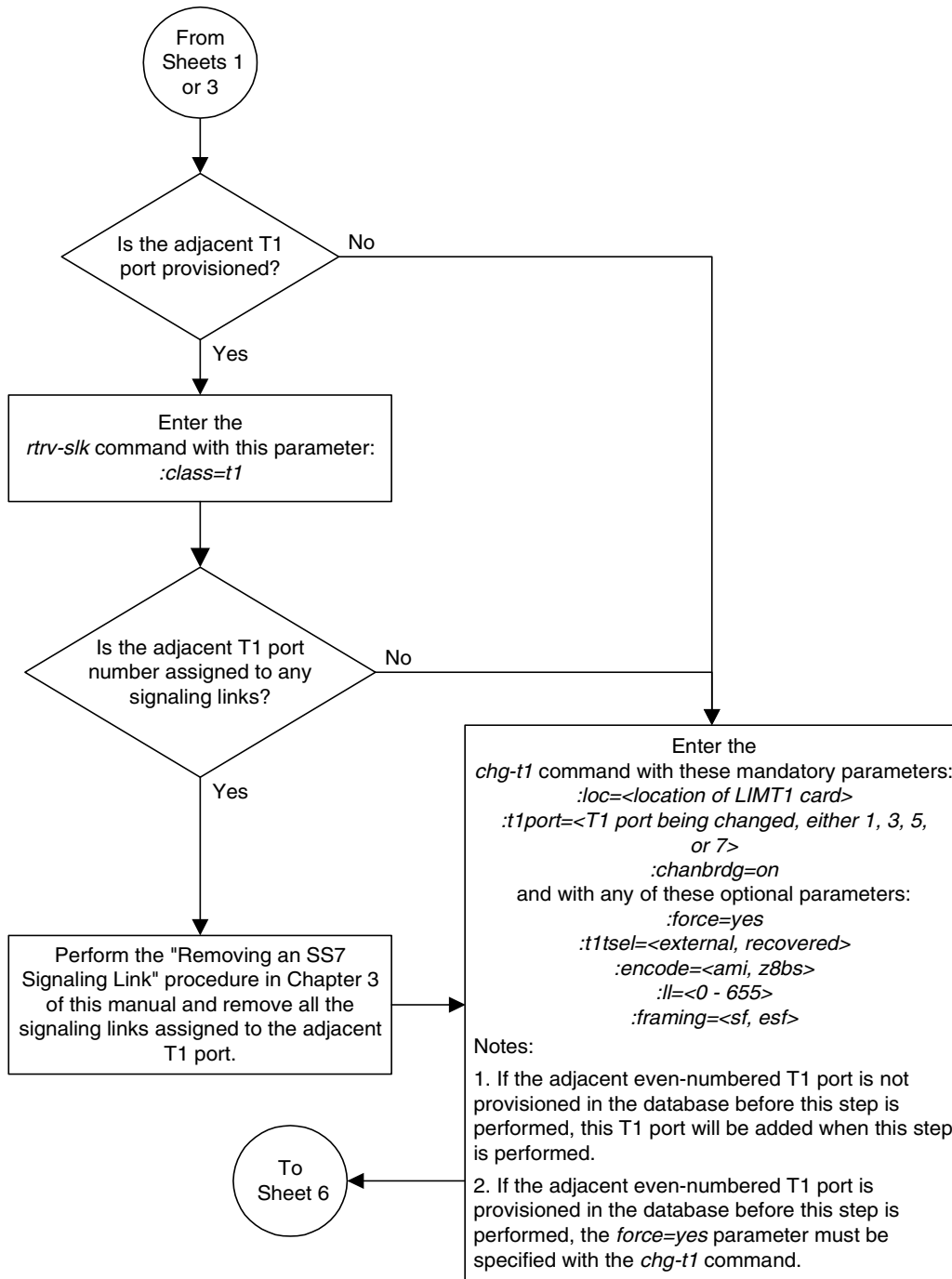

Flowchart B-5. Changing the T1 Interface Parameters (Sheet 5 of 6)

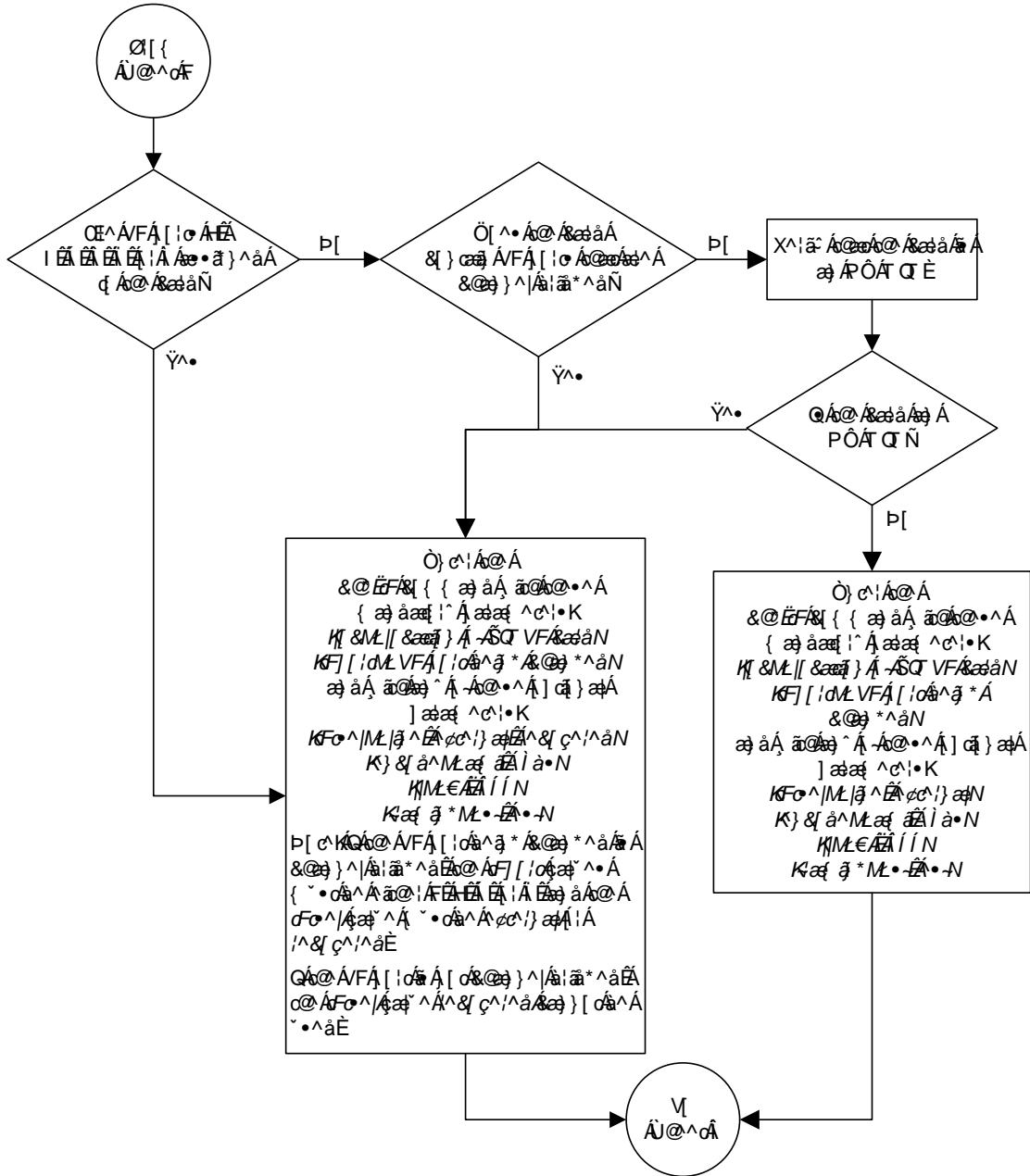

Flowchart B-5. Changing the T1 Interface Parameters (Sheet 6 of 6)

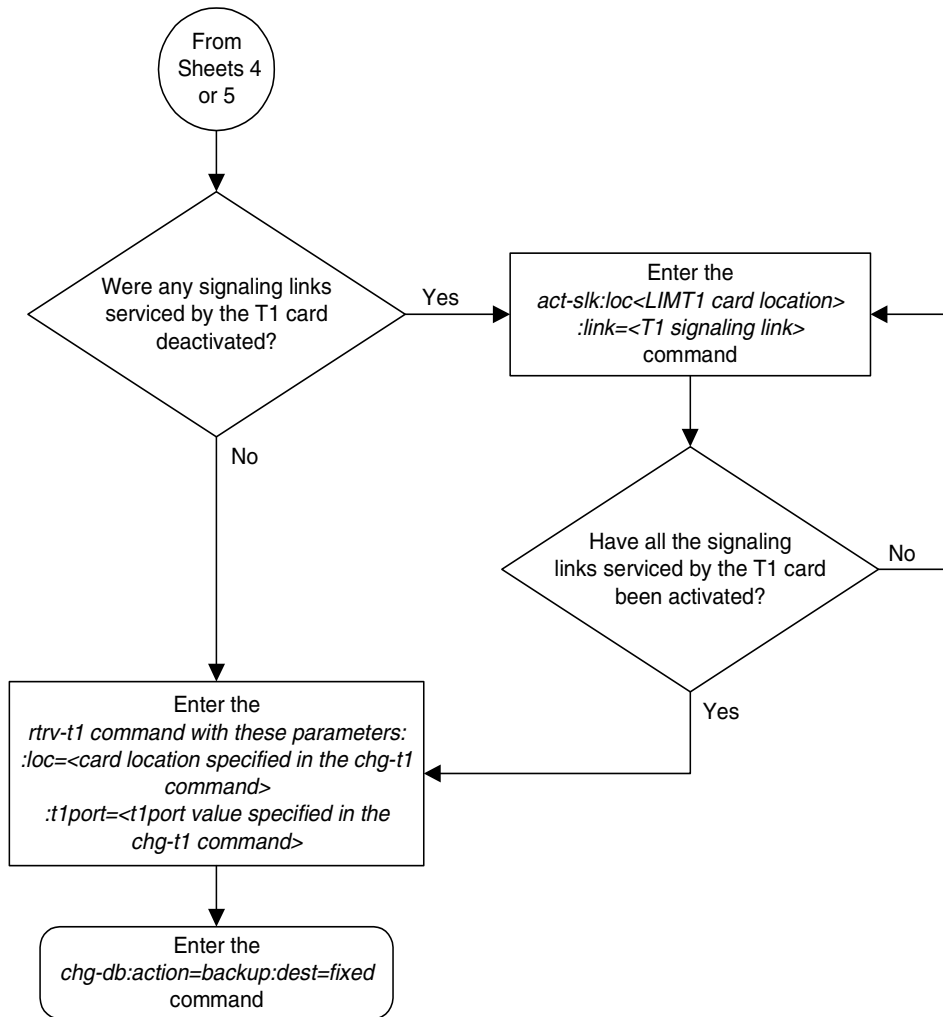

Adding a T1 Signaling Link

This procedure is used to add a T1 signaling link to the database using the **ent-slk** command and these parameters.

:loc – The card location of the card that the T1 signaling link will be assigned to.

:link – The signaling link on the card specified in the **loc** parameter.

:lsn – The name of the linkset that will contain the signaling link.

:slc – The signaling link code. The SLC must be unique within the linkset. It must be the same at both the EAGLE 5 SAS location and the distant node.

:bps – The transmission rate for the link in bits per second.

:ecm – Error correction method, either **basic** or **pcr**. The default value for this parameter is **basic**.

:pcrn1 – The threshold of the number of MSUs available for retransmission. If the error correction method being used is PCR (**:ecm=pcr**), and this threshold is reached, no new MSUs or FISUs are sent. The retransmission cycle is continued up to the last MSU entered into the retransmission buffer in the order in which they were originally transmitted.

:pcrn2 – The threshold of the number of MSU octets available for retransmission. If the error correction method being used is PCR (**:ecm=pcr**), and this threshold is reached, no new MSUs or FISUs are sent. The retransmission cycle is continued up to the last MSU entered into the retransmission buffer in the order in which they were originally transmitted.

:ts – The timeslot on the T1 card or channel card being used for the T1 signaling link.

:t1port – The T1 port on the T1 card that is servicing the timeslot selected for the T1 signaling link.

:t1loc – The location of the T1 card servicing the timeslot selected for the T1 signaling link. This parameter can be specified only when provisioning T1 signaling links on channel cards.

:l2tset – The level 2 timer set table assigned to the T1 signaling link. The type of linkset the T1 signaling link is assigned to and the T1 card's application determines the value of the **l2tset** parameter. The level 2 timer set tables are defined in the "Changing Level 2 Timers" procedure on page 3-219. Table B-11 shows the **l2tset** parameter values.

Table B-11. L2TSET Parameter Values

Type of Linkset	T1 Card's Application	L2TSET Parameter Value	L2TSET Parameter Default Value
ANSI linkset – Shown by this label in the <code>rtrv-ls</code> output. LSN APCA (SS7)	SS7ANSI	1 - 10	1
ITU linkset – Shown by one of these labels in the <code>rtrv-ls</code> output. LSN APCI (SS7) LSN APCN (SS7) LSN APCN24 (SS7)	CCS7ITU	11 - 20	11
ITU-N high-speed linkset for China – Shown by one of these labels in the <code>rtrv-ls</code> output. LSN (CHINA) APCN (SS7) LSN (CHINA) APCN24 (SS7)	CCS7ITU	21 - 25	21
ITU-N high-speed linkset for countries other than China – Shown by one of these labels in the <code>rtrv-ls</code> output. LSN APCN (SS7) LSN APCN24 (SS7)	CCS7ITU	26 - 30	26

The `ent-slk` command contains other optional parameters that can be used to configure a signaling link. These parameters are not shown here because they are not necessary to provision a T1 signaling link. These parameters are explained in more detail in the “Adding an SS7 Signaling Link” procedure on page 3-130, or in the `ent-slk` command description in the *Commands Manual*.

These items must be configured in the database before a T1 signaling link can be added:

- Shelf – see “Adding a Shelf” in the *Database Administration Manual - System Management*
- T1 Card (card type `limt1`) or Channel Card (card type `limch`) running either the `ss7ansi` or `ccs7itu` applications – see “Adding a LIM-T1 Card” procedure on page B-11
- Destination Point Code – see the “Adding a Destination Point Code” procedure on page 2-191.
- Linkset – “Adding an SS7 Linkset” procedure on page 3-17.

Verify that the link has been physically installed (all cable connections have been made).

T1 Interface

T1 port 2 (`t1port=2`) cannot be specified when the T1 signaling link is assigned to a channel card (card type `1imch`).

The value of the `bps` parameter must be either 56000 or 64000.

The values for the `ts` parameter must be from 1 to 24.

The linkset must be in the database. The number of signaling links in a linkset cannot exceed 16. This can be verified with the `rtrv-ls` command.

The APC of the linkset assigned to the signaling link must be in the SS7 domain. Use the `rtrv-dstn` command to verify the domain of the APC of the linkset.

The `pcrn1` or `pcrn2` parameters can only be specified if the `ecm=pcr` parameter is specified.

If the T1 signaling link is being assigned to a channel bridged T1 port (shown by the entries `MASTER` or `SLAVE` in the `CHANBRDG` field in the `rtrv-t1` output), the T1 port value for the signaling link must be the odd numbered (`MASTER`) T1 port.

If the T1 card is an E1/T1 MIM, a maximum of 8 T1 signaling links can be assigned to the card. The range of `link` parameter values is dependent on the type of T1 card the signaling link is assigned to. The `link` parameter values for T1 signaling links assigned to E1/T1 MIMs are A - A3, or B - B3, allowing a maximum of 8 signaling links on the card.

If the T1 card is an HC MIM, a maximum of 64 T1 signaling links can be assigned to the card. The `link` parameter values for T1 signaling links assigned to HC MIMs are A - A31, or B - B31.

To configure the EAGLE 5 SAS to perform circular routing detection test on the signaling links, "Configuring Circular Route Detection" procedure on page 3-231.

NOTE: Circular route detection is not supported in ITU networks.

To provision a EAGLE 5 SAS with more than 700 signaling links, the EAGLE 5 SAS must have certain levels of hardware installed. See the "Requirements for EAGLE 5 SASs Containing more than 700 Signaling Links" section on page D-2 for more information on these hardware requirements.

The EAGLE 5 SAS can contain a mixture of low-speed, E1, T1, ATM high-speed, and IP signaling links. The "Determining the Number of High-Speed and Low-Speed Signaling Links" section on page D-2 describes how to determine the quantities of the different types of signaling links the EAGLE 5 SAS can have.

Example Signaling Link Configuration

This examples used in this procedure are based on Tables B-12.

Table B-12. T1 Signaling Link Configuration Table

SLK		LSN	SLC	TYPE	BPS	TS	T1PORT	T1LOC
LOC	LINK							
1215	A	LSNT145	0	LIMT1	56000	3	2	N/A
1216	A	LSNT145	1	LIMCH	56000	11	1	1215
1216	A2	LSNT145	2	LIMCH	56000	19	1	1215

Canceling the `REPT-STAT-SLK` and `RTRV-SLK` Commands

Because the `rept-stat-slk` and `rtrv-slk` commands used in this procedure can output information for a long period of time, the `rept-stat-slk` and `rtrv-slk` commands can be canceled and the output to the terminal stopped. There are three ways that the `rept-stat-slk` and `rtrv-slk` commands can be canceled.

- Press the **F9** function key on the keyboard at the terminal where the `rept-stat-slk` or `rtrv-slk` commands were entered.
- Enter the `canc-cmd` without the `trm` parameter at the terminal where the `rept-stat-slk` or `rtrv-slk` commands were entered.
- Enter the `canc-cmd:trm=<xx>`, where `<xx>` is the terminal where the `rept-stat-slk` or `rtrv-slk` commands were entered, from another terminal other than the terminal where the `rept-stat-slk` or `rtrv-slk` commands were entered. To enter the `canc-cmd:trm=<xx>` command, the terminal must allow Security Administration commands to be entered from it and the user must be allowed to enter Security Administration commands. The terminal's permissions can be verified with the `rtrv-secu-trm` command. The user's permissions can be verified with the `rtrv-user` or `rtrv-secu-user` commands.

For more information about the `canc-cmd` command, go to the *Commands Manual*.

Procedure

1. Display the cards in the database using the `rtrv-card` command. This is an example of the possible output.

```

rlghncxa03w 05-09-28 09:12:36 GMT EAGLE5 34.0.0
CARD  TYPE      APPL      LSET NAME  LINK SLC LSET NAME  LINK SLC
1101  TSM          SCCP
1102  TSM          GLS
1113  GSPM         EOAM
1114  TDM-A
1115  GSPM         EOAM
1116  TDM-B
1117  MDAL
1201  LIMV35       CCS7ITU   lsne12     A    0
1202  LIMV35       CCS7ITU   lsne12     A    1
1203  LIMV35       CCS7ITU   lsne13     A    0
1204  LIMV35       CCS7ITU   lsne13     A    1
1207  LIMT1        SS7ANSI   lsnt265    A    0
1208  LIMCH        SS7ANSI   lsnt265    A    1  lsnt265    A2    2
1211  LIME1        CCS7ITU   lsne145    A    0
1212  LIMCH        CCS7ITU   lsne145    A    1  lsne145    A2    2
1215  LIMT1        SS7ANSI
1216  LIMCH        SS7ANSI
1305  LIMOCU       CCS7ITU   sp6         A    0  sp7         B    0
1306  LIMOCU       CCS7ITU   nsp3        A    0  nsp4        B    0
1307  LIMOCU       CCS7ITU   nsp1        A    0
1308  LIMOCU       CCS7ITU   nsp1        A    1
1316  ACMENET      STPLAN
1314  LIMOCU       CCS7ITU   sp7         A    1  sp5         B    0
1317  TSM          SCCP

```

If the required T1 card or channel card is not in the database, go to the "Adding a LIM-T1 Card" procedure on page B-11 and add the required cards to the database.

2. Display the current linkset configuration using the `rtrv-ls` command. This is an example of the possible output.

```

rlghncxa03w 05-09-10 11:43:04 GMT EAGLE5 34.0.0
                                L3T SLT                                GWS GWS GWS
LSN          APCA   (SS7)  SCRNM SET SET BEI LST LNKS ACT MES DIS SLSCI NIS
lsnt145      150-075-038  scr4  1  1  yes a  0  on  on  off --- ---
lsnt265      200-150-067  scr2  1  1  yes a  3  on  on  off --- ---

                                L3T SLT                                GWS GWS GWS
LSN          APCA   (X25)  SCRNM SET SET BEI LST LNKS ACT MES DIS SLSCI NIS

                                L3T SLT                                GWS GWS GWS
LSN          APCI   (SS7)  SCRNM SET SET BEI LST LNKS ACT MES DIS SLSCI NIS
lsne12       2-150-7      scr1  1  1  no  a  2  on  on  off --- ---
lsne145      4-049-3      scr1  1  1  no  a  3  on  on  off --- ---
sp5          1-111-3      scr3  1  3  yes c  1  off off off --- ---
sp6          1-111-1      scr1  1  1  yes a  1  off off off --- ---
sp7          1-111-2      scr2  1  2  no  a  2  on  on  on  --- ---

                                L3T SLT                                GWS GWS GWS
LSN          APCN   (SS7)  SCRNM SET SET BEI LST LNKS ACT MES DIS SLSCI NIS
lsne13       14950      scr1  1  1  no  a  2  on  on  off --- off
nsp1         11111      scr1  1  1  yes a  2  off off off --- off
nsp3         11112      scr2  1  2  no  a  1  on  on  on  --- off
nsp4         11113      scr3  1  3  yes c  1  off off off --- off

                                L3T SLT                                GWS GWS GWS
LSN (CHINA)  APCN   (SS7)  SCRNM SET SET BEI LST LNKS ACT MES DIS SLSCI NIS

                                L3T SLT                                GWS GWS GWS
LSN (CHINA)  APCN24 (SS7) SCRNM SET SET BEI LST LNKS ACT MES DIS SLSCI NIS

Link set table is ( 11 of 1024) 1% full

```

If the required linkset is not in the database, go to the "Adding an SS7 Linkset" procedure on page 3-17 and add the required linkset to the database.

3. Display the current signaling link configuration using the `rtrv-slk` command. This is an example of the possible output.

```

rlghncxa03w 05-09-19 21:16:37 GMT EAGLE5 34.0.0

LOC LINK LSN          SLC TYPE          L2T          L1          PCR PCR
1201 A  lsne12         0 LIMV35         1  64000  --- ---  BASIC ---  -----
1202 A  lsne12         1 LIMV35         1  64000  --- ---  BASIC ---  -----
1203 A  lsne13         0 LIMV35         1  64000  --- ---  BASIC ---  -----
1204 A  lsne13         1 LIMV35         1  64000  --- ---  BASIC ---  -----
1305 A  sp6             0 LIMOCU         1  56000  --- ---  BASIC ---  -----
1305 B  sp7             0 LIMOCU         1  64000  DTE ---  PCR   76   3800
1306 A  nsp3            0 LIMOCU         1  56000  --- ---  BASIC ---  -----
1306 B  nsp4            0 LIMOCU         1  56000  --- ---  BASIC ---  -----
1307 A  nsp1            0 LIMOCU         1  56000  --- ---  BASIC ---  -----
1308 A  nsp1            1 LIMOCU         1  56000  --- ---  BASIC ---  -----
1314 A  sp7              1 LIMOCU         2  64000  DTE ---  PCR   76   3800
1314 B  sp5             0 LIMOCU         3  64000  DCE ON  BASIC ---  -----

LOC LINK LSN          SLC TYPE          LP          ATM
SET BPS          TSEL          VCI  VPI  LL

LOC LINK LSN          SLC TYPE          LP          ATM          E1ATM
SET BPS          TSEL          VCI  VPI  CRC4 SI SN

No Links Set up.

LOC LINK LSN          SLC TYPE          IPLIML2

No Links Set up.

LOC LINK LSN          SLC TYPE

No Links Set up.

LOC LINK LSN          SLC TYPE          L2T          PCR PCR E1 E1
SET BPS          ECM N1 N2  LOC PORT TS
1211 A  lsne145         0 LIME1         1  56000  BASIC ---  ----- 1211 2  10
1212 A  lsne145         1 LIMCH         1  56000  BASIC ---  ----- 1211 1  14
1212 A2 lsne145         2 LIMCH         1  56000  BASIC ---  ----- 1211 1  20

LOC LINK LSN          SLC TYPE          L2T          PCR PCR T1 T1
SET BPS          ECM N1 N2  LOC PORT TS
1207 A  lsnt265         0 LIMT1         1  56000  BASIC ---  ----- 1207 2  2
1208 A  lsnt265         1 LIMCH         1  56000  BASIC ---  ----- 1207 1  6
1208 A2 lsnt265         2 LIMCH         1  56000  BASIC ---  ----- 1207 1  17

SLK table is (18 of 1200) 2% full.

```

NOTE: If the `rtrv-slk` output in step 3 shows that the maximum number of signaling links is 1500, skip step 4 and go to step 5.

NOTE: If the `rtrv-slk` output in step 3 shows that the maximum number of signaling links is 1200, and the signaling link being added increases the number beyond 1200, do not perform step 4, but go to “Enabling the Large System # Links Controlled Feature” procedure on page 3-10 and enable the Large System # Links controlled feature for 1500 signaling links. Then go to step 5.

NOTE: If the `rtrv-slk` output in step 3 shows that the maximum number of signaling links is 1200, and the signaling link being added will not increase the number beyond 1200, skip step 4 and go to step 5.

4. Display the status of the Large System # Links controlled feature by entering the `rtrv-ctrl-feat` command. The following is an example of the possible output.

```
rlghncxa03w 05-09-28 21:15:37 GMT EAGLE5 34.0.0
The following features have been permanently enabled:
```

Feature Name	Partnum	Status	Quantity
IPGWx Signaling TPS	893012814	on	20000
ISUP Normalization	893000201	on	----
Command Class Management	893005801	on	----
LNP Short Message Service	893006601	on	----
Intermed GTT Load Sharing	893006901	on	----
XGTT Table Expansion	893006101	on	400000
XMAP Table Expansion	893007701	on	3000
HC-MIM SLK Capacity	893012707	on	64

The following features have been temporarily enabled:

Feature Name	Partnum	Status	Quantity	Trial Period Left
Zero entries found.				

The following features have expired temporary keys:

Feature Name	Partnum
Zero entries found.	

If the Large System # Links controlled feature is not enabled or on, go to “Enabling the Large System # Links Controlled Feature” procedure on page 3-10 and enable the Large System # Links controlled feature for 1500 signaling links. Then go to step 5.

5. Display the T1 interfaces that will be assigned to the T1 signaling link using the `rtrv-t1` command with no parameters. This is an example of the possible output.

```
rlghncxa03w 05-09-19 21:17:04 GMT EAGLE5 34.0.0

LOC  T1PORT  ENCODE  T1TSEL  FRAMING  LL  CHANBRDG
1207  1        AMI     EXTERNAL  ESF      50  -----
1215  2        B8ZS   LINE      SF       100  -----
```

T1 Interface

If the desired T1 port and T1 card combination are not shown in the `rtrv-t1` output, add the T1 port and T1 card combination to the database by performing the “Adding the T1 Interface Parameters” procedure on page B-24.

If a new T1 card was added in these procedures and that card is an HC MIM, skip step 6 and go to step 7.

NOTE: If the card the signaling link is being assigned to is a channel card, skip step 6, and go to step 7.

6. If any of the following conditions are shown in the `rtrv-t1` output in step 5, the card is an HC MIM.
 - a. If the T1 port that will be assigned to the T1 signaling link is channel bridged. Go to step 7.
 - b. If T1 ports 3, 4, 5, 6, 7, or 8 are assigned to the T1 card that will be assigned to the T1 signaling link. Go to step 7.

If conditions a or b are not shown in the `rtrv-t1` output, verify the type of T1 card.

-
7. Add the T1 signaling links using the `ent-slk` command.

The link parameter value is dependent on the type of card the T1 signaling link is assigned to. Table B-13 shows the link parameter values.

Table B-13. Link Parameter Values

Type of Card	Link Parameter Values
E1/T1 MIM	A - A3, B - B3
HC MIM	A - A31, B - B31

For this example, enter these commands.

```
ent-slk:loc=1215:link=a:lsn=lsnt145:slc=0:bps=56000:ts=3
:t1port=2
```

```
ent-slk:loc=1216:link=a:lsn=lsnt145:slc=1:bps=56000:ts=11
:t1loc=1215
```

```
ent-slk:loc=1216:link=a2:lsn=lsnt145:slc=2:bps=56000:ts=19
:t1loc=1215
```

When each of these commands have successfully completed, this message should appear.

```
rlghncxa03w 05-09-07 08:29:03 GMT EAGLE5 34.0.0
ENT-SLK: MASP A - COMPLTD
```

8. Verify the changes using the **rtrv-slk** command, specifying the card location and signaling link entered in step 7. This is an example of the possible output.

rtrv-slk:loc=1215

This is an example of the possible output.

```
rlghncxa03w 05-09-19 21:17:04 GMT EAGLE5 34.0.0
                L2T                PCR PCR T1 T1
LOC LINK LSN      SLC TYPE      SET BPS   ECM  N1  N2  LOC PORT TS
1215 A   lsnt145    0 LIMT1    1  56000 BASIC ---  ---- 1215 2   3
```

rtrv-slk:loc=1216

This is an example of the possible output.

```
rlghncxa03w 05-09-19 21:17:04 GMT EAGLE5 34.0.0
                L2T                PCR PCR T1 T1
LOC LINK LSN      SLC TYPE      SET BPS   ECM  N1  N2  LOC PORT TS
1216 A   lsnt145    1 LIMCH    1  56000 BASIC ---  ---- 1215 1   11
1216 A2  lsnt145    2 LIMCH    1  56000 BASIC ---  ---- 1215 1   19
```

9. If any cards contain the first signaling link on a card, those cards must be brought into service with the **rst-card** command, specifying the location of the card. For this example, enter these commands.

rst-card:loc=1215

rst-card:loc=1216

When each of these commands have successfully completed, this message should appear.

```
rlghncxa03w 05-09-23 13:05:05 GMT EAGLE5 34.0.0
Card has been allowed.
```

10. Activate all signaling links on the cards using the **act-slk** command, specifying the card location and signaling link specified in step 7. For this example, enter these commands.

act-slk:loc=1215:link=a

act-slk:loc=1216:link=a

act-slk:loc=1216:link=a2

When each of these commands have successfully completed, this message should appear.

```
rlghncxa03w 05-09-07 08:31:24 GMT EAGLE5 34.0.0
Activate Link message sent to card
```

- Check the status of the signaling links added in step 7 using the **rept-stat-slk** command with the card location and signaling link. The state of each signaling link should be in service normal (IS-NR) after the link has completed alignment (shown in the **PST** field). For this example, enter these commands.

```
rept-stat-slk:loc=1215:link=a
```

This is an example of the possible output.

```
rlghncxa03w 05-09-23 13:06:25 GMT EAGLE5 34.0.0
SLK   LSN   CLLI   PST   SST   AST
1215,A lsnt145 ----- IS-NR   Avail  ----
      ALARM STATUS      = No Alarms
      UNAVAIL REASON    = --
      T1 status         = 1215, RCVRY-T1F:FAC-T1 Port 2 available
```

```
rept-stat-slk:loc=1216:link=a
```

This is an example of the possible output.

```
rlghncxa03w 05-09-23 13:06:25 GMT EAGLE5 34.0.0
SLK   LSN   CLLI   PST   SST   AST
1216,A lsnt145 ----- IS-NR   Avail  ----
      ALARM STATUS      = No Alarms
      UNAVAIL REASON    = --
      T1 status         = 1215, RCVRY-T1F:FAC-T1 Port 1 available
```

```
rept-stat-slk:loc=1216:link=a2
```

This is an example of the possible output.

```
rlghncxa03w 05-09-23 13:06:25 GMT EAGLE5 34.0.0
SLK   LSN   CLLI   PST   SST   AST
1216,A2 lsnt145 ----- IS-NR   Avail  ----
      ALARM STATUS      = No Alarms
      UNAVAIL REASON    = --
      T1 status         = 1215, RCVRY-T1F:FAC-T1 Port 1 available
```

- Backup the new changes using the **chg-db:action=backup:dest=fixed** command. These messages should appear, the active Maintenance and Administration Subsystem Processor (MASP) appears first.

```
BACKUP (FIXED) : MASP A - Backup starts on active MASP.
BACKUP (FIXED) : MASP A - Backup on active MASP to fixed disk complete.
BACKUP (FIXED) : MASP A - Backup starts on standby MASP.
BACKUP (FIXED) : MASP A - Backup on standby MASP to fixed disk complete.
```

Flowchart B-6. Adding a T1 Signaling Link (Sheet 1 of 5)

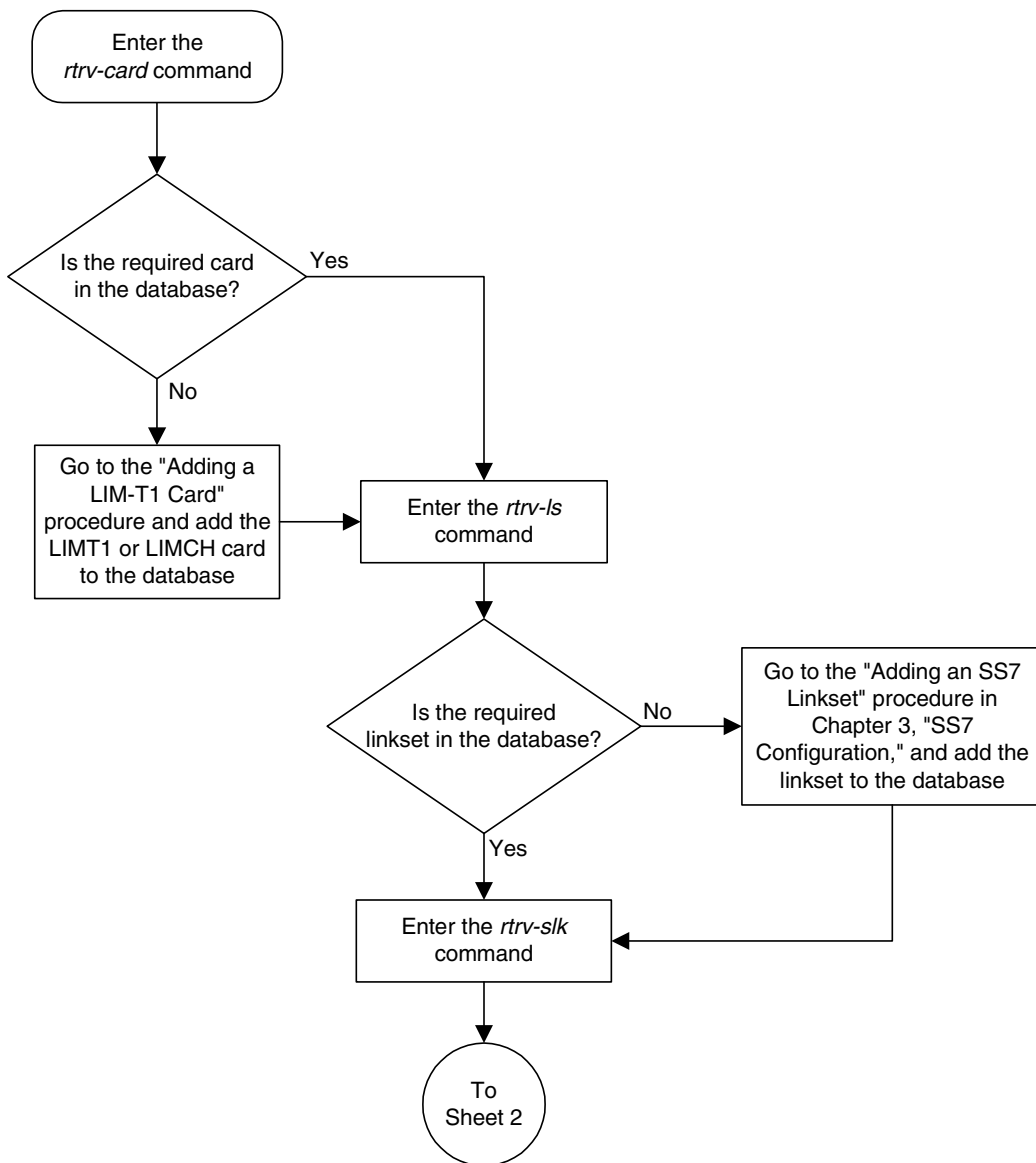

Flowchart B-6. Adding a T1 Signaling Link (Sheet 2 of 5)

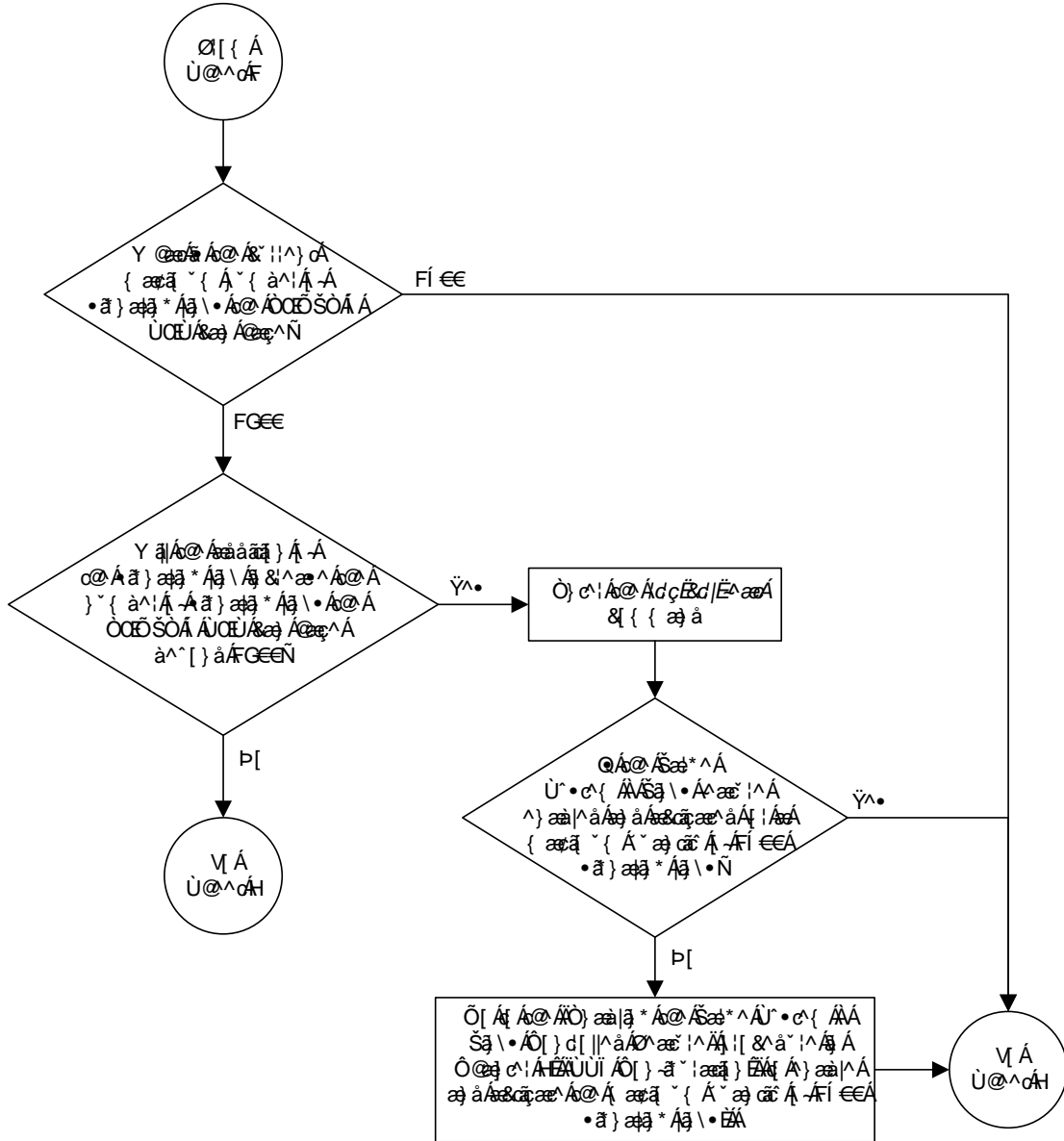

Flowchart B-6. Adding a T1 Signaling Link (Sheet 4 of 5)

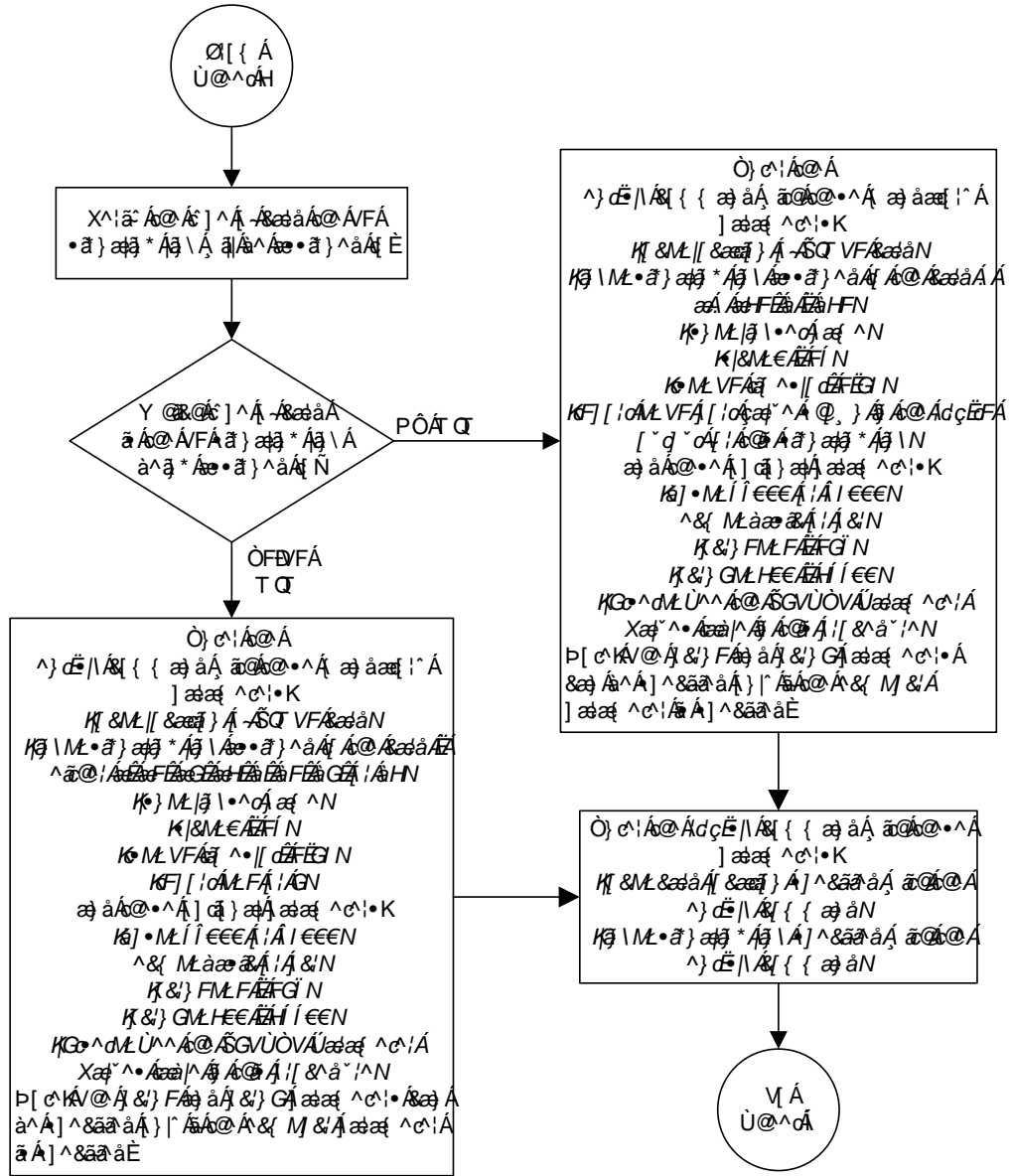

Flowchart B-6. Adding a T1 Signaling Link (Sheet 5 of 5)

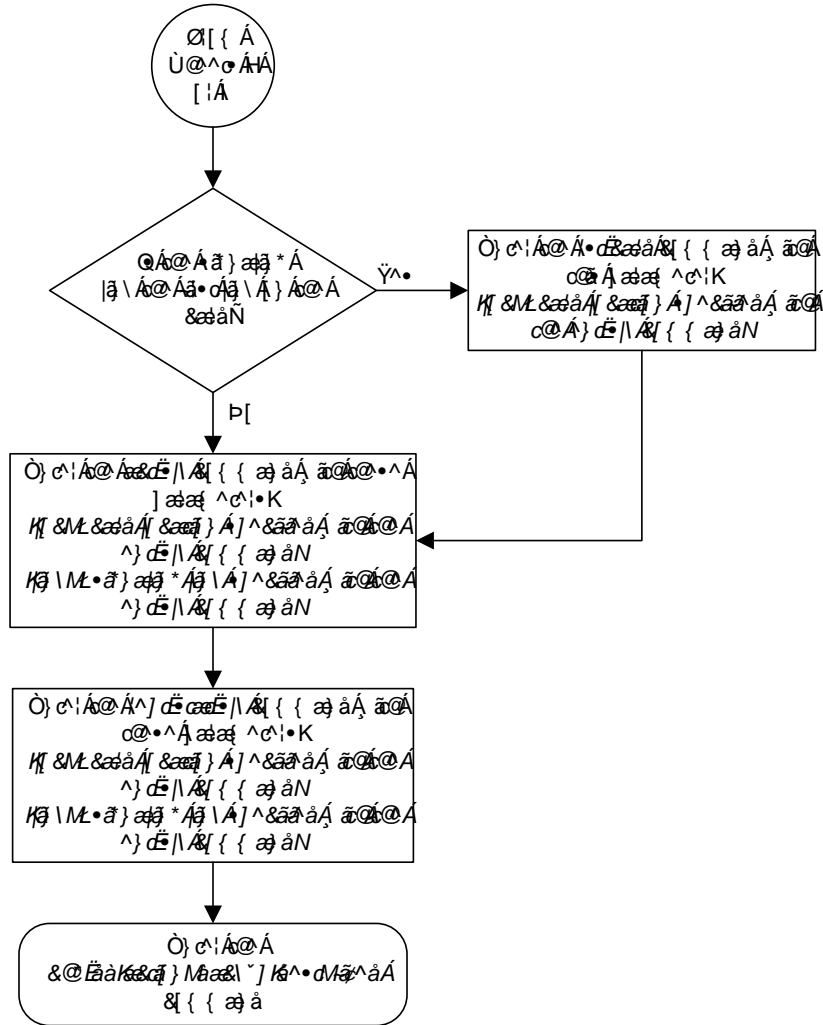

ATM Signaling Link Configuration

Introduction.....	C-1
Overview of the ATM High-Speed Signaling Link LIM Operation.....	C-8
ATM High-Speed Signaling Link Testing Capability	C-19
Large MSUs	C-27
Unsolicited Messages	C-27
ATM High-Speed Signaling Link Configuration	C-30
Adding a High-Speed LIM-ATM or an E1-ATM LIM.....	C-31
Adding an ATM High-Speed Signaling Link.....	C-34
Changing an ATM High-Speed Signaling Link Parameter Set.....	C-50

Introduction

ATM (Asynchronous Transfer Mode) is a transport mechanism that uses virtual connections for transporting information across the network. The ATM layer uses the VPI and VCI fields to define multiple Virtual Channel Connections (VCC). Within each VCC, the PTI field is used to distinguish one type of traffic from another. A true ATM switch can support multiple VPI/VCI combinations. The EAGLE 5 SAS supports only a single VPI/VCI combination.

ATM is a specific packet-oriented transfer mode that uses an asynchronous time division multiplexing technique to multiplex information flow in fixed blocks, called cells. ATM replaces MTP-1 (Signaling Data Link Functions) and MTP-2 (Signaling Link Functions) in the SS7 protocol stack.

Signaling data link functions (MTP-1) are provided by an appropriate physical layer in combination with the ATM layer, signaling link functions (MTP-2) are provided by the Signaling ATM Adaptation Layer (SAAL), and the signaling network functions are provided by MTP level 3. Figure C-1 illustrates the high-speed link protocol model for CCS NEs.

Figure C-1. High-Speed Link Protocol Model for CCS Network Elements

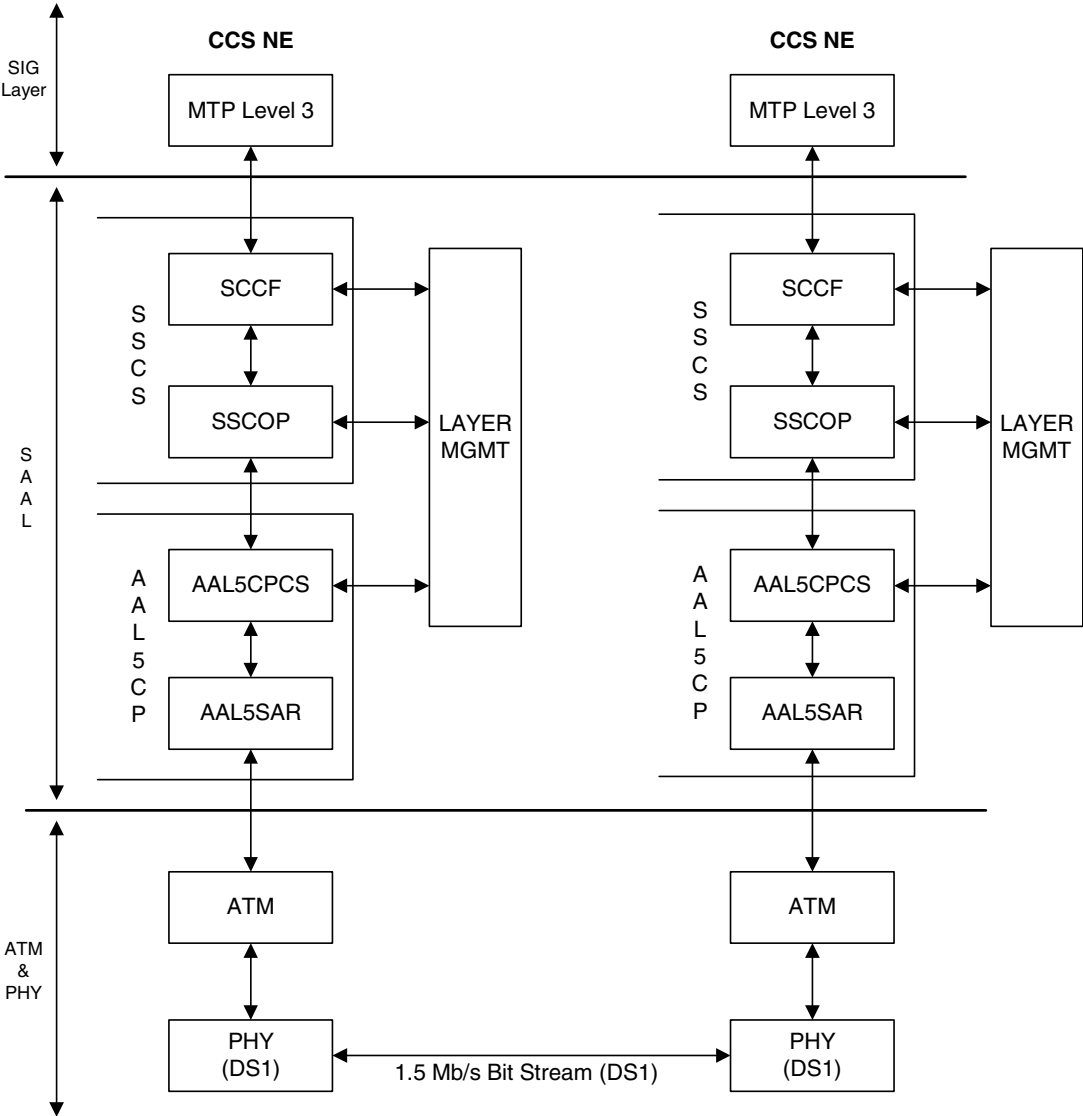

ATM Signaling Link Configuration

Figure C-2 on page C-4 illustrates some slight differences between the SAAL and ATM layers and the actual protocol stack used in the Tekelec implementation.

These differences are as a result of 3 reasons:

- The AATM hardware provides AAL5CP protocol support (primarily segmentation and reassembly of User Data PDUs), thus providing the AAL5CP functionality in hardware not software. The AATM hardware also provides CRC10 support for OAM F5 ATM cell flows.
- The ATM driver is not a defined block in the protocol model, but is needed in the Tekelec implementation to control and interface with the AATM hardware. The ATM driver provides the software interface to the hardware AAL5CP functionality. The ATM driver also provides the ATMM (ATM Layer Management) functions that are supported in the EAGLE 5 SAS.
- As a part of providing ATM (MTP-level 2 equivalent) functionality into the existing EAGLE 5 SAS software (based on MTP-3 and MTP-2, not MTP-3 and SAAL), some of the interfaces to and from MTP level 3 will be to and from MAAL (rather than SSCF handling all MTP-3 interaction).

The EAGLE 5 SAS implements an ANSI ATM high-speed signaling link, transmitting at a rate of 1.544 Mbps, and an E1 ATM high-speed signaling link, transmitting at a rate of 2.048 Mbps. Most of the ANSI and E1 ATM implementations are the same, but there are a few differences. The descriptions in this appendix apply to both implementations. Any differences between ANSI and E1 ATM are noted.

Figure C-2. ATM High-Speed Signaling Link Protocol Stack vs. Tekelec Implementation in the EAGLE 5 SAS

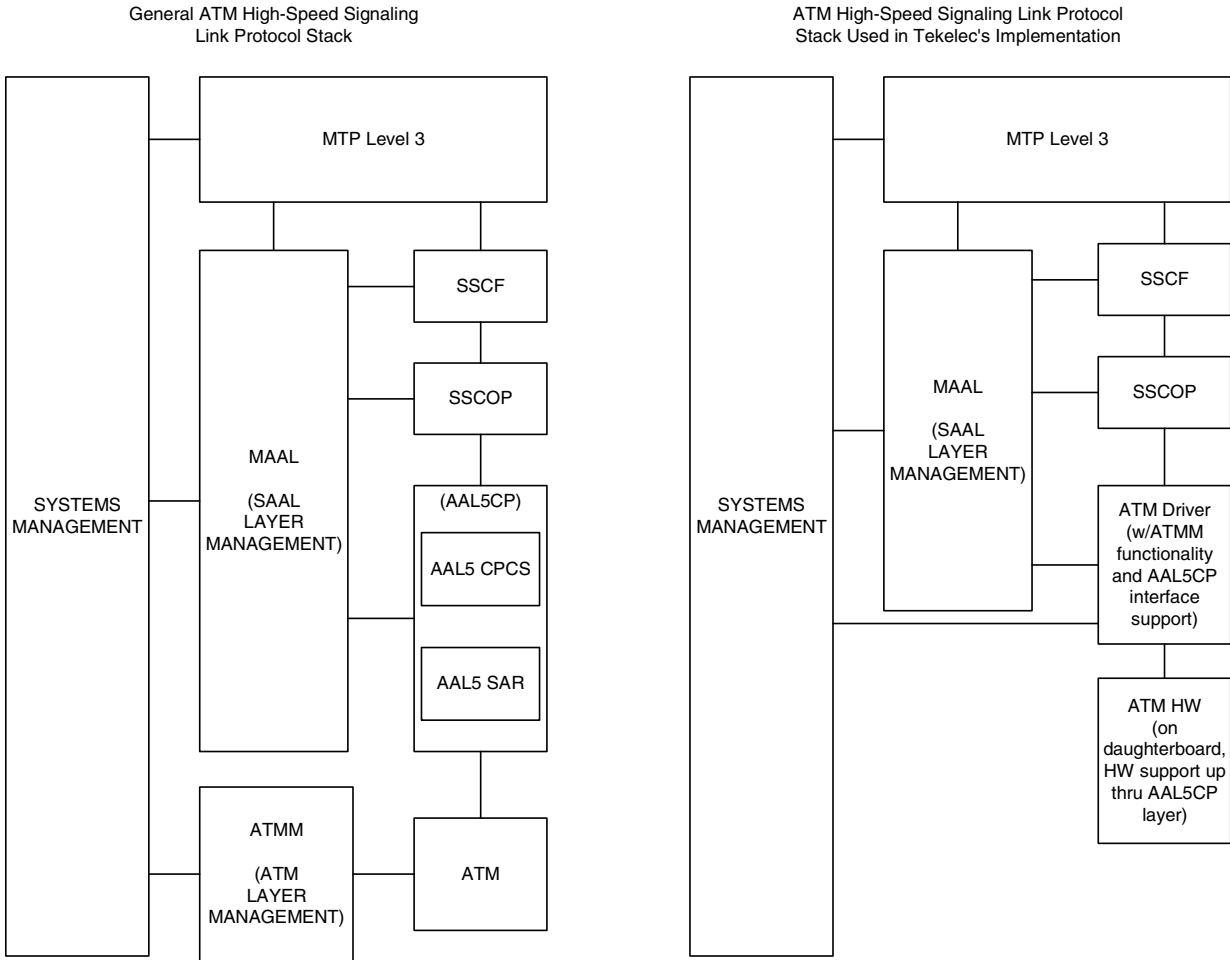

Another way of viewing the high-speed signaling link implementation is to consider the frame formats of the data that is relevant at the various protocol stack layers. Figure C-3 on page C-5 illustrates the differences between the frame formats for high-speed signaling link layers versus the frame formats for traditional (MTP-2 & MTP-1) low-speed signaling link layers.

Figure C-3. Frame Formats for High-Speed and Low-Speed Signaling Link Protocol Stacks

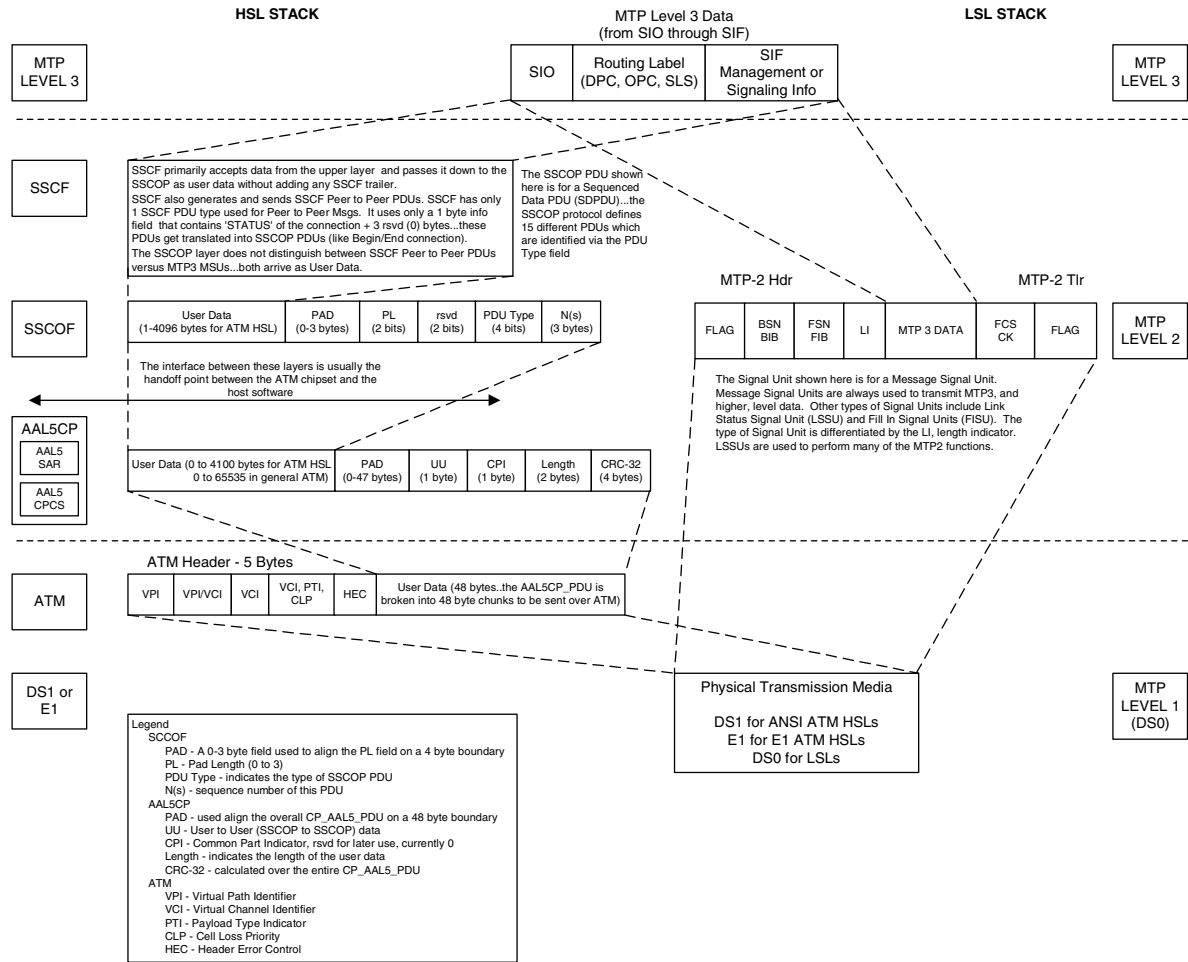

Based on Figure C-3, the following conclusions can be made regarding the ATM traffic and how ATM is used to carry MTP3 data:

- The ATM layer uses the VPI and VCI fields to define multiple Virtual Channel Connections (VCC). Within each VCC, the PTI field is used to distinguish 1 type of traffic from another. A true ATM switch can support multiple VPI/VCI combinations. The EAGLE 5 SAS high-speed signaling link implementation needs to support only a single VPI/VCI combination.
- The ATM stack contains built in fields that are used to check the integrity of the data that is received across the T1 connection. The ATM cell HEC field and the AAL5CP CRC-32 fields are used for data integrity.
- MTP3 data (or MSUs) is transferred as User Data at the ATM cell level. A single MSU will require 1 or more ATM cells to transfer that MSU.

- A significant amount of ATM protocol overhead is involved in transferring MSUs. The overhead includes:
 - ATM cell headers
 - AAL5CP layer pad bytes and trailer
 - SSCOP layer pad bytes and trailer
- In addition to transferring MSUs, the ATM stack is capable of transferring
 - SSCOP Peer to Peer Messages - these are used primarily for connection setup and tear down and the acknowledgment of transferred data
 - SSCF Peer to Peer Messages - these are used primarily for high-speed signaling link alignment and proving

ATM Protocol Encapsulation

Two main types of data are delivered using ATM: SDUs and OAM cells. SDUs provide peer-to-peer information and user data (MSUs). OAM cells are used for operations and maintenance of the ATM connection. Figure C-4 on page C-7 provides the data encapsulation through the ATM stack. MTP3 is a user of SSCF and passes all PDUs directly to it.

Figure C-4. ATM Protocol Encapsulation

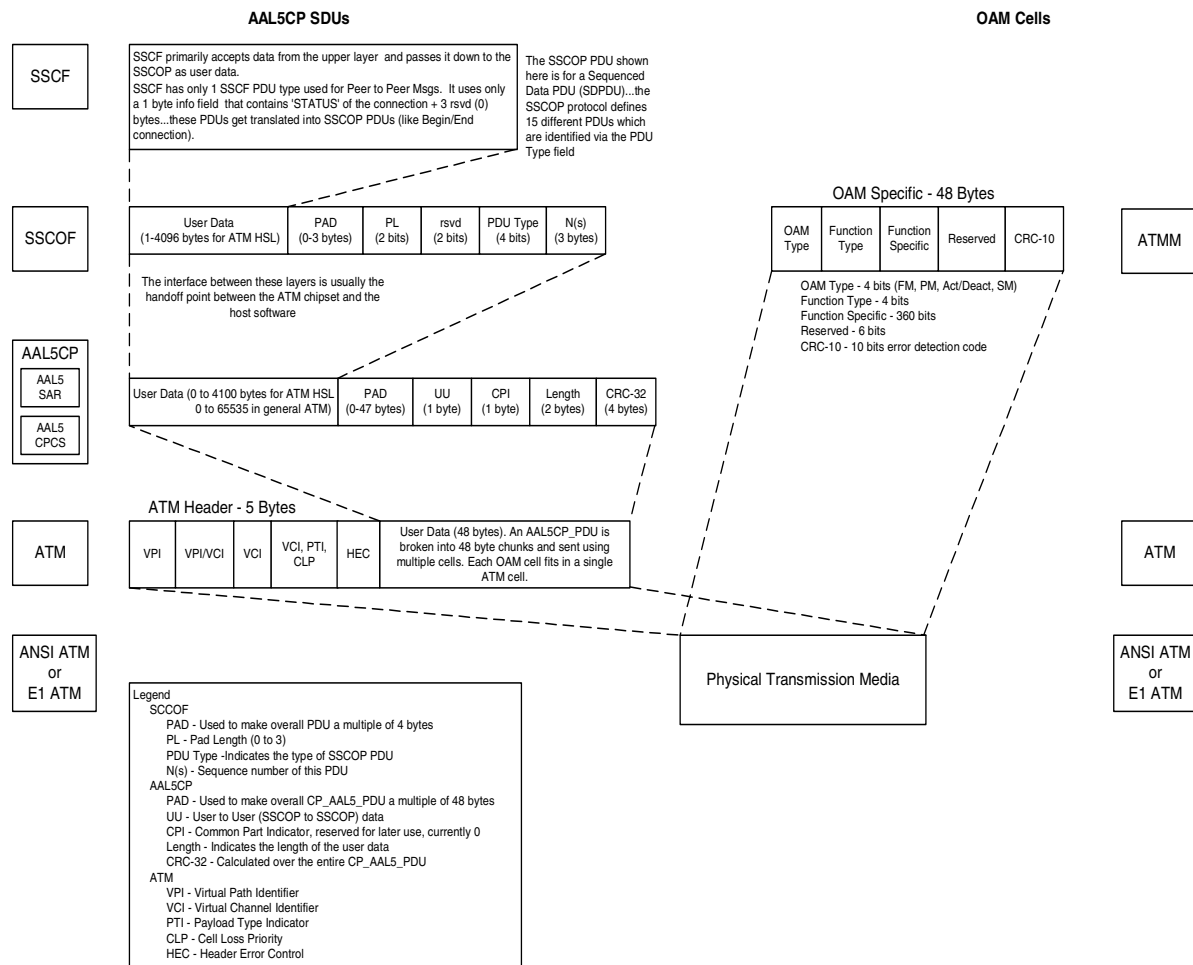

Payload Scrambling

Payload scrambling uses the $x^{43}+1$ scrambling function.

Idle Cells

Idle cells uses the following 5-byte header format:

0x00 0x00 0x00 0x01 0x52.

The content of the information field shall be 0x6A repeated 48 times.

Since idle cells are transmitted on VPI=0, VCI=0, they are immediately discarded by the receiving end.

Overview of the ATM High-Speed Signaling Link LIM Operation

To other cards in the EAGLE 5 SAS, the ANSI ATM and E1 ATM high-speed signaling link cards look and operate similar to any other LIMs (with the exception of subtle differences related to load balancing for SCCP traffic), but has the potential for increased data throughput with respect to traditional EAGLE 5 SAS LIMs.

The ANSI and E1 ATM high-speed signaling link cards can perform gateway screening, copy and redirect, conversion and any of the other EAGLE 5 SAS features that any other LIM can perform (with the exception of link fault sectionalization).

A functional block diagram of the ATM high-speed signaling link is shown in Figure C-5.

ATM Signaling Link Configuration

Figure C-5. Functional Block Diagram of ATM High-Speed Signaling Link

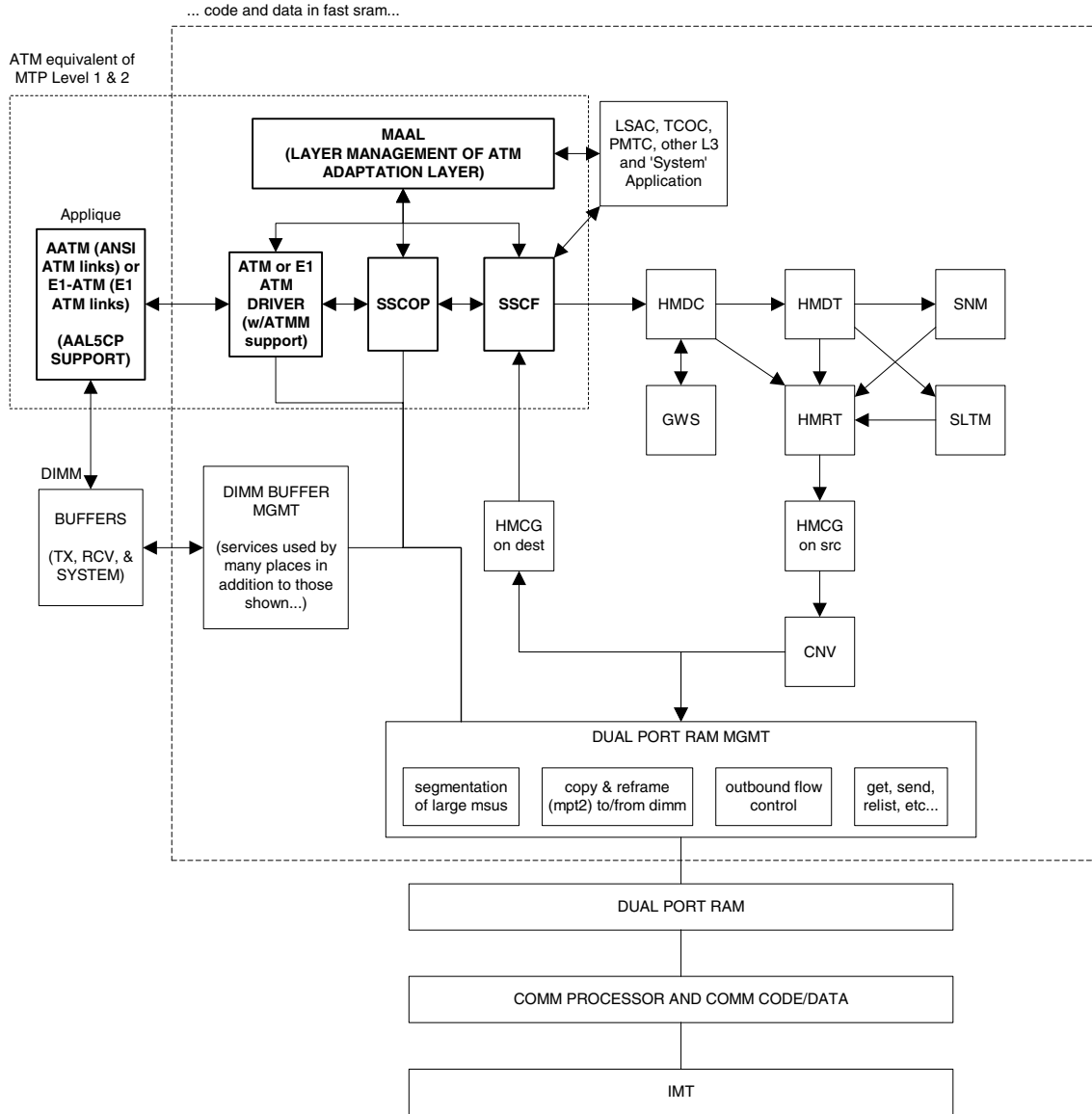

The following sections provide more details for each of the new applications/processes (indicated by the bold boxes in Figure C-5) required for the ATM high-speed signaling link implementation. These sections will include information such as:

- the specification(s) that defines the layer
- highlights of the functionality provided by the application/process (what problems are being solved here)
- any limitations/restrictions from specifications that apply to the EAGLE 5 SAS implementation
- other information as appropriate

Applique

ANSI ATM

The ANSI ATM hardware consists of an AATM applique connected to an HCAP or HCAP-T main assembly. The AATM hardware provides the following functionality:

- support for the DS1, ATM, and AAL5CP layers of the ATM high-speed signaling link protocol stack as indicated in Figure 1
- DS1 Layer support
 - generate DS1 signals
 - support for DS1 defect reporting:
 - ◆ LOS
 - ◆ LOF
 - ◆ LCD
 - ◆ In-band AIS signals
 - support for loopback testing at the DS1 level
 - support for DS1 performance measurements and performance monitoring
- ATM Layer support
 - idle cell insertion/removal
 - provide adequate indications of ATM layer errors:
 - ◆ invalid ATM header patterns
 - ◆ unsupported VPI/VCI combinations
 - ◆ unsupported PTI values

ATM Signaling Link Configuration

- ◆ cells discarded due to header error control
- ◆ out of cell delineation anomalies
- header error control field to be automatically inserted/checked by the hardware
- CLP field of cells received is made available to software
- ability to DMA received cells directly to DIMM receive buffers
- ability to DMA cells to transmit directly from DIMM transmit buffers
- needs to support interleaved transmit/reception of data from different VPI/VCI combinations, or from OAM F5 flows as opposed to user data flows, these need to each be passed to higher layers using different queues or data structures
- congestion indications for cells are made available to software; software can set the congestion indications for outbound traffic.
- OAM F5 cell support
 - only end to End OAM F5 cells for a VCC need to be supported
 - shall support generation (outbound) and processing (inbound) of OAM cell types for VCC F5 flows
 - shall indicate reception of these cells in a distinct manner from user data cells
 - provide CRC-10 checking/generation for these frames
- AAL5CP Layer support
 - perform the segmentation/reassembly required for user data cells and ability to pass user data to/from the SSCOP in an efficient manner (whether this is via some linked list of ATM cells that together make up 1 AAL5CP_PDU, or via regrouping ATM cells as they arrive into 1 continuous AAL5CP_PDU is implementation dependent).
 - provide CRC-32 generation/checking for AAL5CP_PDUs
 - should stuff outbound AAL5CP_PDUs with 0 in the CPI field
 - appropriate error checking and indications for errors
 - ◆ CRC errors
 - ◆ Length errors
 - ◆ CPI errors
 - some fields of the AAL5CP_PDU need to be passed to/from the higher layers
 - ◆ UU

- ◆ CLP
- ◆ Congestion indication

E1 ATM

The E1 ATM hardware consists of an E1 ATM applique connected to an HCAP or HCAP-T main assembly. The E1 ATM hardware performs the same functions as the ANSI ATM hardware, with these exceptions:

- support for the E1, ATM, and AAL5CP layers of the ATM high-speed signaling link protocol stack as indicated in Figure C-5 on page C-9.
- E1 layer support
 - Support CRC-4
 - Support Si and Sn insertion in Channel 0
 - Support E1 defect reporting:
 - ◆ LOS
 - ◆ LOF
 - ◆ LCD
- OAM F5 cell support - only end-to-end OAM F5 cells for a VCC are required to be supported

E1 Overview

This section provides an overview of E1, its protocol and characteristics.

Frame Structure

E1 is a 2.048 Mbps interface. It has a frame structure of 256 bits that is repeated at a rate of 8 KHz. The 256-bit frame is broken into 32 eight-bit time timeslots, numbered 0 to 31, as shown in Figure C-6. Timeslots can also be referred to as channels.

Figure C-6. E1 Frame Structure

align frame	Si 0 0 1 1 0 1 1	timeslot 1	timeslot 2	timeslot 30	timeslot 31
non-align frame	Si 1 A SnSnSnSnSn	timeslot 1	timeslot 2	timeslot 30	timeslot 31
align frame	Si 0 0 1 1 0 1 1	timeslot 1	timeslot 2	timeslot 30	timeslot 31
non-align frame	Si 1 A SnSnSnSnSn	timeslot 1	timeslot 2	timeslot 30	timeslot 31

Si - International Usage Spare Bit
 Sn - National Usage Spare Bit
 A - Alarm Bit

Timeslot 0

Timeslot 0 is used for frame alignment and CRC functions. Alternating frames contain the Frame Alignment Signal (FAS), X0011011, where X is supplied from the International Usage Spare Bit information (Si). Frames without the FAS carry Si, Alarm, and Sn information. Bit 1 is set to 1 to prevent accidental emulation of the FAS.

Si is reserved for international usage. CRC-4 specified below is one specific use. If no use is specified, Si should be set to 1. Sn is a 5-bit field (value 0 – 31). 'A' is an alarm bit. If set, it indicates a remote alarm indication.

CRC-4

A CRC-4 multi-frame structure is shown in Figure C-7 on page C-14. CRC-4 uses timeslot 0 primarily to aid in frame alignment validation but can be used to monitor error performance as well. A CRC multi-frame consists of timeslot 0 information from 16 consecutive frames. Each CRC-4 multi-frame is divided into 2 eight-frame sub-multi-frames (SMF).

Bit 1 is used to carry 3 different pieces of information:

- A multi-frame alignment word is a repeating 6-bit code (001011) that is located in frames 1,3,5,7,9, and 11.
- A 4-bit CRC code word (C1, C2, C3, C4), which is a data check on the previous 8 E1 frames. The check covers the data for all 32 timeslots. (8 frames * 256 bits/frame = 2048 bits) Each SMF has its own code word. The code word for SMF I is in frames 0, 2, 4 and 6. The code word for SMF II is in frames 8, 10, 12, and 14.
- E (CRC-4 Error indication) bits, present in frames 13 and 15.

The Alarm Indication Signal is received in Channel 0, Bit 3 of the non-alignment frame. If this bit is set, it indicates a Remote Alarm Indication. As with the ANSI ATM, this condition is ignored.

Bits 2 through 8 follow the standard E1 frame structure.

If CRC-4 is on, the provisioned Si information is not used. Instead, bit 0 is used for CRC4 information, CRC4 error reporting, and for multiframe alignment (see Figure C-7).

Figure C-7. CRC-4 Multiframe Structure

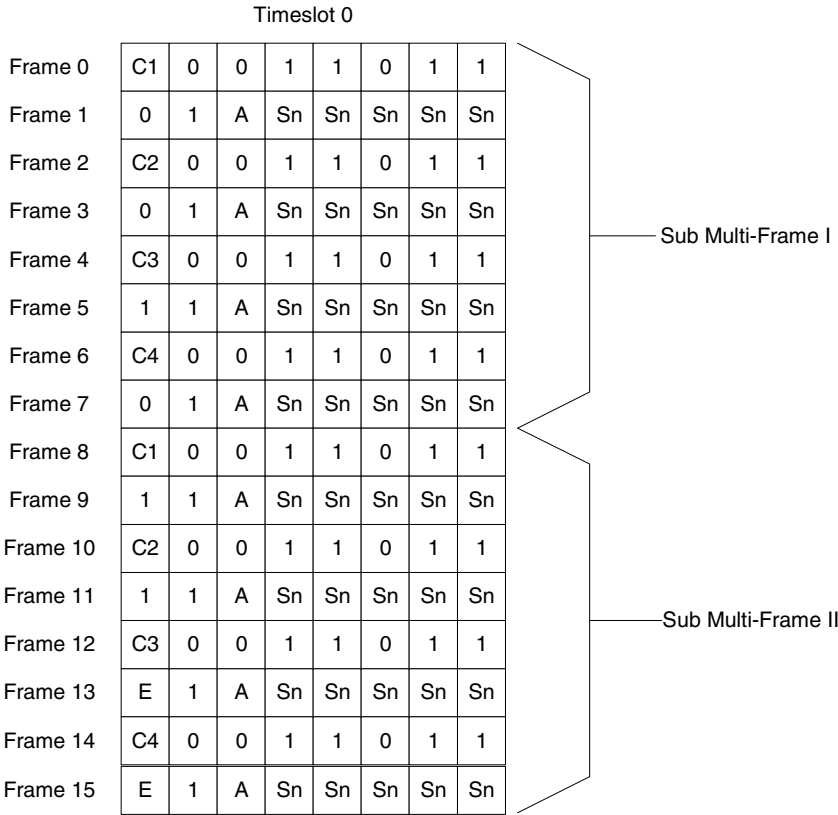

E - CRC-4 Error Indication Bits
 C1 to C4 - Cyclic Redundancy Check 4 bits
 Sn - National Spare Bits
 A - Remote Alarm Indication

ATM Mapping into E1

Data channels 1 – 15 and 17 - 31 carries the data for a single ATM channel, as shown in Figure C-8. Note that the ATM cell size does not map directly over the E1 frame format, so the ATM cell can start in any data channel. The data is octet-aligned.

Figure C-8. ATM Cell Mapping into E1 Frames

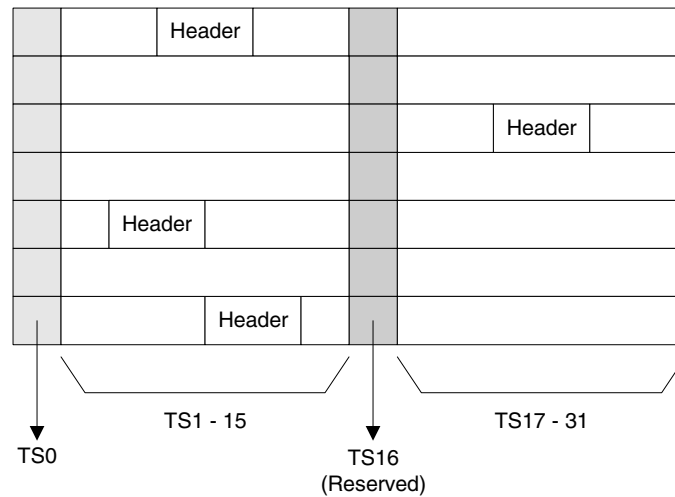

ATM Driver

The ATM driver is a software module, residing as part of the ATMANSI or ATMITU applications, that provides the code required to interface between the AATM hardware and the SSCOP layer and ATM Layer Management interfaces. The primary functions of the driver include:

- initialization and control of the AATM hardware
- interface between AATM hardware signals and data structures and the relevant messages/data to/from the SSCOP and ATM Layer Management layers
- provide the DIMM buffer management interface required for the AATM hardware for user data received and transmitted (that is, provide free receive buffer lists for the AATM hardware after grabbing buffers from DIMM mgmt, provide information detailing where to transmit user data from, etc.)
- some of the functions listed above in the AATM hardware section (such as providing separate 'receive channels' for OAM F5 vs. user data cells to/from higher levels) may actually be performed in this layer based on the actual ATM hardware solution selected
- the only type of AAL service needed is for AAL Type 5 (AAL5)
- the AATM hardware and ATM driver together make up the common part of the SAAL layer, also known as the Common Part Convergence Sublayer (CPCS) or AAL5CP, when the AAL type in question is AAL5.

E1 ATM Driver

The E1 ATM driver is a software module that provides the interface between the E1 ATM hardware, the SSCOP layer, and ATM Layer Management Module. The E1 ATM driver exists only in the ATMITU application. The basic structure is based upon the ANSI ATM driver present in the ATMANSI application. The primary changes to the existing ANSI ATM driver include:

- initialization and control of the new E1 ATM appliqué.
- remove T1 support of 4 Kbps data link (BOCs, including performance reports and T1 loopback tests)
- verify correct E1 ATM appliqué is installed and reboot if not

SSCOP

The primary task of the SSCOP (Service Specific Connection Oriented Protocol) is to provide assured data delivery between AAL connection endpoints. The SSCOP is 1 of 2 parts (the other being the SSCF) of the Service Specific part of the SAAL layer (also known as the SSCS, the Service Specific Convergence Sublayer of the SAAL). The other part of the SAAL Layer is the CPCS (which was just mentioned in the ATM driver). Breaking the SSCS into 2 sublayers allows a common connection oriented protocol with error recovery (the SSCOP) to provide a generic reliable data transfer service for different AAL interfaces defined by different SSCF layers. The primary functions of the SSCOP layer include:

- transfer of user data with sequence integrity
- error correction by selective retransmission
- flow control
- connection control
- error reporting to layer management
- connection maintenance in the prolonged absence of data transfer
- local data retrieval by the user of the SSCOP
- error detection of protocol control information
- status reporting

ATM Signaling Link Configuration

SSCF

The primary task of the SSCF (Service Specific Coordination Function) is to map the services provided by the lower layers of the SAAL to the needs of a specific higher layer user. For the ATM high-speed signaling link, the higher layer user is the MTP-3 protocol.

- maps signals/primitives from MTP-3 (SSCF user) to SSCOP, and vice versa.
- performs local retrieve function, required by the changeover order.
- flow control on transmit direction (SSCF notifies the user of congestion levels)
- maintains and controls the link status
- generates necessary reports to ATM Layer Management (primarily the cause for the release of the SSCOP connection)
- implements some SSCF to SSCF, peer to peer messages primarily related to connection establishment and release
- controls local and remote processor outage and recovery
- controls the alignment procedure

For an E1 ATM high-speed signaling link, the link proving default values are significantly different compared to an ANSI ATM high-speed signaling link. Table C-1 illustrates the different link proving values.

Table C-1. Link Proving Differences Between ITU and ANSI

CHG-ATM-LPS Parameter Name	Description	E1 ATM Default Values	ANSI ATM Default Values
N1	Number of PDUs sent during link proving	1000	64552
TmrT2	Time to attempt link proving	30 sec	120 sec
maxnrp	Maximum number of retransmitted PDUs during proving	0	1
TmrT3	Time between proving PDUs	925 μsec	925 μsec

The time required for normal ANSI proving is approximately 60 seconds ($925 \mu\text{sec}/\text{pdu} * 64552 \text{ PDUs} = 60 \text{ seconds}$). This time is greater than **TmrT2** value for an E1 ATM high-speed signaling link (30 seconds), so a link with E1 ATM defaults would have gone out of service before a link with ANSI ATM defaults finishes proving. Thus, great care must be taken to ensure that compatible proving numbers are assigned to a signaling link.

ATM and SAAL Layer Management Interfaces

The primary task of the ATM and SAAL layer management layers is to map requests and indications between the system management for the EAGLE 5 SAS and the individual ATM, AAL5CP, SSCOP, and SSCF layers. This functionality is actually achieved using two management modules, which both interface to the system management.

ATM Layer Management

ATM layer management is achieved with the ATMM (ATM layer management module). The ATMM provides a supporting role for system management functions which include fault, performance, configuration, security and resource management functions. It is the job of the system management to coordinate with different layers locally to perform all tasks associated with these functions. The ATMM entity uses two types of interactions with the ATM entity to perform its functions. The first type of interaction is for the exchange of info between the ATM and ATMM entity. The second type of interaction is for peer to peer communication between ATMM entities (between the two nodes on both ends of the high-speed signaling link). This second interaction is achieved by sending and receiving and processing OAM F5 cells in the ATM high-speed signaling link implementation. The primary functions provided by the ATMM for an ANSI ATM high-speed signaling link include:

- OAM F5 fault management: includes alarm surveillance, loopback using OAM cells, and continuity check
- OAM F5 performance management: includes activation and deactivation of performance monitoring, forward and backward monitoring and reporting of performance to system management.

NOTE: The general ATMM layer is capable of performing performance management functionality. The ATMM layer implemented by ATM high-speed signaling link does not support this capability.

The primary functions provided by the ATMM for an E1 ATM high-speed signaling link include only OAM F5 fault management: loopback by OAM cells. All other forms of OAM F5 management and OAM F5 performance management are not supported.

ATM Signaling Link Configuration

SAAL Layer Management

The SAAL layer management includes interfaces to and from AAL5CP, SSCOP, SSCF, and system management. SAAL layer management supports the following functions:

- error processing for these layers
- error monitoring for in-service links
- detection of excessive time with no credit
- detection of closely spaced SSCOP recoveries
- measurements
- duration of presence in the in-service state
- signaling link failures
- signaling link restoration
- handling of processor outage conditions
- management of signaling link proving

ATM High-Speed Signaling Link Testing Capability

Local Loopback Support

There are five link testing capabilities for an ATM high-speed signaling link. All five of these tests can be used for an ANSI ATM high-speed signaling link; three of these tests can be used for an E1 ATM high-speed signaling link. Table C-2 gives a description of each test and shows which the type of ATM high-speed signaling link each test can be used. Figures C-9 and C-10 show diagrams of each test.

Table C-2. ATM High-Speed Signaling Link Loopback Support

Loopback Type	The Type of ATM High-Speed Link the Test can be Applied to		When can the Loopback Test be Performed	How does the Loopback Test Work	What is Tested (Assume Near End Unless Specified)
	ANSI	E1			
SLTC	Yes	Yes	When the link is in service and activated	MTP-3 exchanges SLTM/SLTA messages with remote MTP-3. Appears as normal MSU traffic to SSCF and SSCOP.	MTP-3 layer, ATM protocol stack (near end and far end), and wire
OAM	Yes	Yes	When the link is connected to a remote STP. The state of the link is either activated or deactivated.	ATM driver exchanges OAM F5 Loopback cells with remote ATM driver. One OAM cell per request with a maximum of three attempts made.	ATM driver (near end and far end) and wire
LXVR	Yes	Yes	When the link is deactivated.	MTP-3 attempts to align link. If alignment fails, test fails. Appears as normal alignment request to SSCF and SSCOP.	SSCF, SSCOP, ATM driver and T1 hardware (for an ANSI ATM high-speed link) or E1 hardware (for an E1 ATM high-speed signaling link) on near end
Payload	Yes	No	When the link is deactivated, connected to remote STP and no Yellow Alarm BOC is being transmitted.	MTP-3 attempts to align link. If alignment fails, test fails. Appears as normal alignment request to SSCF and SSCOP.	SSCF, SSCOP, ATM driver (near end only) and T1 hardware (near end and far end) and wire
Line	Yes	No	When the link is deactivated and connected to remote STP and no Yellow Alarm BOC is being transmitted.	MTP-3 attempts to align link. If alignment fails, test fails. Appears as normal alignment request to SSCF and SSCOP.	SSCF, SSCOP, ATM driver (near end only) and T1 hardware (near end and far end) and wire

ATM Signaling Link Configuration

Figure C-9. ANSI ATM High-Speed Signaling Link Loopback Support

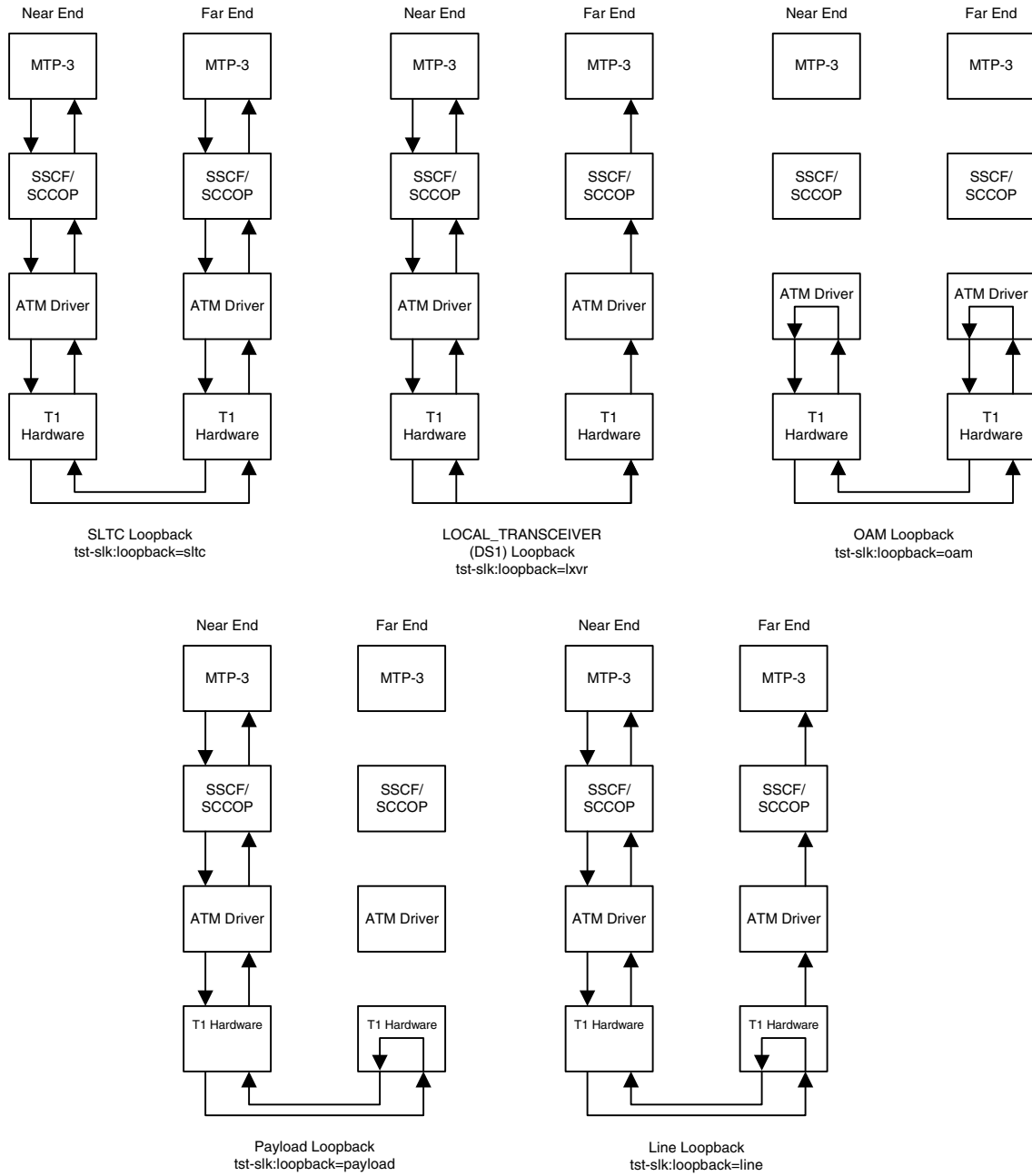
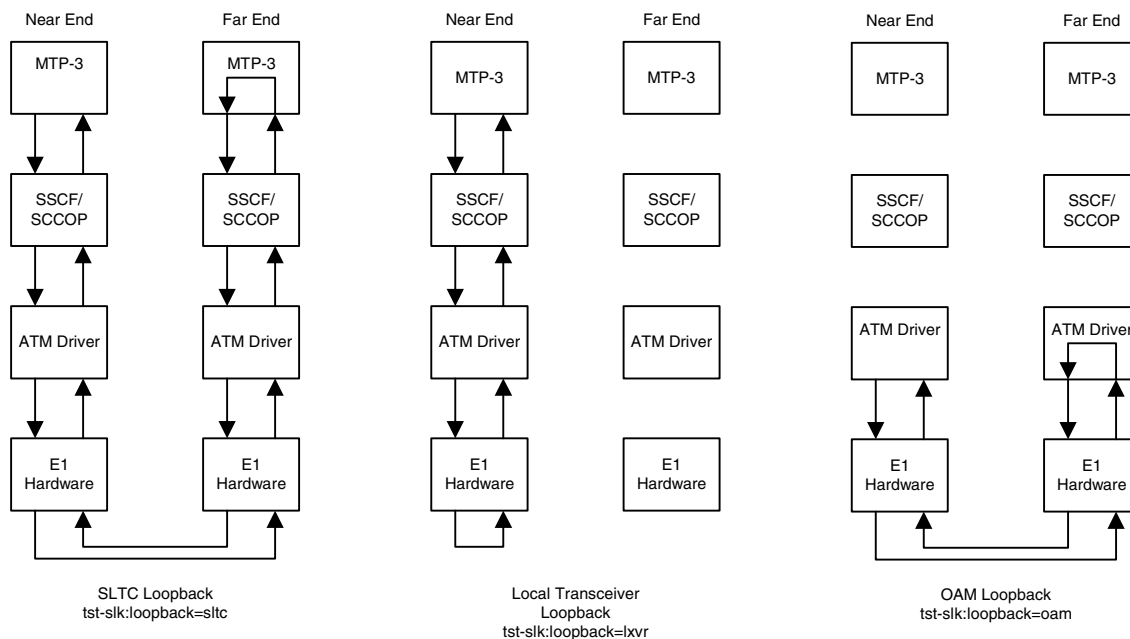

Figure C-10. E1 ATM High-Speed Signaling Link Loopback Support



Remote Loopback Support

The LIM containing the ATM high-speed signaling link must provide remote loopback support so that the EAGLE 5 SAS can act as the far end STP as shown in Figure C-9 on page C-21 or Figure C-10 on page C-22. The support provided for ATM high-speed signaling link cards is identical to low-speed signaling link cards by providing the same initialization and detection capabilities.

- **initialization** - The MTP-3 layer, independent of hardware interface, allows remote loopbacks when the link is deactivated. Upon receiving a bit-oriented code for a line or payload loopback, the ATM high-speed signaling link reprograms the AATM hardware if MTP-3 has determined a remote loopback is allowed.
- **detection** - Every 500 ms, the hardware is read to determine if remote loopback is in progress and the maintenance block is updated. This generates a UAM to the local node. For DS1 links, an AATM hardware register is read to determine if the T1 layer is currently configured for remote loopback.

Link Status Logging Capability

The Enhanced Link Diagnostics capability stores link status information. The link status information is divided into 2 categories: service data and alignment data. Currently, each logging routine can store up to 69 events, all of which can be displayed using the `rept-stat-slk` command. The service data and alignment data categories are described in the following sections.

Service Data Category

Service events and their timestamps are buffered during transitions between the In-Service/Data Transfer Ready states and all other states. This buffer contains a history of the link failure reasons (as seen from Level 2's point of view) and the subsequent realignments. Each entry in the buffer is either the link failure reason and time, or the time the link came back in service. Table C-3 on page C-23 provides a list of all high-speed signaling link failure reasons, however, not all of these failures will show up in the service data. Several types of failure that are recognized by Level 3 (like Changeover Order Received or Failed SLT) are mapped to a Stop Commanded event at Level 2. If the history indicates the link did not realign after the failure, the alignment data buffer shows the reason the link was unable to be realigned.

The service data history contains only the high-speed signaling link failure reason as seen by Level 2. As highlighted above, the actual failure reason can be hidden from the Level 2 Service Data if it is an event that is detected by level 3. For example, there are many reasons why Level 3 sends a Stop command to Level 2, such as link deactivated by user, changeover order received, false link congestion, etc. Therefore, the service data should only be used as a guide in determining a link failure.

Table C-3. High-Speed Signaling Link vs. Low-Speed Signaling Link Unavailability Reasons by Priority

High-Speed Signaling Link Unavailability Reason	Low-Speed Signaling Link Unavailability Reason
Remote Loopback	Remote Loopback
LOS	
LOF	
LCD	
Too Many Interrupts	Too Many Interrupts
	Stopped Receiving Data
ISERM threshold exceeded	
	SUERM
Remote Out of Service	

Table C-3. High-Speed Signaling Link vs. Low-Speed Signaling Link Unavailability Reasons by Priority (Continued)

High-Speed Signaling Link Unavailability Reason	Low-Speed Signaling Link Unavailability Reason
Remote Protocol Error	
Remote Management Initiated	
Remote Processor Outage	
Local Processor Outage	
Timer_No_Credit expired	
Timer_No_Response expired	
	T1 expired(ready, not ready)
	T3 expired
	T2 expired
	Exceeded Proving Period Count
	SIO received
	SIN received
	SIE received
	SIOS received
	SIPO received
	RC/BSNR link failure
	RC/FIBR link failure
	T6 expired
	T7 expired
COO Received	COO Received
False SLK Congestion	False SLK Congestion
SLK Restart Delayed	SLK Restart Delayed
Far End Loopback	Far End Loopback
Link Not Aligned (default)	Link Not Aligned (default)
Remote Blocked	Remote Blocked
Local Blocked	Local Blocked
Remote Inhibited	Remote Inhibited
Local Inhibited	Local Inhibited

ATM Signaling Link Configuration

Alignment Data Category

Alignment events are buffered at all times when link is not in service. Only the first unique occurrence of an event and its timestamp is buffered. High-speed signaling link alignment events are divided into:

- SSCOP, SSCF and MAAL state transitions
- SSCOP and SSCF transmitted PDUs
- SSCOP and SSCF received PDUs
- Special level 1 events.

Tables C-4, C-5, and C-6 list all the possible alignment events sorted by event type.

Table C-4. High-Speed Signaling Link State Transition Alignment Events

SSCOP	SSCF	MAAL
Idle	OOS Idle	OOS
Outgoing Conn. Pending	OOS ODP	Alignment
Incoming Conn. Pending	Alignment Idle	Proving
Outgoing Disc. Pending	Alignment OCP	Aligned/Ready
Outgoing Resync Pending	Alignment ODP	In Service
Incoming Resync Pending	Proving Data Transfer Ready	
Outgoing Recovery Pending	Aligned/Ready Data Transfer Ready	
Recovery Response Pending	In Service/Data Transfer Ready	
Incoming Recovery Pending		
Data Transfer Ready		

Table C-5. High-Speed Signaling Link Transmitted/Received Alignment PDUs

SSCOP	SSCF
BGN	Out of Service
BGAK	Processor Outage
END	In Service
ENDAK	Normal
RS	Emergency
RS AK	Alignment Not Successful
BGREJ	Mgmt Initiated
SD	Protocol Error

Table C-5. High-Speed Signaling Link Transmitted/Received Alignment PDUs (Continued)

SSCOP	SSCF
ER	Proving Not Successful
POLL	
STAT	
USTAT	
UD	
MD	
ERAK	

Table C-6. High-Speed Signaling Link Special Level 1 Alignment Events

Special Events
LCD
LCD Cleared
LOF
LOF Cleared
LOS
LOS Cleared
Too Many Interrupts
Stop Commanded

Display of Buffered Data

The buffered data are displayed using the `rept-stat-slk` command. All events are buffered with the day and time of the event. The buffered timestamp is displayed in a day of year and time of day format (YY-MM-DD HH:MM:SS.sss). The time of day and day of year are passed to the LIM card when polling for the maintenance block. A timer on the LIM card, with a 5 millisecond granularity, provides the millisecond portion of the time displayed. The user has the ability to request either alignment data, service data or both be displayed. A maximum of 69 service and/or alignment events are displayed. However, the user has the ability to display only the last 10 alignment events. See the *Commands Manual* for a description of the `rept-stat-slk` command.

Large MSUs

As shown in Figure C-3 on page C-5, a general purpose implementation of the ATM high-speed signaling link protocol stack would allow for large MSUs to be transferred across an ANSI or E1 ATM high-speed signaling link. The SSCOP layer can handle user data from SSCF that is up to 4096 bytes long. Since the SSCF layer does not add a trailer to MTP3 data, the ATM protocol stack is able to transfer MTP3 data packets up to 4096 bytes. When the SSCOP trailer is added, 4100 bytes of user data are handed to the AAL5CP layer.

These MSU sizes are much larger than the MTP3 data size currently supported by a low-speed signaling link. Currently, the largest MSU transferred on a low-speed signaling link is 279 bytes (2 flag bytes, 3 level 2 header bytes, 2 FCS bytes, and 272 bytes of MTP3 data). A large MSU is any MSU that contains 273 to 4096 bytes of MTP data.

The ATM high-speed signaling link (ANSI or E1) does not support large MSUs. Either UIM 1172 or 1173 is generated when a large MSU is received. See the "UIMs" section on page C-29 for more information on these UIMs.

Unsolicited Messages

There are two types of unsolicited messages that are generated, alarm messages (UAMs) and information messages (UIMs).

Link Unavailability UAMs

The signaling link UAM format includes a CLASS output. This identifies the corresponding link as either an MTP2 or SAAL link class (the SAAL link class is used for high-speed signaling links).

Example:

```
0044.0200    SLK 1201,A sp1          RCVRY-LKF: link available
              SLC=01    FECLLI=A1234567890                CLASS=SAAL

0044.0200    SLK 1202,A sp2          RCVRY-LKF: link available
              SLC=01    FECLLI=A1234567890                CLASS=MTP2
```

Table C-3 on page C-23 provides a summary of high-speed signaling link and low-speed signaling link unavailable reasons listed from highest priority to lowest.

Table C-7 on page C-28 shows the UAMs that correspond link failures on an high-speed signaling link. All signaling link alarms have a severity level of major, except for UAM 200, which shows that the link failure has been cleared. All alarms are output to the Link Maintenance output group.

Table C-7. Signaling Link Unsolicited Alarm Messages

Link Failure	UAM Number	UAM Text
Recovery: Link Available	0200	RCVRY-LKF: link available
Failure: Remote NE Loopback	0201	REPT-LKF: remote NE loopback
Failure: Hardware Problems	0202	REPT-LKF: HWP - too many link interrupts
Failure: Failed Remote FE Loopback	0202	REPT-LKF: remote FE loopback
Failure: MTP3 Changeover Order (COO) Message Received	0218	REPT-LKF: COO - rcvd changeover order
Management Inhibit: Remote	0234	REPT-LKF: RMI remote inhibited
Management Inhibit: Local	0235	REPT-LINK-MGTINH: local inhibited
Failure: Unresolved - Default failure reason	0236	REPT-LKF: not aligned
Failure: False Congestion Restart	0236	REPT-LKF: false congestion restart
Failure: MTP Link Restart Delayed	0236	REPT-LKF: MTP link restart delayed
Excessive Duration of Far End Receiving Congestion	0237	REPT-LKF: LM Timer NO-CREDIT expired
Excessive Delay of Acknowledgment	0238	REPT-LKF: XDA - Timer NO-RESPONSE expired
Local Processor Outage(management initiated)	0239	REPT-LKF: MBL - local processor outage
SSCF Remote Release: Remote Processor Outage	0240	REPT-LKF: rcvd SSCOP END-proc. outage
SSCF Remote Release: Out of Service	0241	REPT-LKF: rcvd SSCOP END-out of service
SSCF Remote Release: Protocol Error	0242	REPT-LKF: rcvd SSCOP END-protocol error
SSCF Remote Release: Management Initiated	0243	REPT-LKF: rcvd SSCOP END-mgmt initiated
Facility Outage - DS1 Loss of Signal failure	0244	REPT-LKF: FAC - DS1 LOS failure
Facility Outage - DS1 Loss of Frame failure	0245	REPT-LKF: FAC - DS1 LOF failure
Facility Outage - DS1 Loss of Cell Delineation failure	0246	REPT-LKF: FAC - DS1 LCD failure
Excessive In Service Error Rate	0247	REPT-LKF: XER - ISERM threshold exceeded

ATM Signaling Link Configuration

UIMs

There are two types UIMs generated with ATM high-speed signaling links, UIMs for large MSUs and UIMs for the loopback tests. UIMs 1172 and 1173 are generated for MTP MSUs (1172) and SCCP MSUs (1173).

The large MSUs are discarded at the receiving ATM high-speed signaling link rather than the outbound link.

UIM 1172 Example

```
0018.1172   CARD 1103   INFO REPT-OVSZMSG: MTP MSU too large to route.
            LEN=279   SIO=03   DPC=001-001-001   OPC=002-002-002
            LSN=A1234567
            Report Date: 97-10-30   Time: 16:27:19
```

UIM 1173 Example

```
0018.1173   CARD 1103   INFO REPT-OVSZMSG: SCCP MSU too large to route.
            LEN=279   SIO=03   DPC=001-001-001   OPC=002-002-002   MSG TYPE=09
            CDPA:  AI=8B   PC=003-003-003   SSN=005   TT=250   ADDR=1234567890
            CGPA:  AI=8B   PC=004-004-004   SSN=006   TT=251   ADDR=0123456789
            LSN=A1234567
            Report Date: 97-10-30   Time: 16:27:19
```

The UIMs shown in Table C-8 are generated when loopback tests performed on the ATM high-speed signaling link are completed.

Table C-8. Table 5 : Loopback Test UIMs

UIM #	Severity	Message Text	UIM is Generated When ...
1156	None	Loopback success	loopback test passes.
1157	None	Loopback failed	loopback test failed.
1158	None	Loopback aborted	request to activate link is received while running a loopback.
1159	None	Loopback in progress	loopback request received while the same loopback test is already in progress.
1170	None	Loopback prevented	loopback setup was not performed because the specified type of loopback requires a BOC to be transmitted and this function was prevented from transmitting a BOC.
1171	None	Loopback invalid	loopback setup was not performed because invalid parameters were provided.

ATM High-Speed Signaling Link Configuration

An ATM high-speed signaling link is configured using these commands:

- **ent-card** - Used to add either the ANSI ATM or E1 ATM LIMs
- **ent-slk** - Used to add the signaling link
- **chg-atm-lps** - Used to change the ATM signaling link parameters. The ATM signaling link parameters control the behavior of the ATM high-speed signaling links. These parameters are not configured with the **ent-slk** command and are assigned default values when the ATM high-speed signaling link is added to the database.

To configure an ATM high-speed signaling link, perform these procedures:

- “Adding a High-Speed LIM-ATM or an E1-ATM LIM” procedure on page C-31
- “Adding an ATM High-Speed Signaling Link” procedure on page C-34
- “Changing an ATM High-Speed Signaling Link Parameter Set” procedure on page C-50.

Procedures for configuring the linksets and routes, and for removing SS7 signaling links (which includes ATM high-speed signaling links), are contained in Chapter 3, “SS7 Configuration.” The procedure for removing the LIM containing the ATM high-speed signaling link is contained in the *Database Administration Manual - System Management*. These procedures contain no information that is specific to ATM high-speed signaling links, therefore, are not included in this appendix.

The procedures contained in this appendix use a variety of commands. If more information on these commands is needed, go to the *Commands Manual* to find the required information.

Adding a High-Speed LIM-ATM or an E1-ATM LIM

This procedure is used to add a high-speed LIM-ATM or an E1-ATM LIM to the database using the `ent-card` command.

The `ent-card` command uses these parameters.

:loc – The location of the card being added to the database.

:type – The type of card being added to the database.

:appl – The application software that is assigned to the card.

:force – If the global title translation feature is on, the `force=yes` parameter allows the LIM to be added to the database even if the current SCCP transactions-per-second threshold is unable to support the additional SCCP transaction-per-second capacity created by adding the LIM. This parameter is obsolete and is no longer used.

Table C-9 shows the valid card type (`type`) and card application (`appl`) combinations for the ATM high-speed LIMs being added to the database and the names and part numbers of the hardware. This can be used to verify that the ATM high-speed LIM being added to the database matches the card physically installed in the EAGLE 5 SAS. See the “Determining the Number of High-Speed and Low-Speed Signaling Links” section on page D-2 for information on the maximum number of ATM high-speed LIMs that can be configured in the database.

Table C-9. ATM High-Speed LIM Card Type and Card Application Combinations

Card Name	Part Number	Card Type (:type)	Application Type (:appl)
LIM-ATM	870-1293-XX	limatm	atmansi
E1-ATM	870-2455-XX	lime1atm	atmitu

The shelf to which the card is to be added, must already be in the database. This can be verified with the `rtv-shlf` command. If the shelf is not in the database, go to the “Adding a Shelf” procedure in the *Database Administration Manual - System Management* and add the shelf.

The examples in this procedure are used to add the cards shown in Table C-10 to the database.

Table C-10. Example Card Configuration

Card Type	Application	Card Location
limatm	atmansi	1318
lime1atm	atmitu	1201

Procedure

1. Display the cards in the database using the **rtrv-card** command. This is an example of the possible output.

```
rlghncxa03w 05-09-28 09:12:36 GMT EAGLE5 34.0.0
CARD  TYPE      APPL      LSET NAME  LINK SLC LSET NAME  LINK SLC
1102  TSM           GLS
1113  GSPM          EOAM
1114  TDM-A
1115  GSPM          EOAM
1116  TDM-B
1117  MDAL
1117  MDAL
1201  LIMDS0       SS7ANSI  sp2        A      0      sp1        B      0
1203  LIMDS0       SS7ANSI  sp3        A      0
1204  LIMDS0       SS7ANSI  sp3        A      1
1206  LIMDS0       SS7ANSI  nsp3       A      1      nsp4       B      1
1207  LIMV35       SS7GX25  nsp1       A      0
1208  LIMV35       SS7GX25  nsp1       A      1
1216  ACMENET      STPLAN
1301  TSM          SCCP
1308  LIMDS0       SS7ANSI  sp6        A      1      sp7        B      0
1314  LIMDS0       SS7ANSI  sp7        A      1      sp5        B      1
1317  ACMENET      STPLAN
```

The cards should be distributed throughout the EAGLE 5 SAS for proper power distribution. Refer to the *Installation Manual - EAGLE 5 SAS* for the shelf power distribution.

2. Using Table C-9 on page C-31 as a reference, verify that the card has been physically installed into the proper location.
-

3. Add the card using the **ent-card** command. For this example, enter these commands.

```
ent-card:loc=1318:type=limatm:appl=atmansi
```

```
ent-card:loc=2101:type=limelatm:appl=atmitu
```

When each of these commands have successfully completed, this message should appear.

```
rlghncxa03w 05-09-12 09:12:36 GMT EAGLE5 34.0.0
ENT-CARD: MASP A - COMPLTD
```

4. Verify the changes using the **rtrv-card** command with the card location specified. For this example, enter these commands.

```
rtrv-card:loc=1318
```

This is an example of the possible output.

```
rlghncxa03w 05-09-28 09:12:36 GMT EAGLE5 34.0.0
CARD  TYPE      APPL      LSET NAME  LINK SLC LSET NAME  LINK SLC
1318  LIMATM      ATMANSI
```

ATM Signaling Link Configuration

rtrv-card:loc=2101

This is an example of the possible output.

```
rlghncxa03w 05-09-28 09:12:36 GMT EAGLE5 34.0.0
CARD  TYPE      APPL      LSET NAME      LINK SLC LSET NAME      LINK SLC
2101  LIME1ATM  ATMITU
```

5. Back up the new changes using the **chg-db:action=backup:dest=fixed** command. These messages should appear, the active Maintenance and Administration Subsystem Processor (MASP) appears first.

```
BACKUP (FIXED) : MASP A - Backup starts on active MASP.
BACKUP (FIXED) : MASP A - Backup on active MASP to fixed disk complete.
BACKUP (FIXED) : MASP A - Backup starts on standby MASP.
BACKUP (FIXED) : MASP A - Backup on standby MASP to fixed disk complete.
```

Flowchart C-1. Adding a High-Speed LIM-ATM or an E1-ATM LIM

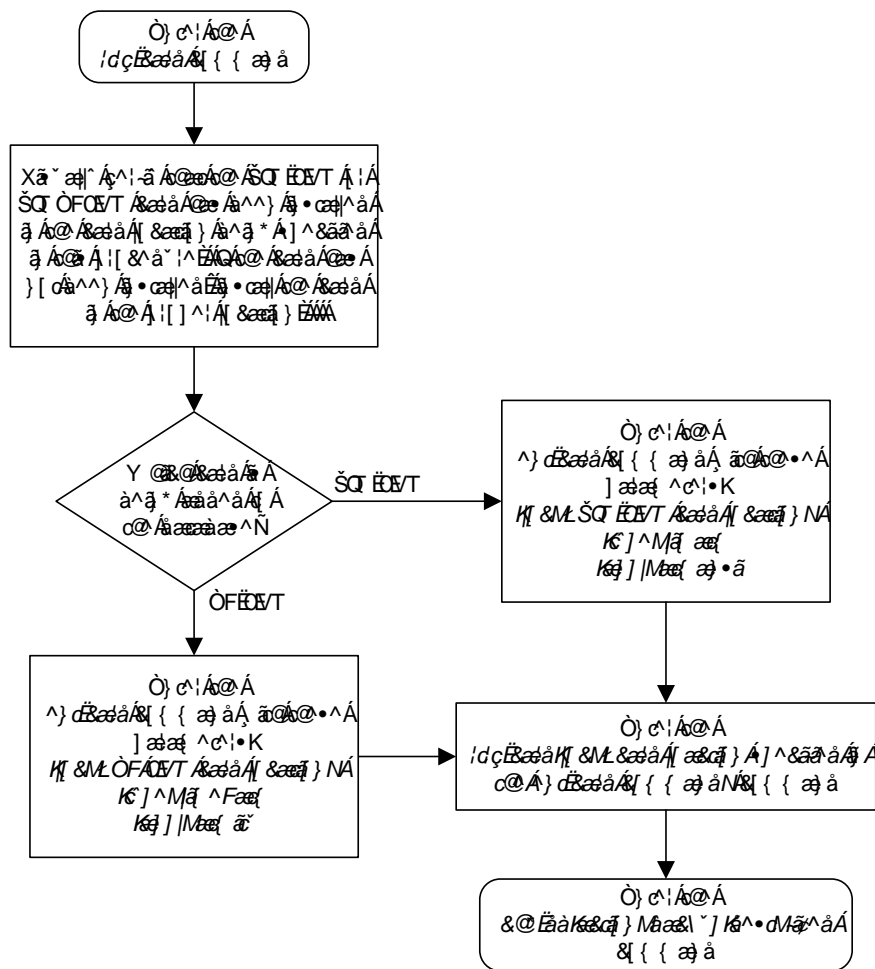

Adding an ATM High-Speed Signaling Link

This procedure is used to add an ANSI ATM or E1 ATM high-speed signaling link to the database using the `ent-slk` command. The `ent-slk` command uses these parameters.

- :loc** – The card location of the LIM that the ATM high-speed signaling link will be assigned to. The cards specified by this parameter are LIM-ATM or LIME1ATM cards.
- :link**– The signaling link on the card specified in the `loc` parameter.
- :lsn** – The name of the linkset that will contain the signaling link.
- :slc** – The signaling link code. The SLC must be unique within the linkset. It must be the same at both the EAGLE 5 SAS location and the distant node.
- :bps** – The transmission rate for the link in bits per second.
- :tset** – Transmitter signal element timing
- :lpset** – link parameter set identifier – the ATM signaling parameter set. An ATM signaling link can be assigned to any of 30 parameter sets.
- :atmtsel** – ATM timing selector – The source of the timing for the ATM signaling link, internal, line, or external. Internal timing for an ANSI ATM signaling link is derived from an internal clock source operating at 1.544 MHz \pm 50 ppm. For an E1 ATM signaling link, internal timing is derived from an internal clock source operating at 2.048 MHz \pm 50 ppm. Line timing is derived from its received data stream, if present. External timing is derived from a clock source external to the EAGLE 5 SAS. Line timing is the default value for this parameter.



CAUTION: The `atmtsel=internal` parameter is only supported for lab use and not for live traffic.

NOTE: If the `atmtsel=external` parameter is specified with the `ent-slk` command, make sure that the correct TDM (P/N 870-0774-10 or later) is installed in card slots 1114 and 1116. Make sure that the external master clock source is connected to the EAGLE 5 SAS.

NOTE: To use an external high-speed master clock source other than RS-422, TDMs 870-0774-15 or later must be installed in card locations 1114 and 1116, and the TDM Global Timing Interface options must be configured. For more information, see the “Configuring the Options for the TDM Global Timing Interface” procedure on page 3-263.

- :vci** – virtual channel identifier – The identifier of the virtual channel used by the ATM signaling link for virtual channel connections.
- :vpi** – virtual path identifier – The identifier of the virtual path used by the ATM signaling link for virtual path connections.
- :ll** – The length of the cable used for the ANSI ATM signaling link. The value of the `ll` parameter is from 0 to 7, with each number representing a range of cable lengths, shown in Table C-11 on page C-35. The default value for this parameter is 0.

ATM Signaling Link Configuration

Table C-11. ATM Signaling Link Cable Lengths

LL Parameter Value	ATM Signaling Link Cable Length
0	0 to 110 feet
1	110 to 220 feet
2	220 to 330 feet
3	330 to 440 feet
4	440 to 550 feet
5	550 to 660 feet
6	more than 660 feet
7	used for external line buildout networks

:e1atmcrc4 – Specifies whether or not CRC4 is enabled on the E1 ATM high-speed signaling link.

:e1atmsi – Specifies the value of the two spare international bits of NFAS data, from 0 to 3 for the E1 ATM high-speed signaling link.

:e1atmsn – Specifies the value of the five spare national bits of NFAS data, from 0 to 31 for the E1 ATM high-speed signaling link.

The **ent-slk** command also contains these parameters: **l2tset**, **l1mode**, **tset**, **ecm**, **pcrn1**, **pcrn2**, **iplim12**, **ts**, **elport**, **e1loc**, **t1port**, and **t1loc**. These parameters are used only for configuring other types signaling links and are not used in this procedure. For more information on these signaling links, go to one of these sections:

- Low-speed and IP signaling links – “Adding an SS7 Signaling Link” on page 3-130
- E1 signaling links – Appendix A, “E1 Interface.”
- T1 signaling links – Appendix B, “T1 Interface.”
- X.25 signaling links – “Adding an X.25 Signaling Link” in the *Database Administration Manual - Features*.

These items must be configured in the database before an ATM high-speed signaling link can be added:

- Shelf – see “Adding a Shelf” in the *Database Administration Manual - System Management*
- Card – see “Adding a High-Speed LIM-ATM or an E1-ATM LIM” on page C-31
- Destination Point Code – see “Adding a Destination Point Code” on page 2-191
- Linkset – see “Adding an SS7 Linkset” on page 3-16.

Verify that the link has been physically installed (all cable connections have been made).

To configure the EAGLE 5 SAS to perform circular routing detection test on the signaling links, “Configuring Circular Route Detection” procedure on page 3-231.

NOTE: Circular route detection is not supported in ITU networks.

To provision a EAGLE 5 SAS with more than 700 signaling links, the EAGLE 5 SAS must have certain levels of hardware installed. See the “Requirements for EAGLE 5 SASs Containing more than 700 Signaling Links” section on page D-2 for more information on these hardware requirements.

The EAGLE 5 SAS can contain a mixture of low-speed, E1, T1, ATM high-speed, and IP signaling links. The “Determining the Number of High-Speed and Low-Speed Signaling Links” section on page D-2 describes how to determine the quantities of the different types of signaling links the EAGLE 5 SAS can have.

ATM High-Speed Signaling Link Parameter Combinations

Table C-12 shows the parameter combinations that can be specified for ATM high-speed signaling links with the `ent-slk` command, and the parameters and values that can be used to provision each type of ATM high-speed signaling link.

Table C-12. ATM High-Speed Signaling Link Parameter Combinations

ATM (ANSI) High-Speed Signaling Link	E1 ATM High-Speed Signaling Link
Mandatory Parameters	
:loc = location of the LIM-ATM with the ATMANSI application and the LIMATM card type.	:loc = location of the E1 HSL card with the ATMITU application and the LIME1ATM card type.
:link = A ⁴	:link = A ⁴
:lsn = linkset name ¹	:lsn = linkset name ^{1,2}
:slc = 0 - 15	:slc = 0 - 15
Optional Parameters	
:bps = 1544000 default value = 1544000	:bps = 2048000 default value = 2048000
:lpset = 1 - 30 default value = 1	:lpset = 1 - 30 default value = 1
:atmtsel = line, internal, external default value = line	:atmtsel = line, internal, external default value = line
:vci = 0 - 65535 ³ default value = 5	:vci = 0 - 65535 ³ default value = 5
:vpi = 0 - 4095 default value = 0	:vpi = 0 - 4095 default value = 0
:ll = 0 - 7 default value = 0	:e1atmcrc4 = on, off default value = off
	:e1atmsi = 0 - 3 default value = 3
	:e1atmsn = 0 - 31 default value = 0

ATM Signaling Link Configuration

Table C-12. ATM High-Speed Signaling Link Parameter Combinations (Continued)

ATM (ANSI) High-Speed Signaling Link	E1 ATM High-Speed Signaling Link
Notes: 1. The linkset adjacent point code (APC) type must match the card's application (ATMANSI - ANSI APC/ATMITU - ITU-I, ITU-N APC). The domain of the linkset adjacent point code must be SS7. A linkset can contain a maximum of 16 signaling links. 2. E1 ATM signaling links (signaling links assigned to cards running the ATMITU application) cannot be assigned to linksets containing 24-bit ITU-N APCs (APCN24) or SAPCs (SAPCN24). 3. The values 0 - 4 and 6 - 31 cannot be specified for the <code>vci</code> parameter. These values are reserved. 4. The <code>port</code> parameter can be used in place of the <code>link</code> parameter to specify the signaling link on the card.	

Example Signaling Link Configuration

Table C-13. ANSI High-Speed ATM Signaling Link Configuration Table

SLK		LSN	SLC	TYPE	BPS	LPSET	ATMTSEL	VCI	VPI	LL
LOC	LINK									
1302	A	ATMANSI0	0	LIMATM	1544000	3	EXTERNAL	35	15	0
1305	A	ATMANSI1	0	LIMATM	1544000	4	INTERNAL	100	20	2
1318	A	ATMANSI1	1	LIMATM	1544000	9	LINE	150	25	4

Table C-14. E1 High-Speed ATM Signaling Link Configuration Table

SLK		LSN	SLC	TYPE	BPS	LPSET	ATMTSEL
LOC	LINK						
2101	A	ATMITU1	0	LIME1ATM	2048000	25	LINE
2105	A	ATMITU1	1	LIME1ATM	2048000	25	LINE
SLK		VCI	VPI	E1ATMCRC4	E1ATMSI	E1ATMSN	
LOC	LINK						
2101	A	150	25	ON	1	20	
2105	A	35	15	ON	2	15	

Canceling the REPT-STAT-SLK and RTRV-SLK Commands

Because the `rept-stat-slk` and `rtrv-slk` commands used in this procedure can output information for a long period of time, the `rept-stat-slk` and `rtrv-slk` commands can be canceled and the output to the terminal stopped. There are three ways that the `rept-stat-slk` and `rtrv-slk` commands can be canceled.

- Press the **F9** function key on the keyboard at the terminal where the `rept-stat-slk` or `rtrv-slk` commands were entered.
- Enter the `canc-cmd` without the `trm` parameter at the terminal where the `rept-stat-slk` or `rtrv-slk` commands were entered.
- Enter the `canc-cmd:trm=<xx>`, where `<xx>` is the terminal where the `rept-stat-slk` or `rtrv-slk` commands were entered, from another terminal other than the terminal where the `rept-stat-slk` or `rtrv-slk` commands were entered. To enter the `canc-cmd:trm=<xx>` command, the terminal must allow Security Administration commands to be entered from it and the user must be allowed to enter Security Administration commands. The terminal's permissions can be verified with the `rtrv-secu-trm` command. The user's permissions can be verified with the `rtrv-user` or `rtrv-secu-user` commands.

For more information about the `canc-cmd` command, go to the *Commands Manual*.

Procedure

1. Display the current signaling link configuration using the `rtrv-slk` command. This is an example of the possible output.

```
rlghncxa03w 05-09-19 21:16:37 GMT EAGLE5 34.0.0

LOC LINK LSN          SLC TYPE      L2T      L1      PCR PCR
                SET  BPS      MODE TSET  ECM  N1  N2
1201 B   lsa1          0 LIMDS0      1   56000  --- --- BASIC --- -----
1203 B   lsa2          0 LIMDS0      1   56000  --- --- BASIC --- -----
1205 A   lsa3          0 LIMV35      3   64000  DCE  ON  BASIC --- -----
1207 A   lsn1207a      0 LIMDS0      1   56000  --- --- BASIC --- -----
1207 B   lsn1207b      0 LIMDS0      1   56000  --- --- BASIC --- -----
1214 A   lsn1214a      0 LIMV35      2   64000  DTE  --- PCR  76  3800
1214 B   lsa3          1 LIMV35      3   64000  DCE  ON  BASIC --- -----

LOC LINK LSN          SLC TYPE      LP      ATM
                SET  BPS      TSEL      VCI  VPI  LL
                LP      ATM
                SET  BPS      TSEL      VCI  VPI  CRC4 SI SN
E1ATM

No Links Set up.

LOC LINK LSN          SLC TYPE      IPLIML2

No Links Set up.

LOC LINK LSN          SLC TYPE

No Links Set up.
```

ATM Signaling Link Configuration

```

LOC LINK LSN          SLC TYPE          L2T          PCR PCR  E1  E1
                               SET BPS      ECM  N1  N2  LOC PORT TS

```

No Links Set up.

```

LOC LINK LSN          SLC TYPE          L2T          PCR PCR  T1  T1
                               SET BPS      ECM  N1  N2  LOC PORT TS

```

No Links Set up.

SLK table is (7 of 1200) 1% full.

NOTE: If the `rtrv-slk` output in step 1 shows that the maximum number of signaling links is 1500, skip step 2 and go to step 3.

NOTE: If the `rtrv-slk` output in step 1 shows that the maximum number of signaling links is 1200, and the signaling link being added increases the number beyond 1200, do not perform step 2, but go to “Enabling the Large System # Links Controlled Feature” procedure on page 3-10 and enable the Large System # Links controlled feature for 1500 signaling links. Then go to step 3.

NOTE: If the `rtrv-slk` output in step 1 shows that the maximum number of signaling links is 1200, and the signaling link being added will not increase the number beyond 1200, skip step 2 and go to step 3.

2. Display the status of the Large System # Links controlled feature by entering the `rtrv-ctrl-feat` command. The following is an example of the possible output.

```

rlghncxa03w 05-09-28 21:15:37 GMT EAGLE5 34.0.0
The following features have been permanently enabled:

```

Feature Name	Partnum	Status	Quantity
IPGWx Signaling TPS	893012814	on	20000
ISUP Normalization	893000201	on	----
Command Class Management	893005801	on	----
LNP Short Message Service	893006601	on	----
Intermed GTT Load Sharing	893006901	on	----
XGTT Table Expansion	893006101	off	----
XMAP Table Expansion	893007701	off	----
HC-MIM SLK Capacity	893012707	on	64

The following features have been temporarily enabled:

Feature Name	Partnum	Status	Quantity	Trial Period Left
Zero entries found.				

The following features have expired temporary keys:

Feature Name	Partnum
Zero entries found.	

If the Large System # Links controlled feature is not enabled or on, go to “Enabling the Large System # Links Controlled Feature” procedure on page 3-10 and enable Large System # Links controlled feature for 1500 signaling links. Then go to step 3.

3. Display the cards in the database using the `rtrv-card` command. This is an example of the possible output.

```

rlghncxa03w 05-09-28 09:12:36 GMT EAGLE5 34.0.0
CARD   TYPE      APPL      LSET NAME   LINK SLC LSET NAME   LINK SLC
1101   TSM           SCCP
1102   TSM           GLS
1103   DCM           VXWSLAN
1113   GSPM          EOAM
1114   TDM-A
1115   GSPM          EOAM
1116   TDM-B
1117   MDAL
1201   LIMDS0       SS7ANSI   lsa1        B      0
1202   LIMV35       SS7ANSI
1203   LIMDS0       SS7ANSI   lsa2        B      0
1204   LIMDS0       SS7ANSI
1205   LIMV35       SS7ANSI   lsa3        A      0
1206   LIMV35       SS7ANSI
1207   LIMDS0       SS7ANSI   lsn1207a   A      0   lsn1207b   B      0
1208   LIMDS0       SS7ANSI
1212   LIMV35       SS7ANSI
1213   LIMDS0       SS7ANSI
1214   LIMV35       SS7ANSI   lsn1214a   A      0   lsa3        B      1
1215   LIMDS0       SS7ANSI
1301   LIMV35       ATMANSI
1302   LIMATM       ATMANSI
1304   LIMV35       SS7ANSI
1305   LIMATM       ATMANSI
1308   LIMV35       SS7ANSI
1311   LIMDS0       SS7ANSI
1313   LIMDS0       SS7ANSI
1315   LIMV35       CCS7ITU
1317   LIMV35       CCS7ITU
1318   LIMATM       ATMANSI

```

If the required ATM high-speed LIM is not in the database, perform the “Adding a High-Speed LIM-ATM or an E1-ATM LIM” procedure on page C-31 and add the ATM high-speed LIM to the database.

4. Display the current linkset configuration using the `rtrv-ls` command. This is an example of the possible output.

```

rlghncxa03w 05-09-10 11:43:04 GMT EAGLE5 34.0.0

LSN          APCA      (SS7)  SCRNR  SET  SET  BEI  LST  LNKS  ACT  MES  DIS  SLSCI  NIS
e1e2         001-207-000  none  1    1    no  B    6    off  off  off  no    off
ls1305      000-005-000  none  1    1    no  A    1    off  off  off  no    off
ls1307      000-007-000  none  1    1    no  A    1    off  off  off  no    off
e1m1s1     001-001-001  none  1    1    no  A    7    off  off  off  no    off
e1m1s2     001-001-002  none  1    1    no  A    7    off  off  off  no    off

LSN          APCA      (X25)  SCRNR  SET  SET  BEI  LST  LNKS  ACT  MES  DIS  SLSCI  NIS

LSN          APCI      (SS7)  SCRNR  SET  SET  BEI  LST  LNKS  ACT  MES  DIS  SLSCI  NIS
e1e2i       1-207-0    none  1    1    no  B    4    off  off  off  ---   on
ls1315     0-015-0    none  1    1    no  A    1    off  off  off  ---   off
ls1317     0-017-0    none  1    1    no  A    1    off  off  off  ---   on
e1m2s1     1-011-1    none  1    1    no  A    7    off  off  off  ---   off

```

ATM Signaling Link Configuration

```

elm2s2      1-011-2      none 1 1 no A 7 off off off --- off
                                     L3T SLT      GWS GWS GWS
LSN         APCN   (SS7)  SCRN SET SET BEI LST LNKS ACT MES DIS SLSCI NIS
                                     L3T SLT      GWS GWS GWS
LSN         APCN24 (SS7)  SCRN SET SET BEI LST LNKS ACT MES DIS SLSCI NIS
                                     L3T SLT      GWS GWS GWS
LSN (CHINA) APCN   (SS7)  SCRN SET SET BEI LST LNKS ACT MES DIS SLSCI NIS
                                     L3T SLT      GWS GWS GWS
LSN (CHINA) APCN24 (SS7)  SCRN SET SET BEI LST LNKS ACT MES DIS SLSCI NIS

```

Link set table is (10 of 1024) 1% full.

If the required linkset is not in the database, go to the “Adding an SS7 Linkset” procedure on page 3-17 and add the linkset to the database.

If you plan to use a linkset shown in this step, or a new linkset is being added in this step, skip step 5 and go to step 6.

NOTE: If an ANSI ATM high-speed signaling link is being added to the database, skip step 5 and go to step 6.

5. Display the linkset that the signaling link is being assigned to using the `rtrv-ls` command, specifying the name of the linkset that the signaling link is being assigned to. For this example, enter this command.

```
rtrv-ls:lsn=atmitul
```

This is an example of the possible output.

```

rlghncxa03w 05-09-17 11:43:04 GMT EAGLE5 34.0.0

LSN         APCI   (SS7)  SCRN SET SET BEI LST LNKS ACT MES DIS SLSCI NIS
atmitul     3-111-3      none 1 1 no A 0 off off off --- off

CLLI          TFATCABMLQ MTPRSE ASL8 SLSRSB ITUTFR IPGWAPC
----- 1          ---  --- 1 off no

LOC LINK SLC TYPE      L2T      L1      PCR PCR
SET BPS      MODE TSET ECM  N1  N2

LOC LINK SLC TYPE      LP      ATM
SET BPS      TSEL      VCI  VPI  LL

LOC LINK SLC TYPE      LP      ATM      E1ATM
SET BPS      TSEL      VCI  VPI  CRC4 SI SN

LOC LINK SLC TYPE      IPLIML2

LOC LINK SLC TYPE

LOC LINK SLC TYPE      L2T      PCR PCR E1 E1
SET BPS      ECM  N1  N2  LOC PORT TS

LOC LINK SLC TYPE      L2T      PCR PCR T1 T1
SET BPS      ECM  N1  N2  LOC PORT TS

```

```
SAPCN
1234-aa
1235-bb
1200-zz
```

Link set table is (13 of 1024) 1% full.

Linksets containing 24-bit ITU-N adjacent point codes (**APCN24**) or secondary adjacent point codes (**SAPCN24**) cannot be assigned to a E1 ATM high-speed signaling link. Go back to step 4 and choose another linkset, or go to the “Adding an SS7 Linkset” procedure on page 3-17 and add the linkset to the database that does not contain either a 24-bit ITU-N APC or SAPC.

6. Display the existing values for the ATM link parameter set that will be assigned to the signaling link using the `rtrv-atm-lps` command specifying the link parameter set. For this example, enter this command.

```
rtrv-atm-lps:lpset=25
```

This is an example of the possible output.

```
rlghncxa03w 05-09-28 16:02:05 GMT EAGLE5 34.0.0
ATM LINK PARAMETER SET TIMERS AND PARAMETERS (TIMERS IN SECONDS)
                                SSCOP PARAMETERS
                                TMR  TMR    TMR    TMR    TMR
LPSET  MAXCC  MAXPD  MAXSTAT  CC  KALIVE  NORSP  POLL  IDLE
25     4      500    67      0.2 0.125   1.5    0.150 0.125

                                SSCF-NNI PARAMETERS
                                TMRT1  TMRT2  TMRT3  N1
                                05.0    30.0   0.000925 1000

                                SAAL PARAMETERS
                                MAX  TMR  TNRNO  TMR  N  TMR
                                NRP  SREC  CRED  ERM  BLK  PROV
                                0    3600  1.5   0.125  3   0600.0

                                NONCONFIGURABLE PARAMETERS
                                SDU  UU    FC  FC
                                SIZE SIZE N  NR  BC  TSUP  TLOSS  ERMSM  THRES
                                272  4    9  --  --  120  1.3   0.1    0.244
```

If you wish to change the values in this ATM parameter set, go to the “Changing an ATM High-Speed Signaling Link Parameter Set” procedure on page C-50.



CAUTION: Changing the values in this ATM link parameter set will impact the performance of all the signaling links using this ATM parameter set.

7. Add the signaling link to the database using the `ent-slk` command. Use Table C-12 on page C-36 as a guide for the parameters that can be specified with the `ent-slk` command. For this example, enter these commands.

```
ent-slk:loc=1302:link=a:lsn=atmansi0:slc=0:bps=1544000:lpset=3
:atmtsel=external:vci=35:vpi=15:ll=0
```

ATM Signaling Link Configuration

```
ent-slk:loc=1305:link=a:lsn=atmansil:slc=0:bps=1544000:lpset=4
:atmtsel=internal:vci=100:vpi=20:ll=2
```

```
ent-slk:loc=1318:link=a:lsn=atmansil:slc=1:bps=1544000:lpset=9
:atmtsel=line:vci=150:vpi=25:ll=4
```

```
ent-slk:loc=2101:link=a:lsn=atmitu1:slc=0:bps=2048000:lpset=25
:atmtsel=line:vci=150:vpi=25:elatmcrc4=on:elatmsi=1
:elatmsn=20
```

```
ent-slk:loc=2105:link=a:lsn=atmitu1:slc=1:bps=2048000:lpset=25
:atmtsel=line:vci=35:vpi=15:elatmcrc4=on:elatmsi=2
:elatmsn=15
```

When each of these commands have successfully completed, this message should appear.

```
rlghncxa03w 05-09-07 08:29:03 GMT EAGLE5 34.0.0
ENT-SLK: MASP A - COMPLTD
```

8. Verify the changes using the **rtrv-slk** command with the **loc** and **link** parameter values specified in step 7. For this example, enter these commands.

```
rtrv-slk:loc=1302:link=a
```

This is an example of the possible output.

```
rlghncxa03w 05-09-19 21:16:37 GMT EAGLE5 34.0.0
```

LOC	LINK	LSN	SLC	TYPE	LP	BPS	ATM	VCI	VPI	LL
					SET		TSEL			
1302	A	atmansio	0	LIMATM	3	1544000	EXTERNAL	35	15	0

```
rtrv-slk:loc=1305:link=a
```

This is an example of the possible output.

```
rlghncxa03w 05-09-19 21:16:37 GMT EAGLE5 34.0.0
```

LOC	LINK	LSN	SLC	TYPE	LP	BPS	ATM	VCI	VPI	LL
					SET		TSEL			
1305	A	atmansil	0	LIMATM	4	1544000	INTERNAL	100	20	2

```
rtrv-slk:loc=1318:link=a
```

This is an example of the possible output.

```
rlghncxa03w 05-09-19 21:16:37 GMT EAGLE5 34.0.0
```

LOC	LINK	LSN	SLC	TYPE	LP	BPS	ATM	VCI	VPI	LL
					SET		TSEL			
1318	A	atmansio	1	LIMATM	9	1544000	LINE	150	25	4

```
rtrv-slk:loc=2101:link=a
```

This is an example of the possible output.

```
rlghncxa03w 05-09-19 21:16:37 GMT EAGLE5 34.0.0
```

LOC	LINK	LSN	SLC	TYPE	LP	BPS	ATM	VCI	VPI	CRC4	SI	SN
					SET		TSEL					
2101	A	atmitu1	0	LIME1ATM	5	2.048M	LINE	150	2	ON	1	20

rtrv-slk:loc=2105:link=a

This is an example of the possible output.

```
rlghncxa03w 05-09-19 21:16:37 GMT EAGLE5 34.0.0
```

LOC	LINK	LSN	SLC	TYPE	LP	ATM	VCI	VPI	CRC4	SI	SN
2105	A	atmitu1	1	LIME1ATM	5	2.048M LINE	35	15	ON	2	15

- If the signaling link added in step 7 was the first signaling link assigned to the card, that card must be brought into service with the **rst-card** command, specifying the location of the card. For this example, enter these commands.

```
rst-card:loc=1302
rst-card:loc=1305
rst-card:loc=1318
rst-card:loc=2101
rst-card:loc=2105
```

When each of these commands have successfully completed, this message should appear.

```
rlghncxa03w 05-09-23 13:05:05 GMT EAGLE5 34.0.0
Card has been allowed.
```

- Activate all signaling links on the cards using the **act-slk** command, specifying the card location and signaling link specified in step 7. For this example, enter these commands.

```
act-slk:loc=1302:link=a
act-slk:loc=1305:link=a
act-slk:loc=1318:link=a
act-slk:loc=2101:link=a
act-slk:loc=2105:link=a
```

When each of these commands have successfully completed, this message should appear.

```
rlghncxa03w 05-09-07 08:31:24 GMT EAGLE5 34.0.0
Activate Link message sent to card
```

- Check the status of the signaling links added in step 7 using the **rept-stat-slk** command with the **loc** and **link** parameter values specified in step 7. The state of each signaling link should be in service normal (**IS-NR**) after the link has completed alignment (shown in the **PST** field). For this example, enter these commands.

rept-stat-slk:loc=1302:link=a

This is an example of the possible output.

```
rlghncxa03w 05-09-19 21:16:37 GMT EAGLE5 34.0.0
```

SLK	LSN	CLLI	PST	SST	AST	
1302,A	atmansio	-----	IS-NR	Avail	----	
ALARM STATUS		= No Alarms				

ATM Signaling Link Configuration

```
UNAVAIL REASON      = --  
Command Completed.
```

```
rept-stat-slk:loc=1305:link=a
```

This is an example of the possible output.

```
rlghncxa03w 05-09-19 21:16:37 GMT EAGLE5 34.0.0  
SLK      LSN      CLLI      PST      SST      AST  
1305,A   atmansil  -----  IS-NR      Avail    ----  
  ALARM STATUS      = No Alarms  
  UNAVAIL REASON    = --  
Command Completed.
```

```
rept-stat-slk:loc=1318:link=a
```

This is an example of the possible output.

```
rlghncxa03w 05-09-19 21:16:37 GMT EAGLE5 34.0.0  
SLK      LSN      CLLI      PST      SST      AST  
1318,A   atmansil  -----  IS-NR      Avail    ----  
  ALARM STATUS      = No Alarms  
  UNAVAIL REASON    = --  
Command Completed.
```

```
rept-stat-slk:loc=2101:link=a
```

This is an example of the possible output.

```
rlghncxa03w 05-09-19 21:16:37 GMT EAGLE5 34.0.0  
SLK      LSN      CLLI      PST      SST      AST  
2101,A   atmitul  -----  IS-NR      Avail    ----  
  ALARM STATUS      = No Alarms  
  UNAVAIL REASON    = --  
Command Completed.
```

```
rept-stat-slk:loc=2105:link=a
```

This is an example of the possible output.

```
rlghncxa03w 05-09-19 21:16:37 GMT EAGLE5 34.0.0  
SLK      LSN      CLLI      PST      SST      AST  
2105,A   atmitul  -----  IS-NR      Avail    ----  
  ALARM STATUS      = No Alarms  
  UNAVAIL REASON    = --  
Command Completed.
```

-
- 12. Back up the new changes using the `chg-db:action=backup:dest=fixed` command. These messages should appear, the active Maintenance and Administration Subsystem Processor (MASP) appears first.**

```
BACKUP (FIXED) : MASP A - Backup starts on active MASP.  
BACKUP (FIXED) : MASP A - Backup on active MASP to fixed disk complete.  
BACKUP (FIXED) : MASP A - Backup starts on standby MASP.  
BACKUP (FIXED) : MASP A - Backup on standby MASP to fixed disk complete.
```

Flowchart C-2. Adding an ATM High-Speed Signaling Link (Sheet 1 of 4)

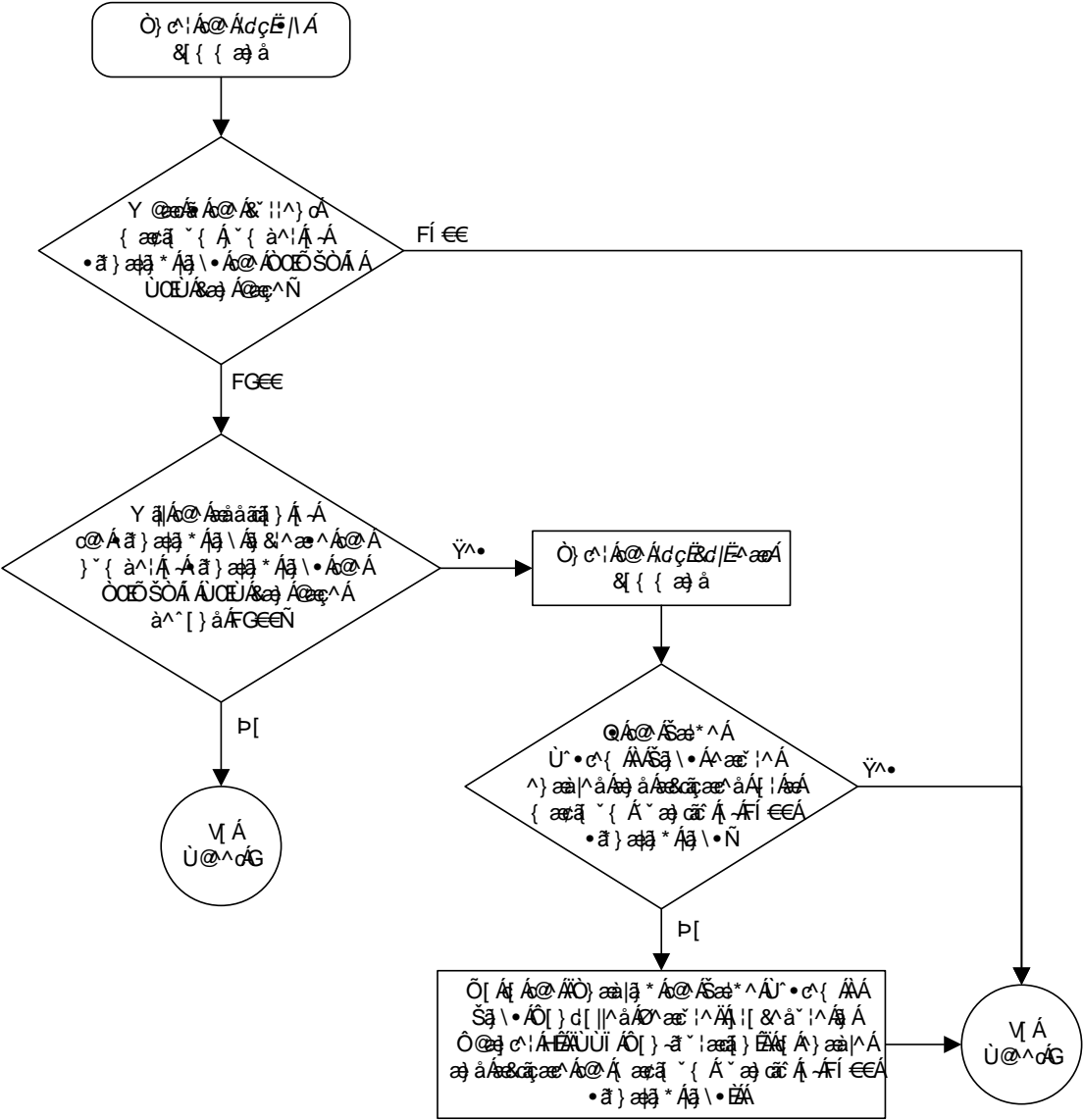

ATM Signaling Link Configuration

Flowchart C-2. Adding an ATM High-Speed Signaling Link (Sheet 2 of 4)

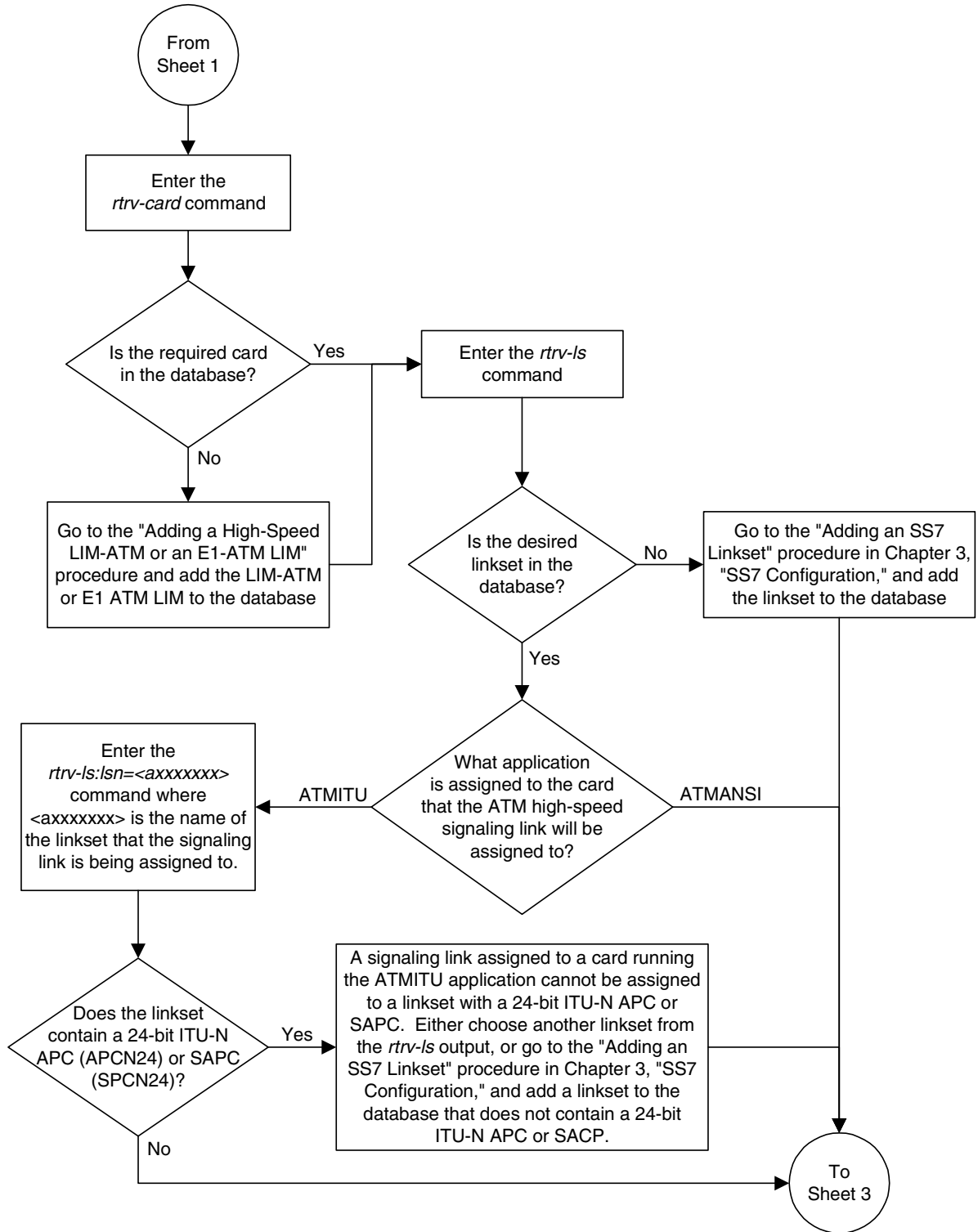

Flowchart C-2. Adding an ATM High-Speed Signaling Link (Sheet 3 of 4)

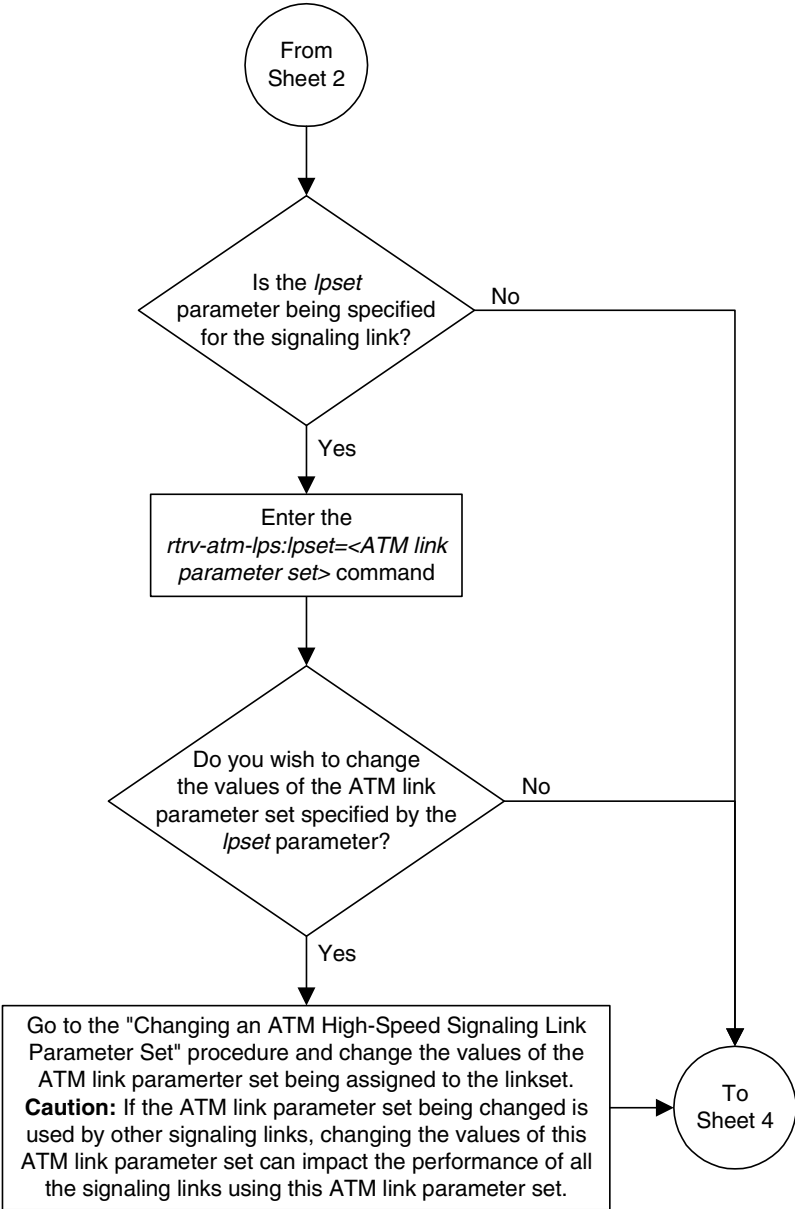

Changing an ATM High-Speed Signaling Link Parameter Set

This procedure is used to change any of the ATM signaling link parameters using the `chg-atm-lps` command or to copy the values from one link parameter set to another.



CAUTION: Changing the values in an ATM link parameter set will impact the performance of all the signaling links using the ATM parameter set being changed.

The `chg-atm-lps` command uses these parameters.

- :lpset** – the link parameter set being changed.
Range of values – 1 - 30
- :action** – copy a set of ATM signaling link parameters from one parameter set to another.
Value – copy
- :src1pset** – the ATM signaling link parameter set used as a source for the `action=copy` parameter.
Range of values – 1 - 30
- :maxcc** – the maximum number of transmissions of a BGN, END, ER, or RS PDU
Range of values – 1 - 10
System default – 4
- :maxpd** – the maximum number of SD PDUs that can be sent before a POLL is sent
Range of values – 5 - 2120
System default – 500
- :maxstat** – the maximum number of list elements in a STAT PDU
Range of values – 3 - 67
System default – 67
- :tmrcc** – the timer, in milliseconds, used during the connection phase to guard against unacknowledged BGN, END, ER or RS PDUs
Range of values – 100 - 2000
System default – 200
- :tmrkalive** – the timer, in milliseconds, used during the transient phase when no SD PDUs are being sent to keep connection up
Range of values – 25 - 500
System default – 100

ATM Signaling Link Configuration

- :tmrnorsp** – the timer, in milliseconds, used to check that STAT PDUs are arriving often enough
 - Range of values – 500 - 2000
 - System default – 1500
- :tmrpoll** – the timer, in milliseconds, used to guarantee that POLL PDUs are sent often enough
 - Range of values – 25 - 500
 - System default – 100
- :tmridle** – the timer, in milliseconds, used during the idle phase when no SD PDUs are being sent to limit time in the idle phase
 - Range of values – 25 - 1000
 - System default – 100
- :tmrt1** – the time, in milliseconds, between link release action and the next link reestablish action during alignment
 - Range of values – 1000 - 15000
 - System default – 5000
- :tmrt2** – the total time, in milliseconds, that SSCF will attempt alignment
 - Range of values – 15000 - 180000
 - System default (ANSI ATM) – 120000
 - System default (E1 ATM) – 30000
- :tmrt3** – the time, in microseconds, between proving PDUs
 - Range of values – 450 - 23000
 - System default – 925
- :n1** – the number of PDUs sent during proving
 - Range of values – 500 - 64552
 - System default (ANSI ATM) – 64552
 - System default (E1 ATM) – 1000
- :maxnrp** – the maximum number of retransmitted PDUs during proving
 - Range of values (ANSI ATM) – 1 - 10
 - Range of values (E1 ATM) – 0 - 10
 - System default (ANSI ATM) – 1
 - System default (E1 ATM) – 0
- :tmrsrec** – the timer, in milliseconds, used to prohibit closely spaced SSCOP recoveries from occurring
 - Range of values – 60000 - 10800000
 - System default – 3600000
- :tmrnocred** – the timer, in milliseconds, used when no credit exists and PDUs are available to be sent
 - Range of values – 1000 - 6000
 - System default – 1500

- :tmrerm** – the error rate monitor interval, in milliseconds
 Range of values – 25 - 500
 System default – 100
- :nblk** – the number of monitoring intervals per block
 Range of values – 1 - 10
 System default – 3
- :tmrprov** – the timer, in milliseconds, used to monitor the status of a link after it is placed into service
 Range of values – 60000 - 1200000
 System default – 600000

Link parameter sets 20 and 30 cannot be changed. The values in link parameter set 20 are set to the ANSI default values. The values in link parameter set 30 are set to the ITU default values. The values in link parameter set 20 and 30 can be copied to another link parameter set.

The values of the **lpset** and **srclpset** parameters cannot be the same.

The **action** and the **srclpset** parameters must be specified together.

If the **action** parameter is specified, only the **lpset** and **srclpset** parameters can be specified.

For any parameters not specified with the **chg-atm-lps** command, the values for those parameters are not changed.

The ATM parameter set values applied to ATM high-speed signaling links are displayed with the **rtrv-atm-lps** and **rtrv-atm-prm** commands. The values displayed with the **rtrv-atm-prm** command are not configurable. These values are:

PCR – The maximum or peak cell rate for the VCL (virtual channel link).

DS1 PCR value – 3622

E1 PCR value – 4528

SCR – The average or sustainable cell rate supported on the VCL.

DS1 SCR value – 3622

E1 PCR value – 4528

BT – Burst tolerance. The number of consecutive cells on the VCL permitted on the ATM interface by the enforcement process, given the PCR and the line speed.

Value – 210

CDVT – The amount of cell delay variation, in microseconds, for the VCL in the network ingress direction.

Value – 100

ATM Signaling Link Configuration

QoS – Quality of service. The performance objectives that must be met by the ATM VCL when it must discard cells during enforcement of the traffic parameters.

Value – 3

MaxVPC – The maximum number of simultaneously active Virtual Path Connections (VPCs) supported (by the ATM interface).

Value – 0

MAXVCC – The maximum number of simultaneously active Virtual Circuit Connections (VCCs) supported.

Value – 1

AllocVPI BITS – The number of bits to be used in the VPIs in the ATM cells for the VPLs terminated on the ATM interface.

Value – 12

AllocVCI BITS – The number of allocated VCI bits to be used in the VPIs in the ATM cells for the VCLs supported on the ATM interface.

Value – 16.

The **rtrv-atm-lps** command shows parameter values that cannot be configured with the **chg-atm-lps** command. These values are:

SDU SIZE – The maximum size, in octets, of the SDU

Value – 272

UU SIZE – The size, in octets of the SSCOP UU

Value – 4

N – The monitoring intervals needed to span the time when messages are not released from buffers as a result of a 400 millisecond error event.

Value – 9

FCNR – The moving credit increment value

Value – NULL

FCBC – The moving credit allocation frequency

Value – NULL

TSUP – The superblock timer value, in seconds

Value – 120

TLOSS – the stat loss limit timer value, in seconds

Value – 1.3

ERMSM – The exponential smoothing factor using in ERM

Value – 0.1

THRES – The threshold for comparing the running QoS computation by the ERM

Value – 0.244

For this example, the values ATM link parameter set 5 are being changed to these values.

```
maxcc = 8 PDUs
maxpd = 2000 PDUs
maxstat = 45 PDUs
tmrcc = 1500 milliseconds
tmrkalive = 500 milliseconds
tmrnorsp = 1000 milliseconds
tmrt1 = 10000 milliseconds
tmrt2 = 19000 milliseconds
tmrt3 = 3000 microseconds
n1 = 10000 PDUs
maxnrp = 7 attempt
tmrsrec = 750000 milliseconds
nblk = 6 monitoring intervals per block
```

Procedure

1. Display the existing values for the ATM link parameter set being changed using the `rtrv-atm-lps` command specifying the link parameter set being changed. For this example, enter this command.

```
rtrv-atm-lps:lpset=5
```

This is an example of the possible output.

```
rlghncxa03w 05-09-28 16:02:05 GMT EAGLE5 34.0.0
ATM LINK PARAMETER SET TIMERS AND PARAMETERS (REAL NUMBERS IN SECONDS)
                                SSCOP PARAMETERS
                                TMR  TMR    TMR    TMR    TMR
LPSET  MAXCC  MAXPD  MAXSTAT  CC  KALIVE  NORSP  POLL  IDLE
5      4      500    67      0.2  0.1    1.5    0.1   0.1

                                SSCF-NNI PARAMETERS
                                TMRT1  TMRT2  TMRT3    N1
05.0   120.0  0.000925  64552

                                SAAL PARAMETERS
                                MAX  TMR    TNRNO  TMR  N    TMR
NRP  SREC  CRED  ERM  BLK  PROV
1    3600.0  1.5   0.1  3    0600.0

                                NONCONFIGURABLE PARAMETERS
                                SDU  UU    FC  FC
                                SIZE SIZE  N  NR  BC  TSUP  TLOSS  ERMSM  THRES
0272 4    9  --  --  120  1.3  0.1  0.244
```

ATM Signaling Link Configuration

2. Change the values of the ATM link parameter set with the **chg-atm-lps** command specifying the link parameter set. For this example, enter this command.

```
chg-atm-lps:lpset=5:maxcc=8:maxpd=2000:maxstat=45:tmrcc=1500
:tmrkalive=500:tmrnorasp=1000:tmrt1=10000:tmrt2=19000
:tmrt3=3000:n1=10000:maxnrp=7:tmsrec=750000:nblk=6
```

This message should appear.

```
rlghncxa03w 05-09-28 00:22:57 GMT EAGLE5 34.0.0
CHG-ATM-LPS: MASP A - COMPLTD
```

3. Verify the changes using the **rtrv-atm-lps** command and the link parameter set specified in step 2. For this example, enter this command.

```
rtrv-atm-lps:lpset=5
```

This is an example of the possible output.

```
rlghncxa03w 05-09-28 16:02:05 GMT EAGLE5 34.0.0
ATM LINK PARAMETER SET TIMERS AND PARAMETERS (REAL NUMBERS IN SECONDS)
      SSCOP PARAMETERS
      TMR  TMR      TMR      TMR      TMR
LPSET  MAXCC  MAXPD  MAXSTAT  CC  KALIVE  NORSP  POLL  IDLE
5       8      2000   45       1.5  0.5    1.0    0.1   0.1

      SSCF-NNI PARAMETERS
      TMRT1  TMRT2  TMRT3  N1
      10.0   019.0  0.003000  10000

      SAAL PARAMETERS
      MAX  TMR      TNRNO  TMR  N  TMR
      NRP  SREC    CRED   ERM  BLK  PROV
      7    0750.0  1.5    0.1  6   0600.0

      NONCONFIGURABLE PARAMETERS
      SDU  UU      FC  FC
      SIZE SIZE  N  NR  BC  TSUP  TLOSS  ERMSM  THRES
      272  4    9  --  --  120  1.3    0.1    0.244
```

4. Back up the new changes using the **chg-db:action=backup:dest=fixed** command. These messages should appear, the active Maintenance and Administration Subsystem Processor (MASP) appears first.

```
BACKUP (FIXED) : MASP A - Backup starts on active MASP.
BACKUP (FIXED) : MASP A - Backup on active MASP to fixed disk complete.
BACKUP (FIXED) : MASP A - Backup starts on standby MASP.
BACKUP (FIXED) : MASP A - Backup on standby MASP to fixed disk complete.
```

Flowchart C-3. Changing an ATM High-Speed Signaling Link Parameter Set

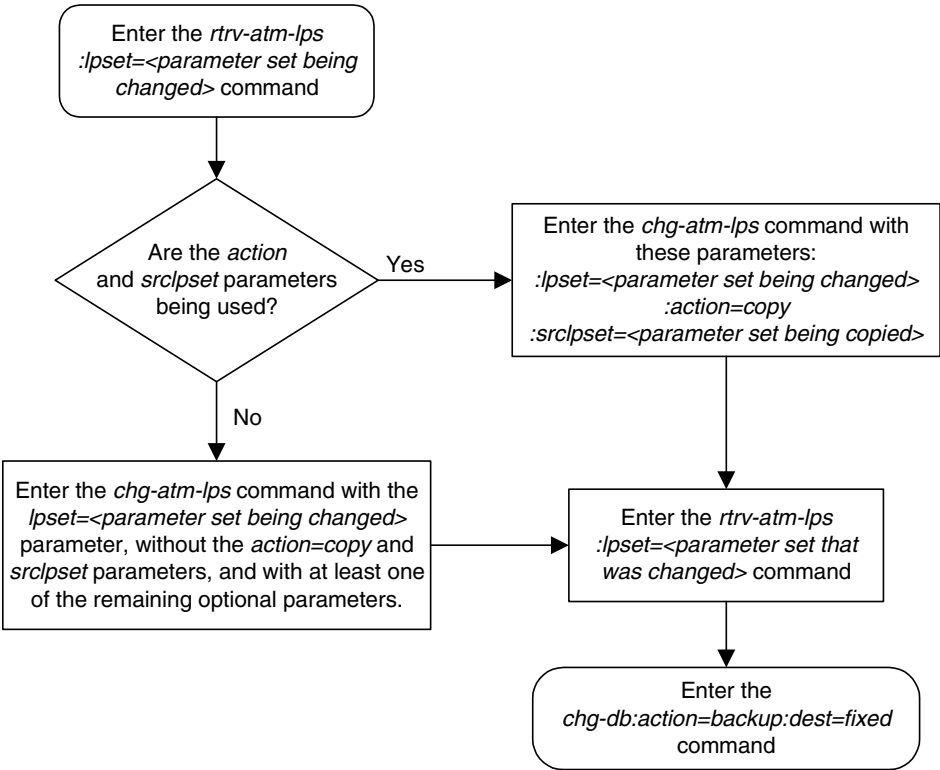

D

Reference Information

Requirements for Systems Containing more than 700 Signaling Links	D-2
Determining the Number of High-Speed and Low-Speed Signaling Links.....	D-2

Requirements for EAGLE 5 SASs Containing more than 700 Signaling Links

To provision a EAGLE 5 SAS with more than 700 signaling links (currently the EAGLE 5 SAS can have maximum capacities of 1200 or 1500 signaling links), the following additional requirements must be met:

- The Measurements Platform feature must be enabled. Perform these procedures in the *Database Administration Manual - System Management* to enable the Measurements Platform Feature:
 - “Adding an MCPM”
 - “Configuring the IP Communications Link for the Measurements Platform Feature”
 - “Adding an FTP Server”
- To provision more than 1200 signaling links, the Large System # Links controlled feature must be enabled for 1500 signaling links. For more information on enabling this feature, go to “Enabling the Large System # Links Controlled Feature” procedure on page 3-10.

Determining the Number of High-Speed and Low-Speed Signaling Links

The EAGLE 5 SAS contain either a maximum of 1200 or 1500 signaling links, depending the hardware that is installed. The method of determining the number of high-speed and low-speed signaling links that can be in the EAGLE 5 SAS is shown in the next section.

An EAGLE 5 SAS containing either 1200 or 1500 signaling links can contain the following quantities of signaling links:

- 1200 low-speed signaling links
- 115 high-speed ATM signaling links (signaling links assigned to either ATMANSI or ATMITU applications)
- 100 signaling links assigned to either the IPLIM or IPLIMI applications.
- 64 signaling links assigned to single-slot ADMs running either the `ss7ipgw` or `ipgwi` application, or combinations of the `ss7ipgw` and `ipgwi` applications. If DCMs are present in the EAGLE 5 SAS, there can be a maximum of 2 signaling links assigned to the `ss7ipgw` application and 2 signaling links assigned to the `ipgwi` application.

Table D-1 shows the combinations of high-speed signaling links and low-speed signaling links allowed in the EAGLE 5 SAS.

Reference Information

Table D-1. Number of High-Speed and Low-Speed Links Supported at 100% Traffic

Number of High-Speed ATM Signaling Links	Number of Low-Speed Signaling Links	Number of IP Signaling Links	Number of Low-Speed Signaling Links
0	1500	0	1500
0	1200	0	1200
1	1199	1	1199
5	1195	5	1195
15	1185	15	1185
20	1180	20	1180
30	1165	30	1165
40	1150	40	1040
60	1110	60	880
80	1025	80	720
90	950	90	560
100	875	100	400
115	800		

Index

Numerics

1500 Signaling Links, 3-10
5000 Routes, 2-23
6000 Routesets, 2-23
7000 Routesets, 2-23
8000 Routesets, 2-23

A

acronyms, 1-14
activating
 ITU National and International Spare
 Point Code Support feature, 2-42,
 2-51
adding
 card, 3-5, C-31
 cluster point code, 2-142
 destination point code, 2-191
 linkset, 3-6, 3-17
 point code, 3-5
 remote loopback points, 3-241, 3-247
 route, 3-153, 3-164, 3-172, 3-181
 shelf, 3-4
 signaling link, 3-5, 3-6, 3-130, C-34
adding a point code to the self-identification
 of the EAGLE 5 SAS, 2-81
alternate point code, 2-2
ATM high speed signaling link parameter set
 changing, C-50

B

bit rotation
 ITU SLS enhancement, 3-30
broadcast transfer messages
 network routing, 2-177

C

cancel
 rtrv-dstn, 3-35, 3-155, 3-165, 3-173,
 3-182, 3-271
 rtrv-ls, 3-35, 3-155, 3-165, 3-173, 3-182,
 3-271
 rtrv-rte, 3-155, 3-165, 3-173, 3-182

card
 adding, 3-5
card type
 signaling link, 3-5
changing
 ATM high speed signaling link
 parameter set, C-50
 cluster point code
 attributes, 2-161
 destination point code, 2-226
 level 2 timers, 3-219
 level 3 timers, 3-222
 linkset, 3-74
 remote loopback points, 3-250
 route, 3-206
 self identification of the EAGLE 5
 SAS, 2-90
 signaling link test message, 3-228
Changing the DPC Quantity, 2-23
Changing the HC MIM Temperature Alarm
 Thresholds, 3-279
chg-ss7opts command, 3-94, 3-269, 3-273,
 3-276, 3-277
CIC bit
 ITU SLS enhancement, 3-31
circular route detection
 configuring, 3-231
circular routing
 network routing, 2-178
C-link linkset, 3-6
cluster destination point code, 2-3
cluster management
 ITU network, 2-125
cluster point code
 adding, 2-142
 changing attributes, 2-161
cluster routing
 Cluster Routing and Management
 Diversity feature, 2-119, 2-124
Cluster Routing and Management Diversity
 feature, 2-119
 cluster routing, 2-124
 compatibility with non-cluster routing
 systems, 2-125
 diversity rules, 2-126

- example, 2-128
- when feature is turned off, 2-126
- complex network, 3-8
- configuring
 - circular route detection, 3-231
 - destination tables, 2-1
 - secondary point codes, 2-63
 - TFAT/FR pacing rate, 3-235
- Configuring the Options for Handling TFCs on ITU-I and ITU-N Networks, 3-276, 3-278
- Configuring the Restricted Linkset Option, 3-269, 3-274, 3-275
- Controlled Feature
 - Large System # Links - Enabling, 3-10
- CPC, 2-92
- CPCA, 2-92
- CPCI, 2-92
- CPCN, 2-92
- CPCTYPE, 2-92
- Customer Care Center, 1-8

D

- database partitions
 - overview, 1-11
- destination, 2-2
- destination point code, 2-3
 - adding, 2-191
 - changing, 2-226
 - removing, 2-214
- destination tables
 - configuring, 2-1
- DISCARDTFCI Option, 3-276, 3-277
- DISCARDTFCN Option, 3-276, 3-277
- DPC Quantity
 - Changing, 2-23

E

- E1 backplane, A-8
- E1 card
 - clocking options, A-9, B-8
 - configured as channel card, A-5, B-4
 - configured as E1 card, A-5, B-4
 - determining configuration, A-8, B-7
- Emergency response, 1-9

- Enabling the Large System # Links Controlled Feature, 3-10
- Errors - contacting the Customer Care Center, 1-8
- exception list, 2-120

F

- features
 - ITU National and International Spare Point Code Support, 2-42, 2-51
 - multiple point code support, 2-55
- fixed disk drive
 - overview, 1-12
- full point code, 2-3

H

- HC MIM Temperature Alarm Thresholds - Changing, 3-279

I

- International Spare network indicator
 - values, 2-7
- ITU National and International Spare Point Code Support feature, 2-7, 2-43, 2-44, 2-49, 2-50, 2-83, 2-85, 2-91, 2-100, 2-193, 2-229, 3-19, 3-77
 - activating, 2-42, 2-51
- ITU network
 - cluster management, 2-125
- ITU SLS enhancement
 - bit rotation, 3-30
 - CIC bit, 3-31
- ITU-I Networks Option - TFCs
 - Configuring, 3-276, 3-278
- ITU-N Networks Option - TFCs
 - Configuring, 3-276, 3-278

L

- Large System # Links Controlled Feature
 - Enabling, 3-10
- level 2 timers
 - changing, 3-219
- level 3 timers
 - changing, 3-222

Index

linkset

- adding, 3-6, 3-17
- changing, 3-74
- removing, 3-63
- route, 3-7

linksets, 3-3

local link congestion

- network routing, 2-177

LSRESTRICT Option, 3-94, 3-269, 3-270, 3-271, 3-273

M

maintenance and administration subsystem overview, 1-10

manual

- admonishments, 1-8
- organization, 1-2
- related publications, 1-3

mated gateways, 3-6

multiple point code support, 2-55

- Local Number Portability, 2-60

N

National Spare network indicator

- values, 2-7

NCPC, 2-92

NCPA, 2-92

NCPCI, 2-92

NCPCN, 2-92

network

- complex, 3-8
- types, 2-2

network routing, 2-174

- administration, 2-180
- broadcast transfer messages, 2-177
- circular routing, 2-178
- local link congestion, 2-177
- point code availability, 2-176
- reception of an RCx message, 2-180
- reception of an RSx message, 2-179
- reception of transfer messages, 2-179
- remote congestion, 2-177
- response method transfer messages, 2-177
- route availability, 2-176
- route management, 2-177

routing strategies, 2-174

network routing point code, 2-3

O

Option

- DISCARDTFCI, 3-276, 3-277
- DISCARDTFCN, 3-276, 3-277
- LSRESTRICT, 3-94, 3-269, 3-270, 3-271, 3-273
- Restricted Linkset - Configuring, 3-269, 3-274, 3-275

Options

- TFCs on ITU-I Networks - Configuring Options
- TFCs on ITU-N Networks - Configuring, 3-276, 3-278

overview

- database partitions, 1-11
- fixed disk drive, 1-12
- maintenance and administration subsystem, 1-10
- removable cartridge, 1-13

P

parameters for DCM signaling links, 3-7

PDS, 2-90

Persistent Device States, 2-90

point code

- adding, 3-5
- adding to the self identification of the EAGLE 5 SAS, 2-81
- alternate, 2-2
- cluster destination, 2-3
- destination, 2-3
- formats, 2-4
- full, 2-3
- network routing, 2-3
- true, 2-2

point code availability

- network routing, 2-176

private point code, 2-8, 2-91, 2-142, 2-161, 2-181, 2-191, 2-193, 2-226, 2-227, 2-229, 3-17, 3-45, 3-75, 3-121, 3-154, 3-158, 3-164, 3-168, 3-172, 3-174, 3-176, 3-207, 3-212

private spare point code, 3-114, 3-121

Problems - contacting the Customer Care Center, 1-8

R

reception of an RCx message
 network routing, 2-180
 reception of an RSx message
 network routing, 2-179
 reception of transfer messages
 network routing, 2-179
 remote congestion
 network routing, 2-177
 remote loopback points
 adding, 3-241, 3-247
 changing, 3-250
 removable cartridge
 overview, 1-13
 removing
 destination point code, 2-214
 linkset containing SS7 signaling links, 3-63
 route, 3-189
 signaling link, 3-145
 replacing
 two STP pairs with one pair, 2-56
 response method transfer messages
 network routing, 2-177
 restart signaling link alignment delay, 3-25
 Restricted Linkset Option
 Configuring, 3-269, 3-274, 3-275
 route
 adding, 3-153, 3-164, 3-172, 3-181
 changing, 3-206
 removing, 3-189
 route availability
 network routing, 2-176
 route management
 network routing, 2-177
 Routes
 5000, 2-23
 Routesets
 6000, 2-23
 7000, 2-23
 8000, 2-23

S

secondary point codes, 2-3
 configuring, 2-63
 self identification of the EAGLE 5 SAS
 adding a point code, 2-81
 changing, 2-90
 shelf
 adding, 3-4
 signaling link
 adding, 3-5, 3-6, 3-130, C-34
 card types, 3-5
 configure for E1 card, A-10
 parameters for DCMs, 3-7
 removing, 3-145
 verify, 3-6
 signaling link test message
 changing, 3-228
 signaling links, 1500, 3-10
 spare point code, 2-7, 2-55, 2-81, 2-82, 2-83, 2-91, 2-94, 2-100, 2-104, 2-193, 2-198, 2-228, 2-236, 3-17, 3-74, 3-121
 SS7 linksets, 3-3
 STP pair replacement
 multiple point code support, 2-56
 Support - contacting the Customer Care Center, 1-8

T

Technical Assistance - contacting the Customer Care Center, 1-8
 Temperature Alarm Thresholds - HC MIM - Changing, 3-279
 TFAT/FR pacing rate
 configuring, 3-235
 tfatcabmlq parameter, 3-22, 3-76, 3-96, 3-269, 3-270, 3-272
 TFCs
 ITU-I Networks Option -
 Configuring, 3-276, 3-278
 ITU-N Networks Option -
 Configuring, 3-276, 3-278
 timers
 default values, 3-25
 true point code, 2-2
 types of networks, 2-2