

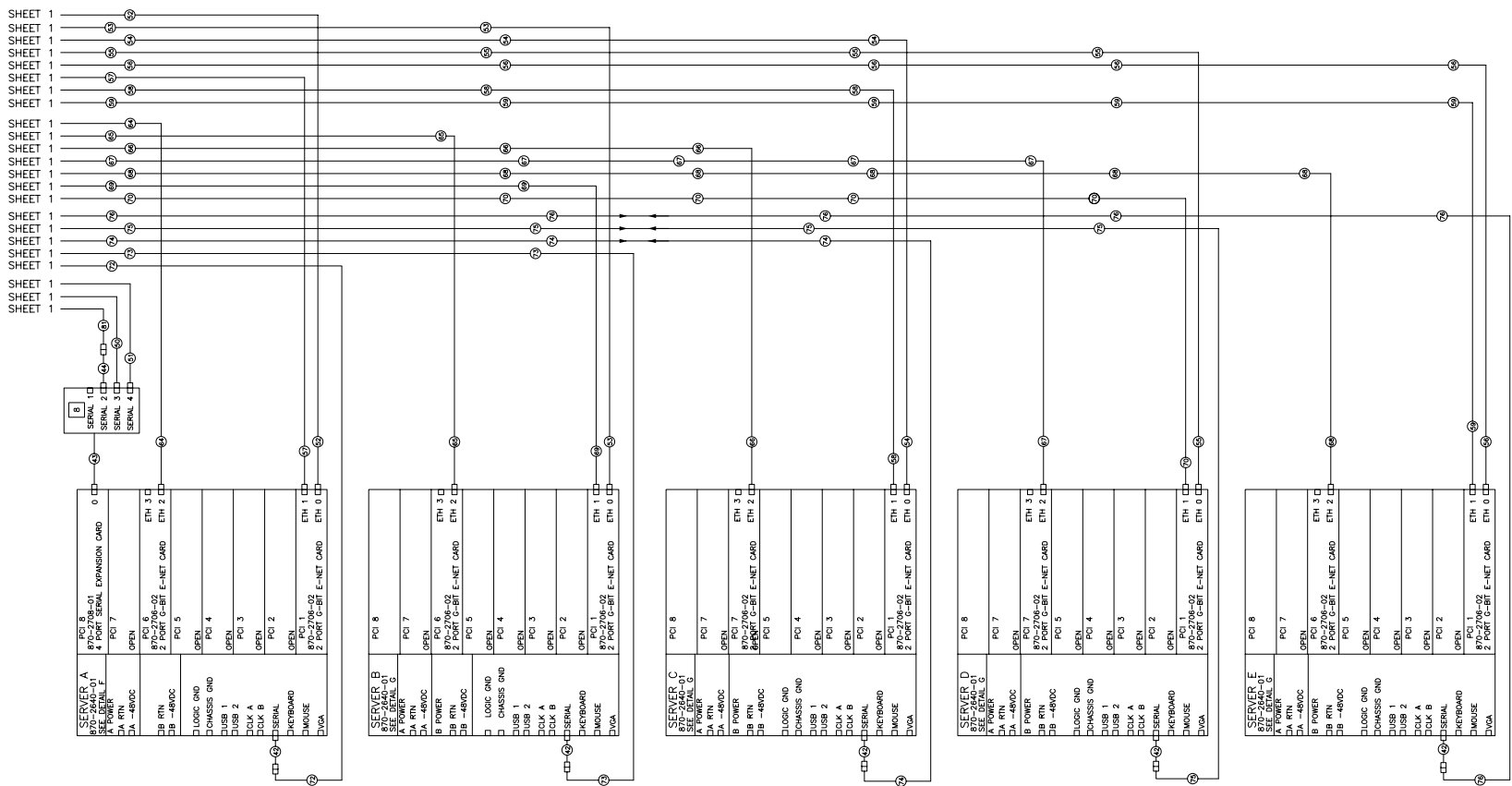

REVISIONS			
LTR	DESCRIPTION	DATE	APPROVED



DATA CONNECTIONS AND CABLES

SIZE: D	CAGE CODE	DRAWING NO. 892-0073-02	REV. A
<small>THIS DOCUMENT AND THE DATA DISCLOSED HEREIN OR HEREWITH IS UNCLASSIFIED UNLESS INDICATED OTHERWISE. IT IS UNCLASSIFIED IN WHOLE OR PART TO ANYONE WITHOUT THE WRITTEN PERMISSION OF TEXELCO, COPYRIGHT, TEXELCO, 1994.</small>			
SCALE: NONE	FILE NAME: 892-0073-02_REV_A.DWG	SHEET 2	OF 6



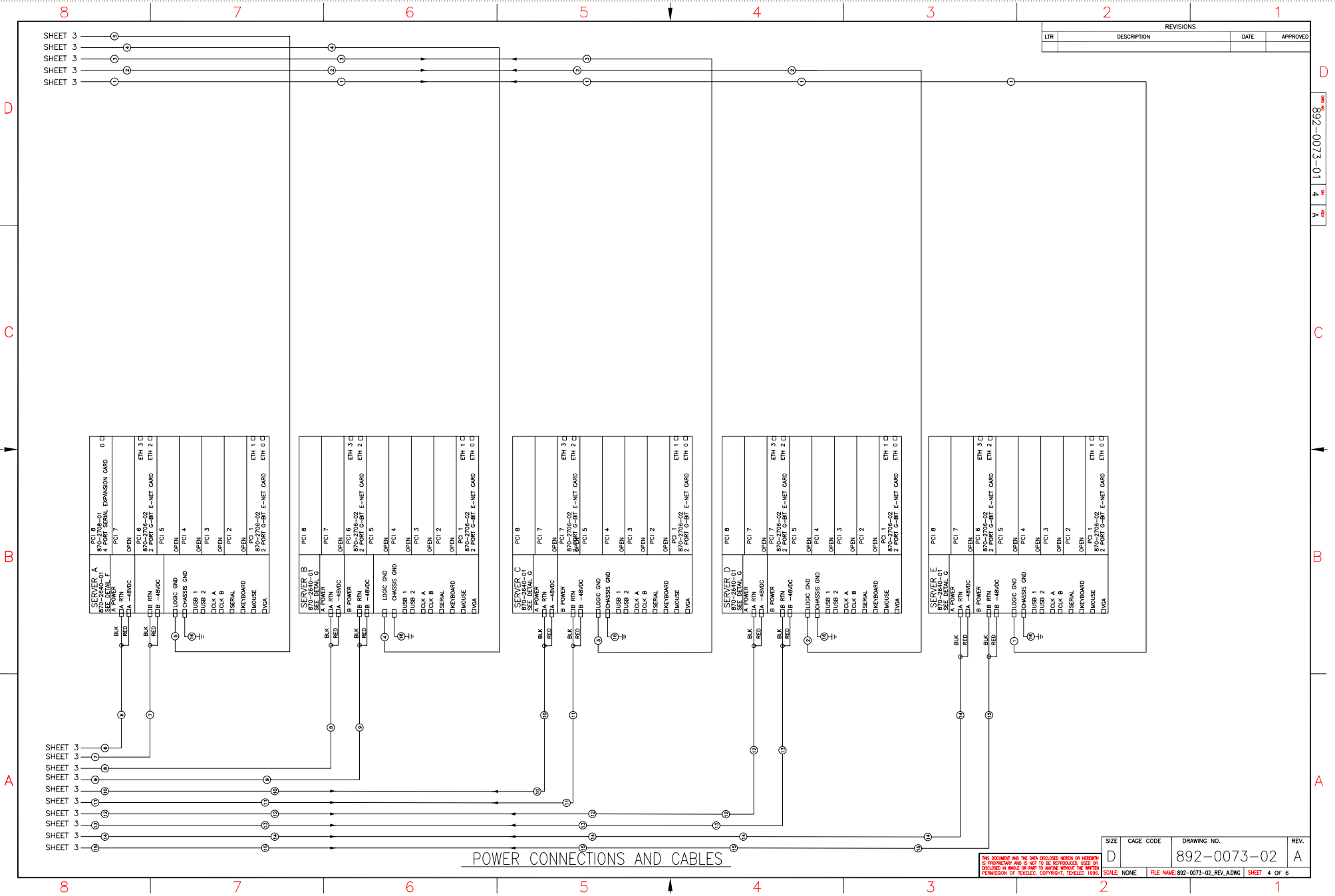

REVISIONS			
LTR	DESCRIPTION	DATE	APPROVED

SIZE	CAGE CODE	DRAWING NO.	REV.
D		892-0073-02	A

THIS DOCUMENT AND THE DATA DISCLOSED HEREIN OR HEREON IS PROPRIETARY AND IS NOT TO BE REPRODUCED, USED OR PUBLISHED IN WHOLE OR IN PART TO ANYONE WITHOUT THE WRITTEN PERMISSION OF TEXELLEC. COPYRIGHT, TEXELLEC 1998. SCALE: NONE FILE NAME: 892-0073-02\_REV\_A.DWG SHEET 4 OF 6

892-0073-01 4 A  
 B  
 C  
 D

TABLE A - POWER CABLE PART NUMBERS

ITEM NO.	TEKELEC P/N	QTY	LENGTH	RUN LIST AND LABEL INFORMATION FOR FROM AND TO	9	LABEL REQUIRED
1	830-0989-05	1	116.00 INCHES	FROM: LOGIC GND TERM BLK 5 / TO: SERVER 1E LOGIC GND		YES
2	830-0989-04	1	106.00 INCHES	FROM: LOGIC GND TERM BLK 4 / TO: SERVER 1D LOGIC GND		YES
3	830-0989-03	1	99.00 INCHES	FROM: LOGIC GND TERM BLK 3 / TO: SERVER 1C LOGIC GND		YES
4	830-0989-02	1	92.00 INCHES	FROM: LOGIC GND TERM BLK 2 / TO: SERVER 1B LOGIC GND		YES
5	830-0989-01	1	86.00 INCHES	FROM: LOGIC GND TERM BLK 1 / TO: SERVER 1A LOGIC GND		YES
6	830-0988-01	1	96.00 INCHES	FROM: SERVER 1A - A PWR / TO: BP1-2A		YES
7	830-0988-02	1	87.00 INCHES	FROM: SERVER 1A - B PWR / TO: BP2-2B		YES
8	830-0988-03	1	100.00 INCHES	FROM: SERVER 1B - A PWR / TO: BP2-2A		YES
9	830-0988-04	1	97.00 INCHES	FROM: SERVER 1B - B PWR / TO: BP1-2B		YES
10	830-0988-05	1	110.00 INCHES	FROM: SERVER 1C - A PWR / TO: BP1-3A		YES
11	830-0988-06	1	107.00 INCHES	FROM: SERVER 1C - B PWR / TO: BP2-3B		YES
12	830-0988-07	1	114.00 INCHES	FROM: SERVER 1D - A PWR / TO: BP2-3A		YES
13	830-0988-08	1	111.00 INCHES	FROM: SERVER 1D - B PWR / TO: BP1-3B		YES
14	830-0988-09	1	128.00 INCHES	FROM: SERVER 1E - A PWR / TO: BP1-4A		YES
15	830-0988-10	1	119.00 INCHES	FROM: SERVER 1E - B PWR / TO: BP2-4B		YES
16	830-0927-01	5	48.00 INCHES	FROM: FRAME GROUND / TO: SERVER 1A FROM: FRAME GROUND / TO: SERVER 1B FROM: FRAME GROUND / TO: SERVER 1C FROM: FRAME GROUND / TO: SERVER 1D FROM: FRAME GROUND / TO: SERVER 1E		YES
17	830-1013-01	1	41.00 INCHES	FROM: SWITCH B - A PWR / TO: BP1-6A		NO
18	830-1013-04	1	30.00 INCHES	FROM: SWITCH B - B PWR / TO: BP2-6B		NO
19	830-1013-02	1	32.00 INCHES	FROM: SWITCH A - B PWR / TO: BP1-6B		NO
20	830-1013-03	1	37.00 INCHES	FROM: SWITCH A - A PWR / TO: BP2-6A		NO
21	830-0715-03	1	84.00 INCHES	FROM: FRAME GROUND / TO: GROUND WINDOW		NO
22	830-0830-01	2	N/A	FROM: CIRCUIT BREAKER / TO: FRAME GND		NO
23	830-0868-27	1	41.00 INCHES	FROM: CON SERVER A PWR / TO: BP2-7A		YES
24	830-0868-28	1	37.00 INCHES	FROM: CON SERVER B PWR / TO: BP1-7B		YES
25	830-1015-02	1	18.00	FROM: CONSOLE SERVER / TO: FRAME GND		YES
26	NOT USED					
27	NOT USED					
28	NOT USED					
29	NOT USED					
30	NOT USED					
31	NOT USED					
32	CHASSIS GND (FIELD ROUTED)	1	SITE SPECIFIC	SEE TABLE F		FIELD LABEL
33	-48VDC AND 48V RTN (FIELD ROUTED)	8	SITE SPECIFIC	SEE TABLE E		FIELD LABEL
34	LOGIC GROUND	1	SITE SPECIFIC	SEE TABLE D		FIELD LABEL
35	830-1015-01	2	22.00 INCHES	FROM: SWITCH A AND B / TO: FRAME GROUND		YES

TABLE B - DATA CABLE PART NUMBERS

ITEM NO.	TEKELEC P/N	QTY	LENGTH	RUN LIST AND LABEL INFORMATION FOR FROM AND TO	9	LABEL REQUIRED
42	830-1011-01	5	NA	ADAPTER FROM MAIN SERIAL PORTS ON SERVER 1A-1E		NO
43	870-2708-01	1	NA	4 PORT SERIAL CABLE SUPPLIED WITH PCI CARD		NO
44	830-1012-01	1	NA	ADAPTER FROM SERVER 1A, PCI SLOT 8, SERIAL CARD PORT 2		NO
45	NOT USED					
46	NOT USED					
47	830-0660-01	1		RJ11 TO RJ11 PHONE LINE		NO
50	830-0961-01	1	72 INCHES	FROM: BP1 ALARM / TO: SERVER A PCI SLOT 8 SERIAL PORT 3		YES
51	830-0961-01	1	72 INCHES	FROM: BP2 ALARM / TO: SERVER A PCI SLOT 8 SERIAL PORT 4		YES
52	830-0724-06	1	6 FT	FROM: SWITCH A PORT 1X / TO: SERVER A PCI SLOT 1 ETH 0		YES
53	830-0724-07	1	7 FT	FROM: SWITCH A PORT 2X / TO: SERVER B PCI SLOT 1 ETH 0		YES
54	830-0724-67	1	8 FT	FROM: SWITCH A PORT 3X / TO: SERVER C PCI SLOT 1 ETH 0		YES
55	830-0724-67	1	8 FT	FROM: SWITCH A PORT 4X / TO: SERVER D PCI SLOT 1 ETH 0		YES
56	830-0724-02	1	10 FT	FROM: SWITCH A PORT 5X / TO: SERVER E PCI SLOT 1 ETH 0		YES
57	830-0724-06	1	6 FT	FROM: SWITCH A PORT 13X / TO: SERVER A PCI SLOT 1 ETH 1		YES
58	830-0724-67	1	8 FT	FROM: SWITCH A PORT 14X / TO: SERVER C PCI SLOT 1 ETH 1		YES
59	830-0724-02	1	10 FT	FROM: SWITCH A PORT 15X / TO: SERVER E PCI SLOT 1 ETH 1		YES
60	830-0724-65	1	3 FT	FROM: SWITCH A PORT 18X / TO: CONSOLE SERVER ETH PORT		YES
61	830-0723-01	1	1 FT	FROM: SWITCH A PORT 21X / TO: SWITCH B PORT 21		YES
62	830-0723-01	1	1 FT	FROM: SWITCH A PORT 22X / TO: SWITCH B PORT 22		YES
63	NOT USED					
64	830-0724-06	1	6 FT	FROM: SWITCH B PORT 1X / TO: SERVER A PCI SLOT 6 ETH 2		YES
65	830-0724-07	1	7 FT	FROM: SWITCH B PORT 2X / TO: SERVER B PCI SLOT 6 ETH 2		YES
66	830-0724-67	1	8 FT	FROM: SWITCH B PORT 3X / TO: SERVER C PCI SLOT 6 ETH 2		YES
67	830-0724-67	1	8 FT	FROM: SWITCH B PORT 4X / TO: SERVER D PCI SLOT 6 ETH 2		YES
68	830-0724-02	1	10 FT	FROM: SWITCH B PORT 5X / TO: SERVER E PCI SLOT 6 ETH 2		YES
69	830-0724-07	1	6 FT	FROM: SWITCH B PORT 13X / TO: SERVER B PCI SLOT 1 ETH 1		YES
70	830-0724-67	1	8 FT	FROM: SWITCH B PORT 14X / TO: SERVER D PCI SLOT 1 ETH 1		YES
71	NOT USED					
72	830-1005-06	1	6 FT	FROM: CONSOLE SERVER PORT 1X / TO: SERVER A MAIN SERIAL PORT		YES
73	830-1005-06	1	6 FT	FROM: CONSOLE SERVER PORT 2X / TO: SERVER B MAIN SERIAL PORT		YES
74	830-1005-07	1	7 FT	FROM: CONSOLE SERVER PORT 3X / TO: SERVER C MAIN SERIAL PORT		YES
75	830-1005-08	1	8 FT	FROM: CONSOLE SERVER PORT 4X / TO: SERVER D MAIN SERIAL PORT		YES
76	830-1005-08	1	8 FT	FROM: CONSOLE SERVER PORT 5X / TO: SERVER E MAIN SERIAL PORT		YES
77	NOT USED					
78	NOT USED					
79	830-0990-03	1	3 FT	FROM: CONSOLE SERVER PORT 6X / TO: SWITCH A CONSOLE PORT		YES
80	830-0990-03	1	3 FT	FROM: CONSOLE SERVER PORT 7X / TO: SWITCH B CONSOLE PORT		YES
81	830-0990-03	1	3 FT	FROM: CONSOLE SERVER DIAG PORT / TO: SERVER A PCI SLOT 8 SERIAL PORT 2		YES
82	830-0724-XX	2	SITE SPECIFIC	TO CUSTOMER NETWORK - RJ45 STRAIGHT THRU		FIELD LABEL
83	830-0978-XX	AR	SITE SPECIFIC	SWITCH A AND B PORTS 6X - 12X TO EAGLE		FIELD LABEL
84	830-0724-XX	4	SITE SPECIFIC	SWITCH A AND B PORTS 19X AND 20X TO FIRST FRAME		FIELD LABEL
85	CUSTOMER SUPPLIED	2	SITE SPECIFIC	TO CUSTOMERS SWITCH		FIELD LABEL

REVISIONS			
LTR	DESCRIPTION	DATE	APPROVED

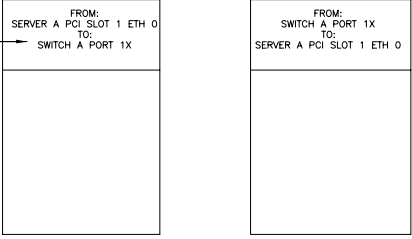

DETAIL K 9  
CABLE LABEL EXAMPLE USING CABLE ITEM NO. 38

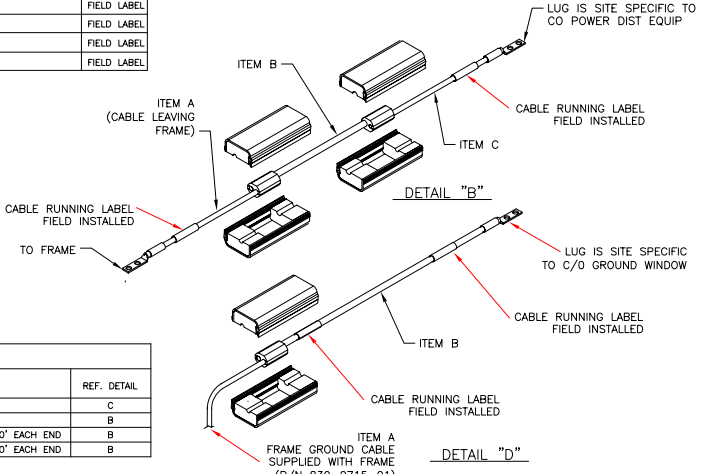
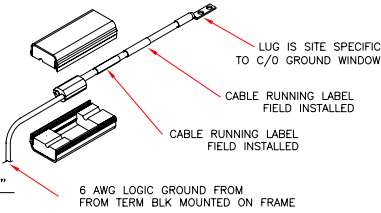
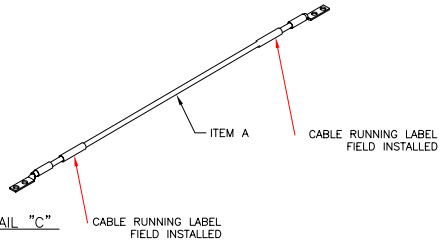

TABLE D - LOGIC GROUND CABLING

DISTANCE	PRIMARY CABLE PART NUMBER	CABLE AWG	TERMINAL LUG P/N	HEAT SHRINK PART NUMBER	COMMENT	REF. DETAIL
0' - 40'	690-0131-01	6	502-0085-01	804-0228-01	CABLE LENGTH IS SITE-SPECIFIC	C
40' - 160'	690-0108-07	1/0	804-0977-01	804-0229-01	CABLE LENGTH IS SITE-SPECIFIC	A

TABLE E - 48VDC & 48VRTN CABLING COMPONENTS

DISTANCE	ITEM A			ITEM B			ITEM C		COMMENT	REF. DETAIL	
	CABLE P/N	CABLE AWG	TERMINAL LUG P/N	CABLE P/N	CABLE AWG	CABLE CONSTRUCTION	HALF TAP SPLICE P/N	HTAP SOFT COVER P/N			
0' - 40'	690-0108-01	6	502-0085-01	804-0228-01	N/A	N/A	NONE REQUIRED	NONE REQUIRED	CABLE LENGTH IS SITE-SPECIFIC	C	
40' - 65'	690-0108-01	6	502-0085-01	804-0228-01	690-0108-04	4	SITE SPECIFIC	T&B 63125	T&B HTC40	CABLE LENGTH IS SITE-SPECIFIC	B
65' - 100'	690-0108-01	6	502-0085-01	804-0228-01	690-0108-06	2	SITE SPECIFIC	T&B 63125	T&B HTC40	CABLE LENGTH IS SITE-SPECIFIC, HTAPPED STUBS <= 10" EACH END	B
100' - 160'	690-0108-01	6	502-0085-01	804-0228-01	690-0108-03	1/0	SITE SPECIFIC	T&B 63125	T&B HTC40	CABLE LENGTH IS SITE-SPECIFIC, HTAPPED STUBS <= 10" EACH END	B

TABLE F - SYSTEM FRAME GROUND CABLING

DISTANCE	CABLE P/N	CABLE AWG	ITEM A (830-0715-01 SUPPLIED WITH FRAME)		ITEM B		HTAP (A TO B CONNECTION)		COMMENT	REF. DETAIL
			TERMINAL LUG P/N	HEAT SHRINK P/N	CABLE P/N	CABLE AWG	H TAP P/N	P/N		
0' - 40'	690-0131-01	6	502-0085-01	804-0228-01	690-0131-01	6	804-0865-01	804-0865-01	CABLE LENGTH IS SITE-SPECIFIC	D
40' - 160'	690-0108-01	6	502-0085-01	804-0228-01	690-0108-07	1/0	804-0865-01	804-0865-01	CABLE LENGTH IS SITE-SPECIFIC	D

THIS DOCUMENT AND THE DATA DISCLOSED HEREIN OR HEREUNDER IS PROPRIETARY AND IS NOT TO BE REPRODUCED, USED OR DISCLOSED IN WHOLE OR PART TO ANYONE WITHOUT THE WRITTEN PERMISSION OF TRIECLE, COPYRIGHT, TRIELEC 1996

SIZE	CAGE CODE	DRAWING NO.	REV.
D		892-0073-02	A
SCALE: NONE	FILE NAME: 892-0073-02.REV.A.DWG	SHEET 5 OF 6	

REVISIONS			
LTR	DESCRIPTION	DATE	APPROVED

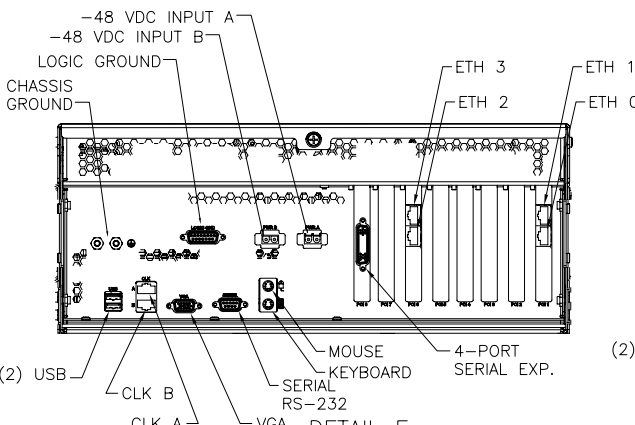

**DETAIL F**  
 SERVER A REAR VIEW  
 870-2640-01 W/ PCI CARDS:  
 SLOT 1 -870-2706-02  
 SLOT 6 -870-2706-02  
 SLOT 8 -870-2708-01

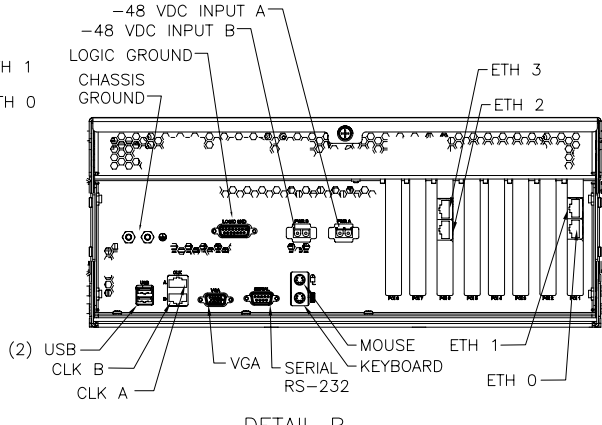

**DETAIL B**  
 SERVER 1B - 1E (REAR VIEW)  
 870-2640-01 W/ PCI CARDS:  
 SLOT 1 -870-2706-02  
 SLOT 6 -870-2706-02

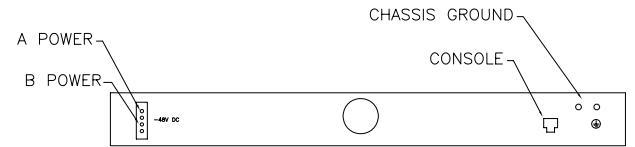

**DETAIL J**  
 REAR VIEW-SWITCH  
 870-2758-01

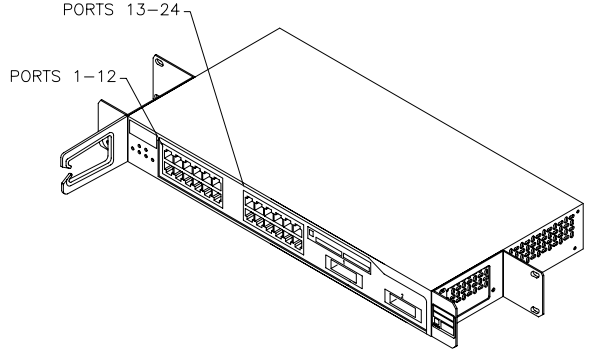

**DETAIL M**  
 ISO VIEW OF THE FRONT-SWITCH  
 870-2758-01

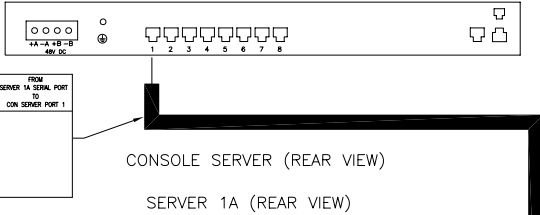

CONSOLE SERVER (REAR VIEW)  
 SERVER 1A (REAR VIEW)

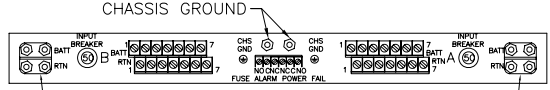

**DETAIL E**  
 CIRCUIT BREAKER (REAR VIEW)  
 870-2248-10

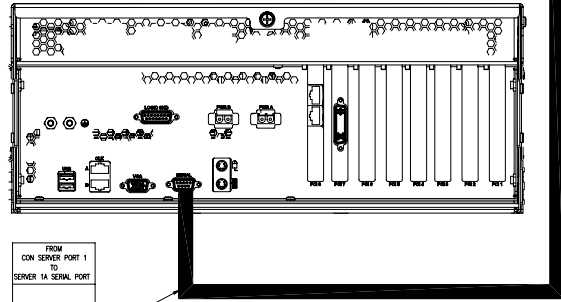

**DETAIL L**  
 CABLE LABEL PLACEMENT DETAIL  
 TYPICAL FOR ALL CABLES  
 INDICATED IN TABLES A AND B  
 USING CABLE ITEM NO. 38

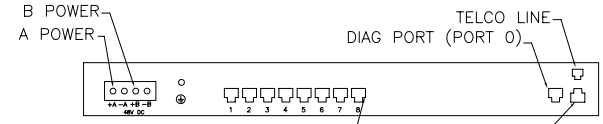

**DETAIL H**  
 REAR VIEW- CONSOLE SERVER  
 870-2742-01

THIS DOCUMENT AND THE DATA DISCLOSED HEREIN OR HEREUNDER IS PROPRIETARY AND IS INTENT TO BE REPRODUCED, COPIED OR DISCLOSED IN WHOLE OR PART TO ANYONE WITHOUT THE WRITTEN PERMISSION OF TEKELIC, COPYRIGHT, TEKELIC-1994.

SIZE	CAGE CODE	DRAWING NO.	REV.
D		892-0073-02	A
SCALE: NONE	FILE NAME: 892-0073-02_REV_A.DWG	SHEET 6 OF 6	