

Tekelec EAGLE[®] 5
Integrated Signaling System

Release 36.0

**Database Administration Manual - IP⁷ Secure
Gateway[®]**

910-4471-001 Revision A

October 2006



TEKELEC

**Copyright 2006 Tekelec.
All Rights Reserved
Printed in U.S.A.**

Notice

Information in this documentation is subject to change without notice. Unauthorized use or copying of this documentation can result in civil or criminal penalties.

Any export of Tekelec products is subject to the export controls of the United States and the other countries where Tekelec has operations.

No part of this documentation may be reproduced or transmitted in any form or by any means, electronic or mechanical, including photocopying or recording, for any purpose without the express written permission of an authorized representative of Tekelec.

Other product names used herein are for identification purposes only, and may be trademarks of their respective companies.

RoHS 5/6 - As of July 1, 2006, all products that comprise new installations shipped to European Union member countries will comply with the EU Directive 2002/95/EC "RoHS" (Restriction of Hazardous Substances). The exemption for lead-based solder described in the Annex will be exercised. RoHS 5/6 compliant components will have unique part numbers as reflected in the associated hardware and installation manuals.

WEEE - All products shipped to European Union member countries comply with the EU Directive 2002/96/EC, Waste Electronic and Electrical Equipment. All components that are WEEE compliant will be appropriately marked. For more information regarding Tekelec's WEEE program, contact your sales representative.

Trademarks

The Tekelec logo, EAGLE, G-Flex, G-Port, IP⁷, IP⁷Edge, IP⁷ Secure Gateway, and TALI are registered trademarks of Tekelec. TekServer and A-Port are trademarks of Tekelec. All other trademarks are the property of their respective owners.

Patents

This product is covered by one or more of the following U.S. and foreign patents:

U.S. Patent Numbers:

5,008,929, 5,953,404, 6,167,129, 6,324,183, 6,327,350, 6,456,845, 6,606,379, 6,639,981, 6,647,113, 6,662,017, 6,735,441, 6,745,041, 6,765,990, 6,795,546, 6,819,932, 6,836,477, 6,839,423, 6,885,872, 6,901,262, 6,914,973, 6,940,866, 6,944,184, 6,954,526, 6,954,794, 6,959,076, 6,965,592, 6,967,956, 6,968,048, 6,970,542

Ordering Information

For additional copies of this document, contact your sales representative.

Table of Contents

Chapter 1. Introduction

| | |
|--|------|
| Overview | 1-2 |
| Manual Organization | 1-2 |
| Related Publications | 1-3 |
| Documentation Packaging, Delivery, and Updates | 1-8 |
| Documentation Admonishments | 1-8 |
| Customer Care Center | 1-9 |
| Emergency Response | 1-10 |
| Maintenance and Administration Subsystem | 1-10 |
| Database Partitions | 1-11 |
| Fixed Disk Drive | 1-12 |
| Removable Cartridge | 1-13 |
| List of Acronyms and Abbreviations | 1-14 |

Chapter 2. IP7 Secure Gateway Overview

| | |
|--|------|
| Introduction | 2-2 |
| Hardware, Applications, and Functions | 2-3 |
| IP Connections | 2-5 |
| Point-to-Point Connectivity (IPLIM or IPLIMI Application) | 2-21 |
| Point-to-Multipoint Connectivity (SS7IPGW and IPGWI) | 2-22 |
| SNMP Agent Implementation | 2-30 |
| Mixed Networks Using the ANSI/ITU MTP Gateway Feature | 2-34 |
| ISUP Normalization | 2-40 |
| IETF Adapter Layer Support | 2-48 |
| Overview | 2-48 |
| Interaction Between TALI and IETF Connections Within a Single EAGLE 5 ISS | 2-49 |
| Feature Components | 2-50 |

Chapter 3. IP7 Secure Gateway Configuration Procedures

| | |
|---------------------------|------|
| Overview | 3-3 |
| Adding an IP Card | 3-17 |
| Card Slot Selection | 3-18 |

| | |
|---|-------|
| Removing an IP Card | 3-28 |
| Configuring an IPGWx Linkset | 3-37 |
| Configuring a Mate IPGWx Linkset | 3-63 |
| Adding an IP Signaling Link | 3-84 |
| Example Signaling Link Configuration | 3-87 |
| Enabling the Large System # Links Controlled Feature | 3-104 |
| Removing an IP Signaling Link | 3-113 |
| Changing the IP Protocol Option | 3-123 |
| Changing IP Options other than SYNC and SCTPCSUM | 3-130 |
| Changing an IP Link | 3-135 |
| Adding an IP Host | 3-153 |
| Removing an IP Host | 3-156 |
| Changing an IP Card | 3-161 |
| Adding an IP Route | 3-171 |
| Removing an IP Route | 3-177 |
| Adding an Application Socket | 3-181 |
| Removing an Application Socket | 3-198 |
| Changing an Application Socket | 3-202 |
| Configuring IP Socket Retransmission Parameters | 3-220 |
| Changing a DCM Parameter Set | 3-226 |
| Adding a Routing Key Containing a Socket | 3-233 |
| Adding a Routing Key Containing an Application Server | 3-250 |
| Removing a Routing Key | 3-272 |
| Changing the CIC Values in an Existing Routing Key | 3-283 |
| Changing the Routing Context Value in an Existing Routing Key | 3-295 |
| Changing the PSTN Presentation and Normalization Attributes in a Routing Key | 3-303 |
| Increasing the System-Wide IPGWx Signaling TPS | 3-317 |
| Configuring the IP TPS Alarm Threshold | 3-324 |
| IETF Adapter Layer Configuration | 3-326 |
| Adding an Association | 3-327 |
| Removing an Association | 3-344 |
| Changing an Association | 3-348 |
| Configuring SCTP Retransmission Control for an Association | 3-381 |
| Changing an M2PA Timer Set | 3-389 |

Table of Contents

| | |
|---|-------|
| Adding a New Association to a New Application Server | 3-397 |
| Adding an Existing Association to a New Application Server | 3-406 |
| Adding a New Association to an Existing Application Server | 3-417 |
| Adding an Existing Association to an Existing Application Server | 3-429 |
| Removing an Association from an Application Server | 3-441 |
| Changing an Application Server | 3-447 |
| Adding a Network Appearance | 3-452 |
| Removing a Network Appearance | 3-459 |
| Changing the SCTP Checksum Algorithm Option | 3-462 |
| Changing a UA Parameter Set | 3-486 |
| Chapter 4. ISUP Variant Table Provisioning | |
| Overview | 4-2 |
| Adding New ISUP PSTN Presentation Values | 4-6 |
| Changing ISUP Presentation Values | 4-11 |
| Removing ISUP Presentation Values | 4-13 |
| Changing ISUP Variant Table Entries | 4-17 |
| Copying ISUP Variant Table Entries | 4-26 |
| Chapter 5. End Office Support | |
| Overview | 5-2 |
| Internal Point Code | 5-4 |
| End Office Support Configuration | 5-13 |
| Adding an End Node Internal Point Code | 5-14 |
| Removing an End Node Internal Point Code | 5-18 |
| Chapter 6. Activating Controlled Features | |
| Introduction | 6-2 |
| Enabling Controlled Features | 6-2 |
| Enabling a Permanent or Temporary Key | 6-3 |
| Temporary Feature Keys | 6-7 |
| Turning On and Off Controlled Features | 6-10 |
| Turning On an Enabled Controlled Feature | 6-10 |
| Turning Off an Enabled Controlled Feature | 6-12 |
| Index | |

List of Figures

| | |
|--|------|
| Figure 1-1. Database Partitions | 1-11 |
| Figure 2-1. TCP socket or SCTP Association Database Relationships | 2-6 |
| Figure 2-2. IP Connections using a Dual-Slot DCM running the IPLIMx Applications | 2-7 |
| Figure 2-3. IP Connections using a Dual-Slot DCM running the IPGWx Applications | 2-8 |
| Figure 2-4. IP Connections using an EDCM or E5-ENET Card running the IPGWx Applications | 2-9 |
| Figure 2-5. Typical SCTP Association and TCP Socket Configuration | 2-10 |
| Figure 2-6. SCTP Association and TCP Socket on the Same IP Card | 2-12 |
| Figure 2-7. IP Connections using SSEDICMs running the IPLIMx Applications | 2-13 |
| Figure 2-8. IP Connections using E5-ENET Cards running the IPLIMx Applications | 2-13 |
| Figure 2-9. Multi-Homed Associations on EDCMs or E5-ENET Cards running the IPLIMx Applications | 2-15 |
| Figure 2-10. Multi-Homed Associations on EDCMs or E5-ENET Cards running the IPGWx Applications | 2-16 |
| Figure 2-11. Multi-Homed Association Database Relationships | 2-17 |
| Figure 2-12. EAGLE 5 ISS Network (STP Connectivity via MTP-over-IP) | 2-21 |
| Figure 2-13. IP Network (SCP Connectivity via TCAP-over-IP) | 2-22 |
| Figure 2-14. IP Network (SEP connectivity via ISUP, Q.BICC, and TUP-over-IP) | 2-24 |
| Figure 2-15. Complex Network with ANSI, ITU-I, and ITU-N Nodes | 2-35 |
| Figure 2-16. 8-bit TOS Field | 2-40 |
| Figure 2-17. DS Field | 2-40 |

List of Figures

| | |
|--|------|
| Figure 2-18. ISUP Normalization Supporting Multiple ISUP Variants | 2-41 |
| Figure 2-19. Format of PSTN Presentation | 2-45 |
| Figure 2-20. AS/Association Relationship | 2-49 |
| Figure 2-21. TCP Socket/SCTP Association Relationship | 2-50 |
| Figure 2-22. SG/MGC/MG Network Diagram | 2-50 |
| Figure 2-23. TALI Protocol Stack (IPGWx and IPLIMx) | 2-51 |
| Figure 2-24. IPLIMx Protocol Stack with SCTP as the Transport Layer | 2-52 |
| Figure 2-25. IPGWx Protocol Stack with SCTP as the Transport Layer | 2-52 |
| Figure 2-26. M2PA in the IP ⁷ Signaling Gateway | 2-56 |
| Figure 2-27. SCTP Connectivity | 2-59 |
| Figure 3-1. Mixed Network with ANSI, ITU-I, and ITU-N Nodes | 3-6 |
| Figure 3-2. IP ⁷ Secure Gateway Database Relationships | 3-12 |
| Figure 3-3. Typical Configuration | 3-14 |
| Figure 5-1. A EAGLE 5 ISS with End Office Support and VXI Node | 5-6 |
| Figure 5-2. Network Before a EAGLE 5 ISS with End Office, Node P is to Migrate | 5-6 |
| Figure 5-3. Network After a EAGLE 5 ISS with End Office, Node P has Migrated | 5-7 |
| Figure 5-4. Original Network with Deployed EAGLE 5 ISS | 5-7 |
| Figure 5-5. New Network with a EAGLE 5 ISS Using End Office and End Node R | 5-8 |
| Figure 5-6. Network before Two Signaling End Points Migrate from PSTN to IP | 5-8 |
| Figure 5-7. Network after Two Signaling End Points Migrate from PSTN to IP | 5-9 |
| Figure 5-8. The EAGLE 5 ISS Simultaneously Acts as STP and End Office | 5-10 |
| Figure 5-9. Three Multiple-Element End Office Nodes | 5-11 |
| Figure 5-10. Mated Pair Supports Two End Office Nodes | 5-12 |

List of Tables

| | |
|---|-------|
| Table 2-1. Ethernet Interface and Signaling Link Combinations | 2-7 |
| Table 2-2. Uni-Homed and Multi-Homed Node Combinations | 2-14 |
| Table 2-3. SS7 Full Routing Keys per IPGWx Functionality | 2-26 |
| Table 2-4. Example SS7 Routing Key Table | 2-28 |
| Table 2-5. Routing Key Lookup Hierarchy | 2-29 |
| Table 2-6. SNMP Object Groups | 2-31 |
| Table 2-7. Deviations from SNMP Protocols | 2-33 |
| Table 2-8. Nodes and Point Codes in Complex Network Example | 2-36 |
| Table 2-9. ISUP Variants Supported by this Feature | 2-42 |
| Table 2-10. Sample SCTP Endpoints | 2-61 |
| Table 2-11. Sample SCTP Associations | 2-61 |
| Table 2-12. Sample SCTP Associations | 2-62 |
| Table 3-1. Typical IP Routing | 3-15 |
| Table 3-2. Typical IP Sockets | 3-15 |
| Table 3-3. Typical IP Routing Keys (SS7IPGW and IPGWI Applications) | 3-16 |
| Table 3-4. Card Type and Card Applications | 3-17 |
| Table 3-5. Example Card Configuration | 3-18 |
| Table 3-6. Signaling Link Fair Share Example | 3-38 |
| Table 3-7. Optional Linkset Parameters | 3-41 |
| Table 3-8. Optional Linkset Parameters | 3-64 |
| Table 3-9. IP Signaling Link Parameter Combinations | 3-86 |
| Table 3-10. IP Signaling Link Configuration Table | 3-87 |
| Table 3-11. Valid Subnet Mask Parameter Values | 3-136 |
| Table 3-12. Valid Subnet Mask Parameter Values | 3-172 |
| Table 3-13. Examples of IPGWx Card Provisioning Limits | 3-182 |
| Table 3-14. Examples of IPGWx Card Provisioning Limits | 3-203 |
| Table 3-15. DCMPS Values | 3-226 |
| Table 3-16. Service Indicator Text String Values | 3-233 |
| Table 3-17. Routing Key Parameter Combinations for Adding a Routing Key Containing a Socket | 3-235 |

List of Tables

| | |
|--|-------|
| Table 3-18. Service Indicator Text String Values | 3-250 |
| Table 3-19. Routing Key Parameter Combinations for Adding a Routing Key Containing an Application Server | 3-252 |
| Table 3-20. Service Indicator Text String Values | 3-272 |
| Table 3-21. Routing Key Parameter Combinations for Removing Routing Keys | 3-273 |
| Table 3-22. Service Indicator Text String Values | 3-283 |
| Table 3-23. Routing Key Parameter Combinations for Changing the Range of CIC Values in an Existing Routing Key | 3-285 |
| Table 3-24. Routing Key Parameter Combinations for Splitting the Range of CIC Values in an Existing Routing Key | 3-287 |
| Table 3-25. Service Indicator Text String Values | 3-296 |
| Table 3-26. Service Indicator Text String Values | 3-304 |
| Table 3-27. System-Wide IPGWx Signaling TPS Part Numbers | 3-318 |
| Table 3-28. SCTP Buffer Limits | 3-328 |
| Table 3-29. SCTP Buffer Limits | 3-350 |
| Table 3-30. Examples of IPGWx Card Provisioning Limits | 3-351 |
| Table 3-31. M2PA Timers | 3-390 |
| Table 3-32. Examples of IPGWx Card Provisioning Limits | 3-397 |
| Table 3-33. Examples of IPGWx Card Provisioning Limits | 3-406 |
| Table 3-34. Examples of IPGWx Card Provisioning Limits | 3-417 |
| Table 3-35. Examples of IPGWx Card Provisioning Limits | 3-429 |
| Table 3-36. Valid PVALUE Parameter Values if PARM=1 | 3-487 |
| Table 3-37. Valid PVALUE Parameter Values if PARM=2 | 3-488 |
| Table 4-1. ISUP Variants Supported by this Feature | 4-3 |
| Table 4-2. CHG-ISUPVAR-ATTRIB Parameter Combinations | 4-20 |
| Table 5-1. Sample IPC Values | 5-4 |
| Table 6-1. Sample Controlled Feature Part Numbers | 6-3 |
| Table 6-2. Sample Controlled Feature Part Numbers | 6-10 |
| Table 6-3. Sample Controlled Feature Part Numbers | 6-13 |

List of Flowcharts

| | |
|--|-------|
| Flowchart 3-1. Adding an IP Card | 3-23 |
| Flowchart 3-2. Removing an IP Card | 3-35 |
| Flowchart 3-3. Configuring an IPGWx Linkset | 3-53 |
| Flowchart 3-4. Configuring a Mate IPGWx Linkset | 3-77 |
| Flowchart 3-5. Adding an IP Signaling Link | 3-98 |
| Flowchart 3-6. Enabling the Large System # Links Controlled Feature | 3-110 |
| Flowchart 3-7. Removing an IP Signaling Link | 3-120 |
| Flowchart 3-8. Changing the IP Protocol Option | 3-128 |
| Flowchart 3-9. Changing an IP Option That Does Not Require Inhibiting the IP Card | 3-134 |
| Flowchart 3-10. Changing an IP Link | 3-146 |
| Flowchart 3-11. Adding an IP Host | 3-155 |
| Flowchart 3-12. Removing an IP Host | 3-159 |
| Flowchart 3-13. Changing an IP Card | 3-168 |
| Flowchart 3-14. Adding an IP Route | 3-175 |
| Flowchart 3-15. Removing an IP Route | 3-180 |
| Flowchart 3-16. Adding an Application Socket | 3-192 |
| Flowchart 3-17. Removing an Application Socket | 3-201 |
| Flowchart 3-18. Changing an Application Socket | 3-213 |
| Flowchart 3-19. Configuring IP Retransmission Parameters | 3-225 |
| Flowchart 3-20. Changing an DCM Parameter Set | 3-232 |
| Flowchart 3-21. Adding a Routing Key Containing a Socket | 3-245 |
| Flowchart 3-22. Adding a Routing Key Containing an Application Server | 3-267 |
| Flowchart 3-23. Removing a Routing Key | 3-281 |
| Flowchart 3-24. Changing the CIC values in an Existing Routing Key | 3-293 |
| Flowchart 3-25. Changing the Routing Context Value in an Existing Routing Key | 3-301 |
| Flowchart 3-26. Changing the PSTN Presentation and Normalization Attributes in an Routing Key | 3-311 |

List of Flowcharts

| | |
|---|-------|
| Flowchart 3-27. Increasing the IPGWx Signaling TPS | 3-322 |
| Flowchart 3-28. Configuring the IP TPS Alarm Threshold | 3-325 |
| Flowchart 3-29. Adding an Association | 3-338 |
| Flowchart 3-30. Removing an Association | 3-347 |
| Flowchart 3-31. Changing an Association | 3-369 |
| Flowchart 3-32. Configuring an Association for SCTP Retransmission Control | 3-387 |
| Flowchart 3-33. Changing an M2PA Timer Set | 3-396 |
| Flowchart 3-34. Adding a New Association to a New Application Server | 3-403 |
| Flowchart 3-35. Adding an Existing Association to a New Application Server | 3-413 |
| Flowchart 3-36. Adding a New Association to an Existing Application Server | 3-424 |
| Flowchart 3-37. Adding an Existing Association to an Existing Application Server | 3-436 |
| Flowchart 3-38. Removing an Association from an Application Server | 3-445 |
| Flowchart 3-39. Changing an Application Server | 3-450 |
| Flowchart 3-40. Adding a Network Appearance | 3-456 |
| Flowchart 3-41. Removing a Network Appearance | 3-461 |
| Flowchart 3-42. Changing the SCTP Checksum Option | 3-479 |
| Flowchart 3-43. Changing a UA Parameter Set | 3-493 |
| Flowchart 4-1. Adding ISUP PSTN Presentation Value | 4-9 |
| Flowchart 4-2. Changing ISUP PSTN Presentation Value | 4-12 |
| Flowchart 4-3. Removing ISUP PSTN Presentation Value | 4-16 |
| Flowchart 4-4. Changing ISUP Attribute Values | 4-24 |
| Flowchart 4-5. Copying ISUP Attribute Values | 4-30 |
| Flowchart 5-1. Adding an End Node Internal Point Code | 5-17 |
| Flowchart 5-2. Removing an End Node Internal Point Code | 5-20 |
| Flowchart 6-1. Enabling a Permanent or Temporary Key | 6-6 |
| Flowchart 6-2. Clearing a Temporary Feature Access Key Alarm | 6-9 |
| Flowchart 6-3. Turning On an Enabled Controlled Feature | 6-12 |
| Flowchart 6-4. Turning Off an Enabled Controlled Feature | 6-14 |

List of Flowcharts

1

Introduction

| | |
|---|------|
| Overview | 1-2 |
| Manual Organization | 1-2 |
| Related Publications..... | 1-3 |
| Documentation Packaging, Delivery, and Updates..... | 1-8 |
| Documentation Admonishments..... | 1-8 |
| Customer Care Center | 1-9 |
| Emergency Response | 1-10 |
| Maintenance and Administration Subsystem | 1-10 |
| Database Partitions..... | 1-11 |
| Fixed Disk Drive..... | 1-12 |
| Removable Cartridge..... | 1-13 |
| List of Acronyms and Abbreviations..... | 1-14 |

Overview

The *Database Administration Manual – IP⁷ Secure Gateway* describes the procedures necessary for database administration personnel or translations personnel to create, modify, display, and maintain the EAGLE 5 ISS database, and to configure the EAGLE 5 ISS to implement the IP⁷ Secure Gateway functionality.

NOTE: Database administration privileges are password restricted. Only those persons with access to the command class “Database Administration” can execute the administrative functions. Other command classes and the commands allowed by those classes are listed in the *Commands Manual*.

Manual Organization

Throughout this document, the terms database and system software are used. Database refers to all data that can be administered by the user, including shelves, cards, links, routes, global title translation tables, and gateway screening tables. System software refers to data that cannot be administered by the user, including generic program loads (GPLs).

This document is organized into these sections:

Chapter 1, “Introduction,” contains general information about the database and the organization of this manual.

Chapter 2, “IP⁷ Secure Gateway Overview,” describes the basics of the IP⁷ Secure Gateway functionality.

Chapter 3, “IP⁷ Secure Gateway Configuration Procedures,” describes the procedures necessary to configure the EAGLE 5 ISS to provide connectivity between SS7 and IP networks, enabling messages to pass between the SS7 network domain and the IP network domain, including the procedures necessary to configure the EAGLE 5 ISS to use the SUA, M3UA, and M2PA adapter layers.

Chapter 4, “ISUP Variant Table Provisioning,” describes the procedures necessary to configure the ISUP Variant Tables.

Chapter 5, “End Office Support,” describes the procedures necessary to allow the EAGLE 5 ISS to share its true point code (TPC) with an IP-based node without the need for a separate point code for the IP node.

Chapter 6, “Activating Controlled Features,” explains how to enable controlled features with temporary and permanent feature keys, how to clear the alarms for near to expired and expired temporary keys, and how to turned enabled On/Off features on and off.

Related Publications

The *Database Administration Manual – IP⁷ Secure Gateway* is part of the EAGLE 5 ISS documentation set and may refer to one or more of the following manuals:

- The *Commands Manual* contains procedures for logging into or out of the EAGLE 5 ISS, a general description of the terminals, printers, the disk drive used on the EAGLE 5 ISS, and a description of all the commands used in the EAGLE 5 ISS.
- The *Commands Error Recovery Manual* contains the procedures to resolve error message conditions generated by the commands in the *Commands Manual*. These error messages are presented in numerical order.
- The *Database Administration Manual – Features* contains procedural information required to configure the EAGLE 5 ISS to implement these features:
 - X.25 Gateway
 - STPLAN
 - Database Transport Access
 - GSM MAP Screening
 - EAGLE 5 Integrated Monitoring Support.
- The *Database Administration Manual – Global Title Translation* contains procedural information required to configure an EAGLE 5 ISS to implement these features:
 - Global Title Translation
 - Enhanced Global Title Translation
 - Variable Length Global Title Translation
 - Interim Global Title Modification
 - Intermediate GTT Load Sharing
 - ANSI-ITU-China SCCP Conversion
 - Flexible GTT Load Sharing
 - Origin-Based SCCP Routing.
- The *Database Administration Manual - Gateway Screening* contains a description of the Gateway Screening (GWS) feature and the procedures necessary to configure the EAGLE 5 ISS to implement this feature.
- The *Database Administration Manual – SEAS* contains the EAGLE 5 ISS configuration procedures that can be performed from the Signaling Engineering and Administration Center (SEAC) or a Signaling Network Control Center (SNCC). Each procedure includes a brief description of the

procedure, a flowchart showing the steps required, a list of any EAGLE 5 ISS commands that may be required for the procedure but that are not supported by SEAS, and a reference to optional procedure-related information, which can be found in one of these manuals:

- *Database Administration Manual – Gateway Screening*
- *Database Administration Manual – Global Title Translation*
- *Database Administration Manual – SS7.*
- The *Database Administration Manual – SS7* contains procedural information required to configure an EAGLE 5 ISS to implement the SS7 protocol.
- The *Database Administration Manual – System Management* contains procedural information required to manage the EAGLE 5 ISS database and GPLs, and to configure basic system requirements such as user names and passwords, system-wide security requirements, and terminal configurations.
- The *Dimensioning Guide for EPAP Advanced DB Features* is used to provide EPAP planning and dimensioning information. This manual is used by Tekelec personnel and EAGLE 5 ISS customers to aid in the sale, planning, implementation, deployment, and upgrade of EAGLE 5 ISS systems equipped with one of the EAGLE 5 ISS EPAP Advanced Database (EADB) Features.
- The *ELAP Administration Manual* defines the user interface to the EAGLE 5 ISS LNP Application Processor on the MPS/ELAP platform. The manual defines the methods for accessing the user interface, menus, screens available to the user and describes their impact. It provides the syntax and semantics of user input, and defines the output the user receives, including information and error messages, alarms, and status.
- The *EPAP Administration Manual* describes how to administer the EAGLE 5 ISS Provisioning Application Processor on the MPS/EPAP platform. The manual defines the methods for accessing the user interface, menus, and screens available to the user and describes their impact. It provides the syntax and semantics of user input and defines the output the user receives, including messages, alarms, and status.
- The *Feature Manual - ECAP* provides instructions and information on how to install, use, and maintain the Integrated Accounting Feature Application feature on the Eagle Collector Application Processor (ECAP). This feature collects raw MSU data from the EAGLE 5 ISS, categorizes the data into groups, and feeds those groups to another system for accounting activities.
- The *Feature Manual - EIR* provides instructions and information on how to install, use, and maintain the EIR feature on the Multi-Purpose Server (MPS) platform of the EAGLE 5 ISS. The feature provides network operators with the capability to prevent stolen or disallowed GSM mobile handsets from accessing the network.

Introduction

- The *Feature Manual - G-Flex C7 Relay* provides an overview of a feature supporting the efficient management of Home Location Registers in various networks. This manual gives the instructions and information on how to install, use, and maintain the G-Flex feature on the Multi-Purpose Server (MPS) platform of the EAGLE 5 ISS.
- The *Feature Manual - A-Port* provides an overview of a feature providing the capability for IS41 mobile subscribers to change service provider while retaining their original Mobile Directory Number (MDN). This manual gives the instructions and information on how to install, use, and maintain the A-Port feature on the Multi-Purpose Server (MPS) platform of the EAGLE 5 ISS.
- The *Feature Manual - G-Port* provides an overview of a feature providing the capability for mobile subscribers to change the GSM subscription network within a portability cluster while retaining their original MSISDNs. This manual gives the instructions and information on how to install, use, and maintain the G-Port feature on the Multi-Purpose Server (MPS) platform of the EAGLE 5 ISS.
- The *Feature Manual - INP* provides the user with information and instructions on how to implement, utilize, and maintain the INAP-based Number Portability (INP) feature on the Multi-Purpose Server (MPS) platform of the EAGLE 5 ISS.
- The *Feature Manual - Migration* provides an overview of a feature providing the capability for IS41 subscribers to migrate to a GSM network and GSM mobile subscribers to migrate to an IS41 network. This manual gives the instructions and information on how to install, use, and maintain the Migration feature on the Multi-Purpose Server (MPS) platform of the EAGLE 5 ISS.
- The *FTP-Based Table Retrieve Application (FTRA) User Guide* describes how to set up and use a PC to serve as the offline application for the EAGLE 5 ISS FTP Retrieve and Replace feature.
- The *Hardware Manual - EAGLE 5 ISS* contains hardware descriptions and specifications of Tekelec's signaling products. These include the EAGLE 5 ISS, OEM-based products such as the ASi 4000 Service Control Point (SCP), the Netra-based Multi-Purpose Server (MPS), and the Integrated Sentinel with Extended Services Platform (ESP) subassembly.

The Hardware Manual provides an overview of each system and its subsystems, details of standard and optional hardware components in each system, and basic site engineering. Refer to this manual to obtain a basic understanding of each type of system and its related hardware, to locate detailed information about hardware components used in a particular release, and to help configure a site for use with the system hardware.

- The *Hardware Manual - Tekelec 1000 Application Server* provides general specifications and a description of the Tekelec 1000 Applications Server

(T1000 AS). This manual also includes site preparation, environmental and other requirements, procedures to physically install the T1000 AS, and troubleshooting and repair of Field Replaceable Units (FRUs).

- The *Hardware Manual - Tekelec 1100 Application Server* provides general specifications and a description of the Tekelec 1100 Applications Server (T1000 AS). This manual also includes site preparation, environmental and other requirements, procedures to physically install the T1100 AS, and troubleshooting and repair of Field Replaceable Units (FRUs).
- The *Installation Manual - EAGLE 5 ISS* contains cabling requirements, schematics, and procedures for installing the EAGLE 5 ISS along with LEDs, connectors, cables, and power cords to peripherals. Refer to this manual to install components or the complete systems.
- The *Installation Manual - Integrated Applications* provides the installation information for integrated applications such as EPAP 4.0 or earlier (Netra-based Multi-Purpose Server (MPS) platform) and Sentinel. The manual includes information about frame floors and shelves, LEDs, connectors, cables, and power cords to peripherals. Refer to this manual to install components or the complete systems.
- The *LNP Database Synchronization Manual - LSMS with EAGLE 5 ISS* describes how to keep the LNP databases at the LSMS and at the network element (the EAGLE 5 ISS is a network element) synchronized through the use of resynchronization, audits and reconciles, and bulk loads. This manual is contained in both the LSMS documentation set and in the EAGLE 5 ISS documentation set.
- The *LNP Feature Activation Guide* contains procedural information required to configure the EAGLE 5 ISS for the LNP feature and to implement these parts of the LNP feature on the EAGLE 5 ISS:
 - LNP services
 - LNP options
 - LNP subsystem application
 - Automatic call gapping
 - Triggerless LNP feature
 - Increasing the LRN and NPANXX Quantities on the EAGLE 5 ISS
 - Activating and Deactivating the LNP Short Message Service (SMS) feature.
- The *Maintenance Manual* contains procedural information required for maintaining the EAGLE 5 ISS. The *Maintenance Manual* provides preventive and corrective maintenance procedures used in maintaining the different systems.

Introduction

- The *MPS Platform Software and Maintenance Manual - EAGLE 5 ISS with Tekelec 1000 Application Server* describes the platform software for the Multi-Purpose Server (MPS) based on the Tekelec 1000 Application Server (T1000 AS) and describes how to perform preventive and corrective maintenance for the T1000 AS-based MPS. This manual should be used with the EPAP-based applications (EIR, G-Port, G-Flex, A-Port, Migration, and INP).
- The *MPS Platform Software and Maintenance Manual - EAGLE 5 ISS with Tekelec 1100 Application Server* describes the platform software for the Multi-Purpose Server (MPS) based on the Tekelec 1100 Application Server (T1100 AS) and describes how to perform preventive and corrective maintenance for the T1100 AS-based MPS. This manual should be used with the ELAP-based application (LNP).
- The *Provisioning Database Interface Manual* defines the programming interface that populates the Provisioning Database (PDB) for the EAGLE 5 ISS features supported on the MPS/EPAP platform. The manual defines the provisioning messages, usage rules, and informational and error messages of the interface. The customer uses the PDBI interface information to write his own client application to communicate with the MPS/EPAP platform.
- The *Previously Released Features Manual* summarizes the features of previous EAGLE, EAGLE 5 ISS, and IP⁷ Secure Gateway releases, and it identifies the release number of their introduction.
- The *Release Documentation* contains the following documents for a specific release of the system:
 - *Feature Notice* - Describes the features contained in the specified release. The Feature Notice also provides the hardware baseline for the specified release, describes the customer documentation set, provides information about customer training, and explains how to access the Customer Support Website.
 - *Release Notice* - Describes the changes made to the system during the lifecycle of a release. The Release Notice includes Generic Program Loads (GPLs), a list of PRs resolved in a build, and all known PRs.

NOTE: The *Release Notice* is maintained solely on Tekelec's Customer Support site to provide you with instant access to the most up-to-date release information.
 - *System Overview* - Provides high-level information on SS7, the IP⁷ Secure Gateway, system architecture, LNP, and EOAP.
 - *Master Glossary* - Contains an alphabetical listing of terms, acronyms, and abbreviations relevant to the system.
 - *Master Index* - Lists all index entries used throughout the documentation set.

- The *System Manual – EOAP* describes the Embedded Operations Support System Application Processor (EOAP) and provides the user with procedures on how to implement the EOAP, replace EOAP-related hardware, device testing, and basic troubleshooting information.

Documentation Packaging, Delivery, and Updates

Customer documentation is provided with each system in accordance with the contract agreements.

Customer documentation is updated whenever significant changes that affect system operation or configuration are made.

Customer documentation updates may be issued in the form of an addendum, or a reissue of the affected documentation.

The document part number is shown on the title page along with the current revision of the document, the date of publication, and the software release that the document covers. The bottom of each page contains the document part number and the date of publication.

Two types of releases are major software releases and maintenance releases. Maintenance releases are issued as addenda with a title page and change bars. On the changed pages, the date and document part number are changed. On any unchanged pages that accompany the changed pages, the date and document part number are unchanged.

In the event a software release has minimum affect on documentation, an addendum is provided. The addendum provides an instruction page, a new title page, a change history page, and replacement chapters bearing the date of publication, the document part number, and change bars.

If a new release has a major impact on documentation, such as a new feature, the entire documentation set is reissued with a new part number and a new release number.

Documentation Admonishments



Admonishments are icons and text that may appear in this and other EAGLE 5 ISS manuals that alert the reader to assure personal safety, to minimize possible service interruptions, and to warn of the potential for equipment damage.

Following are the admonishments, listed in descending order of priority.



DANGER:

(This icon and text indicate the possibility of *personal injury*.)

| | |
|---|---|
|  | CAUTION: (This icon and text indicate the possibility of <i>service interruption</i> .) |
|  | WARNING: (This icon and text indicate the possibility of <i>equipment damage</i> .) |

Customer Care Center

The Customer Care Center offers a point of contact through which customers can receive support for problems that may be encountered during the use of Tekelec's products. The Customer Care Center is staffed with highly trained engineers to provide solutions to your technical questions and issues seven days a week, twenty-four hours a day. A variety of service programs are available through the Customer Care Center to maximize the performance of Tekelec products that meet and exceed customer needs.

To receive technical assistance, call the Customer Care Center at one of the following locations:

- Tekelec, UK

Phone: +44 1784 467 804

Fax: +44 1784 477 120

Email: ecsc@tekelec.com

- Tekelec, USA

Phone (within the continental US) 888-367-8552 (888-FOR-TKLC)
(outside the continental US) +1 919-460-2150.

Email: support@tekelec.com.

When your call is received, the Customer Care Center issues a Customer Service Report (CSR). Each CSR includes an individual tracking number. When a CSR is issued, the Customer Care Center determines the classification of the trouble. The CSR contains the serial number of the system, problem symptoms, and messages. The Customer Care Center assigns the CSR to a primary engineer, who will work to solve the problem. The Customer Care Center closes the CSR when the problem is resolved.

If a critical problem exists, the Customer Care Center initiates emergency procedures (see the following topic, "Emergency Response").

Emergency Response

If a critical service situation occurs, the Customer Care Center offers emergency response twenty-four hours a day, seven days a week. The emergency response provides immediate coverage, automatic escalation, and other features to ensure a rapid resolution to the problem.

A critical situation is defined as an EAGLE 5 ISS or LSMS problem that severely affects service, traffic, or maintenance capabilities, and requires immediate corrective action. Critical problems affect service or system operation, resulting in:

- Failure in the system that prevents transaction processing
- Reduction in EAGLE 5 ISS capacity or in EAGLE 5 ISS traffic-handling capability
- Inability to restart the EAGLE 5 ISS
- Corruption of the database
- Inability to perform maintenance or recovery operations
- Inability to provide any required critical or major trouble notification
- Any other problem severely affecting service, capacity, traffic, and billing. Maintenance capabilities may be defined as critical by prior discussion and agreement with the Customer Care Center.

Maintenance and Administration Subsystem

The maintenance and administration subsystem consists of two processors, MASP (maintenance and administration subsystem processor) A and MASP B.

Each MASP is made up of two cards, the GPSM-II card (general purpose service module) and the TDM (terminal disk module).

The GPSM-II card contains the communications processor and applications processor and provides connections to the IMT bus. The GPSM-II controls the maintenance and database administration activity.

The TDM contains the fixed disk drive, the terminal processor for the 16 serial I/O ports and interfaces to the MDAL (maintenance disk and alarm) card which contains the removable cartridge drive and alarm logic. There is only one MDAL card in the maintenance and administration subsystem and it is shared between the two MASPs.

The procedures in the *Database Administration Manual – IP⁷ Secure Gateway* refer to the terms MASP and MDAL. The database commands, such as `rept-stat-db`, refer to the MASP because the MASP controls the input to the TDM and MDAL, and output from the TDM and MDAL. The MDAL is only referred to when inserting or removing the removable cartridge because the removable cartridge drive resides on the MDAL.

For more information on these cards, go to the *Hardware Manual - EAGLE 5 ISS*.

Database Partitions

The data that the EAGLE 5 ISS uses to perform its functions are stored in two separate areas: the fixed disk drives, and the removable cartridge. The Fixed Disk Drive section on page 1-12 and the Removable Cartridge section on page 1-13 describe these areas and data that is stored on them. These areas and their partitions are shown in Figure 1-1.

Figure 1-1. Database Partitions

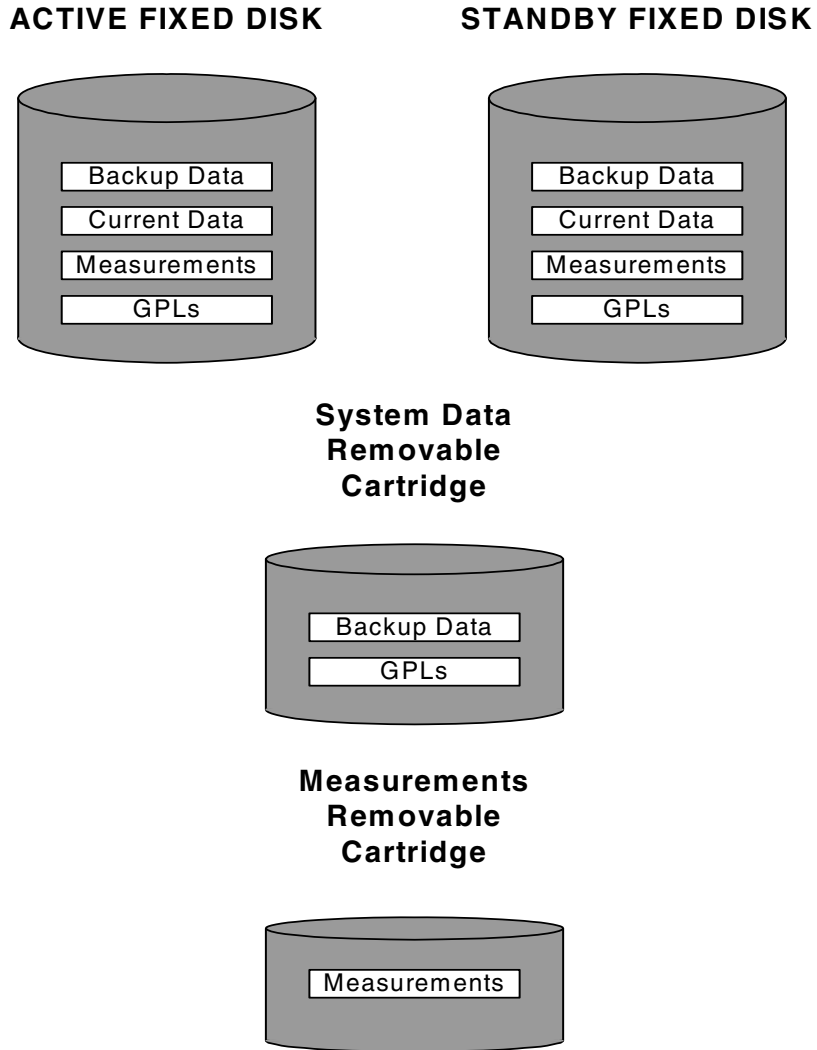

Fixed Disk Drive

There are two fixed disk drives on the EAGLE 5 ISS. The fixed disk drives contain the “master” set of data and programs for the EAGLE 5 ISS. The two fixed disk drives are located on the terminal disk modules (TDMs). Both disks have the same files. The data stored on the fixed disks is partially replicated on the various cards in the EAGLE 5 ISS. Changes made during database administration sessions are sent to the appropriate cards.

The data on the fixed disks can be viewed as four partitions.

- Current partition
- Backup partition
- Measurements partition
- Generic program loads (GPLs) partition

The data which can be administered by users is stored in two partitions on the fixed disk, a current database partition which has the tables which are changed by on-line administration, and a backup database partition which is a user-controlled copy of the current partition.

All of the on-line data administration commands effect the data in the current partition. The purpose of the backup partition is to provide the users with a means of rapidly restoring the database to a known good state if there has been a problem while changing the current partition.

A full set of GPLs is stored on the fixed disk in the GPL partition. There is an approved GPL and a trial GPL for each type of GPL in this set and a utility GPL, which has only an approved version. Copies of these GPLs are downloaded to the EAGLE 5 ISS cards. The GPL provides each card with its functionality. For example, the **ss7ansi** GPL provides MTP functionality for link interface modules (LIMs).

Measurement tables are organized as a single partition on the fixed disk. These tables are used as holding areas for the measurement counts.

Introduction

Removable Cartridge

A removable cartridge is used for two purposes.

- To hold an off-line backup copy of the administered data and system GPLs
- To hold a copy of the measurement tables

Because of the size of the data stored on the fixed disk drives on the TDMs, a single removable cartridge cannot store all of the data in the database, GPL, and measurements partitions.

To use a removable cartridge to hold the system data, it must be formatted for system data. To use a removable cartridge to hold measurements data, it must be formatted for measurements data. The EAGLE 5 ISS provides the user the ability to format a removable cartridge for either of these purposes. A removable cartridge can be formatted on the EAGLE 5 ISS by using the **format-disk** command. More information on the **format-disk** command can be found in the *Commands Manual*. More information on the removable cartridge drive can be found in the *Hardware Manual - EAGLE 5 ISS*.

The removable cartridge drive is located on the MDAL card in card location 1117.

Additional and preformatted removable cartridges are available from the Customer Care Center.

List of Acronyms and Abbreviations

| | |
|---------------|---|
| ACMENET | Applications Communications Module with the Ethernet interface |
| ACT | Activate |
| ALIASA | ANSI Alias Point Code |
| ALIASI..... | ITU International Alias Point Code |
| ALIASN | ITU National Alias Point Code |
| ANSI | American National Standards Institute |
| APC..... | Adjacent Point Code |
| APCA..... | ANSI Adjacent Point Code |
| APCI..... | ITU International Adjacent Point Code |
| APCN..... | ITU National Adjacent Point Code |
| APPL..... | Application |
| AS | Application Server |
| ASCII..... | American Standard Code for Information Interchange |
| AST..... | Associated State for Maintenance |
| ATM | Asynchronous Transfer Mode |
| ATMANSI | The application software for the ATM (high-speed) SS7 signaling links |
| ATMITU | The application software for the ITU ATM (high-speed) SS7 signaling links |
| BEI..... | Broadcast Exception Indicator |
| BPDCM..... | Application software for flash memory management on the DCM card |
| BPS | Bits per Second or Bytes per Second |
| CCS7ITU..... | The application software for the ITU SS7 (low-speed) signaling links |
| CHG | Change |
| CIC | Circuit Identification Code |
| CLLI | Common Language Location Identifier |
| Cmd Rej..... | Command Rejected |
| CPC | Capability Point Code |

Introduction

| | |
|----------------|---|
| CPU..... | Central Processing Unit |
| DCM | Database Communication Module |
| DCMPS..... | Database Communications Module Parameter Set |
| DEFROUTER..... | Default Router |
| DLT | Delete |
| DNS..... | Domain Name Server |
| DPC..... | Destination Point Code |
| DPCA..... | ANSI Destination Point Code |
| DPCI | ITU International Destination Point Code |
| DPCN | ITU National Destination Point Code |
| DS..... | Differentiated Service |
| DTA..... | Database Transport Access |
| DTE | Data Terminal Equipment |
| E1..... | European equivalent of the North American 1.544 Mbps T1 (Trunk Level 1) except that E1 carries information at 2.048 Mbps. |
| ECM..... | Error Correction Method |
| EDCM..... | Enhanced-Performance Database Communications Module |
| ELEI | Exception List Exclusion Indicator |
| ENT | Enter |
| EO | End Office |
| EOAM..... | Enhanced Operations, Administration, and Maintenance |
| FAK | Feature Access Key |
| FTP | File Transfer Protocol |
| G-FLEX..... | GSM Flexible Numbering |
| G-PORT | GSM Portability |
| GLS | Gateway Loading Services – Application software for the gateway screening loading services |
| GPL | Generic Program Load |
| GPSM..... | General Purpose Service Module |
| GTT | Global Title Translation |

| | |
|--------|--|
| GWS | Gateway Screening |
| GWSA | Gateway Screening Application |
| GWSD | Gateway Screening Message Discard |
| GWSM | Gateway Screening Mode |
| HIPR | High-Speed IMT Packet Router |
| HMUX | High-Speed Multiplexer |
| I/O | Input/Output |
| ICMP | Internet Control Message Protocol |
| ID | Identity |
| IEEE | Institute of Electrical and Electronic Engineers |
| IETF | Internet Engineering Task Force |
| IMT | Interprocessor Message Transport |
| INH | Inhibit |
| INIT | Initialize |
| IP | Internet Protocol |
| IPADDR | IP Address |
| IPC | Internal Point Code |
| IPGWI | An ITU version of SS7IPGW application software |
| IPGWx | Point to multi-point EAGLE 5 ISS application software, referring to SS7IPGW (ANSI) and IPGWI (ITU) |
| IPLIM | Application software for TCP/IP point-to-point connectivity for ANSI networks |
| IPLIMI | Application software for TCP/IP point-to-point connectivity for ITU networks |
| IPLIMx | Point to point EAGLE 5 ISS application software, referring to IPLIM (ANSI) and IPLIMI (ITU) |
| IS-NR | In Service - Normal |
| ISUP | ISDN User Part |
| ITU | International Telecommunications Union |
| ITU-I | ITU International |
| ITU-N | ITU National |
| LAN | Local Area Network |
| LHOST | Local Host |

Introduction

| | |
|----------------|--|
| LIM | Link Interface Module |
| LIMATM | LIM used with ATM (high-speed) signaling links |
| LIMCH | A LIM used as a channel card with either the E1 or T1 interfaces |
| LIMDS0 | LIM with a DS0A interface |
| LIME1 | LIM with an E1 Interface |
| LIME1ATM | LIM used with ITU ATM (high-speed) signaling links |
| LIMOCU | LIM with a OCU interface |
| LIMT1 | LIM with a T1 interface |
| LIMV35 | LIM with a V.35 interface |
| LNP | Local Number Portability |
| LOC | Location |
| LPORT | The TCP or SCTP port number for the local host |
| LS | Linkset |
| LSMS | Local Service Management System |
| LSN | Linkset Name |
| LST | Linkset Type |
| M2PA | SS7 MTP2-User Peer-to-Peer Adaptation Layer |
| M3UA | SS7 MTP3 Adaptation Layer |
| MAP | Mated Application |
| MAP | Mobile Application Part |
| MAS | Maintenance and Administration Subsystem |
| MASP | Maintenance and Administration Subsystem Processor |
| MDAL | Maintenance Disk and Alarm Card |
| MSU | Message Signaling Unit |
| MTP | Message Transfer Part |
| MTP2 | Message Transfer Part, Level 2 |
| MTP3 | Message Transfer Part, Level 3 |
| NA | Network Appearance |
| NE | Near End |
| NEI | Network Element Interface |
| NI | Network Identifier |

| | |
|--------------|---|
| NMS | Network Management System |
| OCU | Office Channel Unit |
| OOS | Out of Service |
| OOS-MT-DSBLD | Out of Service - Maintenance Disabled |
| OPC | Originating Point Code |
| PC | Point Code |
| PC | Personal Computer |
| PCR | Preventive Cyclic Retransmission |
| PDU | Protocol Data Unit |
| PST | Primary State for Maintenance |
| PSTN | Public Switched Telephone Network |
| REPT-STAT | Report Status |
| RHOST | Remote Host |
| RMV | Remove |
| RPORT | The TCP or SCTP port number of the remote host |
| RST | Restore |
| RTRV | Retrieve |
| SAAL | Signaling ATM Adaptation Layer |
| SCCP | Signaling Connection Control Part – Application software for the global title translation (GTT) feature |
| SCMG | SCCP Management |
| SCRN | Screen Set Name |
| SCTP | Stream Control Transmission Protocol |
| SEAC | Signaling Engineering and Administration Center |
| SEAS | Signaling Engineering and Administration System |
| SGP | Signaling Gateway Process |
| SI | Service Indicator |
| SIO | Service Information Octet |
| SLC | Signaling Link Code |
| SLK | Signaling Link |
| SLS | Signaling Link Selector |
| SLSCI | 5- to 8-bit SLS Conversion Indicator |

Introduction

| | |
|-----------------|--|
| SNCC | Signaling Network Control Center |
| SNM..... | Signaling Network Management |
| SNMP | Simple Network Management Protocol |
| SS7..... | Signaling System #7 |
| SS7 DPC..... | SS7 Destination Point Code |
| SS7ANSI..... | The application software for the ANSI SS7 signaling links |
| SS7IPGW | The application software for IP ⁷ signaling gateway feature point-to-multipoint connectivity |
| SS7GX25 | The application software for the X.25/SS7 gateway feature |
| SSEDCM..... | Single-slot EDCM |
| SSN..... | Subsystem Number |
| SST | Secondary State for Maintenance |
| STP | Signal Transfer Point |
| STPLAN | Feature that copies MSUs selected through the gateway screening process and sends these MSUs over the Ethernet to an external host computer for further processing and the application software for the STPLAN feature |
| SUA..... | SCCP User Adaptation Layer |
| T1..... | Trunk Level 1 |
| TALI | Transport Adaptation Layer Interface |
| TCA..... | Transfer Cluster Allowed network management message |
| TCAP | Transaction Capability Application Part |
| TCP | Transmission Control Protocol |
| TCP/IP | Transmission Control Protocol/Internet Protocol |
| TDM..... | Terminal Disk Module |
| TFA..... | Transfer Allowed network management message |
| TFC..... | Transfer Controlled network management message |
| TFATCABMLQ..... | TFA/TCA broadcast minimum link quantity |
| TFP | Transfer Prohibited network management message |
| TFR..... | Transfer Restricted network management message |

| | |
|-------------|--|
| TOS..... | Type of Service |
| TPC..... | True Point Code |
| TSET | Transmitter Signaling Element Timing |
| TSM..... | Translation Services Module |
| TSN | Transmission Sequence Number |
| TUP | Telephony User Part |
| TVG..... | Group Ticket Voucher feature |
| UA | User Adapter |
| UAM..... | Unsolicited Alarm Message |
| UAPS..... | User Adapter Parameter Set |
| UDP..... | User Datagram Protocol |
| UPU..... | User Part Unavailable message |
| XCA..... | Extended Changeover Acknowledgement |
| XCO..... | Extended Changeover |
| X-list..... | Exception list of non-provisioned members of provisioned cluster. |

IP⁷ Secure Gateway Overview

| | |
|--|------|
| Introduction..... | 2-2 |
| Hardware, Applications, and Functions | 2-3 |
| IP Connections | 2-5 |
| Point-to-Point Connectivity (IPLIM or IPLIMI Application)..... | 2-21 |
| Point-to-Multipoint Connectivity (SS7IPGW and IPGWI)..... | 2-22 |
| SNMP Agent Implementation | 2-30 |
| Mixed Networks Using the ANSI/ITU MTP Gateway Feature | 2-34 |
| Nagle's Algorithm | 2-39 |
| Type of Service (TOS) | 2-39 |
| ISUP Normalization | 2-40 |
| IETF Adapter Layer Support | 2-48 |
| Overview | 2-48 |
| Feature Components..... | 2-50 |
| SUA Layer | 2-53 |
| M3UA Layer..... | 2-54 |
| M2PA Layer..... | 2-56 |
| SCTP | 2-57 |
| Broader Definition of Connection Four-Tuple | 2-57 |
| Multiple Streams..... | 2-58 |
| Selective Acknowledgements | 2-58 |

Un-order Delivery Capability2-59
Enhanced Security2-59
SCTP Connectivity Concepts2-59

Introduction

The IP⁷ Secure Gateway functionality in the EAGLE 5 ISS provides connectivity between SS7 and IP networks, enabling messages to pass between the SS7 network domain and the IP network domain, as follows:

- When an EAGLE 5 ISS receives an SS7 formatted message over an SS7 link, the IP⁷ Secure Gateway functionality dynamically convert this message into IP format and routes the re-formatted message over an associated IP link to a destination residing within an IP network.

The IP⁷ Secure Gateway functionality use sockets or associations to access the IP domain. Sockets or associations identify IP sessions.

- Conversely, when the EAGLE 5 ISS receives an IP formatted message over an IP link, the IP⁷ Secure Gateway functionality dynamically convert this message into SS7 format and routes the re-formatted message over an associated SS7 link to a destination residing within the SS7 signaling network.

Address resolution is not performed in the IP to SS7 direction. It is the responsibility of the sending application to ensure that the appropriate SS7 point code information resides in the IP message to allow a valid SS7 message to be constructed for routing to the SS7 network.

Hardware, Applications, and Functions

The IP⁷ Secure Gateway functionality is provided by applications that run on IP cards, either a Database Communications Module (DCM), a single-slot Enhanced-Performance Database Communications Module (EDCM), or E5-ENER card. IP cards provide interfaces between the IMT bus and two 10/100 Base-T IEEE 802.3/DIX Ethernet interfaces. The IP cards, similar to any other Link Interface Module (LIM), use the Interprocessor Message Transport (IMT) bus to communicate with the other cards in the EAGLE 5 ISS. Like other LIMs, the primary job of an IP card is to send and receive SS7 data on a network (in this case, an IP network), and to route that data to other cards in the EAGLE 5 ISS as appropriate.

The IP card can run on the following applications:

- **iplim** or **iplimi** - Both applications support STP connectivity via MTP-over-IP functionality point-to-point connectivity (for more information, see “Connecting STPs Over the IP Network” on page 2-21).

The **iplim** and **iplimi** applications support these types of connections:

- TALI/TCP/IP (B, C, D links)
- M2PA/SCTP/IP (A, B, C, D, and E links)
- SCP
- SEP
- SCP/SEP

This type of connection is essentially the same as that of a traditional SS7 point-to-point link, except that the traditional MTP2 and 56Kb/s technology is replaced by IP and Ethernet technology.

The **iplim** application supports point-to-point connectivity for ANSI networks. The **iplimi** application supports point-to-point connectivity for ITU networks. With the optional ANSI/ITU MTP Gateway feature and proper configuration, the EAGLE 5 ISS could convert between any of the ANSI, ITU-N, and ITU-I networks, switch traffic between these networks, and perform network management for each of these networks (for more information, see “Mixed Networks Using the ANSI/ITU MTP Gateway Feature” on page 2-34).

The EAGLE 5 ISS can support up to 100 cards running the **iplim** and **iplimi** applications.

- **ss7ipgw** and **ipgwi** - These applications support the following types of point-to-multipoint connectivity for networks:
 - SCP connectivity via SCCP/TCAP-over-IP functionality (for more information, see “Connecting to SCPs with SCCP/TCAP Messages Sent Over the IP Network” on page 2-22)
 - SEP connectivity via ISUP, Q.BICC, and TUP-over-IP functionality (for more information, see “Connecting SEPs Using ISUP, Q.BICC, and TUP Messages Over the IP Network” on page 2-23)
 - SCP/SEP connectivity via non-ISUP, non-SCCP, non-Q.BICC, and non-TUP-over-IP functionality (for more information, see “Connecting SCPs and SEPs Using Non-ISUP, Non-SCCP, Non-Q.BICC, and Non-TUP Messages Over the IP Network” on page 2-24)

The **ss7ipgw** application supports point-to-multipoint connectivity for ANSI networks. The **ipgwi** application supports point-to-multipoint connectivity for ITU networks.

The EAGLE 5 ISS can support a maximum of 64 cards running the **ss7ipgw** and **ipgwi** applications.

In addition to running an **iplim**, **iplimi**, **ss7ipgw**, or **ipgwi** application, each IP card supports the following functions:

- A Simple Network Management Protocol (SNMP) agent. For more information, see “SNMP Agent Implementation” on page 2-30.
- Message Transfer Part (MTP) status. This function is available only on IP cards that support the **ss7ipgw** or **ipgwi** application. For more information, see “Support for MTP Status Functions” on page 2-30.

IP Connections

IP connections involve the following assignments:

- Transport protocol – The SCTP transport protocol is specified by the **ent-assoc** and **chg-assoc** commands. The TCP transport protocol is specified by the **ent-appl-sock** and **chg-appl-sock** commands.
- Adapter protocol – The M3UA, M2PA, or SUA adapter protocol is specified by the **adapter** parameter of the **ent-assoc** and **chg-assoc** commands. If TCP sockets are provisioned with the **ent-appl-sock** and **chg-appl-sock** commands, the adapter protocol is implicitly defined as TALI.
- One or two near-end (local) hosts – The local host is specified by the **lhost** parameter of the **ent-assoc**, **chg-assoc**, **ent-appl-sock**, and **chg-appl-sock** commands. A second local host can be specified for an association using the **alhost** parameter of the **ent-assoc** and **chg-assoc** commands, allowing the near-end host of the association to be multi-homed. Specifying only one local host for an association allows the association to be uni-homed.
- Far-end (remote) host – The remote host is specified by the **rhost** parameter of the **ent-assoc**, **chg-assoc**, **ent-appl-sock**, and **chg-appl-sock** commands.
- Near-end (local) transport protocol port – The local transport protocol port is specified by the **lport** parameter of the **ent-assoc**, **chg-assoc**, **ent-appl-sock**, and **chg-appl-sock** commands.
- Far-end (remote) transport protocol port – The remote transport protocol port is specified by the **rport** parameter of the **ent-assoc**, **chg-assoc**, **ent-appl-sock**, and **chg-appl-sock** commands.
- SS7 signaling link – specified by the **loc** and **link** parameters of the **ent-slk** command.

The local host is mapped to a particular Ethernet interface on the IP card by linking the local host name of the IP connection to an IP address with the **ent-ip-host** command. The IP address is also assigned to an IP card and to an Ethernet interface on that IP card using the **chg-ip-lnk** command. A signaling link on that card is assigned to the IP connection using the **link** parameter of the **ent-assoc**, **chg-assoc**, **ent-appl-sock**, and **chg-appl-sock** commands and referencing the signaling link on the IP card.

A TCP socket can establish a connection between one local host and one remote host. An SCTP association can establish a connection between one local host and one remote host (a uni-homed association) or between multiple local hosts and a remote host (a multi-homed association). It is possible that the remote host may be multi-homed, but the EAGLE 5 ISS allows only one remote host to be specified for a multi-homed association. If an IP node has multiple IP address associated with it, then an SCTP association originating from this node may take advantage of this added connectivity by establishing an SCTP multi-homed association.

For more information on multi-homed associations, see the Multi-Homed Sctp Associations section on page 2-14 and the Routing section on page 2-18.

Figure 2-1 shows the components of a TCP socket or Sctp association and how these components interact with each other.

Figure 2-1. TCP socket or Sctp Association Database Relationships

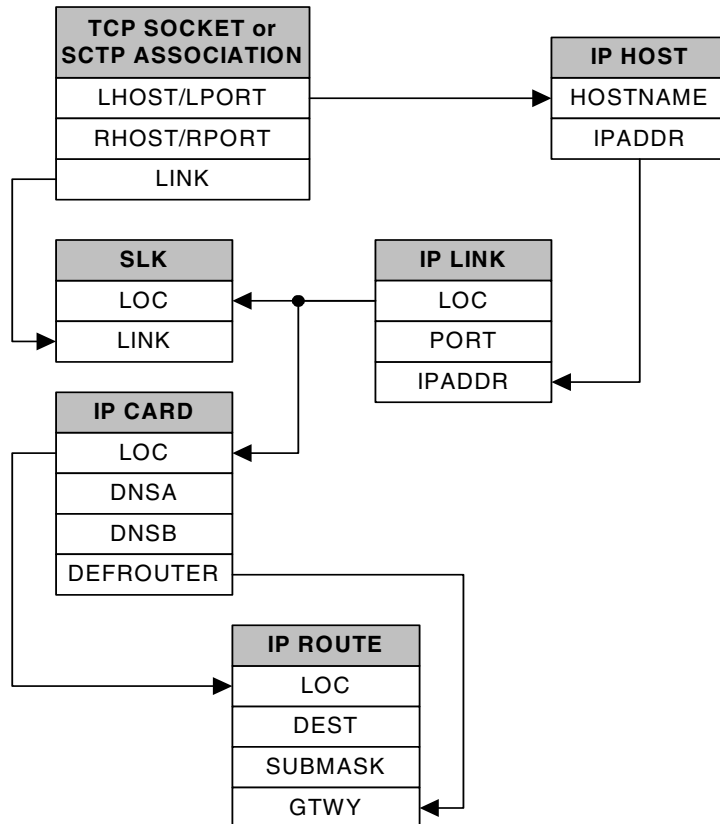

There is no direct correlation between signaling link ports and Ethernet interfaces. A card can be using Ethernet interface A and signaling link B to transmit data to the remote host. Another scenario could have the card using Ethernet interface B and signaling link A to transmit data to the remote host.

The numbers of signaling link ports and Ethernet interfaces on IP cards varies depending on the card type and application running on the card, as shown in Table 2-1. The sections that follow Table 2-1 describe the IP connections supported by each IP card type. The IP connections described in these sections are either TCP sockets or uni-homed Sctp associations.

Table 2-1. Ethernet Interface and Signaling Link Combinations

| Card | Application | Ethernet Interface | Signaling Link |
|---------------------------|-------------|--------------------|---------------------------------|
| Dual-Slot DCM | IPLIMx | A | A and B |
| | IPGWx | A | A |
| Single-slot EDCM (SSEDCM) | IPLIMx | A and B | A, B, A1, B1, A2, B2, A3 and B3 |
| | IPGWx | A and B | A |
| E5-ENET | IPLIMx | A and B | A - A7, B - B7 |
| | IPGWx | A and B | A |

IP Connection on a Dual-Slot DCM Running the IPLIMx Application

Dual-slot DCMs running the IPLIMx applications can have two signaling link ports (A or B) and only one Ethernet interface (A), as shown in Figure 2-2, resulting in a maximum of two IP connections, one for each signaling link, using Ethernet interface A.

Figure 2-2. IP Connections using a Dual-Slot DCM running the IPLIMx Applications

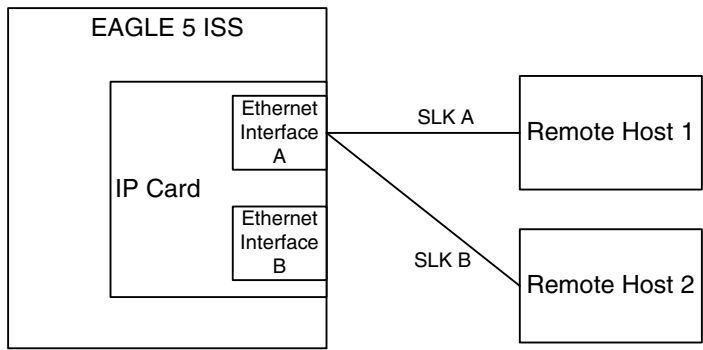

IP Connection on a Dual-Slot DCM Running the IPGWx Application

Dual-slot DCMs running the IPGWx applications can have only one signaling link (A) and one Ethernet interface (A). With this card able to support up to 50 IP connections, these 50 connections are established over Ethernet interface A, using signaling link A, as shown in Figure 2-3.

Figure 2-3. IP Connections using a Dual-Slot DCM running the IPGWx Applications

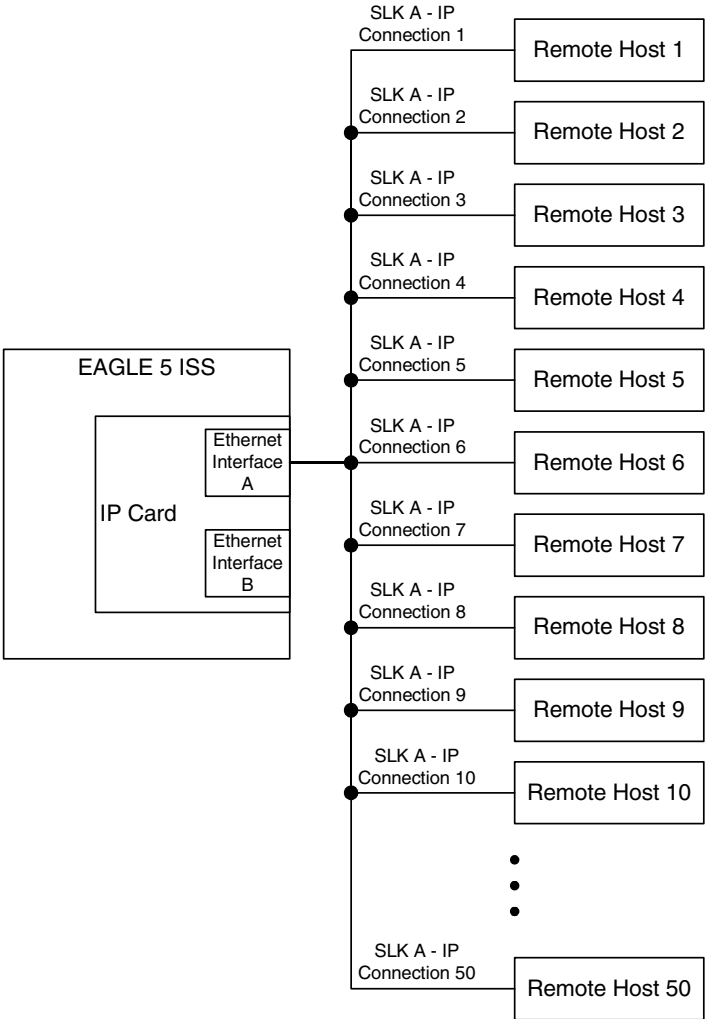

IP Connection on an EDCM or E5-ENET Card Running the IPGWx Application

Single-slot EDCMs running the IPGWx applications can have only one signaling link (A) and two Ethernet interfaces (A or B). With this card able to support up to 50 IP connections, these 50 connections can be established using both Ethernet interfaces A and B, as shown in Figure 2-4. The number of connections on each Ethernet interface can vary, but the total number connections on both interfaces cannot exceed 50. These 50 connections can also be established using only one Ethernet interface (A or B), if desired. Only signaling link A is used for the signaling link.

Figure 2-4. IP Connections using an EDCM or E5-ENET Card running the IPGWx Applications

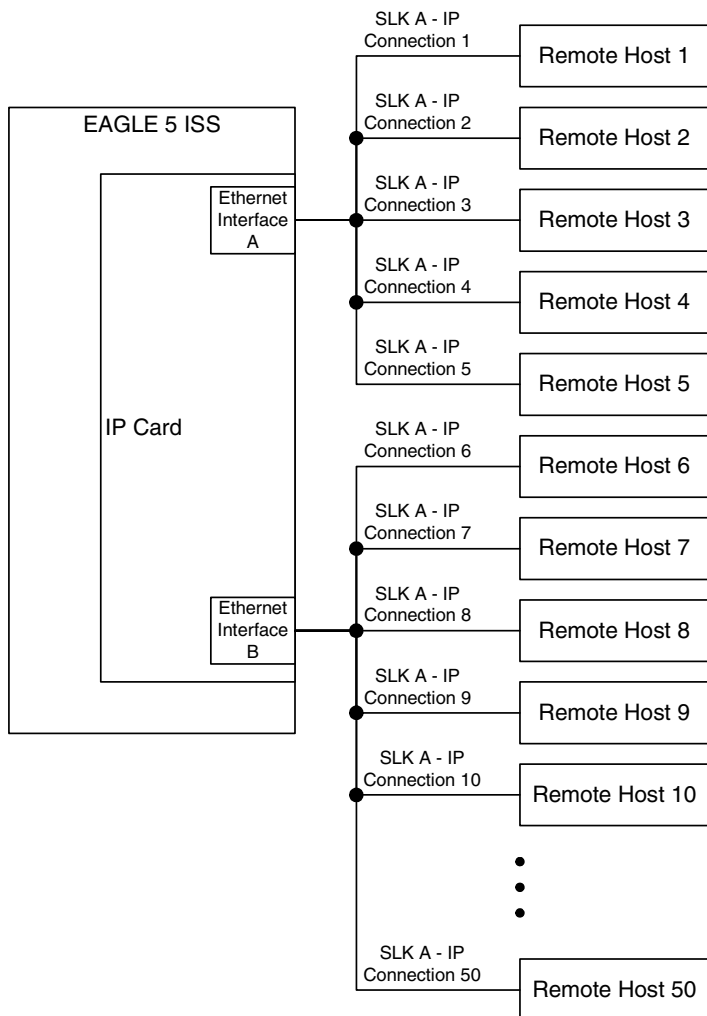

The assignment of the transport protocol (TCP or SCTP) port number is made through the local host port (**lport**) and remote host port (**rport**) parameters of the **ent-appl-sock** or **chg-appl-sock** commands (for a TCP socket), or the **ent-assoc** or **chg-assoc** commands (for an SCTP association). An IP card can have both TCP sockets and SCTP associations assigned to it at the same time. The transport protocol port numbers for TCP sockets are TCP ports. The transport protocol port numbers for SCTP associations are SCTP ports. Port numbers for one transport protocol have no relation to port numbers for the other transport protocol.

Figure 2-5 shows typical IP connection data for a uni-homed SCTP association and a TCP socket and how these components interact with each other.

Figure 2-5. Typical SCTP Association and TCP Socket Configuration

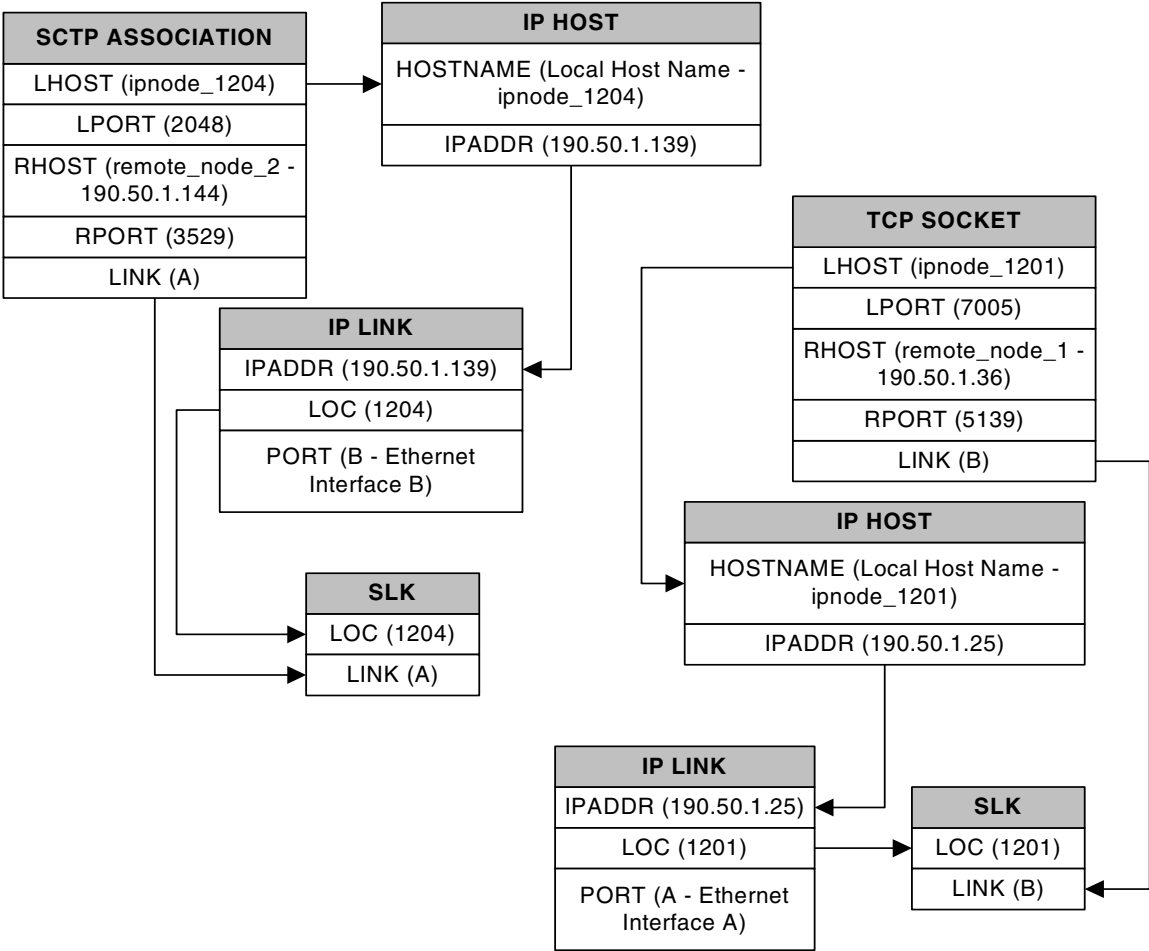

Using the data in Figure 2-5, the IP connection defined by the TCP socket is from local host ipnode-1201 (190.50.1.25), TCP port 7005, to remote host remote-node-1 (190.50.1.36), TCP port 5139, using Ethernet interface A on IP card 1201, and signaling link B on IP card 1201.

The IP connection defined by the SCTP association is from local host ipnode-1204 (190.50.1.139), SCTP port 2048, to remote host remote-node-2 (190.50.1.144), SCTP port 3529, using Ethernet interface B on IP card 1204, and signaling link A on IP card 1204.

In another scenario, IP card 1203 could contain a TCP socket and an SCTP association. The connection defined by the TCP socket is from local host ipnode-1203b (190.50.1.69), TCP port 4096, to remote host remote-node-3 (190.50.1.159), TCP port 1657, using Ethernet interface B on IP card 1203, and signaling link A on IP card 1203. The connection defined by the SCTP association is from local host ipnode-1203a (190.50.1.68), SCTP port 4096, to remote host remote-node-4 (190.50.1.199), SCTP port 1657, using Ethernet interface A on IP card 1203, and signaling link B on IP card 1203. This IP connection scenario is shown in Figure 2-6.

Figure 2-6. Sctp Association and TCP Socket on the Same IP Card

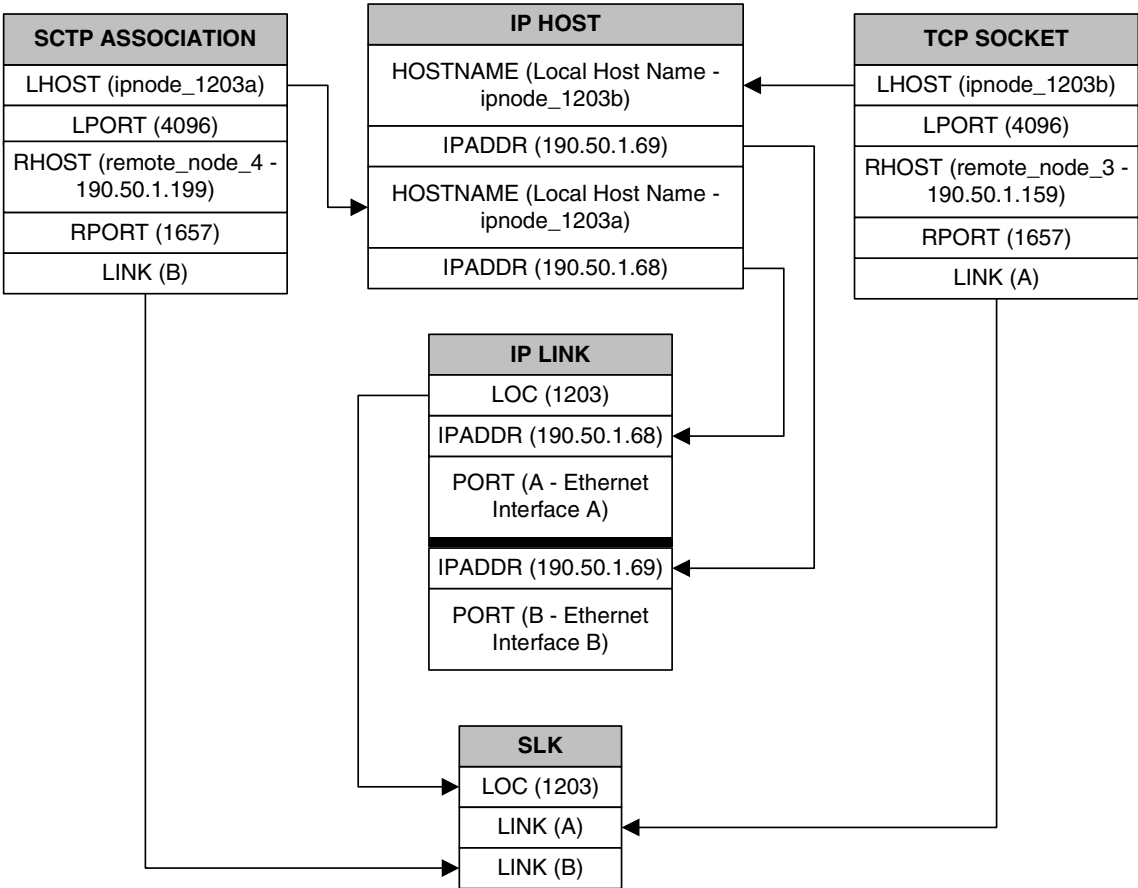

IP Connection on a Single-slot EDCM Running the IPLIMx Application

Single-slot EDCMs (SSEDCMs) running the IPLIMx applications can have 8 signaling links (A, B, A1, B1, A2, B2, A3 or B3) and 2 Ethernet interfaces (A or B) resulting in a maximum of 8 IP connections, one for each signaling link. Each link can use either Ethernet interface A or B. The local host and alternate host assigned to a signaling link must use different Ethernet interfaces; they cannot be assigned to the same Ethernet interface. Figure 2-7 shows some ways the 8 signaling links and the 2 Ethernet interfaces can be used to establish IP connections.

Figure 2-7. IP Connections using SSEDCMs running the IPLIMx Applications

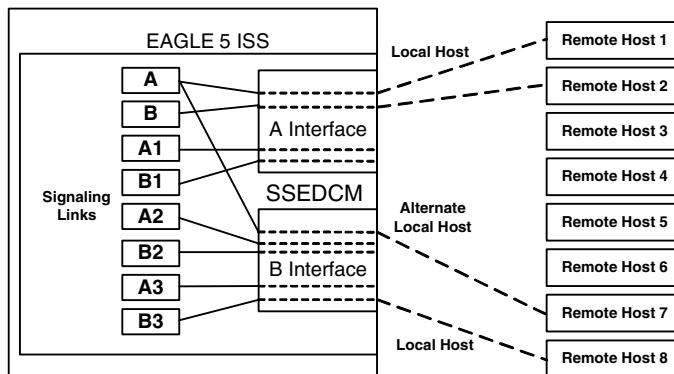

IP Connection on an E5-ENET Card Running the IPLIMx Application

E5-ENET cards running the IPLIMx applications can have 16 signaling links (A, B, A1, B1, A2, B2, A3, B3, A4, B4, A5, B5, A6, B6, A7 or B7) and 2 Ethernet interfaces (A or B) resulting in a maximum of 16 IP connections, one for each signaling link. Each link can use either Ethernet interface A or B. The local host and alternate host assigned to a signaling link must use different Ethernet interfaces; they cannot be assigned to the same Ethernet interface. Figure 2-8 shows some ways the 16 signaling links and the 2 Ethernet interfaces can be used to establish IP connections.

Figure 2-8. IP Connections using E5-ENET Cards running the IPLIMx Applications

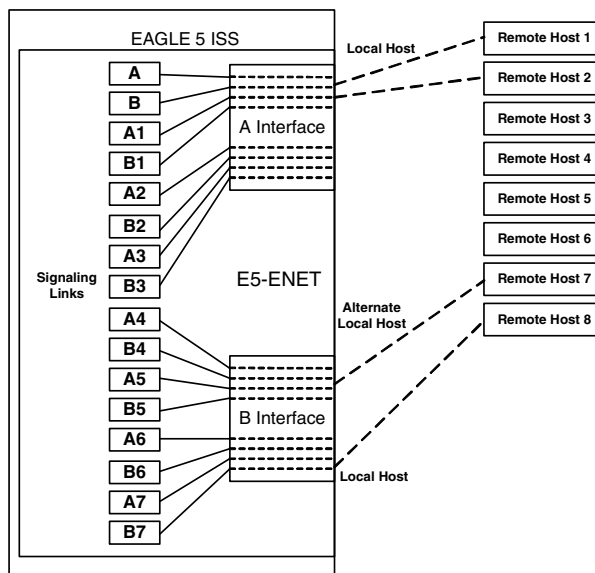

Multi-Homed SCTP Associations

If the IP cards are EDCMs or E5-ENET cards, SCTP associations can have two local hosts, and are referred to as multi-homed associations. A multi-homed association uses both Ethernet interfaces on the IP card. Each Ethernet interface is assigned to a local host. Each local host is assigned to a different local network. One of the local hosts is configured with the `lhost` parameter of the `ent-assoc` or `chg-assoc` commands. The second local host, or alternate local host, is configured with the `alhost` parameter of the `ent-assoc` or `chg-assoc` commands. One of the local hosts references one of the Ethernet interfaces on the IP card and the other local host references the other Ethernet interface on the IP card. The multi-homed SCTP association allows the EDCM or E5-ENET card to communicate with another node over two networks. Traffic is passed to and from the remote node on either local interface on the card.

An SCTP association can be uni-homed also. A uni-homed association uses only one Ethernet interface (A or B), which is assigned to only one local host. This local host is configured with the `lhost` parameter of the `ent-assoc` or `chg-assoc` commands. For a uni-homed association, the `alhost` parameter is not specified with the `ent-assoc` or `chg-assoc` commands. A uni-homed association allows the IP card to communicate to another node on one network only. Traffic is passed to and from the remote node on the local interface on the card defined by the `lhost` parameter.

The remote node can be either uni-homed or multi-homed, and is not dependent on whether or not the local node (containing the local hosts) is uni-homed or multi-homed. For example, Node A can be uni-homed and can be connected to a multi-homed Node B, or a multi-homed Node A can be connected to a uni-homed Node B. Table 2-2 illustrates the possible combinations.

Table 2-2. Uni-Homed and Multi-Homed Node Combinations

| Node A | Node B |
|-------------|-------------|
| Uni-homed | Uni-homed |
| Uni-homed | Multi-homed |
| Multi-homed | Uni-homed |
| Multi-homed | Multi-homed |

Multi-Homed Associations on EDCMs or E5-ENET Cards Running the IPLIMx Application

A multi-homed association on an IPLIMx card uses both Ethernet interfaces to reach the remote host, but only one signaling link. An association, either uni-homed or multi-homed, can be assigned to only one signaling link. That signaling link can be either signaling link A or B. The local and alternate local hosts are assigned to each Ethernet interface on the IP card. The IPLIMx cards are limited to one IP connection per signaling link. Since the IPLIMx cards can have

eight signaling links on the card, eight multi-homed associations can be assigned to an IPLIMx card.

Figure 2-9 shows the ways a multi-homed IP connection can be established on an IPLIMx card. The remote hosts can be multi-homed, but only one remote host can be specified for each multi-homed association in the EAGLE 5 ISS, so only one remote host is shown in Figure 2-9.

Figure 2-9. Multi-Homed Associations on EDCMs or E5-ENET Cards running the IPLIMx Applications

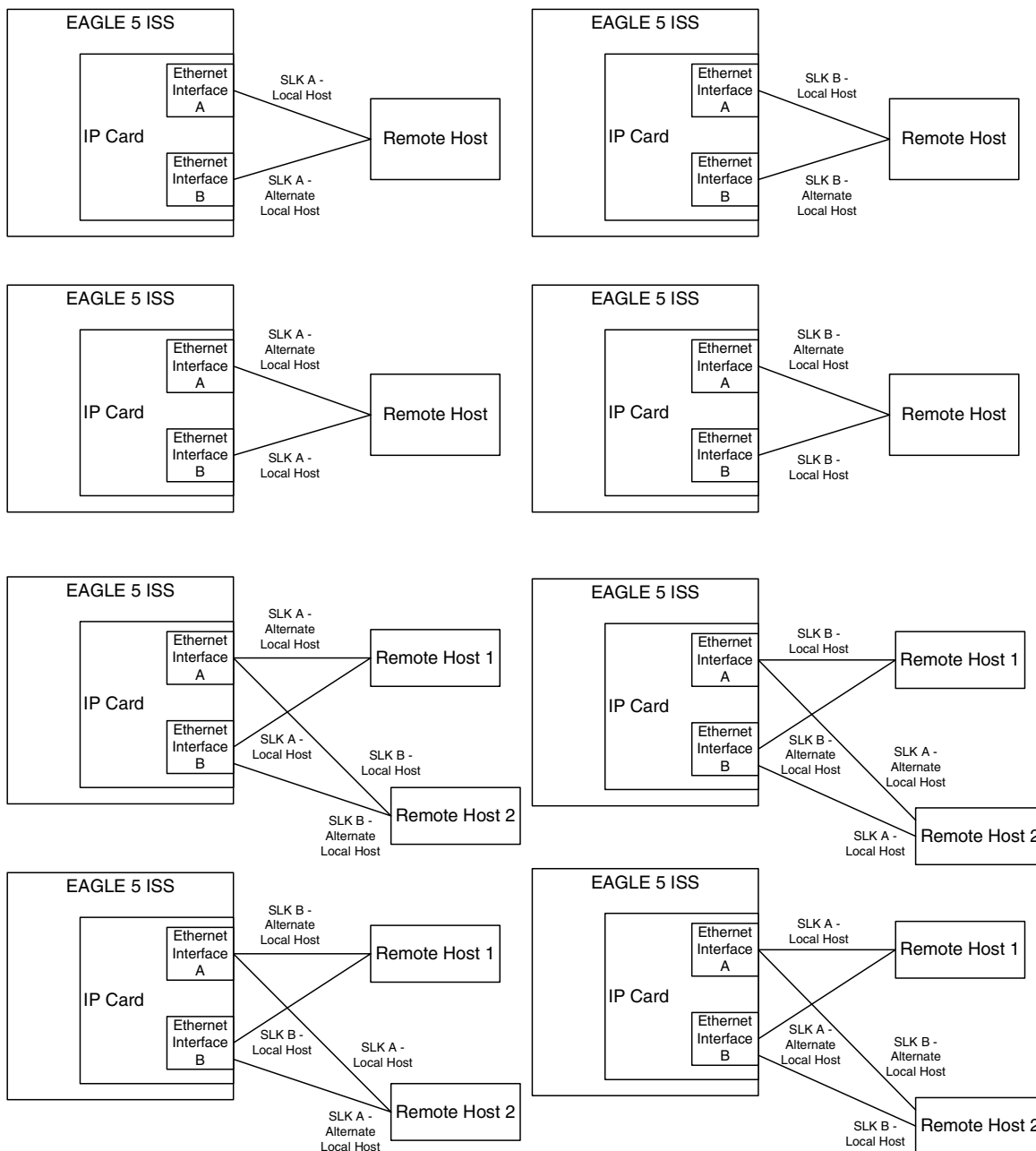

Multi-Homed Associations on EDCMs or E5-ENET Cards Running the IPGWx Applications

A multi-homed association on an IPGWx card uses both Ethernet interfaces to reach the remote host, but only one signaling link, signaling link A on the IPGWx card. The local and alternate local hosts are assigned to each Ethernet interface on the IP card. The IPGWx cards can have up to 50 connections for each IPGWx card. The IPGWx card can contain both uni-homed and multi-homed IP connections, as long as the total number of connections does not exceed 50.

Figure 2-10 shows the way a multi-homed IP connection can be established on an IPGWx card. The remote hosts can be multi-homed, but only one remote host can be specified for each multi-homed association in the EAGLE 5 ISS, so only one remote host is shown in Figure 2-10.

Figure 2-10. Multi-Homed Associations on EDCMs or E5-ENET Cards running the IPGWx Applications

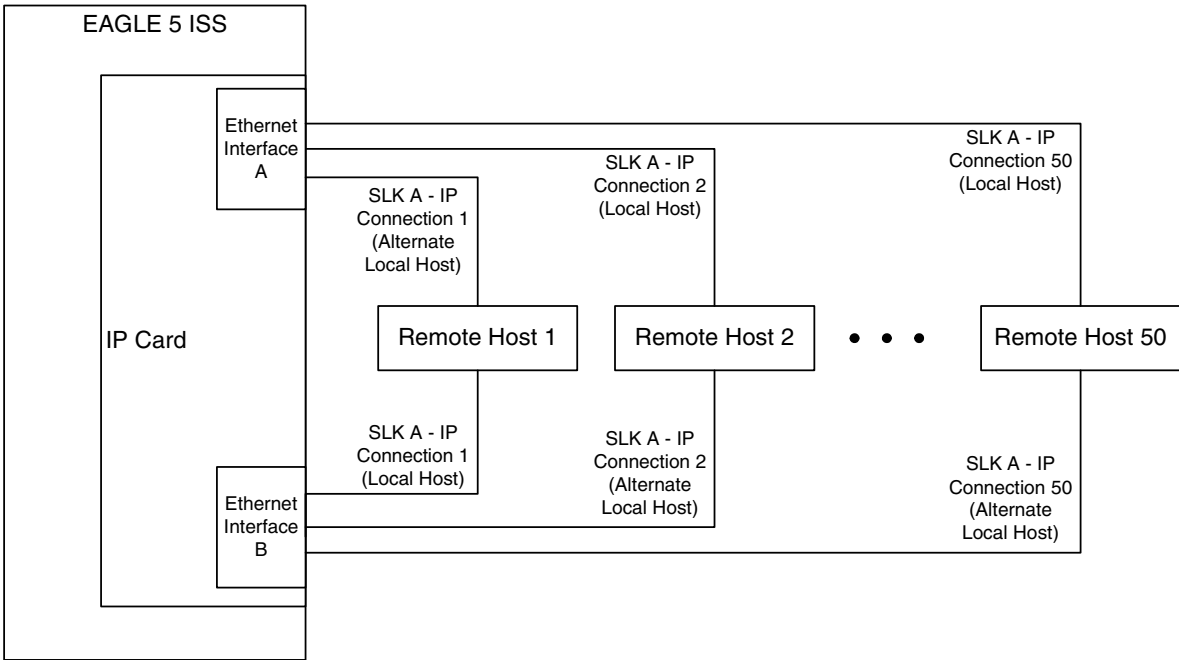
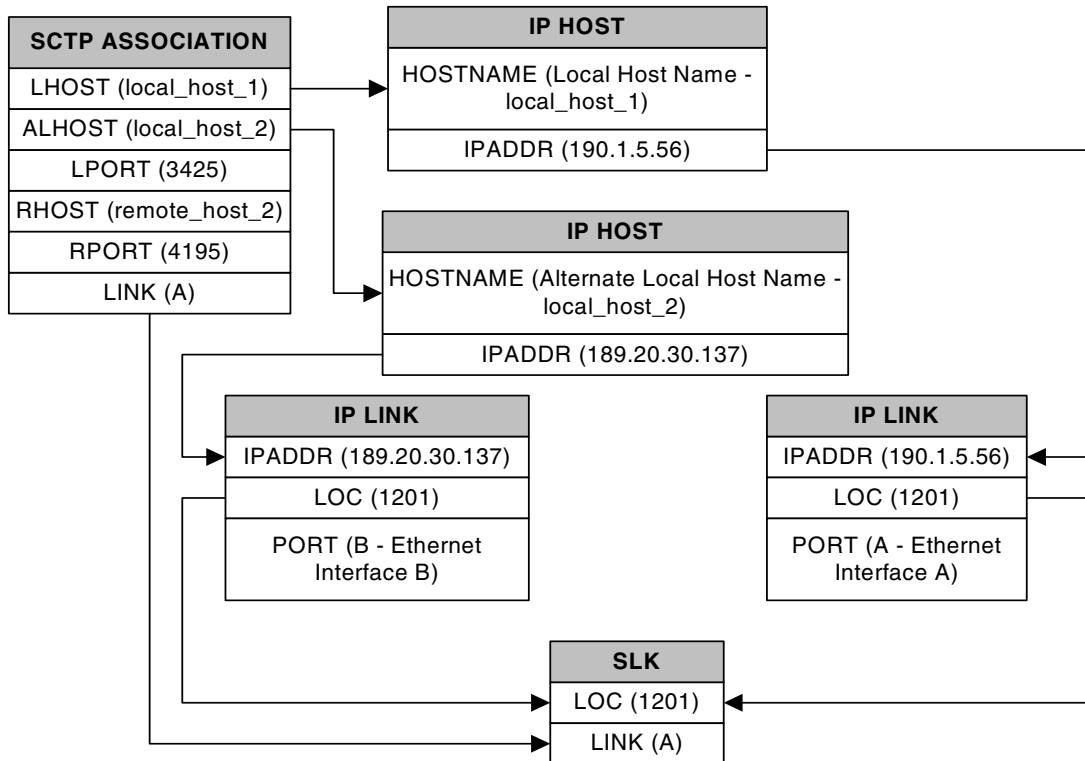

Figure 2-11 shows the components of the multi-homed SCTP association and how these components interact with each other.

Figure 2-11. Multi-Homed Association Database Relationships



Using the data shown in Figure 2-11, the IP connection is defined as a multi-homed association, connecting to a remote host using local hosts 190.1.5.56 and 189.20.30.137 over Sctp port 3425, using signaling link B on card 1201.

Routing

The IP⁷ Secure Gateway functionality in the EAGLE 5 ISS support two transport protocols – TCP and SCTP. Although both transport protocols are connection oriented, they differ greatly with respect to operation in a multi-homed host environment. The TCP protocol provides for a point-to-point transport connection. The SCTP protocol implements connections with either point to point, point to multi-point, or multi-point to multi-point connectivity capabilities.

A TCP socket connection is defined by an explicit four-tuple – a local IP address, local TCP port, remote IP address and remote TCP port. Once the local IP address is determined for a TCP connection, it binds all subsequent transmissions to this specific IP interface. Once an IP interface is selected for a TCP connection, the TCP connection will fail if the remote host becomes unreachable by this interface. This connection failure occurs on a multi-homed host even if the remote host can still be reached by a different IP interfaces of the multi-homed host.

An SCTP IETF connection – association – has a broader definition than TCP with respect to a multi-homed host. An SCTP IETF association is defined as a four-tuple as follows:

- local host list – one or more of the local host's IP interface addresses
- local SCTP port
- remote host list – one or more of the remote host's IP interface addresses
- remote SCTP port.

Based on this definition for an SCTP IETF connection, and the fact that the IPGWx and IPLIMx applications may utilize both Ethernet interfaces (a multi-homed host), an SCTP IETF association can take advantage of multi-homing and be a multi-homed SCTP endpoint. As a multi-homed endpoint, an SCTP IETF connection remains active and usable as long as at least one of the Ethernet interfaces can be reached by the remote host. Multiple paths through multiple interfaces to the remote host provides a more reliable connection. Thus where a TCP connection would be lost, and if possible, a new one established by the application, the SCTP IETF protocol is designed to make such a network outage transparent to the application.

In previous releases, an SCTP IETF endpoint could only operate as a uni-homed host using only the Ethernet A interface. In this mode, any SCTP transmission received on or transmitted out of the Ethernet B interface are silently discarded. By using the Ethernet B interface, the SCTP protocol running on the IP card can provide SCTP multi-homing endpoint support – that is, when an SCTP IETF association is formed, it may list both the Ethernet A and B IP addresses for the respective interfaces. As a multi-homed association endpoint, SCTP data would be allowed to flow on either of the Ethernet interfaces and thus provide more robust network connectivity.

In order to provide more flexible network connectivity, an association can be configured as follows with respect to the Ethernet interfaces:

- Ethernet A interface only (uni-homed)
- Ethernet B interface only (uni-homed)
- Ethernet A and B interface (multi-homed).

The interface mode is specified by the **lhost** and **alhost** parameters of the **ent-assoc** or **chg-assoc** commands.

In previous releases, the **lhost** parameter of the **ent-assoc** or **chg-assoc** commands is used to define the local IP address of the SCTP IETF association endpoint. The IP address would have to be an IP address associated with an Ethernet A interface. With this release, the IP address may be associated with either the Ethernet A or B interfaces. If it is an Ethernet A interface IP address, and the **alhost** parameter is not specified, then the association operates as a uni-homed SCTP endpoint on Ethernet interface A. If it is an Ethernet B interface IP address, and the **alhost** parameter is not specified, then the association operates as a uni-homed SCTP endpoint on Ethernet interface B. An association is configured as an SCTP multi-homed endpoint by specifying both the **lhost** and **alhost** parameter values with values corresponding to the Ethernet interface IP address for the IP card. The **lhost** and **alhost** parameter values represent the IP addresses specified by the **chg-ip-lnk** command for the specific IP card. Traffic cannot be passed between the Ethernet interfaces on the IP card containing a multi-homed SCTP association. The IP card cannot act as an IP router between the networks defined by the local host and alternate local hosts of a multi-homed association.

A host that is not on the local network, the network identified by the local host's IP address, can be reached only through a gateway router. A gateway router is a device with more than one physical network connection, and can be connected to multiple networks. Unlike a multi-homed host, a gateway router is permitted to route IP messages between the physical Ethernet interfaces on the IP card. The network portion of the gateway router's IP address must be the same as the network portion of the IP address of one of the IP addresses of the Ethernet interfaces on the IP card. The gateway router is configured using the **defrouter** of the **chg-ip-card** command, or using the **ent-ip-rte** command.

Static entries are added to the IP Routing table using the **ent-ip-rte** command. Static routes are usually assigned to give control over which routers are used, allowing different routers to be selected based upon the destination IP address. There are two types of static routes:

- host static IP routes
- network or subnetwork static IP routes.

The default route entry is a special static route. If there is not a specific host or network address in the IP Routing table that matches the destination IP address of an outbound datagram, then the datagram is sent to the default router (gateway) specified by the default route.

An IP route is configured using the `ent-ip-rte` command with the location of the IP card, the IP address of the gateway router (the `gtwy` parameter), and the IP address and subnet mask of the destination (that is, host or network). The IP address of the gateway router must be a locally attached IP address (that is, the gateway IP address must share the network portion of one of the two Ethernet interfaces).

When an IP packet is to be transmitted the IP routing table must be interrogated to determine where to send the IP datagram. If the destination IP address is local to the node (that is, directly reachable by an Ethernet interface), then the IP datagram is transmitted directly to the node with that associated IP address. If the destination IP address is determined to not be local to the node, then it must be routed (that is, sent to a gateway to reach its destination).

IP routing requires accessing the IP routing table to select a route. The destination IP address of the outbound datagram is used to search the IP routing table for the most specific route match. The order for selection is:

1. Host route
2. Subnetwork route
3. Network route
4. Aggregated route
5. Default route.

Based on this selection order if an IP route is found then the outbound IP datagram will be transmitted to the gateway specified by the route. If no IP route is found (where no default route is specified), then the transmission of the datagram fails due to destination unreachable.

The capability to enter static IP routes provides for flexibility and control with respect to controlling network traffic. An IP card can contain up to 64 IP routes. The EAGLE 5 ISS can contain up to 1024 IP routes.

Point-to-Point Connectivity (IPLIM or IPLIMI Application)

The following sections describe the types of point-to-point connectivity provided, and how routing is accomplished, by the `iplim` or `iplimi` application:

Connecting STPs Over the IP Network

This functionality allows the use of an IP network in place of point-to-point SS7 links to carry SS7 MSUs. Figure 2-12 shows a diagram of this type of network. For example, the C links between the mated pair of STPs or A/B/D links between STPs can be replaced by an IP network. The IP⁷ Secure Gateway functionality is deployed on both ends of the link (point-to-point connection). The EAGLE 5 ISS converts the SS7 MSUs to IP packets on one end of the link, and IP packets to SS7 MSUs on the other end of the link. The IPLIMx applications supports the TALI/TCP/IP sockets over B, C, and D links and M2PA/SCTP/IP associations over A, B, C, D, and E links.

Figure 2-12. EAGLE 5 ISS Network (STP Connectivity via MTP-over-IP)

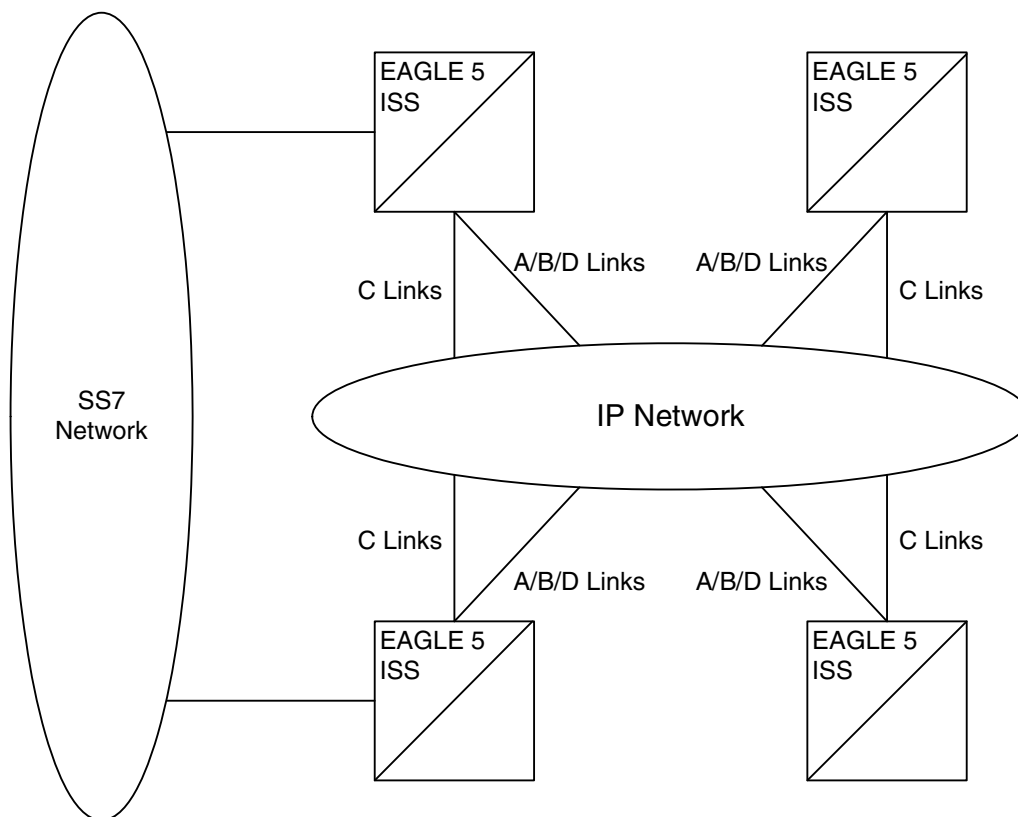

Point-to-Multipoint Connectivity (SS7IPGW and IPGWI)

The following sections describe the types of point-to-multipoint connectivity, how routing is accomplished, and the MTP status functions provided by the `ss7ipgw` and `ipgwi` applications:

- “Connecting to SCPs with SCCP/TCAP Messages Sent Over the IP Network” on page 2-22
- “Connecting SEPs Using ISUP, Q.BICC, and TUP Messages Over the IP Network” on page 2-23
- “Connecting SCPs and SEPs Using Non-ISUP, Non-SCCP, Non-Q.BICC, and Non-TUP Messages Over the IP Network” on page 2-24
- “Understanding Routing for SS7IPGW and IPGWI Applications” on page 2-25
- “Support for MTP Status Functions” on page 2-30

Connecting to SCPs with SCCP/TCAP Messages Sent Over the IP Network

This functionality allows SS7 nodes to exchange SCCP/TCAP queries and responses with an SCP residing on an IP network. Figure 2-13 shows a diagram of this type of network.

Figure 2-13. IP Network (SCP Connectivity via TCAP-over-IP)

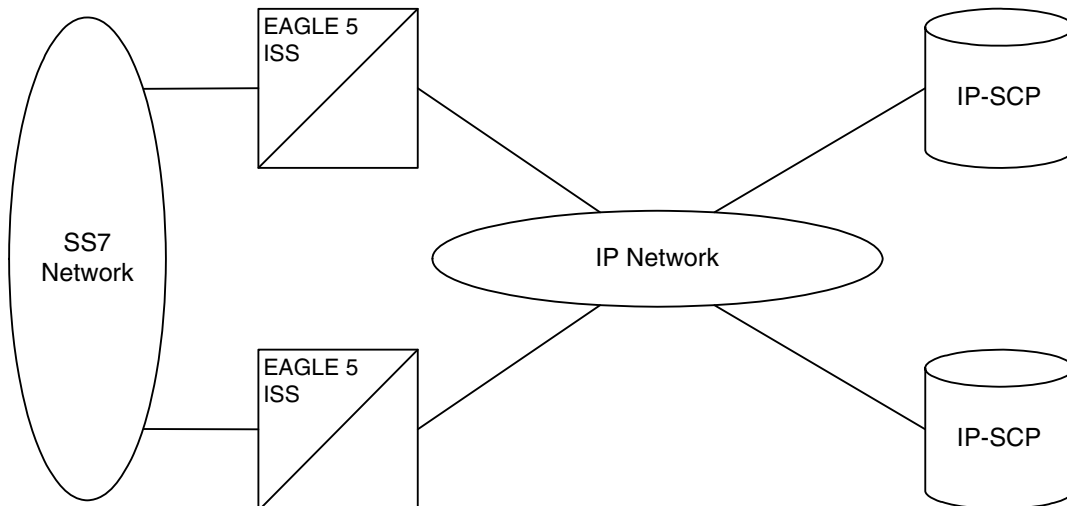

The EAGLE 5 ISS manages the virtual point codes and subsystem numbers for the IP-SCP. From the SS7 network perspective, the TCAP queries are routed using these virtual point codes/SSNs. The EAGLE 5 ISS maps the virtual point code/SSN to one or more TCP sessions (point-to-multipoint connection), converts the SS7 MSUs to IP packets by embedding the SCCP/TCAP data inside IP packets, and routes them over an IP network. The EAGLE 5 ISS also manages application subsystem status from an IP network's perspective and an SS7 network's perspective.

The following sequence of events illustrates this functionality:

1. Traditional SS7 devices route MSUs (such as TCAP Queries) to the EAGLE 5 ISS.
2. The EAGLE 5 ISS performs a global title translation and forwards the translated MSU to the correct IP device based on Point Code and SCCP Subsystem information in the MSU.
3. The TCAP query is processed at the IP-SCP, and the IP-SCP sends a TCAP reply back to the EAGLE 5 ISS.
4. The EAGLE 5 ISS forwards the TCAP reply back to the sender of the original query.

Connecting SEPs Using ISUP, Q.BICC, and TUP Messages Over the IP Network

This point-to-multipoint functionality allows SS7 nodes to exchange ISUP, Q.BICC, and TUP protocol messages with one or more signaling end points (class 4 switches, class 5 switches, VoIP gateways, Media Gateway Controllers, or Remote Access Servers) residing on an IP network. Figure 2-14 shows an example of this type of network.

Figure 2-14. IP Network (SEP connectivity via ISUP, Q.BICC, and TUP-over-IP)

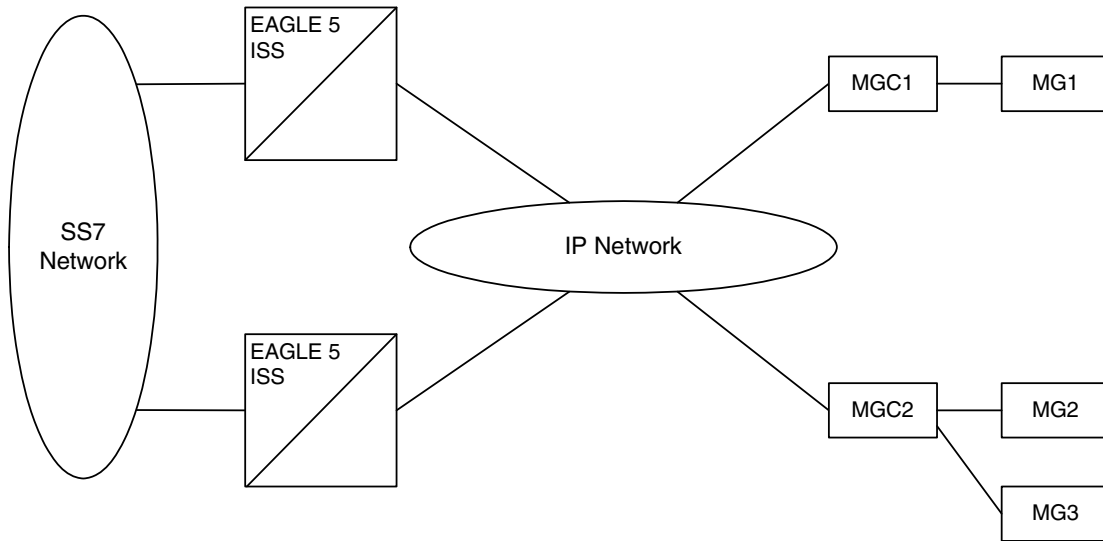

The EAGLE 5 ISS maps the originating point code, destination point code, and circuit identification code to an IP connection. The SEP is provided the originating and destination point codes in the MTP level 3 routing label as part of the passed protocol.

Connecting SCPs and SEPs Using Non-ISUP, Non-SCCP, Non-Q.BICC, and Non-TUP Messages Over the IP Network

This point-to-multipoint functionality allows SS7 nodes to exchange non-ISUP, non-SCCP, non-Q.BICC, and non-TUP protocol messages with one or more IP-based devices residing on an IP network. The network example is similar to the SCP connectivity via SCCP/TCAP-over-IP functionality example shown in Figure 2-13. The EAGLE 5 ISS maps the destination point code, and service indicator (non-ISUP, non-SCCP, non-Q.BICC, non-TUP) to an IP connection.

Understanding Routing for SS7IPGW and IPGWI Applications

The `ss7ipgw` and `ipgwi` applications can use a single point code, called a virtual point code. This code is assigned to a set of IP devices that it connects to. The EAGLE 5 ISS distinguishes between the devices within the set by using application routing keys and application sockets or application servers.

Application routing associates SS7 routing keys with sockets or application servers. SS7 routing keys define a filter based on SS7 message data. Application sockets or application servers define the connection between the IP local host/local transport protocol port and IP remote host/remote transport protocol port.

An application server is a logical entity serving a specific routing key. The application server contains a set of one or more unique application server processes, of which one or more is normally actively processing traffic. An application server process is a process instance of an application server and contains an SCTP association. For more information on application servers, application server processes, and SCTP associations, see the IETF Adapter Layer Support section on page 2-48.

If the routing key filter matches the SS7 message presented for routing to the IP network, the SS7 message is sent to the associated application socket or application server.

There may be up to 16 application sockets or one application server associated with each SS7 routing key. One application server can have up to 16 associations. SS7 messages delivered to the IP network using a routing key are distributed over the available application sockets or application server based on the SLS (signaling link selector) value in the SS7 message.

Routing keys can be fully or partially specified, or specified by default.

Full Routing Keys

For this routing application, all applicable fields in the Message Signaling Unit (MSU) must match the contents of the full routing key. Table 2-3 defines which SS7 message parameters are used to search for a match for full routing keys for each of the functions supported by the `ss7ipgw` and `ipgwi` applications (IPGWx functionality).

Table 2-3. SS7 Full Routing Keys per IPGWx Functionality

| IPGWx Functionality (ANSI and ITU) | SS7 Routing Keys |
|---|---|
| SCP connectivity via TCAP-over-IP | Destination Point Code Service Indicator (=3) Subsystem Number |
| SEP connectivity via ISUP-over-IP | Destination Point Code Service Indicator (=5) Originating Point Code CIC Range Start CIC Range End |
| SEP connectivity via Q.BICC-over-IP | Destination Point Code Service Indicator (=13) Originating Point Code CIC Range Start CIC Range End |
| SEP connectivity via TUP-over-IP (ITU only) | Destination Point Code Service Indicator (=4) Originating Point Code CIC Range Start CIC Range End |
| SCP/SEP connectivity via non-ISUP, non-SCCP, non-Q.BICC, non-TUP-over-IP | Destination Point Code Service Indicator (any value other than 3, 4*, 5, and 13) |
| * The service indicator value of 4 can be used in this instance if the DPC is an ANSI point code. | |

Partial Routing Keys

Partially specified routing keys are explicitly, but not completely defined. These routing keys ignore some of the contents of the MSU. The parts of the MSU that are ignored are specific. For example, for the 'ignore `cic`' partial-key type, the destination point code (`dpc`), service indicator (`si`), and originating point code (`opc`) must be configured, but the circuit identification code (`cic`) field does not have to be configured. The other types of SS7 partial routing keys are as follows:

- `dpc`, `si`, and `opc` specified (ignore `cic` for CIC-based messages)
- `dpc` and `si` specified (ignore `ssn` for `sccp` messages)
- `dpc` and `si` specified (ignore `opc` and `cic` for CIC-based messages)
- `dpc` specified (ignore all but the `dpc` field)
- `si` specified (ignore all but the `si` field)

Default Routing Keys

Default routing keys do not need any part of the MSU specified. This routing key can be used to carry any SS7 MSU, regardless of the type of MSU or the fields that make up the MSU. The EAGLE 5 ISS can support two default routing keys, one created by administrative commands and one entered by Dynamic Routing Key Registration.

Routing Key Tables

Each IP card has a Routing Key table that maps SS7 routing keys to IP connections, as illustrated by the example in Table 2-4. MSUs that match the parameters in a given row are sent over one of the IP connections shown for that row (up to 16 IP connections can be defined for a single routing key). Multiple IP connections for a given row allow load sharing. In addition, multiple routing keys can be used to send traffic to a single IP connection.

Each IP card's Routing Key table can contain up to 1000 entries (if there are any dual-slot DCM cards) or 2500 entries (if all IP cards are SSED CM cards). Entries in the Routing Key table can be either of the following:

- **Static** — these entries are defined by the user using the `ent-appl-rtkey` command entered through the OAM, saved on disk, and reloaded to each IP card upon reset. Static entries can be full, partial, or default routing keys. The static entries in one IP card's Routing Key table are identical to the static entries in the other IP card's table. Static entries can be changed by the `chg-appl-rtkey` command or deleted by the `dlr-appl-rtkey` command.
- **Dynamic** — these entries are added to or deleted from the table when a remote computer sends a message to the EAGLE 5 ISS. Dynamic entries allow an IP connection to automatically direct traffic towards, or away from, itself. A dynamic entry can have the same parameters as a static entry and can be full, partial, or default routing keys. When the `ss7ipgw` or `ipgwi` application transmits an MSU, it looks for a matching dynamic entry before looking for a

static entry. When an IP connection fails, all dynamic entries associated with the IP connection are deleted. The dynamic entries in one IP card's Routing Key table may differ from the other IP card's table depending on messages received from other IP nodes. Dynamic entries can be deleted by receipt of a message from the IP connection, by failure of the IP connection, or by the `dlt-appl-rtkey` command.

NOTE: Dynamic routing keys are not created from MSUs containing ITU international or 14-bit ITU national spare point codes.

Table 2-4 shows a sample Routing Key table that has one static entry and one dynamic entry for an SSCP/TCAP-over-IP connection; one static entry each for an ISUP, Q.BICC, and TUP-over-IP connection; and a non-SCCP/non-ISUP/non-Q.BICC/non-TUP connection.

Table 2-4. Example SS7 Routing Key Table

| Location | SS7 Routing Keys | | | | | | IP Sockets that carry traffic for that Routing Key |
|--|------------------|--------|---------|---------|-----------|---------|--|
| | SS7 DPC | SS7 SI | SS7 SSN | SS7 OPC | CIC START | CIC END | Socket Name |
| DPC-SI-SSN routing key for SSCP/TCAP-over-IP connectivity | | | | | | | |
| Static | 5-5-5 | 03 | 6 | - | - | - | kchlr11201 kchlr21201 kchlr11203 kchlr21203 |
| 1105 | 5-5-5 | 03 | 6 | - | - | - | kchlr31205 kchlr41205 |
| ISUP-CIC routing key for ISUP-over-IP connectivity | | | | | | | |
| Static | 5-5-6 | 05 | - | 4-4-4 | 1 | 100 | dnmsc11201 dnmsc21201 dnmsc11203 dnmsc21203 |
| Q.BICC-CIC routing key for Q.BICC-over-IP connectivity | | | | | | | |
| Static | 4363 | 13 | - | 5834 | 48486 | 48486 | lpmsg11204 lpmsg21204 lpmsg31204 |
| TUP-CIC routing key for TUP-over-IP connectivity | | | | | | | |
| Static | 1-44-2 | 04 | - | 2-5-1 | 3948 | 3948 | lpmsg11205 lpmsg21205 lpmsg31205 |
| DPC-SI routing key for non-SCCP/non-ISUP/non-Q.BICC/non-TUP connectivity | | | | | | | |
| Static | 5-5-7 | 02 | | | | | sfh1r11204 |

Routing Key Lookup Hierarchy

To facilitate the delivery of Message Signaling Units (MSUs) that do not match full routing key entries in the Routing Key table, each MSU is processed and delivered according to a specific routing key lookup hierarchy. The hierarchy guarantees that the MSU is delivered to the best possible location based on the MSU's closest match in the Routing Key table, and also prevents MSUs without full routing key matches from being discarded. Table 2-5 defines the routing key lookup hierarchy.

Table 2-5. Routing Key Lookup Hierarchy

| Type of MSU | Lookup Order per MSU Type | Segment of MSU that Must Match Routing Key | Routing Key Type |
|-------------|---------------------------|--|------------------|
| CIC | 1 | dpc + si + opc + cic | Full |
| | 2 | dpc + si + opc (ignore cic) | Partial |
| | 3 | dpc + si (ignore opc & cic) | Partial |
| | 4 | dpc (ignore si, opc & cic) | Partial |
| | 5 | si (ignore dpc, opc & cic) | Partial |
| | 6 | None | Default |
| SCCP | 1 | dpc + si + ssn | Full |
| | 2 | dpc + si (ignore ssn) | Partial |
| | 3 | dpc (ignore si & ssn) | Partial |
| | 4 | si (ignore dpc & ssn) | Partial |
| | 5 | None | Default |
| OtherSI | 1 | dpc + si | Full |
| | 2 | dpc (ignore si) | Partial |
| | 2 | si (ignore dpc) | Partial |
| | 3 | None | Default |

When an MSU has an **si** value of 5, 13, or 4 (ITU only), it is a CIC message. Messages with an **si** value of 3 are SCCP messages. All other MSUs are considered OtherSI messages. The EAGLE 5 ISS first tries to match each MSU with a full routing key and second with one of the partial keys as numbered in ascending order in the table. Third, if no segment of the routing key matches either full or partial routing keys, the EAGLE 5 ISS assigns the MSU a default routing key.

Support for MTP Status Functions

This feature, available only on IP cards that support the `ss7ipgw` and `ipgwi` applications, allows the Message Transfer Part (MTP) status of point codes in the SS7 networks to be made available to IP-connected media gateway controllers (MGCs) and IP-SCPs. This feature is similar to the MTP3 network management procedures used in an SS7 network.

This feature enables an IP device to:

- Divert traffic from a secure gateway that is not able to access a point code that the mated secure gateway can access
- Audit point code status
- Build up routing tables before sending traffic
- Be warned about network congestion
- Abate congestion (`ss7ipgw` application only)
- Obtain SS7 User Part Unavailability status

SNMP Agent Implementation

This feature implements a Simple Network Management Protocol (SNMP) agent on each IP card that runs the `ss7ipgw`, `ipgwi`, `iplim`, or `iplimi` applications. SNMP is an industry-wide standard protocol used for network management. SNMP agents interact with network management applications called Network Management Systems (NMSs).

Supported Managed Object Groups

The SNMP agent maintains data variables that represent aspects of the IP card. These variables are called managed objects and are stored in a management information base (MIB). The SNMP protocol arranges managed objects into groups. Table 2-6 on page 2-31 shows the groups that are supported.

Table 2-6. SNMP Object Groups

| Group Name | Description | Contents |
|-------------------|--|---|
| <i>system</i> | Text description of agent in printable ASCII characters | System description, object identifier, length of time since reinitialization of agent, other administrative details |
| <i>interfaces</i> | Information about hardware interfaces on the IP card | Table that contains for each interface, speed, physical address, current operational status, and packet statistics |
| <i>ip</i> | Information about host and router use of the IP | Scalar objects that provide IP-related datagram statistics, and 3 tables: address table, IP-to-physical address translation table, and IP-forwarding table |
| <i>icmp</i> | Intranetwork control messages, representing various ICMP operations within the IP card | 26 scalar objects that maintain statistics for various Internet Control Message Protocol (ICMP) messages |
| <i>tcp</i> | Information about TCP operation and connections | 14 scalar objects that record TCP parameters and statistics, such as the number of TCP connections supported and the total number of TCP segments transmitted, and a table that contains information about individual TCP connections |
| <i>udp</i> | Information about UDP operation | 4 scalar objects that maintain UDP-related datagram statistics, and a table that contains address and port information |
| <i>snmp</i> | Details about SNMP objects | 30 scalar objects, including SNMP message statistics, number of MIB objects retrieved, and number of SNMP traps sent |

Supported SNMP Messages

The SNMP agent interacts with up to two NMSs by:

- Responding to *Get* and *GetNext* commands sent from an NMS for monitoring the IP card.
- Responding to *Set* commands sent from an NMS for maintaining the IP card and changing managed objects as specified.
- Sending *Trap* messages to asynchronously notify an NMS of conditions such as a link going up or down. *Traps* provide a way to alert the NMS in a more

timely fashion than waiting for a *Get* or *GetNext* from the NMS. Two hostnames, DCMSNMPTRAPHOST1 and DCMSNMPTRAPHOST2, are utilized to specify the SNMP NMS to which traps are sent. In this release, only the following traps are supported:

- *coldStart*, sent one time only when the IP stack initialization occurs on the IP card as part of boot processing
- *linkUp*, sent when one of the ports on the IP card initially comes up or recovers from a previous failure
- *linkDown*, sent when one of the ports on the IP card fails

When a trap occurs at the IP card agent, the agent sends the trap to each of the SNMP specific host names that can be resolved to an IP address. Resolution is based on configuration data in the **chg-ip-card** command (or default data) which specifies DNS search order and DNS information.

Deviations from SNMP Protocol

Table 2-7 on page 2-33 shows how the EAGLE 5 ISS deviates from the standard SNMP protocol definition.

Table 2-7. Deviations from SNMP Protocols

| Group | Variable Name | Usage | Deviation |
|------------------|---|--|--|
| <i>system</i> | <i>sysContact</i> | Text identification of contact information for agent | Cannot be set by <i>Set</i> command; may be set only by chg-sg-opts command. |
| | <i>sysLocation</i> | Physical location of agent | Cannot be set by <i>Set</i> command; internally set using configuration data already available; set to <CLLI>-<slot of IP card> |
| | <i>sysName</i> | Administratively assigned name for agent | Cannot be set by <i>Set</i> command; internally set using configuration data already available; set to <CLLI>-<slot of IP card> |
| <i>interface</i> | <i>ifAdminStatus</i> | Desired state of the interface | Cannot be set by <i>Set</i> command (to ensure that an NMS does not disrupt SS7 traffic by placing an IP interface in a nonoperable state) |
| <i>ip</i> | <i>ipForwarding</i> <i>ipDefaultTTL</i> <i>ipRoute Dest</i> <i>ipRouteIfIndex</i> <i>ipRouteMetric1-5</i> <i>ipRouteNextHop</i> <i>ipRouteType</i> <i>iprouteAge</i> <i>ipRouteMask</i> | IP route-specific values | Cannot be set by <i>Set</i> command |
| | <i>ipNetToMediaIfIndex</i> <i>ipNetToMediaPhysAdress</i> <i>ipNetToMediaNetAddress</i> <i>ipNetToMediaType</i> | IP-address specific information | Can be set by <i>Set</i> command, but not saved across IP card reloads |
| <i>tcp</i> | <i>tcpConnState</i> | State of a TCP connection | Cannot be set by <i>Set</i> command |
| <i>snmp</i> | <i>snmpEnableAuthenTraps</i> | Indicate whether agent is permitted to generate authentication failure traps | Cannot be set by <i>Set</i> command |

Mixed Networks Using the ANSI/ITU MTP Gateway Feature

The optional ANSI/ITU MTP Gateway feature, now also available for IP networks, and the addition of the `iplimi` and `ipgwi` applications enables the EAGLE 5 ISS to act as an interface between nodes that support ANSI, ITU-I, and ITU-N protocols. For more information on the ANSI/ITU MTP Gateway feature, contact your Tekelec Sales Representative.

Figure 2-15 on page 2-35 shows an example of a complex network that includes all these types of nodes. Table 2-8 on page 2-36 provides more detail about the nodes, network types, and point codes used in this example.

The following SS7 protocol constraints determine how the network must be configured:

- A linkset is a group of links that terminate into the same adjacent point code. All links in the linkset can transport compatible MSU formats. The network type of the linkset is the same as the network type of the adjacent point code assigned to the linkset.
- When nodes in different networks need to communicate, each node must have either a true point code or an alias point code for each of the network types. For example, if Node 1 (in an ANSI network) needs to communicate to Node 7 (in an ITU-N network), Node 1 must have an ANSI true point code and an ITU-N alias point code, while Node 7 must have an ITU-N true point code and an ANSI alias point code.
- The systems are usually deployed as mated pairs. The links connecting the EAGLE 5 ISS to its mate are C links. Each EAGLE 5 ISS must have a C linkset for each network type that the EAGLE 5 ISS connects to. Therefore, in Figure 2-15 on page 2-35, Nodes 5 and 6 are connected with three linksets, one each for ANSI traffic, ITU-I traffic, and ITU-N traffic.
- To perform routing, the EAGLE 5 ISS must convert the routing labels in MSUs. To perform this conversion, every destination point code (DPC), originating point code (OPC), and concerned point code must be defined in the Routing table. Even if the EAGLE 5 ISS does not route MSUs to these nodes, they must be provisioned in the Routing table to provision the alias point codes required in the conversion process.

Figure 2-15. Complex Network with ANSI, ITU-I, and ITU-N Nodes

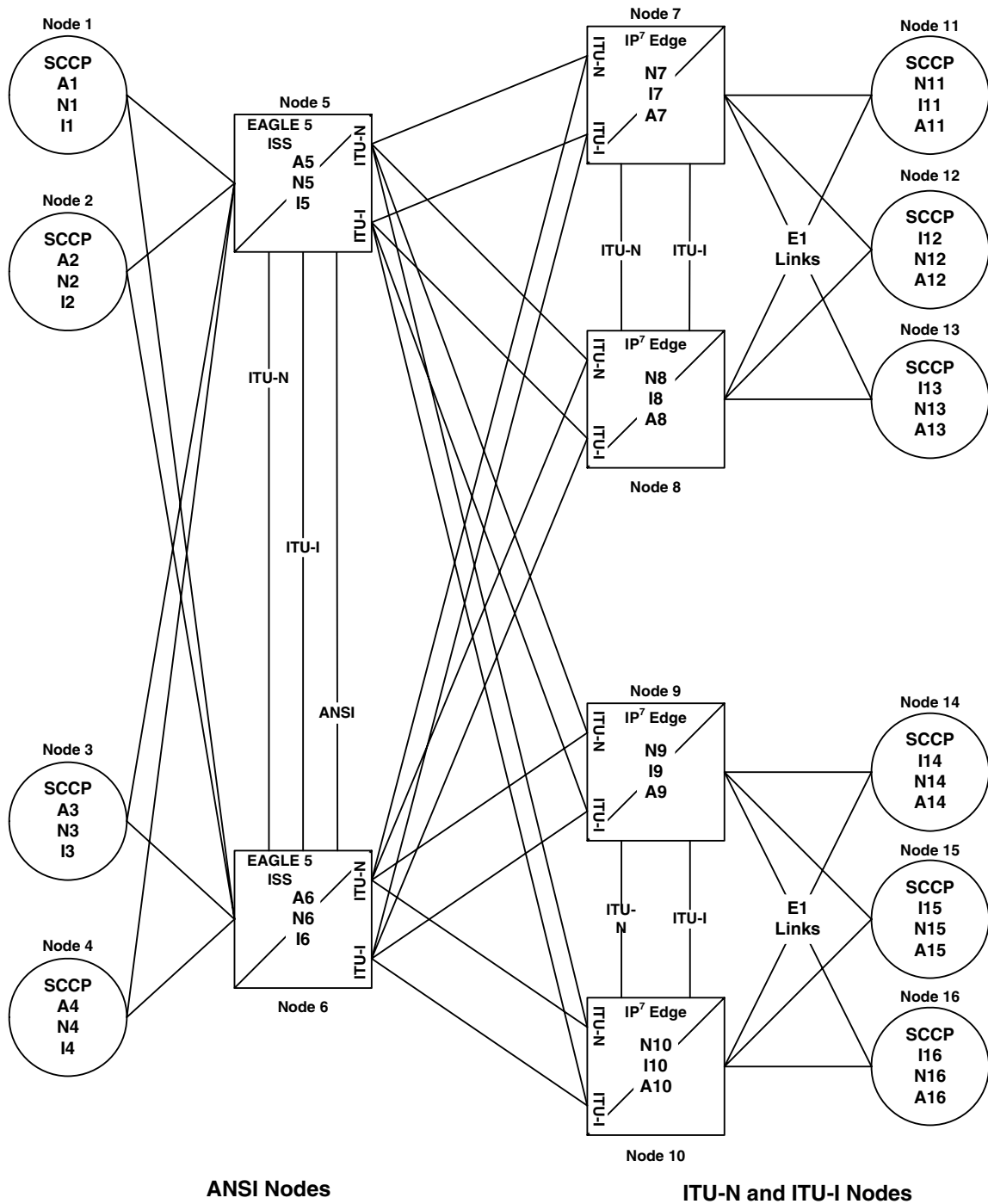

Table 2-8. Nodes and Point Codes in Complex Network Example

| Node | Node Type | Network Types Supported | True Point Codes ¹ | Alias Point Codes ² |
|------|---|-------------------------|-------------------------------|--------------------------------|
| 1 | SSP | ANSI | A1 | N1, I1 |
| 2 | SSP | ANSI | A2 | I2 |
| 3 | SSP | ANSI | A3 | N3, I3 |
| 4 | SSP | ANSI | A4 | N4 |
| 5 | STP (with IP ⁷ Secure Gateway functionality) | ANSI, ITU-N, ITU-I | A5, N5, I5 | |
| 6 | STP (with IP ⁷ Secure Gateway functionality) | ANSI, ITU-N, ITU-I | A6, N6, I6 | |
| 7 | STP (with IP ⁷ Secure Gateway functionality) | ITU-N, ITU-I | N7, I7 | A7 |
| 8 | STP (with IP ⁷ Secure Gateway functionality) | ITU-N, ITU-I | N8, I8 | A8 |
| 9 | STP (with IP ⁷ Secure Gateway functionality) | ITU-N, ITU-I | N9, I9 | A9 |
| 10 | STP (with IP ⁷ Secure Gateway functionality) | ITU-N, ITU-I | N10, I10 | A10 |
| 11 | SSP | ITU-N | N11 | I11, A11 |
| 12 | SSP | ITU-I | I12 | N12, A12 |
| 13 | SSP | ITU-I | I13 | N13, A13 |
| 14 | SSP | ITU-N | N14 | I14, A14 |
| 15 | SSP | ITU-I | I15 | N15, A15 |
| 16 | SSP | ITU-I | I16 | N16, A16 |

Notes:

1. A true point code (TPC) defines a destination in the EAGLE 5 ISS's destination point code table. A TPC is a unique identifier of a node in a network. An STP (with IP⁷ Secure Gateway functionality) must have a TPC for each network type that the EAGLE 5 ISS connects to. An SSP connects to only one type of network, so it has only one TPC.
2. An alias point code is used to allow nodes in other networks to send traffic to and from a EAGLE 5 ISS when that EAGLE 5 ISS does not have a TPC for the same network type.

The configured links and point codes in the complex network shown in Figure 2-15 on page 2-35 allows most nodes to communicate with other nodes. However, note that Node 2 cannot communicate with Node 13 or Node 16, or with any node in the ITU-N network because Node 2 does not have an ITU-N alias point code.

Routing and Conversion Within a Single Network Type

The following steps demonstrate how an EAGLE 5 ISS routes and converts when an ITU-N node sends an MSU to another ITU-N node. For example, assume that Node 11 in Figure 2-15 on page 2-35 sends an MSU to Node 14. The MSU is routed from Node 11 to Node 7 to Node 5 to Node 9 to Node 14. The following steps describe the actions performed at Node 5 (an STP with IP⁷ Secure Gateway functionality):

1. An ITU-N formatted MSU (which has a network identifier=01b and a 14-bit destination point code/originating point code) is received on an `iplimi` card (for this example at location 1103).
2. MSU discrimination is performed with the following substeps:
 - a. Compare the received network identifier (NI) to the list of valid NIs. (Each configured linkset for a receiving link has a defined list of valid NIs.) If the comparison fails, the MSU is discarded and an STP measurement is logged. In this example, the received NI (01b) is valid for an `iplimi` card.
 - b. Extract the NI and destination point code (DPC) from the received MSU.
 - c. Determine whether the destination of the received MSU is this STP. If not (as is the case in this example), the MSU is passed to the STP's routing function.
3. The routing function selects which outgoing link to use by searching a routing table for an entry for the DPC (N14 in this example). The routing table identifies another `iplimi` card (for this example at location 1107) to be used for the outgoing link.
4. Determine whether MSU conversion is required (required when the source network type is not the same as the destination network type). In this example, both Node 11 and Node 14 are ITU-N nodes, so conversion is not required.
5. Forward the MSU across the Interprocessor Message Transport (IMT) bus from location 1103 to location 1107, where the MSU is transmitted out the link towards Node 14.

Routing and Conversion Between Different Network Types

The routing and conversion steps performed by a EAGLE 5 ISS when an ITU-N node sends an MSU to an ITU-I node are the same as the steps shown in “Routing and Conversion Within a Single Network Type” on page 2-37, except for the conversion step.

For example, assume that Node 11 in Figure 2-15 sends an MSU to Node 16. The MSU is routed from Node 11 to Node 7 to Node 5 to Node 9 to Node 16. The following steps describe the actions performed at Node 5 (an EAGLE 5 ISS with IP⁷ Secure Gateway functionality):

1. Perform step 1 through step 3 as shown in “Routing and Conversion Within a Single Network Type” on page 2-37. In this example, assume that the routing function determines that the outgoing link is configured on the IP card at location 1203.
2. Determine whether MSU conversion is required (required when the source network type is not the same as the destination network type). In this example, Node 11 is an ITU-N node and Node 16 is an ITU-I node, so conversion is required. Conversion consists of two phases: Message Transfer Part (MTP) conversion and user part conversion.
3. Perform MTP conversion (also known as routing label conversion). The following parts of the MSU can be affected by MTP conversion:
 - Length indicator — for ITU-N to ITU-I conversion, the length of the MSU does not change
 - Service Information Octet (SIO), Priority — for conversion to ITU, the priority is set to 0. For conversion to ANSI, the priority is set to a default of 0, which can later be changed based on user part conversion.
 - Service Information Octet (SIO), Network Indicator — the NI bits are set to the NI value for the destination node. In this example, NI is set to 00b.
 - Routing Label, Destination Point Code (DPC) — the DPC is replaced with the destination’s true point code. In this example, N16 is replaced by I16.
 - Routing Label, Originating Point Code (OPC) — the OPC is replaced with the appropriate network type’s alias point code for the originating node. In this example, N11 is replaced with I11.
 - Routing Label, Signaling Link Selector (SLS) — no SLS conversion is required between ITU-I and ITU-N nodes. However, if one of the nodes were an ANSI node, conversion would be required between a 5-bit or 8-bit SLS for ANSI nodes and a 4-bit SLS for ITU nodes.

4. Perform user part conversion, if necessary. Currently, only SCCP traffic and only network management messages have the Message Transfer Part (MTP) converted. All other user parts have their data passed through unchanged.
5. Forward the MSU across the Interprocessor Message Transport (IMT) bus from location 1103 to location 1203, where the MSU is transmitted out the link towards Node 16.

Nagle's Algorithm

Nagle's Algorithm is a 1-bit, Boolean socket option that controls message packet transmission timing. Nagle's Algorithm applies only to TALI sockets. Sockets can be set to 1 = Enable or 0 = Disable. Nagle's Algorithm is disabled by default for all sockets, which means that every message is transmitted over the Ethernet as soon as possible. When this socket option is disabled, it minimizes the time it takes for messages to be transmitted but increases the overall number of packets transmitted, which results in increased Central Processing Unit (CPU) utilization and less efficient Local Area Network (LAN) utilization.

Enabling Nagle's Algorithm allows the IP stack to hold on to messages for a period of time in an effort to pack multiple messages into a single TCP packet. Though message latency increases, fewer packets are generated and processed, resulting in lower CPU and better LAN utilization. At high rates of traffic through a socket, message latency is minimal because the threshold packet size is reached (messages fill the packet) very quickly, which causes the stack to transmit the packet.

Administrators can choose to enable or disable Nagle's Algorithm depending on the parameters that work best for the EAGLE 5 ISS. Nagle's Algorithm also can be toggled between being 1) enabled when the amount of messages that are transmitted is higher than the threshold limit and 2) disabled when transmission rates are lower than the threshold.

For more information on how to set up these features by altering the Database Communication Module Parameter Set (DCMPS), see the *Commands Manual*.

Type of Service (TOS)

This 8-bit, Type of Service (TOS) socket option is also used to prioritize the flow of network traffic. Packets can be routed differently according to the TOS value set in the IP header. The TOS field resides within the message's IP header and identifies the network router's priorities. Tekelec does not specify how the TOS bits should be set. The administrator can choose how to set them. Figure 2-16 on page 2-40 illustrates a TOS field setup. For more information on how to set up these features by altering the Database Communication Module Parameter Set (DCMPS), see the *Commands Manual*.

Figure 2-16. 8-bit TOS Field

| | | | | | | | |
|---|---|-------------|------------|-------|---------------|---|---|
| 7 | 6 | 5 | 4 | 3 | 2 | 1 | 0 |
| | | Reliability | Throughput | Delay | IP precedence | | |

For Differentiated Service (DiffServ) the TOS field is referred to as the Differentiated Service (DS) field. The priorities of the DS field in the IP header can also be set through socket options. Figure 2-17 illustrates a DS field setup.

Figure 2-17. DS Field

| | | | | | | | |
|----|---|------|---|---|---|---|---|
| 7 | 6 | 5 | 4 | 3 | 2 | 1 | 0 |
| CU | | DSCP | | | | | |

ISUP Normalization

This feature allows an EAGLE 5 ISS to deliver ISUP messages that arrive at the EAGLE 5 ISS from the public switched telephone network (PSTN) in a country specific ISUP variant format, to an IP device in a normalized ISUP format. Likewise, it enables traffic received from an IP device in normalized ISUP format to be delivered to a PSTN link in the appropriate country variant format. The normalized ISUP messages are carried in TALI packets. Data is contained in the TALI packet itself to specify what national network (or what country) the ISUP message originated from or is destined to and what ISUP variant the original PSTN message was formatted in.

This feature allows an IP device (for example, an MGC providing Class 4 Tandem functionality) connected to an EAGLE 5 ISS to perform call setup for multiple countries without knowledge of the various countries' ISUP message formats. The MGC needs only to support encode and decode functionality for the normalized format and does not have to support encode and decode functionality for each ISUP variant.

The EAGLE 5 ISS and IP device are able to support these call scenarios:

1. Intra-Country Call
2. Inter-Country Call

This capability is shown in Figure 2-18 on page 2-41.

Figure 2-18. ISUP Normalization Supporting Multiple ISUP Variants

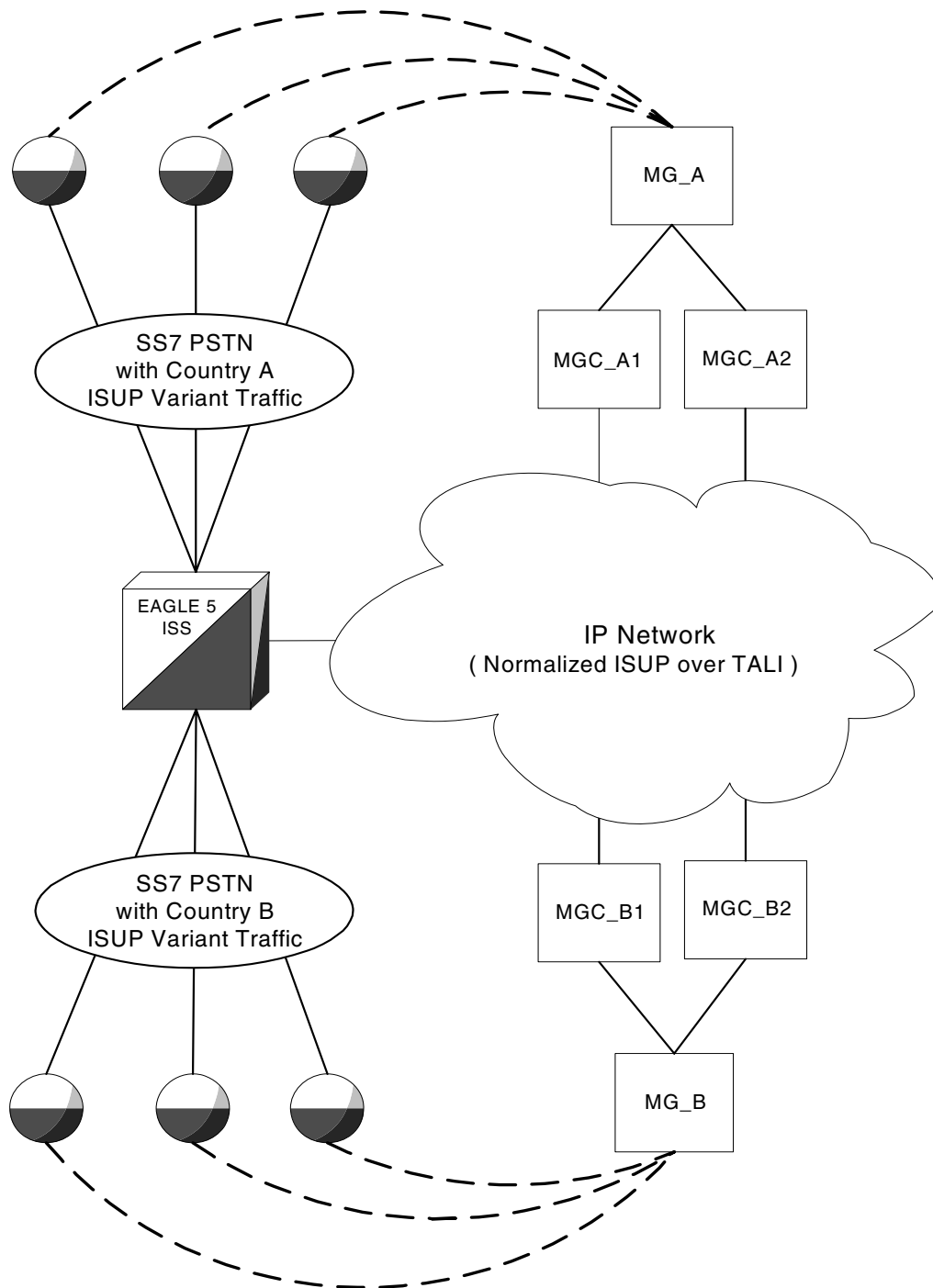

Although Figure 2-18 on page 2-41 shows a separate soft-switch (that is, the Media Gateway/Media Gateway Controller pair) per country, this feature does not prevent a single soft-switch, communicating with a single pair of IPGWI cards, from performing call setup for multiple countries.

Referring to Figure 2-18, the ‘normalized ISUP traffic’ is used in the communication between the EAGLE 5 ISS and the devices on the IP network. The traffic carried over the DS0 links to Country A SSPs and Country B SSPs (on the PSTN side of the EAGLE 5 ISS) continues to be formatted in the ISUP national variant format.

Normalized ISUP refers to the ISUP messages that are passed between the IP card running the IPGWI application (IPGWI card) and the IP device when this feature is used. The Normalized ISUP message is based on ETSI V3 ISUP, but provides a method to pass along variant-specific data that does not map cleanly to ETSI V3. This allows the IP device to support decode/state machine/encode capabilities for Normalized ISUP only, rather than having to support these capabilities for multiple ISUP variants. Note that Normalized ISUP messages only exist in the IP network and are never present in the PSTN.

The variant specific information is retained as part of the ISUP normalized TALI message to guarantee that intra-country calling features which require variant specific messages and parameters can continue to work for those intra-country calls.

The normalization function is performed entirely on the IPGWI card in the EAGLE 5 ISS. Everything presented to the MGCs that are using this feature is in Normalized ISUP format. Everything that is presented to the MTP3 portion of the IPGWI card (to be routed back to a DS0 link towards the PSTN) is in the format for a specific ISUP variant. Each DS0 LIM (or any LIM in the EAGLE 5 ISS other than the IPGWI card) receives MSUs from the PSTN wire and from the IMT in the same ISUP variant format. The DS0 LIMS do not know how to perform ISUP Normalization, and do not even know that it is occurring on the IPGWI cards.

The ISUP Normalization feature supports the normalization of the ISUP variants shown in Table 2-9:

Table 2-9. ISUP Variants Supported by this Feature

| ISUP Variant | Part No. | PSTN Category | PSTN ID |
|---------------------------|-------------|---------------|---------|
| ISUP Normalization | 893000201 | 1 | * |
| ITU Q.767 Normalization | 893000501 | 1 | 1 |
| ESTI V3 Normalization | 893000601 | 1 | 2 |
| UK PNO-ISC7 Normalization | 893000401 | 1 | 3 |
| German ISUP Normalization | 893000301 | 1 | 4 |
| French ISUP Normalization | 893-0007-01 | 1 | 5 |

Table 2-9. ISUP Variants Supported by this Feature (Continued)

| ISUP Variant | Part No. | PSTN Category | PSTN ID |
|---|-----------------|----------------------|----------------|
| Sweden ISUP Normalization | 893-0008-01 | 1 | 6 |
| Belgium ISUP Normalization | 893-0009-01 | 1 | 7 |
| Netherlands ISUP Normalization | 893-0010-01 | 1 | 8 |
| Switzerland ISUP Normalization | 893-0011-01 | 1 | 9 |
| Austria ISUP Normalization | 893-0012-01 | 1 | 10 |
| Italy ISUP Normalization | 893-0013-01 | 1 | 11 |
| Ireland ISUP Normalization | 893-0014-01 | 1 | 12 |
| India ISUP Normalization | 893-0015-01 | 1 | 13 |
| Malaysia ISUP Normalization | 893-0016-01 | 1 | 14 |
| Vietnam ISUP Normalization | 893-0017-01 | 1 | 15 |
| South Africa ISUP Normalization | 893-0018-01 | 1 | 16 |
| Argentina ISUP Normalization | 893-0019-01 | 1 | 17 |
| Chile ISUP Normalization | 893-0020-01 | 1 | 18 |
| Venezuela ISUP Normalization | 893-0021-01 | 1 | 19 |
| Mexico ISUP Normalization | 893-0022-01 | 1 | 20 |
| Brazil ISUP Normalization | 893-0023-01 | 1 | 21 |
| Spain ISUP Normalization | 893-0024-01 | 1 | 22 |
| Colombia ISUP Normalization | 893-0025-01 | 1 | 23 |
| Peru ISUP Normalization | 893-0026-01 | 1 | 24 |
| Hong Kong ISUP Normalization | 893-0027-01 | 1 | 25 |
| China ISUP Normalization | 893-0028-01 | 1 | 26 |
| Japan ISUP Normalization | 893-0029-01 | 1 | 27 |
| Korea ISUP Normalization | 893-0030-01 | 1 | 28 |
| Taiwan ISUP Normalization | 893-0031-01 | 1 | 29 |
| Philippines ISUP Normalization | 893-0032-01 | 1 | 30 |
| Singapore ISUP Normalization | 893-0033-01 | 1 | 31 |
| Australia ISUP Normalization | 893-0034-01 | 1 | 32 |
| Reserved for future definition by Tekelec | | 2 through 4095 | |
| Available for user-defined categories | | 4095 through 65535 | |

The Quantity Control feature allows a customer to provision a specified quantity of user-defined variants within the PSTN categories 4096 - 65535. Each Quantity Control Feature is associated with a specific quantity of variants. To provision user-defined variants, it is necessary to purchase the appropriate Feature Access Keys from Tekelec. Variants enabled using the Quantity Control feature do not have associated PSTN Presentation values.

The part number for user-defined variants is 893-0100-nn, where nn is a number ranging from 01 to 20. Use part number 893-0100-01 to order one new variant, 893-0100-05 to order five new variants, and so on.

It is important to understand that for each variant that is supported, only two conversions are needed. For example:

- From ISUP Variant A -> Normalized ISUP
- From Normalized ISUP -> ISUP Variant A

To clarify this, the normalization on the IPGWI card never converts from ISUP Variant A to ISUP Variant B.

However, a call setup scenario could exist where two variants are used. In this case the conversions would go from:

Variant A -> Normalized -> Variant B

But the conversions cannot all occur at once. Two separate conversions occur, possibly on different nodes.

The normalization of ANSI ISUP messages is not supported. The normalization of ISUP MSUs only occur on the cards running the IPGWI application and not the SS7IPGW application.

PSTN Presentation

PSTN presentation is a 32-bit value indicating the format of the MSU Level 3 payload while it exists in the PSTN (see Figure 2-19 on page 2-45). When using this feature, the PSTN presentation is configured in the IP Routing Key table and appears in "XSRV-xnrm" and "XSR-xmtp" packet headers.

The PSTN presentation's primary uses are as follows:

1. To indicate to the IPGWI card how to decode an ISUP MSU received from the PSTN when converting it to Normalized format for transmission over a socket configured for ISUP via XSRV-xmm.
2. To indicate to the IPGWI card how to encode an ISUP MSU for delivery to the PSTN when converting a Normalized ISUP packet received from an IP device.
3. To indicate to an IP device how to decode the Variant Specific portion (Part 2) of a received 'XSRV-xnrm' TALI packet.

4. To indicate to an IP device how to decode the raw MSU payload of a received "XSRV-xmtp" TALI packet (not limited to ISUP messages).

The PSTN Presentation consists of two parts, a PSTN Category and a PSTN ID:

- PSTN Category – provides a way of logically partitioning groups of PSTN IDs
- PSTN ID – provides unique identification of presentations within a given category

Figure 2-19. Format of PSTN Presentation

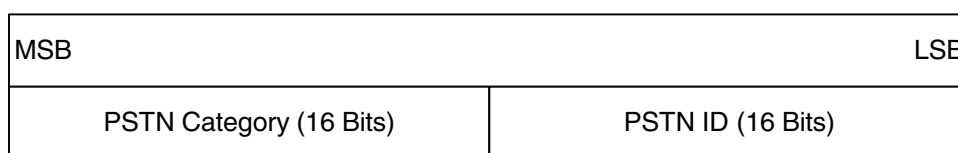

Some PSTN Categories are reserved for specific vendor's use and definition. For example, EAGLE 5 ISS's reserve category #1 for defining ISUP variants supported by this feature. Table 2-9 lists valid PSTN categories and IDs.

The list of Tekelec-defined and user-defined PSTNs can be displayed by using the `rtrv-pstn-pres` command, as illustrated in the following example:

```

PSTNCAT      PSTNID      PSTNDESC
00001        00001        ITU Q.767
00001        00002        ETSI V3
00001        00003        UK PNO-ISC7
00001        00004        GERMAN ISUP
00001        00020        MEXICO
04096        01000        User Defined 4096/1000
    
```

Note that a PSTN Presentation of 0 (that is, Category = 0 and ID = 0) is defined as unknown and is the default value in routing keys and TALI XSRV headers.

Other PSTN Categories are available for implementation specific definition by the customer. For example, customer X may use category 4096 to define a set of PSTN IDs (that is, BTNUP, French TUP, etc.) that exists in its network and are routed over IPGWI links.

The PSTN Presentation (Category, ID, and description) is provisioned using the `ent-pstn-pres` command. This command may be used to define values within the Tekelec-defined range (PSTN Category 0-4095) as long as there exists an associated ON/OFF Control Feature, and its status is ENABLED. This command may be used to define values within the user-defined range (PSTN Category 4096-65535) as long as there exists an associated ISUP Normalization Quantity Control Feature and its status is ENABLED and its capacity is not going to be exceeded.

This command also creates a new entry in the ISUP Variant table initialized to default values. There must be an available entry in the table or this command will be rejected.

The **chg-pstn-pres** command changes the descriptive text of a previously provisioned PSTN Presentation value.

The **dlt-pstn-pres** command deletes a previously provisioned PSTN Presentation value. The entry in the ISUP Variant table associated with the deleted PSTN will be marked as available. All of the associated ISUP messages and parameters that have been provisioned for the PSTN/Variant with the **chg-isupvar-attr** command will also be deleted.

The user cannot delete the PSTN for Normalized ISUP (ETSI V3).

Deleting the PSTN Category or ID may cause a loss of traffic if SS7IP routing keys exist using that PSTN value. The user should use caution when performing this action and must enter the **force** parameter with the **dlt-pstn-pres** command.

The **chg-isupvar-attr** command is used to provision the ISUP message and parameter database for a variant based on the PSTN Presentation value. This command will allow the administrator to:

- Specify/change the defined message-type-codes and parameter-codes for the variant.
- Specify/change the optional parameters that are supported for each message-type.
- Specify/change the mandatory-fixed and mandatory-variable-length parameters that are supported for each message-type.
- Specify/change the minimum valid length for each parameter.
- Specify/change for each message or message/parameter combination, a custom "action". An "action" parameter for this command will allow the administrator to specify one of the following three actions:
 - NONE - this is the default and it means the standard "normalization" conversion rules apply, i.e. do nothing special.
 - CONVERT - a special conversion routine will be invoked by software when it receives the message or message/parameter. For the Tekelec-defined variants, there may be certain messages or parameters that require special handling. Tekelec will write special conversion software for these cases. This value may be entered for user-defined variants, however software will ignore it.

- PASSTHRU - If specified with a message, then PASSTHRU means the specified message should be passed through unconverted using the raw MTP3 transfer method. If specified in a message/parameter combination, then PASSTHRU means that parameter, when received in that message, should be passed through to the Normalized section of the message (ignoring the DEFINED/SUPPORTED attributes of the Normalized specification).

The **copy-isupvar-attrib** command copies a “source” variant database to a “destination” variant database. This command provides the user with a quick way to provision a variant by copying a source variant database that has a similar ISUP protocol definition. The user can then use the **chg-isupvar-attrib** command to make the changes for the new protocol.

The PSTN Presentation is used to identify both the source and destination table entries. Both entries must be previously defined PSTN Presentation values, i.e. either a Tekelec-defined PSTN or a user-defined PSTN by the **ent-psn-pres** command. Use the **rtrv-psn-pres** command to display the only allowed values for the source and destination PSTNs.

If the source or destination variant is a Tekelec-defined PSTN value, then its associated ON/OFF Control Feature must be ENABLED.

The destination PSTN is not allowed to be Normalized ISUP (ETSI V3).

The **rtrv-isupvar-attrib** command displays the variant database provisioned by the **chg-isupvar-attrib** command. An assortment of displays is possible depending on the filters applied.

The following is an example of a possible output displaying all supported parameters for a specified message in a variant:

| PSTNCAT | PSTNID | MSGCODE | ATTRIB | ACTION |
|---------|--------|---------|---------|---------|
| 00001 | 00005 | 04h | DEFINED | CONVERT |

| MSGCODE | PARMCODE | TYPE | ORDER | ACTION |
|---------|----------|------|-------|---------|
| 04h | --- | --- | - | CONVERT |
| | 10h | MF | 1 | NONE |
| | 08h | MF | 2 | NONE |
| | 09h | MV | 1 | CONVERT |
| | FEh | MV | 2 | NONE |
| | 00h | OPT | - | NONE |
| | 01h | OPT | - | NONE |

The **chg-appl-rtkey** command accesses the ISUP variant table to determine if the PSTN Presentation value entered is valid. It evaluates both Tekelec-defined and user-defined variant PSTNs.

The “Changing the PSTN Presentation and Normalization Attributes in a Routing Key” procedure on page 3-303 shows how to configure the EAGLE 5 ISS for ISUP Normalization feature.

IETF Adapter Layer Support

Overview

The current implementation of the IETF adapter layers in the EAGLE 5 ISS uses three adapter layers: SUA, M3UA, and M2PA. These adapter layers are assigned to SCTP associations which define the connection to the far end. An SCTP association is defined in the EAGLE 5 ISS by the local host name, the local SCTP port, the remote host name, and the remote SCTP port.

The three adapter layers used in the EAGLE 5 ISS are supported depending on the type of IP card being used for the IP connection. The SUA and M3UA adapter layers can be used only on IPGWx cards (cards running either the SS7IPGW or IPGWI applications). The M2PA adapter layer can be used only on IPLIMx cards (cards running either the IPLIM or IPLIMI applications).

SCTP associations on IPGWx cards, like TCP sockets, use routing keys to distinguish between the IP devices being connected to. TCP sockets are assigned directly to routing keys. SCTP associations cannot be assigned directly to routing keys. To get an SCTP association ultimately assigned to a routing key, the IETF adapter layers use the concept of the application server (AS). The SCTP association is assigned to an application server. One or more associations are normally actively processing traffic. A group of associations (up to 16) can be assigned to an application server. An application server, a logical entity serving a specific routing key, is assigned to a routing key. This results in assigning the SCTP association, up to a maximum of 16, to a routing key.

The IETF SUA and M3UA adapter layers are supported on IPGWx cards. These adapter layers support the full implementation of the AS and routing key for the EAGLE 5 ISS. SCTP associations assigned to IPGWx cards can be assigned to application servers and routing keys.

The IETF M2PA adapter layer is supported on IPLIMx cards. The M2PA adapter layer does not support application servers, therefore SCTP associations assigned to M2PA links on IPLIMx cards cannot be assigned to application servers.

Figure 2-20 on page 2-49 shows a typical configuration with four connections (SCTP associations) out of the EAGLE 5 ISS using IPGWx cards. Each association is connected to a process on the far end.

Figure 2-20. AS/Association Relationship

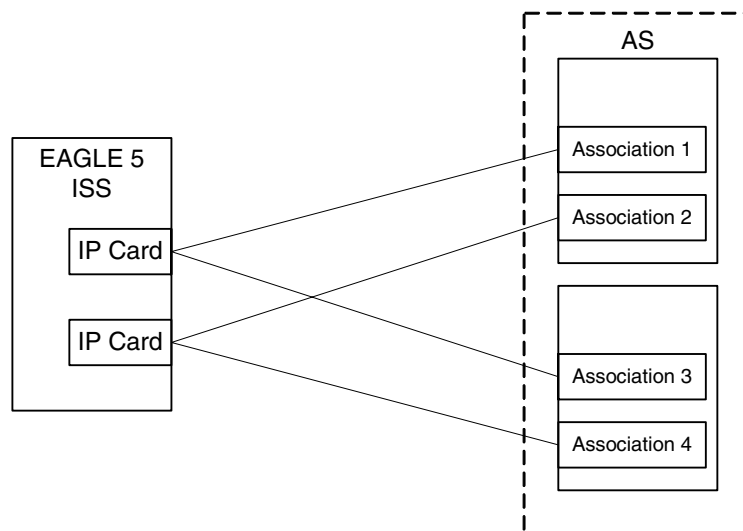

Interaction Between TALI and IETF Connections Within a Single EAGLE 5 ISS

The IP cards in the EAGLE 5 ISS can use both TCP sockets (TALI connections) and SCTP associations (IETF connections) to make IP connections to far end devices. An IP connection is defined as either a TCP socket or an SCTP association. The EAGLE 5 ISS may contain all TALI connections, all IETF connections, or a combination of both. Figure 2-21 shows that a single EAGLE 5 ISS can communicate to far end devices using different adapter layers. Each IP card in the EAGLE 5 ISS can support both TCP sockets and application servers. However, on IPGWx cards, only one TCP socket can be assigned to a single routing key. If the routing key has a routing context value assigned to it, only one application server can be assigned to the routing key. If the routing key does not have a routing context value assigned to it, the application server can be assigned to a maximum of 2500 routing keys.

An IPGWx card can contain a maximum of 50 connections. The EAGLE 5 ISS allows a maximum of 64 IPGWx cards, resulting in a maximum of 3200 connections for all IPGWx cards.

An IPLIMx card can have only one connection for each signaling link assigned to the card. The dual-slot DCM can contain only two signaling links, resulting in a maximum of two IP connections on these cards. The single-slot EDCM can contain a maximum of eight signaling links, resulting in a maximum of eight IP connections for this card. The E5-ENET card can contain a maximum of 16 signaling links, resulting in a maximum of 161 IP connections for this card.

The EAGLE 5 ISS can contain a maximum of 4000 IP connections, between IPGWx cards and IPLIMx cards.

Figure 2-21. TCP Socket/SCTP Association Relationship

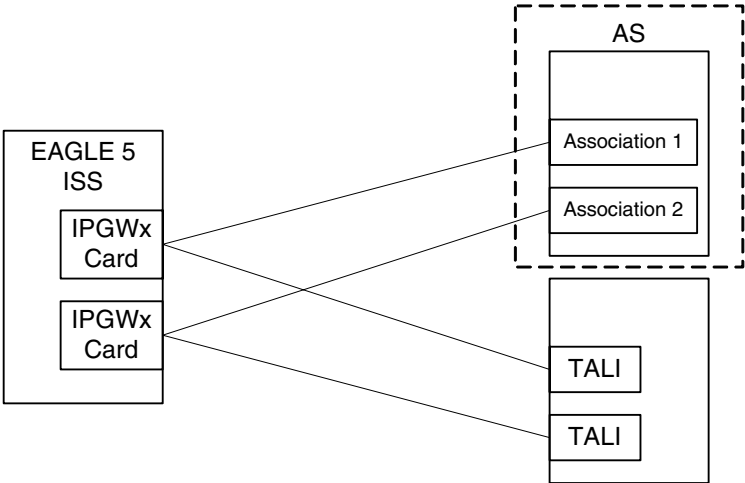

Feature Components

The EAGLE 5 ISS with IP⁷ Secure Gateway functionality is used as a signaling gateway between the PSTN and IP networks as shown in Figure 2-22. This figure shows that signaling gateways interface with media gateway controllers (MGCs) and MGCs interface with media gateways (MGs).

Figure 2-22. SG/MGC/MG Network Diagram

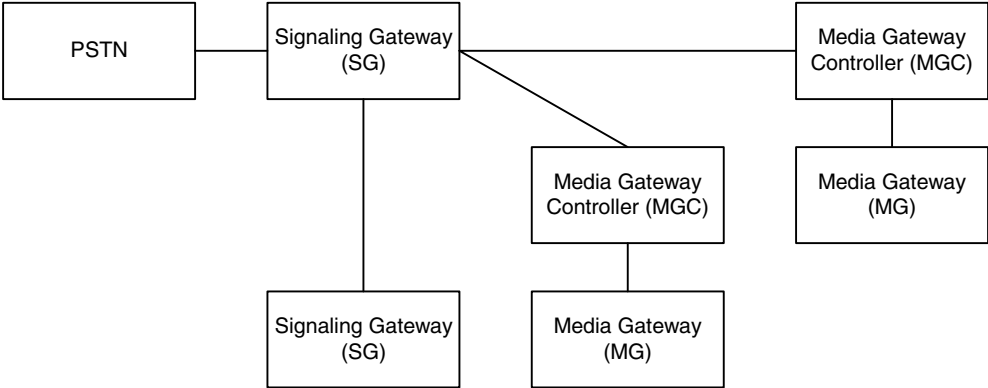

If a TCP socket is used to make the IP connection to other devices, the EAGLE 5 ISS uses the TALI protocol on top of TCP to communicate to other devices, as shown in Figure 2-23 on page 2-51.

Figure 2-23. TALI Protocol Stack (IPGWx and IPLIMx)

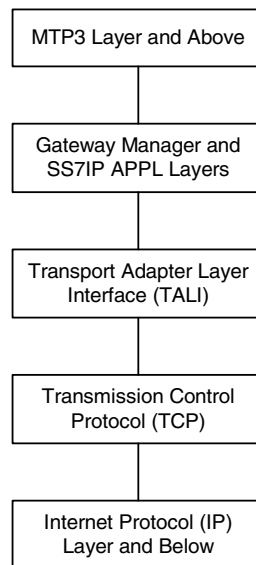

To provide a signaling gateway solution that will be able to communicate with a larger number of IP devices, the EAGLE 5 ISS needs to be able to communicate with multiple MGCs which are using SCTP as the transport layer and M3UA, M2PA, or SUA as an adapter layer. On an IPLIMx card, the M2PA adapter layer can be used with SCTP as shown in Figure 2-24. On an IPGWx card, the M3UA and SUA adapter layers can be used with SCTP as shown in Figure 2-25 on page 2-52.

Figure 2-24. IPLIMx Protocol Stack with SCTP as the Transport Layer

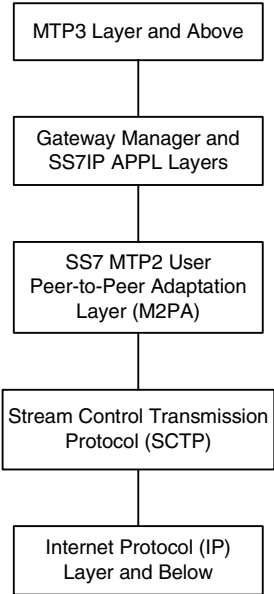
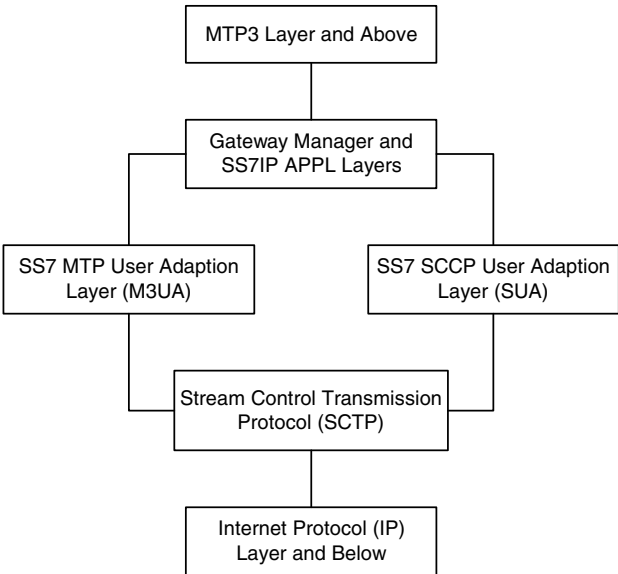

Figure 2-25. IPGWx Protocol Stack with SCTP as the Transport Layer



The EAGLE 5 ISS supports many (mapping & transport) protocol combinations. One connection can be running TALI/TCP while another connection is running M3UA/SCTP, and a third connection is running M2PA/SCTP. These three connections can be on the same card (provided the card is an IPGW_x card) and even a part of the same routing key (if the card is an IPGW_x card). If the card is an IPLIM_x card, only M2PA connections can be assigned to the card.

This mixture allows greater configurability for the user. The EAGLE 5 ISS does not support TALI over SCTP, or IETF adapter layers over TCP.

SUA Layer

The SUA layer, only supported on IP cards running either the SS7IPGW or IPGWI applications (IPGW_x cards), was designed to fit the need for the delivery of SCCP-user messages (MAP & CAP over TCAP, RANAP, etc.) and new third generation network protocol messages over IP between two signaling endpoints. Consideration is given for the transport from an SS7 signaling gateway to an IP signaling node (such as an IP-resident database). This protocol can also support transport of SCCP-user messages between two endpoints wholly contained within an IP network. The layer is expected to meet the following criteria:

- Support for transfer of SS7 SCCP-User Part messages (for example, TCAP, RANAP, etc.)
- Support for SCCP connectionless service.
- Support for the seamless operation of SCCP-User protocol peers
- Support for the management of SCTP transport associations between a signaling gateway and one or more IP-based signaling nodes).
- Support for distributed IP-based signaling nodes.
- Support for the asynchronous reporting of status changes to management

Depending upon the SCCP-users supported, the SUA layer supports the four possible SCCP protocol classes transparently. The SCCP protocol classes are defined as follows:

- Protocol class 0 provides unordered transfer of SCCP-user messages in a connectionless manner.
- Protocol class 1 allows the SCCP-user to select the in-sequence delivery of SCCP-user messages in a connectionless manner.
- Protocol class 2 allows the bi-directional transfer of SCCP-user messages by setting up a temporary or permanent signaling connection.
- Protocol class 3 allows the features of protocol class 2 with the inclusion of flow control. Detection of message loss or mis-sequencing is included.

Protocol classes 0 and 1 make up the SCCP connectionless service. Protocol classes 2 and 3 make up the SCCP connection-oriented service.

The SUA layer supports the following SCCP network management functions:

- Coord Request
- Coord Indication
- Coord Response
- Coord Confirm
- State Request
- State Indication
- Pcstate Indication

The SUA layer provides interworking with SCCP management functions at the signaling gateway for seamless inter-operation between the SCN network and the IP network. This means:

- An indication to the SCCP-user at an application server process that a remote SS7 endpoint/peer is unreachable.
- An indication to the SCCP-user at an application server process that a remote SS7 endpoint/peer is reachable.
- Congestion indication to SCCP-user at an application server process.
- The initiation of an audit of remote SS7 endpoints at the signaling gateway.

M3UA Layer

The M3UA layer, supported on only IPGWx cards, was designed to fit the need for signaling protocol delivery from an SS7 signaling gateway to a media gateway controller (MGC) or IP-resident database. The layer is expected to meet the following criteria:

- Support for the transfer of all SS7 MTP3-User Part messages (for example, ISUP, SCCP, TUP, etc.)
- Support for the seamless operation of MTP3-User protocol peers
- Support for the management of SCTP transport associations and traffic between a signaling gateway and one or more MGCs or IP-resident databases
- Support for MGC or IP-resident database process fail-over and load-sharing
- Support for the asynchronous reporting of status changes to management

The M3UA layer at an application server provides a set of primitives at its upper layer to the MTP3-Users that is the equivalent of those provided by the MTP Level 3 to its local users at an SS7 SEP. In this way, the ISUP or SCCP layer at an application server process is unaware that the expected MTP3 services are offered remotely from an MTP3 Layer at a signaling gateway, and not by a local MTP3 layer. The MTP3 layer at a signaling gateway may also be unaware that its local users are actually remote user parts over the M3UA layer. The M3UA layer extends access to the MTP3 layer services to a remote IP-based application. The M3UA layer does not provide the MTP3 services.

The M3UA layer provides the transport of MTP-TRANSFER primitives across an established SCTP association between a signaling gateway and an application server process and between IPSPs. The MTP-TRANSFER primitives are encoded as MTP3-User messages with attached MTP3 Routing Labels as described in the message format sections of the SCCP and ISUP recommendations. In this way, the SCCP and ISUP messages received from the SS7 network are not re-encoded into a different format for transport to or from the server processes. All the required MTP3 Routing Label information (OPC, DPC, and SIO) is available at the application server process and the IPSP as is expected by the MTP3-User protocol layer.

At the signaling gateway, the M3UA layer also provides inter-working with MTP3 management functions to support seamless operation of the signaling applications in the SS7 and IP domains. This includes:

- Providing an indication to MTP3-Users at an application server process that a remote destination in the SS7 network is not reachable.
- Providing an indication to MTP3-Users at an application server process that a remote destination in the SS7 network is now reachable.

- Providing an indication to MTP3-Users at an application server process that messages to a remote MTP3-User peer in the SS7 network are experiencing SS7 congestion
- Providing an indication to MTP3-Users at an application server process that a remote MTP3-User peer is unavailable.

The M3UA layer at the signaling gateway maintains the availability of all configured remote application server processes, in order to manage the SCTP Associations and the traffic between the signaling gateway and application server processes. As well, the Active/Inactive state of remote application server processes is also maintained - Active application server processes are those currently receiving traffic from the signaling gateway.

M2PA Layer

The M2PA layer, supported only on IPLIMx cards, is a peer-to-peer protocol and provides mappings for all SS7 messages. In a peer-to-peer mode, either side of the IP connection may initiate the connection.

The M2PA layer closely matches the SAAL/TALI/TCP/IP Level 2 protocol stack. This allows it to provide all of the Level 2 features expected by MTP3. The M2PA layer lies below MTP3 in the protocol stack. Figure 2-26 shows the protocol layers in three interconnected nodes involving the M2PA layer.

Figure 2-26. M2PA in the IP⁷ Signaling Gateway

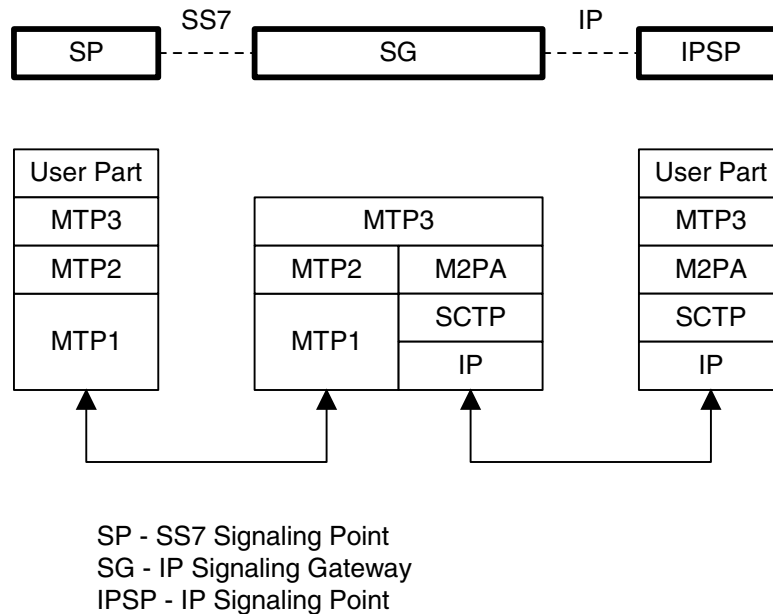

The M2PA layer receives the primitives sent from MTP3 to its lower layer. The M2PA layer processes these primitives or maps them to appropriate primitives at the M2PA/SCTP interface. Likewise, the M2PA layer sends primitives to MTP3 like those used in the MTP3/MTP2 interface.

The M2PA layer provides MTP2 functionality that is not provided by SCTP. This includes:

- Reporting of link status changes to MTP3
- Processor outage procedure
- Link alignment procedure

The M2PA layer allows MTP3 to perform all of its Message Handling and Network Management functions with IPSPs as with other SS7 nodes.

The M2PA layer also supports full retrieval because it assigns sequence numbers to all protocol messages and provides for acknowledgements from the M2PA peer. This means that an M2PA signaling link is able to execute the Change-Over and Change-Back procedures. The M2PA layer makes use of the SS7 Extended Changeover (XCO) and SS7 Extended Changeover Acknowledgement (XCA) messages in order to communicate 24-bit sequence numbers with the peer. This is very similar to what IPLIMx SAALALI signaling links currently do.

SCTP

SCTP is a protocol designed to operate on top of a non-reliable protocol such as IP, while providing a reliable data delivery to the SCTP user. The SCTP protocol is designed to be a discrete protocol.

Although SCTP is similar in some respects to the Transport Control Protocol (TCP), it differs in several key areas. The two protocols are similar in that they both provide reliable data delivery over a non-reliable network protocol (IP). The SCTP protocol is a more robust and higher performance protocol than TCP.

Broader Definition of Connection Four-Tuple

The TCP protocol defines a connection via a four-tuple – a specific local IP address, local transport protocol port, a specific remote host IP address and remote transport protocol port. The TCP connection is point-to-point and once the session is established the four-tuple can not change. SCTP uses a similar four-tuple concept, but provides for the local and remote IP address values to be a list of IP addresses. SCTP allows a multi-homed host, with multiple network interfaces and more than one way to reach the far-end host, the capability to make use of this additional network connectivity to support the transport of data via the SCTP protocol. Redundancy through the support of multi-homing session end-points is a major SCTP advantage.

Multiple Streams

TCP is a point-to-point byte stream oriented transport protocol. In such a protocol if a single byte is corrupted or lost, then all data that follows must be queued and delayed from delivery to the application until the missing data is retransmitted and received to make the stream valid. With the TCP protocol, all data being transmitted is affected because there is only one path from end-to-end. The SCTP protocol addresses this limitation by providing the capability to specify more than one transport path between the two end-points. In SCTP, the four-tuple – with the multi-homing feature – defines what the SCTP protocol calls an *association*.

The association is composed of one or more uni-directional transport paths called *streams*. The number of inbound and outbound streams is independent of one another and is determined at session initiation time (for example, an association may be composed of three outbound and one inbound stream). In this scheme, a data retransmission only affects a single stream. If an association is defined with multiple streams and a packet is lost on a specific stream, data transmission on the other streams, which form this association, is not blocked. However, this feature is only beneficial if the upper layer application uses it.

In the EAGLE 5 ISS, a maximum of 2 inbound and 2 outbound streams can be defined for an association. Stream 0 in each direction is designated for Link Status messages. Stream 1 is designated for User Data messages. Separating the Link Status and User Data messages onto separate streams allows the adapter layer to prioritize the messages in a manner similar to MTP2. If the peer chooses to configure the association to have only one stream, then the signaling gateway will be able to use only stream 0 for both Link Status messages and User Data messages.

Datagram Stream

While TCP is implemented as a byte-oriented stream protocol, SCTP is based on a datagram-oriented protocol stream. By choosing the datagram as the smallest unit of transport, the SCTP protocol removes the need for the upper layer application to encode the length of a message as part of the message. An SCTP send results in the data being sent as a unit – a datagram – and received at the receiving node as a datagram.

Selective Acknowledgements

TCP acknowledgements are specified as the last consecutive byte in the byte stream that has been received. If a byte is dropped, the TCP protocol on the receiving side cannot pass inbound data to the user until the sender retransmits the lost byte; the stream is blocked. SCTP uses a feature known as *selective acknowledgement* in which each data chunk is identified by a chunk number – the Transmission Sequence Number (TSN) in SCTP terminology – and is explicitly acknowledged at a data chunk granularity. This means that if a data chunk is dropped, only that one data chunk needs to be retransmitted. In SCTP, a dropped

data chunk only effects one stream, since ordered transmission of data is only enforced at the stream and not the association level.

Un-order Delivery Capability

The SCTP protocol provides a mechanism for un-ordered datagram delivery. This feature means that a datagram can be transmitted and received independent of datagram sequencing and thus not delayed while awaiting a retransmission. TCP does not provide an equivalent feature of this type.

Enhanced Security

The TCP protocol has a known and easily exploitable vulnerability to denial of service attacks (for example, SYN attacks). This weakness is due to the three-way handshake used by the TCP session-establishment protocol. The TCP session establishment method causes EAGLE 5 ISS resources to be committed prior to actually establishing the session. SCTP uses a four-way handshake where resources are not committed by the host being contacted until the contacting host confirms that it is actually making a contact request to prevent such attacks.

SCTP Connectivity Concepts

The basic connectivity provided by the SCTP protocol is illustrated by Figure 2-27:

Figure 2-27. SCTP Connectivity

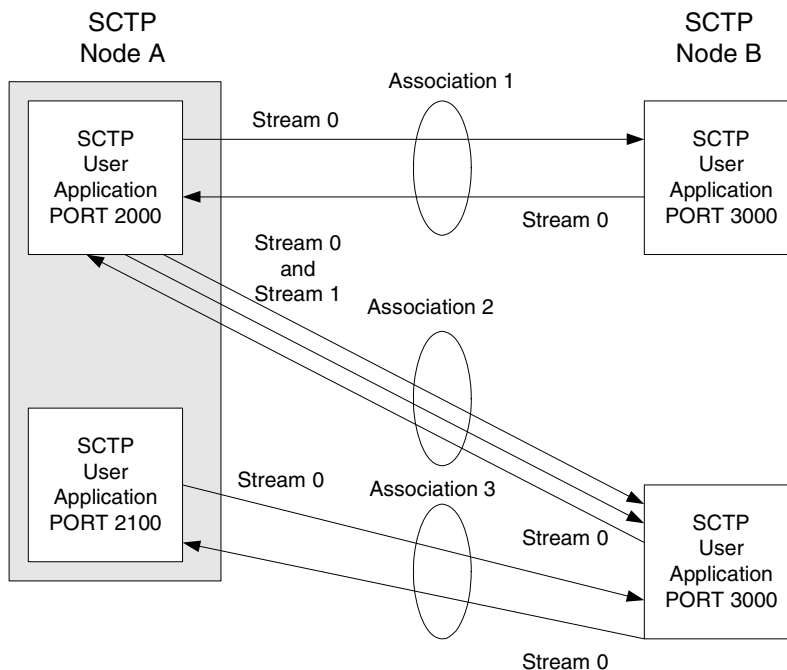

Key elements of the SCTP connection include:

- SCTP Instance
- SCTP Endpoint
- SCTP Association
- SCTP Stream

An SCTP instance is defined by the local SCTP port number. Each local SCTP port number requires its own SCTP instance. An SCTP instance as an entity defines the various SCTP characteristics that will apply to “all” SCTP associations that are created as part of the SCTP instance. These include timeout values, maximum receive windows, and so forth.

In Figure 2-27 on page 2-59 there are three hosts: SCTP node A, node B and node C. Node A has two SCTP instances: local SCTP port 2000 and 2100. Both node B and node C have a single SCTP instance, local SCTP port 3000 and 3000 respectively. The fact that both node B and C are using port 3000 does not tie them together in any way.

An SCTP endpoint is defined as the logical sender/receiver of SCTP packets. On a multi-homed host, an SCTP endpoint is represented to its peers as a combination of a set of eligible destination transport addresses to which SCTP packets can be sent and a set of eligible source transport addresses from which SCTP packets can be received. All transport addresses used by an SCTP endpoint must use the same port number, but can use multiple IP addresses. A transport address used by an SCTP endpoint must not be used by another SCTP endpoint. In other words, a transport address is unique to an SCTP endpoint.

The concept of SCTP instance clarifies this definition. In Figure 2-27 on page 2-59, IP addresses are not shown, but to illustrate this definition, assume the following:

- Node A is multi-homed having two network interface cards with IP addresses 192.168.110.10 and 192.168.55.10
- Node B has a single network interface card with IP address of 192.168.110.20
- Node C is multi-homed having two network interface cards with IP addresses 192.168.110.30 and 192.168.55.30

Based on these IP addresses from above and the defined port numbers for Figure 2-27 on page 2-59, there are four SCTP endpoints (Table 2-10).

Table 2-10. Sample SCTP Endpoints

| Node | Local IP Address | Local SCTP Port |
|--------|---------------------------------|-----------------|
| Node-1 | 192.168.110.10 192.168.55.10 | 2000 |
| Node-1 | 192.168.110.10 192.168.55.10 | 2100 |
| Node-2 | 192.168.110.20 | 3000 |
| Node-3 | 192.168.110.30 192.168.55.30 | 3000 |

An SCTP association is defined as a protocol relationship between SCTP endpoints, composed of the two SCTP endpoints and protocol state information including verification tags and the currently active set of Transmission Sequence Numbers (TSNs), etc. An association can be uniquely identified by the transport addresses used by the endpoints in the association. Two SCTP endpoints must not have more than one SCTP association between them at any given time.

Based on this definition, given the endpoints listed above and Figure 2-27 on page 2-59, there are three defined SCTP associations.

Table 2-11. Sample SCTP Associations

| Association | Local IP Address | Local SCTP Port | Remote IP Address | Remote SCTP Port |
|---------------|---------------------------------|-----------------|---------------------------------|------------------|
| Association-1 | 192.168.110.10 192.168.55.10 | 2000 | 192.168.110.20 | 3000 |
| Association-2 | 192.168.110.10 192.168.55.10 | 2000 | 192.168.110.30 192.168.55.30 | 3000 |
| Association-3 | 192.168.110.10 192.168.55.10 | 2100 | 192.168.110.30 192.168.55.30 | 3000 |

An SCTP stream is defined as a uni-directional logical channel established from one to another associated SCTP endpoint, within which all user messages are delivered in sequence except for those submitted to the unordered delivery service.

NOTE: The relationship between stream numbers in opposite directions is strictly a matter of how the applications use them. It is the responsibility of the SCTP user to create and manage these correlations if they are so desired.

Based on this definition and Figure 2-27 on page 2-59, there are a total of seven streams for the three associations.

Table 2-12. Sample SCTP Associations

| Association | Stream Number | Local IP Address | Local SCTP Port | Remote IP Address | Remote SCTP Port |
|---------------|---------------|---------------------------------|-----------------|---------------------------------|------------------|
| Association-1 | Stream 0 Out | 192.168.110.10 192.168.55.10 | 2000 | 192.168.110.20 | 3000 |
| Association-1 | Stream 0 In | 192.168.110.10 192.168.55.10 | 2000 | 192.168.110.20 | 3000 |
| Association-2 | Stream 0 Out | 192.168.110.10 192.168.55.10 | 2000 | 192.168.110.30 192.168.55.30 | 3000 |
| Association-2 | Stream 1 Out | 192.168.110.10 192.168.55.10 | 2000 | 192.168.110.30 192.168.55.30 | 3000 |
| Association-2 | Stream 0 In | 192.168.110.10 192.168.55.10 | 2000 | 192.168.110.30 192.168.55.30 | 3000 |
| Association-3 | Stream 0 Out | 192.168.110.10 192.168.55.10 | 2100 | 192.168.110.30 192.168.55.30 | 3000 |
| Association-3 | Stream 0 In | 192.168.110.10 192.168.55.10 | 2100 | 192.168.110.30 192.168.55.30 | 3000 |

3

IP⁷ Secure Gateway Configuration Procedures

| | |
|---|-------|
| Overview | 3-3 |
| Adding an IP Card | 3-17 |
| Removing an IP Card | 3-28 |
| Configuring an IPGWx Linkset | 3-37 |
| Configuring a Mate IPGWx Linkset | 3-63 |
| Adding an IP Signaling Link | 3-84 |
| Enabling the Large System # Links Controlled Feature..... | 3-104 |
| Removing an IP Signaling Link..... | 3-113 |
| Changing the IP Protocol Option | 3-123 |
| Changing IP Options other than SYNC and SCTPCSUM | 3-130 |
| Changing an IP Link | 3-135 |
| Adding an IP Host..... | 3-153 |
| Removing an IP Host | 3-156 |
| Changing an IP Card..... | 3-161 |
| Adding an IP Route..... | 3-171 |
| Removing an IP Route | 3-177 |
| Adding an Application Socket..... | 3-181 |
| Removing an Application Socket | 3-198 |
| Changing an Application Socket..... | 3-202 |

Configuring IP Socket Retransmission Parameters 3-220

Changing a DCM Parameter Set..... 3-226

Adding a Routing Key Containing a Socket..... 3-233

Adding a Routing Key Containing an Application Server..... 3-250

Removing a Routing Key..... 3-272

Changing the CIC Values in an Existing Routing Key 3-283

Changing the Routing Context Value in an Existing Routing Key..... 3-295

Changing the PSTN Presentation and Normalization Attributes
in a Routing Key 3-303

Increasing the System-Wide IPGWx Signaling TPS 3-317

IETF Adapter Layer Configuration..... 3-326

Adding an Association..... 3-327

Removing an Association..... 3-344

Changing an Association..... 3-348

Configuring SCTP Retransmission Control for an Association..... 3-381

Changing an M2PA Timer Set..... 3-389

Adding a New Association to a New Application Server 3-397

Adding an Existing Association to a New Application Server..... 3-406

Adding a New Association to an Existing Application Server 3-417

Adding an Existing Association to an Existing Application
Server 3-429

Removing an Association from an Application Server..... 3-441

Changing an Application Server 3-447

Adding a Network Appearance 3-452

Removing a Network Appearance..... 3-459

Changing the SCTP Checksum Algorithm Option..... 3-462

Changing a UA Parameter Set 3-486

Overview

The IP card supports the following applications:

- The **ip1im** application, which supports point-to-point connectivity for ANSI networks
- The **ip1imi** application, which supports point-to-point connectivity for ITU networks
- The **ss7ipgw** application, which supports point-to-multipoint connectivity for ANSI networks
- The **ipgwi** application, which supports point-to-multipoint connectivity for ITU networks.

The EAGLE 5 ISS must be configured to support connectivity to the ANSI and/or ITU IP network. Configuration consists of:

- IP configuration, consisting of these items configured in this chapter and Chapters 4 and 5:

Chapter 3

- IP card - a dual-slot DCM, single-slot EDCM, or E5-ENET card, includes the IP addresses of the Ethernet interfaces and the default router on the card.
- IP transactions per second (applies only to **ss7ipgw** and **ipgwi** applications)
- IPGWx linksets
- IP signaling links
- IP options (required only for **ss7ipgw** and **ipgwi** applications)
- IP host
- IP link
- IP application sockets
- DCM parameter set
- IP routing key (optional and applies only to the **ss7ipgw** and **ipgwi** applications).
- IP routes
- IP associations

- IP application servers
- Network appearances
- M2PA timer sets
- UA parameter sets

Chapter 4 – PSTN presentation data and ISUP variant provisioning

Chapter 5 – End node internal point codes

- SS7 configuration, consisting of the following items:
 - Destinations - see Chapter 2, “Configuring Destination Tables,” in the *Database Administration Manual - SS7*.
 - IPLIMx Linksets - see Chapter 3, “SS7 Configuration,” in the *Database Administration Manual - SS7*
 - Routes - see Chapter 3, “SS7 Configuration,” in the *Database Administration Manual - SS7*

The procedures shown in this chapter use a variety of commands. If more information on these commands is needed, go to the *Commands Manual* to find the required information.

The following steps provide a summary of all the entities that must be configured for the `iplim`, `iplimi`, `ss7ipgw`, and `ipgwi` applications. These entities must be provisioned in the order that they are shown. Steps 4, 16, 17, and 18 apply only to the `ss7ipgw` and `ipgwi` applications. Skip these steps for the `iplim` and `iplimi` applications.

1. Make sure that the required shelf is in the database with the `rtrv-shlf` command. If it is not in the database, add it with the `ent-shlf` command. For a detailed procedure, refer to the *Database Administration Manual - System Management*.
2. Make sure the cards that the signaling links will be assigned to are in the database with the `rtrv-card` command. These cards must be IP cards (card type `dcm`) and must have the `ss7ipgw`, `ipgwi`, `iplim`, or `iplimi` application assigned to them. If these cards are not in the database, add them with the `ent-card` command, specifying the `dcm` card type (`:type=dcm`) and one of these applications (`appl=ss7ipgw`, `appl=ipgwi`, `appl=iplim`, or `appl=iplimi`).
3. Verify the IP options with the `rtrv-sg-opts` command. If the options are not correct, change them with the `chg-sg-opts` command. All options except the `sctpchecksum` option (SCTP checksum algorithm) are valid only for `ss7ipgw` and `ipgwi` applications. The `sctpchecksum` option applies to the `iplim`, `iplimi`, `ss7ipgw`, and `ipgwi` applications.

4. If the `ss7ipgw` or `ipgwi` application is to be administered and you have purchased the ISUP-over-IP (`ipisup`) feature or the Dynamic Routing Key (`dynrtk`) feature, verify that the appropriate feature is turned on (`ipisup=on` or `dynrtk=on`) using the `rtrv-feat` command. If the appropriate feature is off, turn it on with the `chg-feat` command.

NOTE: Before turning on the ISUP-over-IP feature (`ipisup`) or the Dynamic Routing Key feature, make sure you have purchased these features. If you are not sure whether you have purchased the ISUP-over-IP feature or the Dynamic Routing Key feature, contact your Tekelec Sales Representative or Account Representative.

Once a feature has been turned on with the `chg-feat` command, the feature cannot be turned off.

Steps 4, 6, 17, 18, and 19 are valid only for `ss7ipgw` and `ipgwi` applications.

5. The network configuration for the EAGLE 5 ISS requires linksets, SS7 routes, and destinations. These entities use point codes and these point codes must be defined in the database. When nodes in different networks wish to communicate, each node must have either a true point code (TPC) or an alias point code for each of the two network types involved. For example, if node 1 in an ANSI network wishes to communicate with node 2 in an ITU-N network, node 1 must have an ANSI TPC and an ITU-N alias point code; and node 2 must have an ITU-N TPC and an ANSI alias point code.

Figure 3-1 shows an example of a mixed network with ANSI, ITU-I, and ITU-N nodes. Each node has one true point code and two alias point codes.

Figure 3-1. Mixed Network with ANSI, ITU-I, and ITU-N Nodes

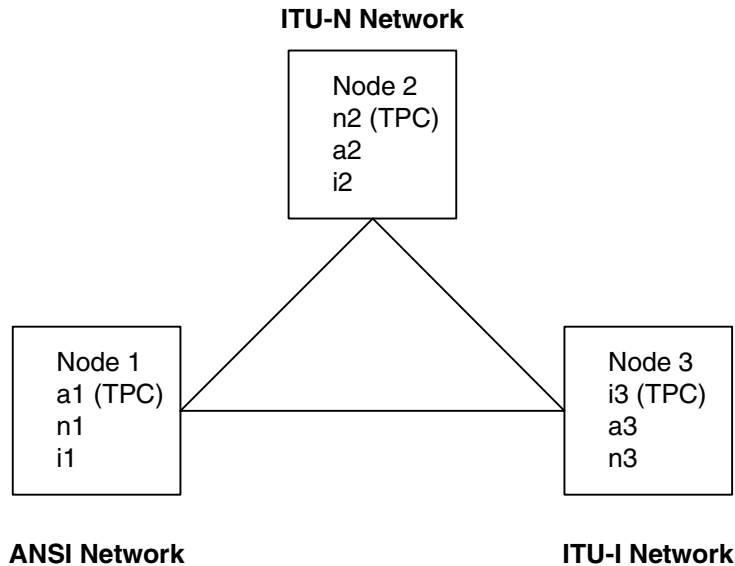

Adjacent point codes (using the `ipgwapc` parameter) and virtual point codes must be defined for the `ss7ipgw` and `ipgwi` related links. For adjacent point codes, the specified point codes must not be reused anywhere in the SS7 network, with the exception that they can be used in a mated node with the EAGLE 5 ISS.

Verify that the necessary point codes are in the database with the `rtrv-dstn` command. If they are not in the database, add them with the `ent-dstn` command.

NOTE: An ITU-N point code can be either a 14-bit ITU-N point code (defined by the `ent-dstn` command's `dpcn` parameter), or a 24-bit ITU-N point code (defined by the `ent-dstn` command's `dpcn24` parameter). The EAGLE 5 ISS can contain either type of ITU-N point code, but not both at the same time.

6. The amount of IP transactions per second the EAGLE 5 ISS supports can be set using the `enable-ctrl-feat` command. The amount set by the `enable-ctrl-feat` command applies to the entire EAGLE 5 ISS, and only to IPGWx linksets. The amount of IP transactions per second can be set in amounts of 200, 400, 600, 1,000, and from 2,000 to 112,000 in increments of 2000 transactions per second.

Steps 4, 6, 17, 18, and 19 are valid only for `ss7ipgw` and `ipgwi` applications.

7. The linksets that will contain the signaling links must be in the database. A linkset is a group of links that terminate into the same adjacent point code. All links in the linkset can transport compatible MSU formats. The network type

of the adjacent point code assigned to the linkset determines the network type of the linkset. These linksets must be assigned an adjacent point code (APC) that is in the SS7 domain. Verify this with the **rtrv-1s** command. If the APC is in the SS7 domain, the entry **SS7** is shown in the **DOMAIN** field of the output.

Mated EAGLE 5 ISSs are connected through C links. Since each destination can be reached only over linksets that match that destination's network type, mated EAGLE 5 ISSs require a C-link linkset for each network the STP is connected to. For systems with three true point codes (TPCs), there needs to be a C linkset to transport ANSI formatted MSUs, a C linkset to transport ITU-N formatted MSUs, and a C linkset to transport ITU-I formatted MSUs. A TPC uniquely identifies the EAGLE 5 ISS in the network.

Linksets associated with the **ss7ipgw** or **ipgwi** application (IPGWx linksets) must specify an adjacent point code (**apc**) with the **ipgwapc** parameter set to **yes** and the **mtprse** parameter set to **no**. IPGWx linksets must also specify the amount of IP transactions per second (with the **iptps** parameter) the linkset is allowed to use. The sum of the IP transactions per second for all IPGWx linksets cannot exceed the amount of IP transactions per second configured in step 6 with the **enable-ctrl-feat** command. Alarm thresholds for the IP transactions per second for the IPGWx linkset and the signaling links in the IPGWx linkset can also be set. IPGWx linksets can also have a mate IPGWx linkset assigned to it.

Verify that the necessary linksets are in the database with the **rtrv-1s** command. If the necessary linksets are not in the database, add them with the **ent-1s** command or change existing linksets with the **chg-1s** command.

8. The signaling links must be in the database. Verify this with the **rtrv-slk** command. The signaling links are assigned to linksets from step 7, and to IP cards with the **ss7ipgw**, **ipgwi**, **iplim**, or **iplimi** application, from step 2. If the IP card's application is **iplim** or **ss7ipgw**, then the linkset's APC must be an ANSI APC. If the IP card's application is **ipgwi** or **iplimi**, then the linkset's APC can be either an ITU international APC or an ITU national APC. Signaling link ports A1, A2, A3, B1, B2, and B3 can be assigned only to SSEDCCM cards running either the **iplim** or **iplimi** applications.

If the card's application is either the **iplim** or **iplimi**, and the signaling link is assigned to a TALI socket, the **iplim12=saaltali** parameter must be specified for the signaling link. If the signaling link is assigned to a SCTP association, the **iplim12=m2pa** parameter must be specified for the signaling link.

If the necessary links are not in the database, add them with the **ent-slk** command. IPGWx linksets can have only one signaling link if these linksets have a mate assigned to it, or is the mate of another IPGWx linkset. Eight signaling links can be assigned to an IPGWx linkset if the IPGWx linkset is not the mate of another IPGWx linkset, or does not have a mate IPGWx linkset assigned to it.

9. The point codes assigned to each of the IP destinations must also be assigned to an SS7 route. An SS7 route must also be assigned to the linksets containing the adjacent point code. Verify this with the `rtrv-rte` command. If the necessary SS7 routes are not in the database, add them to the database with the `ent-rte` command, specifying a point code assigned to an IP destination, from step 5, and a linkset, from step 7. When setting up SS7 routes to the `ss7ipgw` or `ipgwi` application point codes, the only SS7 route that should be configured for those 'virtual point codes' is the direct route using the `ss7ipgw` or `ipgwi` related linkset.
10. When the IP cards are added to the database in step 2, IP link parameters for the IP cards are assigned default parameter values. These parameter values can be displayed by the `rtrv-ip-lnk` command. These values can be changed with the `chg-ip-lnk` command.
11. Local IP hosts must be in the database. Verify the hosts with the `rtrv-ip-host` command. The IP host associates host names with IP addresses. This connection establishes a relationship between the IP card related information and the socket/association related information. If the necessary IP hosts are not in the database, add them with the `ent-ip-host` command.
12. When the IP cards are added to the database in step 2, there are IP parameters that control the IP stack that are assigned default values. These parameter values can be displayed by the `rtrv-ip-card` command. These values can be changed with the `chg-ip-card` command.
13. Make sure that the application sockets are defined in the database. Verify this with the `rtrv-appl-sock` command. Sockets specify a connection between a local host/TCP port and a remote host/TCP port. If the necessary sockets are not in the database, add them with the `ent-appl-sock` command. A number of socket-related fields in the database are set to default values when the `ent-appl-sock` command is entered. These defaults can be displayed using the `rtrv-appl-sock` command after the `ent-appl-sock` command is executed. These default values can be changed with the `chg-appl-sock` command. IP cards with the `iplim` or `iplimi` application are allowed to have two IP connections (SCTP associations or TALI sockets). IP cards with the `ss7ipgw` or `ipgwi` application are allowed to have up to 50 IP connections (SCTP associations or TALI sockets).
14. Verify the DCM parameter set associated with each socket with the `rtrv-dcmps` command. The DCM parameters can be changed with the `chg-dcmps` command.

NOTE: Set number 10 is a default parameter set and cannot be changed. In order to change the DCM parameters set for a socket using set number 10, use the `chg-appl-sock` command to change the DCM parameter set to a different set number, and then use the `chg-dcmps` command to modify the new set.

15. The SCTP association is defined by the combination of a local host, local SCTP port, remote host and remote SCTP port. The SCTP associations are displayed in the database with the **rtrv-assoc** command. If the necessary associations are not in the database, add them with the **ent-assoc** command. A number of association-related fields in the database are set to default values when the **ent-assoc** command is entered. These defaults can be displayed using the **rtrv-assoc** command after the **ent-assoc** command is executed. These default values can be changed with the **chg-assoc** command.

An SCTP association can be either a multi-homed association or a uni-homed association. A multi-homed association uses both the A and B Ethernet interfaces on the IP card (a single-slot EDCM). One of the Ethernet interfaces on the IP card (for example, Ethernet A) is associated with the local host configured with the **lhost** parameter of the **ent-assoc** or **chg-assoc** command.

The other Ethernet interface on the same IP card (for example, Ethernet B) is associated with an alternate local host configured with the **alhost** parameter of the **ent-assoc** or **chg-assoc** command. The **lhost** and **alhost** parameter values represent the IP addresses associated with both Ethernet interfaces on the IP card.

A uni-homed association uses only one of the Ethernet interfaces on the IP card which is associated with the **lhost** parameter of the **ent-assoc** or **chg-assoc** command. The **alhost** parameter (alternate local host) is not used. The **lhost** parameter value represents the IP address associated with the Ethernet interface being used on the IP card.

Dual-slot EDCM cards with the **iplim** or **iplimi** application are allowed to have two IP connections (SCTP associations or TALI sockets). Single-slot EDCM cards with the **iplim** or **iplimi** application are allowed to have eight IP connections (SCTP associations or TALI sockets). IP cards with the **ss7ipgw** or **ipgwi** application are allowed to have up to 50 IP connections (SCTP associations or TALI sockets).

When an M3UA or SUA association is added to the database, UA parameter set 10 is assigned to the association. There are 10 UA parameter sets that can be assigned to an association, but the UA parameter set assignment can be changed, using the **chg-assoc** command. The values assigned to each UA parameter set can be changed, except for UA parameter set 10, using the **chg-uaps** command.

There are two versions of M2PA associations, RFC and Draft 6, that can be configured in the database. When an M2PA association is added to the database with the **ent-assoc** command, the association is configured as an RFC M2PA association. The RFC version of M2PA timer set 1 is also assigned to the association when the M2PA association is added to the database.

There are two different versions, RFC and Draft 6, of M2PA timer sets that can be assigned to M2PA associations. Each version of the M2PA timer sets contains 20 timer sets. The values of these timer sets can be changed using the **chg-m2pa-tset** command.

The version of the M2PA association can be changed with the **chg-assoc** command. The M2PA timer set assigned to the M2PA association can be changed with the **chg-assoc** command. The M2PA version of the association determines the version of the M2PA timer set that is assigned to the association. For example, if M2PA timer set 3 is assigned to the M2PA association, and the association is an RFC M2PA association, the RFC version of M2PA timer set 3 is used with the association. If M2PA timer set 7 is assigned to the M2PA association, and the association is a Draft 6 M2PA association, the Draft 6 version of M2PA timer set 7 is used with the association.

16. The application server contains a set of one to 16 associations, of which one or more is normally actively processing traffic. The application servers are displayed using the **rtrv-as** command. If the necessary application server is not in the database, add the application server with the **ent-as** command. If the associations assigned to application server are M3UA associations, and the **open** parameter value for these associations is **yes**, then the same UA parameter set must be assigned to all of the application server processes in the application server.
17. If the **ss7ipgw** or **ipgwi** application is to be administered and if static routing keys are desired, make sure that they are defined in the database for each socket or application server related to the **ss7ipgw** or **ipgwi** application. Verify the routing keys with the **rtrv-appl-rtkey** command. Routing keys specify MSU filters for a corresponding socket or application server. If the desired static routing keys are not in the database, add them with the **ent-appl-rtkey** command.
18. If the PSTN presentation data is to be changed for the routing key, the controlled feature associated with the PSTN presentation data must be enabled. The **rtrv-ctrl-feat** command shows whether or not the controlled features are enabled. If any of the required controlled features are not enabled, enter the **enable-ctrl-feat** command with the feature part number and the feature access key for the required controlled feature. The status of these controlled features is set to **on** with the **chg-ctrl-feat** command.

The **ent-pstn-pres** command can be used to define PSTN presentation data, in addition to the values shown in the **rtrv-pstn-pres** output, within either the Tekelec-defined range of PSTN categories, or the user-defined PSTN categories. The ISUP message and parameter database for an ISUP variant, defined by the PSTN presentation data, can be displayed using the **rtrv-isupvar-attrib** command, and changed with the **chg-isupvar-attrib** command. The PSTN presentation data, and ISUP normalization setting, can be changed using the **chg-appl-rtkey** command and is displayed using the **rtrv-appl-rtkey** command.

Steps 4, 6, 17, 18, and 19 are valid only for **ss7ipgw** and **ipgwi** applications.

19. If the IP card is a single-slot EDCM, static IP routes can be provisioned in the database with the **ent-ip-rte** command. The static IP routes are displayed using the **rtrv-ip-rte** command. The static IP routes provide more flexibility in selecting the path to the remote destination and reduces the dependence on default routers.
20. An internal point code can be provisioned to provide routing to an IP end office node. The internal point codes are displayed with the **rtrv-rmt-app1** command. The internal point code value must be in the DPC table, shown in the **rtrv-dstn** output. If the necessary internal point codes are not in the database, add them with the **ent-rmt-app1** command.
21. The network appearance field identifies the SS7 network context for the message, for the purpose of logically separating the signaling traffic between the SGP (signaling gateway process) and the application server over a common SCTP (stream control transmission protocol) association. This field is contained in the DATA, DUNA, DAVA, DRST, DAUD, SCON, and DUPU messages. The network appearances are displayed with the **rtrv-na** command. The internal point code value must be in the DPC table, shown in the **rtrv-dstn** output. If the necessary network appearances are not in the database, add them with the **ent-na** command. If the network appearance contains an ITU-N point code with group codes, the group code must be assigned to a secondary point code shown in the **rtrv-spc** output.

Figure 3-2 shows the relationships of the database elements that are configured in these procedures.

Figure 3-2. IP⁷ Secure Gateway Database Relationships (Sheet 1 of 2)

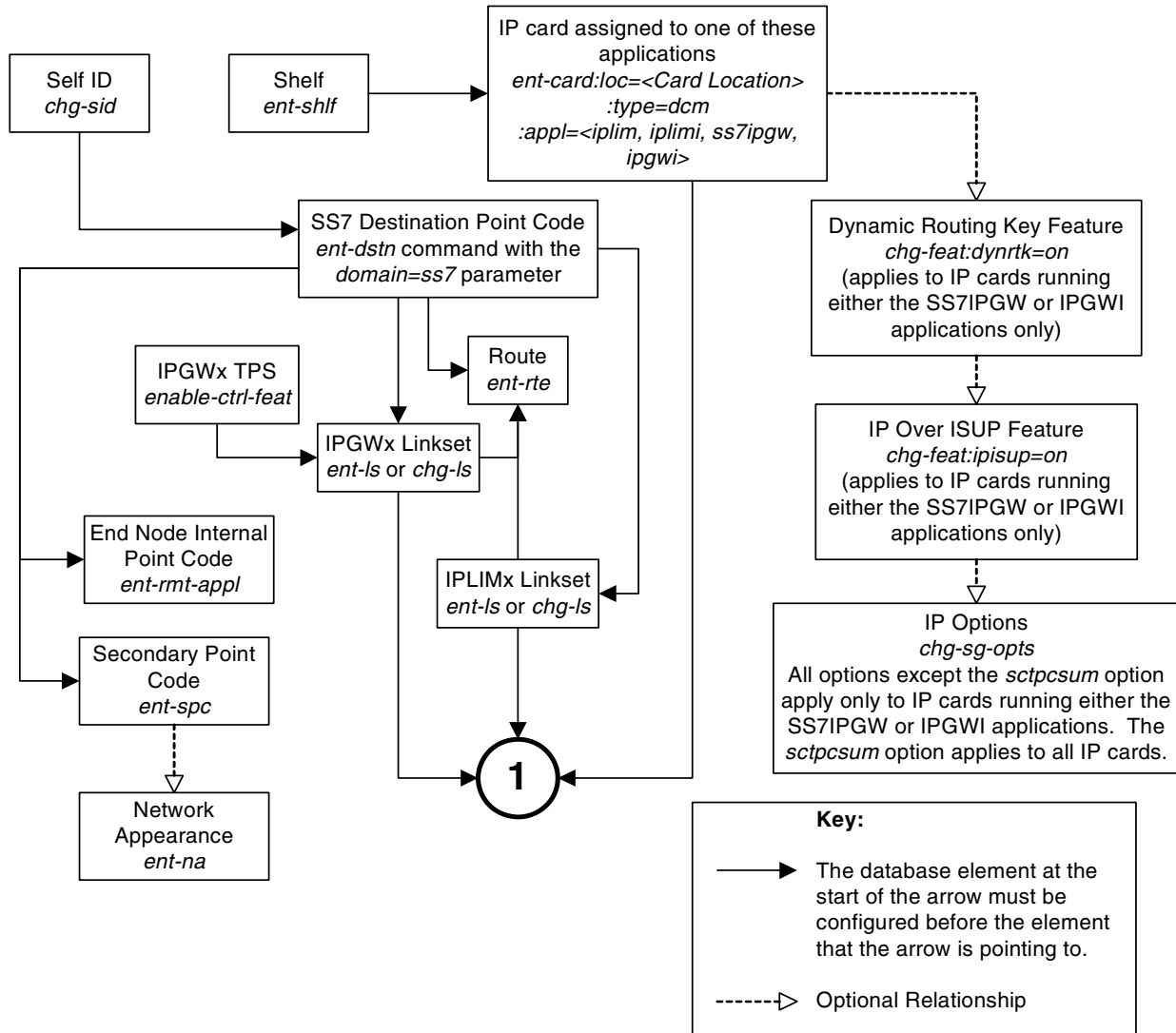

Figure 3-2. IP⁷ Secure Gateway Database Relationships (Sheet 2 of 2)

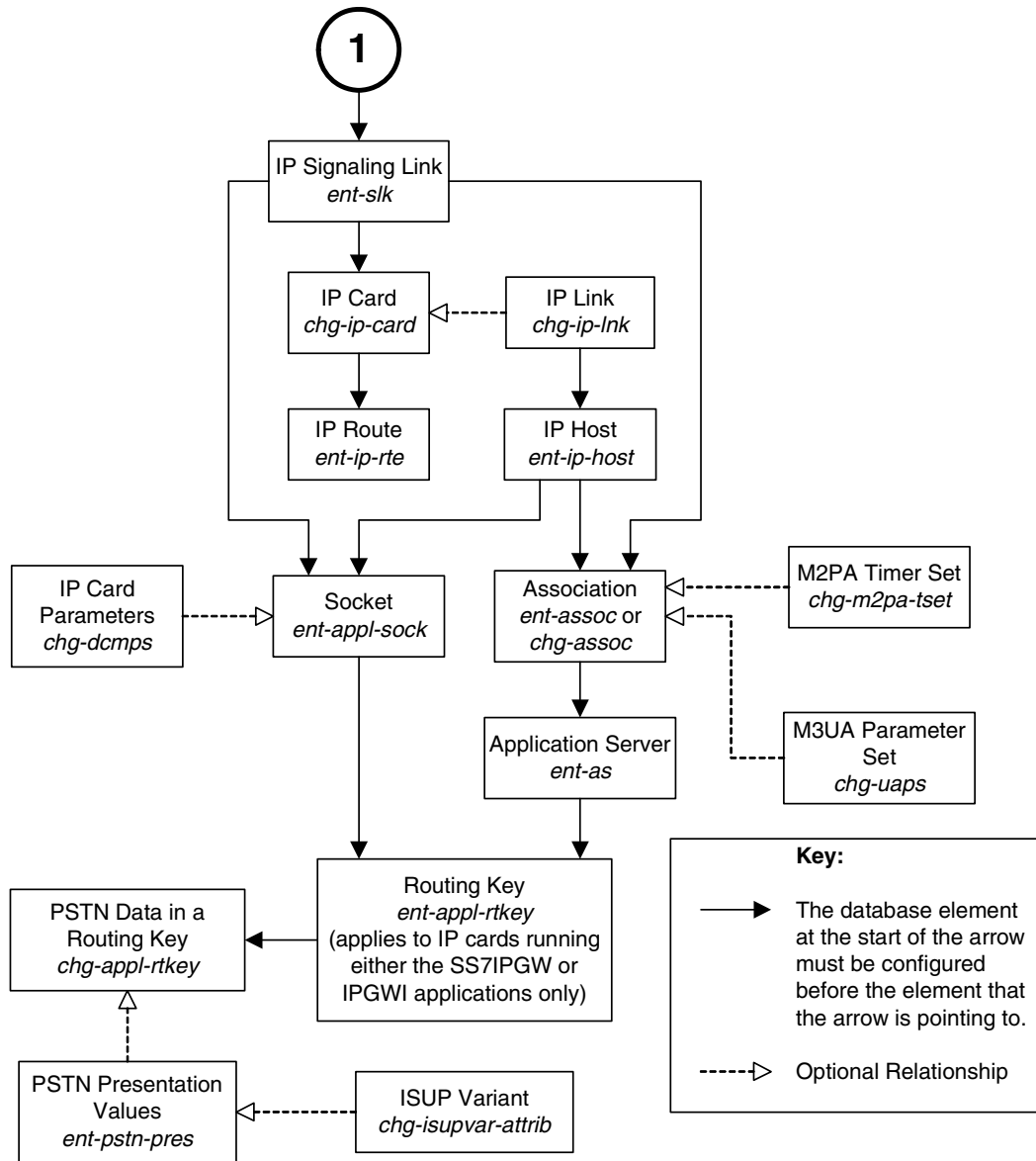
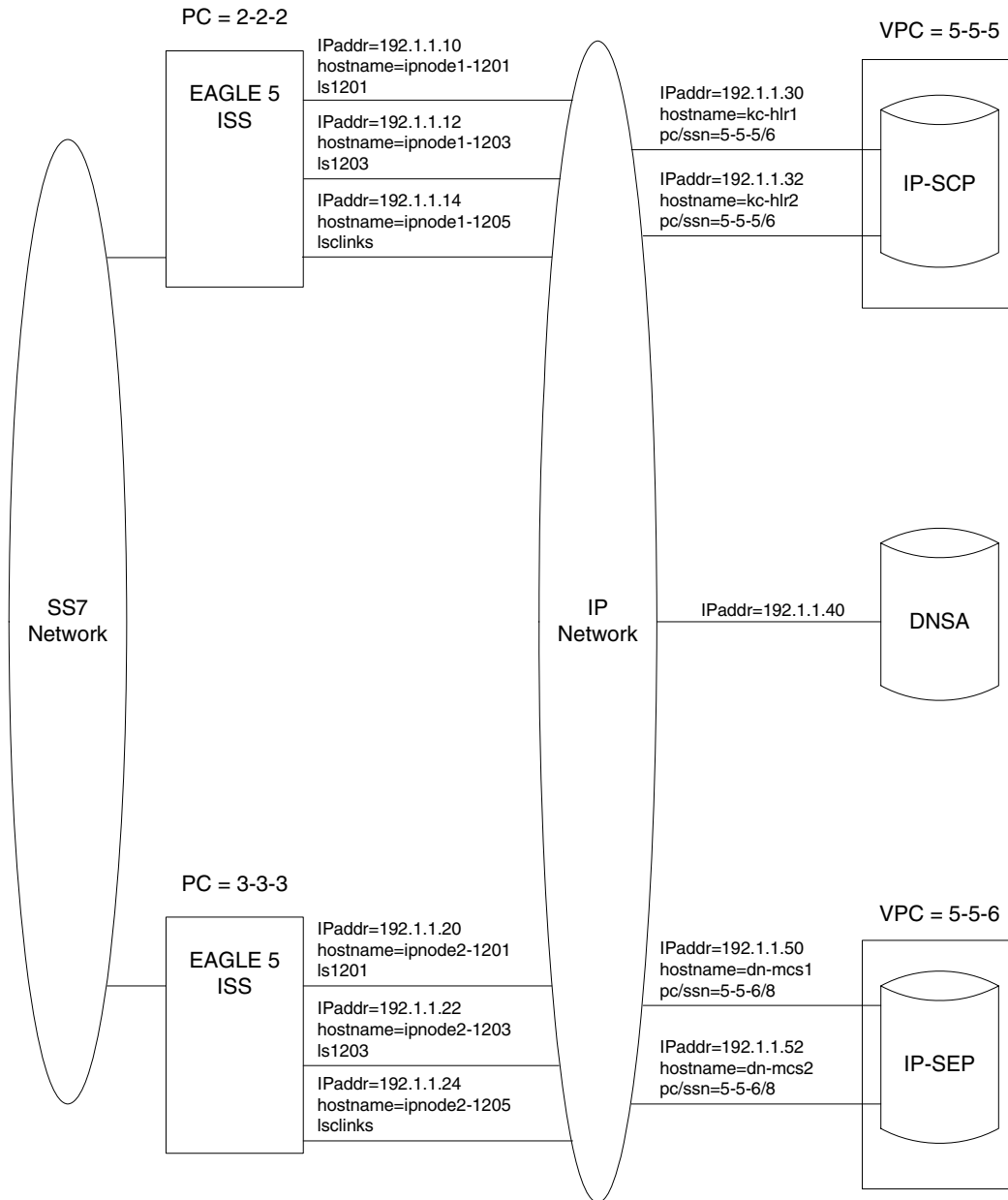

Figure 3-3 shows a typical network configuration and Tables 3-1, 3-2, 3-3 (following Figure 3-3) show the table information that would exist in the EAGLE 5 ISS with point code 2-2-2 after provisioning is completed.

Figure 3-3. Typical Configuration



IP⁷ Secure Gateway Configuration Procedures

Table 3-1. Typical IP Routing

| Destination | SS7 Route | Relative Cost |
|-------------|-----------|---------------|
| 3-3-3 | lsclinks | 10 |
| 5-5-5 | ls1201 | 10 |
| | ls1203 | 10 |
| | lsclinks | 20 |
| 5-5-6 | ls1201 | 10 |
| | ls1203 | 10 |
| | lsclinks | 20 |

Table 3-2. Typical IP Sockets

| Local IP Config | | | Remove IP Config | | Local Socket Information | |
|-----------------|---------------|----------|------------------|----------|--------------------------|-------------------|
| Local Hostname | Client/Server | TCP Port | Hostname | TCP Port | Socket Name | DCM Parameter Set |
| ipnode-1201 | S | 7000 | kc-hlr1 | 7000 | kchlr11201 | 1 |
| | S | 7002 | kc-hlr2 | 7002 | kchlr21201 | 1 |
| | S | 7003 | dn-msc1 | 7003 | dnmsc11201 | 1 |
| | S | 7004 | dn-msc2 | 7004 | dnmsc21201 | 1 |
| ipnode-1203 | S | 7005 | kc-hlr1 | 7005 | kchlr11203 | 1 |
| | S | 7006 | kc-hlr2 | 7006 | kchlr21203 | 1 |
| | S | 7007 | dn-msc1 | 7007 | dnmsc11203 | 1 |
| | S | 7008 | dn-msc2 | 7008 | dnmsc21203 | 1 |
| ipnode1-1204 | S | 7009 | lp-msg1 | 7009 | lpmsg11204 | 1 |
| | S | 7010 | lp-msg2 | 7010 | lpmsg21204 | 1 |
| | S | 7011 | lp-msg3 | 7011 | lpmsg31204 | 1 |
| ipnode1-1205 | S | 7012 | lp-msg1 | 7012 | lpmsg11205 | 1 |
| | S | 7013 | lp-msg2 | 7013 | lpmsg21205 | 1 |
| | S | 7014 | lp-msg3 | 7014 | lpmsg31205 | 1 |
| ipnode1-1206 | C | 7001 | ipnode2 | 7001 | ipnode21206 | 1 |

Table 3-3. Typical IP Routing Keys (SS7IPGW and IPGWI Applications)

| SS7 Routing Keys | | | | | | IP Sockets that carry traffic for that Routing Key |
|------------------|--------|---------|---------|-----------|---------|--|
| SS7 DPC | SS7 SI | SS7 SSN | SS7 OPC | CIC Start | CIC End | Socket Name |
| 5-5-5 | 3 | 6 | - | - | - | kchlr11201 kchlr21201 kchlr11203 kchlr21203 |
| 5-5-6 | 5 | - | 4-4-4 | 1 | 100 | dnmsc11201 dnmsc21201 dnmsc11203 dnmsc21203 |
| 1-44-2 | 4 | - | 2-5-1 | 3948 | 3948 | lpmsg11205 lpmsg21205 lpmsg31205 |
| 4346 | 13 | - | 5834 | 48486 | 48486 | lpmsg11204 lpmsg21204 lpmsg31204 |

Adding an IP Card

This procedure is used to add an IP card to the database using the **ent-card** command. The IP card is a Database Communications Module (DCM) or a single-slot Enhanced-Performance Database Communications Module (EDCM) and may not be in the database. The shelf to which the card is to be added, must be in the database.

The **ent-card** command uses these parameters.

- :loc** – The location of the card being added to the database.
- :type** – The type of card being added to the database.
- :appl** – The application software or GPL that is assigned to the card.

Table 3-4 shows the valid card type and card applications (**appl**) for the **ent-card** command in this procedure. The table also shows the card's part number and the maximum number of cards that the database can contain.

Table 3-4. Card Type and Card Applications

| Card Name | Card Type (:type) | Application Type (:appl) | Network Type | Maximum Number of Cards in the Database |
|---|-------------------|------------------------------|--------------|---|
| Dual-Slot DCM (870-1945-xx or 870-1984-01) † | dcm | iplim/iplmi ss7ipgw/ipgwi | ANSI/ITU | 100 |
| Single-Slot EDCM (870-2372-01 or 870-2372-13) | | | ANSI/ITU | 64 * |
| E5-ENET (870-2212-xx) | | | | |
| * The EAGLE 5 ISS may contain a maximum of 64 single-slot EDCMs or E5-ENET cards running either the ss7ipgw or ipgwi application, or combinations of the ss7ipgw and ipgwi applications. If dual-slot DCMs are present in the EAGLE 5 ISS, there can be a maximum of 2 cards running the ss7ipgw application and 2 cards running the ipgwi application. † The dual-slot DCM is not supported if the Origin-Based MTP Routing feature is enabled. | | | | |

:force – If the global title translation feature is on, the **force=yes** parameter allows the LIM to be added to the database even if the current SCCP transactions-per-second threshold is unable to support the additional SCCP transaction-per-second capacity created by adding the IP card. This parameter is obsolete and is no longer used.

If the card application is **ss7ipgw** or **ipgwi** and you have purchased the ISUP-over-IP (**ipisup**) feature or the Dynamic Routing Key (**dynrtk**) feature, verify that the appropriate feature is turned on (**ipisup=on** or **dynrtk=on**) using the **rtrv-feat** command. If the appropriate feature is off, turn it on with the

chg-feat command. For more information on these features, refer to section “Understanding Routing for SS7IPGW and IPGWI Applications” on page 2-25.

NOTE: Before turning on the ISUP-over-IP feature (**ipisup**) or the Dynamic Routing Key feature, make sure you have purchased these features. If you are not sure whether you have purchased the ISUP-over-IP feature or the Dynamic Routing Key feature, contact your Tekelec Sales Representative or Account Representative. Once a feature has been turned on with the **chg-feat** command, the feature cannot be turned off.

Card Slot Selection

The dual-slot DCM occupies two card slots and can be inserted any card slot in the extension shelf except slots 08 and 18. The dual-slot DCM card requires that the next adjacent slot be empty and not provisioned in the database. For example, if dual-slot DCM cards are inserted into slots 03 and 06, slots 04 and 07 must be empty and not provisioned in the database. Because slots 09 and 10 contain the HMUX cards or HIPR cards, the dual-slot DCM card cannot be inserted into slots 08, 09, or 10. Slot 18 cannot be used because it is the last slot in the shelf. The dual-slot DCM card can be inserted in the control shelf, but only in slots 01 through 07, and 11, following the same rules as the extension shelf. Slots 1113 through 1118 are reserved for MASPs A and B and the MDAL card.

The single-slot EDCM and E5-ENET card can be inserted into any card slot, except for card slots that must remain empty to accommodate dual-slot cards, slots 09 and 10 in each shelf, and slots 1113 through 1118.

To provision a E5-ENET card, the shelf containing the E5-ENET card must have HIPR cards installed in slots 9 and 10 in that shelf. If HIPR cards are not installed in the shelf that the E5-ENET card will occupy, the E5-ENET card will be auto-inhibited when the E5-ENET card is inserted into the shelf. Enter the **rept-stat-gpl:gpl=hipr** command to verify whether or not HIPR cards are installed in the same shelf as the E5-ENET card being provisioned in this procedure.

The examples in this procedure are used to add the cards shown in Table 3-5 to the database.

Table 3-5. Example Card Configuration

| Card Type | Application | Card Location |
|--------------------------------------|-------------|---------------|
| dcm | iplim | 1202* |
| dcm | iplimi | 1308* |
| dcm | iplim | 1311 |
| dcm | iplimi | 1313 |
| dcm | ss7ipgw | 1315 |
| dcm | ipgwi | 1317 |
| * These cards are single-slot EDCMs. | | |

Procedure

1. Display the cards in the database using the `rtrv-card` command. This is an example of the possible output. Cards should be distributed throughout the EAGLE 5 ISS for proper power distribution. Refer to the *Installation Manual - EAGLE 5 ISS* for the shelf power distribution.

```
rlghncxa03w 06-10-28 09:12:36 GMT EAGLE5 36.0.0
CARD  TYPE      APPL      LSET NAME      LINK SLC LSET NAME      LINK SLC
1101  TSM          SCCP
1102  TSM          GLS
1113  GSPM         EOAM
1114  TDM-A
1115  GSPM         EOAM
1116  TDM-B
1117  MDAL
1201  LIMDS0      SS7ANSI    sp2            A    0    sp1            B    0
1203  LIMDS0      SS7ANSI    sp3            A    0
1204  LIMDS0      SS7ANSI    sp3            A    1
1206  LIMDS0      SS7ANSI    nsp3           A    1    nsp4           B    1
1207  LIMV35      SS7GX25    nsp1           A    0
1208  LIMV35      SS7GX25    nsp1           A    1
1216  ACMENET     STPLAN
1301  LIMDS0      SS7ANSI    sp6            A    1    sp7            B    0
1302  LIMDS0      SS7ANSI    sp7            A    1    sp5            B    1
1303  DCM         IPLIM      ipnode1        A    0    ipnode3        B    1
1305  DCM         IPLIM      ipnode4        A    0
1307  ACMENET     STPLAN
```

2. Verify that the card to be entered has been physically installed into the proper location (see the Card Slot Selection section on page 3-18).



CAUTION: If the version of the BPDCM GPL on the IP card does not match the BPDCM GPL version in the database when the IP card is inserted into the card slot, UAM 0002 is generated indicating that these GPL versions do not match. If UAM 0002 has been generated, perform the alarm clearing procedure for UAM 0002 in the *Maintenance Manual* before proceeding with this procedure.

NOTE: If the card being added in this procedure is not an E5-ENET card, skip step 3 and go to step 4.

3. Verify that HIPR cards are installed in card locations 9 and 10 in the shelf containing the E5-ENET card being added in this procedure. Enter this command.

```
rept-stat-gpl:gpl=hipr
```

This is an example of the possible output.

```
rlghncxa03w 06-10-01 11:40:26 GMT EAGLE5 36.0.0
GPL          CARD          RUNNING          APPROVED          TRIAL
HIPR         1109          125-002-000     125-002-000     125-003-000
HIPR         1110          125-002-000     125-002-000     125-003-000
HIPR         1209          125-002-000     125-002-000     125-003-000
HIPR         1210          125-002-000     125-002-000     125-003-000
HIPR         1309          125-002-000     125-002-000     125-003-000
HIPR         1310          125-002-000     125-002-000     125-003-000
HIPR         2109          125-002-000     125-002-000     125-003-000
HIPR         2110          125-002-000     125-002-000     125-003-000
Command Completed
```

If HIPR cards are installed in the shelf containing the E5-ENET card, go to step 4.

If HIPR cards are not installed on the shelf containing the E5-ENET card, go to the *Installation Manual - EAGLE 5 ISS* and install the HIPR cards. Once the HIPR cards have been installed, go to step 4.

NOTE: If the application being assigned to the card is either IPLIM or IPLIMI, skip steps 4 and 5, and go to step 6.

4. If the ISUP-over-IP (`ipisup`) feature or the Dynamic Routing Key (`dynrtk`) feature are to be used, verify that these features are on by entering the `rtrv-feat` command. If the ISUP-over-IP feature is on, the `ipisup` field is set to `on`. If the Dynamic Routing Key feature is on, the `dynrtk` field is set to `on`.

NOTE: The `rtrv-feat` command output contains other fields that are not used by this procedure. If you wish to see all the fields displayed by the `rtrv-feat` command, see the `rtrv-feat` command description in the *Commands Manual*.

NOTE: If the features you wish to use are already on, skip this step and go to step 6.

5. Turn the ISUP-over-IP or Dynamic Routing Key features by entering one of these commands, depending of which features are already on, and which ones you wish to turn on.

To enable the ISUP-over-IP feature, enter this command.

```
chg-feat:ipisup=on
```

To enable the Dynamic Routing Key feature, enter this command.

```
chg-feat:dynrtk=on
```

To enable both features, enter this command.

```
chg-feat:ipisup=on:dynrtnk=on
```

NOTE: Once the ISUP-over-IP feature or Dynamic Routing Key features are turned on with the `chg-feat` command, they cannot be turned off.

NOTE: The ISUP-over-IP feature and Dynamic Routing Key features must be purchased before turning them on. If you are not sure whether you have purchased the ISUP-over-IP feature or Dynamic Routing Key features, contact your Tekelec Sales Representative or Account Representative.

When this command has successfully completed, this message should appear.

```
rlghncxa03w 06-10-12 09:12:36 GMT EAGLE5 36.0.0
CHG-FEAT: MASP A - COMPLTD
```

6. Add the card using the `ent-card` command. For this example, enter these commands.

```
ent-card:loc=1202:type=dcm:appl=iplim
ent-card:loc=1308:type=dcm:appl=iplim
ent-card:loc=1311:type=dcm:appl=iplim
ent-card:loc=1313:type=dcm:appl=iplimi
ent-card:loc=1315:type=dcm:appl=ss7ipgw
ent-card:loc=1317:type=dcm:appl=ipgwi
```

When each of these commands have successfully completed, this message should appear.

```
rlghncxa03w 06-10-12 09:12:36 GMT EAGLE5 36.0.0
ENT-CARD: MASP A - COMPLTD
```

7. Verify the changes using the `rtrv-card` command with the card location specified in step 6. For this example, enter these commands.

```
rtrv-card:loc=1202
```

This is an example of the possible output.

```
rlghncxa03w 06-10-28 09:12:36 GMT EAGLE5 36.0.0
CARD  TYPE      APPL      LSET NAME      LINK SLC LSET NAME      LINK SLC
1202  DCM          IPLIM
```

```
rtrv-card:loc=1308
```

This is an example of the possible output.

```
rlghncxa03w 06-10-28 09:12:36 GMT EAGLE5 36.0.0
CARD  TYPE      APPL      LSET NAME      LINK SLC LSET NAME      LINK SLC
1308  DCM          IPLIM
```

```
rtrv-card:loc=1311
```

This is an example of the possible output.

```
rlghncxa03w 06-10-28 09:12:36 GMT EAGLE5 36.0.0
CARD  TYPE      APPL      LSET NAME      LINK SLC LSET NAME      LINK SLC
1311  DCM          IPLIM
```

rtrv-card:loc=1313

This is an example of the possible output.

```
rlghncxa03w 06-10-28 09:12:36 GMT EAGLE5 36.0.0
CARD   TYPE      APPL      LSET NAME      LINK SLC LSET NAME      LINK SLC
1313   DCM        IPLIMI
```

rtrv-card:loc=1315

This is an example of the possible output.

```
rlghncxa03w 06-10-28 09:12:36 GMT EAGLE5 36.0.0
CARD   TYPE      APPL      LSET NAME      LINK SLC LSET NAME      LINK SLC
1315   DCM        SS7IPGW
```

rtrv-card:loc=1317

This is an example of the possible output.

```
rlghncxa03w 06-10-28 09:12:36 GMT EAGLE5 36.0.0
CARD   TYPE      APPL      LSET NAME      LINK SLC LSET NAME      LINK SLC
1317   DCM        IPGWI
```

8. Back up the new changes using the **chg-db:action=backup:dest=fixed** command. These messages should appear, the active Maintenance and Administration Subsystem Processor (MASP) appears first.

```
BACKUP (FIXED) : MASP A - Backup starts on active MASP.
BACKUP (FIXED) : MASP A - Backup on active MASP to fixed disk complete.
BACKUP (FIXED) : MASP A - Backup starts on standby MASP.
BACKUP (FIXED) : MASP A - Backup on standby MASP to fixed disk complete.
```

9. If you wish to change the quantity of static and dynamic routing keys in the database, perform the "Changing IP Options other than SYNC and SCTPCSUM" procedure on page 3-130. Otherwise, this procedure is finished.

Flowchart 3-1. Adding an IP Card (Sheet 1 of 5)

NOTE: Before executing this procedure, make sure you have purchased the ISUP-over-IP feature and Dynamic Routing Key features. If you are not sure whether you have purchased the ISUP-over-IP feature or Dynamic Routing Key features, contact your Tekelec Sales Representative or Account Representative.

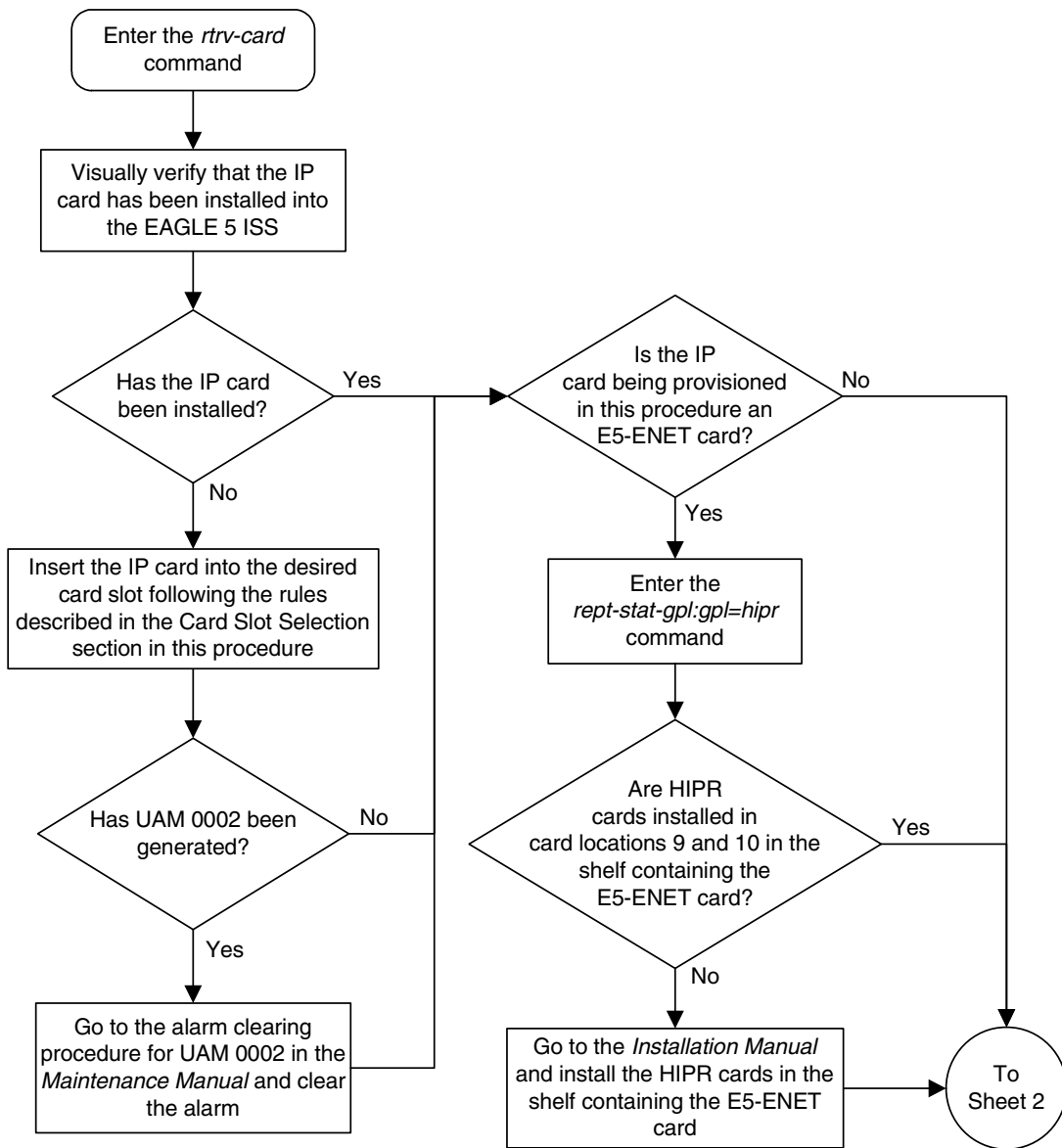

Flowchart 3-1. Adding an IP Card (Sheet 2 of 5)

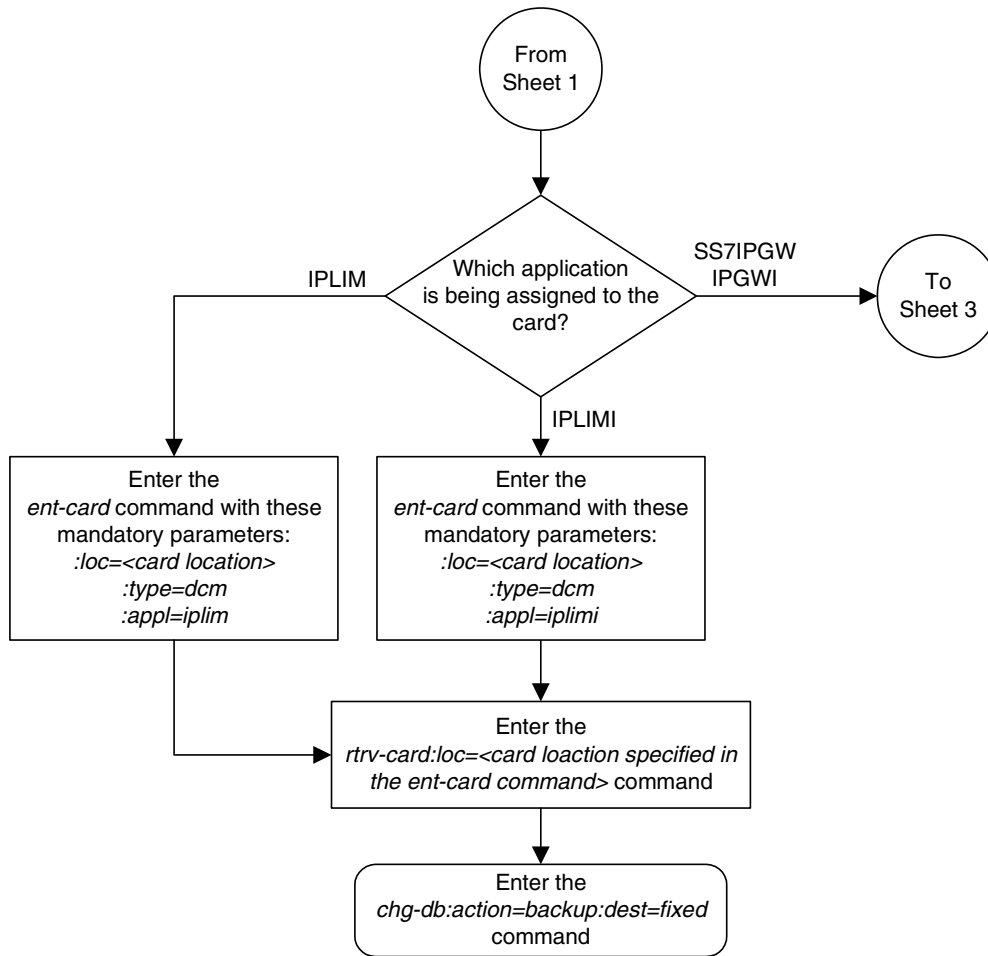

Flowchart 3-1. Adding an IP Card (Sheet 3 of 5)

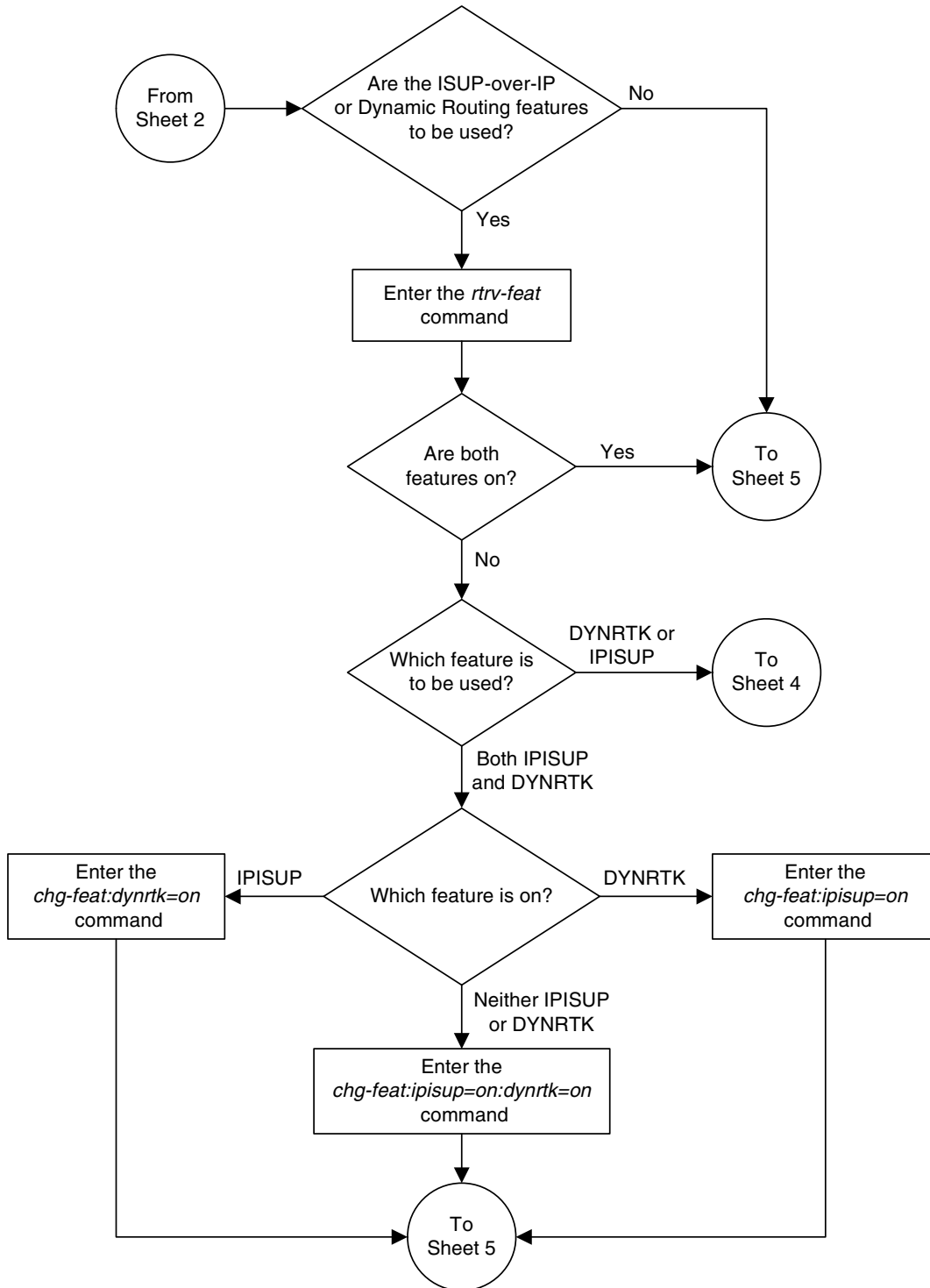

Flowchart 3-1. Adding an IP Card (Sheet 4 of 5)

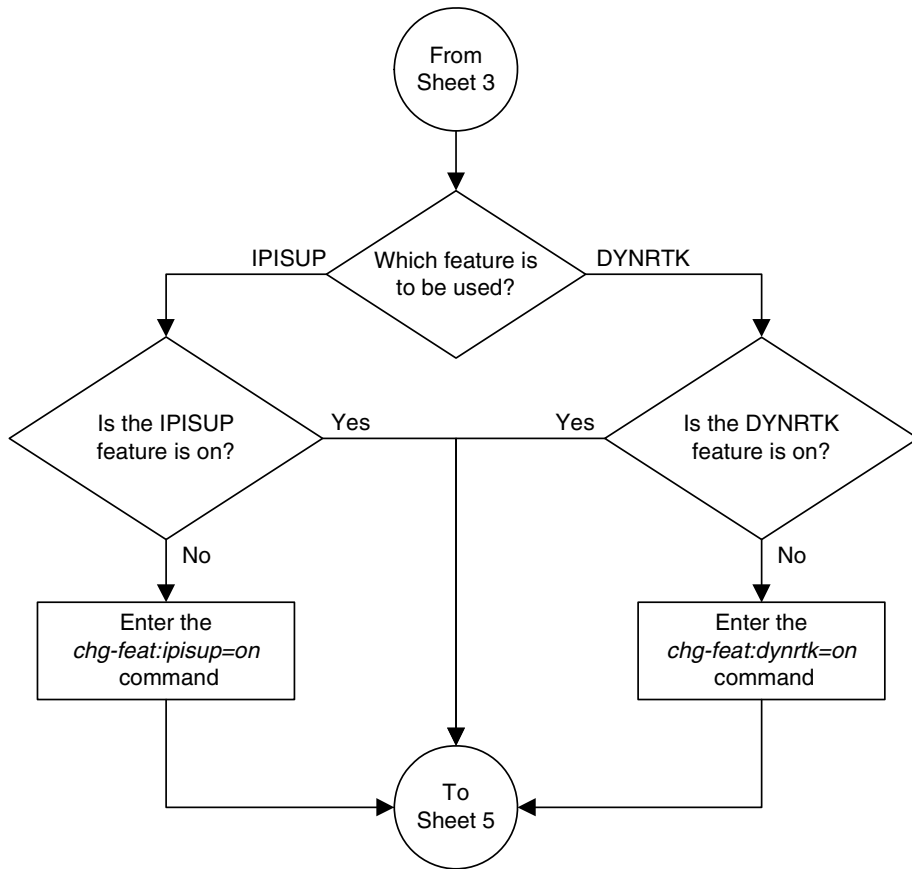

Flowchart 3-1. Adding an IP Card (Sheet 5 of 5)

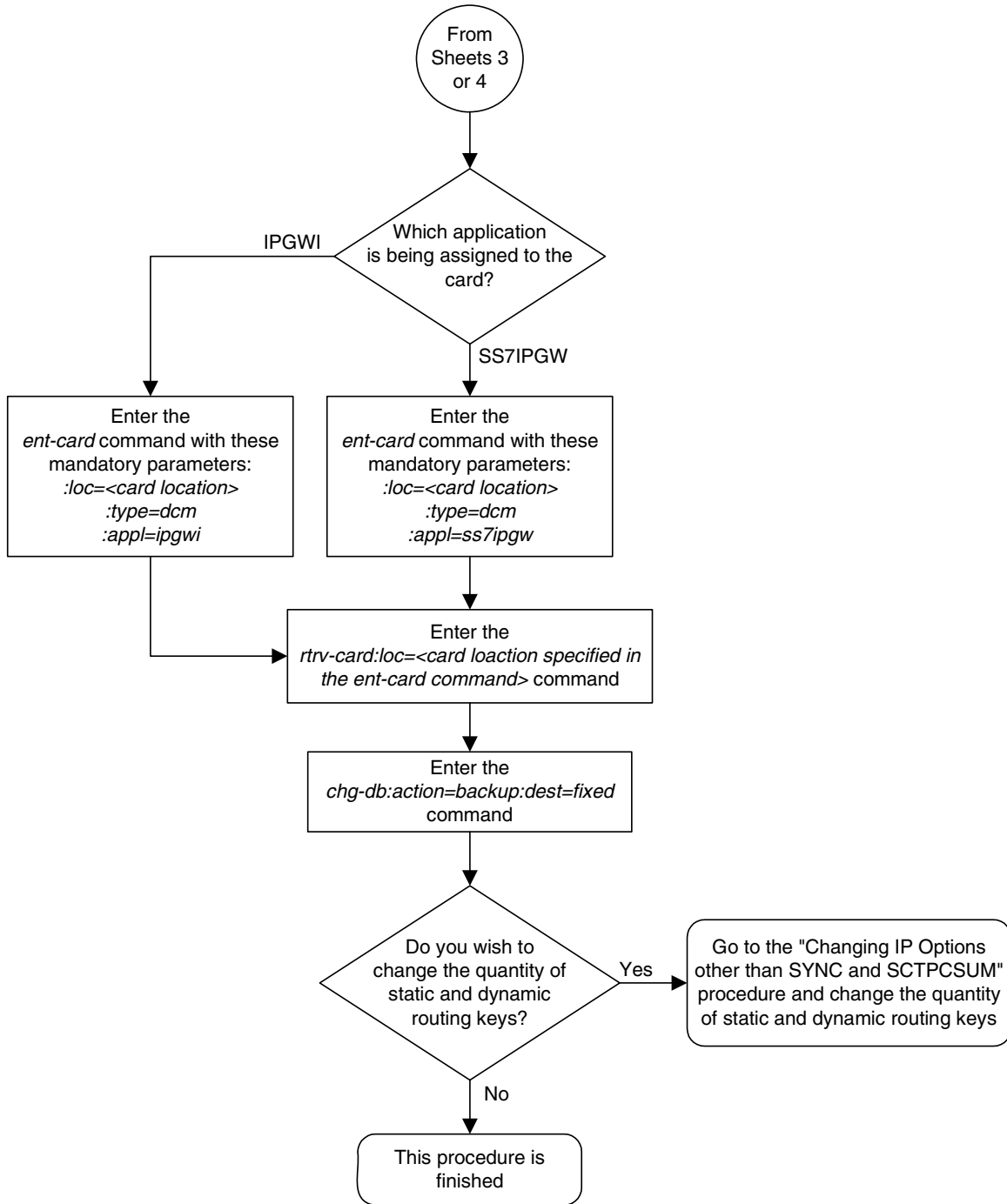

Removing an IP Card

Use this procedure to remove an IP card, a card running one of these applications: **iplim**, **iplimi**, **ss7ipgw**, **ipgwi**, from the database using the **dlt-card** command.

The card cannot be removed if it does not exist in the database. Prior to removing the card from the database, the signaling links assigned to the card must be removed.



CAUTION: If the IP card is the last IP card in service, removing this card from the database will cause traffic to be lost.

Procedure

1. Display the cards in the database using the **rtrv-card** command. This is an example of the possible output.

```
rlghncxa03w 06-10-15 16:34:56 GMT EAGLE5 36.0.0
CARD  TYPE      APPL      LSET NAME      LINK SLC LSET NAME      LINK SLC
1101  TSM          SCCP
1102  TSM          GLS
1104  ACMENET     STPLAN
1113  GSPM        EOAM
1114  TDM-A
1115  GSPM        EOAM
1116  TDM-B
1117  MDAL
1201  LIMDS0     SS7ANSI   lsn1           A    0    lsn2           B    1
1202  LIMV35     SS7GX25  lsnngwy        A    0
1203  LIMV35     SS7ANSI   lsn2           A    0    lsn1           B    1
1204  LIMATM     ATMANSI   atmgwy         A    0
1205  DCM        IPLIM     ipnode1        A    0    ipnode3        B    1
1207  DCM        IPLIM     ipnode2        A    0
1303  DCM        IPLIM     ipnode1        A    0    ipnode3        B    1
1305  DCM        IPLIM     ipnode4        A    0
```

Determine the cards to be removed from the database. The examples in this procedure are used to remove the IP cards in card locations 1205 and 1207.

The card location is shown in the **CARD** field of the **rtrv-card** command output. No entries in the **LSET NAME**, **LINK**, and **SLC** columns mean that no signaling link has been assigned to the card.

2. Display the status of the SS7 signaling links assigned to the IP cards you wish to remove. Enter the **rept-stat-slk** command and specify the card location (**CARD** column) and signaling link (**LINK** column) shown in step 1. The status of the signaling link is indicated in the PST field.

For this example, enter the following commands:

```
rept-stat-slk:loc=1205:link=a
```

This is an example of the possible output.

```
rlghncxa03w 06-10-28 09:12:36 GMT EAGLE5 36.0.0
SLK      LSN      CLLI      PST      SST      AST
1205,A   ipnode1   -----  IS-NR    Avail    ----
  ALARM STATUS      = No Alarms.
  UNAVAIL REASON    = --
Command Completed.
```

```
rept-stat-slk:loc=1205:link=b
```

This is an example of the possible output.

```
rlghncxa03w 06-10-28 09:12:36 GMT EAGLE5 36.0.0
SLK      LSN      CLLI      PST      SST      AST
1205,B   ipnode3   -----  IS-NR    Avail    ----
  ALARM STATUS      = No Alarms.
  UNAVAIL REASON    = --
Command Completed.
```

```
rept-stat-slk:loc=1207:link=a
```

This is an example of the possible output.

```
rlghncxa03w 06-10-28 09:12:36 GMT EAGLE5 36.0.0
SLK      LSN      CLLI      PST      SST      AST
1207,A   ipnode2   -----  IS-NR    Avail    ----
  ALARM STATUS      = No Alarms.
  UNAVAIL REASON    = --
Command Completed.
```

If the signaling link status is in-service normal (IS-NR), go to step 3.

If the signaling link status is out-of-service maintenance-disabled (OOS-MT-DSBLD), go to step 4.

3. Deactivate any links shown in step 2 whose state is not OOS-MT-DSBLD using the **dact-slk** command. For this example, enter these commands.

```
dact-slk:loc=1205:link=a
```

```
dact-slk:loc=1205:link=b
```

```
dact-slk:loc=1207:link=a
```

When these commands have successfully completed, this message appears.

```
rlghncxa03w 06-10-12 09:12:36 GMT EAGLE5 36.0.0
Deactivate Link message sent to card
```

- Verify the new link status. Enter the **rept-stat-slk** command and specify card location and the signaling link. The status of the signaling link is indicated in the **PST** field.

For this example, enter the following commands:

rept-stat-slk:loc=1205:link=a

This is an example of the possible output.

```
rlghncxa03w 06-10-28 09:12:36 GMT EAGLE5 36.0.0
SLK      LSN      CLLI      PST      SST      AST
1205,A  ipnode1  -----  OOS-MT-DSBLD Avail  ----
        ALARM STATUS      = * 0236 REPT-LKS:not aligned.
        UNAVAIL REASON    = NA
Command Completed.
```

rept-stat-slk:loc=1205:link=b

This is an example of the possible output.

```
rlghncxa03w 06-10-28 09:12:36 GMT EAGLE5 36.0.0
SLK      LSN      CLLI      PST      SST      AST
1205,B  ipnode3  -----  OOS-MT-DSBLD Avail  ----
        ALARM STATUS      = * 0236 REPT-LKS:not aligned.
        UNAVAIL REASON    = NA
Command Completed.
```

rept-stat-slk:loc=1207:link=a

This is an example of the possible output.

```
rlghncxa03w 06-10-28 09:12:36 GMT EAGLE5 36.0.0
SLK      LSN      CLLI      PST      SST      AST
1207,A  ipnode2  -----  OOS-MT-DSBLD Avail  ----
        ALARM STATUS      = * 0236 REPT-LKS:not aligned.
        UNAVAIL REASON    = NA
Command Completed.
```

- Display the cards that are in service with the **rept-stat-card:stat=nr** command. For this example, enter the following command.

rept-stat-card:stat=nr

This is an example of the possible output.

```
rlghncxa03w 06-10-27 16:43:42 GMT EAGLE5 36.0.0
CARD  VERSION      TYPE  APPL  PST      SST      AST
1101  114-003-000  TSM   SCCP  IS-NR    Active  ---
1102  114-003-000  TSM   GLS   IS-NR    Active  ---
1103  114-002-000  ACMENET STPLAN IS-NR    Active  ---
1109  114-003-000  HMUX  BPHMUX IS-NR    Active  ---
1110  114-003-000  HMUX  BPHMUX IS-NR    Active  ---
1113  114-002-000  GPSM  EOAM   IS-NR    Active  ---
1114  -----      TDM           IS-NR    Active  ---
1115  114-002-000  GPSM  EOAM   IS-NR    Active  ---
1116  -----      TDM           IS-NR    Active  ---
1117  -----      MDAL           IS-NR    Active  ---
1201  114-003-000  LIMDS0 SS7ANSI IS-NR    Active  ---
1202  114-002-000  LIMV35 SS7GX25 IS-NR    Active  ---
1203  114-003-000  LIMV35 SS7ANSI IS-NR    Active  ---
1204  114-003-000  LIMATM ATMANSI IS-NR    Active  ---
1205  114-001-000  DCM   IPLIM  IS-NR    Active  ---
1207  114-001-000  DCM   IPLIM  IS-NR    Active  ---
1209  114-003-000  HMUX  BPHMUX IS-NR    Active  ---
1210  114-003-000  HMUX  BPHMUX IS-NR    Active  ---
```

IP7 Secure Gateway Configuration Procedures

| | | | | | | |
|------|-------------|------|--------|-------|--------|-----|
| 1303 | 114-001-000 | DCM | IPLIM | IS-NR | Active | --- |
| 1305 | 114-001-000 | DCM | IPLIM | IS-NR | Active | --- |
| 1309 | 114-003-000 | HMUX | BPHMUX | IS-NR | Active | --- |
| 1310 | 114-003-000 | HMUX | BPHMUX | IS-NR | Active | --- |

6. If the signaling link assigned to the card to be removed from the database is the last signaling link in a linkset, the **force=yes** parameter must be used when deleting the link with the **dlt-slk** command. Verify the number of links in the linkset using the **rtrv-ls** command and specifying the linkset name (shown in step 1 in the **LSET NAME** field) for the respective link. For this example, enter the following commands.

```
rtrv-ls:lsn=ipnode1
```

This is an example of the possible output

```
rlghncxa03w 06-10-28 16:31:35 GMT EAGLE5 36.0.0
                                L3T SLT                                GWS GWS GWS
LSN          APCA  (SS7)  SCRN  SET SET BEI LST LNKS ACT MES DIS SLSCI NIS
ipnode1      240-020-000  scr1  1  1  yes A  2  off off off yes  off

                                IPGWAPC MATELSN          IPTPS LSUSEALM SLKUSEALM GTTMODE
                                no          -----          ---  ---          ---          CdPA

                                LOC  LINK SLC TYPE          L2T          L1          PCR PCR
                                SET  BPS          MODE TSET  ECM  N1  N2

                                LOC  LINK SLC TYPE          LP          ATM          VCI  VPI  LL
                                SET  BPS          TSEL          VCI  VPI  LL

                                LOC  LINK SLC TYPE          LP          ATM          VCI  VPI  CRC4 SI SN
                                SET  BPS          TSEL          VCI  VPI  CRC4 SI SN

                                LOC  LINK SLC TYPE          IPLIML2
                                1205 A    0  IPLIM  SAALTALI
                                1303 A    0  IPLIM  SAALTALI

                                LOC  LINK SLC TYPE

                                LOC  LINK SLC TYPE          L2T          PCR PCR  E1  E1
                                SET  BPS          ECM  N1  N2  LOC  PORT TS

                                LOC  LINK SLC TYPE          L2T          PCR PCR  T1  T1
                                SET  BPS          ECM  N1  N2  LOC  PORT TS

Link set table is ( 10 of 1024) 1% full
;
```

```
rtrv-ls:lsn=ipnode2
```

This is an example of the possible output

```
rlghncxa03w 06-10-28 16:31:35 GMT EAGLE5 36.0.0
                                L3T SLT                                GWS GWS GWS
LSN          APCA  (SS7)  SCRN  SET SET BEI LST LNKS ACT MES DIS SLSCI NIS
ipnode2      240-030-000  scr1  1  1  yes A  2  off off off yes  off

                                IPGWAPC MATELSN          IPTPS LSUSEALM SLKUSEALM GTTMODE
                                no          -----          ---  ---          ---          CdPA
```

IP⁷ Secure Gateway Configuration Procedures

```

LOC LINK SLC TYPE          L2T          L1          PCR PCR
SET BPS          MODE TSET  ECM  N1  N2

LOC LINK SLC TYPE          LP          ATM
SET BPS          TSEL          VCI  VPI  LL

LOC LINK SLC TYPE          LP          ATM          E1ATM
SET BPS          TSEL          VCI  VPI  CRC4 SI SN

LOC LINK SLC TYPE          IPLIML2
1207 A          0  IPLIM  SAALTALI

LOC LINK SLC TYPE

LOC LINK SLC TYPE          L2T          PCR PCR  E1  E1
SET BPS          ECM  N1  N2  LOC  PORT TS

LOC LINK SLC TYPE          L2T          PCR PCR  T1  T1
SET BPS          ECM  N1  N2  LOC  PORT TS

```

Link set table is (10 of 1024) 1% full

rtrv-ls:lsn=ipnode3

This is an example of the possible output

```

rlghncxa03w 06-10-28 16:31:35 GMT EAGLE5 36.0.0
                                L3T SLT          GWS GWS GWS
LSN          APCA  (SS7)  SCRN  SET SET BEI LST LNKS ACT MES DIS SLSCI NIS
ipnode3      240-020-000  scr1  1  1  yes A  2  off off off yes  off

IPGWAPC MATELSN  IPTPS LSUSEALM SLKUSEALM GTTMODE
no          -----  ---  ---  ---  CdPA

LOC LINK SLC TYPE          L2T          L1          PCR PCR
SET BPS          MODE TSET  ECM  N1  N2

LOC LINK SLC TYPE          LP          ATM
SET BPS          TSEL          VCI  VPI  LL

LOC LINK SLC TYPE          LP          ATM          E1ATM
SET BPS          TSEL          VCI  VPI  CRC4 SI SN

LOC LINK SLC TYPE          IPLIML2
1205 A          0  IPLIM  SAALTALI
1303 A          0  IPLIM  SAALTALI

LOC LINK SLC TYPE

LOC LINK SLC TYPE          L2T          PCR PCR  E1  E1
SET BPS          ECM  N1  N2  LOC  PORT TS

LOC LINK SLC TYPE          L2T          PCR PCR  T1  T1
SET BPS          ECM  N1  N2  LOC  PORT TS

```

Link set table is (10 of 1024) 1% full

- Inhibit the card using the `inh-card` command and specifying the card location. If the IP card to be inhibited contains the only signaling link in the linkset that is in service, the `force=yes` parameter must also be specified. For this example, enter these commands.

```
inh-card:loc=1205
```

```
inh-card:loc=1207:force=yes
```

When these commands have successfully completed, this message appears.

```
rlghncxa03w 06-10-12 09:12:36 GMT EAGLE5 36.0.0
Card has been inhibited.
```

- Verify the changes with the `rept-stat-card` command. This is an example of the possible output.

```
rlghncxa03w 06-10-27 16:43:42 GMT EAGLE5 36.0.0
CARD  VERSION      TYPE    APPL      PST          SST          AST
1101  114-003-000    TSM     SCCP      IS-NR        Active       ---
1102  114-003-000    TSM     GLS       IS-NR        Active       ---
1103  114-002-000    ACMENET STPLAN    IS-NR        Active       ---
1109  114-003-000    HMUX    BPHMUX    IS-NR        Active       ---
1110  114-003-000    HMUX    BPHMUX    IS-NR        Active       ---
1113  114-002-000    GPSM    EOAM      IS-NR        Active       ---
1114  -----        TDM                    IS-NR        Active       ---
1115  114-002-000    GPSM    EOAM      IS-NR        Active       ---
1116  -----        TDM                    IS-NR        Active       ---
1117  -----        MDAL                    IS-NR        Active       ---
1201  114-003-000    LIMDS0  SS7ANSI   IS-NR        Active       ---
1202  114-002-000    LIMV35  SS7GX25   IS-NR        Active       ---
1203  114-003-000    LIMV35  SS7ANSI   IS-NR        Active       ---
1204  114-003-000    LIMATM  ATMANSI   IS-NR        Active       ---
1205  114-001-000    DCM     IPLIM     OOS-MT-DSBLD  Isolated    ---
1207  114-001-000    DCM     IPLIM     OOS-MT-DSBLD  Isolated    ---
1209  114-003-000    HMUX    BPHMUX    IS-NR        Active       ---
1210  114-003-000    HMUX    BPHMUX    IS-NR        Active       ---
1303  114-001-000    DCM     IPLIM     IS-NR        Active       ---
1305  114-001-000    DCM     IPLIM     IS-NR        Active       ---
1309  114-003-000    HMUX    BPHMUX    IS-NR        Active       ---
1310  114-003-000    HMUX    BPHMUX    IS-NR        Active       ---
```

9. Remove the signaling links on the specified card by using the **dlt-slk** command. If the output of step 6 shows that the signaling link being removed is the last signaling link in a linkset, the **force=yes** parameter must be used. For this example, enter these commands.

```
dlt-slk:loc=1205:link=a
dlt-slk:loc=1205:link=b
dlt-slk:loc=1207:link=a:force=yes
```

When these commands have successfully completed, this message appears.

```
rlghncxa03w 06-10-28 09:12:36 GMT EAGLE5 36.0.0
DLT-SLK: MASP A - COMPLTD
```

10. Remove the card from the database using the **dlt-card** command. The **dlt-card** command has only one parameter, **loc**, which is the location of the card. For this example, enter these commands.

```
dlt-card:loc=1205
dlt-card:loc=1207
```

When these commands have successfully completed, this message appears.

```
rlghncxa03w 06-10-12 09:12:36 GMT EAGLE5 36.0.0
DLT-CARD: MASP A - COMPLTD
```

11. Verify the changes using the **rtrv-card** command and specifying the card that was removed in step 10. For this example, enter these commands.

```
rtrv-card:loc=1205
rtrv-card:loc=1207
```

When these commands have successfully completed, this message appears.

```
E2144 Cmd Rej: Location invalid for hardware configuration
```

12. Back up the new changes using the **chg-db:action=backup:dest=fixed** command. These messages appear, the active Maintenance and Administration Subsystem Processor (MASP) appears first.

```
BACKUP (FIXED) : MASP A - Backup starts on active MASP.
BACKUP (FIXED) : MASP A - Backup on active MASP to fixed disk complete.
BACKUP (FIXED) : MASP A - Backup starts on standby MASP.
BACKUP (FIXED) : MASP A - Backup on standby MASP to fixed disk complete.
```

Flowchart 3-2. Removing an IP Card (Sheet 1 of 2)

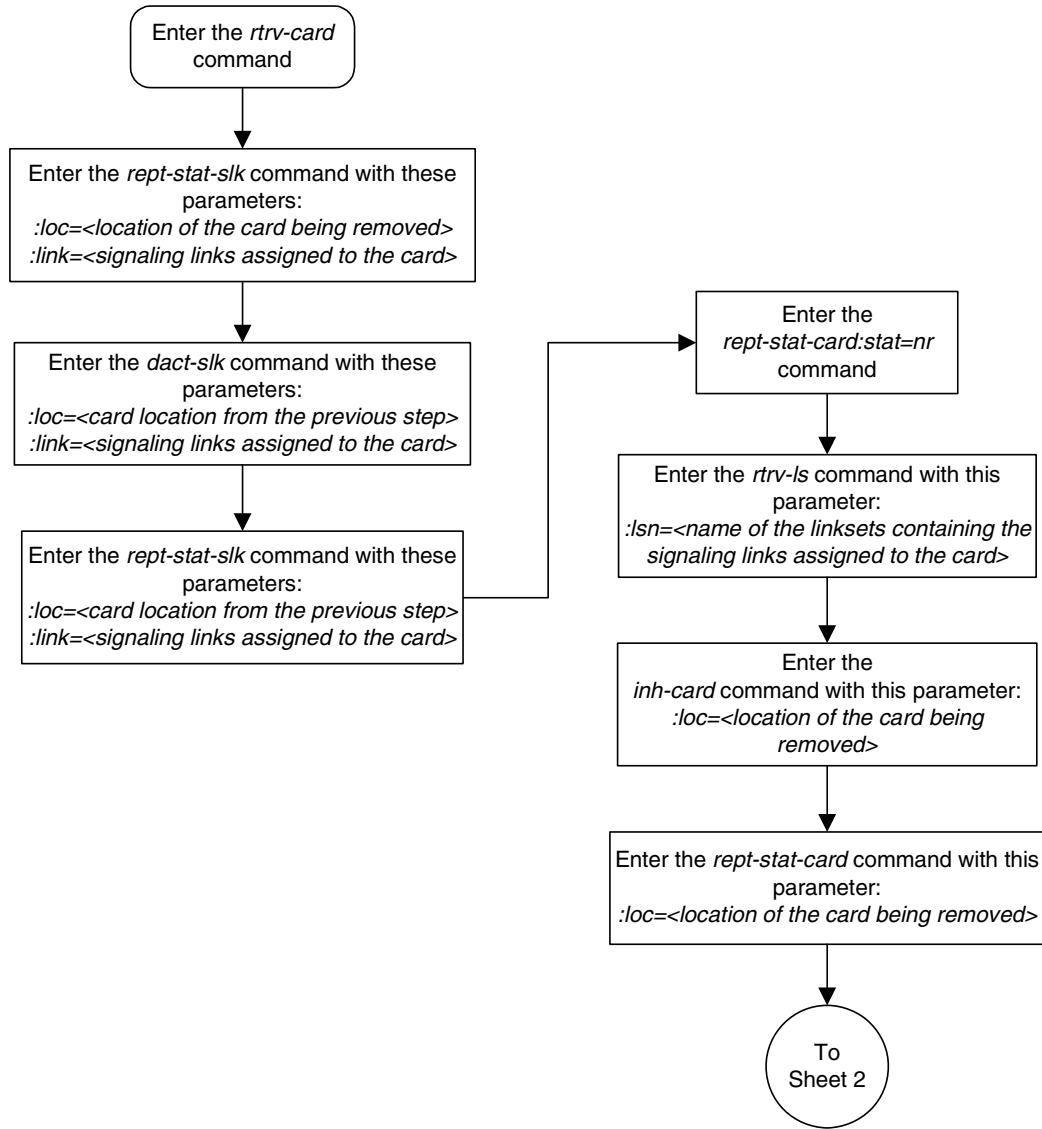

Flowchart 3-2. Removing an IP Card (Sheet 2 of 2)

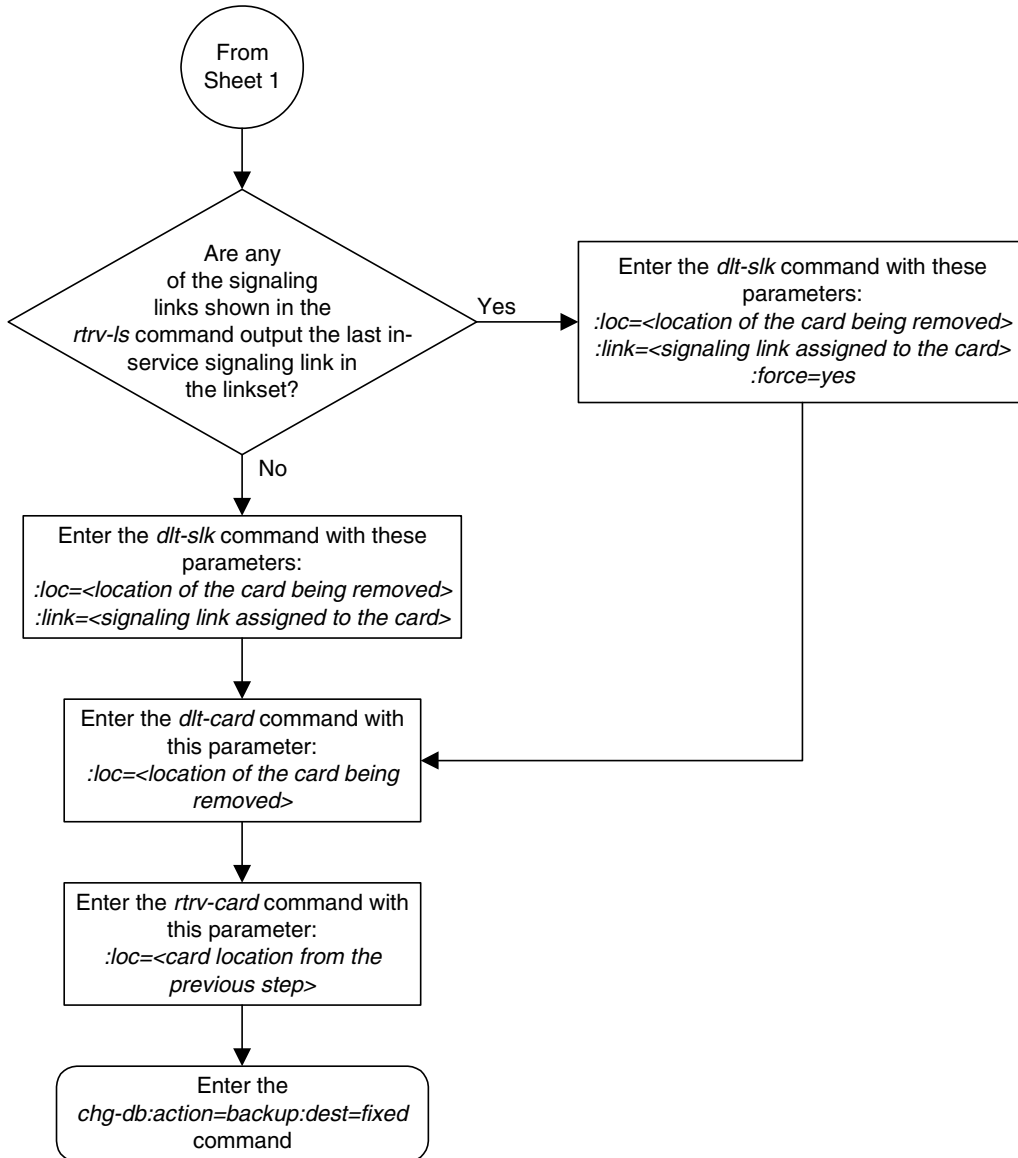

Configuring an IPGWx Linkset

This procedure is used to configure IPGWx linksets in the EAGLE 5 ISS using the `ent-1s` or `chg-1s` commands with these parameters. An IPGWx linkset is a linkset that contains signaling links running either the SS7IPGW or IPGWI applications.

NOTE: This procedure is not used to configure a mate IPGWx linkset, with the `mate1sn` and `action` parameters. To configure a mate IPGWx linkset, perform the “Configuring a Mate IPGWx Linkset” procedure on page 3-63.

:1sn – The name of the linkset. The linkset name can contain up to 10 characters, with the first character being a letter. However, the SEAS interface supports only eight characters. If this linkset is displayed on the SEAS interface and the linkset name contains more than eight characters, only the first eight characters in the linkset name are shown. If this linkset name contains more than eight characters, and is specified with the linkset commands on the SEAS interface, only the first eight characters can be specified.

:apc/apca/apci/apcn/apcn24 – Adjacent point code – the point code identifying the node that is next to the EAGLE 5 ISS. The adjacent point code can be one of the following types of point codes:

:apc/apca – ANSI point code, ANSI private point code

:apci – ITU-I point code, ITU-I spare point code, ITU-I private point code, ITU-I private spare point code.

:apcn – 14-bit ITU-N point code, 14-bit ITU-N spare point code, 14-bit ITU-N private point code, 14-bit ITU-N private spare point code.

:apcn24 – 24-bit ITU-N point code, 24-bit ITU-N private point code.

NOTE: See the “Point Code Formats” section in the *Database Administration Manual - SS7* for a definition of the point code types that are used on the EAGLE 5 ISS and for a definition of the different formats that can be used for ITU national point codes.

NOTE: The `apc/apca/apci/apcn/apcn24` parameter must be specified with the `ent-1s` command. Specifying this parameter with the `chg-1s` command is required only if the adjacent point code of the linkset is being changed.

:1st – The linkset type of the specified linkset - The `1st` parameter must be specified with the `ent-1s` command. Specifying this parameter with the `chg-1s` command is required only if the linkset type of the linkset is being changed.

:ipgwapc – IP Gateway Adjacent Point Code indicator. Specify the `ipgwapc=yes` parameter to provide SS7 linkset definition compatibility for gateway connections to IP-SCPs. This parameter can be specified only for, and

must be specified for, linksets containing signaling links assigned to either the SS7IPGW or IPGWI applications. The default is `ipgwapc=no`.

NOTE: The `ipgwapc` parameter can be specified only with the `ent-1s` command.

To provision ISUP-CIC routing keys, the `ipgwapc=yes` parameter and the IP Gateway ISUP routing feature must be turned on. Verify this with the `rtrv-feat` command. If the IP Gateway ISUP routing feature is turned on, the `ipisup` field should be set to `on`. If the IP Gateway ISUP routing feature is not turned on, enter the `chg-feat:ipisup=on` command.

NOTE: Once the IP Gateway ISUP routing feature is turned on with the `chg-feat` command, it cannot be turned off.

NOTE: The IP Gateway ISUP routing feature must be purchased before you turn the feature on with the `chg-feat` command. If you are not sure if you have purchased the IP Gateway ISUP routing feature, contact your Tekelec Sales Representative or Account Representative.

:iptps – The quantity of IP TPS (transactions per second) that is assigned to the IPGWx linkset, from 100 to 112,000. The total amount of IP TPS for all IPGWx linksets cannot exceed the system-wide IP TPS value shown in the `rept-stat-iptps` output. For more information on the system-wide IP TPS value, see the “Increasing the System-Wide IPGWx Signaling TPS” procedure on page 3-317.

:lsusealm – The linkset’s IP TPS alarm threshold, from 10 to 100 percent of the linkset’s IP TPS. When this threshold is reached, a major alarm (UAM 0115) is generated. When the linkset’s IP TPS falls below this threshold, UAM 0115 is automatically cleared and UAM 0118 is generated.

:slkusealm – The signaling link IP TPS alarm threshold, from 10 to 100 percent of the signaling link’s fair share of the linkset’s IP TPS or from 10 to 100 percent of the IPGWx card’s capacity (2000 TPS). This threshold is reached when the signaling link’s actual usage exceeds the percentage of the signaling link’s fair share of the linkset’s IP TPS or the percentage of the IPGWx card’s capacity.

A signaling link's fair share of linkset’s IP TPS is the linkset’s IP TPS divided by the number of in-service links in the linkset. For example, if the linkset IP TPS is 4000 and there are 4 signaling links in the linkset, all in-service, then the signaling link's fair-share would be 1000 IP TPS (4000/4=1000). Table 3-6 shows this calculation for a linkset with 1, 2, 3 and 4 in-service signaling links.

Table 3-6. Signaling Link Fair Share Example

| Number of In-Service Signaling Links | Linkset IP TPS | Signaling Link Fair Share of the Linkset IP TPS |
|--------------------------------------|----------------|---|
| 4 | 4000 | 1000 |
| 3 | 4000 | 1333 |

Table 3-6. Signaling Link Fair Share Example (Continued)

| Number of In-Service Signaling Links | Linkset IP TPS | Signaling Link Fair Share of the Linkset IP TPS |
|--------------------------------------|----------------|---|
| 2 | 4000 | 2000 |
| 1 | 4000 | 4000 |

When this threshold is exceeded, a minor alarm (UAM 0116) is generated. When the amount of traffic on the signaling link falls below this threshold, UAM 0116 is automatically cleared and UAM 0119 is generated.

The signaling link IP TPS alarm shows that the linkset IP TPS is set too low for the linkset or that the IPGWx card's capacity has been exceeded. Setting the signaling link IP TPS alarm threshold lower than the linkset IP TPS alarm threshold can give the user an earlier indication that the linkset IP TPS is inadequate or that traffic is not balanced across the links in the linkset.

:multgpc – specifies whether multiple group codes (for 14-bit ITU-N point codes) are supported for the linkset. When this parameter value is **yes**, secondary adjacent point codes whose group codes are different from the adjacent point code of the linkset can be assigned to the linkset. If the parameter value is **no**, the group code of the secondary adjacent point code must be the same as the group code of the linkset's adjacent point code. For more information on secondary adjacent point codes, go to the "Configuring an ITU Linkset with a Secondary Adjacent Point Code (SAPC)" procedure in the *Database Administration Manual - SS7*.

This parameter only applies to linksets whose adjacent point codes are either ITU international point codes or ITU national point codes. All the signaling links in this linkset must be assigned to cards running the IPGWI application. For more information on assigning signaling links to cards running the IPGWI application, go to the "Adding an IP Signaling Link" procedure on page 3-84.

The ITU duplicate point code feature must be on before this parameter can be specified. Verify this with the **rtrv-feat** command. If the ITU duplicate point code feature is turned on, the **ituduppc** field should be set to **on**. If the ITU duplicate point code feature is not turned on, enter the **chg-feat:ituduppc=on** command.

NOTE: Once the ITU duplicate point code feature is turned on with the **chg-feat** command, it cannot be turned off.

The ITU duplicate point code feature must be purchased before you turn the feature on with the chg-feat command. If you are not sure if you have purchased the ITU duplicate point code feature, contact your Tekelec Sales Representative or Account Representative.

The adjacent point code (APC) for the linkset must be defined in the database, must be in the SS7 domain and cannot match the point code or capability point code of the EAGLE 5 ISS. The domain of the point code is shown in the **DOMAIN**

field in the output of the `rtrv-dstn` command. The point code of the EAGLE 5 ISS is shown in the `PCA`, `PCN`, `PCN24`, or `PCI` fields and the capability point code of the EAGLE 5 ISS are shown in the `CPCA`, `CPCN`, `CPCN24`, or `CPCI` fields in the output of the `rtrv-sid` command. An ANSI adjacent point code must be a full point code and cannot be a cluster point code or a network routing point code.

If the APC is not in the destination point code table, go to the “Adding a Destination Point Code” procedure in the *Database Administration Manual - SS7* and add the APC to the destination point code table.

For IPGWx linksets, more than one device may be attached to the LAN and have IP connections to the IP card running either the SS7IPGW or IPGWI application. Thus each IPGWx linkset is adjacent to all devices on the LAN (or adjacent to no device on the LAN, depending on your point of view). To provide a scheme allowing this point-to-multipoint connection and maintain consistent SS7 linkset definition rules, a virtual APC is required. This virtual APC is a real SS7 point code that is not used anywhere else in the SS7 network. Virtual APCs assigned to SS7IPGW linksets are ANSI point codes. Virtual APCs assigned to IPGWI linksets are either ITU-I or ITU-N point codes (either 14-bit or 24-bit ITU-N point codes). Virtual point codes can be reused on more than one switch. For example, a mated set of switches, each with two related links, could share two virtual point codes instead of requiring four. DPCs and linksets related to the virtual APC must be defined with the `ipgwapc` parameter set to `yes`.

For provisioning of ISUP-CIC routing keys, the `ipgwapc=yes` parameter and the IP Gateway ISUP routing feature must be turned on. Verify this with the `rtrv-feat` command. If the IP Gateway ISUP routing feature is turned on, the `ipisup` field should be set to `on`. If the IP Gateway ISUP routing feature is not turned on, enter the `chg-feat:ipisup=on` command.

NOTE: Once the IP Gateway ISUP routing feature is turned on with the `chg-feat` command, it cannot be turned off.

The IP Gateway ISUP routing feature must be purchased before you turn the feature on with the `chg-feat` command. If you are not sure if you have purchased the IP Gateway ISUP routing feature, contact your Tekelec Sales Representative or Account Representative.

Other Optional Parameters

Other optional parameters, shown in Table 3-7, can be used with the `ent-1s` or `chg-1s` commands but do not need to be used in this procedure. These parameters are discussed in more detail in either the “Adding an SS7 Linkset” or “Changing an SS7 Linkset” procedures in the *Database Administration Manual - SS7*. The `mate1sn` parameter is discussed in more detail in the “Configuring a Mate IPGWx Linkset” procedure on page 3-63.

Table 3-7. Optional Linkset Parameters

| | | | | |
|--|---------|----------|---------|---------|
| cli | sltset | l3tset | scrn | gwsa |
| gwsm | gwsd | bei | nis | itutfr |
| asl8 | slsrsb | slsocbit | mtprse* | slsci |
| tfatcabmlq | gmscrn | sapci | sapcn | sapcn24 |
| action | matelsn | apcntype | gttmode | randsls |
| * The mtprse parameter cannot be specified for an IPGWx linkset. | | | | |

Canceling the RTRV-LS and RTRV-DSTN Commands

Because the `rtrv-ls` and `rtrv-dstn` commands used in this procedure can output information for a long period of time, the `rtrv-ls` and `rtrv-dstn` commands can be canceled and the output to the terminal stopped. There are three ways that the `rtrv-ls` and `rtrv-dstn` commands can be canceled.

- Press the **F9** function key on the keyboard at the terminal where the `rtrv-ls` or `rtrv-dstn` commands were entered.
- Enter the `canc-cmd` without the `trm` parameter at the terminal where the `rtrv-ls` or `rtrv-dstn` commands were entered.
- Enter the `canc-cmd:trm=<xx>`, where `<xx>` is the terminal where the `rtrv-ls` or `rtrv-dstn` commands were entered, from another terminal other than the terminal where the `rtrv-ls` or `rtrv-dstn` commands were entered. To enter the `canc-cmd:trm=<xx>` command, the terminal must allow Security Administration commands to be entered from it and the user must be allowed to enter Security Administration commands. The terminal's permissions can be verified with the `rtrv-secu-trm` command. The user's permissions can be verified with the `rtrv-user` or `rtrv-secu-user` commands.

For more information about the `canc-cmd` command, go to the *Commands Manual*.

Procedure

1. Display the system-wide IP TPS usage report, and the IPGWx linksets, by entering the `rept-stat-iptps` command. This is an example of the possible output.

```
rlghncxa03w 06-10-10 11:43:04 GMT EAGLE5 36.0.0

IP TPS USAGE REPORT

          THRESH  CONFIG          TPS      PEAK      PEAKTIMESTAMP
-----
SYSTEM
RLGHNCXA03W 100%   30000 TX:   7200    7600  05-02-10 11:40:04
                   RCV:   7200    7600  05-02-10 11:40:04
-----
```

| LSN | | | | | | | |
|----------|-----|-------|------|------|------|----------|----------|
| LSGW1101 | 80% | 10000 | TX: | 7200 | 7600 | 05-02-10 | 11:40:04 |
| | | | RCV: | 7200 | 7600 | 05-02-10 | 11:40:04 |
| LSGW1103 | 80% | 10000 | TX: | 6700 | 7600 | 05-02-10 | 11:40:04 |
| | | | RCV: | 6500 | 7600 | 05-02-10 | 11:40:04 |
| LSGW1105 | 80% | 10000 | TX: | 7300 | 7450 | 05-02-10 | 11:40:04 |
| | | | RCV: | 7300 | 7450 | 05-02-10 | 11:40:04 |

 Command Completed.

If the sum of the IP TPSs of all the IPGWx linksets is equal to the configured IP TPS amount shown in this report:

- No new IPGWx linksets can be added
- The linkset IP TPS of any IPGWx existing linkset cannot be increased.

If a new IPGWx linkset is being added in this procedure, and the IP TPS value for this linkset allows the sum of the IP TPS of all the IPGWx linksets to exceed the configured IP TPS amount shown in this report, the new IPGWx linkset cannot be added.

If an existing IPGWx IP TPS value is being changed in this procedure, and the IP TPS value for this linkset allows the sum of the IP TPS of all the IPGWx linksets to exceed the configured IP TPS amount shown in this report, the IPGWx linkset IP TPS value cannot be changed.

To add a new IPGWx linkset or change the IP TPS value of an existing IPGWx linkset when the resulting sum of IP TPS values for all IPGWx linksets will exceed the IP TPS amount shown in this report, the system-wide IP TPS amount must be increased, or the linkset IP TPS of some or all the IPGWx linksets must be reduced to allow for the new IP TPS value for the linkset configured in this procedure.

To increase the system-wide IP TPS amount, perform the “Increasing the System-Wide IPGWx Signaling TPS” procedure on page 3-317. If the system-wide IP TPS amount is 112000, shown in the **CONFIG** column in the **SYSTEM** section of this report, the system-wide IP TPS amount cannot be increased. Skip step 2 and go to step 3.

If the linkset IP TPS values of the IPGWx linksets need to be reduced, perform step 2.

-
2. Reduce the IP TPS values of some or all the IPGWx linksets by entering the **chg-ls** command with the name of each linkset being changed from step 1, and the new IP TPS value. For this example, enter these commands.

```
chg-ls:lsn=lsgw1101:iptps=6000
```

```
chg-ls:lsn=lsgw1103:iptps=6000
```

When the **chg-ls** command has successfully completed, this message should appear.

```
rlghncxa03w 06-10-17 16:23:21 GMT EAGLE5 36.0.0
Link set table is ( 13 of 1024) 1% full
CHG-LS: MASP A - COMPLTD
```

NOTE: If the `multgc` parameter is not being specified for the linkset, skip steps 3, 4, 5, and 6, and go to step 7. If the `multgc` parameter value is being changed to `no`, skip steps 3, and 4, and go to step 5. The `multgc` parameter can be specified only for linksets with either ITU-I or 14-bit ITU-N APCs, and linksets that contain signaling links running the IPGWI application.

3. To specify the `multgc=yes` parameter with the `ent-1s` or `chg-1s` commands, the ITU Duplicate Point Code feature must be on. For the ITU Duplicate Point Code feature to be on, the Multiple Point Code feature must be on. Enter the `rtrv-feat` command to verify that either of these features are on. The entry `MPC = on` in the `rtrv-feat` command output shows that the Multiple Point Code feature is on. The entry `ITUDUPPC = on` in the `rtrv-feat` command output shows that the ITU Duplicate Point Code feature is on. In this example, both features are off.

NOTE: The `rtrv-feat` command output contains other fields that are not used by this procedure. If you wish to see all the fields displayed by the `rtrv-feat` command, see the `rtrv-feat` command description in the *Commands Manual*.

NOTE: If the ITU Duplicate Point Code feature is on (`ITUDUPPC = on`), skip this step and go to step 5.

4. Turn the ITU Duplicate Point Code feature on, and the Multiple Point Code feature if necessary, by entering one of these commands.

To turn the ITU Duplicate Point Code feature on only.

```
chg-feat:ituduppc=on
```

To turn both the ITU Duplicate Point Code and Multiple Point Code features on.

```
chg-feat:mpc=on:ituduppc=on
```

NOTE: Once the ITU Duplicate Point Code and Multiple Point Code features are turned on with the `chg-feat` command, they cannot be turned off.

The ITU Duplicate Point Code and Multiple Point Code features must be purchased before you turn either of these features on with the `chg-feat` command. If you are not sure if you have purchased these features, contact your Tekelec Sales Representative or Account Representative.

When this command has successfully completed, this message should appear.

```
rlghncxa03w 06-10-10 11:43:04 GMT EAGLE5 36.0.0
CHG-FEAT: MASP A - COMPLTD
```

NOTE: If the `multgc` parameter value is not being changed, is being changed to `yes`, or if a new linkset is being added, skip steps 5 and 6, and go to step 7.

- If the `multgc` parameter value is changed to `no`, the linkset can contain only one secondary adjacent point code. An ITU international linkset can contain only one 14-bit ITU national secondary adjacent point code. If the ITU international linkset contains more than one 14-bit ITU national secondary adjacent point code, all but one of these 14-bit ITU national secondary adjacent point codes must be removed from the linkset. An ITU national linkset can contain only one ITU international secondary adjacent point code. All 14-bit ITU-N secondary adjacent point codes must be removed from the linkset. All routes to these secondary adjacent point codes must be removed from the database before the secondary adjacent point codes can be removed.

Display the routes using the secondary adjacent point code being removed from the linkset with the `rtrv-rte` command, specifying the secondary adjacent point code being removed as the value of the `dpc` parameter.

For this example, enter these commands.

```
rtrv-rte:dpcn=11213-de
```

This is an example of the possible output.

```
rlghncxa03w 06-10-07 11:43:04 GMT EAGLE5 36.0.0
DPCN          ALIASA          ALIASI  LSN          RC      APC
11213-de      -----
RTX:No      CLLI=-----
```

```
rtrv-rte:dpcn=12114-fr
```

This is an example of the possible output.

```
rlghncxa03w 06-10-07 11:43:04 GMT EAGLE5 36.0.0
DPCN          ALIASA          ALIASI  LSN          RC      APC
12114-fr      -----
RTX:No      CLLI=-----
```

```
rtrv-rte:dpcn=12115-uk
```

This is an example of the possible output.

```
rlghncxa03w 06-10-07 11:43:04 GMT EAGLE5 36.0.0
DPCN          ALIASA          ALIASI  LSN          RC      APC
12115-uk      -----
RTX:No      CLLI=-----
```

If the secondary adjacent point code is assigned to a route, that route must be removed from the database. Perform the “Removing a Route” procedure in the *Database Administration Manual - SS7* to remove the route from the database.

- Remove the secondary adjacent point codes specified in step 5 from the linkset with the `chg-ls` command with the `sapcn` and the `action=delete` parameters. For this example, enter these commands.

```
chg-ls:lsn=lsn3:sapcn=11213-de:action=delete
```

```
chg-ls:lsn=lsn3:sapcn=12114-fr:action=delete
```

```
chg-ls:lsn=lsn3:sapcn=12115-uk:action=delete
```

When the **chg-ls** command has successfully completed, this message should appear.

```
rlghncxa03w 06-10-17 16:23:21 GMT EAGLE5 36.0.0
Link set table is ( 13 of 255) 5% full
CHG-LS: MASP A - COMPLTD
```

NOTE: If an existing linkset is being changed, and the adjacent point code of that linkset is not being changed, skip steps 7 through 14, and go to step 15.

NOTE: If a new linkset is being added, or an existing linkset is being changed, and the adjacent point code of that linkset is being changed continue this procedure with step 7.

7. Display the point code and capability point code of the EAGLE 5 ISS by using the **rtrv-sid** command. This is an example of the possible output.

```
rlghncxa03w 06-10-10 11:43:04 GMT EAGLE5 36.0.0
PCA          PCI          PCN          CLLI          PCTYPE
001-001-001  1-200-6          13482        rlghncxa03w  OTHER

CPCA
002-002-002      002-002-003      002-002-004      002-002-005
002-002-006      002-002-007      002-002-008      002-002-009
004-002-001      004-003-003      144-212-003

CPCA (LNP)
005-005-002      005-005-004      005-005-005

CPCI
1-001-1          1-001-2          1-001-3          1-001-4

CPCN
02091            02092            02094            02097
02191            02192            11177
```

8. Display the adjacent point code of the new linkset in the destination point code table by using the **rtrv-dstn** command and specifying the point code

For this example, enter this command.

rtrv-dstn:dPCA=009-002-003

This is an example of the possible output.

```
rlghncxa03w 06-10-10 11:43:04 GMT EAGLE5 36.0.0
DPCA          CLLI          BEI ELEI  ALIASI          ALIASN          DOMAIN
010-020-005  ----- no --- -----             -----             SS7

          SPC          NCAI
          -----          ----
```

Destination table is (29 of 2000) 1% full

If the adjacent point code is not shown in the **rtrv-dstn** command output, the following output is displayed.

```
DPCA          CLLI          BEI ELEI  ALIASI          ALIASN/N24      DOMAIN
No destinations meeting the requested criteria were found
Destination table is (29 of 2000) 1% full
```

If the adjacent point code is not in the destination point code table, perform the “Adding a Destination Point Code” procedure in the *Database Administration Manual - SS7* and add the adjacent point code to the destination point code table.

NOTE: If the adjacent point code was added in step 8, and a new linkset is being added, skip steps 9 and 10, and go to step 11.

NOTE: If the adjacent point code was added in step 8, and an existing linkset is being changed, skip steps 9 through 14, and go to step 15.

9. The APC of the linkset cannot be the DPC of any exception route. Verify that the adjacent point code of the linkset is not the DPC of any exception route by entering the `rtrv-rtx` command with the `dpc/dpca/dpci/dpcn/dpcn24` parameter. The `dpc/dpca/dpci/dpcn/dpcn24` parameter value is the adjacent point code value that will be specified for the linkset. For this example, enter this command.

rtrv-rtx:dpca=010-020-005

This is an example of the possible output.

```
rlghncxa03w 06-10-10 11:43:04 GMT EAGLE5 36.0.0
      DPCA          RTX-CRITERIA          LSN          RC          APC

      010-020-005  OPCA
                        007-008-009          1s1305        20          001-005-000
                        008-008-008          1s1307        40          001-007-000

DESTINATION ENTRIES ALLOCATED:  2000
FULL DPC(s) :                   13
EXCEPTION DPC(s) :               5
NETWORK DPC(s) :                 0
CLUSTER DPC(s) :                 1
TOTAL DPC(s) :                   19
CAPACITY (% FULL) :              1%
ALIASES ALLOCATED:              12000
ALIASES USED:                    0
CAPACITY (% FULL) :              0%
X-LIST ENTRIES ALLOCATED:       500
```

If the adjacent point code of the linkset is not the DPC of a route exception table entry, no entries are displayed in the `rtrv-rtx` output, but a summary of the point code quantities is displayed, as shown in the following output example.

```
rlghncxa03w 06-10-10 11:43:04 GMT EAGLE5 36.0.0

DESTINATION ENTRIES ALLOCATED:  2000
FULL DPC(s) :                   15
EXCEPTION DPC(s) :               5
NETWORK DPC(s) :                 0
CLUSTER DPC(s) :                 1
TOTAL DPC(s) :                   21
CAPACITY (% FULL) :              1%
ALIASES ALLOCATED:              12000
ALIASES USED:                    0
CAPACITY (% FULL) :              0%
X-LIST ENTRIES ALLOCATED:       500
```

If the point code specified in this step is shown in the **DPCA/DPCI/DPCN/DPCN24** columns in this step, the point code value cannot be used as an adjacent point code unless one of two actions are taken:

- Choose another adjacent point code value and repeat steps 7, 8, and 9.
- Remove all the entries displayed in this step by performing the “Removing a Route Exception Entry” procedure in the *Database Administration Manual - SS7*.

10. Display any entires in the route table whose DPC value is also the adjacent point code of the new linkset being added in this procedure, or the new adjacent point code of the existing linkset being changed in this procedure. Enter the **rtrv-rte** command with the **dpc/dpca/dpci/dpcn/dpcn24** parameter. The **dpc/dpca/dpci/dpcn/dpcn24** parameter value is the adjacent point code value that will be specified for the linkset. For this example, enter this command.

rtrv-rte:dpca=010-020-005

This is an example of the possible output.

```
rlghncxa03w 06-10-10 11:43:04 GMT EAGLE5 36.0.0

      DPCA          ALIASI      ALIASN/N24      LSN          RC          APCA
010-020-005 -----
                        lsn1          1          003-003-003
                        lsn2          2          003-003-004
                                RTX:No  CLLI=-----
```

If the adjacent point code of the linkset is not the DPC of a route, the point code entry is displayed in the **rtrv-rte** output, but the LSN, RC, and APC columns contain dashes, as shown in the following output example.

```
rlghncxa03w 06-10-10 11:43:04 GMT EAGLE5 36.0.0

      DPCA          ALIASI      ALIASN/N24      LSN          RC          APCA
002-002-002 -----
                                RTX:No  CLLI=-----
```

If the point code specified in this step is shown in the **DPCA/DPCI/DPCN/DPCN24** columns in this step, the point code value cannot be used as an adjacent point code unless one of two actions are taken:

- Choose another adjacent point code value and repeat steps 7, 8, 9, and 10.
- Remove all the entries displayed in this step by performing the “Removing a Route” procedure in the *Database Administration Manual - SS7*.

NOTE: If an existing linkset is being changed, skip steps 11 through 14, and go to step 15.

11. Display the current linksets in the database using the `rtrv-ls` command. This is an example of the possible output.

```

rlghncxa03w 06-10-10 11:43:04 GMT EAGLE5 36.0.0
                                     L3T SLT                               GWS GWS GWS
LSN          APCA      (SS7)  SCRN  SET SET BEI LST LNKS  ACT MES DIS SLSCI NIS
e1e2         001-207-000  none  1  1  no  B   6   off off off no  off
e1m1s1      001-001-001  none  1  1  no  A   7   off off off no  off
e1m1s2      001-001-002  none  1  1  no  A   7   off off off no  off
ls1305      001-005-000  none  1  1  no  A   1   off off off no  off
ls1307      001-007-000  none  1  1  no  A   1   off off off no  off
lsgw1101    008-012-003  none  1  1  no  A   1   off off off no  off
lsgw1103    003-002-004  none  1  1  no  A   1   off off off no  off
lsgw1105    009-002-003  none  1  1  no  A   1   off off off no  off

                                     L3T SLT                               GWS GWS GWS
LSN          APCA      (X25)  SCRN  SET SET BEI LST LNKS  ACT MES DIS SLSCI NIS

                                     L3T SLT                               GWS GWS GWS
LSN          APCI      (SS7)  SCRN  SET SET BEI LST LNKS  ACT MES DIS SLSCI NIS
e1e2i       1-207-0      none  1  1  no  B   4   off off off --- on
ls1315      0-015-0      none  1  1  no  A   1   off off off --- off
ls1317      0-017-0      none  1  1  no  A   1   off off off --- on
e1m2s1      1-011-1      none  1  1  no  A   7   off off off --- off
e1m2s2      1-011-2      none  1  1  no  A   7   off off off --- off

                                     L3T SLT                               GWS GWS GWS
LSN          APCN      (SS7)  SCRN  SET SET BEI LST LNKS  ACT MES DIS SLSCI NIS

                                     L3T SLT                               GWS GWS GWS
LSN          APCN24   (SS7)  SCRN  SET SET BEI LST LNKS  ACT MES DIS SLSCI NIS

                                     L3T SLT                               GWS GWS GWS
LSN (CHINA)  APCN      (SS7)  SCRN  SET SET BEI LST LNKS  ACT MES DIS SLSCI NIS

                                     L3T SLT                               GWS GWS GWS
LSN (CHINA)  APCN24   (SS7)  SCRN  SET SET BEI LST LNKS  ACT MES DIS SLSCI NIS

Link set table is (13 of 1024) 1% full.

```

NOTE: If you do not wish to use the IP Gateway ISUP routing feature, skip steps 12 and 13, and go to step 14.

12. Verify that the IP Gateway ISUP routing feature is on by entering the `rtrv-feat` command. The entry `IPISUP = on` in the `rtrv-feat` command output shows that the IP Gateway ISUP routing feature is on.

NOTE: The `rtrv-feat` command output contains other fields that are not used by this procedure. If you wish to see all the fields displayed by the `rtrv-feat` command, see the `rtrv-feat` command description in the *Commands Manual*.

NOTE: If the IP Gateway ISUP routing feature is on (`IPISUP = on`), skip this step and go to step 14.

13. Turn the IP Gateway ISUP routing feature on by entering this command.

```
chg-feat:ipisup=on
```

NOTE: Once the IP Gateway ISUP routing feature is turned on with the `chg-feat` command, it cannot be turned off.

NOTE: The IP Gateway ISUP routing feature must be purchased before you turn the feature on with the `chg-feat` command. If you are not sure if you have purchased the IP Gateway ISUP routing feature, contact your Tekelec Sales Representative or Account Representative.

When this command has successfully completed, this message should appear.

```
r1ghncxa03w 06-10-10 11:43:04 GMT EAGLE5 36.0.0
CHG-FEAT: MASP A - COMPLTD
```

14. Add the new linkset to the database using the `ent-1s` command. The new linkset must meet these conditions.

- The name of this linkset cannot be used by another linkset – the linkset configuration is shown in the output of step 11.

The APC of the new linkset must be in the destination point code table, but cannot be either the EAGLE 5 ISS's point code or the EAGLE 5 ISS's capability point code – shown in the outputs of steps 7 and 8. The adjacent point code can be one of the following types of point codes:

`:apc/apca` – ANSI point code, ANSI private point code

`:apci` – ITU-I point code, ITU-I spare point code, ITU-I private point code, ITU-I private spare point code.

`:apcn` – 14-bit ITU-N point code, 14-bit ITU-N spare point code, 14-bit ITU-N private point code, 14-bit ITU-N private spare point code.

`:apcn24` – 24-bit ITU-N point code, 24-bit ITU-N private point code.

- These parameters and values must also be specified for the IPGWx linkset:

```
- ipgwapc=yes
```

```
- lst=<a,b,c,d,e>
```

```
- iptps=<100-112000>
```

NOTE: The `iptps` parameter value must be divisible by 10. The sum of all the linkset IP TPS values, including the value for this linkset, cannot exceed the system-wide IP TPS value shown in the `rept-stat-iptps` output in step 1.

- The `mtprse=yes` parameter cannot be specified for an IPGWx linkset.
- The optional parameters `1susealm` (the linkset's IP TPS alarm threshold) and `s1kusealm` (the signaling link IP TPS alarm threshold) can be

specified with the `ent-ls` command. The default value for the `lsusealm` parameter is 100%, and the default value for the `slkusealm` parameters is 80%.

- The `multgc=yes` parameter can be specified only for IPGWx linksets that will contain signaling links running the IPGWI application.

NOTE: There are other optional parameters that can be specified with the `ent-ls` command, but are not required for an IPGWx linkset. These parameters and their usage are discussed in the “Configuring a Mate IPGWx Linkset” procedure on page 3-63 and in the “Adding an SS7 Linkset” procedure in the *Database Administration Manual - SS7*.

For this example, enter this command.

```
ent-ls:lsn=lsgw1107:apca=010-020-005:lst=a:ipgwapc=yes
:iptps=4000:lsusealm=70:slkusealm=70
```

When this command has successfully completed, this message should appear.

```
rlghncxa03w 06-10-17 16:23:21 GMT EAGLE5 36.0.0
Link set table is ( 14 of 1024) 1% full
ENT-LS: MASP A - COMPLTD
```

NOTE: If you do not wish to change an existing IPGWx linkset, skip steps 15 and 16, and go to step 17.

NOTE: If the `slkusealm` parameter for the linkset is not being changed, skip step 15 and go to step 16.

15. Display the signaling link alarm threshold for the linkset being changed by entering the `rept-stat-iptps` command with the name of the linkset being changed. For this example, enter this command.

```
rept-stat-iptps:lsn=lsgw1105
```

This is an example of the possible output.

```
rlghncxa03w 06-10-17 16:23:21 GMT EAGLE5 36.0.0

IP TPS USAGE REPORT
```

| | THRESH | CONFIG | | TPS | PEAK | PEAKTIMESTAMP |
|----------|--------|--------|------|------|------|-------------------|
| ----- | | | | | | |
| LSN | | | | | | |
| LSGW1105 | 80% | 10000 | TX: | 7300 | 7450 | 05-02-10 11:40:04 |
| | | | RCV: | 7300 | 7450 | 05-02-10 11:40:04 |
| ----- | | | | | | |
| LOC | PORT | | | | | |
| 1105 | A | 80% | TX: | 7300 | 7450 | 05-02-10 11:40:04 |
| | | | RCV: | 7300 | 7450 | 05-02-10 11:40:04 |
| ----- | | | | | | |

Command Completed.

16. Change the existing linkset using the **chg-ls** command with the name of the linkset being changed, shown in the **rept-stat-iptps** output in step 1, and with at least one of these parameters:

- The new adjacent point code of the linkset, if the current adjacent point code of the linkset is being changed.
- **iptps=<100-112000>**
NOTE: The iptps parameter value must be divisible by 10. The sum of all the linkset IP TPS values, including the value for this linkset, if this value is changed, cannot exceed the system-wide IP TPS value shown in the rept-stat-iptps output in step 1.
- The **mtprse=yes** parameter cannot be specified for an IPGWx linkset.
- The optional parameters **lsusealm** (the linkset's IP TPS alarm threshold) and **slkusealm** (the signaling link IP TPS alarm threshold) can be specified with the **chg-ls** command.
- The **multgc=yes** parameter can be specified only for IPGWx linksets that contain signaling links running the IPGWI application.

NOTE: There are other optional parameters that can be specified with the chg-ls command, but are not required for an IPGWx linkset. These parameters and their usage are discussed in the "Configuring a Mate IPGWx Linkset" procedure on page 3-63 and in the "Changing an SS7 Linkset" procedure in the Database Administration Manual - SS7.

For this example, enter this command.

```
chg-ls:lsn=lsgw1105:iptps=14000:lsusealm=70:slkusealm=70
```

When this command has successfully completed, this message should appear.

```
rlghncxa03w 06-10-17 16:23:21 GMT EAGLE5 36.0.0
Link set table is ( 14 of 1024) 1% full
CHG-LS: MASP A - COMPLTD
```

17. Verify the changes using the **rtrv-ls** command specifying the linkset name specified in either steps 14 or 16 with the **lsn** parameter. For this example, enter these commands.

```
rtrv-ls:lsn=lsgw1105
```

This is an example of the possible output.

```
rlghncxa03w 06-10-17 11:43:04 GMT EAGLE5 36.0.0

LSN          APCA  (SS7)  SCRN  SET  SET  BEI  LST  LNKS  ACT  MES  DIS  SLSCI  NIS
lsgw1105     009-002-003  none  1   1   no  A   1   off off off no   off

          CLLI          TFATCABMLQ  MTPRSE  ASL8
          -----  1           no      no

          IPGWAPC  MATELSN          IPTPS  LSUSEALM  SLKUSEALM  GTTMODE
```

IP⁷ Secure Gateway Configuration Procedures

```

yes      ----- 14000 70      % 70      % CdPA

LOC LINK SLC TYPE      L2T      L1      PCR PCR
SET BPS      MODE TSET ECM      N1  N2

LOC LINK SLC TYPE      LP      ATM
SET BPS      TSEL      VCI      VPI  LL

LOC LINK SLC TYPE      LP      ATM      E1ATM
SET BPS      TSEL      VCI      VPI  CRC4 SI SN

LOC LINK SLC TYPE      IPLIML2

LOC LINK SLC TYPE
1105 A      0      SS7IPGW

LOC LINK SLC TYPE      L2T      PCR PCR E1 E1
SET BPS      ECM      N1  N2  LOC PORT TS

LOC LINK SLC TYPE      L2T      PCR PCR T1 T1
SET BPS      ECM      N1  N2  LOC PORT TS

```

Link set table is (14 of 1024) 1% full

rtrv-ls:lsn=lsgw1107

This is an example of the possible output.

rlghncxa03w 06-10-17 11:43:04 GMT EAGLE5 36.0.0

```

LSN          APCA      (SS7)  SCRN  L3T SLT      GWS GWS GWS
SET SET BEI LST LNKS ACT MES DIS SLSCI NIS
lsgw1107     010-020-005  none  1   1  no  A  0  off off off no  off

CLLI          TFATCABMLQ MTPRSE ASL8
----- 1          no      no

IPGWAPC MATELSN      IPTPS LSUSEALM SLKUSEALM GTTMODE
yes      ----- 4000 70      % 70      % CdPA

LOC LINK SLC TYPE      L2T      L1      PCR PCR
SET BPS      MODE TSET ECM      N1  N2

LOC LINK SLC TYPE      LP      ATM
SET BPS      TSEL      VCI      VPI  LL

LOC LINK SLC TYPE      LP      ATM      E1ATM
SET BPS      TSEL      VCI      VPI  CRC4 SI SN

LOC LINK SLC TYPE      IPLIML2

LOC LINK SLC TYPE

LOC LINK SLC TYPE      L2T      PCR PCR E1 E1
SET BPS      ECM      N1  N2  LOC PORT TS

LOC LINK SLC TYPE      L2T      PCR PCR T1 T1
SET BPS      ECM      N1  N2  LOC PORT TS

```

Link set table is (14 of 1024) 1% full

18. Back up the new changes using the `chg-db:action=backup:dest=fixed` command. These messages should appear, the active Maintenance and Administration Subsystem Processor (MASP) appears first.

```

BACKUP (FIXED) : MASP A - Backup starts on active MASP.
BACKUP (FIXED) : MASP A - Backup on active MASP to fixed disk complete.
BACKUP (FIXED) : MASP A - Backup starts on standby MASP.
BACKUP (FIXED) : MASP A - Backup on standby MASP to fixed disk complete.
    
```

Flowchart 3-3. Configuring an IPGWx Linkset (Sheet 1 of 10)

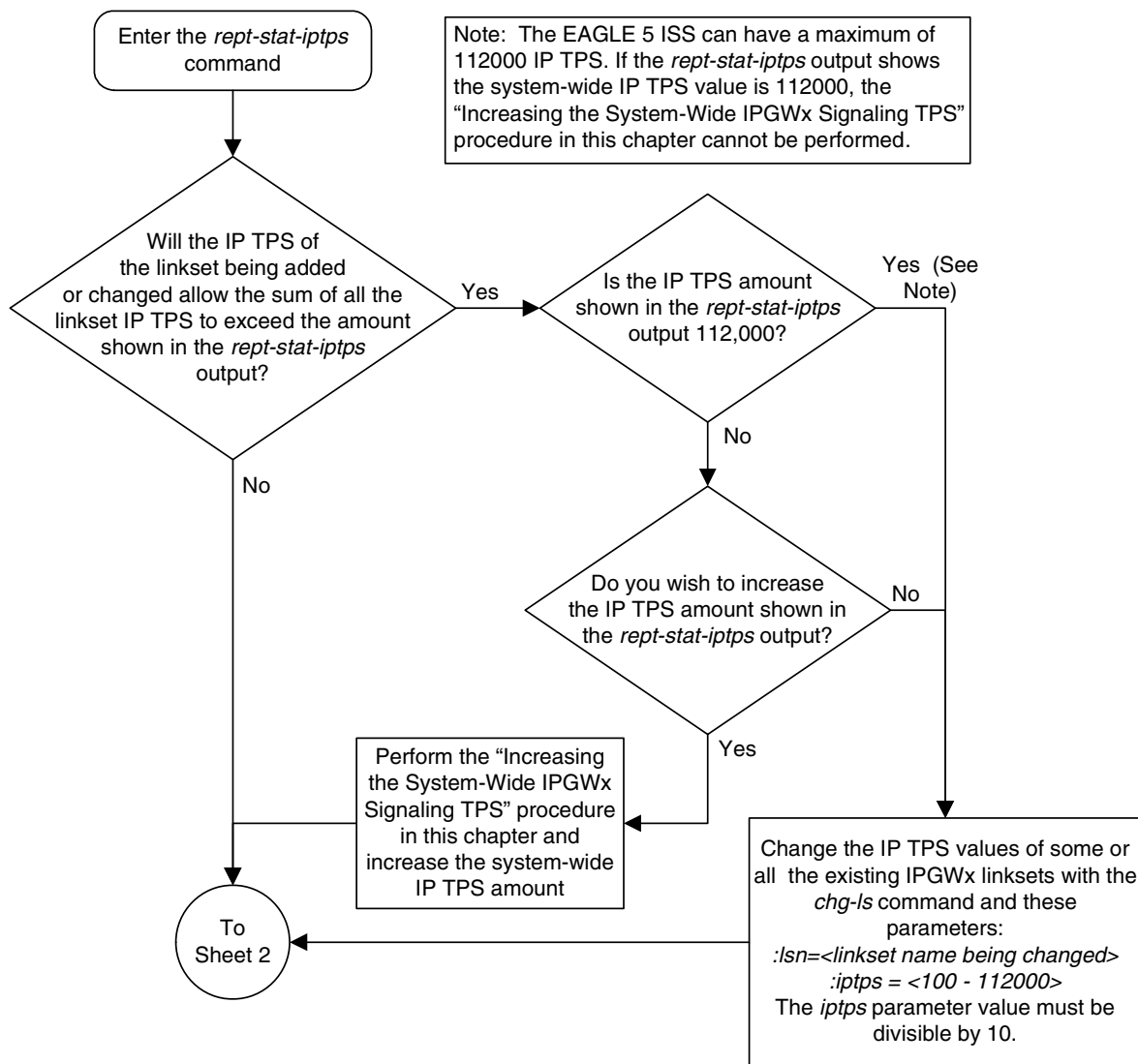

Flowchart 3-3. Configuring an IPGWx Linkset (Sheet 2 of 10)

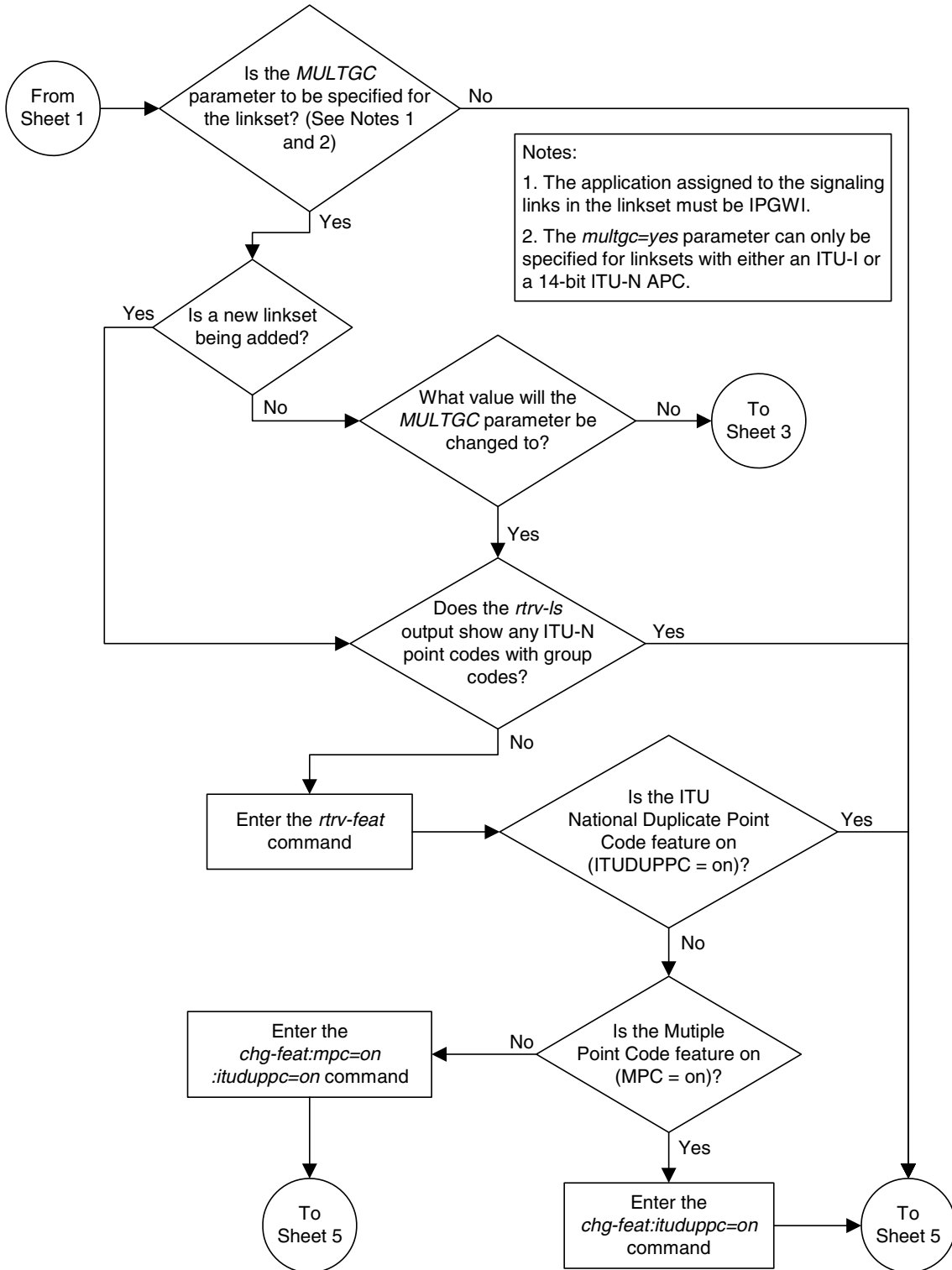

Flowchart 3-3. Configuring an IPGWx Linkset (Sheet 3 of 10)

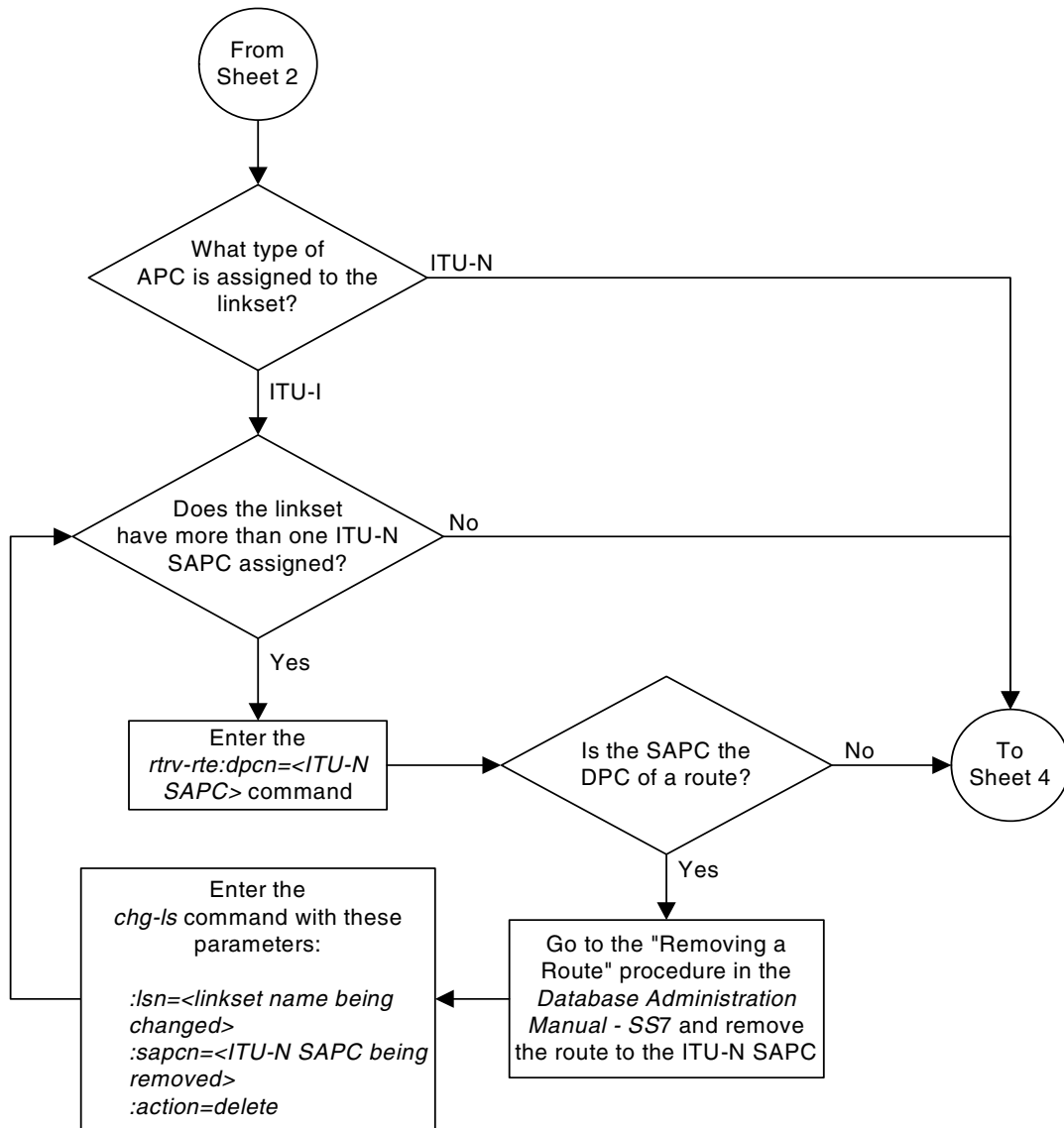

Flowchart 3-3. Configuring an IPGWx Linkset (Sheet 4 of 10)

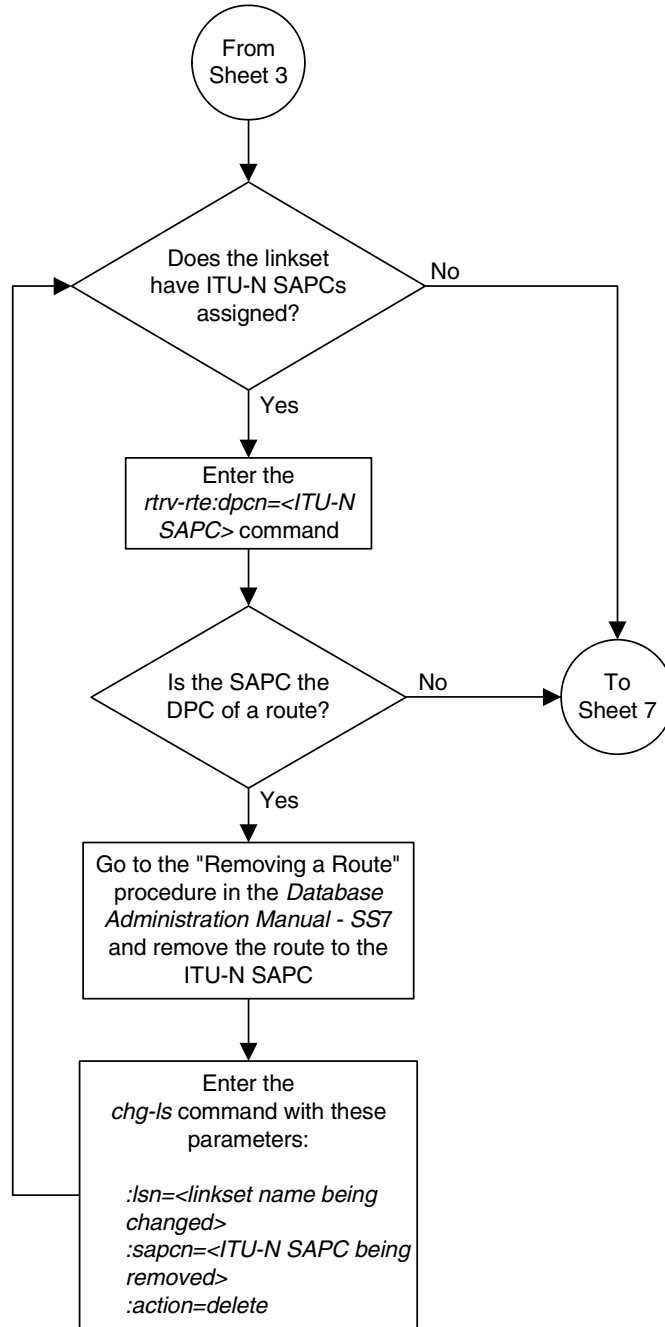

Flowchart 3-3. Configuring an IPGWx Linkset (Sheet 5 of 10)

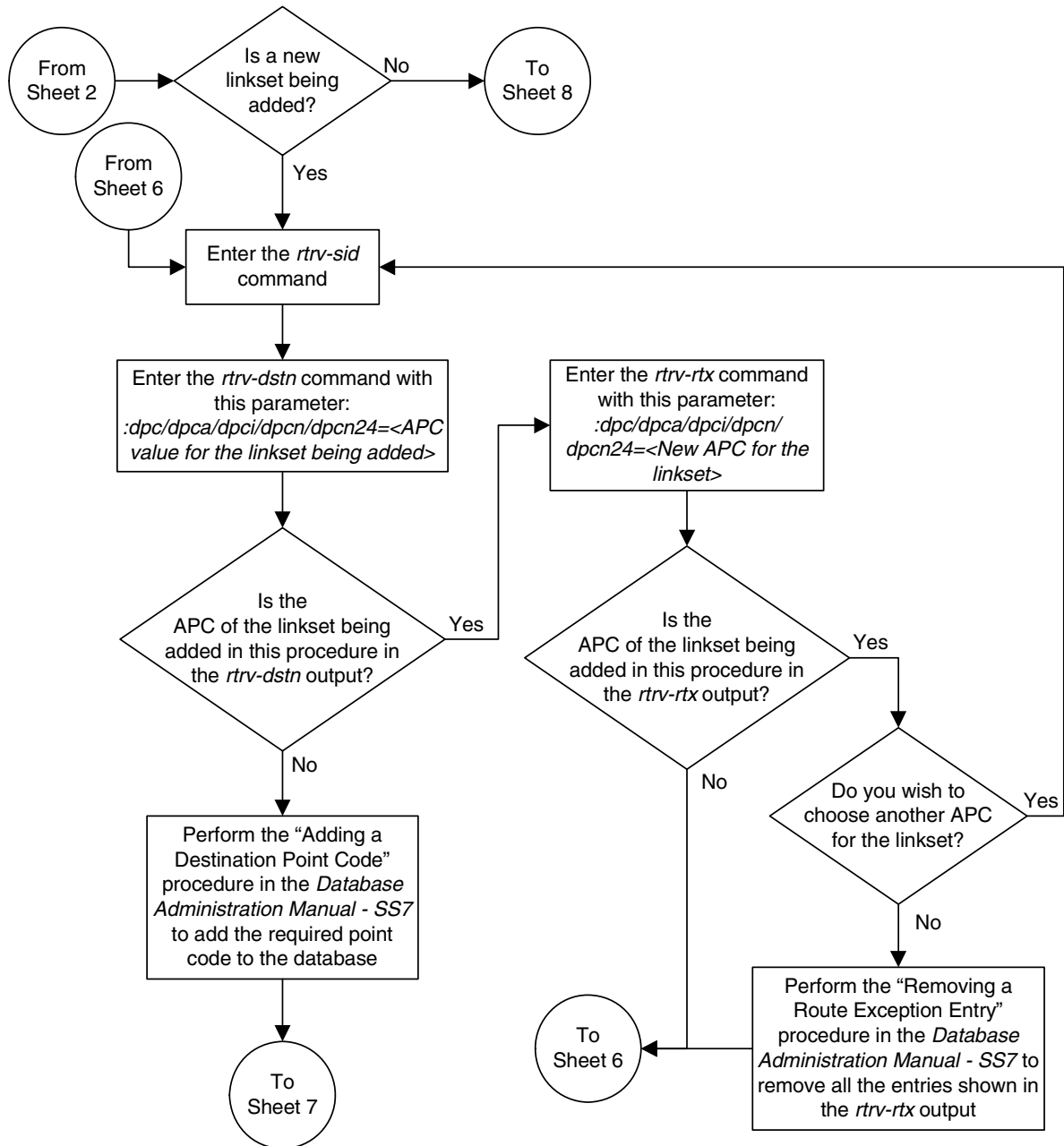

Flowchart 3-3. Configuring an IPGWx Linkset (Sheet 6 of 10)

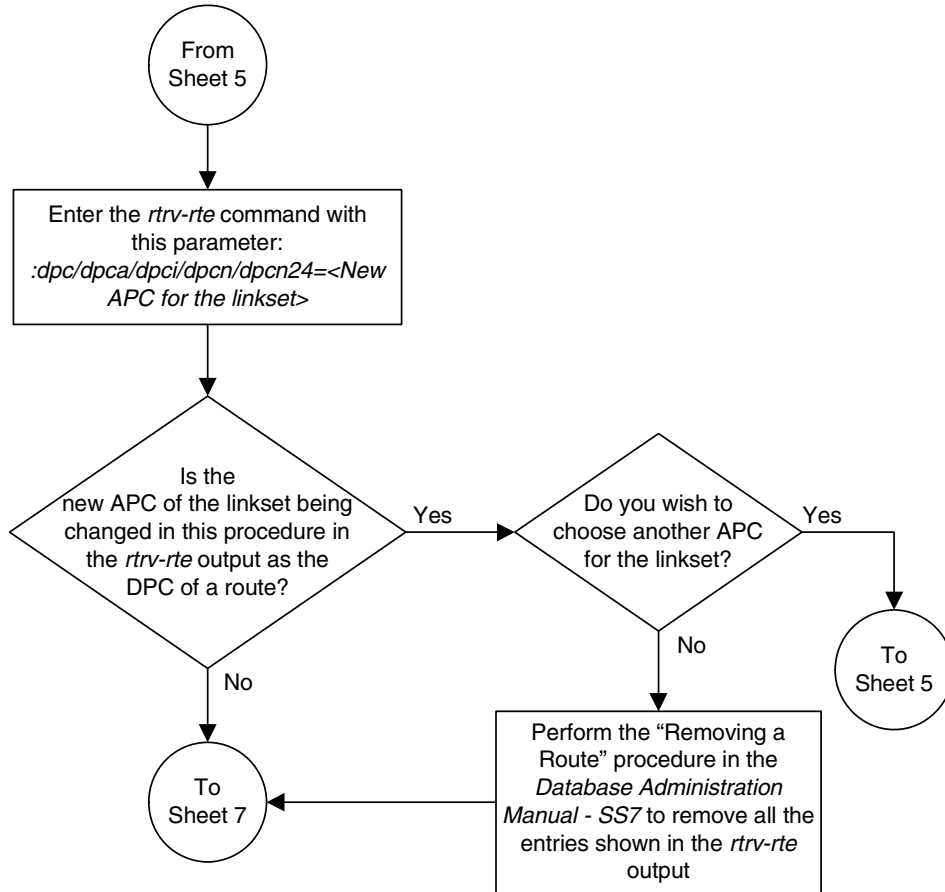

Flowchart 3-3. Configuring an IPGWx Linkset (Sheet 7 of 10)

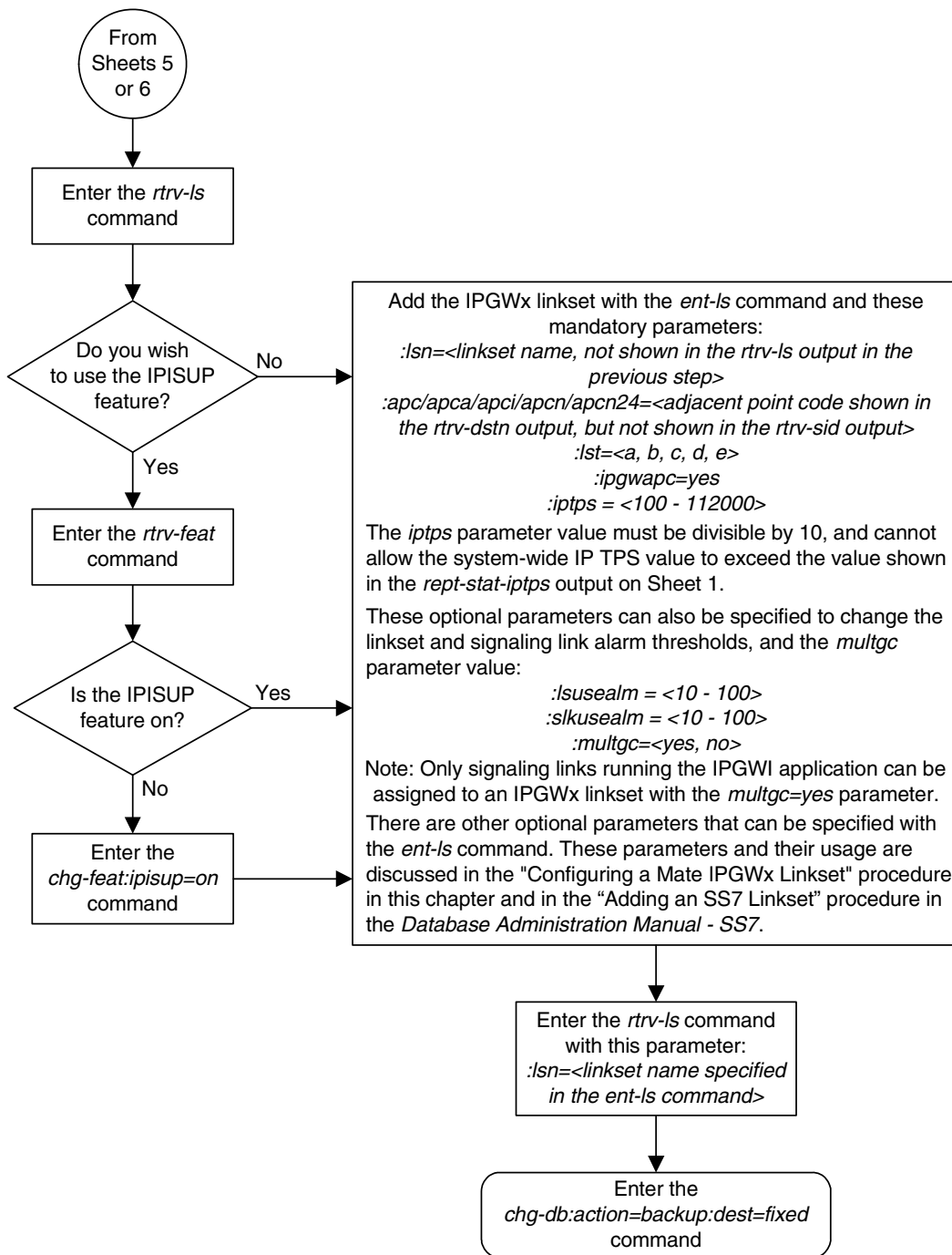

Flowchart 3-3. Configuring an IPGWx Linkset (Sheet 8 of 10)

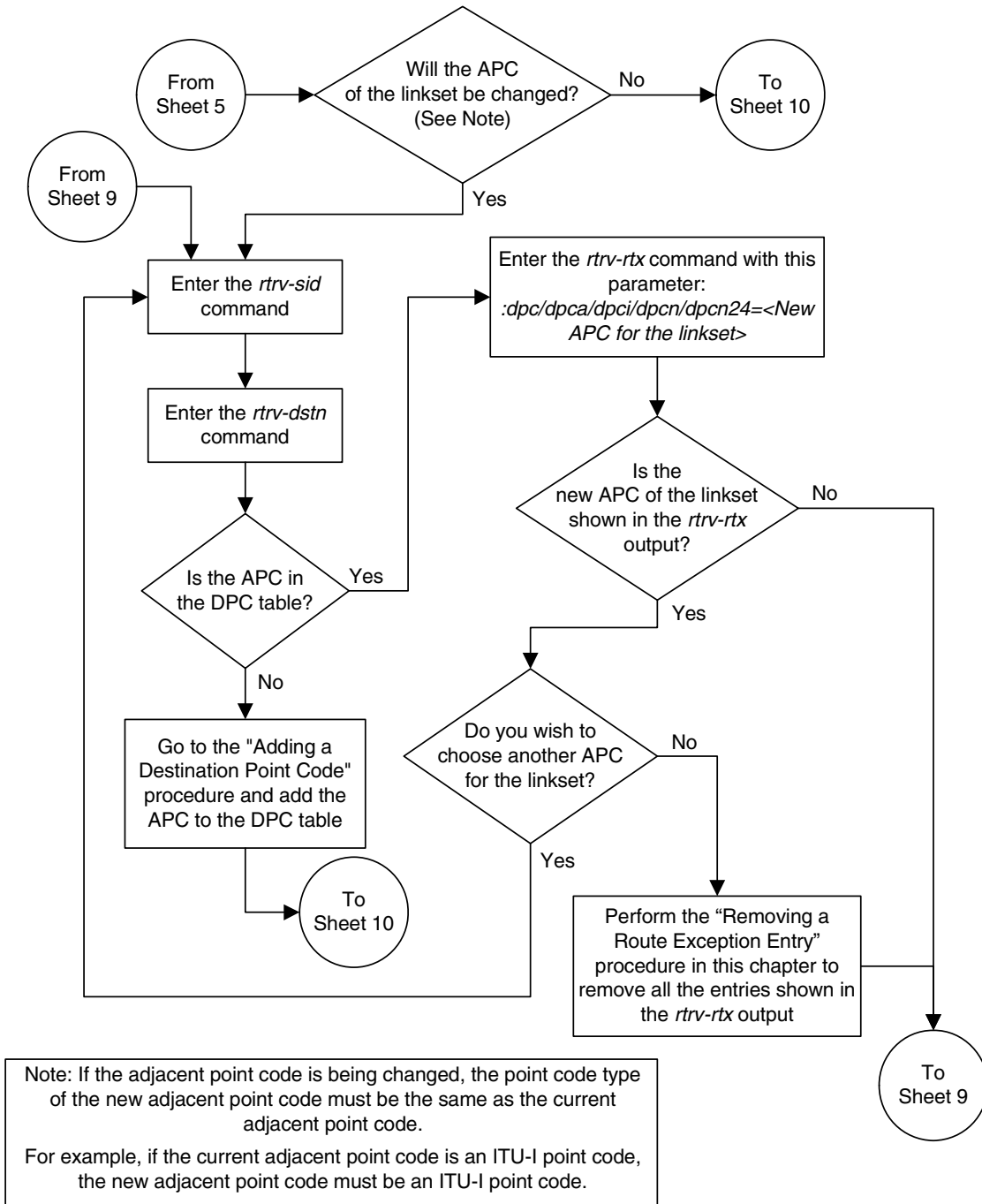

Flowchart 3-3. Configuring an IPGWx Linkset (Sheet 9 of 10)

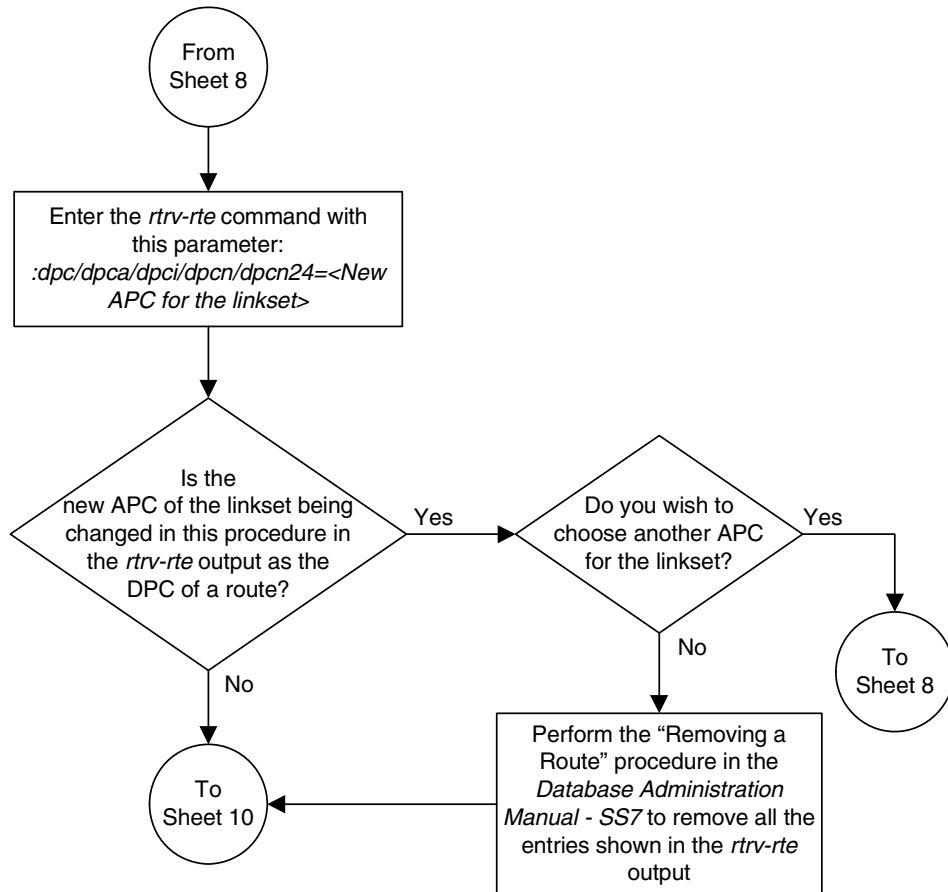

Flowchart 3-3. Configuring an IPGWx Linkset (Sheet 10 of 10)

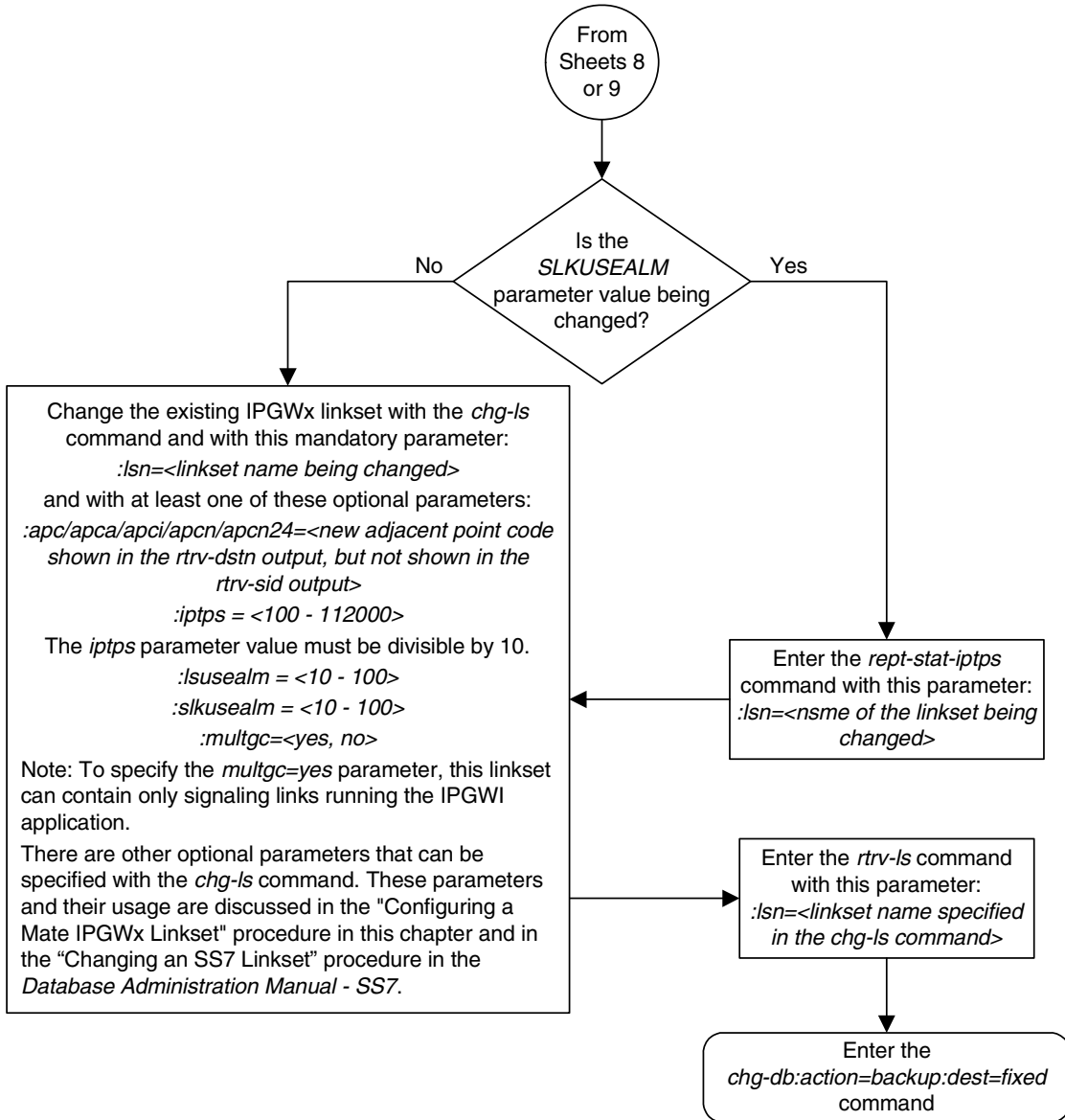

Configuring a Mate IPGWx Linkset

This procedure is used to configure a mate IPGWx linkset to an existing IPGWx linkset **chg-ls** command with these parameters.

:lsn – The name of the linkset. The linkset name can contain up to 10 characters, with the first character being a letter. However, the SEAS interface supports only eight characters. If this linkset is displayed on the SEAS interface and the linkset name contains more than eight characters, only the first eight characters in the linkset name are shown. If this linkset name contains more than eight characters, and is specified with the linkset commands on the SEAS interface, only the first eight characters can be specified.

:matelsn – The name of the mate IPGWx linkset.

:action – to add (**action=add**) or remove (**action=delete**) the mate IPGWx linkset to the IPGWx linkset specified by the **lsn** parameter.

NOTE: This procedure is not used to configure an IPGWx linkset, with the **ipgwapc**, **iptps**, **lsusealm** and **slkusealm** parameters. To configure an IPGWx linkset with these parameters, perform the “Configuring an IPGWx Linkset” procedure on page 3-37.

An IPGWx linkset is a linkset that contains signaling links assigned to IPGWx cards. IPGWx cards are cards running either the SS7IPGW or IPGWI applications.

The EAGLE 5 ISS allows an IPGWx linkset to contain up to 8 IPGWx signaling links, and as a result, 8 IPGWx cards. This increases the amount of traffic that can be delivered to a single IP node compared to the two-card combined IPGWx linkset deployments used in previous releases. An IPGWx linkset containing up to 8 IPGWx signaling links is the preferred method of configuring IPGWx linksets (see the “Configuring an IPGWx Linkset” procedure on page 3-37). This method is required if more than two IPGWx signaling links are to be used in the linkset.

To provide backward compatibility with pre-existing two-card combined IPGWx linkset deployments, the EAGLE 5 ISS also provides for a mate IPGWx linkset. A mate IPGWx linkset consists of one IPGWx linkset assigned to another IPGWx linkset using the **matelsn** parameter of the **chg-ls** command. To assign a mate IPGWx linkset to another IPGWx linkset, both linksets can contain no more than one signaling link. While mate IPGWx linksets can be configured using this procedure, the preferred method of configuring two-card IPGWx deployments is to configure a two-link non-mated linkset using the “Configuring an IPGWx Linkset” procedure on page 3-37.

Each linkset in the mated pair must either contain no mate linksets, or can reference the other linkset in the mated pair. For example, to assign linkset **LSN2** to IPGWx linkset **LSN1** as a mate linkset, linkset **LSN1** cannot contain any mate linksets. Linkset **LSN2** can have linkset **LSN1** as a mate, otherwise linkset **LSN2** cannot have any mate linksets assigned to it.

The mate linkset name is displayed in the **rtrv-ls:lsn=<linkset name>** command output. If either linkset contains more than one signaling link, all but

one of the signaling links must be removed from these linksets or other linksets must be chosen. Perform the “Removing an IP Signaling Link” procedure on page 3-113 to remove any signaling links from the linkset. If new linksets must be configured for this procedure, perform the “Configuring an IPGWx Linkset” procedure on page 3-37.

Before a mate IPGWx linkset can be added to an IPGWx linkset, the card containing the IPGWx signaling link assigned to the linkset being changed, and the signaling link assigned to that card must be placed out of service.

Before a mate IPGWx linkset can be removed from an IPGWx linkset, the card containing the IPGWx signaling link assigned to the mate linkset, and the signaling link assigned to that card must be placed out of service.

The network type of the adjacent point code of the mate IPGWx linkset must be the same type as the linkset the mate is assigned to. For example, if a mate IPGWx linkset is assigned to an IPGWx linkset with an ITU-I adjacent point code, the mate IPGWx linkset must have an ITU-I adjacent point code.

Other Optional Parameters

Other optional parameters, shown in Table 3-8, can be used with the **chg-ls** command but do not need to be used in this procedure. These parameters are discussed in more detail in the “Changing an SS7 Linkset” procedures in the *Database Administration Manual - SS7*. The **iptps**, **lsusealm**, and **slkusealm** parameters are discussed in more detail in the “Configuring an IPGWx Linkset” procedure on page 3-37.

Table 3-8. Optional Linkset Parameters

| | | | | | |
|---|---------|---------|--------|------------|-----------|
| cli | sltset | l3tset | scrn | gwsa | gwsn |
| gwsd | bei | nis | itutfr | mtpse* | slsci |
| asl8 | slsrsb | slsobit | multgc | tfatcabmlq | gmscrn |
| sapci | sapcn | sapcn24 | iptps | lsusealm | slkusealm |
| apcntype | gttmode | randsls | | | |
| * The mtpse parameter cannot be specified for an IPGWx linkset. | | | | | |

Procedure

1. Display the system-wide IP TPS usage report, and the IPGWx linksets, by entering the `rept-stat-iptps` command. This is an example of the possible output.

```
rlghncxa03w 06-10-10 11:43:04 GMT EAGLE5 36.0.0

IP TPS USAGE REPORT

-----
                THRESH  CONFIG          TPS      PEAK      PEAKTIMESTAMP
-----
SYSTEM
RLGHNCXA03W  100%   30000  TX:   7200    7600   05-02-10 11:40:04
                                RCV:   7200    7600   05-02-10 11:40:04
-----
LSN
LSGW1101      80%    6000  TX:   5100    5500   05-02-10 11:40:04
                                RCV:   5100    5500   05-02-10 11:40:04
LSGW1103      80%    6000  TX:   5200    5500   05-02-10 11:40:04
                                RCV:   5200    5500   05-02-10 11:40:04
LSGW1105      80%   14000  TX:   7300    7450   05-02-10 11:40:04
                                RCV:   7300    7450   05-02-10 11:40:04
LSGW1107      70%    4000  TX:   3200    3500   05-02-10 11:40:04
                                RCV:   3200    3500   05-02-10 11:40:04
-----
Command Completed.
```

2. Display the linkset that is being changed by entering the `rtrv-ls` command with a linkset name shown in the `rept-stat-iptps` output in step 1. For this example, enter this command.

```
rtrv-ls:lsn=lsqw1103
```

This is an example of the possible output.

```
rlghncxa03w 06-10-17 11:43:04 GMT EAGLE5 36.0.0

LSN          APCA  (SS7)  SCRNR  SET SET BEI LST LNKS ACT MES DIS SLSCI NIS
lsqw1103     003-002-004  none  1  1  no  A  1  off off off no  off

CLLI          TFATCABMLQ MTPRSE ASL8
-----
1              no    no

IPGWAPC MATELSN  IPTPS LSUSEALM SLKUSEALM GTTMODE
yes      ----- 10000 70    % 70    % CdPA

LOC  LINK SLC TYPE          L2T          L1          PCR  PCR
SET  BPS          MODE TSET  ECM  N1  N2

LOC  LINK SLC TYPE          LP          ATM          VCI  VPI  LL
SET  BPS          TSEL          VCI  VPI  LL

LOC  LINK SLC TYPE          LP          ATM          VCI  VPI  CRC4 SI SN
SET  BPS          TSEL          VCI  VPI  CRC4 SI SN

LOC  LINK SLC TYPE          IPLIML2
```

```

LOC LINK SLC TYPE
1103 A 0 SS7IPGW

LOC LINK SLC TYPE L2T PCR PCR E1 E1
SET BPS ECM N1 N2 LOC PORT TS

LOC LINK SLC TYPE L2T PCR PCR T1 T1
SET BPS ECM N1 N2 LOC PORT TS

```

Link set table is (14 of 1024) 1% full

If this linkset has a mate linkset assigned to it, the name of the mate linkset is shown in the **MATELSN** field of the **rtrv-ls** output, as shown in the following output.

rtrv-ls:lsn=lsgw1103

This is an example of the possible output.

```

rlghncxa03w 06-10-17 11:43:04 GMT EAGLE5 36.0.0

LSN          APCA  (SS7)  SCRN  L3T SLT          GWS GWS GWS
lsgw1103     003-002-004  none  1  1  no  A  1  off off off no  off

CLLI          TFATCABMLQ MTPRSE ASL8
----- 1          no  no

IPGWAPC MATELSN  IPTPS LSUSEALM SLKUSEALM GTTMODE
yes      lsgw1107  10000 70      % 70      % CdPA

LOC LINK SLC TYPE L2T L1 PCR PCR
SET BPS MODE TSET ECM N1 N2

LOC LINK SLC TYPE LP ATM
SET BPS TSEL VCI VPI LL

LOC LINK SLC TYPE LP ATM E1ATM
SET BPS TSEL VCI VPI CRC4 SI SN

LOC LINK SLC TYPE IPLIML2

LOC LINK SLC TYPE
1103 A 0 SS7IPGW

LOC LINK SLC TYPE L2T PCR PCR E1 E1
SET BPS ECM N1 N2 LOC PORT TS

LOC LINK SLC TYPE L2T PCR PCR T1 T1
SET BPS ECM N1 N2 LOC PORT TS

Link set table is ( 14 of 1024) 1% full

```

NOTE: If the linkset being changed has no signaling links, or only one signaling link assigned to it, or if the mate linkset is being removed from the linkset being changed, skip step 3 and go to step 4.

3. To assign a mate linkset to this linkset, and the linkset contains more than one signaling link, all but one of these signaling links must be removed from the linkset. Perform the "Removing an IP Signaling Link" procedure on page 3-113 to remove these signaling links.

If you do not wish to change this linkset, either choose another linkset from the **rept-stat-iptps** output in step 1, and repeat step 2, and 3 if necessary, or perform the "Configuring an IPGWx Linkset" procedure on page 3-37 and add a new linkset. Go to step 4.

4. If a mate linkset is being added in this procedure, display the mate linkset from the IPGWx linksets shown in the **rept-stat-iptps** output in step 1. If a mate linkset is being removed in this procedure, display the mate linkset shown in the **MATELSN** column of the **rtrv-ls** output in step 2.

For this example, enter this command.

rtrv-ls:lsn=lsgw1107

This is an example of the possible output.

```

rlghncxa03w 06-10-17 11:43:04 GMT EAGLE5 36.0.0

LSN              APCA  (SS7)  SCRN  L3T SLT          GWS GWS GWS
lsgw1107         003-002-004 none  1    1    no  A   1    off off off no  off

CLLI              TFATCABMLQ MTPRSE ASL8
----- 1                no    no

IPGWAPC MATELSN      IPTPS LSUSEALM  SLKUSEALM  GTTMODE
yes      ----- 10000 70    % 70    % CdPA

LOC  LINK  SLC  TYPE          L2T          L1          PCR  PCR
      SET  BPS          MODE TSET      ECM  N1   N2

LOC  LINK  SLC  TYPE          LP           ATM          VCI   VPI   LL
      SET  BPS          TSEL          VCI   VPI   CRC4 SI SN

LOC  LINK  SLC  TYPE          LP           ATM          VCI   VPI   CRC4 SI SN
      SET  BPS          TSEL          VCI   VPI   CRC4 SI SN

LOC  LINK  SLC  TYPE          IPLIML2

LOC  LINK  SLC  TYPE
1107 A    0    SS7IPGW

LOC  LINK  SLC  TYPE          L2T          PCR  PCR  E1  E1
      SET  BPS          ECM  N1   N2  LOC  PORT TS

LOC  LINK  SLC  TYPE          L2T          PCR  PCR  T1  T1
      SET  BPS          ECM  N1   N2  LOC  PORT TS

Link set table is ( 14 of 1024) 1% full
    
```

NOTE: If the mate linkset is being removed from the linkset being changed, skip step 5 and go to step 6.

5. To use the linkset shown in step 4 as a mate, the network type of the adjacent point code of the linkset shown in step 4 must be the same as the network type of the linkset shown in step 2. The linkset shown in step 4 must not have more than one signaling link assigned to it.

If the linkset contains more than one signaling link, all but one of these signaling links must be removed from the linkset. Perform the “Removing an IP Signaling Link” procedure on page 3-113 to remove these signaling links.

If you do not wish to change this linkset, or if the network type of the adjacent point codes of both linksets are not the same, either choose another linkset from the `rept-stat-iptps` output in step 1, and repeat step 4, and 5 if necessary, or perform the “Configuring an IPGWx Linkset” procedure on page 3-37 and add a new linkset. Go to step 6.

If the network types of the adjacent point codes of both linksets are the same, and the mate linkset contains no more than one signaling link, do not perform the actions in this step. Go to step 6.

NOTE: If the linkset that the mate linkset is being added to has no signaling links (see the `rtrv-ls` output in step 2), skip steps 6 through 16, and go to step 17.

NOTE: If the mate linkset is being removed in this procedure, and has no signaling links (see the `rtrv-ls` output in step 4), skip steps 6 through 16, and go to step 17.

6. Display the status of the card containing the signaling link assigned to the linkset being changed by entering the `rept-stat-card` command with the card location shown in the `LOC` field in the `rtrv-ls` output in step 2 (for adding a mate linkset) or in the `rtrv-ls` output in step 4 (for removing a mate linkset). For this example, enter one of these commands.

`rept-stat-card:loc=1103` (for the adding a mate linkset example)

This is an example of the possible output.

```
rlghncxa03w 06-10-27 17:00:36 GMT EAGLE5 36.0.0
CARD VERSION      TYPE  APPL   PST          SST      AST
1103  114-000-000  DCM   SS7IPGW  IS-NR        Active   -----
  ALARM STATUS      = No Alarms.
  BPDCM GPL         = 002-102-000
  IMT BUS A         = Conn
  IMT BUS B         = Conn
  SIGNALING LINK STATUS
  SLK  PST          LS          CLLI
  A    IS-NR        lsgw1103   -----
```

Command Completed.

`rept-stat-card:loc=1107` (for the removing a mate linkset example)

This is an example of the possible output.

```
rlghncxa03w 06-10-27 17:00:36 GMT EAGLE5 36.0.0
CARD VERSION      TYPE      APPL      PST      SST      AST
1107 114-000-000  DCM      SS7IPGW  IS-NR    Active   -----
ALARM STATUS      = No Alarms.
BPDCM GPL         = 002-102-000
IMT BUS A         = Conn
IMT BUS B         = Conn
SIGNALING LINK STATUS
SLK  PST          LS          CLLI
A    IS-NR        lsgw1107   -----
```

Command Completed.

NOTE: If the status of the card shown in `PST` field in the `rept-stat-card` output in step 6 is `OOS-MT-DSBLD`, skip steps 7 through 16, and go to step 17.

7. Display the status of the signaling link assigned to the card shown in step 6 by entering the `rept-stat-slk` command with the card location used in step 6 and the `link=a` parameter. For this example, enter one of these commands.

`rept-stat-slk:loc=1103:link=a` (for the adding a mate linkset example)

This is an example of the possible output.

```
rlghncxa03w 06-10-27 17:00:36 GMT EAGLE5 36.0.0
SLK  LSN          CLLI          PST          SST          AST
1103,A  lsgw1103     -----  IS-NR        Avail        -----
ALARM STATUS      = No Alarms.
UNAVAIL REASON    = NA
```

Command Completed.

`rept-stat-slk:loc=1107:link=a` (for the removing a mate linkset example)

This is an example of the possible output.

```
rlghncxa03w 06-10-27 17:00:36 GMT EAGLE5 36.0.0
SLK  LSN          CLLI          PST          SST          AST
1107,A  lsgw1107     -----  IS-NR        Avail        -----
ALARM STATUS      = No Alarms.
UNAVAIL REASON    = NA
```

Command Completed.

NOTE: If the status of the signaling link shown in the `PST` field of the `rept-stat-slk` output in step 7 is `OOS-MT-DSBLD`, skip steps 8 through 15, and go to step 16.

8. Any in-service IP connections on the signaling link shown in step 7 must be placed out of service. The recommended method is to have the far end node place these IP connections out of service. Have the far-end node for the signaling link shown in step 7 perform these actions:

- Place the TALI sockets in the NEA-FEP state.
- Place the M3UA or SUA associations in either the ASP-INACTIVE or ASP-DOWN state.

NOTE: If you choose to perform this step, skip steps 9 through 16, and go to step 17.

9. Display the IP link associated with the card that the signaling link shown in step 7 is assigned to by entering the **rtrv-ip-lnk** command with the card location shown in step 7. For this example, enter one of these commands.

rtrv-ip-lnk:loc=1103 (for the adding a mate linkset example)

The following is an example of the possible output.

```
rlghncxa03w 06-10-28 21:14:37 GMT EAGLE5 36.0.0
LOC  PORT IPADDR          SUBMASK          DUPLEX  SPEED  MACTYPE AUTO  MCAST
1103 A    192.1.1.10          255.255.255.128  HALF    10     802.3  NO   NO
1103 B    -----             -----          HALF    10     DIX    NO   NO
```

rtrv-ip-lnk:loc=1107 (for the removing a mate linkset example)

The following is an example of the possible output.

```
rlghncxa03w 06-10-28 21:14:37 GMT EAGLE5 36.0.0
LOC  PORT IPADDR          SUBMASK          DUPLEX  SPEED  MACTYPE AUTO  MCAST
1107 A    192.3.1.10          255.255.255.128  HALF    10     802.3  NO   NO
1107 B    -----             -----          HALF    10     DIX    NO   NO
```

10. Display the IP host information associated with the IP link by entering the **rtrv-ip-host** command with the IP address shown in step 9. For this example, enter one of these commands.

rtrv-ip-host:ipaddr=192.001.001.010 (for the adding a mate linkset example)

The following is an example of the possible output.

```
rlghncxa03w 06-10-28 21:17:37 GMT EAGLE5 36.0.0

LOCAL IPADDR    LOCAL HOST
192.1.1.10      IPNODE1_1103
```

IP Host table is (11 of 512) 2% full

rtrv-ip-host:ipaddr=192.003.001.010 (for the removing a mate linkset example)

The following is an example of the possible output.

```
rlghncxa03w 06-10-28 21:17:37 GMT EAGLE5 36.0.0

LOCAL IPADDR    LOCAL HOST
192.3.1.10      IPNODE1_1107
```

IP Host table is (11 of 512) 2% full

11. Display the socket associated with the local host name shown in step 10 by entering the **rtrv-appl-sock** command. For this example, enter one of these commands.

rtrv-appl-sock:lhost=ipnode1_1103 (for the adding a mate linkset example)

The following is an example of the possible output.

```
rlghncxa03w 06-10-28 21:14:37 GMT EAGLE5 36.0.0
SNAME KC_HLR1_1103
      LINK      A
```

```
LHOST    IPNODE1_1103
RHOST    KC_HLR2
LPORT    7000          RPORT    7001
SERVER   YES          DCMPS    1
REXMIT   FIXED       RTT      60
OPEN     YES          ALW      YES
```

IP Appl Sock/Assoc table is (4 of 4000) 1% full

rtrv-appl-sock: lhost=ipnode1_1107 (for the removing a mate linkset example)

The following is an example of the possible output.

```
rlghncxa03w 06-10-28 21:14:37 GMT EAGLE5 36.0.0
```

IP Appl Sock/Assoc table is (4 of 4000) 1% full

NOTE: If the specified socket name is not in the database, the rtrv-appl-sock output shows no socket information as shown above.

NOTE: If there is no socket shown in step 11, or the open and alw parameter values of the socket shown in step 11 are no, skip this step and step 13, and go to step 14.

- Change the **alw** parameter values in the socket shown in step 11 using the **chg-appl-sock** command with the **alw=no** parameters, as necessary.

For example, enter this command.

```
chg-appl-sock:sname=kc_hlr1_1103:alw=no
```



CAUTION: This command impacts network performance and should only be used during periods of low traffic.

When this command has successfully completed, the following message should appear.

```
rlghncxa03w 06-10-28 21:16:37 GMT EAGLE5 36.0.0
CHG-APPL-SOCK: MASP A - COMPLTD
```

Repeat this step for all sockets shown in step 11.

- Change the **open** parameter values in the socket shown in step 11 using the **chg-appl-sock** command with the **open=no** parameters, as necessary.

For example, enter this command.

```
chg-appl-sock:sname=kc_hlr1_1103:open=no
```

When this command has successfully completed, the following message should appear.

```
rlghncxa03w 06-10-28 21:16:37 GMT EAGLE5 36.0.0
CHG-APPL-SOCK: MASP A - COMPLTD
```

Repeat this step for all sockets shown in step 11.

14. Display the association associated with the local host name shown in step 10 by entering the `rtrv-assoc` command. For this example, enter one of these command.

`rtrv-assoc: lhost=ipnode1_1107` (for the removing a mate linkset example)

This is an example of possible output.

```
rlghncxa03w 06-10-28 09:12:36 GMT EAGLE5 36.0.0
                CARD IPLNK
ANAME          LOC  PORT  LINK ADAPTER LPORT RPORT OPEN ALW
assoc1         1107 A    A    M3UA   1030  1030  YES  YES
```

```
IP Appl Sock/Assoc table is (4 of 4000) 1% full
Assoc Buffer Space Used (16 KB of 3200 KB) on LOC = 1107
```

`rtrv-assoc: lhost=ipnode1_1103` (for the adding a mate linkset example)

The following is an example of the possible output.

```
rlghncxa03w 06-10-28 21:14:37 GMT EAGLE5 36.0.0
```

```
IP Appl Sock/Assoc table is (4 of 4000) 1% full
```

NOTE: If the specified association name is not in the database, the `rtrv-assoc` output shows no association information as shown above.

NOTE: If there is no association shown in step 14, or the `open` and `alw` parameter values of the association shown in step 14 are `no`, skip this step and step 16, and go to step 17.

15. Change the `alw` parameter values in the association shown in step 14 using the `chg-assoc` command with the `alw=no` parameters, as necessary.

`chg-assoc: aname=assoc1: alw=no`



CAUTION: This command impacts network performance and should only be used during periods of low traffic.

When this command has successfully completed, this message should appear.

```
rlghncxa03w 06-10-28 09:12:36 GMT EAGLE5 36.0.0
CHG-ASSOC: MASP A - COMPLTD
```

Repeat this step for all associations shown in step 14.

16. Change the `open` parameter values in the association shown in step 14 using the `chg-assoc` command with the `open=no` parameters, as necessary.

`chg-assoc: aname=assoc1: open=no`

When this command has successfully completed, this message should appear.

```
rlghncxa03w 06-10-28 09:12:36 GMT EAGLE5 36.0.0
CHG-ASSOC: MASP A - COMPLTD
```

Repeat this step for all associations shown in step 14.

17. Deactivate the signaling link assigned to the IP card using the `dact-slk` command. For example, enter one of these commands:

`dact-slk:loc=1103:link=a` (for the adding a mate linkset example)

`dact-slk:loc=1107:link=a` (for the removing a mate linkset example)



CAUTION: This command impacts network performance and should only be used during periods of low traffic.

After this command has successfully completed, this message appears.

```
rlghncxa03w 06-10-12 09:12:36 GMT EAGLE5 36.0.0
Deactivate Link message sent to card.
```

18. Inhibit the IP card using the `inh-card` command. For example, enter one of these commands.

`inh-card:loc=1103` (for the adding a mate linkset example)

`inh-card:loc=1107` (for the removing a mate linkset example)

This message should appear.

```
rlghncxa03w 06-10-28 21:18:37 GMT EAGLE5 36.0.0
Card has been inhibited.
```

19. Change the linkset shown in step 2 with the `chg-ls` command. If a mate IPGWx linkset is being added, use the `matelsn` and `action=add` parameters with the `chg-ls` command. If a mate IPGWx linkset is being removed, use the `matelsn` and `action=delete` parameters with the `chg-ls` command.

To add a mate linkset in this example, enter this command.

`chg-ls:lsn=lsgw1103:matelsn=lsgw1107:action=add`

To remove a mate linkset in this example, enter this command.

`chg-ls:lsn=lsgw1103:matelsn=lsgw1107:action=delete`

NOTE: There are other optional parameters that can be specified with the `chg-ls` command, but are not required for an IPGWx linkset. These parameters and their usage are discussed in the “Configuring an IPGWx Linkset” procedure on page 3-37 and in the “Changing an SS7 Linkset” procedure in the *Database Administration Manual - SS7*.

When the `chg-ls` command has successfully completed, this message should appear.

```
rlghncxa03w 06-10-17 16:23:21 GMT EAGLE5 36.0.0
Link set table is ( 14 of 1024) 1% full
CHG-LS: MASP A - COMPLTD
```

20. Verify the changes using the **rtrv-ls** command specifying the linkset name specified in step 19 with the **lsn** parameter. For this example, enter this command.

rtrv-ls:lsn=lsgw1103

This is an example of the possible output.

```
rlghncxa03w 06-10-17 11:43:04 GMT EAGLE5 36.0.0

LSN          APCA  (SS7)  SCRN  SET SET BEI LST LNKS  ACT MES  DIS  SLSCI  NIS
lsgw1103     003-002-004  none  1   1   no  A   1   off off off no   off

CLLI          TFATCABMLQ MTPRSE  ASL8
-----      1           no     no

IPGWAPC  MATELSN  IPTPS  LSUSEALM  SLKUSEALM  GTTMODE
yes      lsgw1107  10000  70       % 70       % CdPA

LOC  LINK  SLC  TYPE          L2T          L1          PCR  PCR
SET  BPS  MODE  TSET  ECM  N1  N2

LOC  LINK  SLC  TYPE          LP          ATM          VCI  VPI  LL
SET  BPS  TSEL

LOC  LINK  SLC  TYPE          LP          ATM          VCI  VPI  CRC4  SI  SN
SET  BPS  TSEL

LOC  LINK  SLC  TYPE          IPLIML2

LOC  LINK  SLC  TYPE
1103  A    0    SS7IPGW

LOC  LINK  SLC  TYPE          L2T          PCR  PCR  E1  E1
SET  BPS  ECM  N1  N2  LOC  PORT  TS

LOC  LINK  SLC  TYPE          L2T          PCR  PCR  T1  T1
SET  BPS  ECM  N1  N2  LOC  PORT  TS
```

Link set table is (14 of 1024) 1% full

If the mate linkset was removed in step 19, the **MATELSN** column of the **rtrv-ls** output should contain dashes, as shown in the following example.

rtrv-ls:lsn=lsgw1103

This is an example of the possible output.

```
rlghncxa03w 06-10-17 11:43:04 GMT EAGLE5 36.0.0

LSN          APCA  (SS7)  SCRN  SET SET BEI LST LNKS  ACT MES  DIS  SLSCI  NIS
lsgw1103     003-002-004  none  1   1   no  A   1   off off off no   off

CLLI          TFATCABMLQ MTPRSE  ASL8
-----      1           no     no

IPGWAPC  MATELSN  IPTPS  LSUSEALM  SLKUSEALM  GTTMODE
yes      -----  10000  70       % 70       % CdPA
```

IP7 Secure Gateway Configuration Procedures

```
LOC LINK SLC TYPE      L2T      L1      PCR PCR
SET BPS      MODE TSET  ECM  N1  N2

LOC LINK SLC TYPE      LP      ATM
SET BPS      TSEL      VCI      VPI  LL

LOC LINK SLC TYPE      LP      ATM      E1ATM
SET BPS      TSEL      VCI  VPI  CRC4 SI SN

LOC LINK SLC TYPE      IPLIML2

LOC LINK SLC TYPE
1103 A      0  SS7IPGW

LOC LINK SLC TYPE      L2T      PCR PCR  E1  E1
SET BPS      ECM  N1  N2  LOC  PORT TS

LOC LINK SLC TYPE      L2T      PCR PCR  T1  T1
SET BPS      ECM  N1  N2  LOC  PORT TS
```

Link set table is (14 of 1024) 1% full

NOTE: If the linkset shown in step 20 does not have a signaling link assigned to it, skip steps 21 through 25, and go to step 26.

21. Allow the IP card that was inhibited in step 18 using the **alw-card** command. For example, enter one of these commands.

alw-card:loc=1103 (for the adding a mate linkset example)

alw-card:loc=1107 (for the removing a mate linkset example)

This message should appear.

```
rlghncxa03w 06-10-28 21:21:37 GMT EAGLE5 36.0.0
Card has been allowed.
```

-
22. Activate the signaling link from step 17 using the **act-slk** command. For example, enter one of these commands.

act-slk:loc=1103:link=a (for the adding a mate linkset example)

act-slk:loc=1107:link=a (for the removing a mate linkset example)

The output confirms the activation.

```
rlghncxa03w 06-10-07 11:11:28 GMT EAGLE5 36.0.0
Activate Link message sent to card
```

NOTE: If steps 12 and 13 were not performed, skip this step and go to step 24.

23. Change the **open** and **alw** parameter values for all the sockets that were changed in steps 12 or 13 using the **chg-appl-sock** command with the **open=yes** and **alw=yes** parameters.

For example, enter this command.

```
chg-appl-sock:sname=kc_hlr1_1103:open=yes:alw=yes
```

When this command has successfully completed, the following message should appear.

```
rlghncxa03w 06-10-28 21:16:37 GMT EAGLE5 36.0.0
CHG-APPL-SOCK: MASP A - COMPLTD
```

NOTE: If steps 15 and 16 were not performed, skip this step and go to step 25.

24. Change the **open** and **alw** parameter values for all the associations changed in steps 15 or 16 using the **chg-assoc** command with the **open=yes** and **alw=yes** parameters.

```
chg-assoc:aname=assoc1:open=yes:alw=yes
```

When this command has successfully completed, this message should appear.

```
rlghncxa03w 06-10-28 09:12:36 GMT EAGLE5 36.0.0
CHG-ASSOC: MASP A - COMPLTD
```

25. Have the far-end node for the signaling link shown in step 20 perform these actions to place the IP connections on the signaling link into service:

- Place the TALI sockets in the NEA-FEA state.
 - Place the M3UA or SUA associations in the ASP-ACTIVE state.
-

26. Back up the new changes using the **chg-db:action=backup:dest=fixed** command. These messages should appear, the active Maintenance and Administration Subsystem Processor (MASP) appears first.

```
BACKUP (FIXED) : MASP A - Backup starts on active MASP.
BACKUP (FIXED) : MASP A - Backup on active MASP to fixed disk complete.
BACKUP (FIXED) : MASP A - Backup starts on standby MASP.
BACKUP (FIXED) : MASP A - Backup on standby MASP to fixed disk complete.
```

Flowchart 3-4. Configuring a Mate IPGWx Linkset (Sheet 1 of 7)

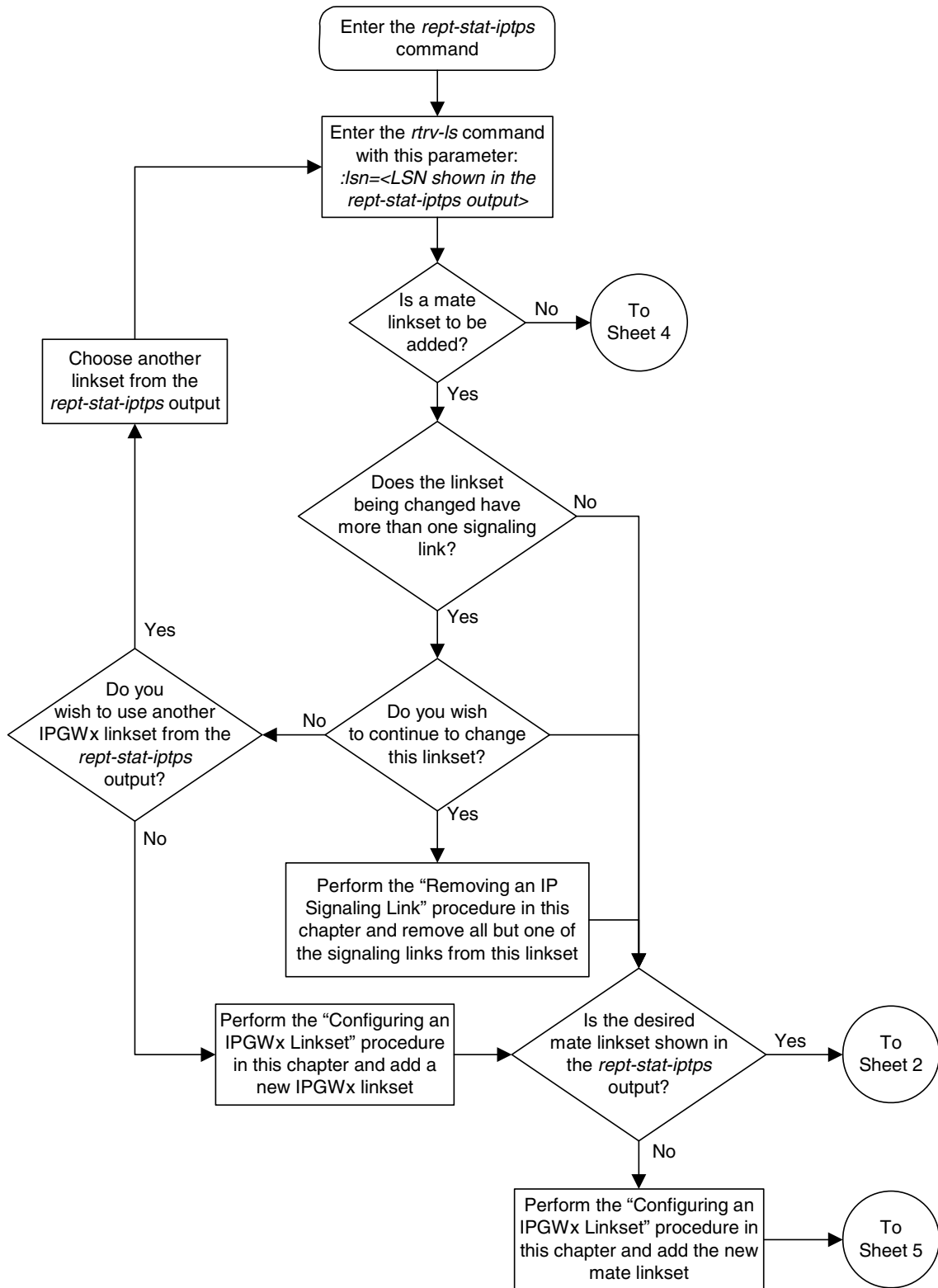

Flowchart 3-4. Configuring a Mate IPGWx Linkset (Sheet 2 of 7)

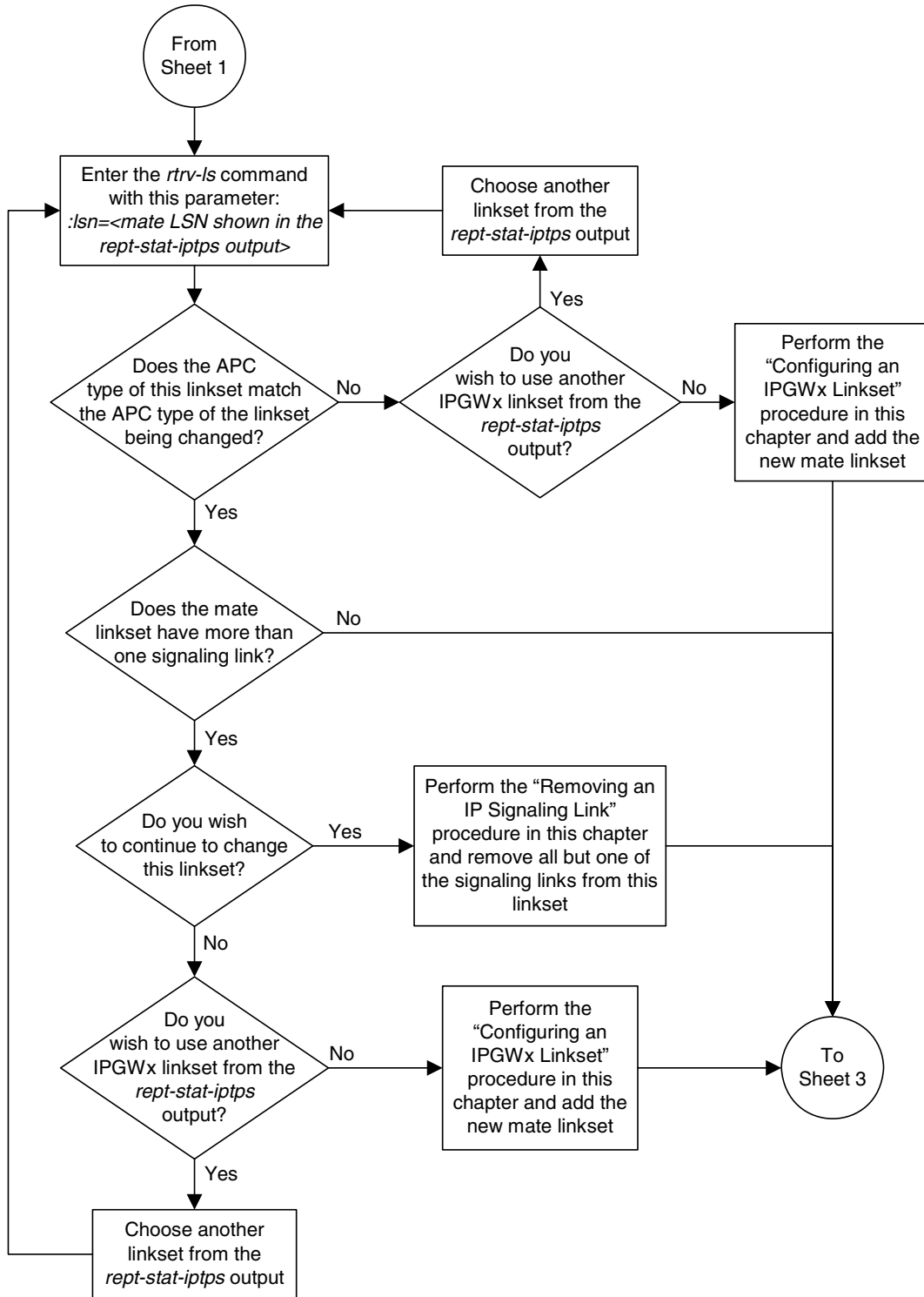

Flowchart 3-4. Configuring a Mate IPGWx Linkset (Sheet 3 of 7)

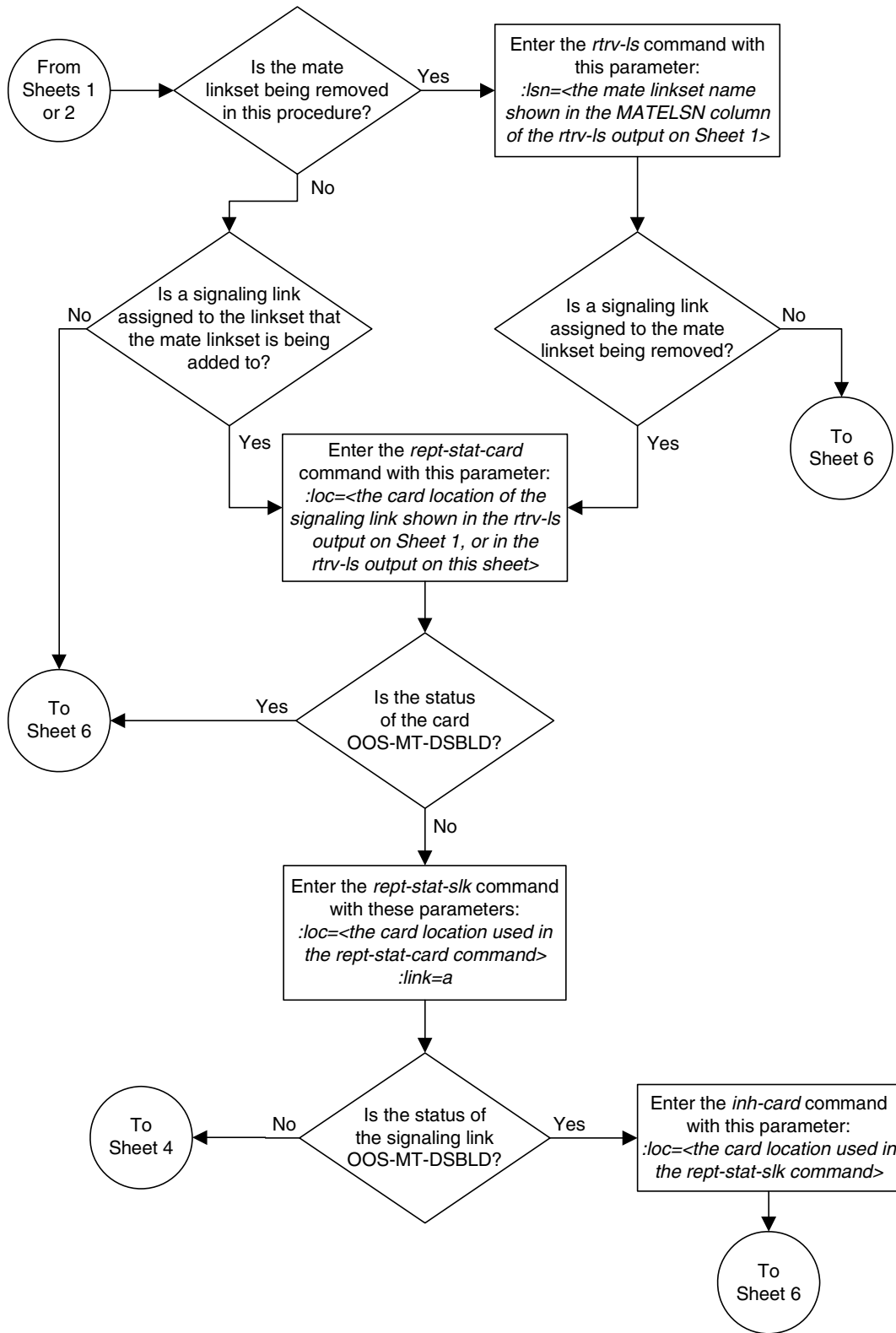

Flowchart 3-4. Configuring a Mate IPGWx Linkset (Sheet 4 of 7)

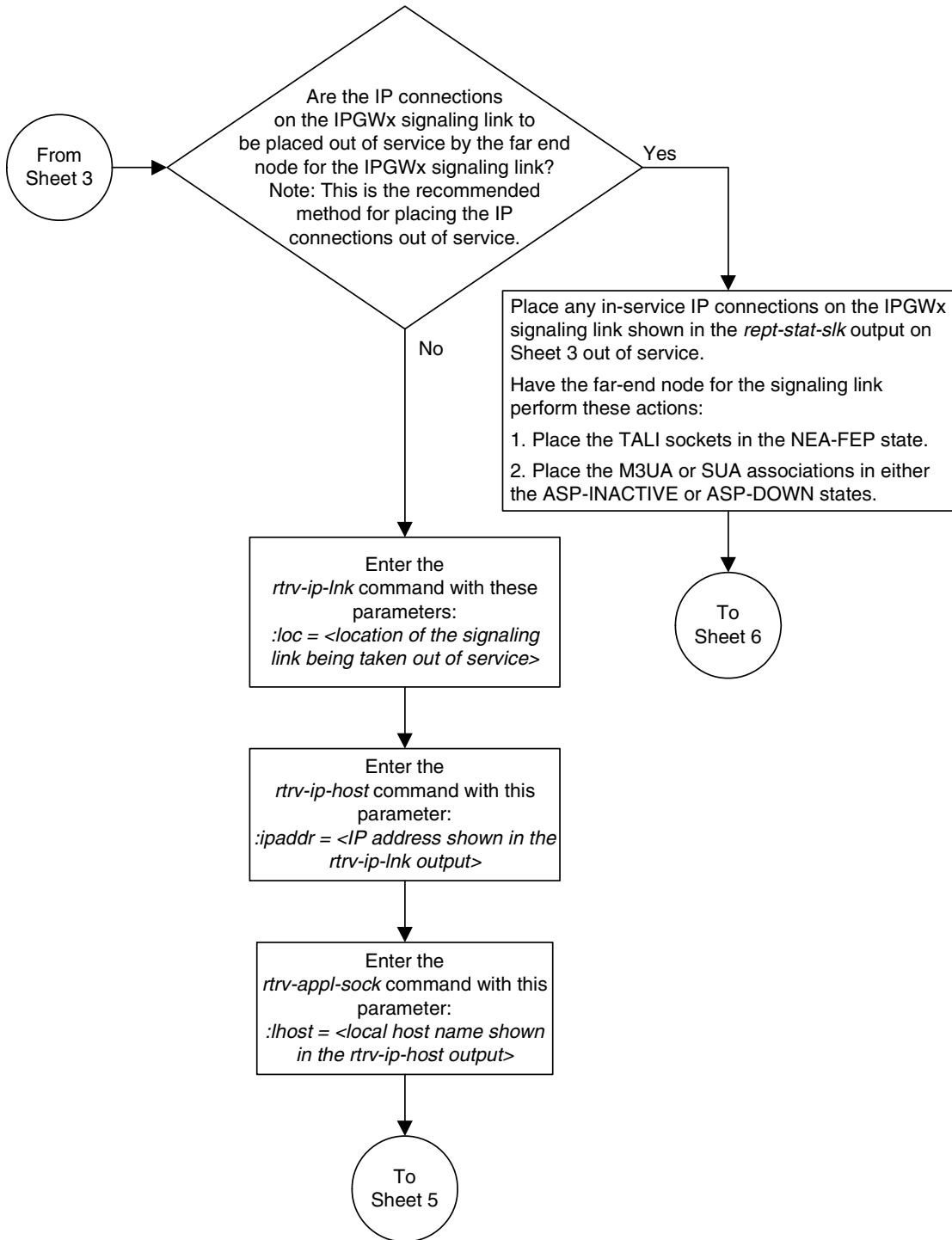

Flowchart 3-4. Configuring a Mate IPGWx Linkset (Sheet 5 of 7)

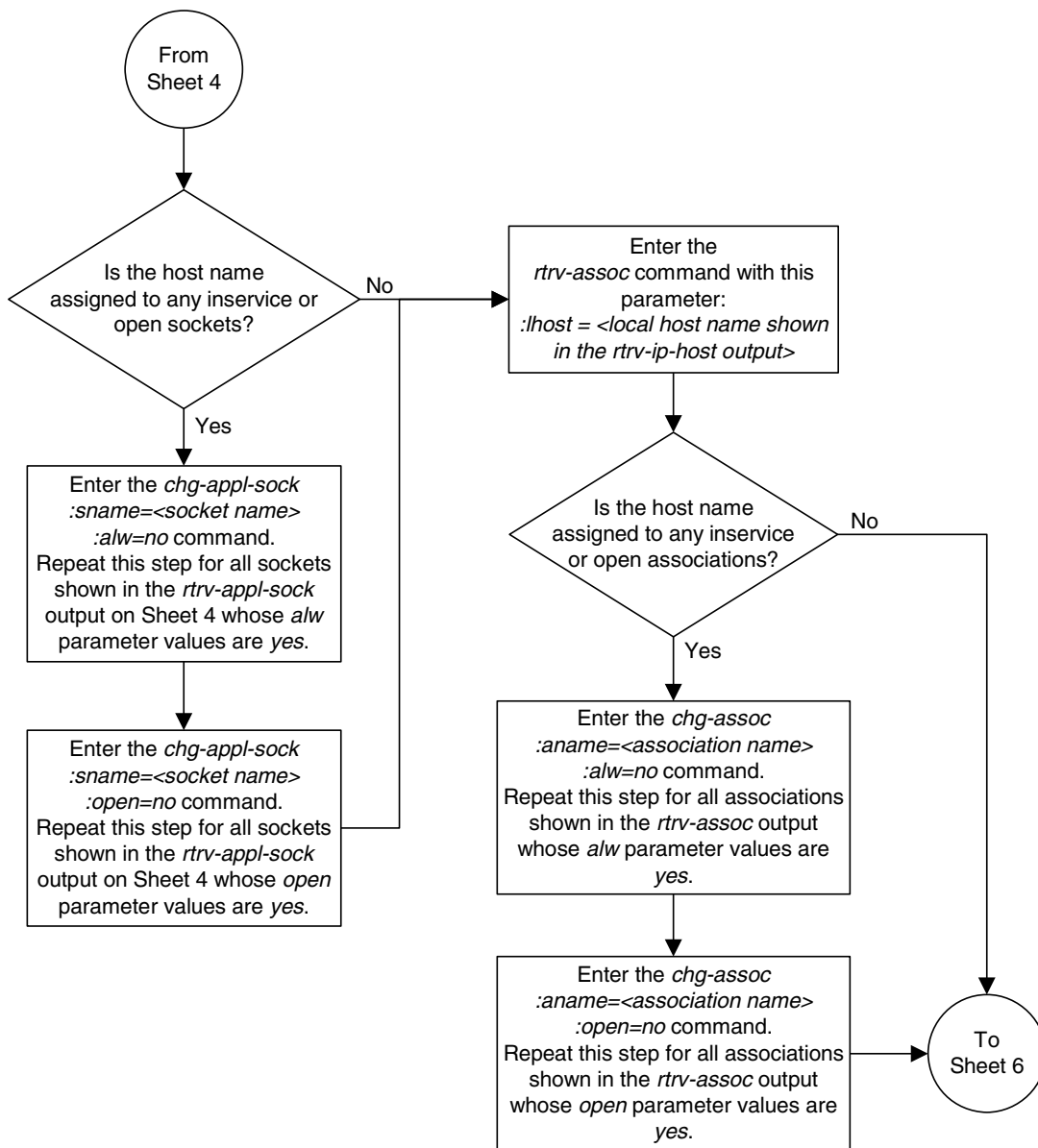

Flowchart 3-4. Configuring a Mate IPGWx Linkset (Sheet 6 of 7)

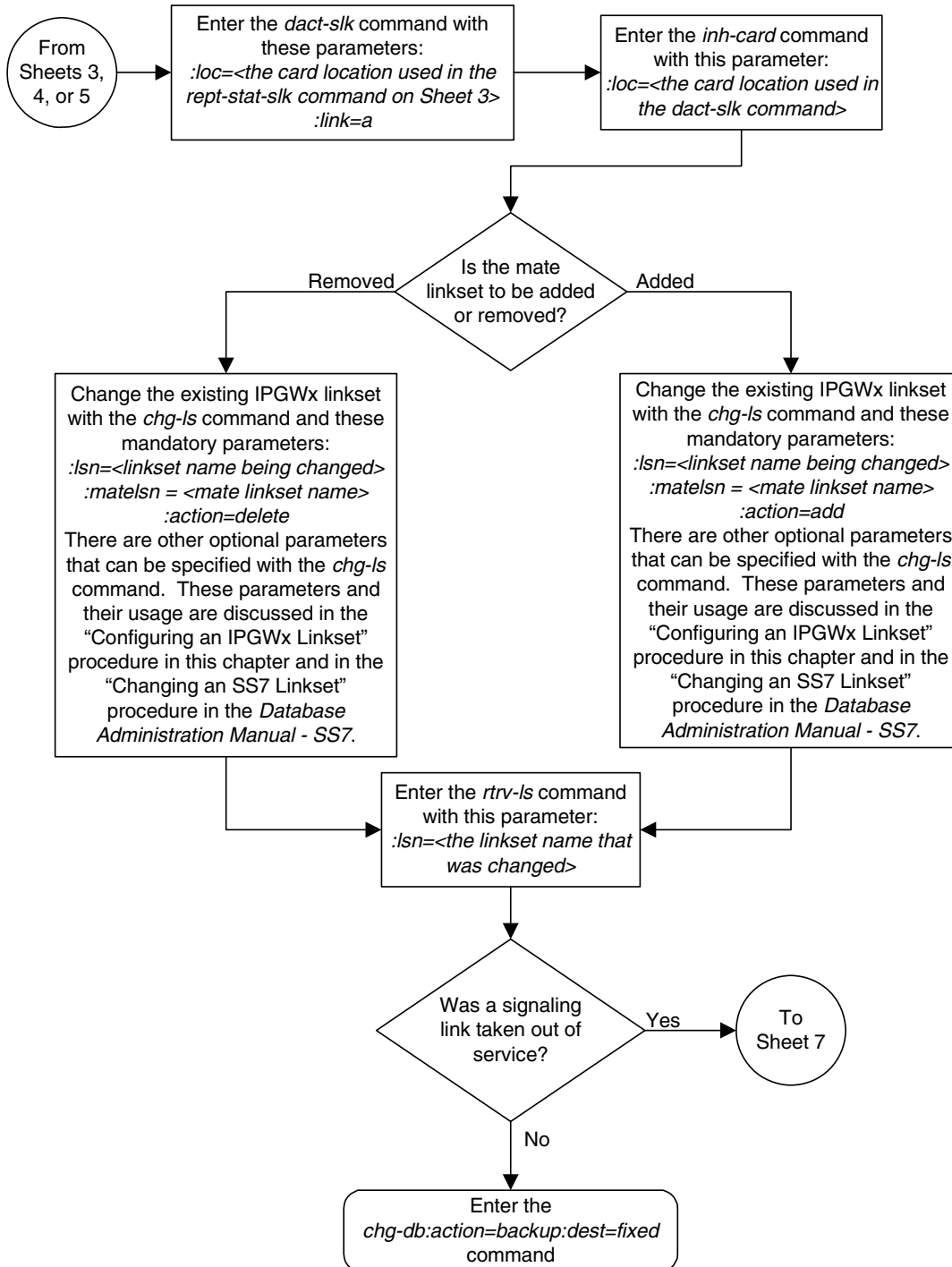

Flowchart 3-4. Configuring a Mate IPGWx Linkset (Sheet 7 of 7)

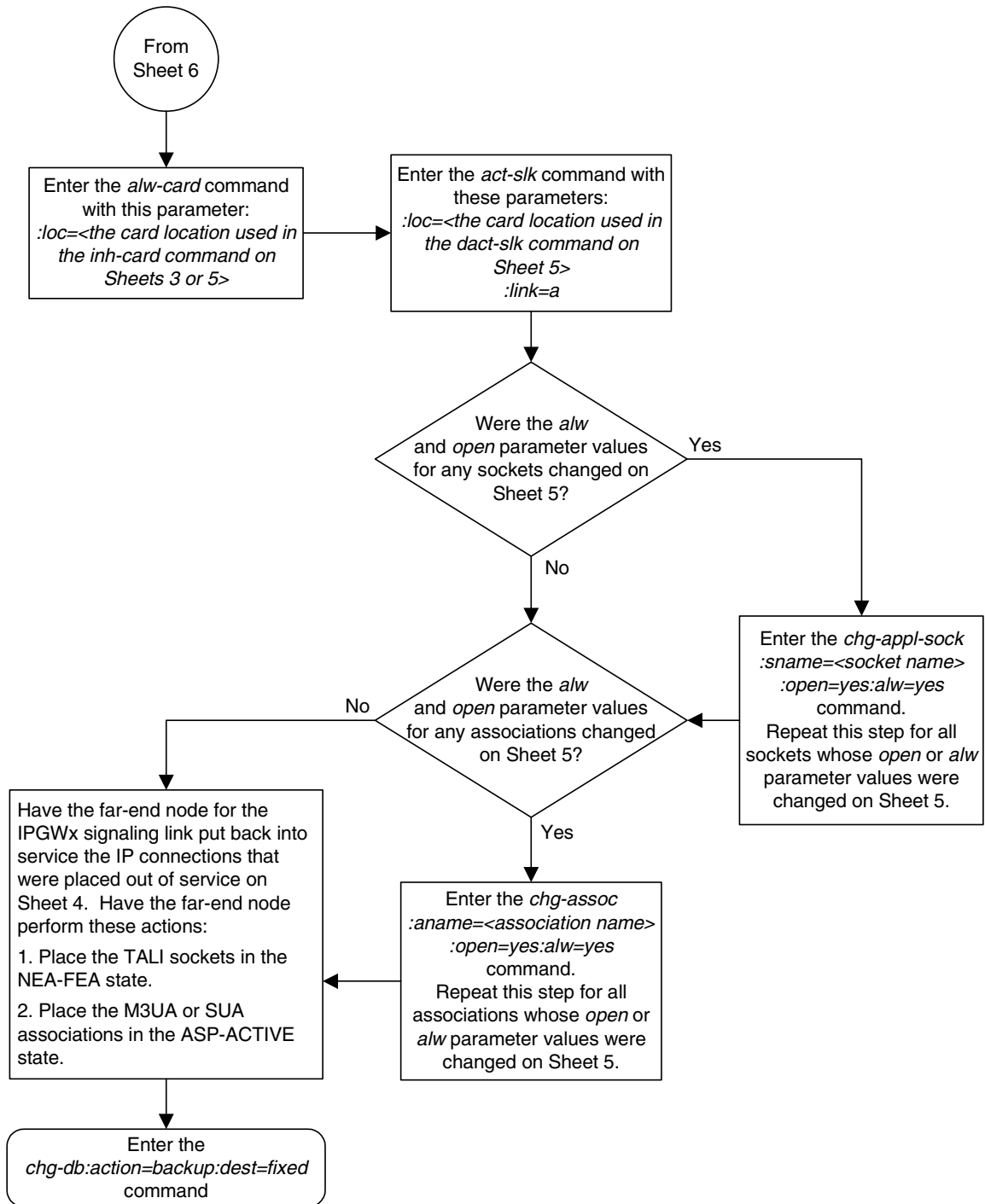

Adding an IP Signaling Link

This procedure is used to add an IP signaling link to the database using the `ent-slk` command. To add other types of signaling links to the database, go to one of these procedures:

The `ent-slk` command uses these parameters.

- `:loc` – The card location of the IP card that the IP signaling link will be assigned to. The cards specified by this parameter are DCMs running the IPLIM, IPLIMI, SS7IPGW, or IPGWI applications.
- `:link` – The signaling link on the card specified in the `loc` parameter.
- `:lsn` – The name of the linkset that will contain the signaling link.
- `:slc` – The signaling link code. The SLC must be unique within the linkset. It must be the same at both the EAGLE 5 ISS location and the distant node.
- `:ipliml2` – The L2 protocol stack to be assigned to the IP signaling link, either SAALTAI or M2PA (the default value).

The `ent-slk` command also contains these parameters, `l2tset`, `l1mode`, `bps`, `tset`, `ecm`, `pcrn1`, `pcrn2`, `lpset`, `atmtsel`, `vci`, `vpi`, `ll`, `elatmcr4`, `elatmsi`, `elatmsn`, `ts`, `elport`, `elloc`, `t1port`, and `t1loc`. These parameters are used only for configuring low-speed, ATM high-speed, E1, and T1 signaling links and are not used in this procedure. For more information on configuring these types of signaling links, see the *Database Administration Manual - SS7*.

These items must be configured in the database before an IP signaling link can be added:

- Shelf – see “Adding a Shelf” in the *Database Administration Manual - System Management*.
- Card – see “Adding an SS7 LIM” in the *Database Administration Manual - System Management*.
- Destination Point Code – see “Adding a Destination Point Code” in the *Database Administration Manual - SS7*.
- Linkset – see either “Configuring an IPGWx Linkset” on page 3-37 (for an IPGWx linkset), or “Adding an SS7 Linkset” in the *Database Administration Manual - SS7* (for an IPLIMx linkset).

Verify that the link has been physically installed (all cable connections have been made).

To configure the EAGLE 5 ISS to perform circular routing detection test on the signaling links, “Configuring Circular Route Detection” procedure in the *Database Administration Manual - SS7*.

NOTE: Circular route detection is not supported in ITU networks.

To provision a EAGLE 5 ISS with more than 700 signaling links, the EAGLE 5 ISS must have certain levels of hardware installed. See the Requirements for EAGLE 5 ISSs Containing more than 700 Signaling Links section on page 3-85 for more information on these hardware requirements.

The EAGLE 5 ISS can contain a mixture of low-speed, E1, T1, ATM high-speed, and IP signaling links. The Determining the Number of High-Speed and Low-Speed Signaling Links on this page describes how to determine the quantities of the different types of signaling links the EAGLE 5 ISS can have.

Requirements for EAGLE 5 ISSs Containing more than 700 Signaling Links

To provision an EAGLE 5 ISS with more than 700 signaling links (currently the EAGLE 5 ISS can have maximum capacities of 1200, 1500, or 2000 signaling links), the following additional requirements must be met:

- The Measurements Platform feature must be enabled. Perform these procedures in the *Database Administration Manual - System Management* to enable the Measurements Platform Feature:
 - “Adding an MCPM”
 - “Configuring the IP Communications Link for the Measurements Platform Feature”
 - “Adding an FTP Server”
- To provision more than 1200 signaling links, the Large System # Links controlled feature must be enabled for 1500 or 2000 signaling links. For more information on enabling this feature, go to “Enabling the Large System # Links Controlled Feature” procedure on page 3-104.

Determining the Number of High-Speed and Low-Speed Signaling Links

An EAGLE 5 ISS containing either 1200, 1500, or 2000 signaling links can contain the following quantities of signaling links:

- 115 high-speed ATM signaling links (signaling links assigned to either ATMANSI or ATMITU applications)
- 100 signaling links assigned to either the IPLIM or IPLIMI applications.
- 64 signaling links assigned to single-slot EDCMs running either the `ss7ipgw` or `ipgwi` application, or combinations of the `ss7ipgw` and `ipgwi` applications. If DCMs are present in the EAGLE 5 ISS, there can be a maximum of 2 signaling links assigned to the `ss7ipgw` application and 2 signaling links assigned to the `ipgwi` application.
- 64 unchannelized E1 signaling links.

The following hardware and applications are the only signaling link hardware and applications supported for an EAGLE 5 ISS containing more than 1500 signaling links.

- E1/T1 MIM running the `ccs7itu` application.
- HC-MIM running the `ccs7itu` application.
- E5-E1T1 running the `ccs7itu` application.
- Single-slot EDCM running either the `iplimi` or `ipgwi` applications.
- E5-ENET running either the `iplimi` or `ipgwi` applications.
- E1-ATM running the `atmitu` application.

IP Signaling Link Parameter Combinations

Table 3-9 shows the two types of IP signaling links that can be provisioned in the database with the `ent-slk` command in this procedure, and the parameters and values that can be used to provision each type of IP signaling link.

Table 3-9. IP Signaling Link Parameter Combinations

| IPGWx Signaling Link | IPLIM Signaling Link |
|--|--|
| Mandatory Parameters | |
| :loc = location of the IP card with one of these applications: SS7IPGW or IPGWI; and the DCM card type. ^{1, 2, 9} | :loc = location of the IP card with one of these applications: IPLIM or IPLIMI; and the DCM card type. ^{1, 2} |
| :link = A | :link = A - A3, B - B3 ³ :link = A4 - A7, B4 - B7 ¹⁰ |
| :lsn = linkset name ^{4, 5, 6} | :lsn = linkset name ^{4, 8} |
| :slc = 0 - 15 ^{5, 6} | :slc = 0 - 15 ⁷ |
| Optional Parameters | |
| | :ipliml2 = saaltali or m2pa ^{7, 8} default value = m2pa |
| Notes: | |
| <ol style="list-style-type: none"> 1. If the <code>multgc=yes</code> parameter is assigned to the linkset, the card's application must be IPLIMI or IPGWI. 2. If the <code>ipgwapc=yes</code> parameter is assigned to the linkset, the card's application must be SS7IPGW or IPGWI. 3. The links A - A3 and B - B3 can be specified only if the card is a single-slot EDCM or an E5-ENET card. 4. If the card's application is IPLIMI or IPGWI, the linkset adjacent point code must be ITU. If the card's application is IPLIM or SS7IPGW, the linkset adjacent point code must be ANSI. The domain of the linkset adjacent point code must be SS7. 5. A linkset can contain only one signaling link assigned to the SS7IPGW or IPGWI applications if the linkset contains a mate IPGWx linkset, or is the mate of an IPGWx linkset. 6. If the linkset does not have a mate IPGWx linkset assigned to it, or is not the mate of an IPGWx linkset, the linkset can contain up to 8 signaling links assigned to the SS7IPGW or IPGWI applications. 7. If the <code>ipliml2=saaltali</code> or <code>ipliml2=m2pa</code> parameter is specified for the signaling link, this signaling link can be in a linkset that contains non-IPLIMx signaling links. The card's application must be either IPLIM or IPLIMI. | |

Table 3-9. IP Signaling Link Parameter Combinations (Continued)

| IPGWx Signaling Link | IPLIM Signaling Link |
|--|----------------------|
| Notes: (Continued) | |
| 8. Signaling links containing the <code>ipliml2=saaltali</code> parameter value cannot be assigned to linksets containing 24-bit ITU-N APCs (APCN24) or SAPCs (SAPCN24). | |
| 9. If the signaling link is being assigned to a single-slot EDCM, to maximize the performance of the IPGWx cards assigned to the linkset, it is recommended that the all signaling links in the linkset are assigned to single-slot EDCMs (part number 870-2372-xx). | |
| 10. The links A4 - A7 and B4 - B7 can be specified only if the card is an E5-ENET card. | |

Example Signaling Link Configuration

This examples used in this procedure are based on the examples shown in Table 3-10.

Table 3-10. IP Signaling Link Configuration Table

| SLK | | LSN | SLC | TYPE | IPLIML2 |
|------|------|--------|-----|---------|----------|
| LOC | LINK | | | | |
| 2202 | A | LSNIP1 | 0 | IPLIM | SAALTALI |
| 2204 | B | LSNIP2 | 0 | IPLIM | M2PA |
| 2205 | A | LSNIP1 | 1 | IPLIM | M2PA |
| 2207 | A | LSNIP3 | 0 | SS7IPGW | N/A |
| 2211 | A | LSNIP4 | 0 | IPGWI | N/A |
| 2213 | A | LSNIP5 | 0 | IPLIMI | M2PA |
| 2215 | A | LSNIP2 | 1 | IPLIM | SAALTALI |

Canceling the REPT-STAT-SLK, RTRV-LS, and RTRV-SLK Commands

Because the `rept-stat-slk`, `rtrv-ls`, and `rtrv-slk` commands used in this procedure can output information for a long period of time, the `rept-stat-slk`, `rtrv-ls`, and `rtrv-slk` commands can be canceled and the output to the terminal stopped. There are three ways that the `rept-stat-slk`, `rtrv-ls`, and `rtrv-slk` commands can be canceled.

- Press the **F9** function key on the keyboard at the terminal where the `rept-stat-slk`, `rtrv-ls`, or `rtrv-slk` commands were entered.
- Enter the `canc-cmd` without the `trm` parameter at the terminal where the `rept-stat-slk`, `rtrv-ls`, or `rtrv-slk` commands were entered.
- Enter the `canc-cmd:trm=<xx>`, where `<xx>` is the terminal where the `rept-stat-slk`, `rtrv-ls`, or `rtrv-slk` commands were entered, from another terminal other than the terminal where the `rept-stat-slk`, `rtrv-ls`, or `rtrv-slk` commands was entered. To enter the `canc-cmd:trm=<xx>` command, the terminal must allow Security Administration commands to be

entered from it and the user must be allowed to enter Security Administration commands. The terminal's permissions can be verified with the `rtrv-secu-trm` command. The user's permissions can be verified with the `rtrv-user` or `rtrv-secu-user` commands.

For more information about the `canc-cmd` command, go to the *Commands Manual*.

Procedure

1. Display the current signaling link configuration using the `rtrv-slk` command. This is an example of the possible output.

```
rlghncxa03w 06-10-19 21:16:37 GMT EAGLE5 36.0.0

LOC LINK LSN          SLC TYPE      L2T      L1      PCR PCR
                SET  BPS      MODE TSET   ECM  N1  N2
1201 B   lsa1          0 LIMDS0      1   56000   --- --- BASIC ---
1203 B   lsa2          0 LIMDS0      1   56000   --- --- BASIC ---
1205 A   lsa3          0 LIMV35      3   64000   DCE  ON  BASIC ---
1207 A   lsn1207a      0 LIMDS0      1   56000   --- --- BASIC ---
1207 B   lsn1207b      0 LIMDS0      1   56000   --- --- BASIC ---
1214 A   lsn1214a      0 LIMV35      2   64000   DTE  --- PCR  76  3800
1214 B   lsa3          1 LIMV35      3   64000   DCE  ON  BASIC ---

LOC LINK LSN          SLC TYPE      LP      ATM
                SET  BPS      TSEL      VCI  VPI  LL
                LP      ATM
                SET  BPS      TSEL      VCI  VPI  CRC4 SI SN
No Links Set up.

LOC LINK LSN          SLC TYPE      IPLIML2
No Links Set up.

LOC LINK LSN          SLC TYPE
No Links Set up.

LOC LINK LSN          SLC TYPE      L2T      PCR PCR  E1  E1
                SET  BPS      ECM  N1  N2  LOC  PORT TS
No Links Set up.

LOC LINK LSN          SLC TYPE      L2T      PCR PCR  T1  T1
                SET  BPS      ECM  N1  N2  LOC  PORT TS
No Links Set up.

SLK table is (7 of 1200) 1% full.
```

If the `rtrv-slk` output shows that the maximum number of signaling links is 2000, go to step 2.

If the `rtrv-slk` output shows that the maximum number of signaling links is 1200, and the signaling link being added increases the number beyond 1200, perform the "Enabling the Large System # Links Controlled Feature"

procedure on page 3-104 and enable the Large System # Links controlled feature for either 1500 signaling links or 2000 signaling links. Then go to step 2.

If the `rtrv-slk` output shows that the maximum number of signaling links is 1500, and the signaling link being added increases the number beyond 1500, perform the “Enabling the Large System # Links Controlled Feature” procedure on page 3-104 and enable the Large System # Links controlled feature for 2000 signaling links. Then go to step 2.

If the addition of the new signaling link will not exceed the maximum number of signaling links, go to step 2.

2. Display the current linkset configuration using the `rtrv-ls` command. This is an example of the possible output.

```
rlghncxa03w 06-10-10 11:43:04 GMT EAGLE5 36.0.0

LSN          APCA   (SS7)  SCRNL3T SLT          GWS GWS GWS
           SET SET BEI LST LNKS ACT MES DIS SLSCI NIS
ele2         001-207-000 none  1  1  no  B   6  off off off no  off
ls1305       000-005-000 none  1  1  no  A   1  off off off no  off
ls1307       000-007-000 none  1  1  no  A   1  off off off no  off
elm1s1       001-001-001 none  1  1  no  A   7  off off off no  off
elm1s2       001-001-002 none  1  1  no  A   7  off off off no  off

LSN          APCA   (X25)  SCRNL3T SLT          GWS GWS GWS
           SET SET BEI LST LNKS ACT MES DIS SLSCI NIS

LSN          APCI   (SS7)  SCRNL3T SLT          GWS GWS GWS
           SET SET BEI LST LNKS ACT MES DIS SLSCI NIS
ele2i        1-207-0    none  1  1  no  B   4  off off off --- on
ls1315       0-015-0    none  1  1  no  A   1  off off off --- off
ls1317       0-017-0    none  1  1  no  A   1  off off off --- on
elm2s1       1-011-1    none  1  1  no  A   7  off off off --- off
elm2s2       1-011-2    none  1  1  no  A   7  off off off --- off

LSN          APCN   (SS7)  SCRNL3T SLT          GWS GWS GWS
           SET SET BEI LST LNKS ACT MES DIS SLSCI NIS

LSN          APCN24 (SS7)  SCRNL3T SLT          GWS GWS GWS
           SET SET BEI LST LNKS ACT MES DIS SLSCI NIS

LSN (CHINA)  APCN   (SS7)  SCRNL3T SLT          GWS GWS GWS
           SET SET BEI LST LNKS ACT MES DIS SLSCI NIS

LSN (CHINA)  APCN24 (SS7)  SCRNL3T SLT          GWS GWS GWS
           SET SET BEI LST LNKS ACT MES DIS SLSCI NIS

Link set table is (10 of 1024) 1% full.
```

If the required linkset is not in the database, perform one of these procedures to add the linkset to the database:

- To add an IPGWx linkset – the “Configuring an IPGWx Linkset” procedure on page 3-37.
- To add an IPLIMx linkset (a linkset that will contain signaling links assigned to cards running either the IPLIM or IPLIMI applications) – the

“Adding an SS7 Linkset” procedure in the *Database Administration Manual - SS7*.

If you plan to use a linkset shown in this step, go to step 3.

If a new linkset is being added in this step, skip step 3 and go to step 4.

3. Display the linkset that the signaling link is being assigned to using the **rtrv-ls** command, specifying the name of the linkset that the signaling link is being assigned to. For this example, enter this command.

rtrv-ls:lsn=lsnipgw

This is an example of the possible output.

```
rlghncxa03w 06-10-17 11:43:04 GMT EAGLE5 36.0.0
LSN          APCI   (SS7)  SCRN  SET SET BEI LST LNKS ACT MES DIS SLSCI NIS
lsipgw       2968          none  1   1   no  A   1   off off off ---  off

          CLLI          TFATCABMLQ  MTPRSE  ASL8  SLRSRB  MULTGC  ITUTFR
          -----  1          no          ---  1          yes  off

IPGWAPC MATELSN      IPTPS LSUSEALM SLKUSEALM GTTMODE
no          -----  ---  ---          ---          CdPA

LOC  LINK SLC TYPE          L2T          L1          PCR  PCR
          SET  BPS          MODE TSET  ECM  N1  N2

LOC  LINK SLC TYPE          LP          ATM
          SET  BPS          TSEL          VCI  VPI  LL

LOC  LINK SLC TYPE          LP          ATM          E1ATM
          SET  BPS          TSEL          VCI  VPI  CRC4 SI SN

LOC  LINK SLC TYPE          IPLIML2
1317 A      0  IPLIMI  SAALTALI

LOC  LINK SLC TYPE

LOC  LINK SLC TYPE          L2T          PCR  PCR  E1  E1
          SET  BPS          ECM  N1  N2  LOC  PORT TS

LOC  LINK SLC TYPE          L2T          PCR  PCR  T1  T1
          SET  BPS          ECM  N1  N2  LOC  PORT TS

SAPCI
1-10-1

SAPCN
1234-aa
1235-bb
1200-zz
```

Link set table is (13 of 1024) 1% full.

Linksets can contain a mixture of signaling link types unless the card application is SS7IPGW or IPGWI.

If an IPGWx signaling link is being added, skip the remainder of this step and go to step 4.

A signaling link containing the `iplim12=saaltali` parameter cannot be assigned to a linkset containing a 24-bit ITU-N adjacent point code. Either choose another linkset without a 24-bit-ITU-N adjacent point code from the `rtrv-ls` output in step 2, or add a new IPLIMx linkset by performing the “Adding the SS7 Linkset” procedure in the *Database Administration Manual - SS7*.

If you do not wish to assign the signaling link to this linkset, go to the “Adding the SS7 Linkset” procedure in the *Database Administration Manual - SS7* and add the IPLIMx linkset to the database.

4. Display the cards in the database using the `rtrv-card` command. This is an example of the possible output.

```
rlghncxa03w 06-10-28 09:12:36 GMT EAGLE5 36.0.0
CARD  TYPE      APPL      LSET NAME      LINK SLC LSET NAME      LINK SLC
1102  TSM           GLS
1103  DCM           VXWSLAN
1113  GSPM          EOAM
1114  TDM-A
1115  GSPM          EOAM
1116  TDM-B
1117  MDAL
1201  LIMDS0        SS7ANSI      lsa1           B      0
1202  LIMV35        SS7ANSI
1203  LIMDS0        SS7ANSI      lsa2           B      0
1204  LIMDS0        SS7ANSI
1205  LIMV35        SS7ANSI      lsa3           A      0
1206  LIMV35        SS7ANSI
1207  LIMDS0        SS7ANSI      lsn1207a       A      0      lsn1207b      B      0
1208  LIMDS0        SS7ANSI
1212  LIMV35        SS7ANSI
1213  LIMDS0        SS7ANSI
1214  LIMV35        SS7ANSI      lsn1214a       A      0      lsa3           B      1
1215  LIMDS0        SS7ANSI
1301  LIMV35        ATMANSI
1302  LIMATM        ATMANSI
1304  LIMV35        SS7ANSI
1305  LIMATM        ATMANSI
1308  LIMV35        SS7ANSI
1311  LIMDS0        SS7ANSI
1313  LIMDS0        SS7ANSI
1315  LIMV35        CCS7ITU
1317  LIMV35        CCS7ITU
1318  LIMATM        ATMANSI
```

If the required card is not in the database, perform the “Adding an IP Card” procedure on page 3-17 and add the IP card to the database.

NOTE: If the linkset that the signaling link will be added to contains the `multgc=yes` parameter, the application assigned to the card must be either IPLIMI or IPGWI.

NOTE: If an IPLIMx signaling link is being added, skip steps 5 through 8, and go to step 9.

NOTE: If the IPGWx linkset contains any IPGWx signaling links, skip step 5 and go to step 6.

5. If you wish to assign an IPGWx signaling link to a linkset contains no signaling links, but the `IPGWAPC` value is no, perform the "Removing a Linkset Containing SS7 Signaling Links" procedure in the *Database Administration Manual - SS7* and remove the linkset, then go to the "Configuring an IPGWx Linkset" procedure on page 3-37 and re-enter the new linkset with the `ipgwapc=yes` parameter. Skip steps 6 through 8 and go to step 9.
-

6. If the desired linkset, shown in the `rttrv-ls` output in step 3, has a mate IPGWx linkset assigned, or is the mate to another IPGWx linkset, the desired linkset can contain only one signaling link.

If the desired linkset does not have a mate IPGWx linkset assigned, or is not the mate of another IPGWx linkset, the desired linkset can contain up to 8 IPGWx signaling links. No other signaling link types can be in an IPGWx linkset.

If you wish to assign more than one IPGWx signaling link to an IPGWx linkset that has a mate linkset assigned, the mate to this linkset must be removed. Perform the "Configuring a Mate IPGWx Linkset" procedure on page 3-63 and remove the mate linkset from the linkset you wish to assign the IPGWx signaling link to. If you do not wish to use this linkset, perform the "Configuring an IPGWx Linkset" procedure on page 3-37 and add a new IPGWx linkset.

If the desired IPGWx linkset does not have a mate assigned, go to step 8.

If the desired linkset has a mate linkset assigned, and contains an IPGWx signaling link, perform the "Configuring a Mate IPGWx Linkset" procedure on page 3-63 and add a new IPGWx linkset. Skip steps 7 and 8, and go to step 9.

- If you wish to assign more than one IPGWx signaling link to an IPGWx linkset that is a mate to another IPGWx linkset, this linkset must be removed from the other linkset as a mate.

To verify if the linkset you wish to use is the mate of another IPGWx linkset, enter the **rept-stat-iptps** command to display the names of all the IPGWx linksets. This is an example of the possible output.

```
rlghncxa03w 06-10-10 11:43:04 GMT EAGLE5 36.0.0

IP TPS USAGE REPORT

      THRESH  CONFIG      TPS      PEAK      PEAKTIMESTAMP
-----
SYSTEM
RLGHNCXA03W 100%   30000 TX:   7200    7600 05-02-10 11:40:04
              RCV:   7200    7600 05-02-10 11:40:04
-----
LSN
LSGW1101      80%    6000 TX:   5100    5500 05-02-10 11:40:04
              RCV:   5100    5500 05-02-10 11:40:04
LSGW1103      80%    6000 TX:   5200    5500 05-02-10 11:40:04
              RCV:   5200    5500 05-02-10 11:40:04
LSGW1105      80%   14000 TX:   7300    7450 05-02-10 11:40:04
              RCV:   7300    7450 05-02-10 11:40:04
LSGW1107      70%    4000 TX:   3200    3500 05-02-10 11:40:04
              RCV:   3200    3500 05-02-10 11:40:04
-----
Command Completed.
```

- Enter the **rtrv-ls:lsn=<IPGWx linkset name from the rept-stat-iptps output>** to verify if the desired linkset is the mate of another IPGWx linkset. For this example, enter this command.

rtrv-ls:lsn=lsgw1103

This is an example of the possible output.

```
rlghncxa03w 06-10-17 11:43:04 GMT EAGLE5 36.0.0

LSN          APCA  (SS7)  SCRNR  L3T SLT          GWS GWS GWS
lsgw1103     003-002-004  none  1  1  no  A  1  off off off no  off

CLLI          TFATCABMLQ MTPRSE ASL8
-----  1          no  no

IPGWAPC MATELSN  IPTPS LSUSEALM SLKUSEALM GTTMODE
yes      lsgw1107  10000 70    % 70    % CdPA

LOC LINK SLC TYPE          L2T          L1          PCR PCR
SET BPS          MODE TSET ECM  N1  N2

LOC LINK SLC TYPE          LP          ATM
SET BPS          TSEL          VCI  VPI  LL

LOC LINK SLC TYPE          LP          ATM          E1ATM
SET BPS          TSEL          VCI  VPI  CRC4 SI SN

LOC LINK SLC TYPE          IPLIML2
```

```
LOC LINK SLC TYPE
1103 A 0 SS7IPGW
```

```
LOC LINK SLC TYPE L2T PCR PCR E1 E1
SET BPS ECM N1 N2 LOC PORT TS
```

```
LOC LINK SLC TYPE L2T PCR PCR T1 T1
SET BPS ECM N1 N2 LOC PORT TS
```

Link set table is (14 of 1024) 1% full

If the name of the linkset you wish to use is not shown in the **MATELSN** field of the **rtrv-ls** output, repeat this step until all the IPGWx linksets have been displayed, or until a linkset has been found that has the linkset you wish to use assigned as a mate. If the linkset you wish to use is not the mate of another IPGWx linkset, go to step 9.

If the name of the linkset you wish to use is shown in the **MATELSN** field of the **rtrv-ls** output, perform the “Configuring a Mate IPGWx Linkset” procedure on page 3-63 to remove this linkset from the other linkset as a mate. Then go to step 9.

If the desired linkset is the mate of another IPGWx linkset, and you do not wish to use this linkset, perform the “Configuring an IPGWx Linkset” procedure on page 3-37 and add a new IPGWx linkset. Then go to step 9.

-
9. Add the signaling link to the database using the **ent-slk** command. Use Table 3-9 on page 3-86 as a guide for the parameters that can be specified with the **ent-slk** command. For this example, enter these commands.

```
ent-slk:loc=2202:link=a:lsn=lsnlp1:slc=0:ipliml2=saaltali
ent-slk:loc=2204:link=b:lsn=lsnlp2:slc=0:ipliml2=m2pa
ent-slk:loc=2205:link=a:lsn=lsnlp1:slc=1:ipliml2=m2pa
ent-slk:loc=2207:link=a:lsn=lsnlp3:slc=0
ent-slk:loc=2211:link=a:lsn=lsnlp4:slc=0
ent-slk:loc=2213:link=a:lsn=lsnlp5:slc=0:ipliml2=m2pa
ent-slk:loc=2215:link=a:lsn=lsnlp2:slc=1:ipliml2=saaltali
```

When each of these commands have successfully completed, this message should appear.

```
rlghncxa03w 06-10-07 08:29:03 GMT EAGLE5 36.0.0
ENT-SLK: MASP A - COMPLTD
```

10. Verify the changes using the `rtv-slk` command. This is an example of the possible output.

```

rlghncxa03w 06-10-19 21:16:37 GMT EAGLE5 36.0.0

LOC LINK LSN          SLC TYPE          L2T          L1          PCR PCR
                SET BPS  MODE TSET  ECM N1  N2
1201 A  ls01          0 LIMDS0          1  56000  --- ---  BASIC ---  ---
1201 B  lsa1          0 LIMDS0          1  56000  --- ---  BASIC ---  ---
1202 B  ls02          0 LIMV35          2  64000  DTE ---  BASIC ---  ---
1203 A  ls03          0 LIMDS0          3  56000  --- ---  BASIC ---  ---
1203 B  lsa2          0 LIMDS0          1  56000  --- ---  BASIC ---  ---
1204 B  ls01          1 LIMDS0          1  56000  --- ---  BASIC ---  ---
1205 A  lsa3          0 LIMV35          4  64000  DCE ON  BASIC ---  ---
1206 A  ls02          1 LIMV35          2  64000  DTE ---  BASIC ---  ---
1207 A  lsn1207a         0 LIMDS0          1  56000  --- ---  BASIC ---  ---
1207 B  lsn1207b         0 LIMDS0          1  56000  --- ---  BASIC ---  ---
1208 B  ls03          1 LIMDS0          3  56000  --- ---  BASIC ---  ---
1212 A  ls04          0 LIMV35          4  64000  DTE ---  BASIC ---  ---
1213 B  ls05          0 LIMDS0          5  56000  --- ---  BASIC ---  ---
1214 A  lsn1214a         0 LIMV35          2  64000  DTE ---  PCR  76  3800
1214 B  lsa3          1 LIMV35          4  64000  DCE ON  BASIC ---  ---
1215 A  ls05          1 LIMDS0          5  56000  --- ---  BASIC ---  ---
1301 B  ls06          0 LIMV35          6  56000  DTE ---  BASIC ---  ---
1304 B  ls06          1 LIMV35          6  56000  DTE ---  BASIC ---  ---
1308 A  ls06          2 LIMV35          6  56000  DTE ---  BASIC ---  ---
1311 A  ls01          2 LIMDS0          1  56000  --- ---  BASIC ---  ---
1311 A1 ls05          2 LIMDS0          5  56000  --- ---  BASIC ---  ---
1311 B  ls03          2 LIMDS0          3  56000  --- ---  BASIC ---  ---
1311 B1 ls07          1 LIMDS0          7  56000  --- ---  BASIC ---  ---
1313 A  ls07          0 LIMDS0          7  56000  --- ---  BASIC ---  ---
1315 A  lsn5          0 LIMV35         11  64000  DTE OFF  BASIC ---  ---
1317 A  lsi7          0 LIMV35         11  64000  DTE OFF  BASIC ---  ---

LOC LINK LSN          SLC TYPE          LP          ATM
                SET BPS  TSEL          VCI  VPI  LL
No Links Set up.

LOC LINK LSN          SLC TYPE          LP          ATM          E1ATM
                SET BPS  TSEL          VCI  VPI  CRC4 SI SN
No Links Set up.

LOC LINK LSN          SLC TYPE          IPLIML2
2202 A  lsnlp1         0 IPLIM          SAALTALI
2205 A  lsnip1         1 IPLIM          M2PA
2204 B  lsnlp2         0 IPLIM          M2PA
2213 A  lsnip5         0 IPLIMI         M2PA
2215 A  lsnlp2         1 IPLIM          SAALTALI

LOC LINK LSN          SLC TYPE
2207 A  lsnlp3         0 SS7IPGW
2211 A  lsnlp4         0 IPGWI

LOC LINK LSN          SLC TYPE          L2T          PCR PCR  E1  E1
                SET BPS  ECM N1  N2  LOC PORT TS
No Links Set up.

LOC LINK LSN          SLC TYPE          L2T          PCR PCR  T1  T1
                SET BPS  ECM N1  N2  LOC PORT TS
No Links Set up.

SLK table is (38 of 1500) 3% full.

```

11. If any cards contain the first signaling link on a card, those cards must be brought into service with the `rst-card` command, specifying the location of the card. For this example, enter these commands.

```
rst-card:loc=2202
rst-card:loc=2204
rst-card:loc=2205
rst-card:loc=2207
rst-card:loc=2211
rst-card:loc=2213
rst-card:loc=2215
```

When each of these commands have successfully completed, this message should appear.

```
rlghncxa03w 06-10-23 13:05:05 GMT EAGLE5 36.0.0
Card has been allowed.
```

12. Activate all signaling links on the cards using the `act-slk` command, specifying the card location and `link` parameter value of each signaling link. For this example, enter these commands.

```
act-slk:loc=2202:link=a
act-slk:loc=2204:link=b
act-slk:loc=2205:link=a
act-slk:loc=2207:link=a
act-slk:loc=2211:link=a
act-slk:loc=2213:link=a
act-slk:loc=2215:link=a
```

When each of these commands have successfully completed, this message should appear.

```
rlghncxa03w 06-10-07 08:31:24 GMT EAGLE5 36.0.0
Activate Link message sent to card
```

13. Check the status of the signaling links added in step 9 using the **rept-stat-slk** command. The state of each signaling link should be in service normal (IS-NR) after the link has completed alignment (shown in the **PST** field). This is an example of the possible output.

```
rlghncxa03w 06-10-19 21:16:37 GMT EAGLE5 36.0.0
SLK      LSN      CLLI      PST      SST      AST
1201,A   ls01     ls01c1li  IS-NR    Avail    ----
1201,B   lsa1     -----  IS-NR    Avail    ----
1202,B   ls02     ls02c1li  IS-NR    Avail    ----
1203,A   ls03     ls03c1li  IS-NR    Avail    ----
1203,B   lsa2     -----  IS-NR    Avail    ----
1204,B   ls01     ls01c1li  IS-NR    Avail    ----
1205,A   lsa3     -----  IS-NR    Avail    ----
1206,A   ls02     ls02c1li  IS-NR    Avail    ----
1207,A   lsn1207a -----  IS-NR    Avail    ----
1207,B   lsn1207b -----  IS-NR    Avail    ----
1208,B   ls03     ls03c1li  IS-NR    Avail    ----
1212,A   ls04     ls04c1li  IS-NR    Avail    ----
1213,B   ls05     lsn5c1li  IS-NR    Avail    ----
1214,A   lsn1214a -----  IS-NR    Avail    ----
1214,B   lsa3     -----  IS-NR    Avail    ----
1215,A   ls05     lsn5c1li  IS-NR    Avail    ----
1301,B   ls06     ls06c1li  IS-NR    Avail    ----
1304,B   ls06     ls06c1li  IS-NR    Avail    ----
1308,A   ls06     ls06c1li  IS-NR    Avail    ----
1311,A   ls01     ls01c1li  IS-NR    Avail    ----
1311,A1  ls05     lsn5c1li  IS-NR    Avail    ----
1311,B   ls03     ls03c1li  IS-NR    Avail    ----
1311,B1  ls07     ls07c1li  IS-NR    Avail    ----
1313,A   ls07     ls07c1li  IS-NR    Avail    ----
1315,A   lsn5     -----  IS-NR    Avail    ----
1317,A   lsi7     -----  IS-NR    Avail    ----
2202,A   lsnlp1   -----  IS-NR    Avail    ----
2204,B   lsnlp2   -----  IS-NR    Avail    ----
2205,A   lsnlp1   -----  IS-NR    Avail    ----
2207,A   lsnlp3   -----  IS-NR    Avail    ----
2211,A   lsnlp4   -----  IS-NR    Avail    ----
2213,A   lsnlp5   -----  IS-NR    Avail    ----
2215,A   lsnlp2   -----  IS-NR    Avail    ----
```

14. Back up the new changes using the **chg-db:action=backup:dest=fixed** command. These messages should appear, the active Maintenance and Administration Subsystem Processor (MASP) appears first.

```
BACKUP (FIXED) : MASP A - Backup starts on active MASP.
BACKUP (FIXED) : MASP A - Backup on active MASP to fixed disk complete.
BACKUP (FIXED) : MASP A - Backup starts on standby MASP.
BACKUP (FIXED) : MASP A - Backup on standby MASP to fixed disk complete.
```

Flowchart 3-5. Adding an IP Signaling Link (Sheet 1 of 6)

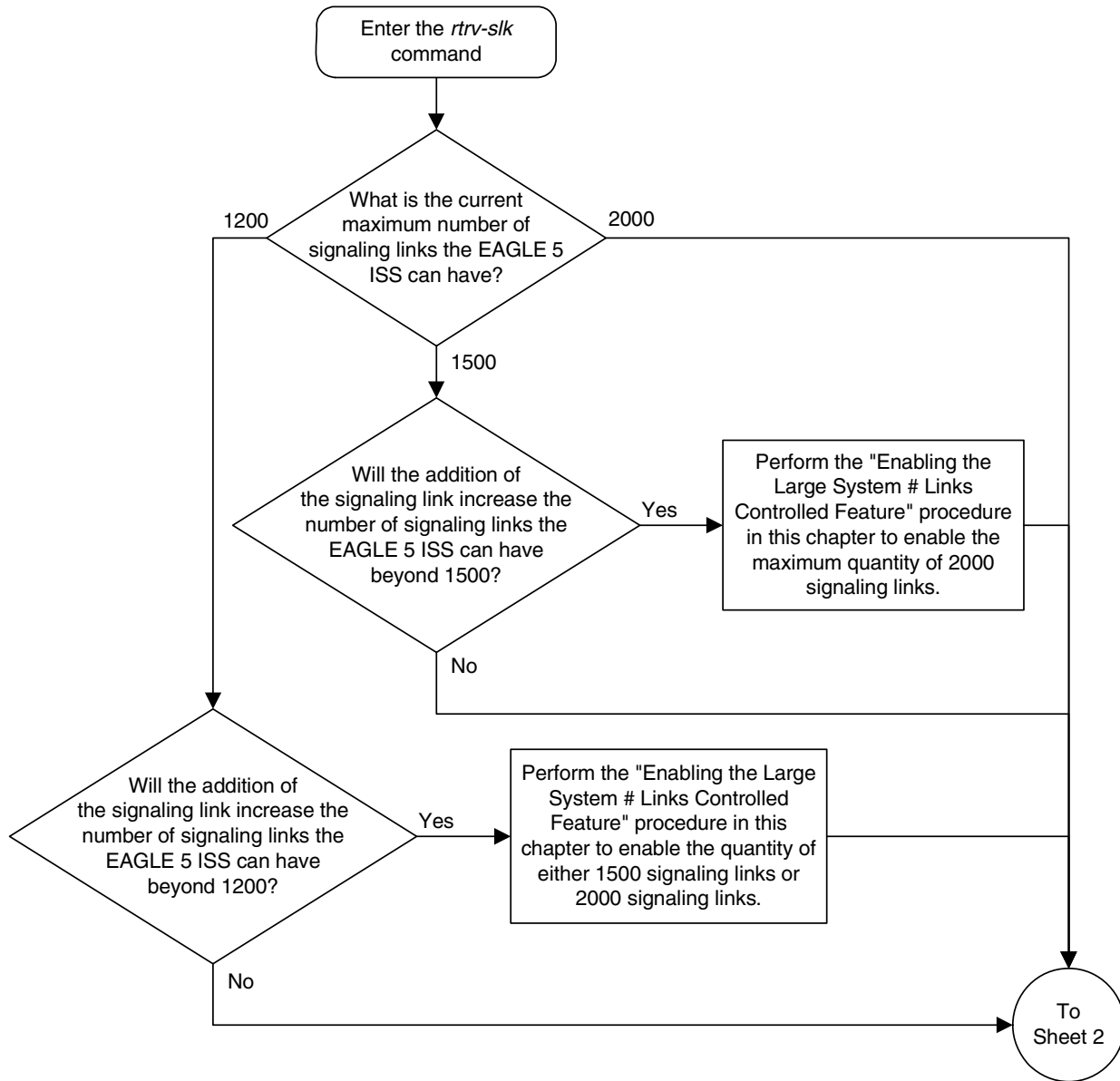

Flowchart 3-5. Adding an IP Signaling Link (Sheet 2 of 6)

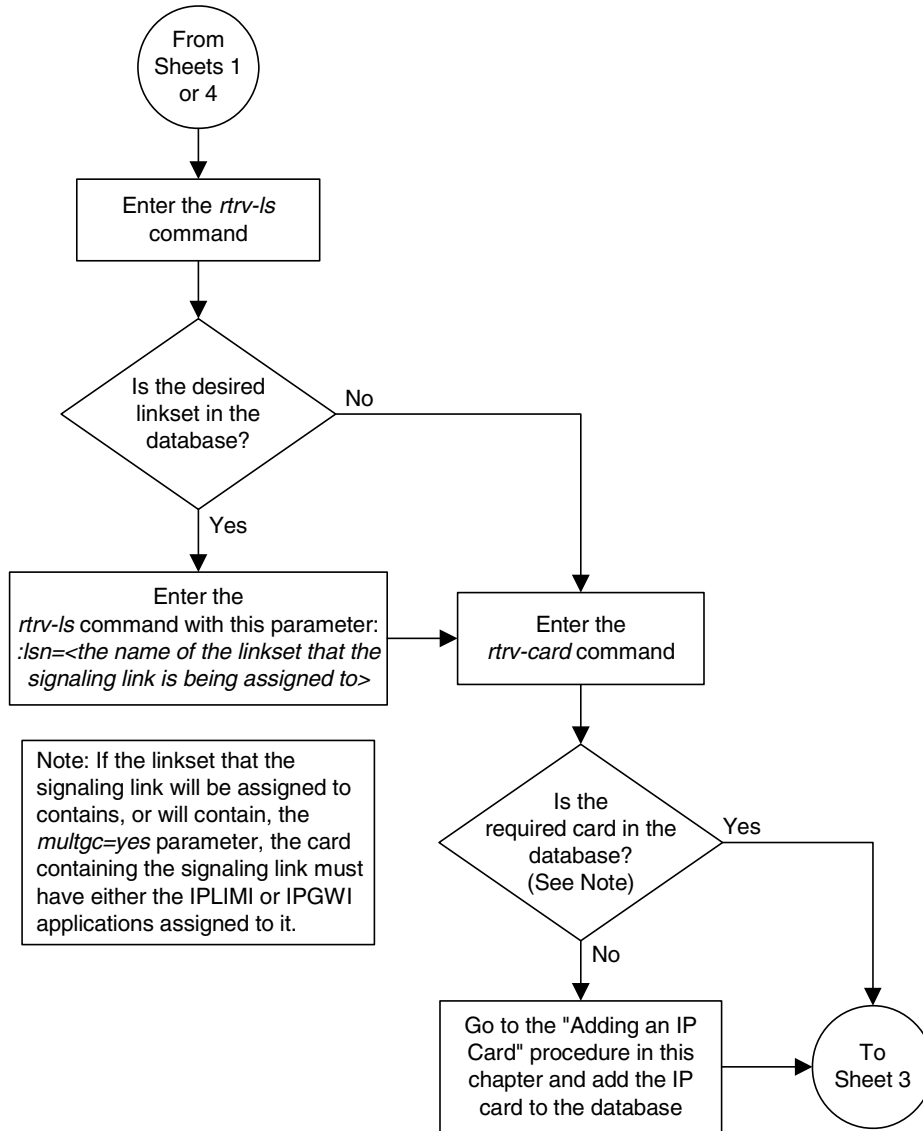

Flowchart 3-5. Adding an IP Signaling Link (Sheet 3 of 6)

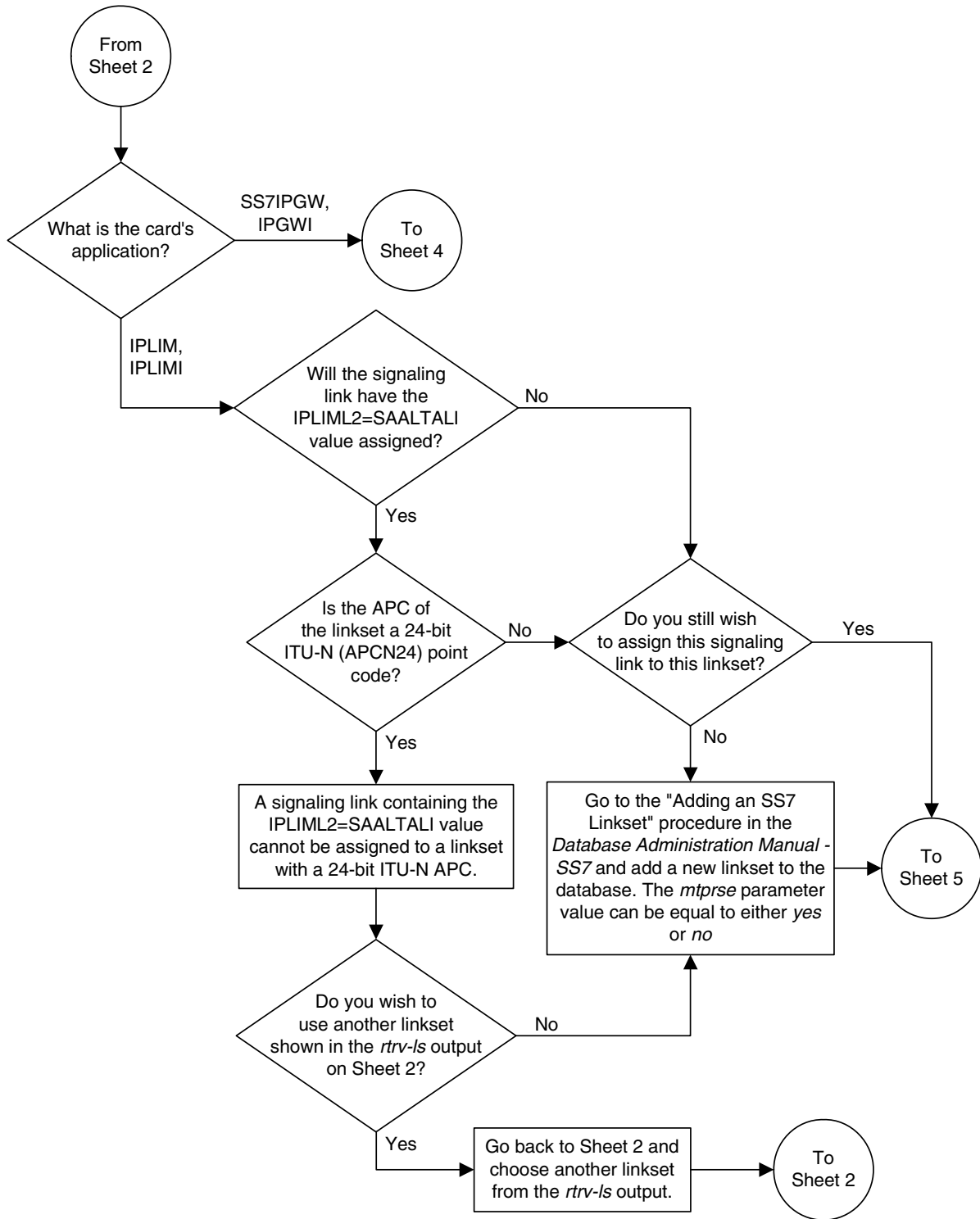

Flowchart 3-5. Adding an IP Signaling Link (Sheet 4 of 6)

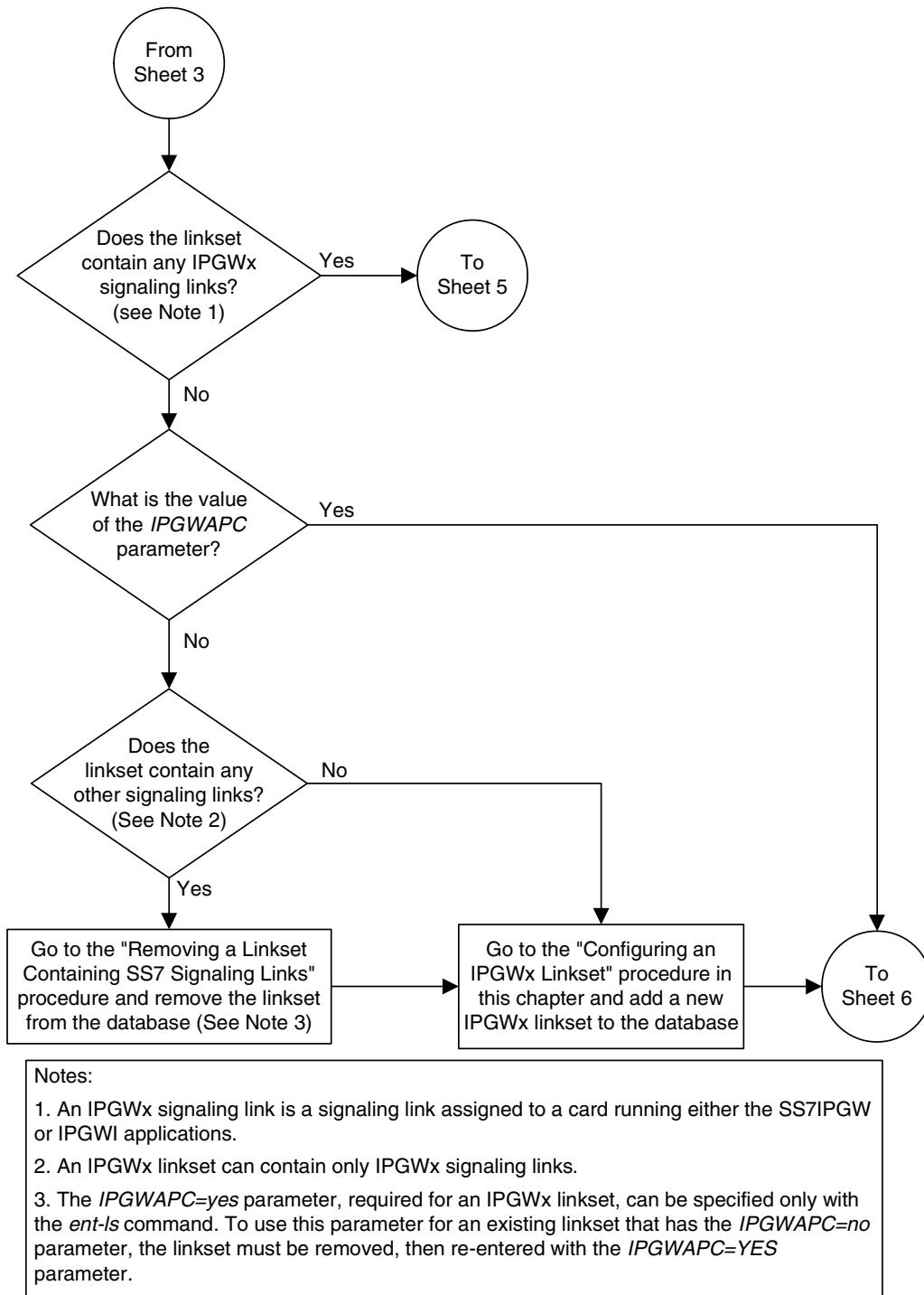

Flowchart 3-5. Adding an IP Signaling Link (Sheet 5 of 6)

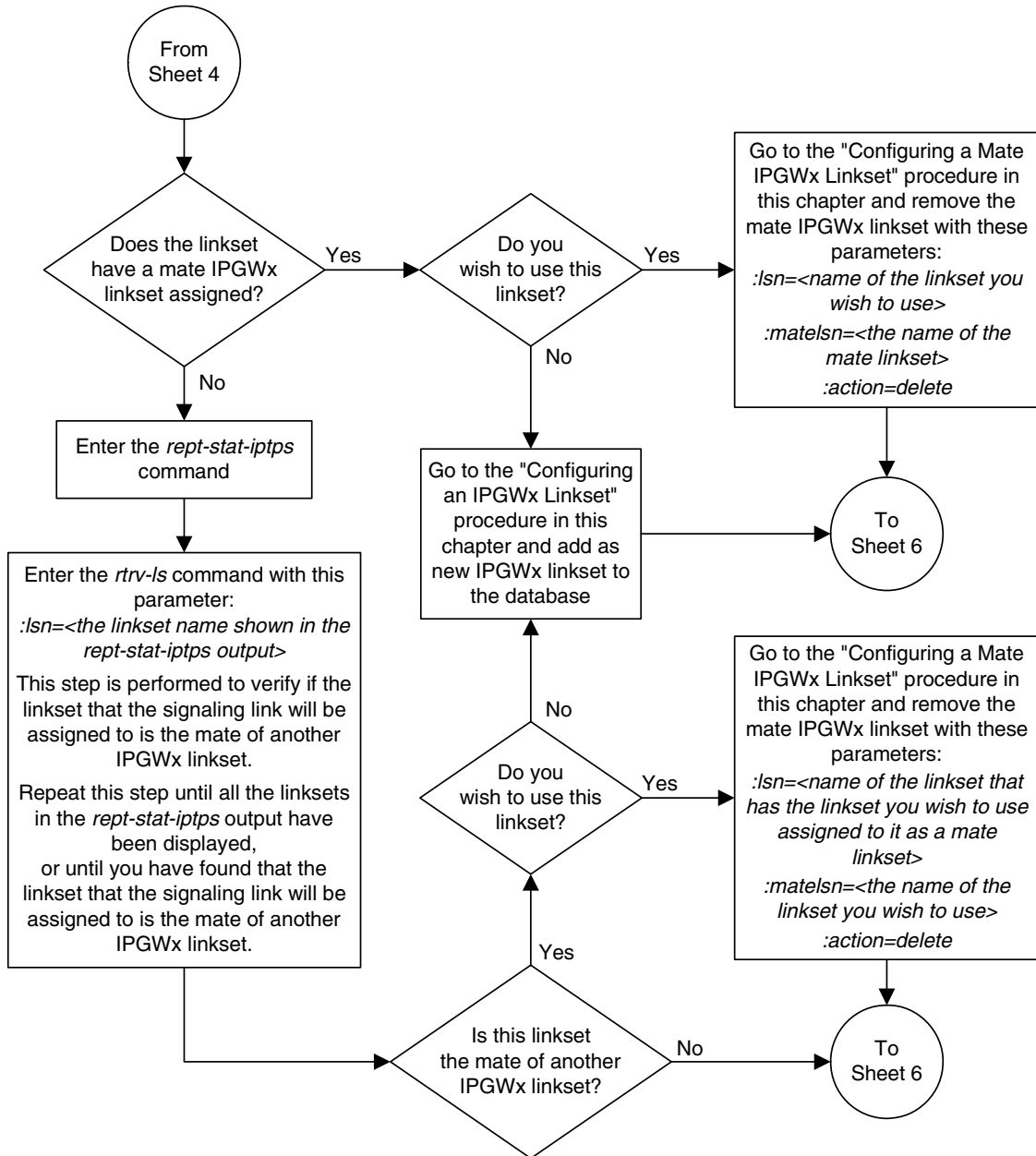

Notes:

1. An IPGWx linkset can contain only one IPGWx signaling link if the IPGWx linkset has a mate IPGWx linkset assigned to it, or is the mate to an IPGWx linkset.
2. If the IPGWx linkset is not the mate to another IPGWx linkset, or does not have a mate IPGWx linkset assigned, the IPGWx linkset can contain up to 8 IPGWx signaling links.

Flowchart 3-5. Adding an IP Signaling Link (Sheet 6 of 6)

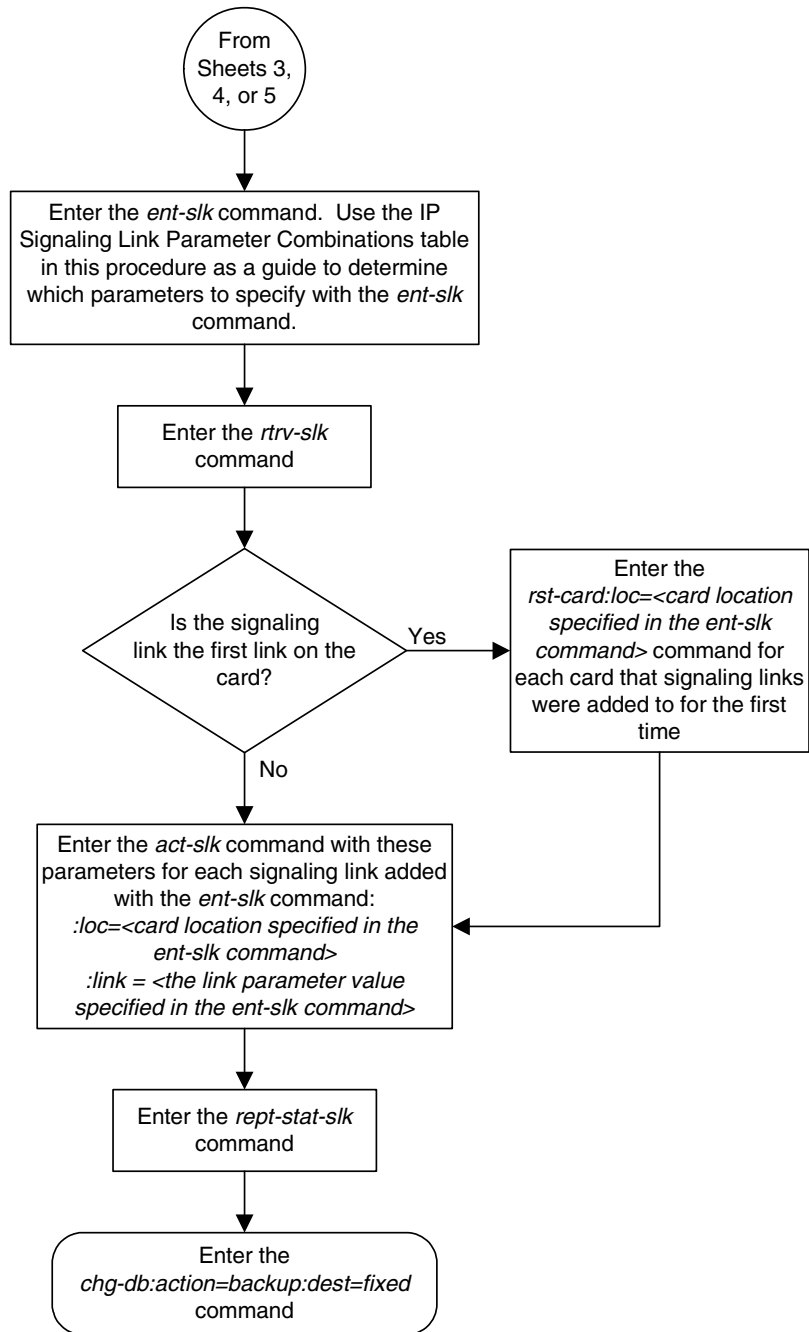

Enabling the Large System # Links Controlled Feature

This procedure is used to enable the Large System # Links controlled feature using the feature's part number and a feature access key.

The feature access key for the Large System # Links controlled feature is based on the feature's part number and the serial number of the EAGLE 5 ISS, making the feature access key site-specific.

This feature allows the EAGLE 5 ISS to contain a maximum of either 1500 or 2000 signaling links.

The `enable-ctrl-feat` command enables the controlled feature by inputting the controlled feature's access key and the controlled feature's part number with these parameters:

- **:fak** – The feature access key generated by the feature access key generator. The feature access key contains 13 alphanumeric characters and is not case sensitive.
- **:partnum** – The Tekelec-issued part number associated with the signaling link quantity being enabled:
 - 893005901 for the 1500 signaling link quantity
 - 893005910 for the 2000 signaling link quantity.

The `enable-ctrl-feat` command requires that the database contain a valid serial number for the EAGLE 5 ISS, and that this serial number is locked. This can be verified with the `rtrv-serial-num` command. The EAGLE 5 ISS is shipped with a serial number in the database, but the serial number is not locked. The serial number can be changed, if necessary, and locked once the EAGLE 5 ISS is on-site, with the `ent-serial-num` command. The `ent-serial-num` command uses these parameters.

- **:serial** – The serial number assigned to the EAGLE 5 ISS. The serial number is not case sensitive.
- **:lock** – Specifies whether or not the serial number is locked. This parameter has only one value, `yes`, which locks the serial number. Once the serial number is locked, it cannot be changed.

NOTE: To enter and lock the EAGLE 5 ISS's serial number, the `ent-serial-num` command must be entered twice, once to add the correct serial number to the database with the `serial` parameter, then again with the `serial` and the `lock=yes` parameters to lock the serial number. You should verify that the serial number in the database is correct before locking the serial number. The serial number can be found on a label affixed to the control shelf (shelf 1100).

This feature cannot be temporarily enabled (with the temporary feature access key).

Once this feature is enabled with the **enable-ctrl-feat** command, the feature is also activated. The **chg-ctrl-feat** command is not necessary to activate the feature.

This feature cannot be disabled with the **chg-ctrl-feat** command and the **status=off** parameter.

Hardware Supported for Signaling Link Quantities Greater than 1500

The following hardware and applications are the only signaling link hardware and applications supported for an EAGLE 5 ISS containing more than 1500 signaling links.

- E1/T1 MIM running the **ccs7itu** application.
- HC-MIM running the **ccs7itu** application.
- E5-E1T1 card running the **ccs7itu** application.
- Single-slot EDCM running either the **iplimi** or **ipgwi** applications.
- E5-ENET card running either the **iplimi** or **ipgwi** applications.
- E1-ATM card running the **atmitu** application.

To increase the signaling link quantity to more than 1500 signaling links, HIPR cards must be installed into card locations 9 and 10 in each shelf in the EAGLE 5 ISS. Enter the **rept-stat-gp1:gp1=hipr** command to verify whether or not HIPR cards are installed in the EAGLE 5 ISS shelves.

Procedure

1. Display the status of the Large System # Links controlled feature by entering the `rtrv-ctrl-feat` command. The following is an example of the possible output.

```
rlghncxa03w 06-10-28 21:15:37 GMT EAGLE5 36.0.0
The following features have been permanently enabled:
```

| Feature Name | Partnum | Status | Quantity |
|---------------------------|-----------|--------|----------|
| IPGWx Signaling TPS | 893012814 | on | 20000 |
| ISUP Normalization | 893000201 | on | ---- |
| Command Class Management | 893005801 | on | ---- |
| LNP Short Message Service | 893006601 | on | ---- |
| Intermed GTT Load Sharing | 893006901 | on | ---- |
| XGTT Table Expansion | 893006101 | on | 400000 |
| XMAP Table Expansion | 893007710 | off | ---- |
| Routesets | 893006401 | on | 6000 |
| HC-MIM SLK Capacity | 893012707 | on | 64 |

The following features have been temporarily enabled:

| Feature Name | Partnum | Status | Quantity | Trial Period Left |
|---------------------|---------|--------|----------|-------------------|
| Zero entries found. | | | | |

The following features have expired temporary keys:

| Feature Name | Partnum |
|---------------------|---------|
| Zero entries found. | |

If the `rtrv-ctrl-feat` output shows that the controlled feature is permanently enabled for the desired quantity or for a quantity that is greater than the desired quantity, no further action is necessary. This procedure does not need to be performed.

NOTE: If the `rtrv-ctrl-feat` output in step 1 shows any controlled features, or if the Large System # Links controlled feature is enabled for a quantity that is less than the desired quantity, skip steps 2 through 5, and go to step 6.

2. Display the serial number in the database with the `rtrv-serial-num` command. This is an example of the possible output.

```
rlghncxa03w 06-10-28 21:15:37 GMT EAGLE5 36.0.0
System serial number = nt00001231
```

System serial number is not locked.

```
rlghncxa03w 06-10-28 21:15:37 GMT EAGLE5 36.0.0
Command Completed
```

NOTE: If the serial number is correct and locked, skip steps 3, 4, and 5, and go to step 6. If the serial number is correct but not locked, skip steps 3 and 4, and go to step 5. If the serial number is not correct, but is locked, this feature cannot be enabled and the remainder of this procedure cannot be performed. Contact the Customer Care Center to get an incorrect and locked serial number changed. Refer to "Customer Care Center" on page 1-9 for the contact information. The serial number can be found on a label affixed to the control shelf (shelf 1100).

3. Enter the correct serial number into the database using the `ent-serial-num` command with the `serial` parameter.

For this example, enter this command.

```
ent-serial-num:serial=<EAGLE 5 ISS's correct serial number>
```

When this command has successfully completed, the following message should appear.

```
rlghncxa03w 06-10-28 21:15:37 GMT EAGLE5 36.0.0
ENT-SERIAL-NUM: MASP A - COMPLTD
```

4. Verify that the serial number entered into step 3 was entered correctly using the `rtrv-serial-num` command. This is an example of the possible output.

```
rlghncxa03w 06-10-28 21:15:37 GMT EAGLE5 36.0.0
System serial number = nt00001231
```

System serial number is not locked.

```
rlghncxa03w 06-10-28 21:15:37 GMT EAGLE5 36.0.0
Command Completed
```

If the serial number was not entered correctly, repeat steps 5 and 6 and re-enter the correct serial number.

5. Lock the serial number in the database by entering the `ent-serial-num` command with the serial number shown in step 2, if the serial number shown in step 2 is correct, or with the serial number shown in step 4, if the serial number was changed in step 3, and with the `lock=yes` parameter.

For this example, enter this command.

```
ent-serial-num:serial=<EAGLE 5 ISS's serial number>:lock=yes
```

When this command has successfully completed, the following message should appear.

```
rlghncxa03w 06-10-28 21:15:37 GMT EAGLE5 36.0.0
ENT-SERIAL-NUM: MASP A - COMPLTD
```

NOTE: If the 2000 signaling link quantity is not being enabled in this procedure, skip step 6 and go to step 7.

- Verify that HIPR cards are installed in card locations 9 and 10 in each shelf of the EAGLE 5 ISS. Enter this command.

```
rept-stat-gpl:gpl=hipr
```

This is an example of the possible output.

```
rlghncxa03w 06-10-01 11:40:26 GMT EAGLE5 36.0.0
GPL          CARD      RUNNING      APPROVED     TRIAL
HIPR         1109      126-002-000  126-002-000  126-003-000
HIPR         1110      126-002-000  126-002-000  126-003-000
HIPR         1209      126-002-000  126-002-000  126-003-000
HIPR         1210      126-002-000  126-002-000  126-003-000
HIPR         1309      126-002-000  126-002-000  126-003-000
HIPR         1310      126-002-000  126-002-000  126-003-000
HIPR         2109      126-002-000  126-002-000  126-003-000
HIPR         2110      126-002-000  126-002-000  126-003-000
Command Completed
```

If HIPR cards are installed in each the shelf in the EAGLE 5 ISS, go to step 7.

If HIPR cards are not installed on each shelf in the EAGLE 5 ISS, go to the *Installation Manual - EAGLE 5 ISS* and install the HIPR cards. Once the HIPR cards have been installed, go to step 7.

NOTE: Before the 2000 signaling link quantity is enabled, make sure the EAGLE 5 ISS is configured with the signaling link hardware shown in the “Hardware Supported for Signaling Link Quantities Greater than 1500” section on page 3-105.

If signaling hardware other than the hardware shown in the “Hardware Supported for Signaling Link Quantities Greater than 1500” section on page 3-105 is installed and provisioned, contact the Customer Care Center before enabling the 2000 signaling link quantity. Refer to the Refer to “Customer Care Center” on page 1-9 for the contact information.

- Enable the Large System # Links controlled feature for the desired quantity with the `enable-ctrl-feat` command specifying the part number corresponding to the new quantity of signaling links and the feature access key. To increase the number of signaling links the EAGLE 5 ISS can contain to 1500, enter this command.

```
enable-ctrl-feat:partnum=893005901:fak=<Large System # Links
feature access key>
```

To increase the number of signaling links the EAGLE 5 ISS can contain to 2000, enter this command.

```
enable-ctrl-feat:partnum=893005910:fak=<feature access key>
```

NOTE: A temporary feature access key cannot be specified to enable this feature.

NOTE: The values for the feature access key (the `fa` parameter) are provided by Tekelec. If you do not have the controlled feature part number or the feature access key for the feature you wish to enable, contact your Tekelec Sales Representative or Account Representative.

When the `enable-ctrl-feat` command has successfully completed, this message should appear.

```
rlghncxa03w 06-10-28 21:15:37 GMT EAGLE5 36.0.0
ENABLE-CTRL-FEAT: MASP B - COMPLTD
```

8. Verify the changes by entering the `rtrv-ctrl-feat` command with the part number specified in step 7.

If the 1500 signaling link quantity was enabled in step 7, enter this command.

```
rtrv-ctrl-feat:partnum=893005901
```

The following is an example of the possible output.

```
rlghncxa03w 06-10-28 21:15:37 GMT EAGLE5 36.0.0
The following features have been permanently enabled:
```

| Feature Name | Partnum | Status | Quantity |
|----------------------|-----------|--------|----------|
| Large System # Links | 893005901 | on | 1500 |

The following features have been temporarily enabled:

| Feature Name | Partnum | Status | Quantity | Trial Period Left |
|---------------------|---------|--------|----------|-------------------|
| Zero entries found. | | | | |

The following features have expired temporary keys:

| Feature Name | Partnum |
|---------------------|---------|
| Zero entries found. | |

If the 2000 signaling link quantity was enabled in step 7, enter this command.

```
rtrv-ctrl-feat:partnum=893005910
```

The following is an example of the possible output.

```
rlghncxa03w 06-10-28 21:15:37 GMT EAGLE5 36.0.0
The following features have been permanently enabled:
```

| Feature Name | Partnum | Status | Quantity |
|----------------------|-----------|--------|----------|
| Large System # Links | 893005910 | on | 2000 |

The following features have been temporarily enabled:

| Feature Name | Partnum | Status | Quantity | Trial Period Left |
|---------------------|---------|--------|----------|-------------------|
| Zero entries found. | | | | |

The following features have expired temporary keys:

| Feature Name | Partnum |
|---------------------|---------|
| Zero entries found. | |

9. Backup the new changes using the `chg-db:action=backup:dest=fixed` command. These messages should appear, the active Maintenance and Administration Subsystem Processor (MASP) appears first.

```

BACKUP (FIXED) : MASP A - Backup starts on active MASP.
BACKUP (FIXED) : MASP A - Backup on active MASP to fixed disk complete.
BACKUP (FIXED) : MASP A - Backup starts on standby MASP.
BACKUP (FIXED) : MASP A - Backup on standby MASP to fixed disk complete.
    
```

Flowchart 3-6. Enabling the Large System # Links Controlled Feature (Sheet 1 of 3)

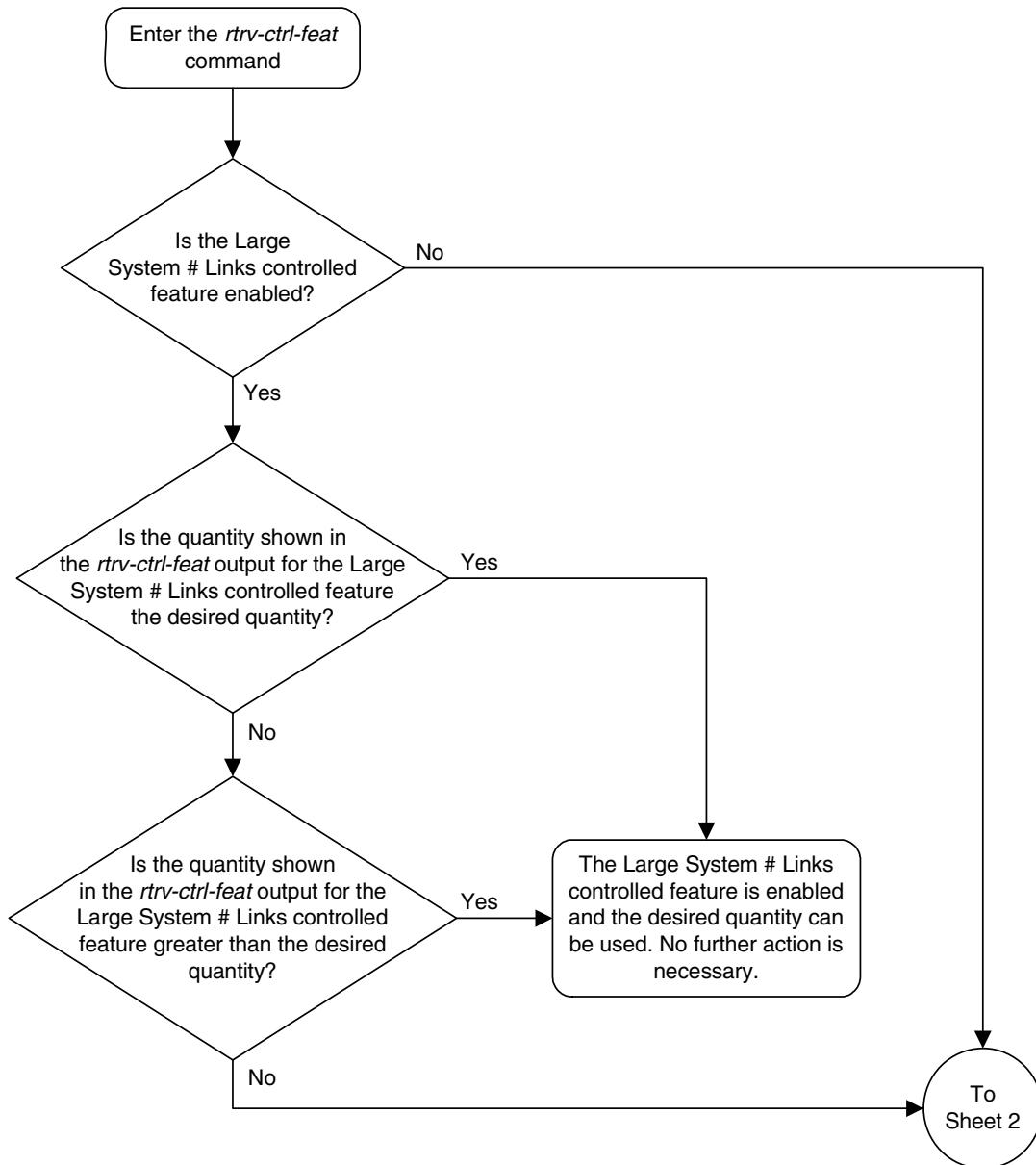

Flowchart 3-6. Enabling the Large System # Links Controlled Feature (Sheet 2 of 3)

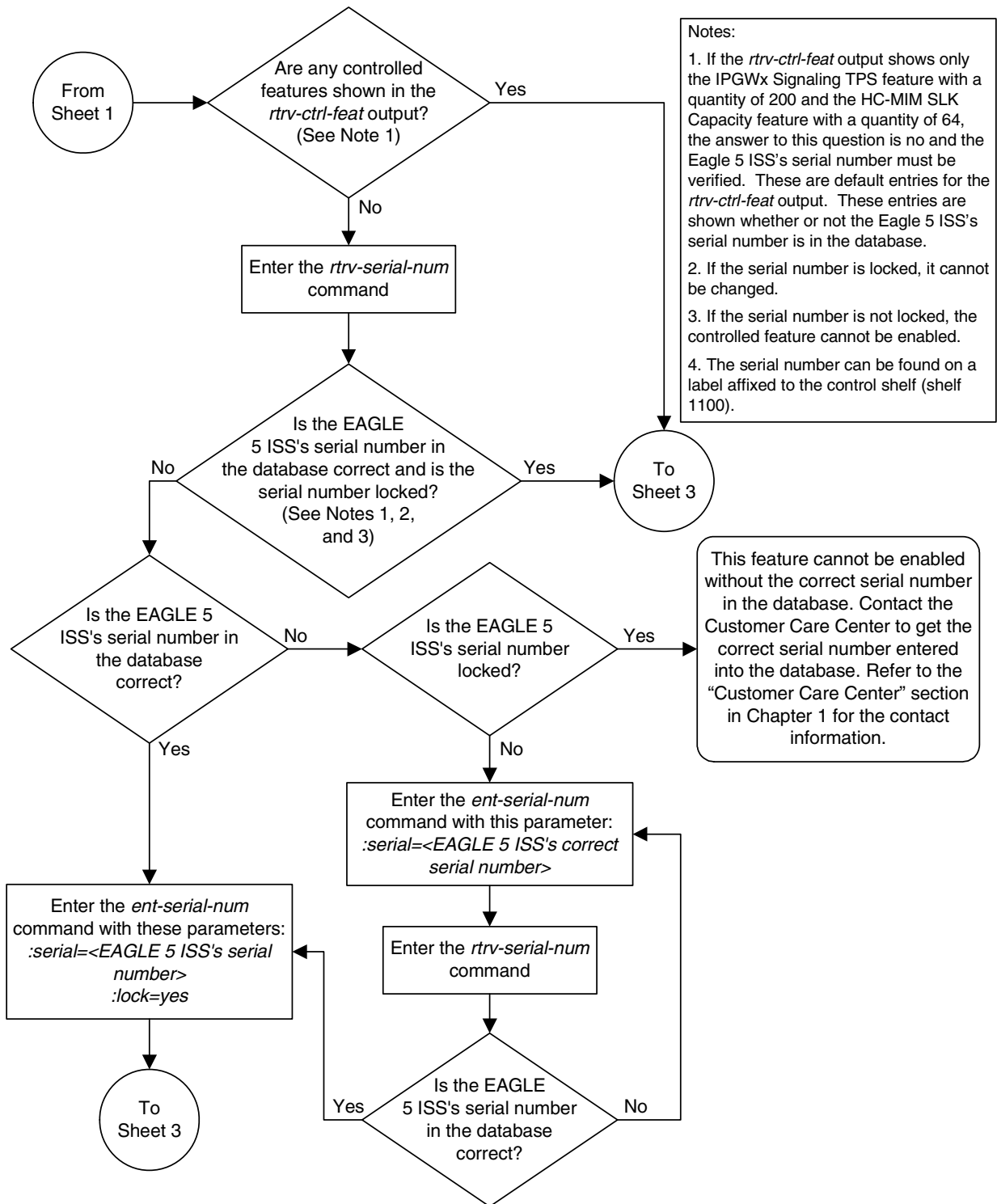

Flowchart 3-6. Enabling the Large System # Links Controlled Feature (Sheet 3 of 3)

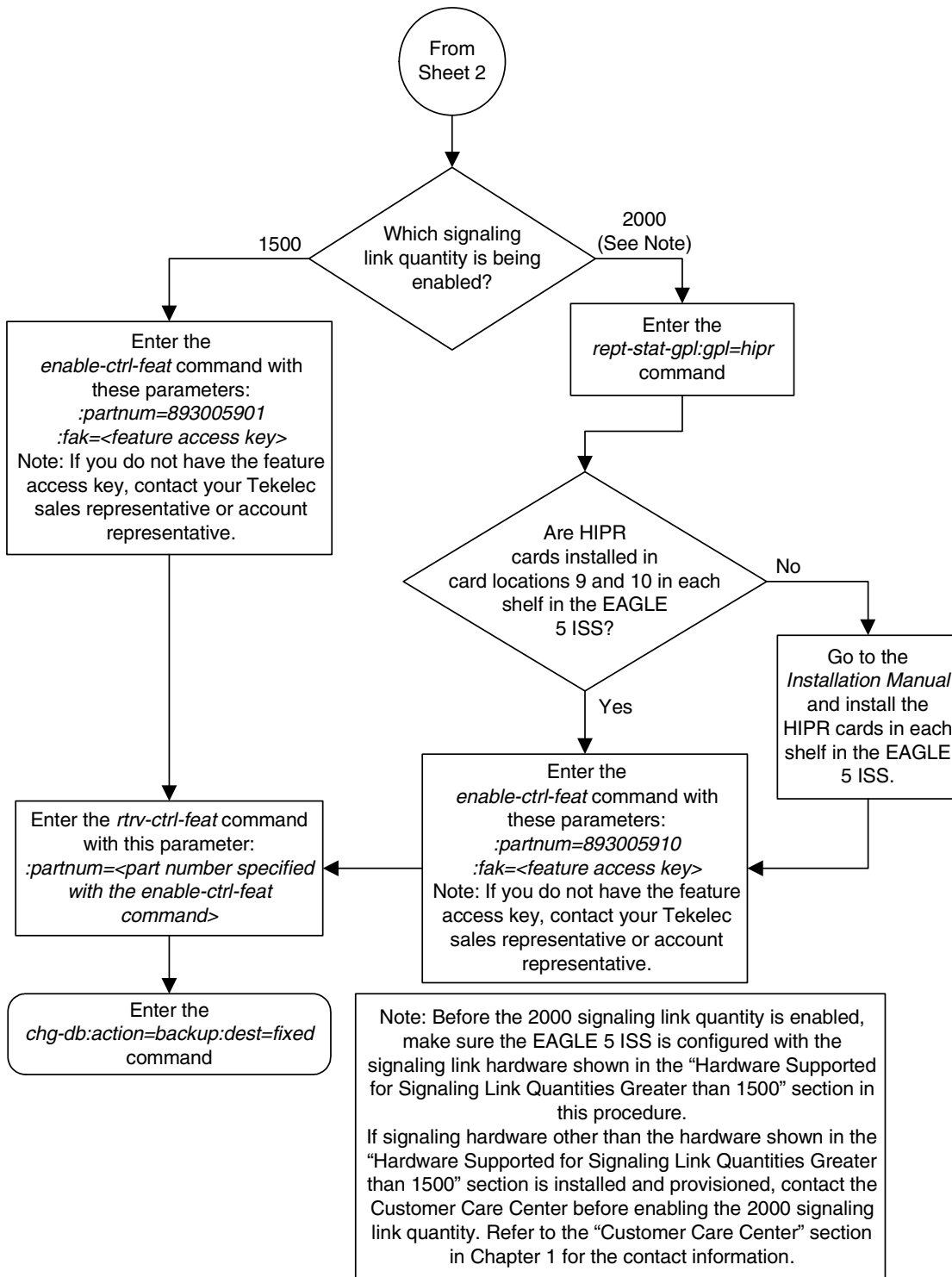

Removing an IP Signaling Link

This procedure is used to remove an IP signaling link from the database using the `dlt-slk` command. The `dlt-slk` command uses these parameters.

- `:loc` – The card location of the IP card that the IP signaling link is assigned to.
- `:link` – The signaling link on the card specified in the `loc` parameter.
- `:force` – This parameter must be used to remove the last link in a linkset without having to remove all of the routes that referenced the linkset.

The `tfatcabmlq` parameter (TFA/TCA Broadcast Minimum Link Quantity), assigned to linksets, shows the minimum number of links in the given linkset (or in the combined link set in which it resides) that must be available for traffic. When the number of signaling links in the specified linkset is equal to or greater than the value of the `tfatcabmlq` parameter, the status of the routes that use the specified linkset is set to allowed and can carry traffic. Otherwise, these routes are restricted. The value of the `tfatcabmlq` parameter cannot exceed the total number of signaling links contained in the linkset.

The `dlt-slk` command makes sure that the number of signaling links assigned to a linkset is greater than or equal to the value of the `tfatcabmlq` parameter. If the number of signaling links associated with a linkset drops below the value of the `tfatcabmlq` parameter for that linkset, the `tfatcabmlq` value for that linkset is automatically decremented. The value of the `tfatcabmlq` parameter for a specified linkset can be verified using the `rtrv-ls:lsn=<linkset name>` command specifying the name of the linkset. The `tfatcabmlq` parameter value is shown in the `tfatcabmlq` field of the `rtrv-ls` command output.

Canceling the RTRV-SLK Command

Because the `rtrv-slk` command used in this procedure can output information for a long period of time, the `rtrv-slk` command can be canceled and the output to the terminal stopped. There are three ways that the `rtrv-slk` command can be canceled.

- Press the **F9** function key on the keyboard at the terminal where the `rtrv-slk` command was entered.
- Enter the `canc-cmd` without the `trm` parameter at the terminal where the `rtrv-slk` command was entered.
- Enter the `canc-cmd:trm=<xx>`, where `<xx>` is the terminal where the `rtrv-slk` command was entered, from another terminal other than the terminal where the `rtrv-slk` command was entered. To enter the `canc-cmd:trm=<xx>` command, the terminal must allow Security Administration commands to be entered from it and the user must be allowed to enter Security Administration commands. The terminal's permissions can be verified with the `rtrv-secu-trm` command. The user's permissions can be verified with the `rtrv-user` or `rtrv-secu-user` commands.

For more information about the `canc-cmd` command, go to the *Commands Manual*.

Procedure

1. Display the current link configuration using the `rtrv-slk` command. This is an example of the possible output.

```

rlghncxa03w 06-10-19 21:16:37 GMT EAGLES 36.0.0

LOC LINK LSN          SLC TYPE      L2T          L1          PCR  PCR
      SET BPS      MODE TSET      ECM  N1  N2
1201 A  ls01          0 LIMDS0      1  56000      --- --- BASIC --- -----
1201 B  lsa1          0 LIMDS0      1  56000      --- --- BASIC --- -----
1202 B  ls02          0 LIMV35      2  64000      DTE --- BASIC --- -----
1203 A  ls03          0 LIMDS0      3  56000      --- --- BASIC --- -----
1203 B  lsa2          0 LIMDS0      1  56000      --- --- BASIC --- -----
1204 B  ls01          1 LIMDS0      1  56000      --- --- BASIC --- -----
1205 A  lsa3          0 LIMV35      4  64000      DCE ON  BASIC --- -----
1206 A  ls02          1 LIMV35      2  64000      DTE --- BASIC --- -----
1207 A  lsn1207a       0 LIMDS0      1  56000      --- --- BASIC --- -----
1207 B  lsn1207b       0 LIMDS0      1  56000      --- --- BASIC --- -----
1208 B  ls03          1 LIMDS0      3  56000      --- --- BASIC --- -----
1212 A  ls04          0 LIMV35      4  64000      DTE --- BASIC --- -----
1213 B  ls05          0 LIMDS0      5  56000      --- --- BASIC --- -----
1214 A  lsn1214a       0 LIMV35      2  64000      DTE --- PCR  76  3800
1214 B  lsa3          1 LIMV35      4  64000      DCE ON  BASIC --- -----
1215 A  ls05          1 LIMDS0      5  56000      --- --- BASIC --- -----
1301 B  ls06          0 LIMV35      6  56000      DTE --- BASIC --- -----
1304 B  ls06          1 LIMV35      6  56000      DTE --- BASIC --- -----
1308 A  ls06          2 LIMV35      6  56000      DTE --- BASIC --- -----
1311 A  ls01          2 LIMDS0      1  56000      --- --- BASIC --- -----
1311 A1 ls05          2 LIMDS0      5  56000      --- --- BASIC --- -----
1311 B  ls03          2 LIMDS0      3  56000      --- --- BASIC --- -----
1311 B1 ls07          1 LIMDS0      7  56000      --- --- BASIC --- -----
1313 A  ls07          0 LIMDS0      7  56000      --- --- BASIC --- -----
1315 A  lsn5           0 LIMV35     11  64000      DTE OFF BASIC --- -----
1317 A  lsi7           0 LIMV35     11  64000      DTE OFF BASIC --- -----

LOC LINK LSN          SLC TYPE      LP          ATM          VCI  VPI  LL
      SET BPS      TSEL          VCI  VPI  LL
1302 A  atmansi0       0 LIMATM      3  1544000     EXTERNAL  35  15  0
1305 A  atmansi1       0 LIMATM      4  1544000     INTERNAL  100 20  2
1318 A  atmansi0       1 LIMATM      9  1544000     LINE      150 25  4

LOC LINK LSN          SLC TYPE      LP          ATM          VCI  VPI  CRC4 SI SN
      SET BPS      TSEL          VCI  VPI  CRC4 SI SN
2101 A  atmitul1       0 LIME1ATM    5  2.048M     LINE      150  2  ON  1  20
2105 A  atmitul1       1 LIME1ATM    5  2.048M     LINE      35  15  ON  2  15

LOC LINK LSN          SLC TYPE      IPLIML2
2202 A  lsnlp1          0 IPLIM      SAALTALI
2205 A  lsnip1          1 IPLIM      M2PA
2204 B  lsnlp2          0 IPLIM      M2PA
2213 A  lsnip5          0 IPLIMI     M2PA
2215 A  lsnlp2          1 IPLIM      SAALTALI

LOC LINK LSN          SLC TYPE
2207 A  lsnlp3          0 SS7IPGW
2211 A  lsnlp4          0 IPGWI

LOC LINK LSN          SLC TYPE      L2T          PCR  PCR  E1  E1
      SET BPS      ECM  N1  N2  LOC  PORT TS
No Links Set Up.

```

IP⁷ Secure Gateway Configuration Procedures

```
LOC  LINK LSN          SLC TYPE      L2T          PCR PCR  T1  T1
      SET  BPS          ECM  N1  N2  LOC  PORT TS
```

No Links Set Up.

SLK table is (31 of 1200) 6% full

- Any in-service IP connections on the signaling link being removed in this procedure must be placed out of service. Have the far-end node for the signaling link being removed perform these actions:

- Place the TALI sockets in the NEA-FEP state.
 - Place the M3UA or SUA associations in either the ASP-INACTIVE or ASP-DOWN state.
-

- Display the IP link associated with the card that the signaling link being removed the database is assigned to. Enter the **rtrv-ip-lnk** command with the card location of the signaling link being removed shown in step 1. For this example, enter these commands.

```
rtrv-ip-lnk:loc=2202
```

The following is an example of the possible output.

```
rlghncxa03w 06-10-28 21:14:37 GMT EAGLE5 36.0.0
LOC  PORT IPADDR          SUBMASK          DUPLEX  SPEED  MACTYPE  AUTO  MCAST
2202 A   192.3.1.10          255.255.255.128  HALF    10     802.3    NO    NO
2202 B   -----
```

```
rtrv-ip-lnk:loc=2204
```

The following is an example of the possible output.

```
rlghncxa03w 06-10-28 21:14:37 GMT EAGLE5 36.0.0
LOC  PORT IPADDR          SUBMASK          DUPLEX  SPEED  MACTYPE  AUTO  MCAST
2204 A   192.1.1.10          255.255.255.128  HALF    10     802.3    NO    NO
2204 B   -----
```

- Display the IP host information associated with the IP link by entering the **rtrv-ip-host** command with the IP address shown in step 3. For this example, enter these commands.

```
rtrv-ip-host:ipaddr=192.001.001.010
```

The following is an example of the possible output.

```
rlghncxa03w 06-10-28 21:17:37 GMT EAGLE5 36.0.0
```

```
LOCAL IPADDR  LOCAL HOST
192.1.1.10    IPNODE1_2204
```

IP Host table is (11 of 512) 2% full

```
rtrv-ip-host:ipaddr=192.003.001.010
```

The following is an example of the possible output.

```
rlghncxa03w 06-10-28 21:17:37 GMT EAGLE5 36.0.0

LOCAL IPADDR      LOCAL HOST
192.3.1.10        IPNODE1_2202

IP Host table is (11 of 512) 2% full
```

5. Display the socket associated with the local host name shown in step 4 by entering the `rtrv-appl-sock` command. For this example, enter these commands.

```
rtrv-appl-sock:lhost=ipnode1_2202
```

The following is an example of the possible output.

```
rlghncxa03w 06-10-28 21:14:37 GMT EAGLE5 36.0.0
SNAME KC_HLR1_2202
LINK      A
LHOST     IPNODE1_2202
RHOST     KC_HLR2
LPORT     7000          RPORT     7001
SERVER    YES          DCMP5     1
REXMIT    FIXED       RTT       60
OPEN      YES          ALW       YES

IP Appl Sock/Assoc table is (4 of 4000) 1% full
```

```
rtrv-appl-sock:lhost=ipnode1_2204
```

The following is an example of the possible output.

```
rlghncxa03w 06-10-28 21:14:37 GMT EAGLE5 36.0.0

IP Appl Sock/Assoc table is (4 of 4000) 1% full
```

NOTE: If the specified socket name is not in the database, the `rtrv-appl-sock` output shows no socket information as shown above.

NOTE: If there is no socket shown in step 5, or the `open` and `alw` parameter values of the socket shown in step 5 are `no`, skip this step and go to step 7.

6. Change the `open` and `alw` parameter values in the socket shown in step 5 using the `chg-appl-sock` command with the `open=no` and `alw=no` parameters, as necessary.

For example, enter this command.

```
chg-appl-sock:sname=kc_hlr1_2202:open=no:alw=no
```

When this command has successfully completed, the following message should appear.

```
rlghncxa03w 06-10-28 21:16:37 GMT EAGLE5 36.0.0
CHG-APPL-SOCK: MASP A - COMPLTD
```

7. Display the association associated with the local host name shown in step 5 that was not assigned to a socket by entering the `rtrv-assoc` command. For this example, enter this command.

```
rtrv-assoc:localhost=ipnode1_2204
```

This is an example of possible output.

```
rlghncxa03w 06-10-28 09:12:36 GMT EAGLE5 36.0.0
CARD IPLNK
ANAME          LOC  PORT  LINK ADAPTER LPORT RPORT OPEN ALW
assoc1         2204 A      A    M3UA    1030  1030 YES  YES
```

```
IP Appl Sock/Assoc table is (4 of 4000) 1% full
Assoc Buffer Space Used (16 KB of 3200 KB) on LOC = 2204
```

NOTE: If there is no association shown in step 7, or the `open` and `alw` parameter values of the association shown in step 7 are `no`, skip this step and go to step 9.

8. Change the value of the `open` and `alw` parameters to `no` by specifying the `chg-assoc` command with the `open=no` and `alw=no` parameters, as necessary. For this example, enter this command.

```
chg-assoc:aname=assoc1:open=no:alw=no
```

When this command has successfully completed, this message should appear.

```
rlghncxa03w 06-10-28 09:12:36 GMT EAGLE5 36.0.0
CHG-ASSOC: MASP A - COMPLTD;
```

9. Deactivate the link to be removed using the `dact-slk` command, using the output from step 1 to obtain the `card` location and `link` parameter value of the signaling link to be removed. For this example, enter these commands.

```
dact-slk:loc=2202:link=a
```

```
dact-slk:loc=2204:link=a
```

When each of these command has successfully completed, this message should appear.

```
rlghncxa03w 06-10-07 08:41:12 GMT EAGLE5 36.0.0
Deactivate Link message sent to card
```

10. Verify that the link is out of service - maintenance disabled (OOS-MT-DSBLD) using the **rept-stat-slk** command with the card location and **link** parameter values specified in step 9. For this example, enter these commands.

```
rept-stat-slk:loc=2202:link=a
```

This is an example of the possible output.

```
rlghncxa03w 06-10-23 13:06:25 GMT EAGLE5 36.0.0
SLK      LSN      CLLI      PST      SST      AST
2202,A   ls05      ls05clli  OOS-MT   Unavail  ----
  ALARM STATUS      = *   0235 REPT-LNK-MGTINH: local inhibited
  UNAVAIL REASON    = LI
```

```
rept-stat-slk:loc=2204:link=a
```

This is an example of the possible output.

```
rlghncxa03w 06-10-23 13:06:25 GMT EAGLE5 36.0.0
SLK      LSN      CLLI      PST      SST      AST
2204,A   ls04      ls04clli  OOS-MT   Unavail  ----
  ALARM STATUS      = *   0235 REPT-LNK-MGTINH: local inhibited
  UNAVAIL REASON    = LI
```

11. If the signaling link to be removed is the last signaling link on a card, the card must be inhibited before the signaling link is removed. Before entering the **dlt-slk** command, enter the **rmv-card** command and specify the location of the card to be inhibited. The card location is shown in the output of **rept-stat-slk** command executed in step 10. If the signaling link to be removed is not the last signaling link on the card, go to step 12.

In the example used for this procedure, the signaling link is the last signaling link on the card and must be inhibited. Enter these commands.

```
rmv-card:loc=2202
```

```
rmv-card:loc=2204
```

When each of these command has successfully completed, this message should appear.

```
rlghncxa03w 06-10-07 08:41:12 GMT EAGLE5 36.0.0
Card has been inhibited.
```

12. Remove the signaling link from the EAGLE 5 ISS using the **dlt-slk** command. If there is only one signaling link in the linkset, the **force=yes** parameter must be specified to remove the signaling link.

In the example used in this procedure, the signaling link is the last signaling link in the linkset. Enter these commands.

```
dlt-slk:loc=2202:link=a:force=yes
```

```
dlt-slk:loc=2204:link=a:force=yes
```

When this command has successfully completed, this message should appear.

```
rlghncxa03w 06-10-07 08:41:17 GMT EAGLE5 36.0.0
DLT-SLK: MASP A - COMPLTD
```

13. Verify the changes using the `rtv-slk` command. This is an example of the possible output.

```

rlghncxa03w 06-10-19 21:16:37 GMT EAGLE5 36.0.0

LOC LINK LSN SLC TYPE L2T L1 PCR PCR
SET BPS MODE TSET ECM N1 N2
1201 A ls01 0 LIMDS0 1 56000 --- --- BASIC ---
1201 B lsa1 0 LIMDS0 1 56000 --- --- BASIC ---
1202 B ls02 0 LIMV35 2 64000 DTE --- BASIC ---
1203 A ls03 0 LIMDS0 3 56000 --- --- BASIC ---
1203 B lsa2 0 LIMDS0 1 56000 --- --- BASIC ---
1204 B ls01 1 LIMDS0 1 56000 --- --- BASIC ---
1205 A lsa3 0 LIMV35 4 64000 DCE ON BASIC ---
1206 A ls02 1 LIMV35 2 64000 DTE --- BASIC ---
1207 A lsn1207a 0 LIMDS0 1 56000 --- --- BASIC ---
1207 B lsn1207b 0 LIMDS0 1 56000 --- --- BASIC ---
1208 B ls03 1 LIMDS0 3 56000 --- --- BASIC ---
1213 B ls05 0 LIMDS0 5 56000 --- --- BASIC ---
1214 A lsn1214a 0 LIMV35 2 64000 DTE --- PCR 76 3800
1214 B lsa3 1 LIMV35 4 64000 DCE ON BASIC ---
1215 A ls05 1 LIMDS0 5 56000 --- --- BASIC ---
1301 B ls06 0 LIMV35 6 56000 DTE --- BASIC ---
1304 B ls06 1 LIMV35 6 56000 DTE --- BASIC ---
1308 A ls06 2 LIMV35 6 56000 DTE --- BASIC ---
1311 A ls01 2 LIMDS0 1 56000 --- --- BASIC ---
1311 A1 ls05 2 LIMDS0 5 56000 --- --- BASIC ---
1311 B ls03 2 LIMDS0 3 56000 --- --- BASIC ---
1311 B1 ls07 1 LIMDS0 7 56000 --- --- BASIC ---
1313 A ls07 0 LIMDS0 7 56000 --- --- BASIC ---
1315 A lsn5 0 LIMV35 11 64000 DTE OFF BASIC ---
1317 A lsi7 0 LIMV35 11 64000 DTE OFF BASIC ---

LOC LINK LSN SLC TYPE LP ATM VCI VPI LL
SET BPS TSEL
1302 A atmansi0 0 LIMATM 3 1544000 EXTERNAL 35 15 0
1305 A atmansi1 0 LIMATM 4 1544000 INTERNAL 100 20 2
1318 A atmansi0 1 LIMATM 9 1544000 LINE 150 25 4

LOC LINK LSN SLC TYPE LP ATM E1ATM
SET BPS TSEL VCI VPI CRC4 SI SN
2101 A atmitul 0 LIME1ATM 5 2.048M LINE 150 2 ON 1 20
2105 A atmitul 1 LIME1ATM 5 2.048M LINE 35 15 ON 2 15

LOC LINK LSN SLC TYPE IPLIML2
2205 A lsnip1 1 IPLIM M2PA
2213 A lsnip5 0 IPLIMI M2PA
2215 A lsnlp2 1 IPLIM SAALTALI

LOC LINK LSN SLC TYPE
2207 A lsnlp3 0 SS7IPGW
2211 A lsnlp4 0 IPGWI

LOC LINK LSN SLC TYPE L2T PCR PCR E1 E1
SET BPS ECM N1 N2 LOC PORT TS
No Links Set up.

LOC LINK LSN SLC TYPE L2T PCR PCR T1 T1
SET BPS ECM N1 N2 LOC PORT TS
No Links Set up.

SLK table is (31 of 1200) 6% full

```

14. Back up the new changes using the **chg-db:action=backup:dest=fixed** command. These messages should appear, the active Maintenance and Administration Subsystem Processor (MASP) appears first.

```

BACKUP (FIXED) : MASP A - Backup starts on active MASP.
BACKUP (FIXED) : MASP A - Backup on active MASP to fixed disk complete.
BACKUP (FIXED) : MASP A - Backup starts on standby MASP.
BACKUP (FIXED) : MASP A - Backup on standby MASP to fixed disk complete.
    
```

Flowchart 3-7. Removing an IP Signaling Link (Sheet 1 of 3)

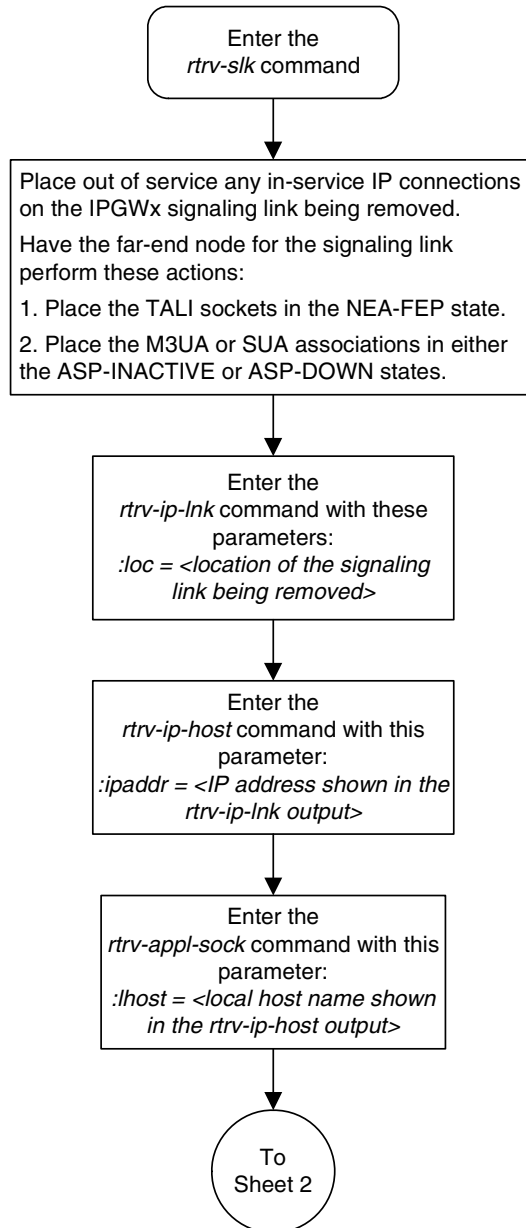

Flowchart 3-7. Removing an IP Signaling Link (Sheet 2 of 3)

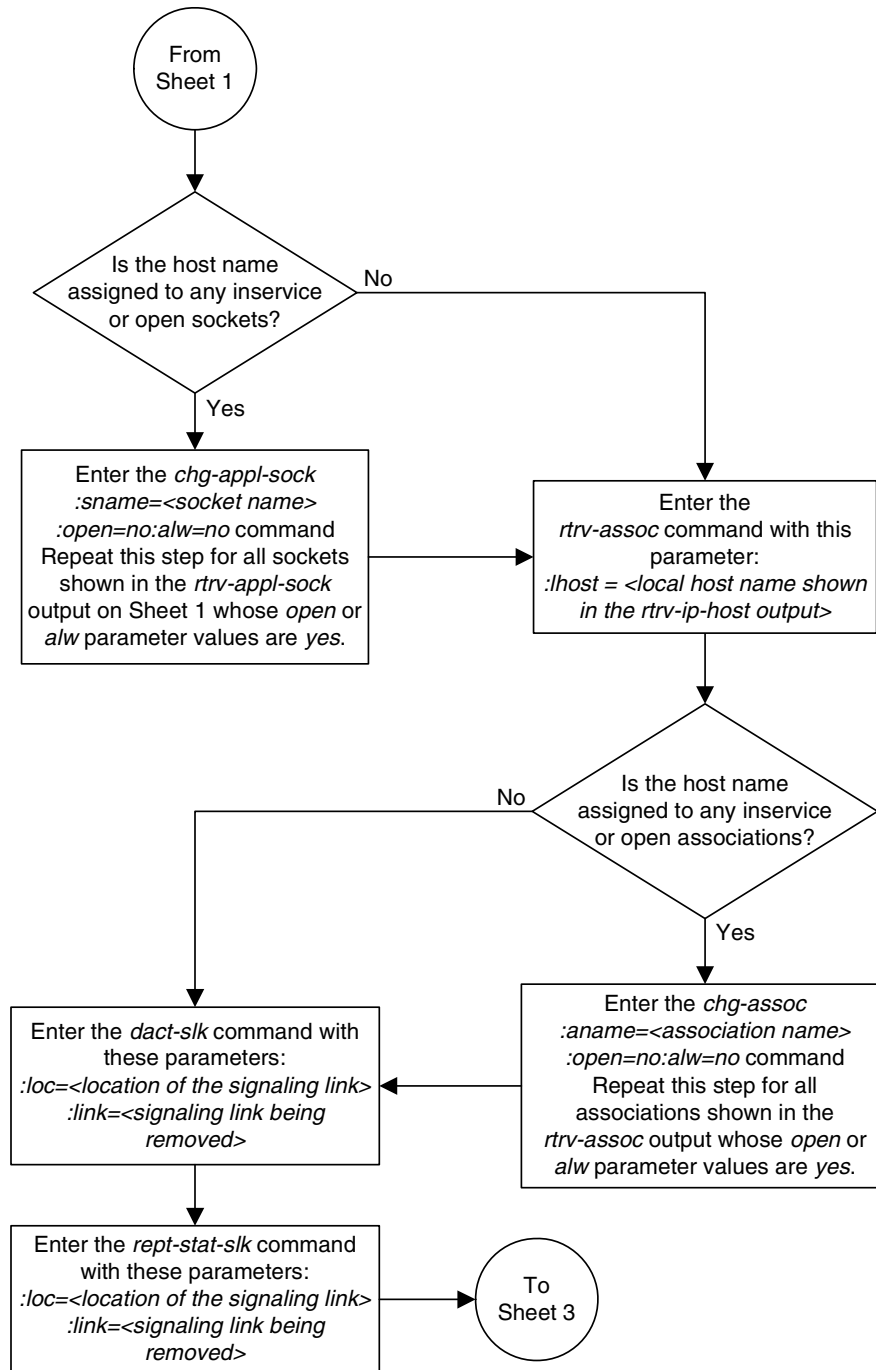

Flowchart 3-7. Removing an IP Signaling Link (Sheet 3 of 3)

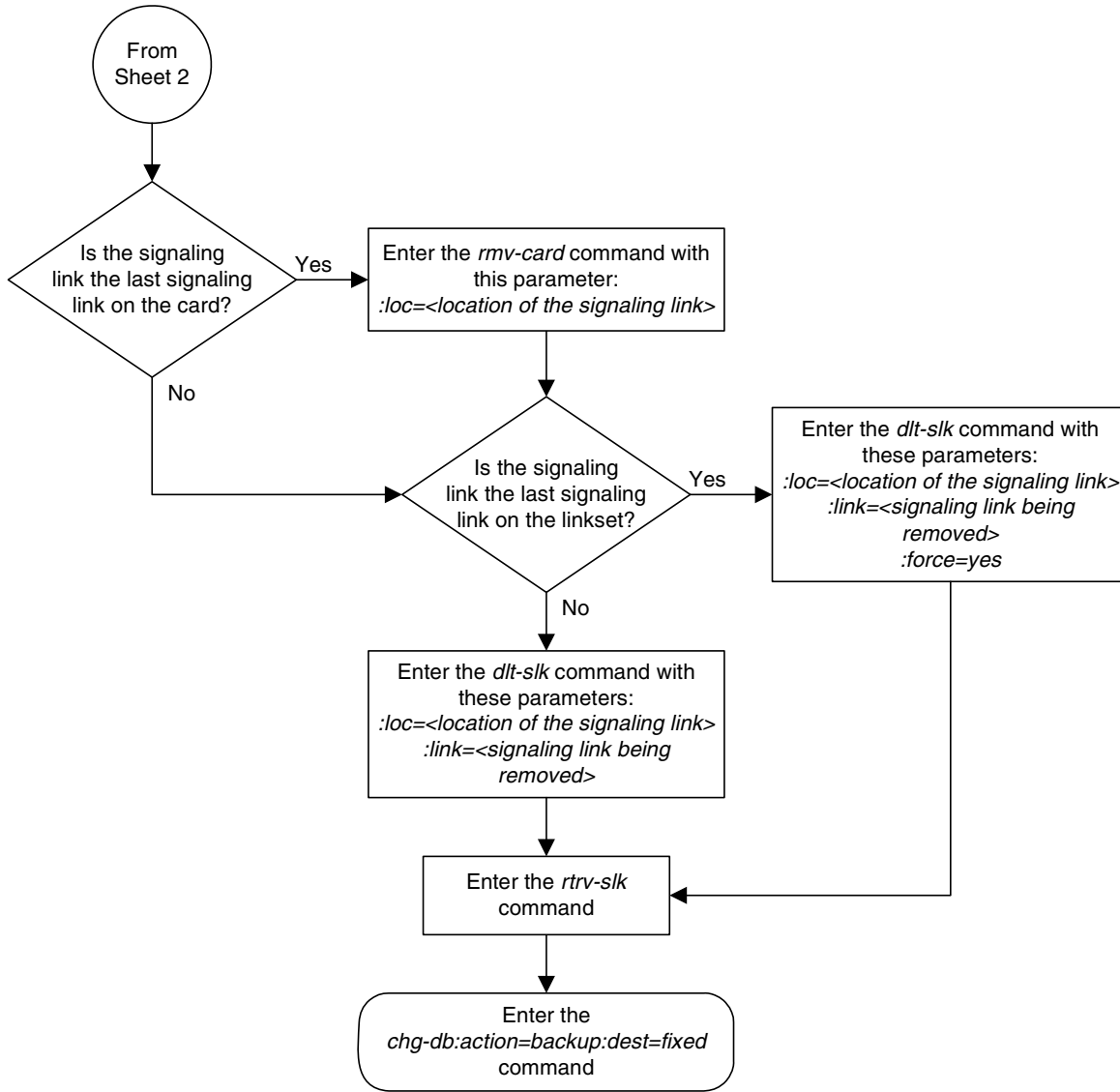

Changing the IP Protocol Option

Use this procedure to change the IP protocol option with the `chg-sg-opts:sync` command.

To change the `:sync` option, which has the values `tali` or `sassi`, the IP cards associated with the `ss7ipgw` or `ipgwi` application must be inhibited, and the signaling links assigned to this card must be deactivated.

Procedure

1. Display the current IP options in the database by entering the `rtrv-sg-opts` command. The following is an example of the possible output.

```
rlghncxa03w 06-10-28 21:16:37 GMT EAGLE5 36.0.0
SYNC:          TALI
SRKQ:          250
DRKQ:          750
SNMPCONT:      john doe 555-123-4567
GETCOMM:       public
SETCOMM:       private
TRAPCOMM:      public
INHFEPALM:     NO
SCTPCSUM:      crc32c
IPGWABATE:     NO
IPLIMABATE:    NO
IPTPSALMTHRESH: 80
```

To change the protocol option (synchronization code) for the card, the signaling link to the IP card and the card have to be inhibited.

2. Display the current IP parameters associated with card in the database by entering the `rtrv-ip-card` command. The following is an example of the possible output.

```
rlghncxa03w 06-10-28 21:17:37 GMT EAGLE5 36.0.0
LOC 1201
  SRCHORDR  LOCAL
  DNSA      150.1.1.1
  DNSB      -----
  DEFROUTER -----
  DOMAIN    -----
LOC 1203
  SRCHORDR  LOCAL
  DNSA      192.1.1.40
  DNSB      -----
  DEFROUTER -----
  DOMAIN    NC.TEKELEC.COM
LOC 1205
  SRCHORDR  SRVONLY
  DNSA      192.1.1.40
  DNSB      -----
  DEFROUTER -----
  DOMAIN    NC.TEKELEC.COM
```

3. Display the signaling link associated with the card shown in step 2 using the **rtrv-slk** command specifying the card location. For this example, enter this command.

```
rtrv-slk:loc=1201
```

This is an example of the possible output.

```
rlghncxa03w 06-10-19 21:17:04 GMT EAGLE5 36.0.0
LOC  LINK LSN          SLC TYPE  IPLIML2
1201 A   nc001          0  IPLIM  SAALTALI
```

4. Verify the status of the signaling link shown in step 3 using the **rept-stat-slk** command. For example, enter this command.

```
rept-stat-slk:loc=1201:link=a
```

The output lists the signaling link assigned to this card:

```
rlghncxa03w 06-10-28 21:16:37 GMT EAGLE5 36.0.0
SLK   LSN      CLLI      PST      SST      AST
1201,A nc001    ----- IS-NR      Avail    ----
Command Completed.
```

If the signaling link is in service-normal (IS-NR), go to step 5 to deactivate the signaling link. If the signaling link is out-of-service-maintenance disabled (OOS-MT-DSBLD), go to step 7 to verify the card status.

5. Deactivate the signaling link assigned to the IP card using the **dact-slk** command. For example, enter this command:

```
dact-slk:loc=1201:link=a
```



CAUTION: This command impacts network performance and should only be used during periods of low traffic.

After this command has successfully completed, this message appears.

```
rlghncxa03w 06-10-12 09:12:36 GMT EAGLE5 36.0.0
Deactivate Link message sent to card.
```

6. Verify the new link status using the **rept-stat-slk** command. For example, enter this command.

```
rept-stat-slk:loc=1201:link=a
```

The output displays the link status as OOS-MT-DSBLD and gives off a minor alarm:

```
rlghncxa03w 06-10-27 17:00:36 GMT EAGLE5 36.0.0
SLK   LSN      CLLI      PST      SST      AST
1201,A nc001    ----- OOS-MT-DSBLD AVAIL    ---
ALARM STATUS = * 0236 REPT-LKS:not aligned
UNAVAIL REASON = NA
Command Completed.
```

- Verify the status of the IP card to be inhibited using the **rept-stat-card** command. For example, enter this command.

```
rept-stat-card:loc=1201
```

This is an example of the possible output.

```
rlghncxa03w 06-10-27 17:00:36 GMT EAGLE5 36.0.0
CARD  VERSION      TYPE      APPL      PST          SST          AST
1201  114-000-000    DCM       IPLIM     IS-NR        Active       -----
ALARM STATUS      = No Alarms.
BPDCM GPL         = 002-102-000
IMT BUS A         = Conn
IMT BUS B         = Conn
SIGNALING LINK STATUS
SLK   PST          LS          CLLI
A     OOS-MT-DSBLD  nc001      -----
```

Command Completed.

If the IP card to be inhibited is in service-normal (IS-NR), go to step 8 to inhibit the IP card. If the IP card is out-of-service-maintenance disabled (OOS-MT-DSBLD), go to step 10 to change the IP options.

- Inhibit the IP card using the **inh-card** command. For example, enter this command.

```
inh-card:loc=1201
```

This message should appear.

```
rlghncxa03w 06-10-28 21:18:37 GMT EAGLE5 36.0.0
Card has been inhibited.
```

- Display the status of the IP card to verify that it is out-of-service maintenance-disabled (OOS-MT-DSBLD). Enter this command.

```
rept-stat-card:loc=1201
```

This is an example of the possible output.

```
rlghncxa03w 06-10-27 17:00:36 GMT EAGLE5 36.0.0
CARD  VERSION      TYPE      APPL      PST          SST          AST
1201  114-000-000    DCM       IPLIM     OOS-MT-DSBLD Manual       -----
ALARM STATUS      = No Alarms.
BPDCM GPL         = 002-102-000
IMT BUS A         = Conn
IMT BUS B         = Conn
SIGNALING LINK STATUS
SLK   PST          LS          CLLI
A     OOS-MT-DSBLD  nc001      -----
```

Command Completed.

10. Change the IP options in the database using the **chg-sg-opts** command. For this example, enter this command.

```
chg-sg-opts:sync=sassi
```

When this command has successfully completed, the following message should appear.

```
rlghncxa03w 06-10-28 21:19:37 GMT EAGLE5 36.0.0
CHG-SG-OPTS: MASP A - COMPLTD
```

11. Verify the new IP options in the database using the **rtrv-sg-opts** command. The following is an example of the possible output.

```
rlghncxa03w 06-10-28 21:16:37 GMT EAGLE5 36.0.0
SYNC:          SASSI
SRKQ:          250
DRKQ:          750
SNMPCONT:     john doe 555-123-4567
GETCOMM:      public
SETCOMM:      private
TRAPCOMM:     public
INHFEPALM:    NO
SCTPCSUM:     crc32c
IPGWABATE:    NO
IPLIMABATE:   NO
IPTPSALMTHRESH: 80
```

NOTE: If step 8 was not performed, skip steps 12 and 13, and go to step 14.

12. Allow the IP card that was inhibited in step 8 using the **alw-card** command. For example, enter this command.

```
alw-card:loc=1201
```

This message should appear.

```
rlghncxa03w 06-10-28 21:21:37 GMT EAGLE5 36.0.0
Card has been allowed.
```

13. Verify the in-service normal (IS-NR) status of the IP card using the **rept-stat-card** command. For example, enter this command.

```
rept-stat-card:loc=1201
```

This is an example of the possible output.

```
rlghncxa03w 06-10-27 17:00:36 GMT EAGLE5 36.0.0
CARD  VERSION      TYPE      APPL      PST          SST          AST
1201  114-000-000    DCM       IPLIM     IS-NR        Active       -----
    ALARM STATUS      = No Alarms.
    BPDCM GPL         = 002-102-000
    IMT BUS A         = Conn
    IMT BUS B         = Conn
    SIGNALING LINK STATUS
      SLK   PST          LS          CLLI
      A     IS-NR        nc001      -----
```

Command Completed.

NOTE: If step 5 was not performed, skip steps 14 and 15, and go to step 16.

14. Activate the signaling link from step 5 using the **act-slk** command. For example, enter this command.

```
act-slk:loc=1201:link=a
```

The link changes its state from OOS-MT-DSBLD (out-of-service maintenance-disabled) to IS-NR (in-service normal).

The output confirms the activation.

```
rlghncxa03w 06-10-07 11:11:28 GMT EAGLE5 36.0.0
Activate Link message sent to card
```

15. Verify the in-service normal (IS-NR) status of the signaling link by using the **rept-stat-slk** command. For example, enter this command.

```
rept-stat-slk:loc=1201:link=a
```

This message should appear.

```
rlghncxa03w 06-10-28 21:16:37 GMT EAGLE5 36.0.0
SLK      LSN      CLLI      PST      SST      AST
1201,A   nc001     -----  IS-NR    Avail    ----
Command Completed.
```

16. Back up the new changes using the **chg-db:action=backup:dest=fixed** command. These messages should appear, the active Maintenance and Administration Subsystem Processor (MASP) appears first.

```
BACKUP (FIXED) : MASP A - Backup starts on active MASP.
BACKUP (FIXED) : MASP A - Backup on active MASP to fixed disk complete.
BACKUP (FIXED) : MASP A - Backup starts on standby MASP.
BACKUP (FIXED) : MASP A - Backup on standby MASP to fixed disk complete.
```

Flowchart 3-8. Changing the IP Protocol Option (Sheet 1 of 2)

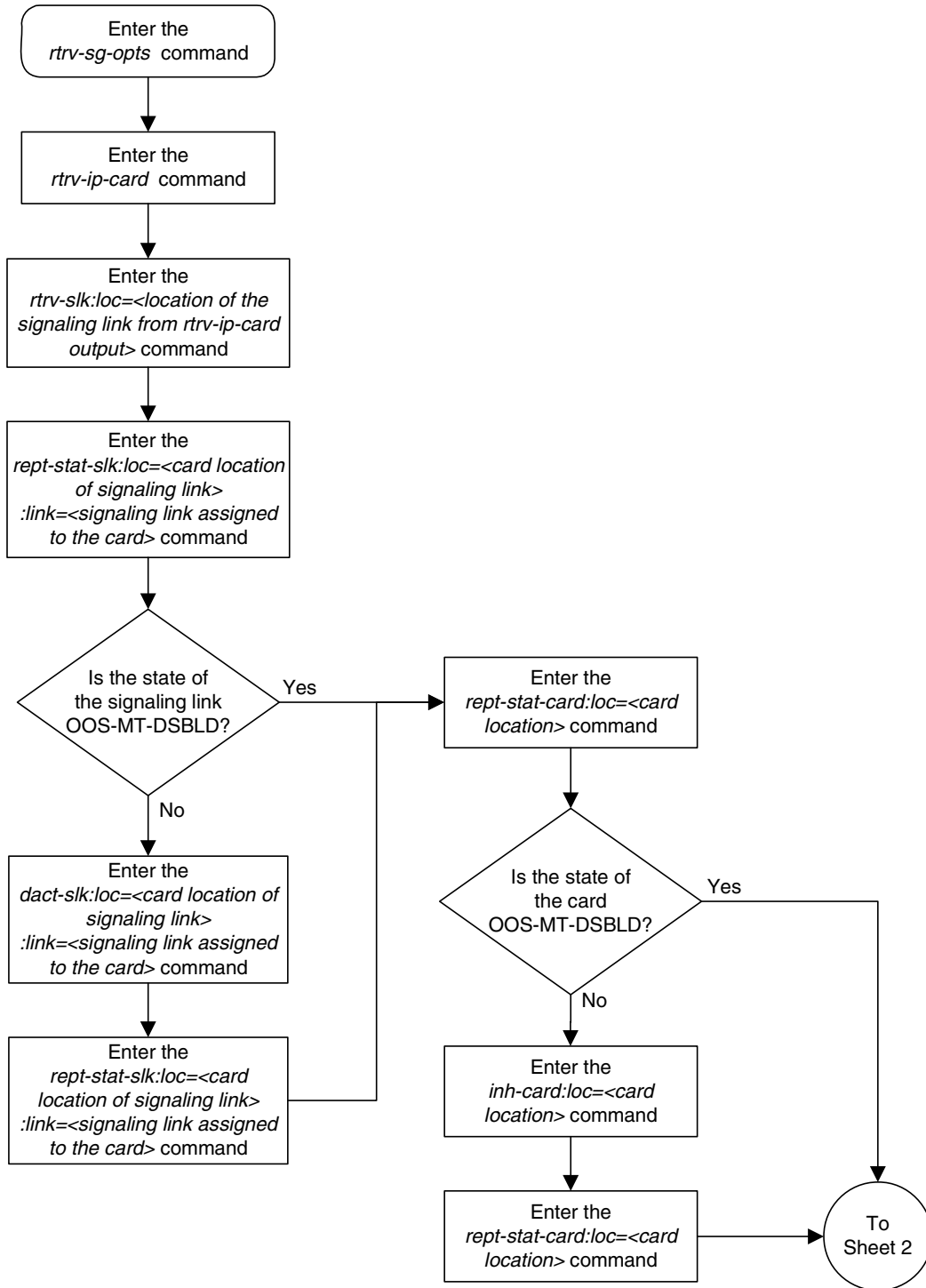

Flowchart 3-8. Changing the IP Protocol Option (Sheet 2 of 2)

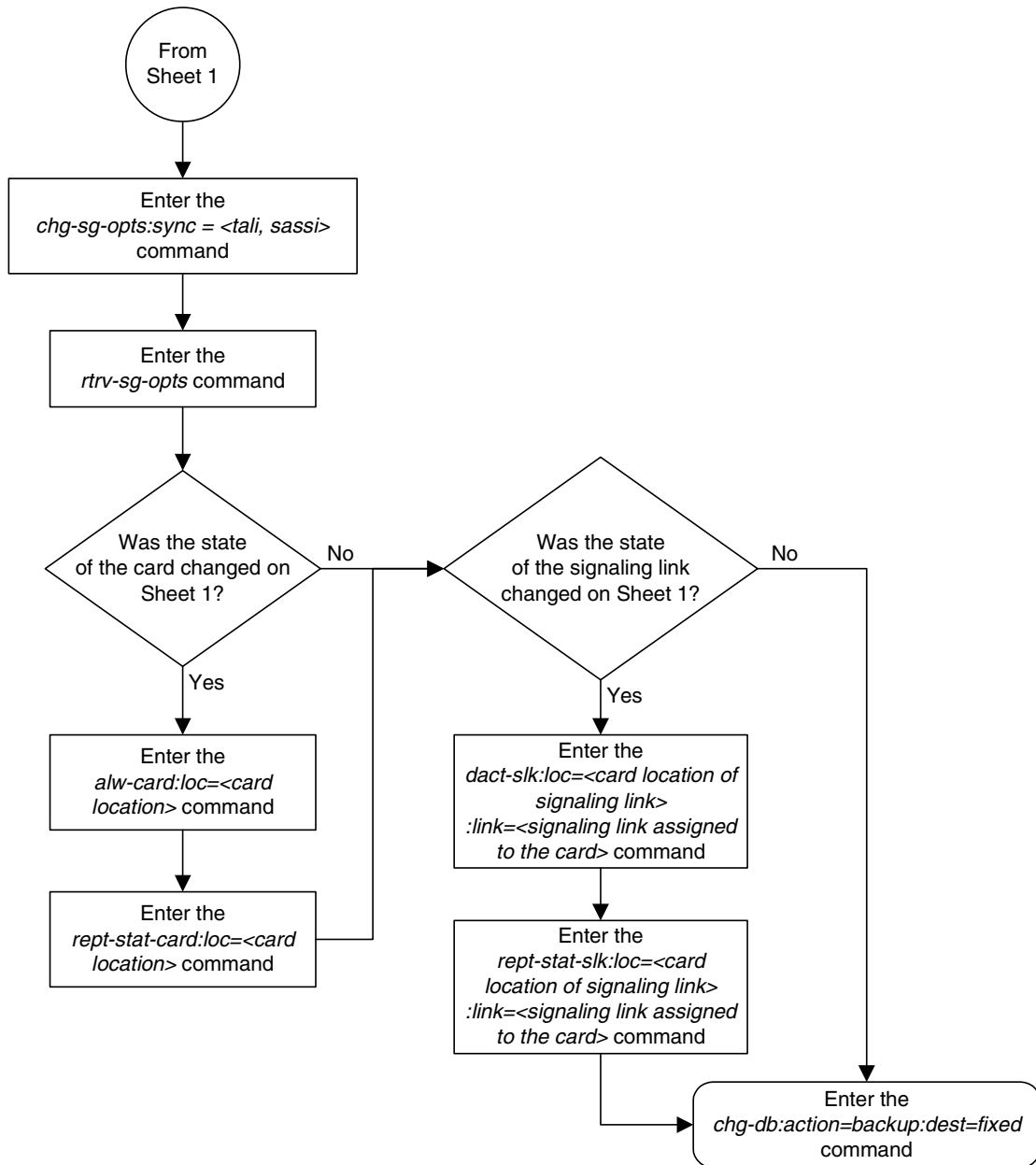

Changing IP Options other than SYNC and SCTPCSUM

Use this procedure to change the IP options defined by these parameters: **drkq**, **getcomm**, **setcomm**, **snmpcont**, **srkq**, **trapcomm**, **inhfepalm**, **ipgwabate**, **iplimabate**. These parameters do not require the IP card associated with an **ss7ipgw** or **ipgwi** application to be inhibited prior to configuration.

NOTE: The **chg-sg-opts** command also contains the **iptpsalmthresh** parameter, used to configure the IP TPS alarm threshold. This parameter is not used in this procedure. Perform the “Configuring the IP TPS Alarm Threshold” procedure on page 3-324 to configure the IP TPS alarm threshold with the **iptpsalmthresh** parameter.

:drkq – The dynamic routing key quantity used to specify the maximum number of dynamic routing key entries in the Routing Key table of each **ss7ipgw** and **ipgwi** card.

:getcomm – The community name used to validate SNMP *Get* and *GetNext* requests. This value applies to each IP card SNMP agent.

:setcomm – The community name used to validate SNMP *Set* requests. This value applies to each IP card SNMP agent.

:snmpcont – The system contact information for each IP card SNMP agent, used to define the *sysContact* object in the SNMP MIB II System Group.

:srkq – The static routing key quantity used to specify the maximum number of static routing key entries in the Routing Key table of each **ss7ipgw** and **ipgwi** card.

:trapcomm – The community name used when sending SNMP traps. This value applies to each IP card SNMP agent.

:inhfepalm – This parameter specifies whether or not major alarms for TALI sockets whose secondary state is NEA-FEP will be inhibited (suppressed). This value applies to all IPLIM and SS7IPGW cards in the EAGLE 5 ISS.

When this parameter is set to **no** (default), the NEA-FEP sockets are reported as OOS-MT and a major alarm (UAM 0084 - IP Connection Unavailable) is raised for that connection.

When this parameter is set to **yes**, all TALI sockets with a secondary status of NEA-FEP are reported as IS-NR and no socket alarm is raised. For IPLIM and IPLIMI cards, where each link consists of a single TALI socket, a link alarm will still be raised when the TALI socket's secondary status is NEA-FEP, regardless of the **inhfepalm** parameter value.

:ipgwabate – enables (**ipgwabate=yes**) or disables (**ipgwabate=no**) SS7 congestion abatement procedures for SS7IPGW signaling links (signaling links assigned to cards running the **ss7ipgw** application). The default value for this parameter is **no**.

:iplimabate – enables (**iplimabate=yes**) or disables (**iplimabate=no**) SS7 congestion abatement procedures for IPLIM signaling links (signaling links assigned to cards running the **iplim** application). The default value for this parameter is **no**.

The sum of the values specified for the **srkq** and **drkq** parameters must not be greater than:

- 1000 if there are any DCM cards (870-1945-xx) running the **ss7ipgw** or **ipgwi** application.
- 2500 if all cards that are running the **ss7ipgw** or **ipgwi** application are SSEDCCM cards (870-2372-xx).

Replacing an SSEDCCM card with a dual-slot DCM card when the sum of the values for the **srkq** and **drkq** parameters is greater than 1000 will result in the DCM card being auto-inhibited.

The value specified for the **srkq** parameter cannot be less than the current number of static entries in the Routing Key table.

The value that can be specified for the **srkq** parameter also depends on how many dynamic routing keys are actively registered. The value specified for the **srkq** parameter cannot exceed the lowest value determined by subtracting the number of dynamic entries on either an **ss7ipgw** or **ipgwi** card from:

- 1000 if there are any dual-slot DCM cards (870-1945-xx) running the **ss7ipgw** or **ipgwi** application
- 2500 if all cards that are running the **ss7ipgw** or **ipgwi** application are SSEDCCM cards (870-2372-xx).

For example, if one dual-slot DCM card has 200 dynamic entries and the other card has 300 dynamic entries, the value specified for **srkq** cannot exceed 700 (1000 - 300 = 700; 1000 - 200 = 800; 700 is the lower value).

If **d** is the current maximum number of actual dynamic routing keys on any card that is running the **ss7ipgw** or **ipgwi** application, then the sum of **d** and the **srkq** value cannot exceed:

- 1000 per card if there are any dual-slot DCM cards (870-1945-xx) running the **ss7ipgw** or **ipgwi** application
- 2500 per card if all cards that are running the **ss7ipgw** or **ipgwi** application are SSEDCCM cards (870-2372-xx).

Effectively this means that even if the **drkq** parameter value has been decreased to less than **d**, the **srkq** value cannot be increased until **d** has also decreased.

The Dynamic Routing Key feature must be on in order to enter the **drkq** parameter. If the current value of the **drkq** parameter is greater than 0, then the Dynamic Routing Key feature is on. If the current value of the **drkq** parameter is 0, enter the **rtrv-feat** command. The **DYNRTK** field in the **rtrv-feat** command output shows whether or not this feature is on.

The values of the **snmpcont**, **getcomm**, **setcomm**, and **trapcomm** parameters are a string of up to 32 characters that is not case sensitive. If the character string contains characters other than alphanumeric characters, the character string must be enclosed in single quotes.

Procedure

1. Display the current IP options in the database by entering the `rtrv-sg-opts` command. The following is an example of the possible output.

```
rlghncxa03w 06-10-28 21:17:37 GMT EAGLE5 36.0.0
SYNC:          TALI
SRKQ:          250
DRKQ:          750
SNMPCONT:     john doe 555-123-4567
GETCOMM:      public
SETCOMM:      private
TRAPCOMM:     public
INHFEPALM:    NO
SCTPCSUM:     crc32c
IPGWABATE:    NO
IPLIMABATE:   NO
IPTPSALMTHRESH: 80
```

NOTE: If the current value of the `drkq` parameter is 0 and is not being changed, or if the current value of the `drkq` parameter is greater than 0, skip steps 2 and 3, and go to step 4.

2. Verify that the Dynamic Routing Key feature is on, by entering the `rtrv-feat` command. If the Dynamic Routing Key feature is on, the `DYNRTK` field should be set to `on`. For this example, the Dynamic Routing Key feature is off.

NOTE: The `rtrv-feat` command output contains other fields that are not used by this procedure. If you wish to see all the fields displayed by the `rtrv-feat` command, see the `rtrv-feat` command description in the *Commands Manual*.

NOTE: If the Dynamic Routing Key feature is on, skip step 3 and go to step 4.

3. Turn the Dynamic Routing Key feature on by entering this command.

```
chg-feat:dynrtk=on
```

NOTE: Once the Dynamic Routing Key feature is turned on with the `chg-feat` command, it cannot be turned off.

The Dynamic Routing Key feature must be purchased before you turn this feature on with the `chg-feat` command. If you are not sure if you have purchased the Dynamic Routing Key feature, contact your Tekelec Sales Representative or Account Representative.

When the `chg-feat` has successfully completed, this message should appear.

```
rlghncxa03w 06-10-28 11:43:04 GMT EAGLE5 36.0.0
CHG-FEAT: MASP A - COMPLTD
```

4. Change the IP options in the database using the **chg-sg-opts** command. For this example, enter this command.

```
chg-sg-opts:srkq=200:drkq=800
```

When this command has successfully completed, the following message should appear.

```
rlghncxa03w 06-10-28 21:18:37 GMT EAGLE5 36.0.0  
CHG-SG-OPTS: MASP A - COMPLTD
```

5. Verify the new IP options in the database by entering the **rtrv-sg-opts** command. The following is an example of the possible output.

```
rlghncxa03w 06-10-28 21:19:37 GMT EAGLE5 36.0.0  
SYNC:          TALI  
SRKQ:          200  
DRKQ:          800  
SNMPCONT:     john doe 555-123-4567  
GETCOMM:      public  
SETCOMM:      private  
TRAPCOMM:     public  
INHFEPALM:    NO  
SCTPCSUM:     crc32c  
IPGWABATE:    NO  
IPLIMABATE:   NO  
IPTPSALMTHRESH: 80
```

6. Back up the new changes using the **chg-db:action=backup:dest=fixed** command. These messages should appear, the active Maintenance and Administration Subsystem Processor (MASP) appears first.

```
BACKUP (FIXED) : MASP A - Backup starts on active MASP.  
BACKUP (FIXED) : MASP A - Backup on active MASP to fixed disk complete.  
BACKUP (FIXED) : MASP A - Backup starts on standby MASP.  
BACKUP (FIXED) : MASP A - Backup on standby MASP to fixed disk complete.
```

Flowchart 3-9. Changing an IP Option That Does Not Require Inhibiting the IP Card

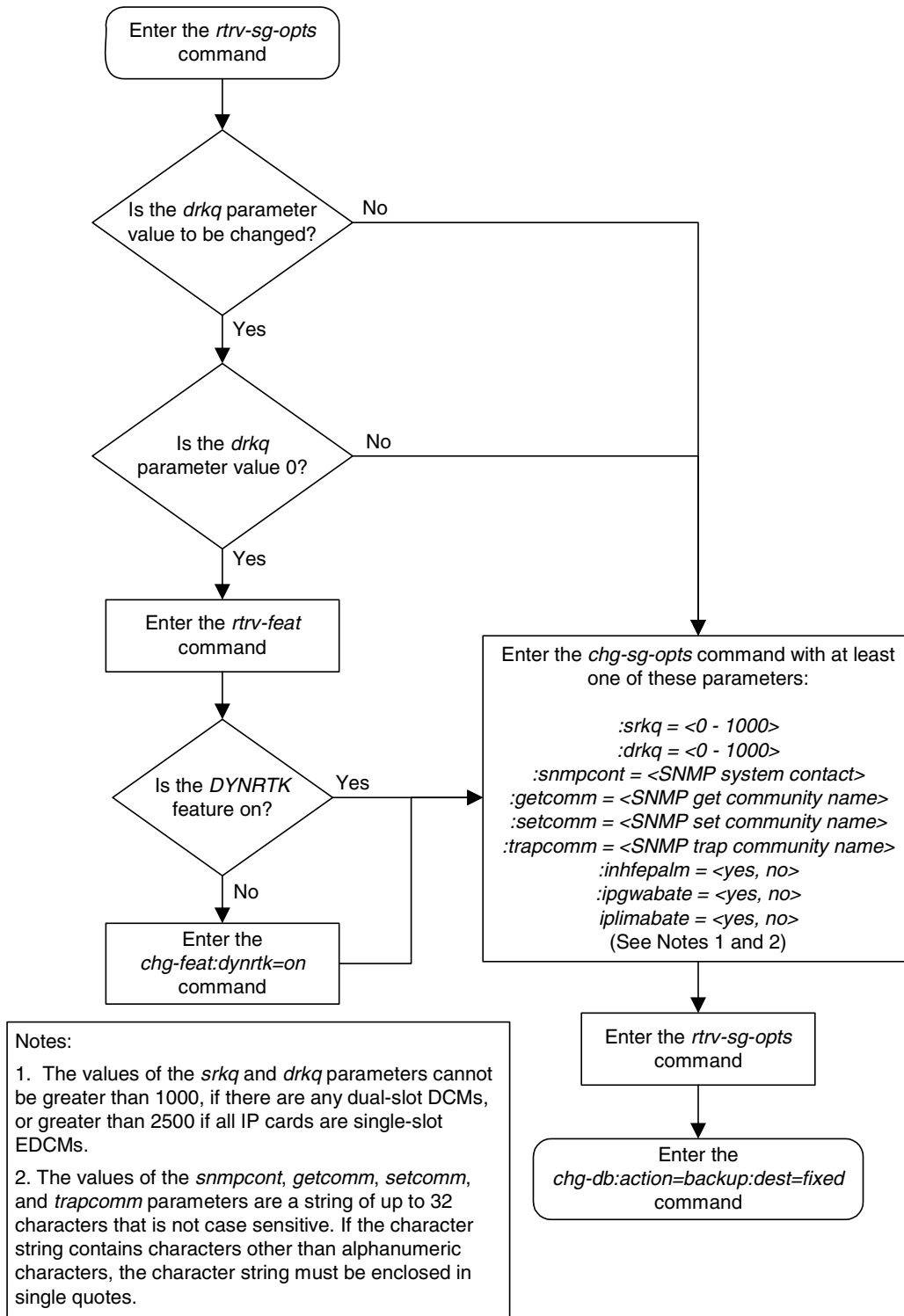

Changing an IP Link

This procedure is used to change the link parameters for IP cards using the **chg-ip-lnk** command. These link parameters are used to configure the Ethernet hardware.

The **chg-ip-lnk** command uses the following parameters.

- :loc** – The card location of the IP card.
- :port** – The Ethernet interface on the IP card, A or B.
- :ipaddr** – IP address assigned to the Ethernet interface on the IP card. This is an IP address expressed in standard “dot notation.” IP addresses consist of the system’s network number and the machine’s unique host number.
- :submask** – The subnet mask of the IP interface. A subnet mask is an IP address with a restricted range of values. The bits in the mask must be a string of one’s followed by a string of zero’s. There must be at least two one’s in the mask, and the mask cannot be all one’s. See Table 3-11 on page 3-136 to assign the correct parameter values.
- :auto** – Tells hardware whether to automatically detect the **duplex** and **speed**.
- :duplex** – This is the mode of operation of the interface.
- :speed** – This is the bandwidth in megabits per second of the interface.
- :mactype** – This is the Media Access Control Type of the interface.
- :mcast** – The multicast control flag. This parameter enables or disables multicast support for the interface.

A zero **ipaddr** parameter value (0.0.0.0) indicates the IP card Ethernet interface to IP link association is disabled. The host to the original IP address must be removed before the **ipaddr=0.0.0.0** can be specified.

If the **defrouter** parameter of the **chg-ip-card** command contains an IP address for the card specified in this procedure, the network portion of one of the IP addresses assigned to the card in this procedure must match the network portion of the IP address specified by the **defrouter** parameter of the **chg-ip-card** command.

The network portion of the IP address is based on the class of the IP address (shown in Table 3-11 on page 3-136). If the IP address is a Class A IP address, the first field is the network portion of the IP address. If the IP address is a Class B IP address, the first two fields are the network portion of the IP address. If the IP address is a Class C IP address, the first three fields are the network portion of the IP address. For example, if the IP address is 193.5.207.150, a Class C IP address, the network portion of the IP address is 193.5.207.

If the **auto=yes** parameter is specified, then the **duplex** and **speed** parameters are not allowed.

The **loc** parameter value must be shown in the **rtrv-ip-card** output.

The IP card must be placed out of service.

If either the **ipaddr** or **submask** parameters are specified, then both parameters must be specified. If the **ipaddr** parameter value is zero (0.0.0.0), the **submask** parameter is not required.

If the IP card is a single-slot EDCM, the A or B interface can be used. The B interface cannot be used with the DCM.

The IP address and subnet mask values cannot be changed to an address representing a different network if:

- If the network interface specified by the **loc** and **port** parameters has a default router, **dnsa**, or **dsnb** parameter values assigned to it, as shown in the **rtrv-ip-card** output.
- Any IP routes, shown in the **rtrv-ip-rte** output, reference the IP address for the network interface specified by the **loc** and **port** parameters.

The IP link cannot be changed if open sockets or associations reference the IP link being changed.

The network portion of the IP addresses assigned to the IP links on an IP card must be unique. For example, if IP links are assigned to IP card 1103, the network portion of the IP address for Ethernet interface A (**port=a**) must be different from the IP address for Ethernet interface B (**port=b**).

The **submask** parameter value is based upon the **ipaddr** setting. See Table 3-11 for the valid input values for the **submask** and **ipaddr** parameter combinations.

Table 3-11. Valid Subnet Mask Parameter Values

| Network Class | IP Network Address Range | Valid Subnet Mask Values |
|---------------|--------------------------|---|
| A | 1.0.0.0 to 127.0.0.0 | 255.0.0.0 (the default value for a class A IP address) 255.192.0.0 255.224.0.0 255.240.0.0 255.248.0.0 255.252.0.0 255.254.0.0 255.255.128.1 |

Table 3-11. Valid Subnet Mask Parameter Values (Continued)

| | | |
|-------|----------------------------|---|
| A+B | 128.0.0.0 to 191.255.0.0 | 255.255.0.0 (the default value for a class B IP address) 255.255.192.0 255.255.224.0 255.255.240.0 255.255.248.0 255.255.252.0 255.255.254.0 255.255.255.128 |
| A+B+C | 192.0.0.0 to 223.255.255.0 | 255.255.255.0 (the default value for a class C IP address) 255.255.255.192 255.255.255.224 255.255.255.240 255.255.255.248 255.255.255.252 |

If a Class B IP address is specified for the `ipaddr` parameter of the `chg-ip-lnk` command, the subnet address that results from the `ipaddr` and `submask` parameter values cannot be the same as the subnet address that results from the `pvn` and `pvnmask` parameter values of the `chg-netopts` command. The `pvn` and `pvnmask` parameter values can be verified by entering the `rtrv-netopts` command. Choose `ipaddr` and `submask` parameter values for the IP link whose resulting subnet address is not be the same as the subnet address resulting from the `pvn` and `pvnmask` parameter values of the `chg-netopts` command.

Canceling the RTRV-APPL-SOCK and RTRV-ASSOC Commands

Because the `rtrv-appl-sock` and `rtrv-assoc` commands used in this procedure can output information for a long period of time, the `rtrv-appl-sock` and `rtrv-assoc` commands can be canceled and the output to the terminal stopped. There are three ways that the `rtrv-appl-sock` and `rtrv-assoc` commands can be canceled.

- Press the **F9** function key on the keyboard at the terminal where the `rtrv-appl-sock` or `rtrv-assoc` commands were entered.
- Enter the `canc-cmd` without the `trm` parameter at the terminal where the `rtrv-appl-sock` or `rtrv-assoc` commands were entered.
- Enter the `canc-cmd:trm=<xx>`, where `<xx>` is the terminal where the `rtrv-appl-sock` or `rtrv-assoc` commands were entered, from another terminal other than the terminal where the `rtrv-appl-sock` or `rtrv-assoc` commands were entered. To enter the `canc-cmd:trm=<xx>` command, the terminal must allow Security Administration commands to be entered from it and the user must be allowed to enter Security Administration commands.

The terminal's permissions can be verified with the `rtrv-secu-trm` command. The user's permissions can be verified with the `rtrv-user` or `rtrv-secu-user` commands.

For more information about the `canc-cmd` command, go to the *Commands Manual*.

Procedure

1. Display the current link parameters associated with the IP card in the database by entering the `rtrv-ip-lnk` command. The following is an example of the possible output.

```
rlghncxa03w 06-10-28 21:14:37 GMT EAGLE5 36.0.0
LOC  PORT  IPADDR          SUBMASK          DUPLEX  SPEED  MACTYPE  AUTO  MCAST
1201  A     192.1.1.1       255.255.255.128  HALF    10     802.3    NO    NO
1203  A     192.1.1.12      255.255.255.0   ----    ---    DIX      YES   NO
1205  A     192.1.1.14      255.255.255.0   FULL    100    DIX      NO    NO
```

NOTE: If the `ipaddr=0.0.0.0` is not being specified in this procedure, skip step 2 and go to step 3.

2. If IP address information is being added or changed (not deleted) in the link parameters, verify that the IP address is present in the IP host table by using the `rtrv-ip-host` command. The following is an example of the possible output.

```
rlghncxa03w 06-10-28 21:15:37 GMT EAGLE5 36.0.0

LOCAL IPADDR    LOCAL HOST
192.1.1.10      IPNODE1-1201
192.1.1.12      IPNODE1-1203
192.1.1.14      IPNODE1-1205
192.1.1.20      IPNODE2-1201
192.1.1.22      IPNODE2-1203
192.1.1.24      IPNODE2-1205
192.1.1.30      KC-HLR1
192.1.1.32      KC-HLR2
192.1.1.50      DN-MS1
192.1.1.52      DN-MS2

REMOTE IPADDR    REMOTE HOST
150.1.1.5        NCDEPTECONOMIC_DEVELOPMENT.SOUTHEASTERN_COORIDOR_ASHVL.GOV

IP Host table is (11 of 512) 2% full
```

If the current IP address of the IP link is shown in the `rtrv-ip-host` output, remove the host assigned to the IP address by performing the "Adding an IP Host" procedure on page 3-153.

- To change IP link parameters, the signaling link to the IP card and the IP card have to be inhibited. Display the signaling link associated with the card shown in step 1 using the `rtrv-slk` command specifying the card location. For this example, enter this command.

```
rtrv-slk:loc=1201
```

This is an example of the possible output.

```
rlghncxa03w 06-10-19 21:17:04 GMT EAGLE5 36.0.0
LOC  LINK LSN          SLC TYPE  IPLIML2
1201 A   nc001          0  IPLIM  SAALTALI
```

- Retrieve the status of the signaling link assigned to the IP card to be changed using the `rept-stat-slk` command. For example, enter this command.

```
rept-stat-slk:loc=1201:link=a
```

The output lists the signaling link assigned to this card:

```
rlghncxa03w 06-10-28 21:16:37 GMT EAGLE5 36.0.0
SLK  LSN          CLLI          PST          SST          AST
1201,A  nc001          ----- IS-NR          Avail          ----
Command Completed.
```

If the signaling link is in service-normal (IS-NR), go to step 5 to deactivate the signaling link. If the signaling link is out-of-service-maintenance disabled (OOS-MT-DSBLD), go to step 7 to verify the IP card status.

- Deactivate the signaling link assigned to the IP card using the `rept-stat-slk` command. For example, enter this command.

```
dact-slk:loc=1201:link=a
```



CAUTION: This command impacts network performance and should only be used during periods of low traffic.

After this command has successfully completed, this message appears.

```
rlghncxa03w 06-10-12 09:12:36 GMT EAGLE5 36.0.0
Deactivate Link message sent to card.
```

- Verify the new link status using the `rept-stat-slk` command. For example, enter this command.

```
rept-stat-slk:loc=1201:link=a
```

The output displays the link status as OOS-MT-DSBLD and gives off a minor alarm:

```
rlghncxa03w 06-10-27 17:00:36 GMT EAGLE5 36.0.0
SLK  LSN          CLLI          PST          SST          AST
1201,A  nc001          ----- OOS-MT-DSBLD AVAIL          ---
ALARM STATUS = * 0236 REPT-LKS:not aligned
UNAVAIL REASON = NA
Command Completed.
```

- Verify the status of the IP card to be inhibited using the `rept-stat-card` command. For example, enter this command.

```
rept-stat-card:loc=1201
```

This is an example of the possible output.

```
rlghncxa03w 06-10-27 17:00:36 GMT EAGLE5 36.0.0
CARD  VERSION      TYPE    APPL    PST          SST      AST
1201  114-000-000    DCM     IPLIM   IS-NR        Active   -----
    ALARM STATUS      = No Alarms.
    BPDCM GPL         = 002-102-000
    IMT BUS A         = Conn
    IMT BUS B         = Conn
    SIGNALING LINK STATUS
      SLK   PST          LS          CLLI
      A     IS-NR        nc001      -----
```

Command Completed.

If the IP card to be inhibited is in service-normal (IS-NR), go to step 8 to inhibit the card. If the IP card is out-of-service-maintenance disabled (OOS-MT-DSBLD), go to step 10 to change the IP link parameters.

- Inhibit the IP card using the `inh-card` command. For example, enter this command.

```
inh-card:loc=1201
```

This message should appear.

```
rlghncxa03w 06-10-28 21:18:37 GMT EAGLE5 36.0.0
Card has been inhibited.
```

- Display the status of the IP card to verify that it is out-of-service maintenance-disabled (OOS-MT-DSBLD). Enter this command.

```
rept-stat-card:loc=1201
```

This is an example of the possible output.

```
rlghncxa03w 06-10-27 17:00:36 GMT EAGLE5 36.0.0
CARD  VERSION      TYPE    APPL    PST          SST      AST
1201  114-000-000    DCM     IPLIM   IS-NR        Active   -----
    ALARM STATUS      = No Alarms.
    BPDCM GPL         = 002-102-000
    IMT BUS A         = Conn
    IMT BUS B         = Conn
    SIGNALING LINK STATUS
      SLK   PST          LS          CLLI
      A     IS-NR        nc001      -----
```

Command Completed.

NOTE: If the `ipaddr` or `submask` parameter values are not being changed, skip steps 10, 11, and 12, and go to step 13.

10. Display the attributes of the IP card assigned to the IP link being changed by entering the `rtrv-ip-card` command and specifying the card location of the IP link. For this example, enter this command.

```
rtrv-ip-card:loc=1201
```

This is an example of the possible output.

```
rlghncxa03w 06-10-28 21:17:37 GMT EAGLE5 36.0.0
  LOC 1201
    SRCHORDR  LOCAL
    DNSA      150.1.1.1
    DNSB      -----
    DEFROUTER -----
    DOMAIN    -----
```

If the `rtrv-ip-card` output shows an IP address for the default router (**DEFROUTER**) whose network portion matches the network portion of the IP address being changed, go to the “Changing an IP Card” procedure on page 3-161 and change the IP address of the default router to `0.0.0.0`.

11. Display any IP routes referencing the IP link being changed by entering the `rtrv-ip-rte` command and specifying the card location of the IP link. For this example, enter this command.

```
rtrv-ip-rte:loc=1201
```

This is an example of the possible output.

```
rlghncxa03w 06-10-28 21:17:37 GMT EAGLE5 36.0.0
LOC  DEST          SUBMASK          GTWY
1201 128.252.10.5    255.255.255.255 140.188.13.33
1201 128.252.0.0      255.255.0.0      140.188.13.34
1201 150.10.1.1       255.255.255.255 140.190.15.3
```

```
IP Route table is (5 of 1024) 1% full
```

If the `rtrv-ip-rte` output shows that the card has IP routes assigned to it, go to the “Removing an IP Route” procedure on page 3-177 and remove the IP routes from the database.

NOTE: If a Class A or C IP address (see Table 3-11 on page 3-136) will be specified for the `ipaddr` parameter in step 15, skip step 12 and go to step 13.

12. The subnet address that results from the `ipaddr` and `submask` parameter values of the `chg-ip-lnk` command cannot be the same as the subnet address that results from the `pvn` and `pvnmask` parameter values of the `chg-netopts` command. Display the `pvn` and `pvnmask` parameter values of the `chg-netopts` command by entering the `rtrv-netopts` command.

If error message **E3967 Cmd Rej: E5IS must be on** is displayed after the `rtrv-netopts` command is executed, the `pvn` and `pvnmask` parameters are not configured. Go to step 13.

This is an example of the possible output if the E5IS feature is on.

```
rlghncxa03w 06-10-28 21:17:37 GMT EAGLE5 36.0.0
NETWORK OPTIONS
-----
PVN      = 128.20.30.40
PVNMASK  = 255.255.192.0
```

Choose `ipaddr` and `submask` parameter values for the IP link whose resulting subnet address is not be the same as the subnet address resulting from the `pvn` and `pvnmask` parameter values of the `chg-netopts` command. Go to step 13.

NOTE: If the local host was removed in step 2, skip steps 13 and 14, and go to step 15.

13. Display the application sockets referencing the local host name that is associated with the IP link being changed by entering the `rtrv-appl-sock` command and specifying the local host name shown in the `rtrv-ip-host` output in step 2. For this example, enter this command.

```
rtrv-appl-sock:lhost="ipnode1-1201"
```

This is an example of the possible output.

```
rlghncxa03w 06-10-28 21:14:37 GMT EAGLE5 36.0.0
SNAME kchlr11201
LINK   A
LHOST  ipnode1-1201
RHOST  kc-hlr1
LPORT  7000          RPORT  7000
SERVER YES          DCMPS  1
REXMIT FIXED       RTT    60
OPEN   YES          ALW    NO
```

```
IP Appl Sock/Assoc table is (3 of 4000) 1% full
```

If no sockets are displayed in this step, go to step 14.

If the `rtrv-appl-sock` output shows that the `open` parameter for any sockets is **yes**, go to the "Changing an Application Socket" procedure on page 3-202 and change the value of the `open` parameter of the sockets to **no**.

14. Display the associations referencing the local host name that is associated with the IP link being changed by entering the **rtrv-assoc** command and specifying the local host name shown in the **rtrv-ip-host** output in step 2. For this example, enter this command.

```
rtrv-assoc:lhost="ipnode-1201"
```

This is an example of the possible output.

```
rlghncxa03w 06-10-28 09:12:36 GMT EAGLE5 36.0.0
                CARD IPLNK
ANAME          LOC  PORT  LINK ADAPTER LPORT RPORT OPEN ALW
swbel32       1201 A    A    M3UA   1030  2345  YES  YES
```

```
IP Appl Sock/Assoc table is (3 of 4000) 1% full
Assoc Buffer Space Used (16 KB of 3200 KB) on LOC = 1201
```

If no associations are displayed in this step, go to step 15.

If the **rtrv-assoc** output shows that the **open** parameter for any associations is **yes**, go to the "Changing an Association" procedure on page 3-348 and change the value of the **open** parameter the associations to **no**.

15. Change the link parameters associated with the IP card in the database using the **chg-ip-lnk** command. For this example, enter this command.

```
chg-ip-lnk:loc=1201:port=a:ipaddr=192.1.1.10
:submask=255.255.255.0:auto=yes:mactype=dix
```

When this command has successfully completed, the following message should appear.

```
rlghncxa03w 06-10-28 21:18:37 GMT EAGLE5 36.0.0
CHG-IP-LNK: MASP A - COMPLTD
```

16. Verify the new link parameters associated with the IP card that was changed in step 15 by entering the **rtrv-ip-lnk** command. The following is an example of the possible output.

```
rlghncxa03w 06-10-28 21:19:37 GMT EAGLE5 36.0.0
LOC  PORT IPADDR          SUBMASK          DUPLEX  SPEED MACTYPE AUTO MCAST
1201 A    192.1.1.10        255.255.255.0   ----   ---   DIX    YES  NO
1203 A    192.1.1.12        255.255.255.0   ----   ---   DIX    YES  NO
1205 A    192.1.1.14        255.255.255.0   FULL   100   DIX    NO   NO
```

NOTE: If step 8 was not performed, skip steps 17 and 18, and go to step 19.

17. Allow the IP card that was inhibited in step 8 by using by using the **alw-card** command. For example, enter this command.

```
alw-card:loc=1201
```

This message should appear.

```
rlghncxa03w 06-10-28 21:20:37 GMT EAGLE5 36.0.0
Card has been allowed.
```

18. Verify the in-service normal (IS-NR) status of the IP card using the **rept-stat-card** command. For example, enter this command.

```
rept-stat-card:loc=1201
```

This is an example of the possible output.

```
rlghncxa03w 06-10-27 17:00:36 GMT EAGLE5 36.0.0
CARD  VERSION      TYPE   APPL   PST      SST      AST
1201  114-000-000    DCM    IPLIM  IS-NR    Active   -----
ALARM STATUS      = No Alarms.
BPDCM GPL         = 002-102-000
IMT BUS A         = Conn
IMT BUS B         = Conn
SIGNALING LINK STATUS
SLK   PST          LS      CLLI
A     IS-NR        nc001   -----
```

Command Completed.

NOTE: If step 5 was not performed, skip steps 19 and 20, and go to step 21.

- 19 Activate the signaling link from step 5 using the **act-slk** command. For example, enter this command.

```
act-slk:loc=1201:link=a
```

The link changes its state from OOS-MT-DSBLD (out-of-service maintenance-disabled) to IS-NR (in-service normal).

The output confirms the activation.

```
rlghncxa03w 06-10-07 11:11:28 GMT EAGLE5 36.0.0
Activate Link message sent to card
```

20. Verify the in-service normal (IS-NR) status of the signaling link using the **rept-stat-slk** command. For example, enter this command.

```
rept-stat-slk:loc=1201:link=a
```

This message should appear.

```
rlghncxa03w 06-10-28 21:16:37 GMT EAGLE5 36.0.0
SLK   LSN      CLLI      PST      SST      AST
1201,A nc001   -----  IS-NR    Avail   -----
Command Completed.
```

NOTE: If the `ipaddr` or `submask` values were not changed, skip steps 21 and 22, and go to step 23.

NOTE: If the IP address of the default router was not changed to 0.0.0.0 in step 10, skip step 21, and go to step 22.

21. Go to the “Changing an IP Card” procedure on page 3-161 and change the IP address of the default router to a non-zero value, where the network portion of the default router IP address matches the network portion of the IP link’s new IP address.

NOTE: If IP routes were not removed in step 11, skip step 22, and go to step 23.

22. Go to the “Adding an IP Route” procedure on page 3-171 and add the IP routes back into the database.

NOTE: If the `open` parameter value for either an application socket or an association was not changed in either steps 13 or 14, skip step 23, and go to step 24.

23. Go to one of these procedures and change the value of the `open` parameter either the application socket or the association to **yes**.
 - For an application socket – “Changing an Application Socket” on page 3-202
 - For an association – “Changing an Association” on page 3-348

-
24. Back up the new changes using the `chg-db:action=backup:dest=fixed` command. These messages should appear, the active Maintenance and Administration Subsystem Processor (MASP) appears first.

```
BACKUP (FIXED) : MASP A - Backup starts on active MASP.  
BACKUP (FIXED) : MASP A - Backup on active MASP to fixed disk complete.  
BACKUP (FIXED) : MASP A - Backup starts on standby MASP.  
BACKUP (FIXED) : MASP A - Backup on standby MASP to fixed disk complete.
```

Flowchart 3-10. Changing an IP Link (Sheet 1 of 7)

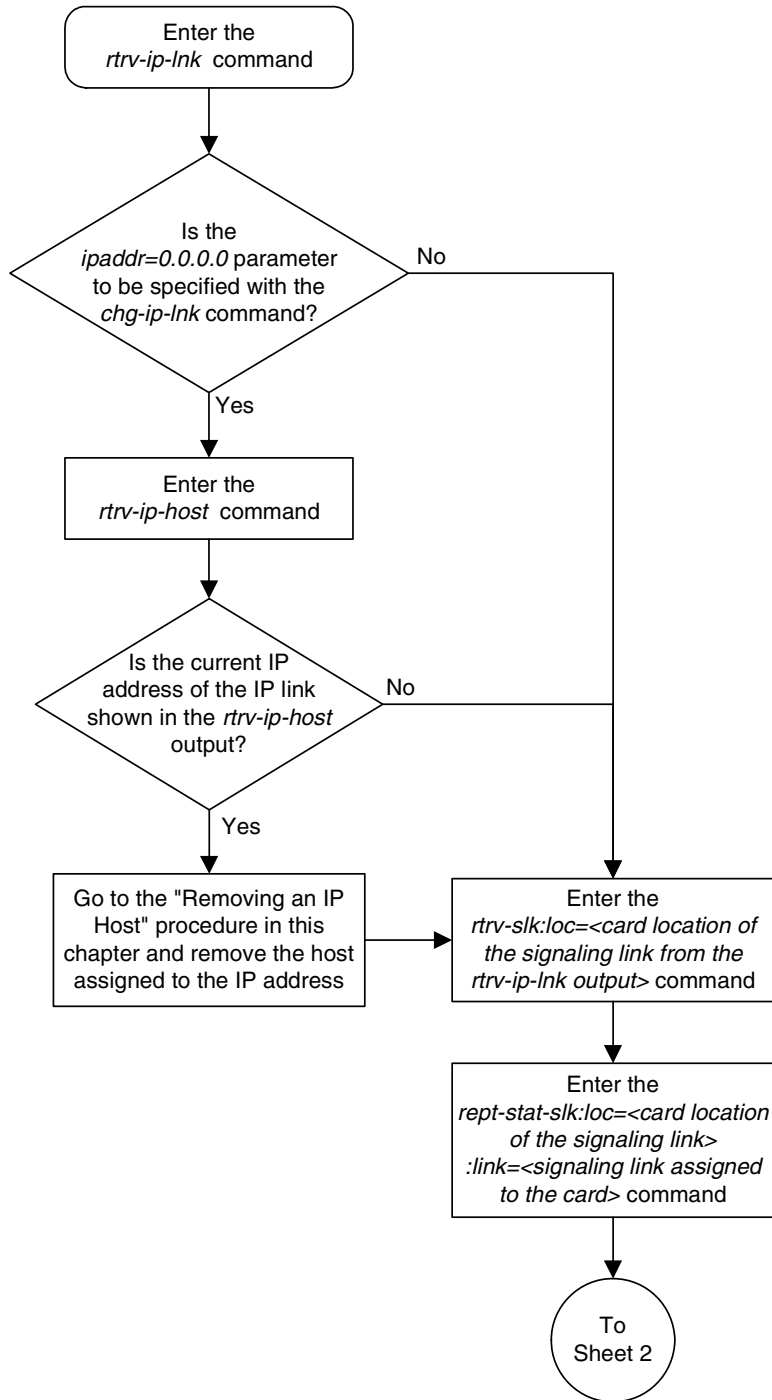

Flowchart 3-10. Changing an IP Link (Sheet 2 of 7)

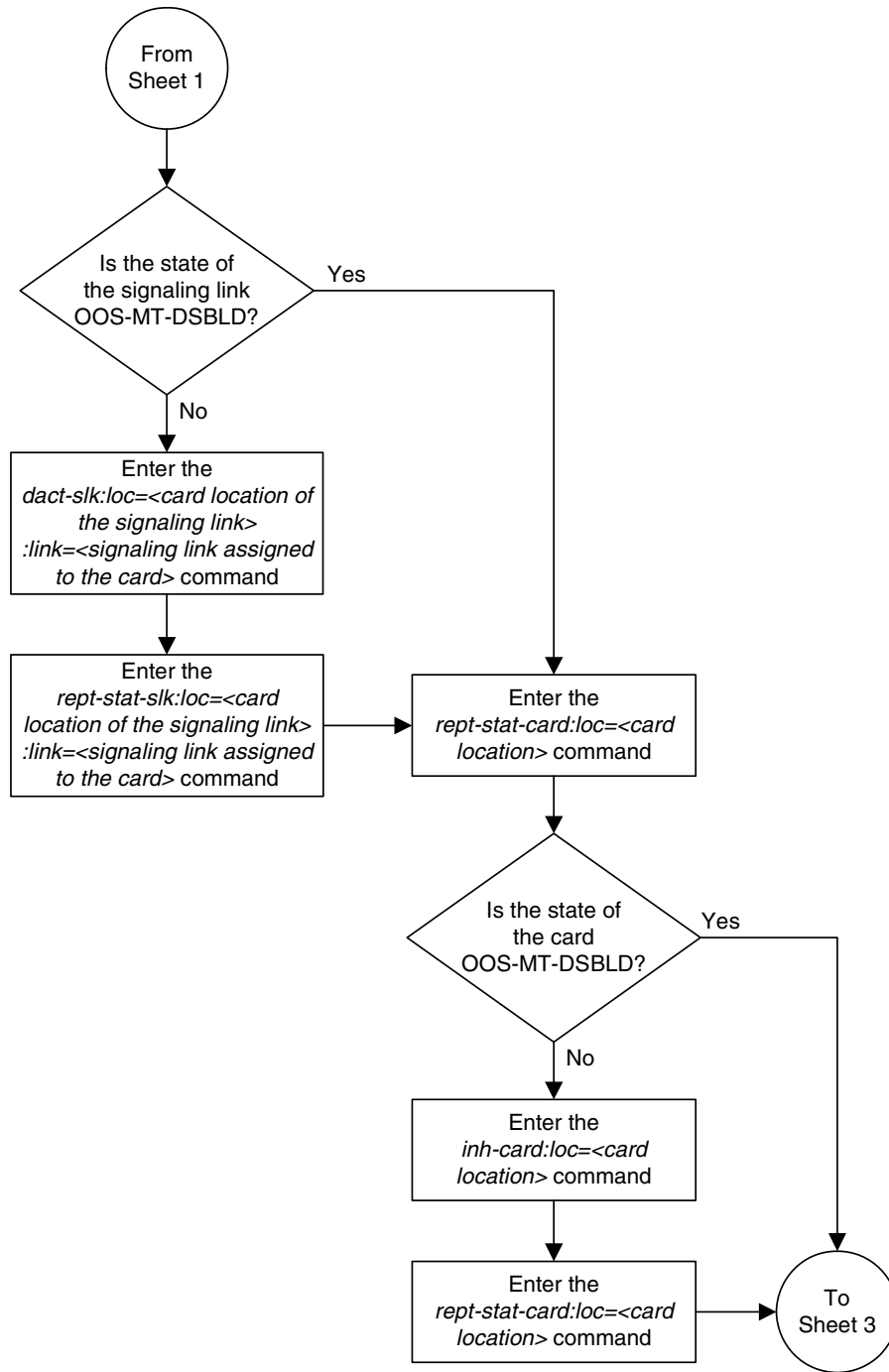

Flowchart 3-10. Changing an IP Link (Sheet 3 of 7)

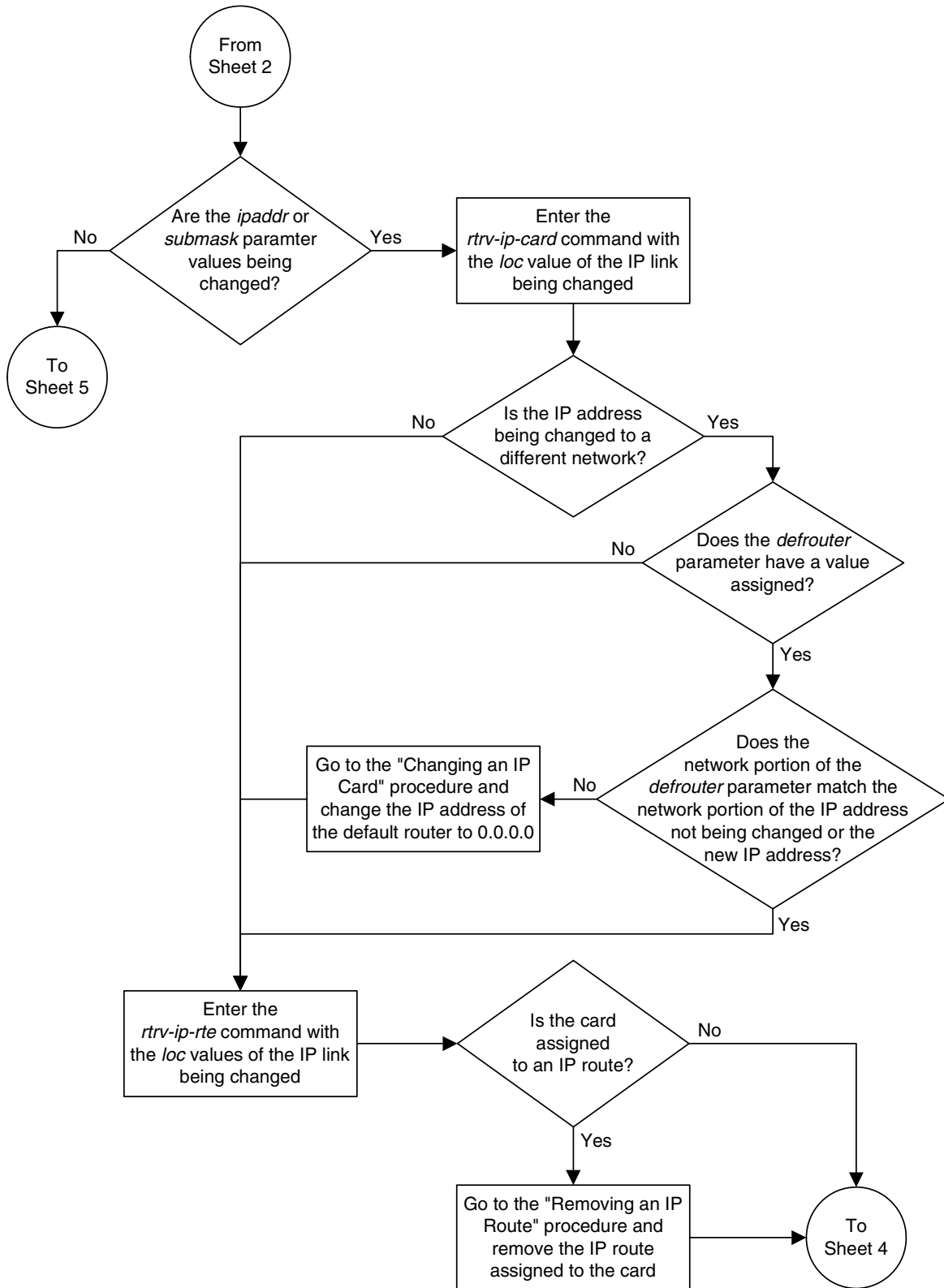

Flowchart 3-10. Changing an IP Link (Sheet 4 of 7)

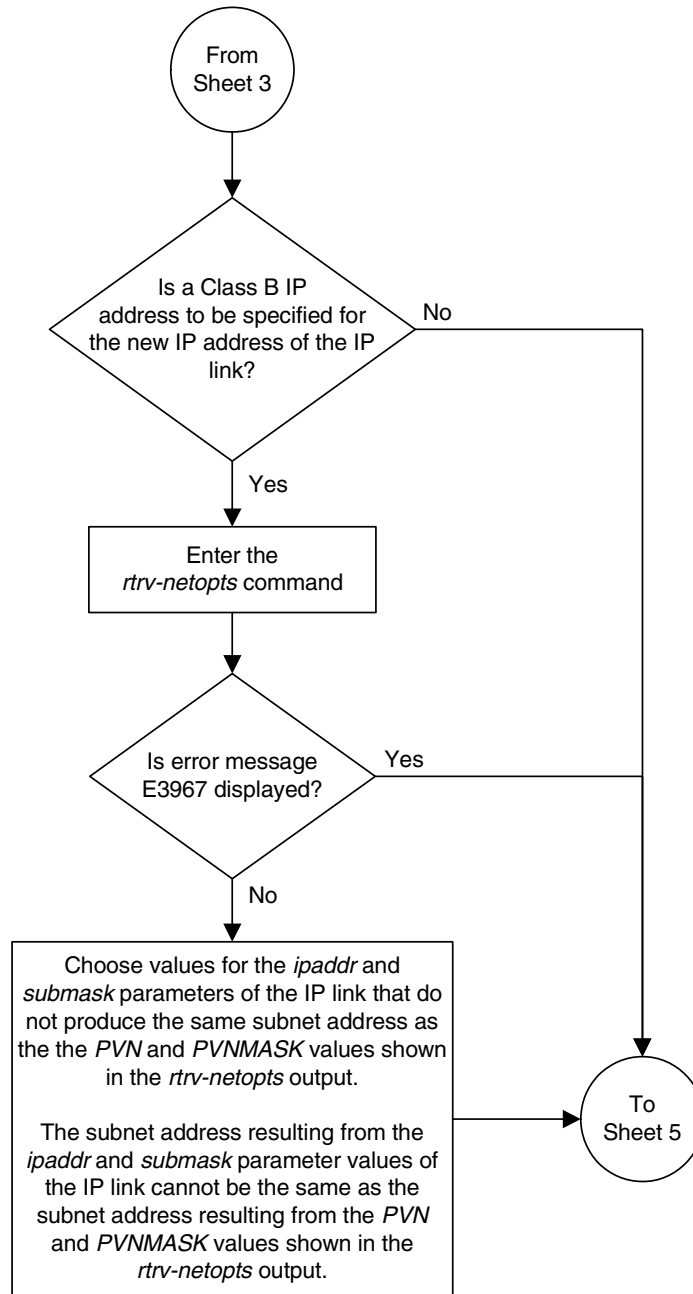

Flowchart 3-10. Changing an IP Link (Sheet 5 of 7)

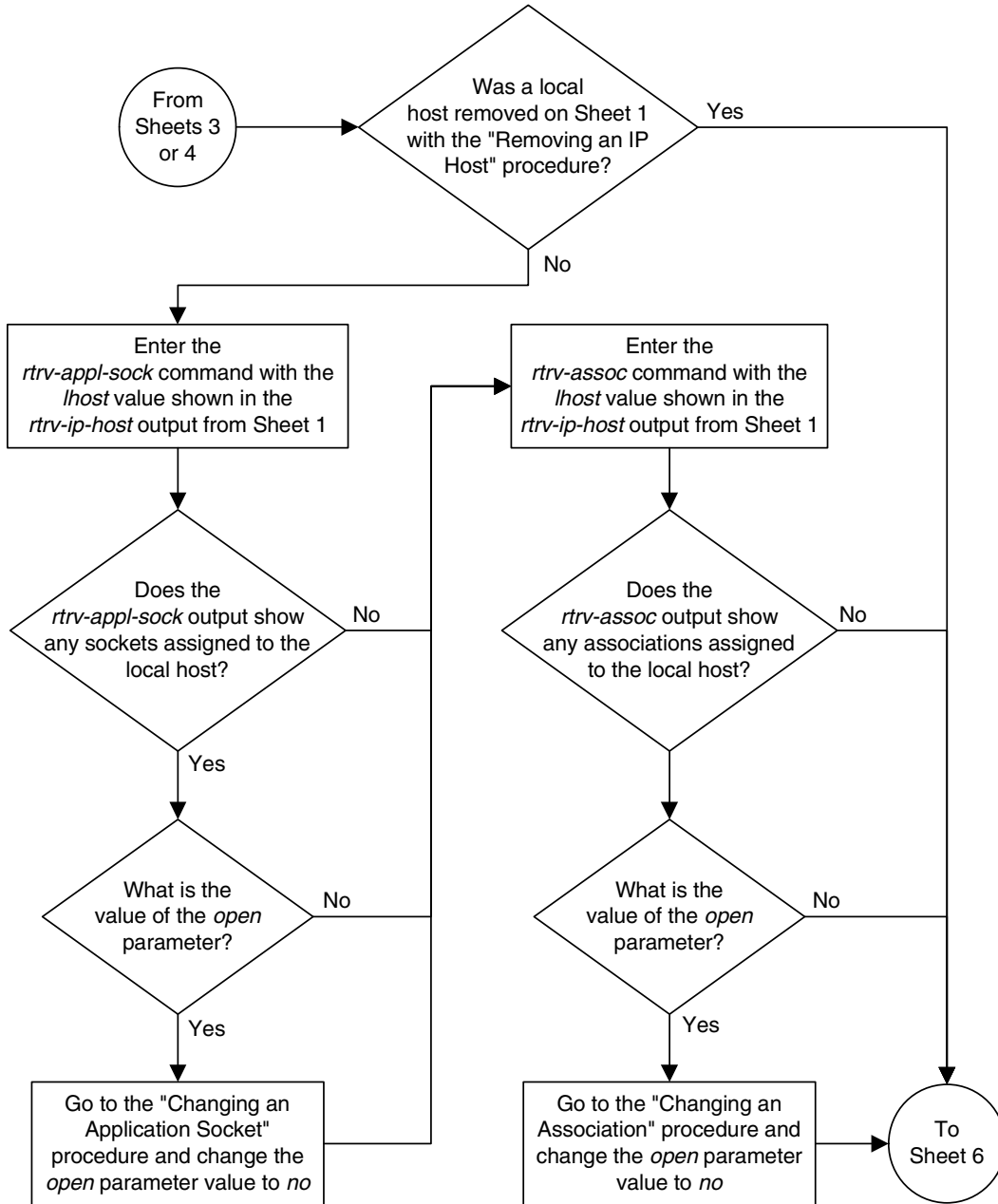

Flowchart 3-10. Changing an IP Link (Sheet 6 of 7)

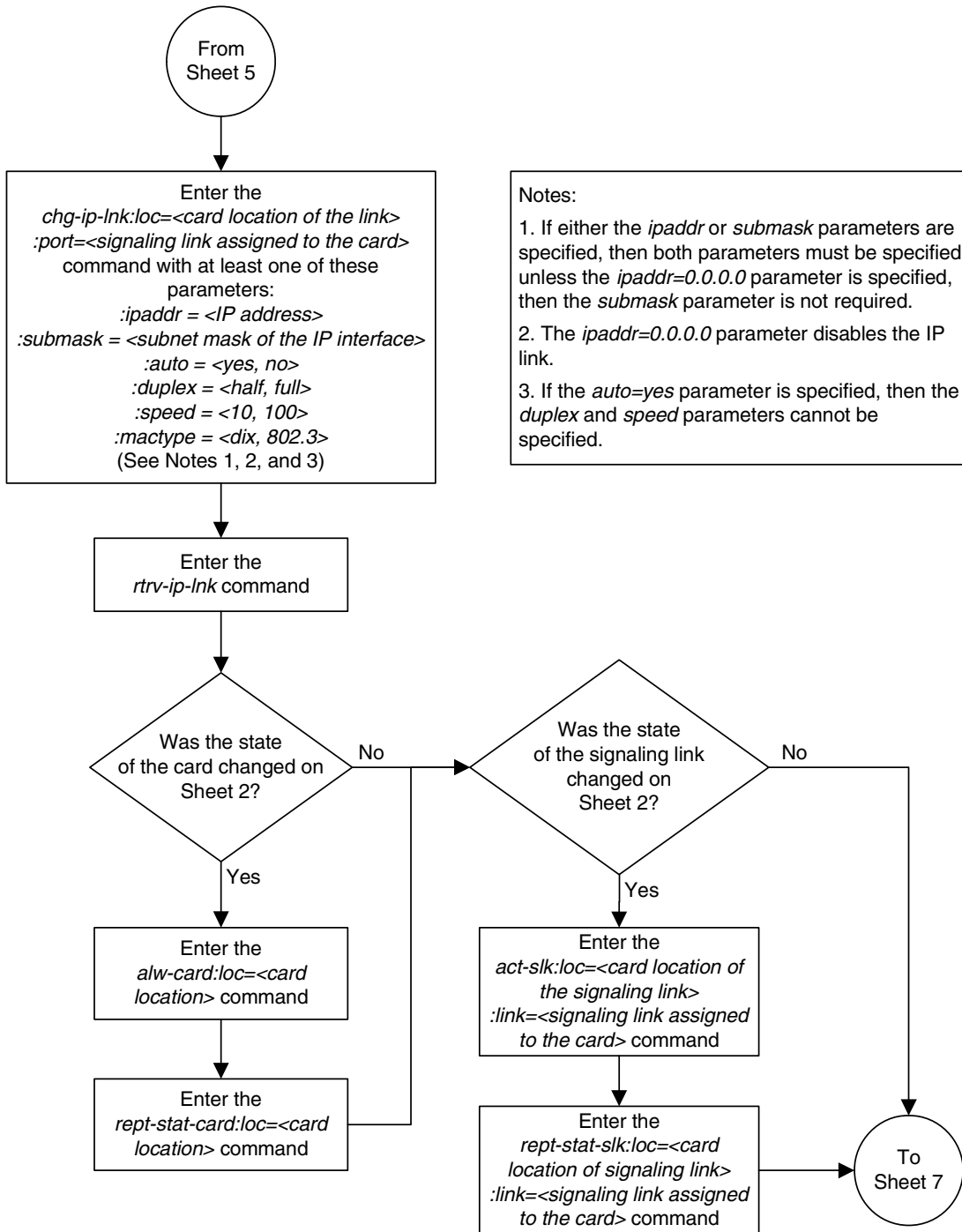

Flowchart 3-10. Changing an IP Link (Sheet 7 of 7)

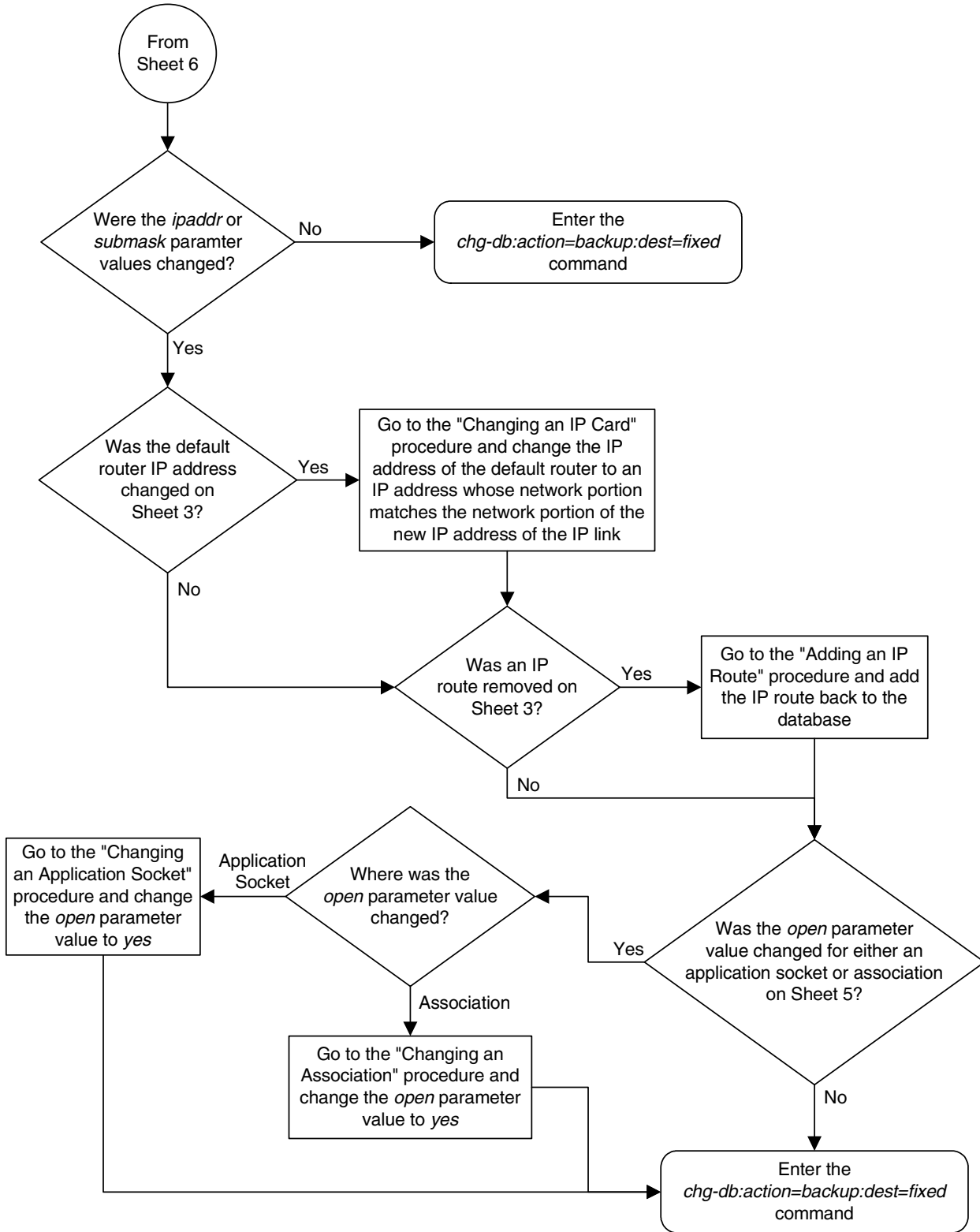

Adding an IP Host

This procedure associates hostnames with IP addresses using the **ent-ip-host** command.

The **ent-ip-host** command uses the following parameters.

:host– The host name to be associated with the IP address. This parameter identifies the logical name assigned to the device with the IP address indicated. The host name can contain up to 60 characters (using only these characters: a-z, A-Z, 0-9, -, .) and is not case sensitive. The host name must begin with a letter. Host names containing a dash (-) must be enclosed in double quotes.

:ipaddr – The IP address to be associated with the hostname. The node's IP address. This is an IP address expressed in standard "dot notation." IP addresses consist of the system's network number and the machine's unique host number.

:type – Specifies if the host resides on the IP card on the EAGLE 5 ISS (**type=local**, the default value), or if the host resides on equipment that is not in the EAGLE 5 ISS (**type=remote**). This parameter is optional.

The IP address for a local host must be shown in the **rtrv-ip-lnk** output.

The IP address for a remote host must not be shown in the **rtrv-ip-lnk** output.

Procedure

1. Display the current IP host information in the database by entering the **rtrv-ip-host** command. The following is an example of the possible output.

```
rlghncxa03w 06-10-28 21:17:37 GMT EAGLE5 36.0.0

LOCAL IPADDR      LOCAL HOST
192.1.1.10        IPNODE1-1201
192.1.1.12        IPNODE1-1203
192.1.1.14        IPNODE1-1205
192.1.1.20        IPNODE2-1201
192.1.1.22        IPNODE2-1203
192.1.1.24        IPNODE2-1205
192.1.1.32        KC-HLR2
192.1.1.50        DN-MS1
192.1.1.52        DN-MS2

REMOTE IPADDR     REMOTE HOST
150.1.1.5         NCDEPTECONOMIC_DEVELOPMENT.SOUTHEASTERN_COORIDOR_ASHVL.GOV

IP Host table is (10 of 512) 2% full
```

2. Verify that the IP address assigned to the IP links by entering the **rtrv-ip-lnk** command. The following is an example of the possible output.

```
rlghncxa03w 06-10-28 21:17:37 GMT EAGLE5 36.0.0
LOC  PORT IPADDR          SUBMASK          DUPLEX  SPEED  MACTYPE AUTO MCAST
1201  A    192.1.1.10         255.255.255.0   ----   ---   DIX     YES  NO
1203  A    192.1.1.12         255.255.255.0   ----   ---   DIX     YES  NO
1205  A    192.1.1.14         255.255.255.0   FULL   100   DIX     NO   NO
```

If a local host is being configured in this procedure, the IP address assigned to the local host must be shown in the `rtrv-ip-lnk` output. If the IP address is not shown in the `rtrv-ip-lnk` output, add the IP address by performing the “Changing an IP Link” on page 3-135.

If a remote host is being configured in this procedure, the IP address assigned to the remote host cannot be shown in the `rtrv-ip-lnk` output.

3. Add IP host information to the database by entering the `ent-ip-host` command. If a local host is being configured, enter the `ent-ip-host` command with the IP address from step 2, and the `type=local` parameter or without the `type` parameter. If the `type` parameter is not specified with the `ent-ip-host` command, the `type` parameter value defaults to `local`.

If a remote host is being configured, enter the `ent-ip-host` command with the IP address that is not shown in step 2, and the `type=remote` parameter.

For example, enter this command.

```
ent-ip-host:host="kc-hlr1":ipaddr=192.1.1.30
```

When this command has successfully completed, the following message should appear.

```
rlghncxa03w 06-10-28 21:18:37 GMT EAGLE5 36.0.0
ENT-IP-HOST: MASP A - COMPLTD
```

4. Verify the new IP host information in the database by entering the `rtrv-ip-host` command with the `host` parameter value specified in step 3. For this example, enter this command.

```
rtrv-ip-host:host="kc-hlr1"
```

The following is an example of the possible output.

```
rlghncxa03w 06-10-28 21:19:37 GMT EAGLE5 36.0.0

LOCAL IPADDR    LOCAL HOST
192.1.1.30      KC-HLR1

IP Host table is (10 of 512) 2% full
```

5. Back up the new changes using the `chg-db:action=backup:dest=fixed` command. These messages should appear, the active Maintenance and Administration Subsystem Processor (MASP) appears first.

```
BACKUP (FIXED) : MASP A - Backup starts on active MASP.
BACKUP (FIXED) : MASP A - Backup on active MASP to fixed disk complete.
BACKUP (FIXED) : MASP A - Backup starts on standby MASP.
BACKUP (FIXED) : MASP A - Backup on standby MASP to fixed disk complete.
```

Flowchart 3-11. Adding an IP Host

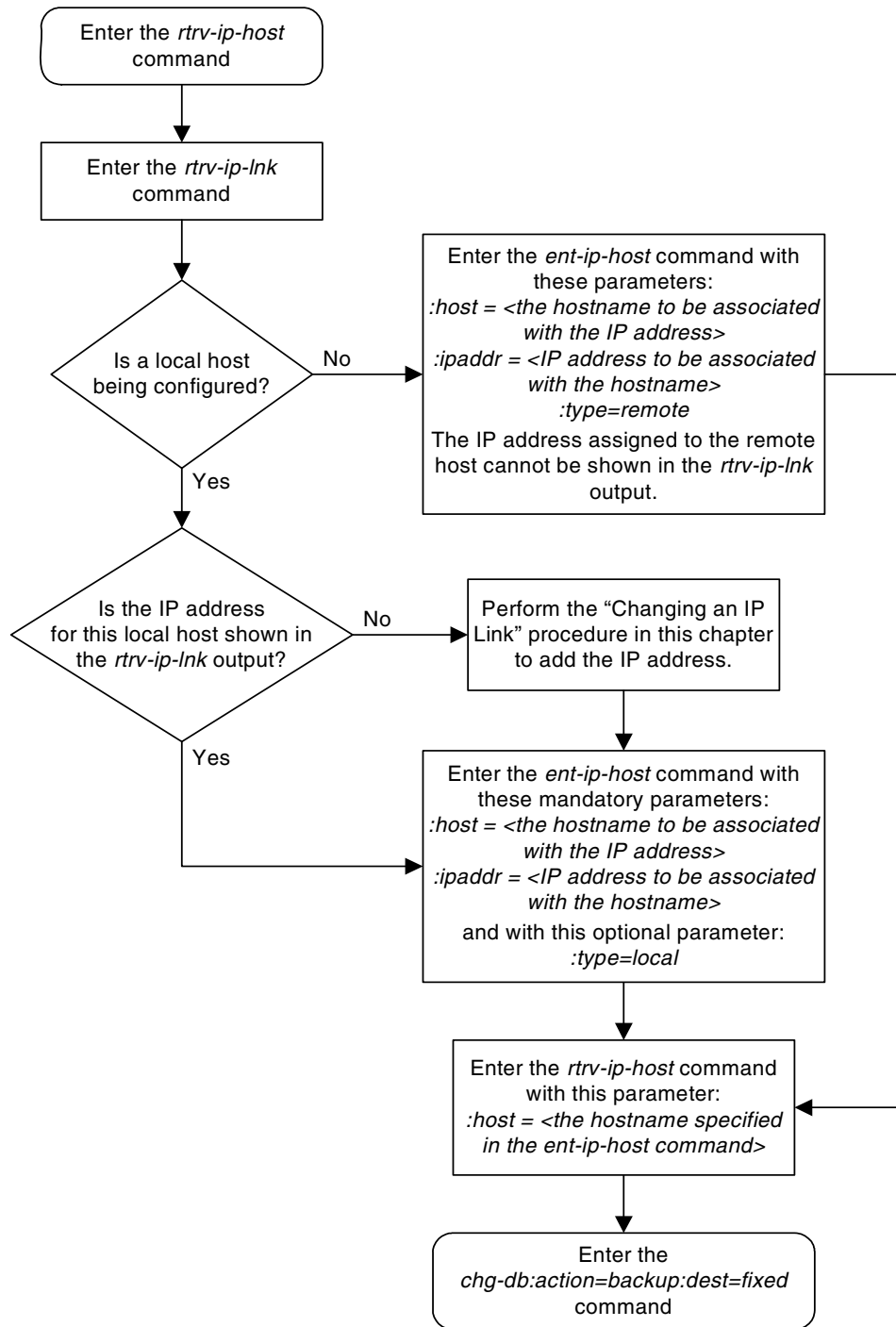

Removing an IP Host

This procedure removes the association between a hostname and an IP address using the `dlt-ip-host` command.

The `dlt-ip-host` command uses the following parameters.

:host– Hostname. The hostname to be removed. This parameter identifies the logical name assigned to a device with an IP address.

No sockets and associations can reference the host name being removed in this procedure. The sockets and associations referencing the host name must be removed by performing the “Removing an Application Socket” procedure on page 3-198 or “Removing an Association” procedure on page 3-344, or the host name in these sockets and associations must be changed by performing the “Changing an Application Socket” procedure on page 3-202 or “Changing an Association” procedure on page 3-348. The host name assigned to sockets and associations is displayed in the `rtrv-appl-sock` or `rtrv-assoc` outputs.

Procedure

1. Display the current IP host information in the database by entering the `rtrv-ip-host` command. The following is an example of the possible output.

```
rlghncxa03w 06-10-28 21:17:37 GMT EAGLE5 36.0.0

LOCAL IPADDR      LOCAL HOST
192.1.1.10        IPNODE1-1201
192.1.1.12        IPNODE1-1203
192.1.1.14        IPNODE1-1205
192.1.1.20        IPNODE2-1201
192.1.1.22        IPNODE2-1203
192.1.1.24        IPNODE2-1205
192.1.1.30        KC-HLR1
192.1.1.32        KC-HLR2
192.1.1.50        DN-MS1
192.1.1.52        DN-MS2
192.3.3.33        GW100.NC.TEKELEC.COM

REMOTE IPADDR     REMOTE HOST
150.1.1.5         NCDEPTECONOMIC_DEVELOPMENT.SOUTHEASTERN_COORIDOR_ASHVL.GOV

IP Host table is (12 of 512) 2% full
```

2. Display the sockets referencing the host name being removed in this procedure by entering the `rtrv-appl-sock` command. For this example, enter this command.

`rtrv-appl-sock:lhost=gw100.nc.tekelec.com`

The following is an example of the possible output.

```
rlghncxa03w 06-10-28 21:14:37 GMT EAGLE5 36.0.0
SNAME KC_HLR1_1103
LINK A
LHOST GW100.NC.TEKELEC.COM
RHOST KC_HLR2
LPORT 7000 RPORT 7001
SERVER YES DCMPS 1
REXMIT FIXED RTT 60
OPEN YES ALW YES
```

IP Appl Sock/Assoc table is (4 of 4000) 1% full

If no sockets referencing the host name being removed in this procedure are shown in this step, go to step 3.

Any sockets referencing the host name must either be removed or the host name assigned to the socket must be changed. To remove the sockets, perform the "Removing an Application Socket" procedure on page 3-198. Go to step 3 after the sockets have been removed.

To change the host name assigned to the sockets, perform the "Changing an Application Socket" procedure on page 3-202. Go to step 3 after the host name assigned to the sockets have been changed.

3. Display the associations referencing the host name being removed in this procedure by entering the `rtrv-assoc` command with the local host name. For this example, enter this command.

`rtrv-assoc:lhost=gw100.nc.tekelec.com`

The following is an example of the possible output.

```
rlghncxa03w 06-10-28 21:14:37 GMT EAGLE5 36.0.0
CARD IPLNK
ANAME LOC PORT LINK ADAPTER LPORT RPORT OPEN ALW
a2 1203 A A M3UA 7205 7001 NO NO
```

IP Appl Sock/Assoc table is (4 of 4000) 1% full

Assoc Buffer Space Used (16 KB of 3200 KB) on LOC = 1203

If no associations referencing the host name being removed in this procedure are shown in this step, go to step 4.

Any associations referencing the host name must either be removed or the host name assigned to the association must be changed. To remove the associations, perform the "Removing an Association" procedure on page 3-344. Go to step 4 after the associations have been removed.

To change the host name assigned to the associations, perform the "Changing an Association" procedure on page 3-348. Go to step 4 after the host name assigned to the associations have been changed.

4. Delete IP host information from the database by entering the `dlt-ip-host` command. For example, enter this command.

```
dlt-ip-host:host=gw100.nc.tekelec.com
```

When this command has successfully completed, the following message should appear.

```
rlghncxa03w 06-10-28 21:19:37 GMT EAGLE5 36.0.0
DLT-IP-HOST: MASP A - COMPLTD
```

5. Verify the changes by entering the `rtrv-ip-host` command with the host name specified in step 4. For this example, enter this command.

```
rtrv-ip-host:host=gw100.nc.tekelec.com
```

The following is an example of the possible output.

```
rlghncxa03w 06-10-28 21:20:37 GMT EAGLE5 36.0.0

LOCAL IPADDR      LOCAL HOST

IP Host table is (10 of 512) 2% full
```

6. Back up the new changes using the `chg-db:action=backup:dest=fixed` command. These messages should appear, the active Maintenance and Administration Subsystem Processor (MASP) appears first.

```
BACKUP (FIXED) : MASP A - Backup starts on active MASP.
BACKUP (FIXED) : MASP A - Backup on active MASP to fixed disk complete.
BACKUP (FIXED) : MASP A - Backup starts on standby MASP.
BACKUP (FIXED) : MASP A - Backup on standby MASP to fixed disk complete.
```

Flowchart 3-12. Removing an IP Host (Sheet 1 of 2)

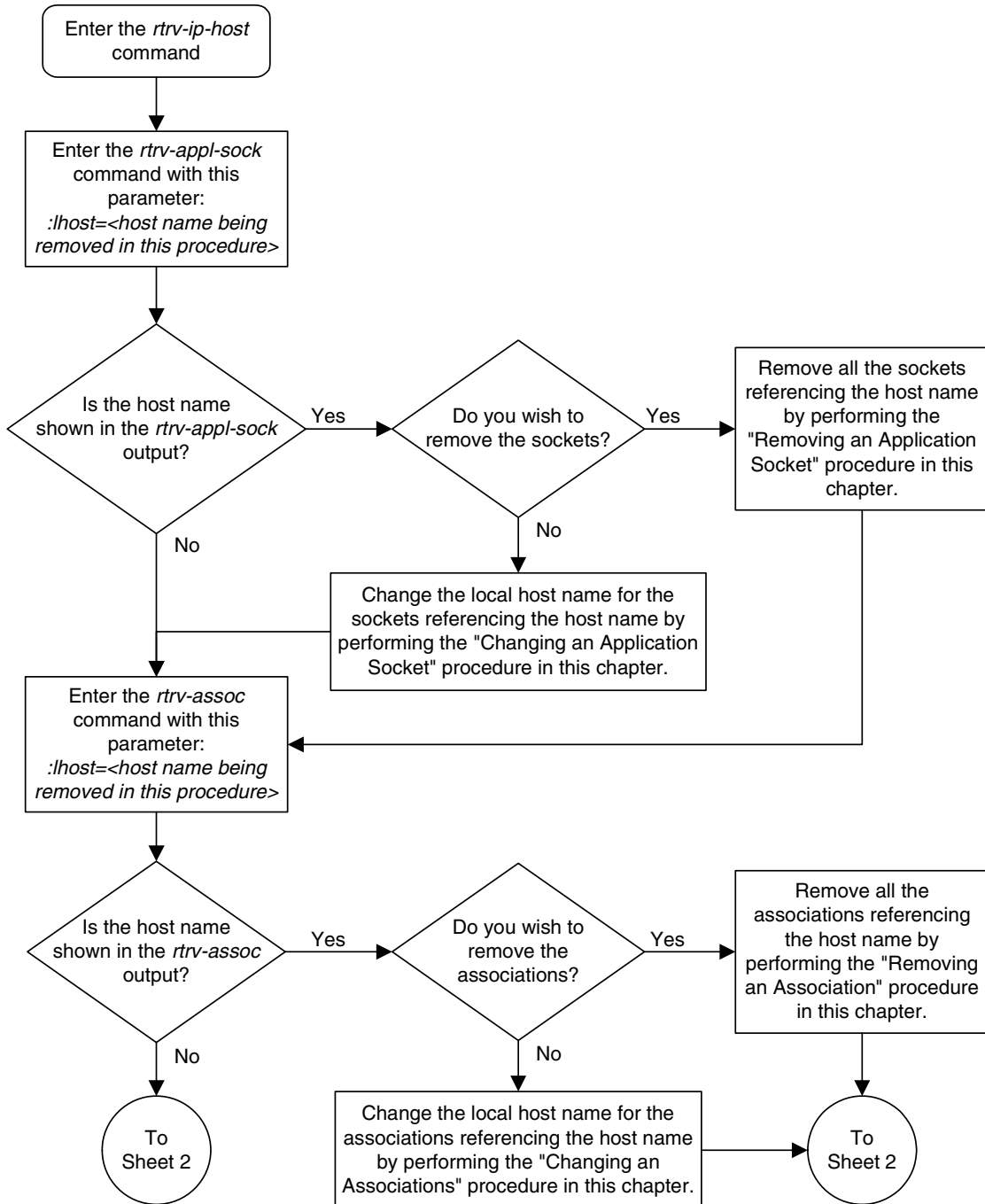

Flowchart 3-12. Removing an IP Host (Sheet 2 of 2)

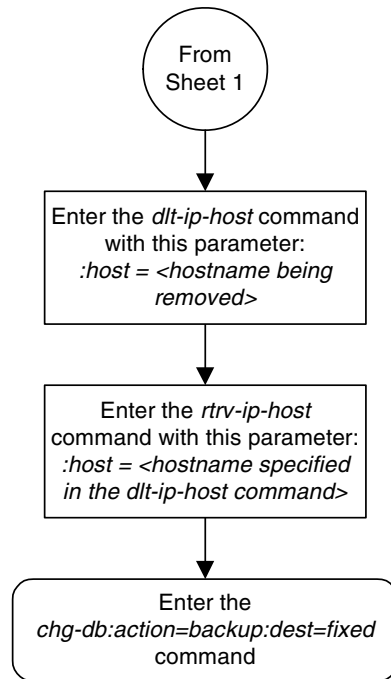

Changing an IP Card

This procedure is used to change the IP stack parameters associated with an IP card in the database using the **chg-ip-card** command.

The **chg-ip-card** command uses the following parameters.

:loc – The card location of the IP card

:srchordr – Host Table Search Order

:dnrsa – Domain name server A's IP address. This is an IP address expressed in standard "dot notation." IP addresses consist of the system's network number and the machine's unique host number.

:dnrsb – Domain name server B's IP address. This is an IP address expressed in standard "dot notation." IP addresses consist of the system's network number and the machine's unique host number.

:domain – The domain name is used to construct a fully-qualified DNS name consisting of 120 characters or less. For example, a domain name can be **tekelec.com**, the hostname is **john.doe**. The fully-qualified DNS name would be **john.doe@tekelec.com**.

:defrouter – Default router IP address. This is an IP address expressed in standard "dot notation." IP addresses consist of the system's network number and the machine's unique host number.

:rstdomain – Reset Domain name. The parameter is used to reset the domain to a NULL value.

The IP card must be placed out of service.

The **rstdomain** parameter cannot be specified if the **domain** parameter is specified.

There is only one default router (**defrouter** parameter) for each IP card. The default router is used as the primary route unless a static IP routes is defined for the destination IP address. Static IP routes are assigned using the **ent-ip-rte** command in the "Adding an IP Route" procedure on page 3-171.

The network portion of the IP address of the default router must match the network portion of one of the IP addresses assigned to the card.

The network portion of the IP address is based on the class of the IP address (shown in Table 3-11 on page 3-136). If the IP address is a Class A IP address, the first field is the network portion of the IP address. If the IP address is a Class B IP address, the first two fields are the network portion of the IP address. If the IP address is a Class C IP address, the first three fields are the network portion of the IP address. For example, if the IP address is 193.5.207.150, a Class C IP address, the network portion of the IP address is 193.5.207.

The default router can be associated with only one IP address assigned to the card if the **defrouter** parameter is specified. For example, the **dnrsa** value for card 1101 is 150.1.1.10. The **dnrsb** value for card 1101 is 160.25.37.1. A default router is provisioned with the IP address 150.1.1.4. The default router is associated with

the Ethernet A IP address (the **dnrsa** parameter value), but not the Ethernet B IP address (the **dnrsb** parameter value).

If the default router is associated with one of the IP card's IP addresses, a second gateway router can be assigned to the other IP address on the IP card by provisioning a static IP route for the IP card using the **ent-ip-rte** command in the "Adding an IP Route" procedure on page 3-171. Static IP routes can provide gateway routers associated with the other IP address on the IP card. To provision the gateway router (the **gtwy** parameter of the **ent-ip-rte** command) for the other IP address assigned to the IP card, the network portion of the gateway router's IP address must match the network portion of the other IP address assigned to the IP card.

Specifying the IP address 0.0.0.0 for the **dnrsa** or **dnrsb** parameters, removes the IP address for Ethernet A (**dnrsa**) or Ethernet B (**dnrsb**).

When an IP card is entered into the database with the **ent-card** command, the IP stack parameters associated with this card are initially set with these default values:

- **:srchordr** – SRVR
- **:dnrsa** – No DNSA IP address is specified
- **:dnrsb** – No DNSB IP address is specified
- **:domain** – No domain name is specified
- **:defrouter** – No default router IP address is specified
- **:rstdomain** – No

The value of any optional parameter not specified with the **chg-ip-card** command is not changed.

The examples in this procedure are based on the sample network shown in Figure 3-3 on page 3-14 and Table 3-3 on page 3-16.

Procedure

1. Display the current IP parameters associated with card in the database by entering the **rtrv-ip-card** command. The following is an example of the possible output.

```
rlghncxa03w 06-10-28 21:17:37 GMT EAGLE5 36.0.0
  LOC 1201
    SRCHORDR  LOCAL
    DNSA      150.1.1.1
    DNSB      -----
    DEFROUTER -----
    DOMAIN    -----

  LOC 1203
    SRCHORDR  LOCAL
    DNSA      192.1.1.40
    DNSB      -----
    DEFROUTER -----
    DOMAIN    NC.TEKELEC.COM
```



```

LOC 1205
  SRCHORDR  SRVROONLY
  DNSA      192.1.1.40
  DNSB      -----
  DEFROUTER -----
  DOMAIN    NC.TEKELEC.COM
    
```

To change the parameters of an IP card, the signaling link to the card and the card have to be inhibited.

2. Display the signaling link associated with the card shown in step 1 using the **rtrv-slk** command specifying the card location. For this example, enter this command.

```
rtrv-slk:loc=1201
```

This is an example of the possible output.

```

rlghncxa03w 06-10-28 21:17:37 GMT EAGLE5 36.0.0
LOC  LINK LSN          SLC TYPE  IPLIML2
1201 A   nc001         0  IPLIM  SAALTALI
    
```

3. Retrieve the status of the signaling link shown in step 2 using the **rept-stat-slk** command specifying the card location and signaling link. For example, enter this command.

```
rept-stat-slk:loc=1201:link=a
```

The output lists the signaling link assigned to this card:

```

rlghncxa03w 06-10-28 21:16:37 GMT EAGLE5 36.0.0
SLK   LSN          CLLI          PST          SST          AST
1201,A nc001         -----  IS-NR          Avail          ----
Command Completed.
    
```

If the signaling link is in service-normal (IS-NR), go to step 4 to deactivate the signaling link. If the signaling link is out-of-service-maintenance disabled (OOS-MT-DSBLD), skip steps 4 and 5, and go to step 6 to verify the card status.

4. Deactivate the signaling link assigned to the IP card using the **rept-stat-slk** command. For example, enter this command.

```
dact-slk:loc=1201:link=a
```



CAUTION: This command impacts network performance and should only be used during periods of low traffic.

After this command has successfully completed, this message appears.

```

rlghncxa03w 06-10-12 09:12:36 GMT EAGLE5 36.0.0
Deactivate Link message sent to card.
    
```

- Verify the new link status using the **rept-stat-slk** command. For example, enter this command.

```
rept-stat-slk:loc=1201:link=a
```

The output displays the link status as OOS-MT-DSBLD and gives off a minor alarm:

```
rlghncxa03w 06-10-27 17:00:36 GMT EAGLE5 36.0.0
SLK      LSN      CLLI      PST      SST      AST
1201,A   nc001      ----- OOS-MT-DSBLD AVAIL   ---
ALARM STATUS = * 0236 REPT-LKS:not aligned
UNAVAIL REASON = NA
Command Completed.
```

- Verify the status of the IP card to be inhibited using the **rept-stat-card** command. For example, enter this command.

```
rept-stat-card:loc=1201
```

This is an example of the possible output.

```
rlghncxa03w 06-10-27 17:00:36 GMT EAGLE5 36.0.0
CARD  VERSION  TYPE  APPL  PST      SST      AST
1201  114-000-000 DCM   IPLIM IS-NR    Active   -----
ALARM STATUS      = No Alarms.
BPDCM GPL         = 002-102-000
IMT BUS A         = Conn
IMT BUS B         = Conn
SIGNALING LINK STATUS
SLK   PST      LS      CLLI
A     IS-NR   nc001   -----
```

Command Completed.

If the IP card to be inhibited is in service-normal (IS-NR), go to step 7 to inhibit the card. If the IP card is out-of-service-maintenance disabled (OOS-MT-DSBLD), skip steps 7 and 8, and go to step 9.

- Inhibit the IP card using the **inh-card** command. For example, enter this command.

```
inh-card:loc=1201
```

This message should appear.

```
rlghncxa03w 06-10-28 21:18:37 GMT EAGLE5 36.0.0
Card has been inhibited.
```

8. Display the status of the IP card to verify that it is out-of-service maintenance-disabled (OOS-MT-DSBLD). Enter this command.

```
rept-stat-card:loc=1201
```

This is an example of the possible output.

```
rlghncxa03w 06-10-27 17:00:36 GMT EAGLE5 36.0.0
CARD  VERSION      TYPE      APPL      PST          SST          AST
1201  114-000-000    DCM       IPLIM     IS-NR        Active       -----
ALARM STATUS      = No Alarms.
BPDCM GPL         = 002-102-000
IMT BUS A         = Conn
IMT BUS B         = Conn
SIGNALING LINK STATUS
SLK   PST          LS          CLLI
A     IS-NR        nc001      -----
```

Command Completed.

NOTE: If the **defrouter** parameter is not specified in step 10, skip this step and go to step 10.

9. Verify that the IP address of either Ethernet A or B (the address whose network portion matches the network portion of the **defrouter** parameter value to be used in step 10) is in the IP link table by entering the **rtrv-ip-lnk** command with the card location specified in this procedure. For this example, enter this command.

```
rtrv-ip-lnk:loc=1201
```

The following is an example of the possible output.

```
rlghncxa03w 06-10-28 21:17:37 GMT EAGLE5 36.0.0
LOC  PORT IPADDR      SUBMASK      DUPLEX  SPEED  MACTYPE  AUTO  MCAST
1201  A    192.1.1.10    255.255.255.0  ----   ---    DIX      YES  NO
1201  B    -----      -----      ----   ---    DIX      YES  NO
```

If the network portion of the IP address specified by the **defrouter** value does not match the network portions of either IP address displayed in this step, perform one of these actions:

- Choose another value for the **defrouter** parameter, making sure that the network portion of the new IP address matches the network portion of one of the IP addresses displayed in this step.
- Perform the “Changing an IP Link” procedure on page 3-135 and change one of the IP addresses shown in this step so that the network portion of the new IP address changed in the “Changing an IP Link” procedure matches the network portion of the IP address value for the **defrouter** parameter.

10. Change the IP stack parameters associated with an IP card in the database using the **chg-ip-card** command. For this example, enter this command.

```
chg-ip-card:loc=1201:srchordr=local:dnsa=192.1.1.40
:domain=nc.tekelec.com
```

When this command has successfully completed, the following message should appear.

```
rlghncxa03w 06-10-28 21:20:37 GMT EAGLE5 36.0.0
CHG-IP-CARD: MASP A - COMPLTD
```

11. Verify the new IP parameters associated with the IP card that was changed in step 10 by entering the **rtrv-ip-card** command.

The following is an example of the possible output.

```
rlghncxa03w 06-10-28 21:21:37 GMT EAGLE5 36.0.0
LOC 1201
  SRCHORDR  LOCAL
  DNSA      192.1.1.40
  DNSB      -----
  DEFROUTER -----
  DOMAIN    NC.TEKELEC.COM

LOC 1203
  SRCHORDR  LOCAL
  DNSA      192.1.1.40
  DNSB      -----
  DEFROUTER -----
  DOMAIN    NC.TEKELEC.COM

LOC 1205
  SRCHORDR  SRVROONLY
  DNSA      192.1.1.40
  DNSB      -----
  DEFROUTER -----
  DOMAIN    NC.TEKELEC.COM
```

NOTE: If step 7 was not performed, skip steps 12 and 13, and go to step 14.

12. Allow the IP card that was inhibited in step 7 by using the **alw-card** command. For example, enter this command.

```
alw-card:loc=1201
```

This message should appear.

```
rlghncxa03w 06-10-28 21:22:37 GMT EAGLE5 36.0.0
Card has been allowed.
```

13. Verify the in-service normal (IS-NR) status of the IP card using the **rept-stat-card** command. For example, enter this command.

```
rept-stat-card:loc=1201
```

This is an example of the possible output.

```
rlghncxa03w 06-10-27 17:00:36 GMT EAGLE5 36.0.0
CARD  VERSION      TYPE      APPL      PST          SST          AST
1201  114-000-000    DCM       IPLIM     IS-NR        Active       -----
ALARM STATUS      = No Alarms.
BPDCM GPL         = 002-102-000
IMT BUS A         = Conn
IMT BUS B         = Conn
SIGNALING LINK STATUS
SLK   PST          LS          CLLI
A     IS-NR        nc001      -----
```

Command Completed.

NOTE: If step 4 was not performed, skip steps 14 and 15, and go to step 16.

- 14 Activate the signaling link from step 4 using the **act-slk** command. For example, enter this command.

```
act-slk:loc=1201:link=a
```

The link changes its state from OOS-MT-DSBLD (out-of-service maintenance-disabled) to IS-NR (in-service normal).

The output confirms the activation.

```
rlghncxa03w 06-10-07 11:11:28 GMT EAGLE5 36.0.0
Activate Link message sent to card
```

15. Verify the in-service normal (IS-NR) status of the signaling link using the **rept-stat-slk** command. For example, enter this command.

```
rept-stat-slk:loc=1201:link=a
```

This message should appear.

```
rlghncxa03w 06-10-28 21:16:37 GMT EAGLE5 36.0.0
SLK   LSN          CLLI          PST          SST          AST
1201,A  nc001      ----- IS-NR        Avail       ----
Command Completed.
```

16. Back up the new changes using the **chg-db:action=backup:dest=fixed** command. These messages should appear, the active Maintenance and Administration Subsystem Processor (MASP) appears first.

```
BACKUP (FIXED) : MASP A - Backup starts on active MASP.
BACKUP (FIXED) : MASP A - Backup on active MASP to fixed disk complete.
BACKUP (FIXED) : MASP A - Backup starts on standby MASP.
BACKUP (FIXED) : MASP A - Backup on standby MASP to fixed disk complete.
```

Flowchart 3-13. Changing an IP Card (Sheet 1 of 3)

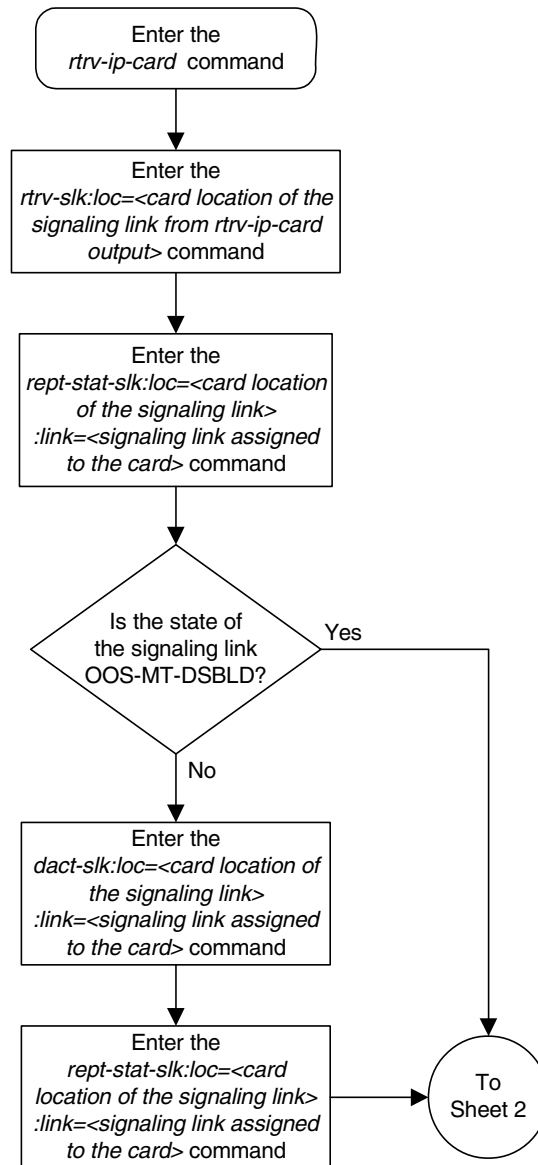

Flowchart 3-13. Changing an IP Card (Sheet 2 of 3)

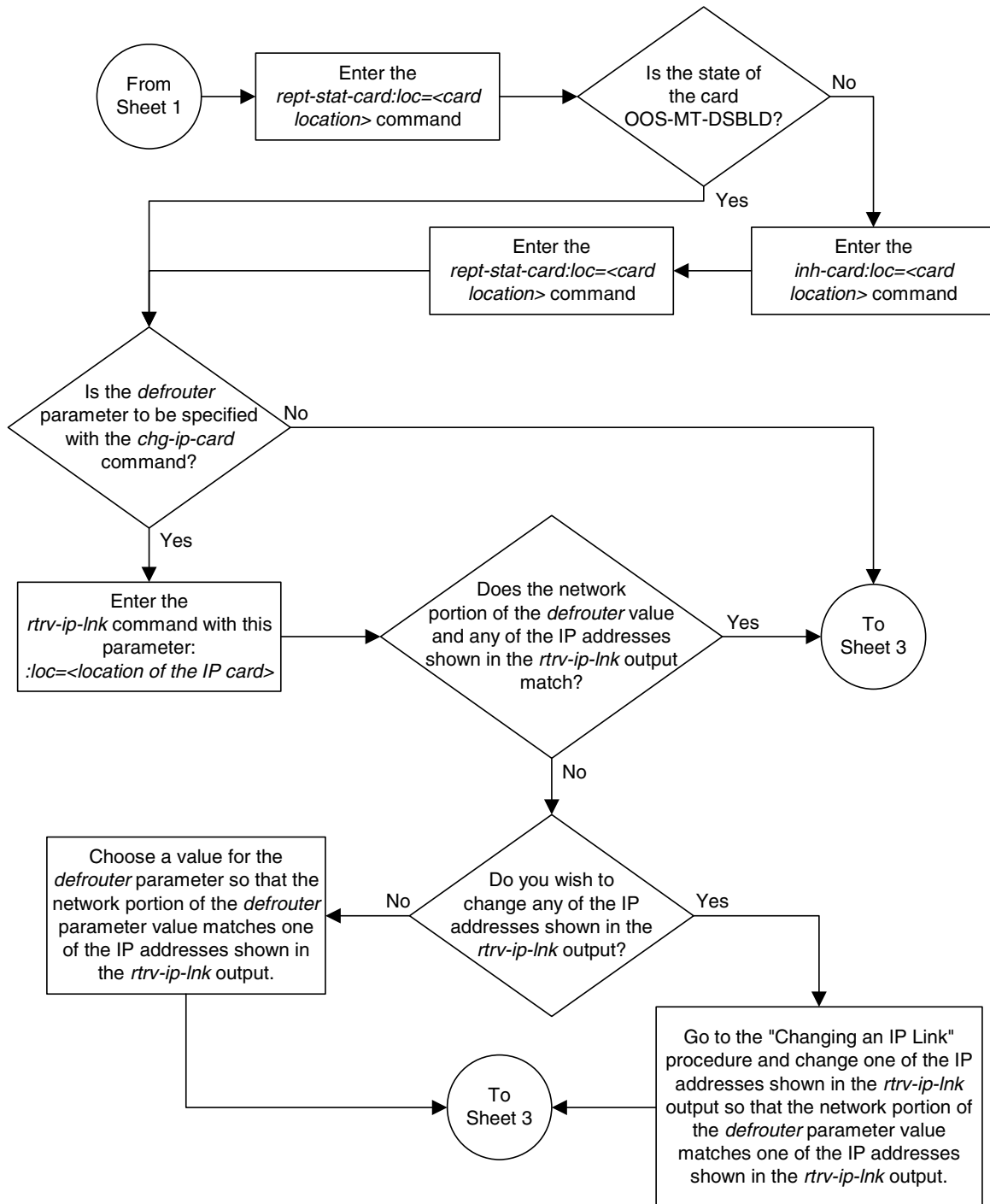

Flowchart 3-13. Changing an IP Card (Sheet 3 of 3)

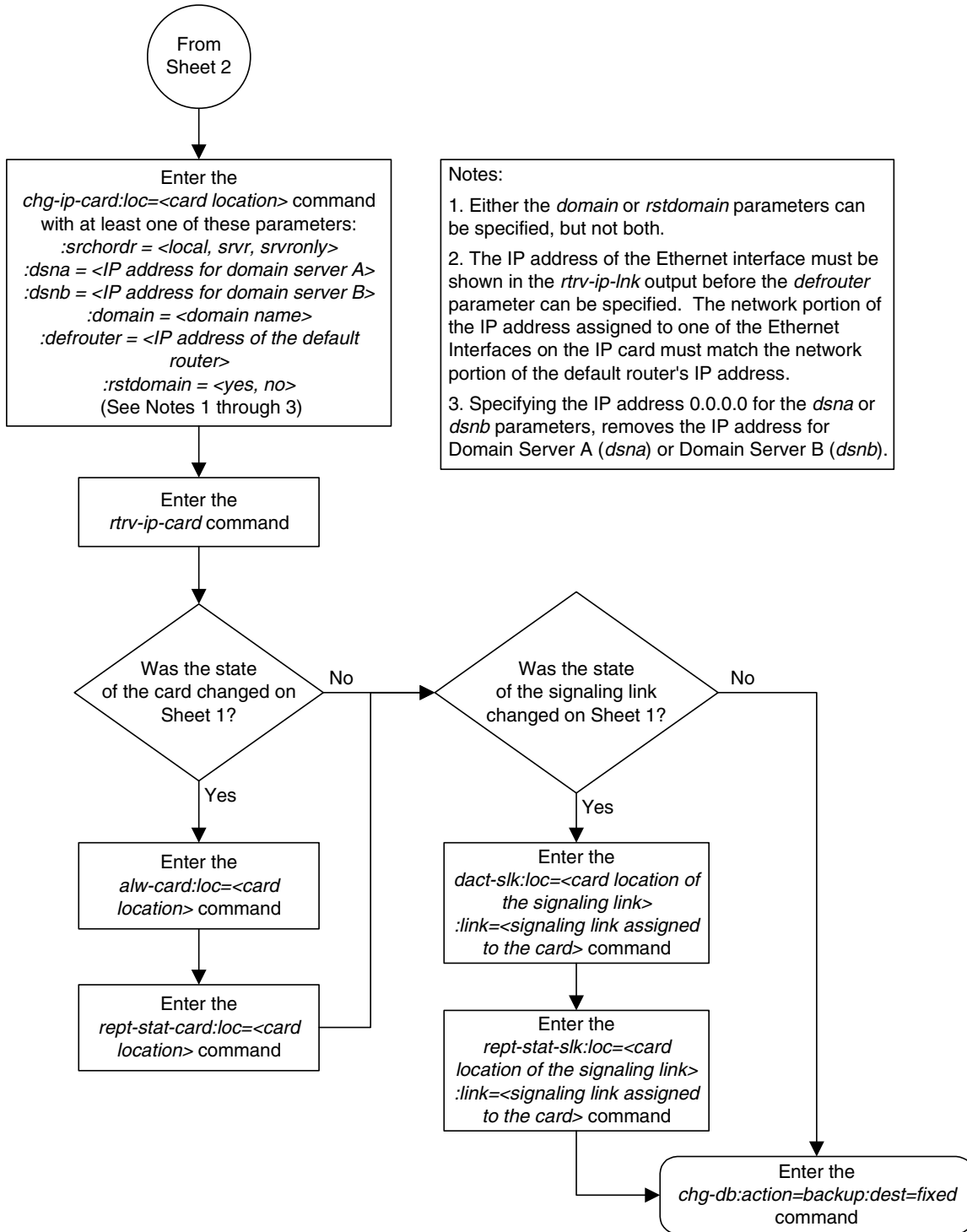

Adding an IP Route

This procedure is used to add an IP route to the database using the `ent-ip-rte` command.

The `ent-ip-rte` command uses these parameters.

- `:loc` – The location of the IP card that the IP route will be assigned to.
- `:dest` – The IP address of the remote host or network.
- `:submask` – The subnet mask of the destination IP address.
- `:gtwy` – The IP address of the gateway or router that will send the IP data to its final destination.

There can be a maximum of 64 IP routes assigned to an IP card.

The EAGLE 5 ISS can contain a maximum of 1024 IP routes.

If the IP card specified by the `loc` parameter is a single-slot EDCM, the card may contain IP addresses for Ethernet A and B. If the IP card specified by the `loc` parameter is a DCM, the card can contain an IP address for Ethernet A only.

The network portion of the IP address value of the `gtwy` parameter must be the same as the network portion of the IP addresses shown for either the A or B interfaces in the `rtrv-ip-card` output.

The value of the `dest` and `gtwy` parameters cannot be 127.x.x.x (the loopback address), 0.0.0.0, or the IP addresses of the A or B interfaces on the IP card, and cannot be assigned to another IP card.

If the `dest` parameter value represents a host IP address, the value for the `submask` parameter must be 255.255.255.255. Otherwise, the `submask` parameter value identifies the network/host ID portions that must be entered when the `dest` parameter value represents a network address.

The submask is applied to the IP address which is being routed to see if it yields a route match. For example, if IP address 192.1.1.2 is being routed and the IP routing table contains these entries.

| IP address | Submask | Gateway |
|------------|-------------|-----------------|
| 191.1.0.0 | 255.255.0.0 | 192.168.110.250 |
| 192.0.0.0 | 255.0.0.0 | 192.168.110.251 |

IP routing occurs as follows:

1. The subnet mask of route 1 (255.255.0.0) is applied to the IP address being routed (192.1.1.2) with the resulting IP address of 192.1.0.0. IP address 192.1.0.0 does not match IP address 191.1.0.0 in the IP routing table, so the next route is chosen.
2. The subnet mask of route 2 (255.0.0.0) is applied to the IP address being routed (192.1.1.2) with the resulting IP address of 192.0.0.0 which matches the second route in the IP routing table, so this route is selected for routing this datagram.

See Table 3-12 for the valid input values for the **submask** and **dest** parameter combinations.

Table 3-12. Valid Subnet Mask Parameter Values

| Network Class | IP Network Address Range | Valid Subnet Mask Values |
|---------------|----------------------------|---|
| A | 1.0.0.0 to 127.0.0.0 | 255.0.0.0 (the default value for a class A IP address) 255.192.0.0 255.224.0.0 255.240.0.0 255.248.0.0 255.252.0.0 255.254.0.0 255.255.128.1 |
| A+B | 128.1.0.0 to 191.255.0.0 | 255.255.0.0 (the default value for a class B IP address) 255.255.192.0 255.255.224.0 255.255.240.0 255.255.248.0 255.255.252.0 255.255.254.0 255.255.255.128 |
| A+B+C | 192.0.0.0 to 223.255.255.0 | 255.255.255.0 (the default value for a class C IP address) 255.255.255.192 255.255.255.224 255.255.255.240 255.255.255.248 255.255.255.252 |

If a Class B IP address is specified for the **dest** parameter of the **ent-ip-rte** command, the subnet address that results from the **dest** and **submask** parameter values cannot be the same as the subnet address that results from the **pvn** and **pvnmask** parameter values of the **chg-netopts** command. The **pvn** and **pvnmask** parameter values can be verified by entering the **rtrv-netopts** command. Choose **dest** and **submask** parameter values for the IP route whose resulting subnet address is not be the same as the subnet address resulting from the **pvn** and **pvnmask** parameter values of the **chg-netopts** command.

Procedure

1. Display the IP routes in the database with the `rtrv-ip-rte` command. This is an example of the possible output.

```
rlghncxa03w 06-10-28 09:12:36 GMT EAGLE5 36.0.0
LOC  DEST          SUBMASK          GTWY
1301 128.252.10.5    255.255.255.255 140.188.13.33
1301 128.252.0.0     255.255.0.0     140.188.13.34
1301 150.10.1.1      255.255.255.255 140.190.15.3
1303 192.168.10.1    255.255.255.255 150.190.15.23
1303 192.168.0.0     255.255.255.0   150.190.15.24
```

```
IP Route table is (5 of 1024) 1% full
```

2. Display the IP cards in the database with the `rtrv-ip-card` command. This is an example of the possible output.

```
rlghncxa03w 06-10-28 21:17:37 GMT EAGLE5 36.0.0
LOC 1212
  SRCHORDR  LOCAL
  DNSA      150.1.1.1
  DNSB      -----
  DEFROUTER 150.1.1.100
  DOMAIN    NC.TEKELEC.COM

LOC 1301
  SRCHORDR  SRVONLY
  DNSA      140.188.13.10
  DNSB      140.190.15.28
  DEFROUTER -----
  DOMAIN    NC.TEKELEC.COM

LOC 1303
  SRCHORDR  LOCAL
  DNSA      150.190.15.1
  DNSB      -----
  DEFROUTER 150.190.15.25
  DOMAIN    NC.TEKELEC.COM
```

If the required IP card is not shown in the `rtrv-ip-card` output, perform the “Adding an IP Card” procedure on page 3-17 to add the card to the database.

Perform the “Changing an IP Card” procedure on page 3-161 and make sure that the network portion of the IP addresses assigned for the A or B interfaces of the IP card is the same as the network portion of the IP address that will be assigned to the `gtwy` parameter of the IP route

NOTE: If a Class A or C IP address (see Table 3-12 on page 3-172) will be specified for the `dest` parameter in step 4, skip step 3 and go to step 4.

3. The subnet address that results from the `dest` and `submask` parameter values of the `ent-ip-rte` command cannot be the same as the subnet address that results from the `pvn` and `pvnmask` parameter values of the `chg-netopts` command. Display the `pvn` and `pvnmask` parameter values of the `chg-netopts` command by entering the `rtrv-netopts` command.

If error message **E3967 Cmd Rej: E5IS must be on** is displayed after the **rtrv-netopts** command is executed, the **pvn** and **pvnmask** parameters are not configured. Go to step 4.

This is an example of the possible output if the E5IS feature is on.

```
rlghncxa03w 06-10-28 21:17:37 GMT EAGLE5 36.0.0
NETWORK OPTIONS
-----
PVN      = 128.20.30.40
PVNMASK = 255.255.192.0
```

Choose **dest** and **submask** parameter values for the IP route whose resulting subnet address is not be the same as the subnet address resulting from the **pvn** and **pvnmask** parameter values of the **chg-netopts** command. Go to step 4.

-
4. Add the IP route to the database using the **ent-ip-rte** command. For this example, enter this command.

```
ent-ip-rte:loc=1212:dest=132.10.175.20:submask=255.255.255.255
:gtwy=150.1.1.50
```

When this command has successfully completed, this message should appear.

```
rlghncxa03w 06-10-12 09:12:36 GMT EAGLE5 36.0.0
ENT-IP-RTE: MASP A - COMPLTD
```

-
5. Verify the changes using the **rtrv-ip-rte** command with the card location specified with the **ent-ip-rte** command in step 4. For this example, enter these commands.

```
rtrv-ip-rte:loc=1212
```

This is an example of the possible output.

```
rlghncxa03w 06-10-28 09:12:36 GMT EAGLE5 36.0.0
LOC  DEST          SUBMASK          GTWY
1212 132.10.175.20   255.255.255.255 150.1.1.50

IP Route table is (6 of 1024) 1% full
```

-
6. Back up the new changes using the **chg-db:action=backup:dest=fixed** command. These messages should appear, the active Maintenance and Administration Subsystem Processor (MASP) appears first.

```
BACKUP (FIXED) : MASP A - Backup starts on active MASP.
BACKUP (FIXED) : MASP A - Backup on active MASP to fixed disk complete.
BACKUP (FIXED) : MASP A - Backup starts on standby MASP.
BACKUP (FIXED) : MASP A - Backup on standby MASP to fixed disk complete.
```

Flowchart 3-14. Adding an IP Route (Sheet 1 of 2)

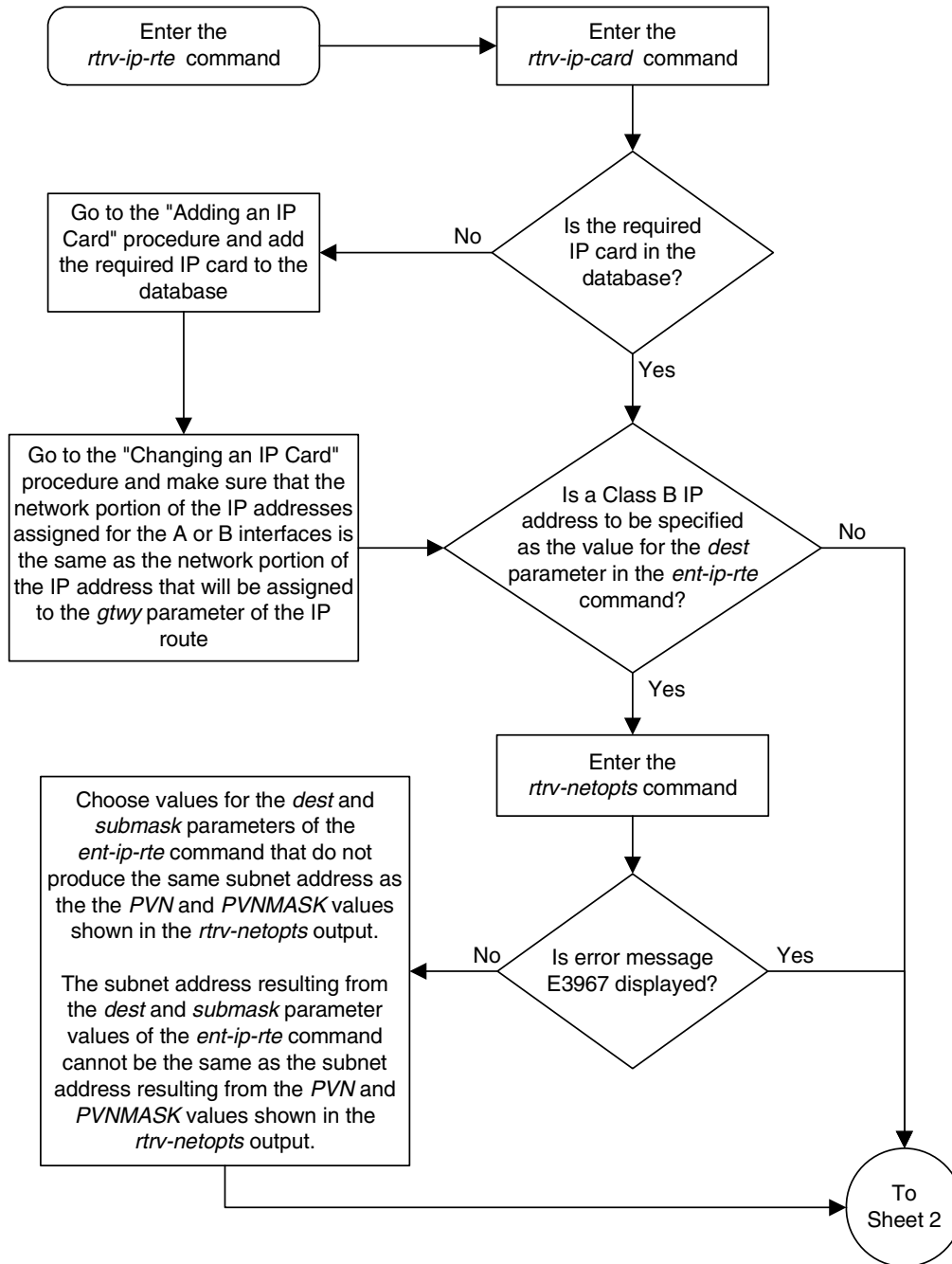

Flowchart 3-14. Adding an IP Route (Sheet 2 of 2)

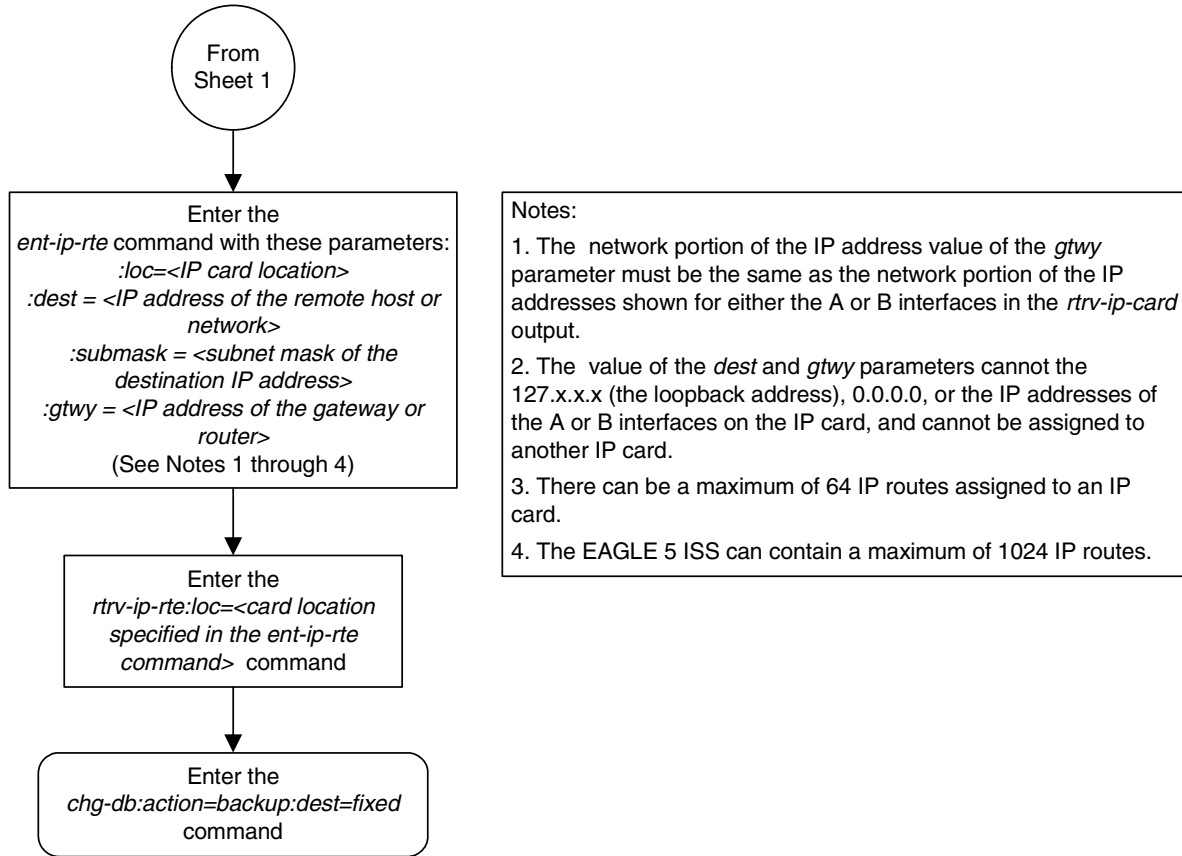

Removing an IP Route

This procedure is used to remove an IP route from the database using the `dlt-ip-rte` command.

The `dlt-ip-rte` command uses these parameters.

:loc – The location of the IP card containing the IP route being removed.

:dest – The IP address of the remote host or network assigned to the IP route being removed.

:force – To remove the IP route, the IP card that the route is assigned to must be out of service, or the `force=yes` parameter must be specified with the `dlt-ip-rte` command. The `force=yes` parameter allows the IP route to be removed if the IP card is in service.



CAUTION: Removing an IP route while the IP card is still in service can result in losing the ability to route outbound IP traffic on the IP card. This can cause both TCP and SCTP sessions on the IP card to be lost.

Procedure

1. Display the IP routes in the database with the `rtrv-ip-rte` command. This is an example of the possible output.

```
rlghncxa03w 06-10-28 09:12:36 GMT EAGLE5 36.0.0
LOC  DEST          SUBMASK          GTWY
1212 132.10.175.20    255.255.0.0      150.1.1.50
1301 128.252.10.5     255.255.255.255  140.188.13.33
1301 128.252.0.0      255.255.0.0      140.188.13.34
1301 150.10.1.1       255.255.255.255  140.190.15.3
1303 192.168.10.1     255.255.255.255  150.190.15.23
1303 192.168.0.0      255.255.255.0    150.190.15.24
```

```
IP Route table is (6 of 1024) 1% full
```

NOTE: If the IP card that the IP route is being assigned to is not shown in the `rtrv-ip-card` output in step 2, skip this step and go to step 4.

2. Verify the state of the IP card containing the IP route being removed by entering the `rept-stat-card` command and specifying the card location of the IP card. The IP card should be in the out-of-service maintenance-disabled (OOS-MT-DSBLD) in order to remove the IP route. If the IP card's state is out-of-service maintenance-disabled, the entry `OOS-MT-DSBLD` is shown in the `PST` column of the `rept-stat-card` output. For this example, enter this command.

```
rept-stat-card:loc=1301
```

This is an example of the possible output.

```
rlghncxa03w 06-10-27 17:00:36 GMT EAGLE5 36.0.0
CARD  VERSION      TYPE      APPL      PST          SST          AST
1301  114-000-000    DCM      IPLIM     IS-NR        Active       -----
ALARM STATUS      = No Alarms.
BPDCM GPL         = 002-102-000
IMT BUS A         = Conn
IMT BUS B         = Conn
SIGNALING LINK STATUS
SLK   PST          LS          CLLI
A     IS-NR        nc001      -----
```

Command Completed.

NOTE: If the output of step 2 shows that the IP card's state is not `OOS-MT-DSBLD`, and you do not wish to change the state of the IP card, skip step 3 and go to step 4.

3. Change the IP card's state to `OOS-MT-DSBLD` using the `inh-card` command and specifying the card location of the IP card. For this example, enter these commands.

```
inh-card:loc=1301
```

When this command has successfully completed, this message appears.

```
rlghncxa03w 06-10-12 09:12:36 GMT EAGLE5 36.0.0
Card has been inhibited.
```

4. Remove the IP route from the database using the `dlt-ip-rte` command. If the state of the IP card is not `OOS-MT-DSBLD`, the `force=yes` parameter must be specified with the `dlt-ip-rte` command. For this example, enter this command.

```
dlt-ip-rte:loc=1301:dest=128.252.0.0
```

CAUTION: Removing an IP route while the IP card is still in service can result in losing the ability to route outbound IP traffic on the IP card. This can cause both TCP and SCTP sessions on the IP card to be lost.

When this command has successfully completed, this message should appear.

```
rlghncxa03w 06-10-12 09:12:36 GMT EAGLE5 36.0.0
DLT-IP-RTE: MASP A - COMPLTD
```



5. Verify the changes using the `rtrv-ip-rte` command. This is an example of the possible output.

```
rlghncxa03w 06-10-28 09:12:36 GMT EAGLE5 36.0.0
LOC  DEST          SUBMASK          GTWY
1212 132.10.175.20    255.255.0.0      150.1.1.50
1301 128.252.10.5     255.255.255.255  140.188.13.33
1301 150.10.1.1       255.255.255.255  140.190.15.3
1303 192.168.10.1     255.255.255.255  150.190.15.23
1303 192.168.0.0      255.255.0.0      150.190.15.24
```

```
IP Route table is (5 of 1024) 1% full
```

NOTE: If the IP card containing the IP route that was removed from the database does not contain other IP routes, skip step 6 and go to step 7.

6. Place the IP card back into service by using the `alw-card` command. For example, enter this command.

```
alw-card:loc=1301
```

This message should appear.

```
rlghncxa03w 06-10-28 21:22:37 GMT EAGLE5 36.0.0
Card has been allowed.
```

7. Back up the new changes using the `chg-db:action=backup:dest=fixed` command. These messages should appear, the active Maintenance and Administration Subsystem Processor (MASP) appears first.

```
BACKUP (FIXED) : MASP A - Backup starts on active MASP.
BACKUP (FIXED) : MASP A - Backup on active MASP to fixed disk complete.
BACKUP (FIXED) : MASP A - Backup starts on standby MASP.
BACKUP (FIXED) : MASP A - Backup on standby MASP to fixed disk complete.
```

Flowchart 3-15. Removing an IP Route

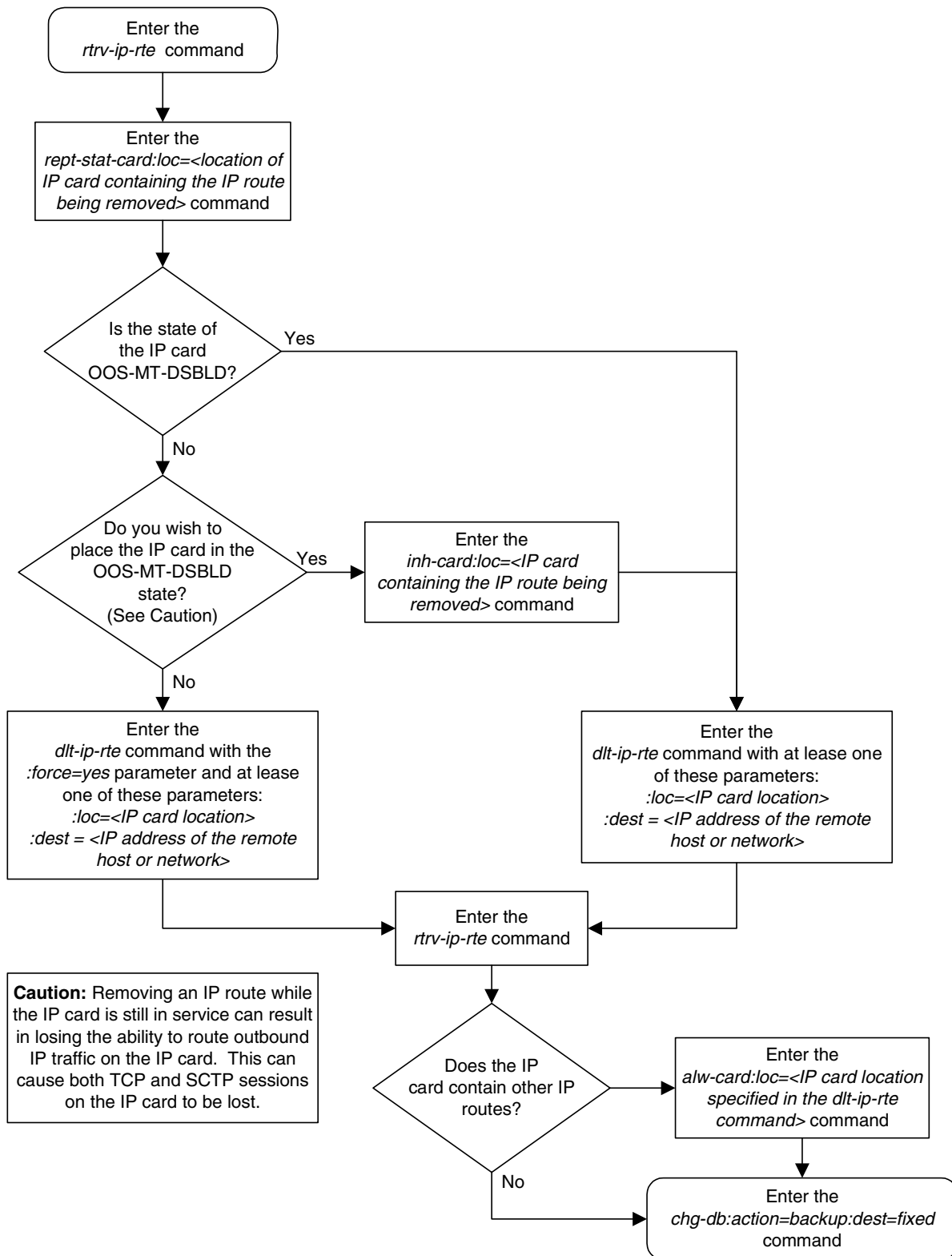

Adding an Application Socket

This procedure is used to add an application socket to the database using the **ent-app1-sock** command. The combination of local host, local TCP port, remote host and remote TCP port defines an application socket.

The **ent-app1-sock** command uses these parameters.

:sname – The name assigned to the socket. Valid socket names can contain up to 15 alphanumeric characters where the first character is a letter and the remaining characters are alphanumeric characters. The **sname** parameter value is not case-sensitive.

:lhost – Local Hostname. The logical name assigned to the local host device. The local host name must be shown in the **LOCAL HOST** column of the **rtrv-ip-host** output. Local host names that contain dashes (-) must be enclosed in double quotes (“”).

:lport – The TCP port number for the local host.

:rhost – Remote Hostname. The logical name assigned to the remote host device. The remote host name does not have to be shown in the **rtrv-ip-host** output. If remote host name is shown in the **rtrv-ip-host** output, it must be shown in the **REMOTE HOST** column of the **rtrv-ip-host** output. Remote host names that contain dashes (-) must be enclosed in double quotes (“”).

:rport – The TCP port number of the remote host.

:link – The signaling link on the IP card. If a signaling link is not specified for a socket when it is entered, the socket defaults to the signaling link A. If the card's application is **iplim** or **iplimi**, and the card is a dual-slot DCM, the values for the **link** parameter can be only **a** or **b**. If the card's application is **iplim** or **iplimi**, and the card is a single-slot EDCM, the values for the **link** parameter can be **a**, **a1**, **a2**, **a3**, **b**, **b1**, **b2**, or **b3**. If the IP card's application is **ss7ipgw** or **ipgwi**, only **link=a** can be specified.

NOTE: The **port** parameter can be used in place of the **link** parameter to specify the signaling link on the card.

NOTE: If the ITU National and International Spare Point Code Support feature is enabled, the socket cannot reference a card running the IPGWI application. Enter the **rtrv-ctrl-feat:partnum=893013601** command to verify whether or not the ITU National and International Spare Point Code Support feature is enabled. If the ITU National and International Spare Point Code Support feature is enabled, and the IP connection is being assigned to a card running the IPGWI application, the IP connection must be an IETF association. Perform the “Adding an Association” procedure on page 3-327 to add the IP connection to the database.

The maximum number of TALI sockets and SCTP association to application server assignments that can be hosted by an IPGWx card (referenced by the **lhost** parameter of the socket and association) is 50. For example, if the IPGWx card contains 22 SCTP association to application server assignments, the maximum

number of TALI sockets the IPGWx card can support is 28. The SCTP association to application server assignments can be verified with the `rtrv-assoc:lhost=<local host name>` and `rtrv-as:aname=<association name>` commands.

Table 3-13. Examples of IPGWx Card Provisioning Limits

| Number of Associations hosted by the IPGWx card | Number of Application Servers each Association is Assigned to * | Number of TALI Sockets Hosted by the IPGWx card | Total Association - Application Server Assignments and TALI Sockets maintained by the IPGWx card |
|---|---|---|--|
| 1 | 50 | 0 | 50 |
| 50 | 1 | 0 | 50 |
| 25 | 1 | 25 | 50 |
| 25 | 2 | 0 | 50 |
| 0 | 0 | 50 | 50 |
| 22 | 1 | 28 | 50 |
| 11 | 2 | 28 | 50 |

* The EAGLE 5 ISS can contain a maximum of 250 application servers.

For the `iplim` and `iplimi` applications, each IP card can have one socket for each signaling link assigned to the card. Dual-slot DCMs can have a maximum of two sockets. Single-slot EDCMs can have a maximum of 8 sockets.

The EAGLE 5 ISS can contain a maximum of 4000 connections (association to application server assignments plus sockets).

The socket name must be unique (not already used).

The socket table, which contains both the socket and association data, contains fields whose values are not assigned using the `ent-appl-sock` command. When a socket is added to the database, these fields receive their default values. If a different value is desired, the `chg-appl-sock` command must be used. These fields and their default values are:

```

open=no           dcmps=10
alw=no           rexmit=fixed
server=yes       rtt=60
    
```

The value of the `lhost` and `rhost` parameters is a text string of up to 60 characters, with the first character being a letter. The command line on the terminal can contain up to 150 characters. If the host name is too long to fit on the `ent-appl-sock` command line, go to the "Changing an Application Socket" procedure on page 3-202 to complete the entry of the host name.

The IP address of the local host (**lhost** parameter) must be shown in the **rtrv-ip-lnk** output.

The signaling link being assigned to the socket must be out of service. This state is shown in the **rept-stat-slk** output with the entries **OOS-MT** in the **PST** field and **Unavail** in the **SST** field.

If the card's application is either IPLIM or IPLIMI:

- The **iplim12** parameter value of the signaling link assigned to the socket must be **saaltali**.
- The signaling link being assigned to the socket must be out of service. This state is shown in the **rept-stat-slk** output with the entries **OOS-MT** in the **PST** field and **Unavail** in the **SST** field.
- If the socket is being opened in this procedure with the **chg-appl-sock** command and the **open=yes** parameter, the signaling link assigned to the socket must be in the database and the **iplim12** parameter value of the signaling link assigned to the socket must be **saaltali**.

If the card's application is either SS7IPGW or IPGWI, the signaling link being assigned to the socket must be in service. This state is shown in the **rept-stat-slk** output with the entries **IS-NR** in the **PST** field and **Avail** in the **SST** field.

The B Ethernet interface of the IP card can be used only if the IP card is a single-slot EDCM.

If the socket is being activated in this procedure with the **chg-appl-sock** command, the socket must contain values for the **lhost**, **lport**, **rhost**, and **rport** parameters.

Canceling the RTRV-APPL-SOCK Command

Because the **rtrv-appl-sock** command used in this procedure can output information for a long period of time, the **rtrv-appl-sock** command can be canceled and the output to the terminal stopped. There are three ways that the **rtrv-appl-sock** command can be canceled.

- Press the **F9** function key on the keyboard at the terminal where the **rtrv-appl-sock** command was entered.
- Enter the **canc-cmd** without the **trm** parameter at the terminal where the **rtrv-appl-sock** command was entered.
- Enter the **canc-cmd:trm=<xx>**, where **<xx>** is the terminal where the **rtrv-appl-sock** command was entered, from another terminal other than the terminal where the **rtrv-appl-sock** command was entered. To enter the **canc-cmd:trm=<xx>** command, the terminal must allow Security Administration commands to be entered from it and the user must be allowed to enter Security Administration commands. The terminal's permissions can be verified with the **rtrv-secu-trm** command. The user's permissions can be verified with the **rtrv-user** or **rtrv-secu-user** commands.

For more information about the **canc-cmd** command, go to the *Commands Manual*.

Procedure

1. Display the current application socket information in the database by entering the **rtrv-appl-sock** command. The following is an example of the possible output.

```
rlghncxa03w 06-10-28 21:14:37 GMT EAGLE5 36.0.0
SNAME kchlr11201
LINK    A
LHOST   ipnode1-1201
RHOST   kc-hlr1
LPORT   7000          RPORT   7000
SERVER  YES          DCMPS   1
REXMIT  FIXED        RTT     60
OPEN    YES          ALW     YES

SNAME sock1
LINK    A
LHOST   IPNODE2-1205
RHOST   remotehost1
LPORT   1024          RPORT   2048
SERVER  YES          DCMPS   10
REXMIT  FIXED        RTT     60
OPEN    YES          ALW     YES

SNAME sock2
LINK    A
LHOST   IPNODE2-1205
RHOST   remotehost2
LPORT   2000          RPORT   2000
SERVER  YES          DCMPS   10
REXMIT  FIXED        RTT     60
OPEN    YES          ALW     YES

IP Appl Sock/Assoc table is (5 of 4000) 1% full
```

2. Display the IP links in the database by entering the **rtrv-ip-lnk** command. The following is an example of the possible output.

```
rlghncxa03w 06-10-28 21:19:37 GMT EAGLE5 36.0.0
LOC  PORT IPADDR          SUBMASK          DUPLEX  SPEED  MACTYPE  AUTO  MCAST
1201 A    192.1.1.10        255.255.255.0    ----   ---   DIX      YES  NO
1203 A    192.1.1.12        255.255.255.0    ----   ---   DIX      YES  NO
1205 A    192.1.1.14        255.255.255.0    FULL   100   DIX      NO   NO
```

If an IP link containing the required IP address is shown in the **rtrv-ip-lnk** output, go to step 3.

If an IP link containing the required IP address is not shown in the **rtrv-ip-lnk** output, add the IP link using the “Changing an IP Link” procedure on page 3-135. After the IP link is added, perform the “Adding an IP Host” procedure on page 3-153 to assign this IP address to a local host name. After the local host name as been added, skip step 3 and go to step 4.

3. Verify that the local host name to be assigned to the socket is in the database by using the `rtrv-ip-host` command. The following is an example of the possible output.

```
rlghncxa03w 06-10-28 21:15:37 GMT EAGLE5 36.0.0

LOCAL IPADDR    LOCAL HOST
192.1.1.10      IPNODE1-1201
192.1.1.12      IPNODE1-1203
192.1.1.14      IPNODE1-1205
192.1.1.20      IPNODE2-1201
192.1.1.22      IPNODE2-1203
192.1.1.24      IPNODE2-1205
192.1.1.30      KC-HLR1
192.1.1.32      KC-HLR2
192.1.1.50      DN-MS1
192.1.1.52      DN-MS2

REMOTE IPADDR    REMOTE HOST
150.1.1.5       NCDEPTECONOMIC_DEVELOPMENT.SOUTHEASTERN_COORIDOR_ASHVL.GOV

IP Host table is (11 of 512) 2% full
```

If the required hostname is not shown in the `rtrv-ip-host` output, add the IP host name with the IP address shown in step 2 by performing the “Adding an IP Host” procedure on page 3-153.

4. Display the application running on the IP card shown in step 2 using the `rept-stat-card` command specifying the location of the IP card. For this example, enter this command.

```
rept-stat-card:loc=1203
```

This is an example of the possible output.

```
rlghncxa03w 06-10-27 17:00:36 GMT EAGLE5 36.0.0
CARD  VERSION      TYPE   APPL      PST          SST          AST
1203  114-000-000     DCM    IPLIM     IS-NR        Active       -----
ALARM STATUS      = No Alarms.
BPDCM GPL         = 002-102-000
IMT BUS A         = Conn
IMT BUS B         = Conn
SIGNALING LINK STATUS
SLK   PST          LS          CLLI
A     IS-NR        nc001      -----
```

```
Command Completed.
```

NOTE: If the card’s application is SS7IPGW or IPGWI, shown in the APPL column in the `rept-stat-card` output in step 4, and if the local host value being used in this procedure was added in step 3, skip steps 5, 6, and 7, and go to step 8.

5. Display the sockets assigned to the local host that will be assigned to the socket being configured in this procedure by entering the `rtrv-appl-sock` command with the `lhost` parameter. For this example, enter this command.

```
rtrv-appl-sock:lhost=IPNODE2-1205
```

This is an example of the possible output.

```
rlghncxa03w 06-10-28 21:14:37 GMT EAGLE5 36.0.0
SNAME sock1
  LINK      A
  LHOST     IPNODE2-1205
  RHOST     remotehost1
  LPORT     1024      RPORT      2048
  SERVER    YES       DCMPS      10
  REXMIT    FIXED    RTT        60
  OPEN      YES      ALW        YES

SNAME sock2
  LINK      A
  LHOST     IPNODE2-1205
  RHOST     remotehost2
  LPORT     2000      RPORT      2000
  SERVER    YES       DCMPS      10
  REXMIT    FIXED    RTT        60
  OPEN      YES      ALW        YES

IP Appl Sock/Assoc table is (5 of 4000) 1% full
```

6. Display the associations assigned to the local host that will be assigned to the socket being configured in this procedure by entering the `rtrv-assoc` command with the `lhost` parameter. For this example, enter this command.

rtrv-assoc:lhost=IPNODE2-1205

This is an example of the possible output.

```
rlghncxa03w 06-10-28 21:14:37 GMT EAGLE5 36.0.0
      CARD IPLNK
ANAME      LOC  PORT  LINK ADAPTER LPORT RPORT OPEN ALW
assoc1     1205 A    A    M3UA  2048 2048 YES YES
assoc2     1205 A    A    SUA   3000 3000 YES YES

IP Appl Sock/Assoc table is (5 of 4000) 1% full
Assoc Buffer Space Used (32 KB of 3200 KB) on LOC = 1205
```

7. Display the application servers that the associations shown in step 6 are assigned to by entering `rtrv-as` command with the names of the associations shown in step 6. For this example, enter these commands.

rtrv-as:aname=assoc1

This is an example of the possible output.

```
rlghncxa03w 06-10-28 21:14:37 GMT EAGLE5 36.0.0
AS Name      Mode      Tr ms  Association Names
as1          LOADSHARE 2000   assoc1

as4          LOADSHARE 2000   assoc1

as6          LOADSHARE 2000   assoc1

AS Table is (6 of 250) 1% full
```

rtrv-as:aname=assoc2

This is an example of the possible output.

```
rlghncxa03w 06-10-28 21:14:37 GMT EAGLE5 36.0.0
AS Name           Mode           Tr ms   Association Names
as2                LOADSHARE     2000    assoc2

as3                LOADSHARE     2000    assoc2

as5                LOADSHARE     2000    assoc2

AS Table is (6 of 250) 2% full
```

The maximum number of TALI sockets and SCTP association to application server assignments that can be hosted by an IPGWx card (referenced by the **lhost** parameter of the socket and association) is 50.

If the number of TALI sockets and SCTP association to application server assignments is less than 50, go to step 8.

If the number of TALI sockets and SCTP association to application server assignments is 50, the local host value cannot be used in this procedure.

Repeat steps 2 and 3 and select another IP link and IP host to use in this procedure or add a new IP link using the “Changing an IP Link” procedure on page 3-135. After the new IP link is added, perform the “Adding an IP Host” procedure on page 3-153 to assign this IP address to a new local host name. After the new local host name as been added, go to step 8.

NOTE: If the card’s application is SS7IPGW, IPLIM, or IPLIMI, shown in the APPL column in the **rept-stat-card** output in step 4, skip step 8 and go to step 9.

8. Display the status of the ITU National and International Spare Point Code Support feature by entering the **rtrv-ctrl-feat** command with the ITU National and International Spare Point Code Support feature part number. Enter this command.

rtrv-ctrl-feat:partnum=893013601

The following is an example of the possible output.

```
rlghncxa03w 06-10-28 21:15:37 GMT EAGLE5 36.0.0
The following features have been permanently enabled:
```

| Feature Name | Partnum | Status | Quantity |
|--------------------------|-----------|--------|----------|
| Spare Point Code Support | 893013601 | on | ---- |

The following features have been temporarily enabled:

| Feature Name | Partnum | Status | Quantity | Trial Period Left |
|---------------------|---------|--------|----------|-------------------|
| Zero entries found. | | | | |

The following features have expired temporary keys:

| Feature Name | Partnum |
|---------------------|---------|
| Zero entries found. | |

If the ITU National and International Spare Point Code Support feature is not enabled, go to step 13.

If the ITU National and International Spare Point Code Support feature is enabled, the remainder of this procedure cannot be performed. A socket cannot be added to the database if the application running on the card containing the signaling link is IPGWI and the ITU National and International Spare Point Code Support feature is enabled. Perform the “Adding an Association” procedure on page 3-327 to add the IP connection to the database.

NOTE: If the card’s application is SS7IPGW or IPGWI, shown in the APPL column in the `rept-stat-card` output in step 4, skip steps 9, 10, 11, and 12, and go to step 13.

9. Display the signaling link referenced by the IP link that will be assigned to the socket by entering the `rtrv-slk` command and specifying the card location shown in step 4. For this example, enter this command.

```
rtrv-slk:loc=1203
```

This is an example of the possible output.

```
rlghncxa03w 06-10-19 21:17:04 GMT EAGLE5 36.0.0
LOC  LINK LSN          SLC TYPE  IPLIML2
1203 A    e5e6a          1  IPLIM  SAALTALI
```

When the IP card’s application is either IPLIM or IPLIMI, the `ipliml2` parameter value for the signaling link assigned to the socket must be `saaltali`. If the `ipliml2` parameter is not `saaltali`, remove the signaling link using the “Removing an IP Signaling Link” procedure on page 3-113. Add the signaling link back into the database with the `ipliml2=saaltali` parameter, and without activating the signaling link, using the “Adding an IP Signaling Link” procedure on page 3-84.

NOTE: If the “Adding an IP Signaling Link” procedure on page 3-84 was not performed in step 9, skip steps 10, 11, and 12, and go to step 13.

10. Display the status of the signaling link shown in step 9 using the `rept-stat-slk` command specifying the card location and the signaling link that will be assigned to the socket. For example, enter this command.

```
rept-stat-slk:loc=1203:link=a
```

This is an example of the possible output.

```
rlghncxa03w 06-10-28 21:16:37 GMT EAGLE5 36.0.0
SLK   LSN          CLLI      PST          SST          AST
1203,A e5e6a          ----- IS-NR      Avail      -----
Command Completed.
```

NOTE: If the primary state (PST) of the signaling link is `OOS-MT` and the secondary state (SST) is `Unavail`, skip steps 11 and 12, and go to step 13.

- 11 Deactivate the signaling link from step 10 using the `dact-slk` command. For example, enter this command.

```
dact-slk:loc=1203:link=a
```

When this command has successfully completed, the following message should appear.

```
rlghncxa03w 06-10-07 11:11:28 GMT EAGLE5 36.0.0
Deactivate Link message sent to card
```

12. Verify the status of the signaling link using the `rept-stat-slk` command. For example, enter this command.

```
rept-stat-slk:loc=1203:link=a
```

This is an example of the possible output.

```
rlghncxa03w 06-10-28 21:16:37 GMT EAGLE5 36.0.0
SLK      LSN      CLLI      PST      SST      AST
1203,A   e5e6a     -----  OOS-MT   Unavail   ----
Command Completed.
```

13. Add the application socket to the database by entering the `ent-appl-sock` command with these mandatory parameters:

:sname = the socket name

:lhost = the local host name from step 3

and with at least one of these optional parameters:

:lport = the local port ID, from 1024 to 65535

:rhost = the remote host name

:rport = the remote port ID, from 1024 to 65535

:link = the signaling link value from step 10.

NOTE: The `port` parameter can be used in place of the `link` parameter to specify the signaling link on the card.

NOTE: See Flowchart 3-16 on page 3-197 (Sheet 6) for the rules that apply to the `ent-appl-sock` command.

For example, enter this command.

```
ent-appl-sock:sname=kchlr11203:lhost="ipnode-1203"
:lport=7005:rhost="kc-hlr1":rport=7005:link=a
```

When this command has successfully completed, the following message should appear.

```
rlghncxa03w 06-10-28 21:15:37 GMT EAGLE5 36.0.0
ENT-APPL-SOCK: MASP A - COMPLTD
```

NOTE: If the socket added in step 13 is not being activated in this procedure, skip step 14 and go to step 15.

14. Activate the socket added in step 13 by entering the **chg-appl-sock** command with the socket name specified in step 13 and the **open=yes** and **alw=yes** parameters. For example, enter this command.

```
chg-appl-sock:sname=kchlr11203:open=yes:alw=yes
```

When this command has successfully completed, the following message should appear.

```
rlghncxa03w 06-10-28 21:15:37 GMT EAGLE5 36.0.0
CHG-APPL-SOCK: MASP A - COMPLTD
```

NOTE: If the card's application is SS7IPGW or IPGWI, skip steps 15 and 16, and go to step 17.

15. Activate the signaling link assigned to the socket using the **act-slk** command. For example, enter this command.

```
act-slk:loc=1203:link=a
```

When this command has successfully completed, the following message should appear.

```
rlghncxa03w 06-10-07 11:11:28 GMT EAGLE5 36.0.0
Activate Link message sent to card
```

16. Verify the status of the signaling link using the **rept-stat-slk** command. For example, enter this command.

```
rept-stat-slk:loc=1203:link=a
```

This is an example of the possible output.

```
rlghncxa03w 06-10-28 21:16:37 GMT EAGLE5 36.0.0
SLK      LSN      CLLI      PST      SST      AST
1203,A   e5e6a     -----  IS-NR    Avail    ----
Command Completed.
```

17. Verify the new application socket information in the database by entering the **rtrv-appl-sock** command with the socket name specified in step 13. For this example, enter this command.

```
rtrv-appl-sock:sname=kchlr11203
```

The following is an example of the possible output.

```
rlghncxa03w 06-10-28 21:16:37 GMT EAGLE5 36.0.0
SNAME kchlr11203
LINK A
LHOST ipnode1-1203
RHOST kc-hlr1
LPORT 7005          RPORT 7005
SERVER YES         DCMPS 10
REXMIT FIXED      RTT 60
OPEN YES          ALW YES
```

```
IP Appl Sock/Assoc table is (3 of 4000) 1% full
```

18. Back up the new changes using the **chg-db:action=backup:dest=fixed** command. These messages should appear, the active Maintenance and Administration Subsystem Processor (MASP) appears first.

```
BACKUP (FIXED) : MASP A - Backup starts on active MASP.  
BACKUP (FIXED) : MASP A - Backup on active MASP to fixed disk complete.  
BACKUP (FIXED) : MASP A - Backup starts on standby MASP.  
BACKUP (FIXED) : MASP A - Backup on standby MASP to fixed disk complete.
```

Flowchart 3-16. Adding an Application Socket (Sheet 1 of 6)

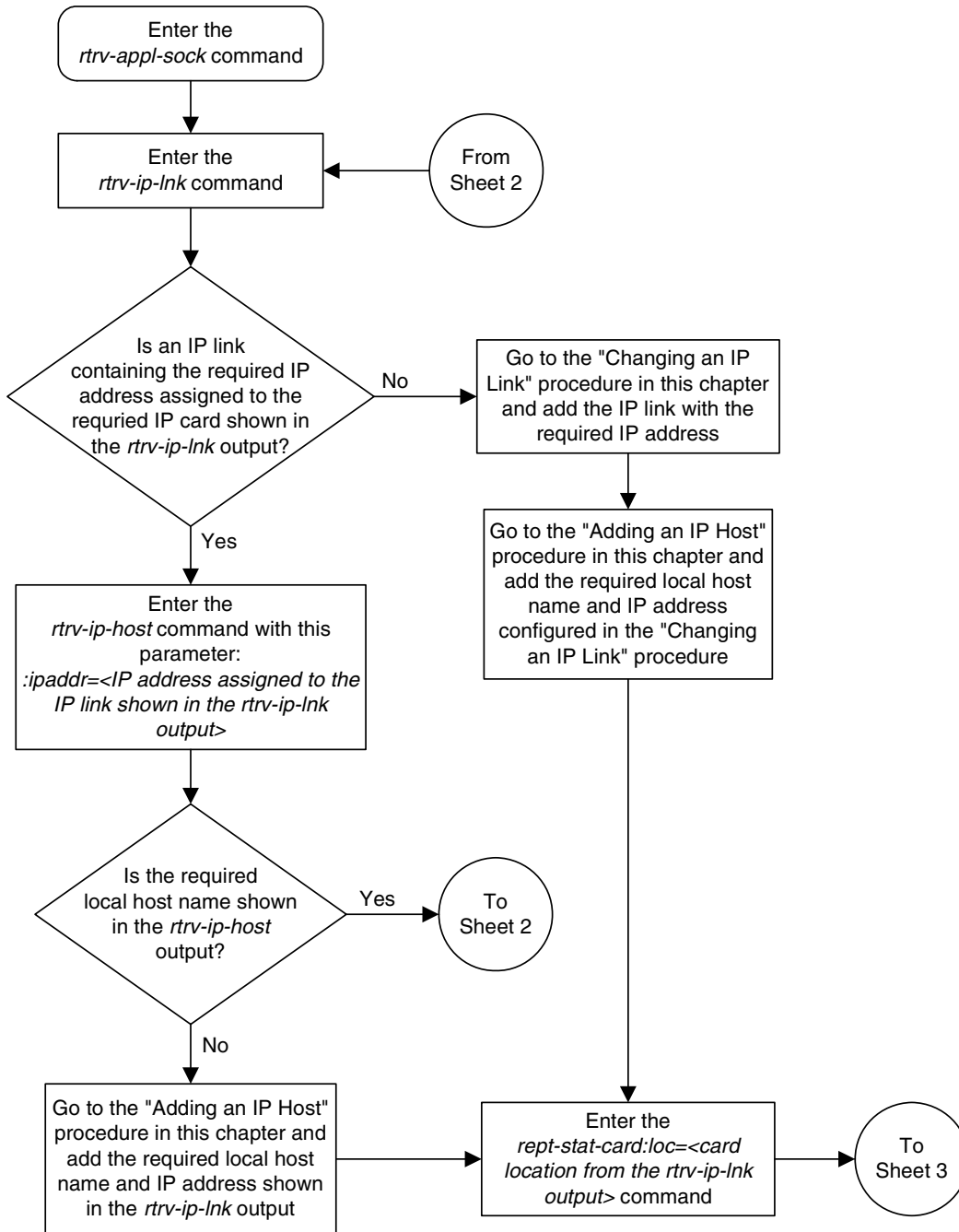

Flowchart 3-16. Adding an Application Socket (Sheet 2 of 6)

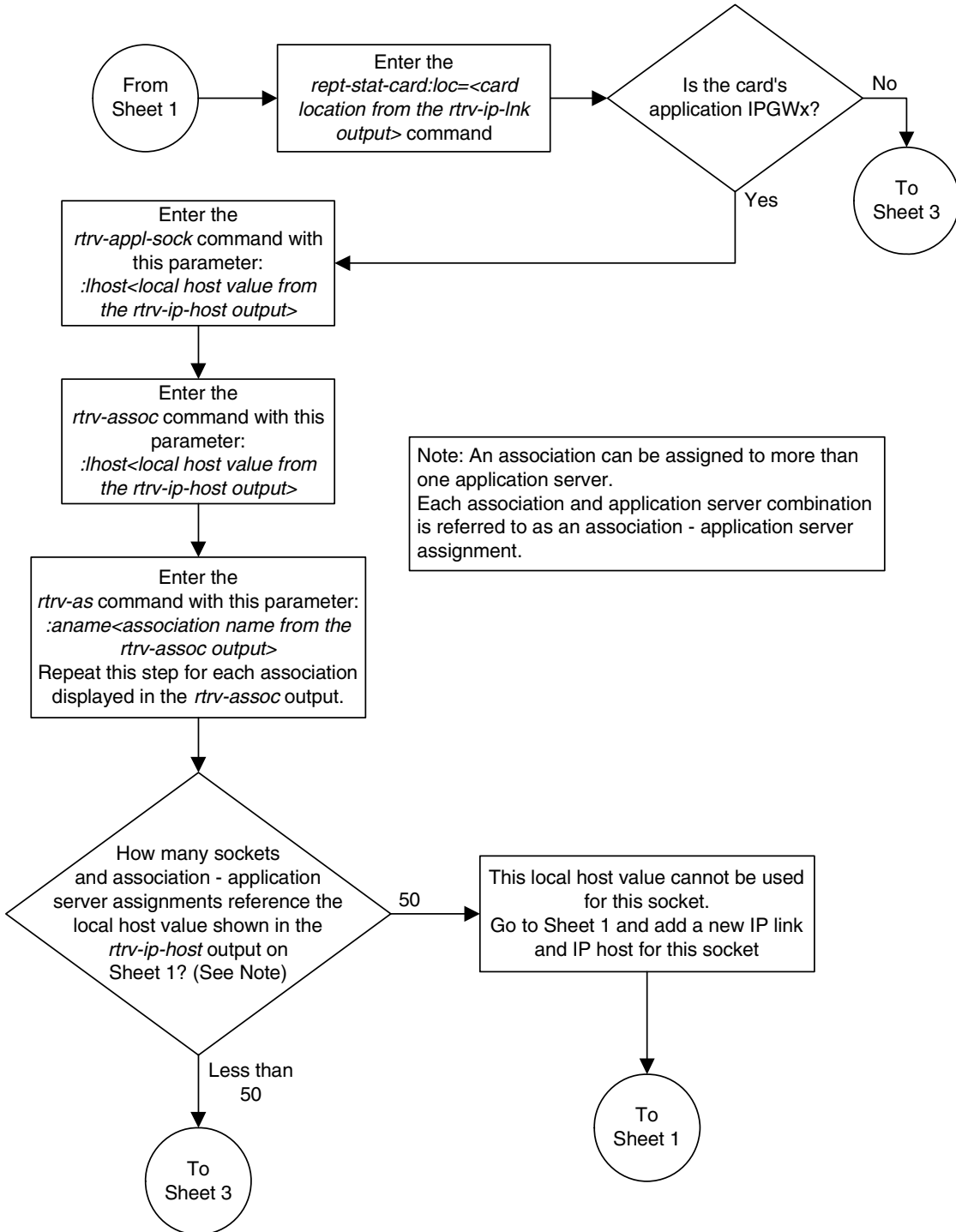

Flowchart 3-16. Adding an Application Socket (Sheet 3 of 6)

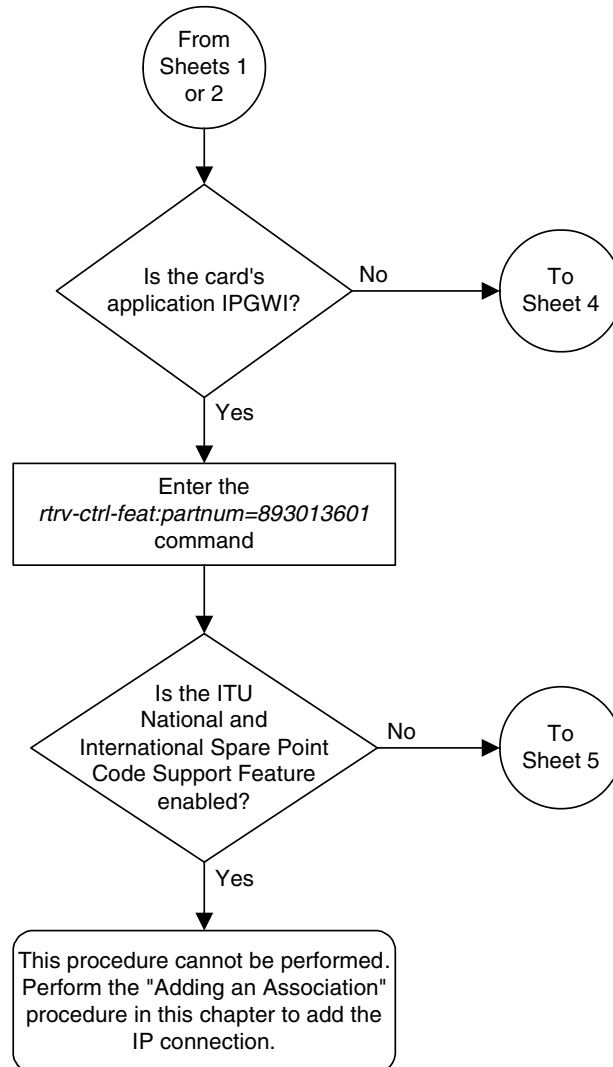

Flowchart 3-16. Adding an Application Socket (Sheet 4 of 6)

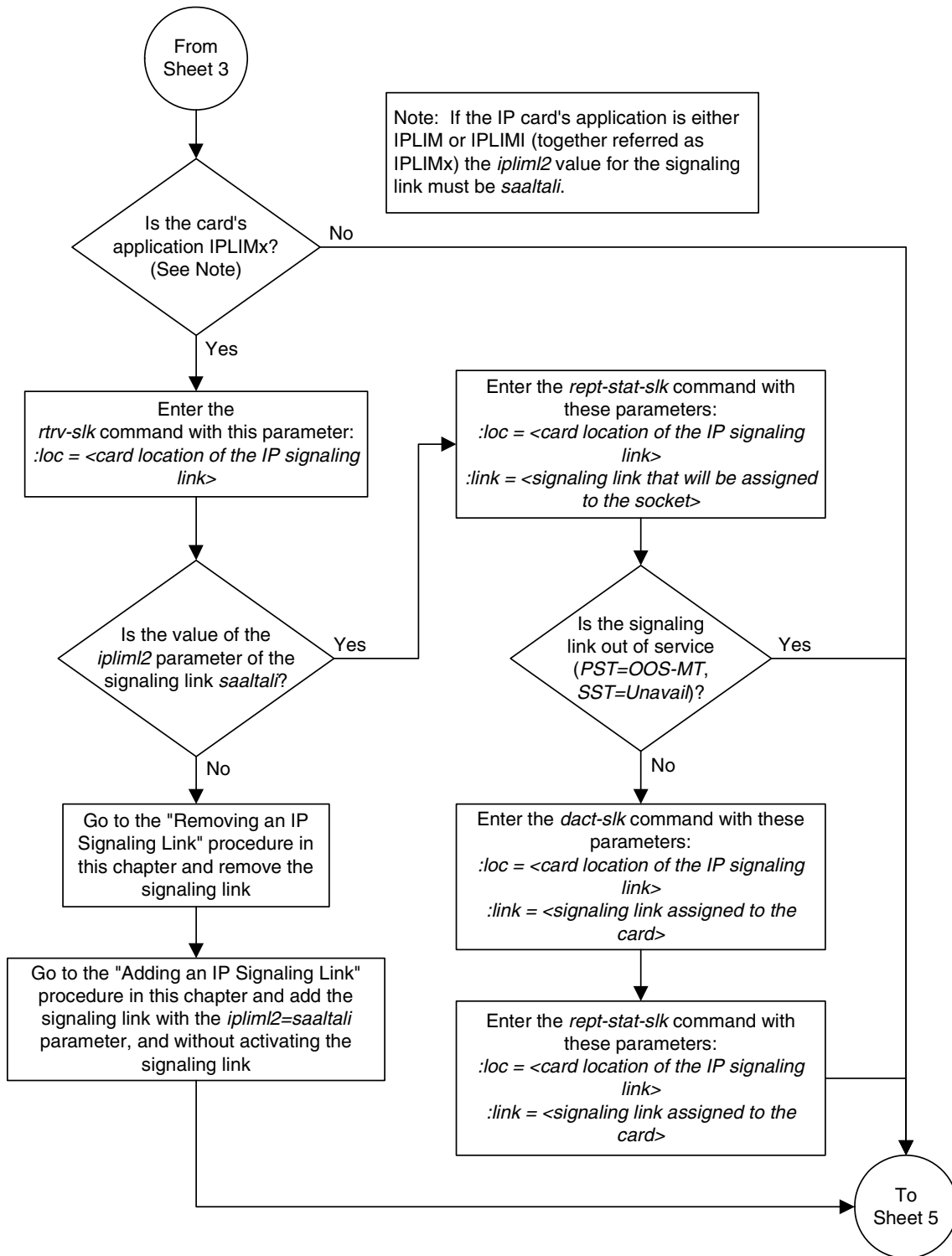

Flowchart 3-16. Adding an Application Socket (Sheet 5 of 6)

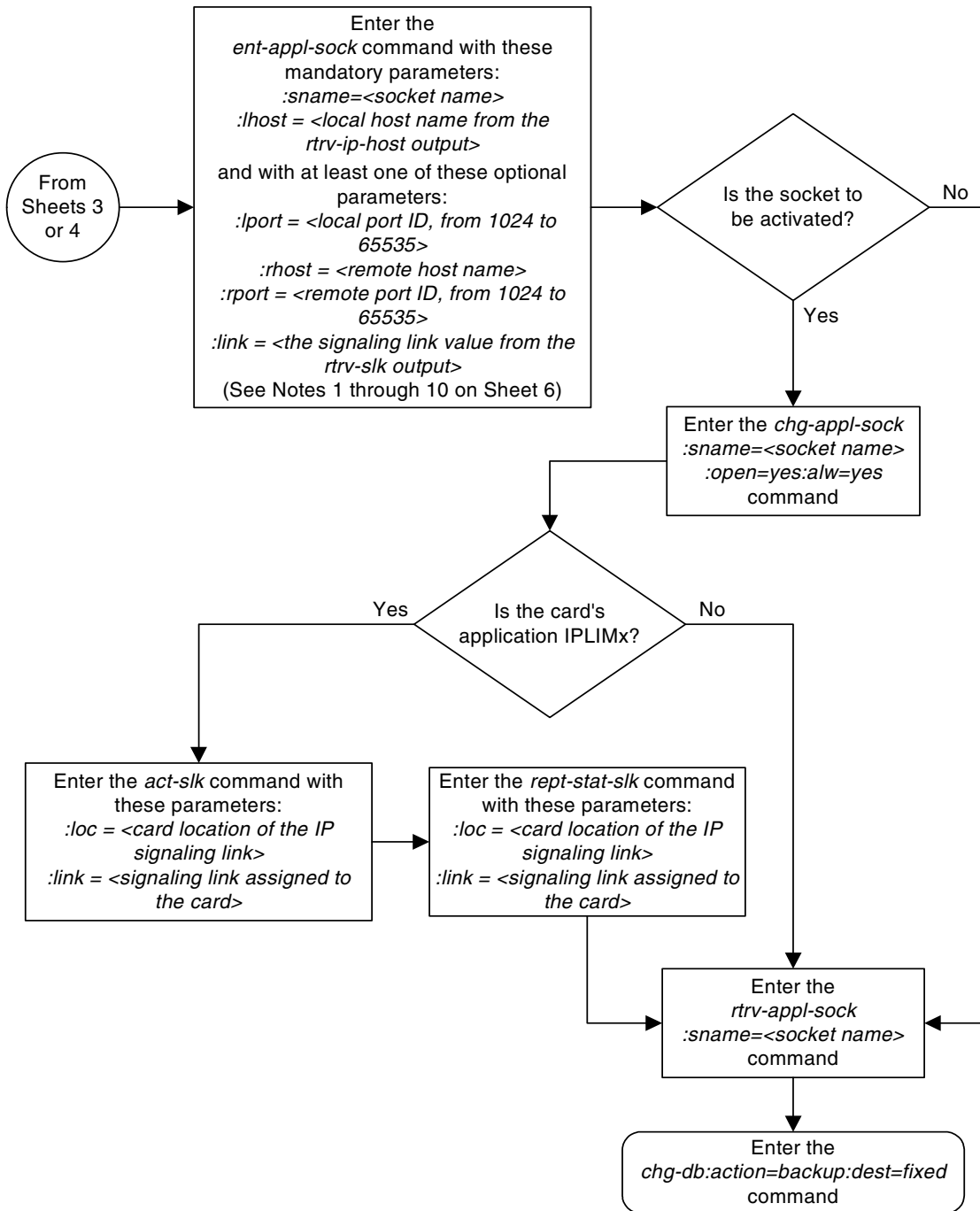

Flowchart 3-16. Adding an Application Socket (Sheet 6 of 6)

Notes:

1. If the card containing the signaling link is a DCM, the B Ethernet interface cannot be used. Single-slot EDCMs can use the B Ethernet interface.
2. The sum of the number of sockets and association – application server assignments on a card running either the *ss7ipgw* or *ipgwi* applications cannot exceed 50.
3. The EAGLE 5 ISS can contain a maximum of 4000 connections (association – application server assignments plus sockets).
4. Cards running either the *iplim* or *iplimi* applications can have only one connection for each signaling link and a maximum of two connections for each card, if the card is a dual-slot DCM. If the card is a single-slot EDCM, the card may contain a maximum of eight connections.
5. The value of the *lhost* and *rhost* parameters is a text string of up to 60 characters, with the first character being a letter. The command line on the terminal can contain up to 150 characters. If the host name is too long to fit on the *ent-appl-sock* command line, go to the "Changing an Application Socket" procedure to complete the entry of the host name.
6. If the new socket is to be activated in this procedure with the *chg-appl-sock* command, the socket must contain values for the *lhost*, *rhost*, *lport*, and *rport* parameters.
7. The local host name must be shown in the *rtrv-ip-host* output in the *LOCAL HOST* column.
8. The remote host name does not have to be shown in the *rtrv-ip-host* output. If the remote host name is shown in the *rtrv-ip-host* output, it must be shown in the *REMOTE HOST* column.
9. Host names (local and remote) that contain dashes (-) must be enclosed in double quotes ("").
10. The *port* parameter can be used in place of the *link* parameter to specify the signaling link assigned to the socket.

Removing an Application Socket

This procedure is used to remove an application socket from the database using the `dlt-appl-sock` command.

The `dlt-appl-sock` command has only one parameter, `:sname` – the socket name being removed.

The `open` parameter must be set to `no` before the application socket can be removed. Use the `chg-appl-sock` command to change the value of the `open` parameter.

The socket cannot be removed if it is referenced by any routing keys. This can be verified with the `rtrv-appl-rtkey` command.

Canceling the RTRV-APPL-SOCK and RTRV-APPL-RTKEY Commands

Because the `rtrv-appl-sock` and `rtrv-appl-rtkey` commands used in this procedure can output information for a long period of time, the `rtrv-appl-sock` and `rtrv-appl-rtkey` commands can be canceled and the output to the terminal stopped. There are three ways that the `rtrv-appl-sock` and `rtrv-appl-rtkey` commands can be canceled.

- Press the **F9** function key on the keyboard at the terminal where the `rtrv-appl-sock` and `rtrv-appl-rtkey` commands were entered.
- Enter the `canc-cmd` without the `trm` parameter at the terminal where the `rtrv-appl-sock` and `rtrv-appl-rtkey` commands were entered.
- Enter the `canc-cmd:trm=<xx>`, where `<xx>` is the terminal where the `rtrv-appl-sock` and `rtrv-appl-rtkey` commands were entered, from another terminal other than the terminal where the `rtrv-appl-sock` and `rtrv-appl-rtkey` commands were entered. To enter the `canc-cmd:trm=<xx>` command, the terminal must allow Security Administration commands to be entered from it and the user must be allowed to enter Security Administration commands. The terminal's permissions can be verified with the `rtrv-secu-trm` command. The user's permissions can be verified with the `rtrv-user` or `rtrv-secu-user` commands.

For more information about the `canc-cmd` command, go to the *Commands Manual*.

Procedure

1. Display the current application socket information in the database by entering the `rtrv-appl-sock` command. The following is an example of the possible output.

```
rlghncxa03w 06-10-28 21:15:37 GMT EAGLE5 36.0.0
SNAME kchlr11201
  LINK   A
  LHOST  ipnode1-1201
  RHOST  kc-hlr1
  LPORT  7000          RPORT  7000
  SERVER YES          DCMPS  1
  REXMIT FIXED       RTT    60
  OPEN   YES          ALW    NO

SNAME kchlr11203
  LINK   A
  LHOST  ipnode1-1203
  RHOST  kc-hlr1
  LPORT  7005          RPORT  7005
  SERVER YES          DCMPS  10
  REXMIT FIXED       RTT    60
  OPEN   NO           ALW    NO
```

IP Appl Sock/Assoc table is (3 of 4000) 1% full

NOTE: If the application socket information shows the value of the `open` parameter in the socket being removed from the database is `no`, skip this step and go to step 3.

2. Change the `open` parameter value in the socket being removed from the database using the `chg-appl-sock` command with the `open=no` parameter.



CAUTION: Setting the `open` parameter value to `no` could cause traffic to be lost.

For example, enter this command.

```
chg-appl-sock:sname=kchlr11201:open=no
```

When this command has successfully completed, the following message should appear.

```
rlghncxa03w 06-10-28 21:16:37 GMT EAGLE5 36.0.0
CHG-APPL-SOCK: MASP A - COMPLTD
```

3. Verify that the socket is not assigned to any routing keys by entering the `rtrv-appl-rtkey` command with the socket name (`sname`) being removed in this procedure and the `display=all` parameter. For this example, enter this command.

```
rtrv-appl-rtkey:sname=kchlr11201:display=all
```

The following is an example of the possible output.

```
rlghncxa03w 06-10-28 21:16:37 GMT EAGLE5 36.0.0
RCONTEXT  DPC          SI SSN OPC          CICS      CICE      LOC
-----  001-002-003    5 --- 100-100-100    1         50       STATIC

      ADPTR  TYPE      PSTNCAT  PSTNID  NORM  DUP
      TALI   FULL          0        0    N    N

      SNAMEs
      kchlr11201
```

```
STATIC Route Key table is ( 8 of 2000) 1% full
1105  Route Key table is ( 2 of 500) 1% full
1107  Route Key table is ( 2 of 500) 1% full

STATIC Route Key Socket Association table is (8 of 32000) 1% full
1105  Route Key Socket Association table is (2 of 8000) 1% full
1107  Route Key Socket Association table is (2 of 8000) 1% full
```

If the socket is assigned to any routing keys, perform the “Removing a Routing Key” procedure on page 3-272 and remove the socket from these routing keys.

-
- Remove the application socket from the database by entering the **dl t-appl-sock** command with the socket name being removed. For example, enter this command.

```
dl t-appl-sock:sname=kchlr11201
```

When this command has successfully completed, the following message should appear.

```
rlghncxa03w 06-10-28 21:17:37 GMT EAGLE5 36.0.0
DLT-APPL-SOCK: MASP A - COMPLTD
```

-
- Verify the new application socket information in the database by entering the **rtrv-appl-sock** command with the socket name specified in step 4. For this example, enter this command.

```
rtrv-appl-sock:sname=kchlr11201
```

The following is an example of the possible output.

```
rlghncxa03w 06-10-28 21:18:37 GMT EAGLE5 36.0.0

IP Appl Sock/Assoc table is (3 of 4000) 1% full
```

-
- Back up the new changes using the **chg-db:action=backup:dest=fixed** command. These messages should appear, the active Maintenance and Administration Subsystem Processor (MASP) appears first.

```
BACKUP (FIXED) : MASP A - Backup starts on active MASP.
BACKUP (FIXED) : MASP A - Backup on active MASP to fixed disk complete.
BACKUP (FIXED) : MASP A - Backup starts on standby MASP.
BACKUP (FIXED) : MASP A - Backup on standby MASP to fixed disk complete.
```

Flowchart 3-17. Removing an Application Socket

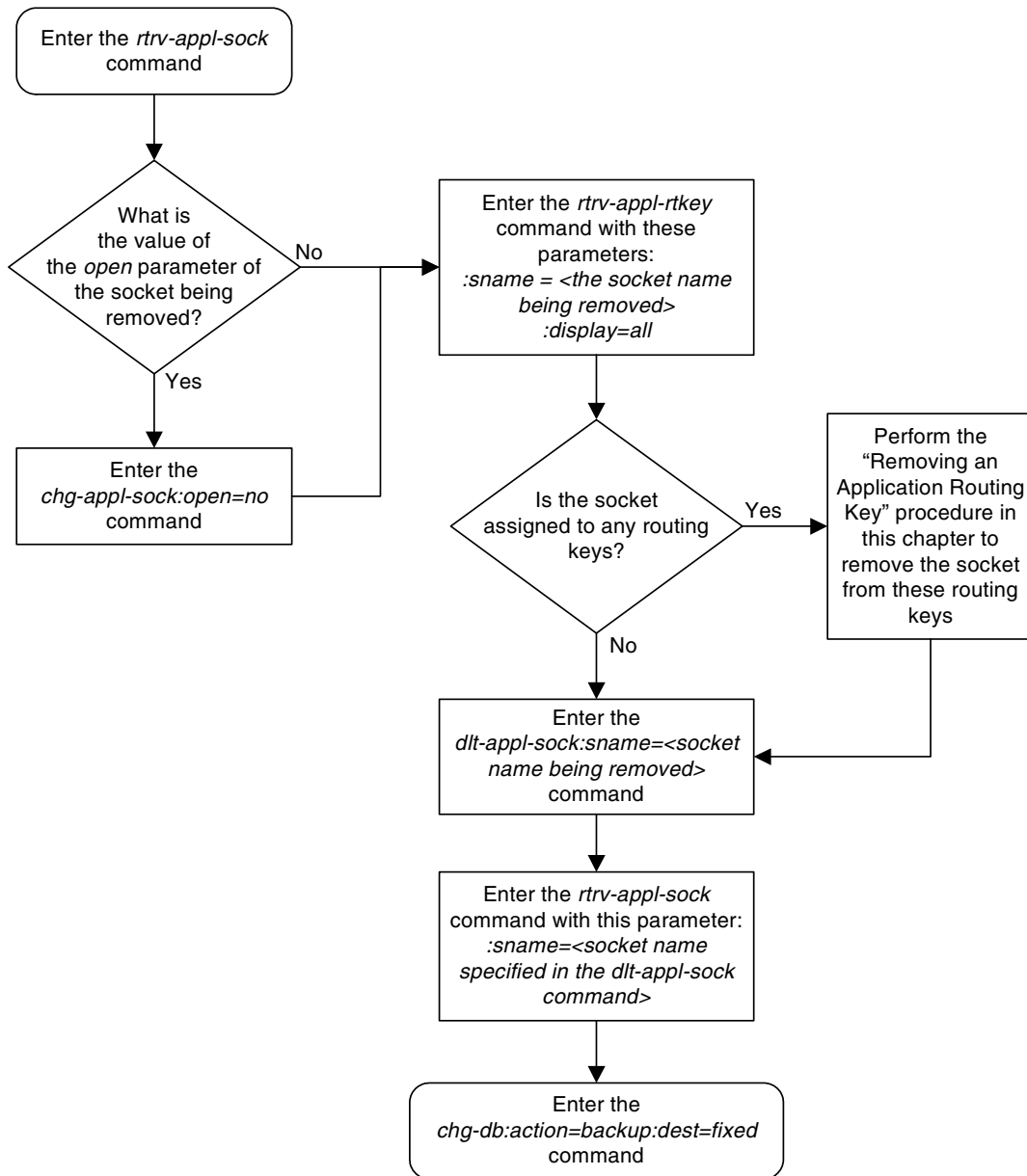

Changing an Application Socket

This procedure is used to change an application socket in the database using the **chg-appl-sock** command.

The **chg-appl-sock** command uses these parameters.

:sname – Socket Name.

:lhost – Local Hostname. The logical name assigned to the local host device. The local host name must be shown in the **LOCAL HOST** column of the **rtrv-ip-host** output. Local host names that contain dashes (-) must be enclosed in double quotes (“”).

:lport – The TCP port number for the Local host.

:rhost – Remote Hostname. The logical name assigned to the remote host device. The remote host name does not have to be shown in the **rtrv-ip-host** output. If remote host name is shown in the **rtrv-ip-host** output, it must be shown in the **REMOTE HOST** column of the **rtrv-ip-host** output. Remote host names that contain dashes (-) must be enclosed in double quotes (“”).

:rport – The TCP port number of the remote host.

:link – The signaling link on the IP card. If the card’s application is **iplim** or **iplimi**, and the card is a dual-slot DCM, the values for the **link** parameter can be only **a** or **b**. If the card’s application is **iplim** or **iplimi**, and the card is a single-slot EDCM, the values for the **link** parameter can be **a**, **a1**, **a2**, **a3**, **b**, **b1**, **b2**, or **b3**. If the IP card’s application is **ss7ipgw** or **ipgwi**, only **link=a** can be specified.

NOTE: The **port** parameter can be used in place of the **link** parameter to specify the signaling link on the card.

:server – Server Role. The role of the local socket in the Client/Server relationship.

:open – Socket State. Indicates to the connection manager software to open the socket if the socket is operational.

:alw – Connection State. Indicates to the connection manager software if the socket is allowed to carry SS7 traffic.

:dcmps – DCM Parameter Set. The DCM parameter set that will be used by the socket.

:rexit – Indicates the retransmission mode that the user wants the TCP stack to use for this socket.

:rtt – Indicates the measured or expected round trip time (RTT) of the socket in milliseconds.

For more information on the **rexit** and **rtt** parameters, go to the “Configuring IP Socket Retransmission Parameters” procedure on page 3-220.

NOTE: If the ITU National and International Spare Point Code Support feature is enabled, the socket cannot reference a card running the IPGWI application. Enter the `rtrv-ctrl-feat:partnum=893013601` command to verify whether or not the ITU National and International Spare Point Code Support feature is enabled. If the ITU National and International Spare Point Code Support feature is enabled, and the IP connection is being assigned to a card running the IPGWI application, the IP connection must be an IETF association. Perform the “Adding an Association” procedure on page 3-327 to add the IP connection to the database.

The `open` parameter must be set to `no` before changes can be made to `server`, `lhost`, `lport`, `rhost`, `rport`, `rta`, `rexmit`, and `link` parameters.

The `open` parameter must be changed with a separate `chg-appl-sock` command. The `open` parameter can not be on a command line that has `server`, `lhost`, `lport`, `rhost`, and `rport` parameters.

At least one optional parameter is required.

The maximum number of TALI sockets and SCTP association to application server assignments that can be hosted by an IPGWx card (referenced by the `lhost` parameter of the socket and association) is 50. For example, if the IPGWx card contains 22 SCTP association to application server assignments, the maximum number of TALI sockets the IPGWx card can support is 28. The SCTP association to application server assignments can be verified with the `rtrv-assoc:lhost=<local host name>` and `rtrv-as:aname=<association name>` commands.

Table 3-14. Examples of IPGWx Card Provisioning Limits

| Number of Associations hosted by the IPGWx card | Number of Application Servers each Association is Assigned to * | Number of TALI Sockets Hosted by the IPGWx card | Total Association - Application Server Assignments and TALI Sockets maintained by the IPGWx card |
|---|---|---|--|
| 1 | 50 | 0 | 50 |
| 50 | 1 | 0 | 50 |
| 25 | 1 | 25 | 50 |
| 25 | 2 | 0 | 50 |
| 0 | 0 | 50 | 50 |
| 22 | 1 | 28 | 50 |
| 11 | 2 | 28 | 50 |

* The EAGLE 5 ISS can contain a maximum of 250 application servers.

For the `iplim` and `iplimi` applications, each IP card can have one socket for each signaling link assigned to the card. Dual-slot DCMs can have a maximum of two sockets. Single-slot EDCM cards can have a maximum of eight sockets.

The EAGLE 5 ISS can contain a maximum of 4000 connections (association to application server assignments plus sockets).

The value of the **lhost** and **rhost** parameters is a text string of up to 60 characters, with the first character being a letter.

The command input is limited to 150 characters, including the hostname.

To set the **open** parameter value to **yes**, the socket specified by the **sname** parameter must contain values for the **lhost**, **lport**, **rhost**, and **rport** parameters.

The **rtt** parameter cannot be specified with the **rexmit=bsd** parameter.

When the **rexmit=fixed** or **rexmit=mod** parameters are specified, the **rtt** parameter must be specified.

The IP address of the local host (**lhost** parameter) must be shown in the **rtrv-ip-lnk** output.

If the card's application is either IPLIM or IPLIMI:

- The **iplim12** parameter value of the signaling link assigned to the socket must be **saaltali**.
- The signaling link being assigned to the socket must be out of service. This state is shown in the **rept-stat-slk** output with the entries **OOS-MT** in the **PST** field and **Unavail** in the **SST** field.
- If the socket is being opened in this procedure with the **chg-appl-sock** command and the **open=yes** parameter, the signaling link assigned to the socket must be in the database and the **iplim12** parameter value of the signaling link assigned to the socket must be **saaltali**.

If the card's application is either SS7IPGW or IPGWI, the signaling link being assigned to the socket must be in service. This state is shown in the **rept-stat-slk** output with the entries **IS-NR** in the **PST** field and **Avail** in the **SST** field.

The B Ethernet interface of the IP card can be used only if the IP card is a single-slot EDCM.

If the socket being changed is a client socket, shown in the **rtrv-appl-sock** output with the entry **NO** in the **SERVER** field, the socket's **lhost** and **lport** values cannot match the values of any open socket.

If the socket being changed is a server socket, shown in the **rtrv-appl-sock** output with the entry **YES** in the **SERVER** field, the socket's **lhost** and **lport** values cannot match the values of any open client socket.

Canceling the RTRV-APPL-SOCK Command

Because the `rtrv-appl-sock` command used in this procedure can output information for a long period of time, the `rtrv-appl-sock` command can be canceled and the output to the terminal stopped. There are three ways that the `rtrv-appl-sock` command can be canceled.

- Press the **F9** function key on the keyboard at the terminal where the `rtrv-appl-sock` command was entered.
- Enter the `canc-cmd` without the `trm` parameter at the terminal where the `rtrv-appl-sock` command was entered.
- Enter the `canc-cmd:trm=<xx>`, where `<xx>` is the terminal where the `rtrv-appl-sock` command was entered, from another terminal other than the terminal where the `rtrv-appl-sock` command was entered. To enter the `canc-cmd:trm=<xx>` command, the terminal must allow Security Administration commands to be entered from it and the user must be allowed to enter Security Administration commands. The terminal's permissions can be verified with the `rtrv-secu-trm` command. The user's permissions can be verified with the `rtrv-user` or `rtrv-secu-user` commands.

For more information about the `canc-cmd` command, go to the *Commands Manual*.

Procedure

1. Display the current application socket information in the database by entering the `rtrv-appl-sock` command. The following is an example of the possible output.

```
rlghncxa03w 06-10-28 21:15:37 GMT EAGLE5 36.0.0
SNAME kchlr11201
  LINK      A
  LHOST     ipnode1-1201
  RHOST     kc-hlr1
  LPORT     7000          RPORT      7000
  SERVER    YES          DCMPMS      1
  REXMIT    FIXED       RTT         60
  OPEN      YES          ALW         NO

SNAME kchlr11203
  LINK      A
  LHOST     ipnode1-1203
  RHOST     kc-hlr1
  LPORT     7005          RPORT      7005
  SERVER    YES          DCMPMS     10
  REXMIT    FIXED       RTT         60
  OPEN      YES          ALW         NO

SNAME sock1
  LINK      A
  LHOST     IPNODE2-1205
  RHOST     remotehost1
  LPORT     1024          RPORT      2048
  SERVER    YES          DCMPMS     10
  REXMIT    FIXED       RTT         60
  OPEN      YES          ALW         YES
```

```

SNAME sock2
  LINK      A
  LHOST     IPNODE2-1205
  RHOST     remotehost2
  LPORT     2000          RPORT     2000
  SERVER    YES           DCMP5     10
  REXMIT    FIXED        RTT         60
  OPEN      YES           ALW         YES

```

IP Appl Sock/Assoc table is (7 of 4000) 1% full

NOTE: To change the values of these parameters: `server`, `lhost`, `lport`, `rhost` `link`, `rtt`, `rexmit`, or `rport`, the value of the `open` parameter must be `no`. If the values of any of these parameters are being changed and the `open` parameter value for the socket being changed is `no`, skip this step and go to step 3.

NOTE: If only the values of the `alw`, `open`, or `dcmps` parameters are being changed, skip steps 2 through 14, and go to step 15.

- Change the value of the `open` parameter to `no` using the `chg-appl-sock` command with the `open=no` parameter. For example, enter this command.

```
chg-appl-sock:sname=kchlr11201:open=no
```

When this command has successfully completed, the following message should appear.

```

rlghncxa03w 06-10-28 21:16:37 GMT EAGLE5 36.0.0
CHG-APPL-SOCK: MASP A - COMPLTD

```

NOTE: If the local host name or the `link` value of the socket are not being changed, skip steps 3 through 14, and go to step 15.

- Verify that the local host name to be assigned to the socket is in the database by using the `rtrv-ip-host` command. The following is an example of the possible output.

```

rlghncxa03w 06-10-28 21:15:37 GMT EAGLE5 36.0.0

LOCAL IPADDR   LOCAL HOST
192.1.1.10     IPNODE1-1201
192.1.1.12     IPNODE1-1203
192.1.1.14     IPNODE1-1205
192.1.1.20     IPNODE2-1201
192.1.1.22     IPNODE2-1203
192.1.1.24     IPNODE2-1205
192.1.1.30     KC-HLR1
192.1.1.32     KC-HLR2
192.1.1.50     DN-MS1
192.1.1.52     DN-MS2

REMOTE IPADDR  REMOTE HOST
150.1.1.5      NCDEPTECONOMIC_DEVELOPMENT.SOUTHEASTERN_COORIDOR_ASHVL.GOV

```

IP Host table is (11 of 512) 2% full

4. Display the IP links in the database by entering the `rtrv-ip-lnk` command. The following is an example of the possible output.

```
rlghncxa03w 06-10-28 21:19:37 GMT EAGLE5 36.0.0
LOC  PORT  IPADDR          SUBMASK          DUPLEX  SPEED  MACTYPE  AUTO  MCAST
1201 A    192.1.1.10      255.255.255.0   ----   ---   DIX      YES  NO
1203 A    192.1.1.12      255.255.255.0   ----   ---   DIX      YES  NO
1205 A    192.1.1.14      255.255.255.0   FULL   100   DIX      NO   NO
```

5. Display the signaling link referenced by the IP link that will be assigned to the socket by entering the `rtrv-slk` command and specifying the location of the IP link. For this example, enter this command.

```
rtrv-slk:loc=1201
```

This is an example of the possible output.

```
rlghncxa03w 06-10-19 21:17:04 GMT EAGLE5 36.0.0
LOC  LINK LSN          SLC TYPE  IPLIML2
1203 A    e5e6a      1  IPLIM  SAALTALI
```

If the required signaling link is in the database, and the card's application (shown in the **TYPE** column) is either SS7IPGW, IPLIM, or IPLIMI, skip step 6 and go to step 7.

If the card's application is IPGWI or if the required signaling link is not in the database, go to step 6.

6. Display the status of the ITU National and International Spare Point Code Support feature by entering the `rtrv-ctrl-feat` command with the ITU National and International Spare Point Code Support feature part number. Enter this command.

```
rtrv-ctrl-feat:partnum=893013601
```

The following is an example of the possible output.

```
rlghncxa03w 06-10-28 21:15:37 GMT EAGLE5 36.0.0
The following features have been permanently enabled:
```

| Feature Name | Partnum | Status | Quantity |
|--------------------------|-----------|--------|----------|
| Spare Point Code Support | 893013601 | on | ---- |

The following features have been temporarily enabled:

| Feature Name | Partnum | Status | Quantity | Trial Period Left |
|---------------------|---------|--------|----------|-------------------|
| Zero entries found. | | | | |

The following features have expired temporary keys:

| Feature Name | Partnum |
|---------------------|---------|
| Zero entries found. | |

If the ITU National and International Spare Point Code Support feature is not enabled, and the required signaling link is not in the database, perform the "Adding an IP Signaling Link" procedure on page 3-84. After the signaling link has been added, go to step 7.

If the ITU National and International Spare Point Code Support feature is enabled, and the card's application is IPGWI, the IP connection must be assigned to an IETF association, or if the IP connection is to remain assigned to a socket, the socket must be assigned to a card running the SS7IPGW, IPLIM, or IPLIMI applications. If the IP connection is to remain a socket, perform the "Adding an IP Signaling Link" procedure on page 3-84 to add the required signaling link. The signaling link cannot be assigned to a card running the IPGWI applications. After the signaling link has been added, go to step 7.

If the IP connection is to be an association, perform the "Adding an Association" procedure on page 3-327 to add the IP connection to the database. The remainder of this procedure cannot be performed.

NOTE: If the required IP link information is shown in the `rtrv-ip-lnk` output in step 4, skip this step and go to step 8.

7. Add the IP address of the IP link by performing the "Changing an IP Link" procedure on page 3-135.

NOTE: If the local host name of the socket is not being changed, skip steps 8, 9, 10, and 11, and go to step 12.

NOTE: If the new local host name is shown in the `rtrv-ip-host` output in step 3, skip this step and go to step 9.

8. Add the new local host name and IP address from step 7 by performing the "Adding an IP Host" procedure on page 3-153.

NOTE: If the card's application is IPLIM or IPLIMI, shown in the TYPE column in the `rtrv-slk` output in step 5, or if the local host value being used in this procedure was configured with the "Adding an IP Host" procedure on page 3-153 in step 8, skip steps 9, 10, and 11, and go to step 12.

9. Display the sockets assigned to the local host that will be assigned to the socket being configured in this procedure by entering the `rtrv-appl-sock` command with the `lhost` parameter. For this example, enter this command.

```
rtrv-appl-sock:lhost=IPNODE2-1205
```

This is an example of the possible output.

```
rlghncxa03w 06-10-28 21:14:37 GMT EAGLE5 36.0.0
SNAME sock1
  LINK      A
  LHOST     IPNODE2-1205
  RHOST     remotehost1
  LPORT     1024          RPORT     2048
  SERVER    YES          DCMPS     10
  REXMIT    FIXED        RTT       60
  OPEN      YES          ALW       YES
```

```
SNAME sock2
LINK A
LHOST IPNODE2-1205
RHOST remotehost2
LPORT 2000 RPORT 2000
SERVER YES DCMPS 10
REXMIT FIXED RTT 60
OPEN YES ALW YES
```

IP Appl Sock/Assoc table is (5 of 4000) 1% full

10. Display the associations assigned to the local host that will be assigned to the socket being configured in this procedure by entering the **rtrv-*assoc*** command with the **lhost** parameter. For this example, enter this command.

rtrv-*assoc*:lhost=IPNODE2-1205

This is an example of the possible output.

```
rlghncxa03w 06-10-28 21:14:37 GMT EAGLE5 36.0.0
CARD IPLNK
ANAME LOC PORT LINK ADAPTER LPORT RPORT OPEN ALW
assoc1 1205 A A M3UA 2048 2048 YES YES
assoc2 1205 A A SUA 3000 3000 YES YES
```

IP Appl Sock/Assoc table is (5 of 4000) 1% full
 Assoc Buffer Space Used (32 KB of 3200 KB) on LOC = 1205

11. Display the application servers that the associations shown in step 10 are assigned to by entering **rtrv-*as*** command with the names of the associations shown in step 10. For this example, enter these commands.

rtrv-*as*:aname=assoc1

This is an example of the possible output.

```
rlghncxa03w 06-10-28 21:14:37 GMT EAGLE5 36.0.0
AS Name Mode Tr ms Association Names
as1 LOADSHARE 2000 assoc1

as4 LOADSHARE 2000 assoc1

as6 LOADSHARE 2000 assoc1
```

AS Table is (6 of 250) 1% full

rtrv-*as*:aname=assoc2

This is an example of the possible output.

```
rlghncxa03w 06-10-28 21:14:37 GMT EAGLE5 36.0.0
AS Name Mode Tr ms Association Names
as2 LOADSHARE 2000 assoc2

as3 LOADSHARE 2000 assoc2

as5 LOADSHARE 2000 assoc2
```

AS Table is (6 of 250) 2% full

The maximum number of TALI sockets and SCTP association to application server assignments that can be hosted by an IPGWx card (referenced by the **lhost** parameter of the socket and association) is 50.

If the number of TALI sockets and SCTP association to application server assignments is less than 50, go to step 12.

If the number of TALI sockets and SCTP association to application server assignments is 50, the local host value cannot be used in this procedure.

Repeat steps 3 and 4 and select another IP link and IP host to use in this procedure or add a new IP link using the “Changing an IP Link” procedure on page 3-135. After the new IP link is added, perform the “Adding an IP Host” procedure on page 3-153 to assign this IP address to a new local host name. After the new local host name as been added, go to step 12.

NOTE: If the card’s application is SS7IPGW or IPGWI, shown in the APPL column in the `rtrv-slk` output in step 5, skip steps 12, 13, 14, and 15, and go to step 16.

12. Display the signaling link referenced by the IP link that will be assigned to the socket by entering the `rtrv-slk` command and specifying the card location and signaling link shown in step 5. For this example, enter this command.

```
rtrv-slk:loc=1201:link=a
```

This is an example of the possible output.

```
rlghncxa03w 06-10-19 21:17:04 GMT EAGLE5 36.0.0
LOC  LINK LSN          SLC TYPE   IPLIML2
1203 A    e5e6a          1 IPLIM    SAALTALI
```

When the IP card’s application is either IPLIM or IPLIMI, the `ipliml2` parameter value for the signaling link assigned to the socket must be `saaltali`. If the `ipliml2` parameter is not `saaltali`, remove the signaling link using the “Removing an IP Signaling Link” procedure on page 3-113. Add the signaling link back into the database with the `ipliml2=saaltali` parameter, and without activating the signaling link, using the “Adding an IP Signaling Link” procedure on page 3-84.

NOTE: If the “Adding an IP Signaling Link” procedure on page 3-84 was not performed in step 6 or 12, skip steps 13, 14, and 15, and go to step 16.

13. Display the status of the signaling link shown in step 6 using the `rept-stat-slk` command specifying the card location and signaling link. For example, enter this command.

```
rept-stat-slk:loc=1203:link=a
```

This is an example of the possible output.

```
rlghncxa03w 06-10-28 21:16:37 GMT EAGLE5 36.0.0
SLK  LSN          CLLI      PST      SST      AST
1203,A  e5e6a      ----- IS-NR      Avail     ----
Command Completed.
```

NOTE: If the primary state (PST) of the signaling link is `OOS-MT` and the secondary state (SST) is `Unavail`, skip steps 14 and 15, and go to step 16.

- 14 Deactivate the signaling link from step 13 using the `act-slk` command. For example, enter this command.

```
dact-slk:loc=1203:link=a
```

When this command has successfully completed, the following message should appear.

```
rlghncxa03w 06-10-07 11:11:28 GMT EAGLE5 36.0.0
Deactivate Link message sent to card
```

15. Verify the status of the signaling link using the `rept-stat-slk` command. For example, enter this command.

```
rept-stat-slk:loc=1203:link=a
```

This is an example of the possible output.

```
rlghncxa03w 06-10-28 21:16:37 GMT EAGLE5 36.0.0
SLK      LSN      CLLI      PST      SST      AST
1203,A  e5e6a    -----  OOS-MT   Unavail  ----
Command Completed.
```

16. Change the application socket by using the `chg-appl-sock` command with this mandatory parameter:

:sname = the socket name

and with at least one of these optional parameters:

:lhost = the local host name from steps 3 or 8

:lport = the local port ID, from 1024 to 65535

:rhost = the remote host name

:rport = the remote port ID, from 1024 to 65535

:link = the signaling link value from step 13.

NOTE: The `port` parameter can be used in place of the `link` parameter to specify the signaling link on the card.

NOTE: See Flowchart 3-18 on page 3-219 (Sheet 7) for the rules that apply to the `chg-appl-sock` command.

For example, enter this command.

```
chg-appl-sock:sname=kchlrl1201:rhost="kc-kc-kc":alw=yes
```

When this command has successfully completed, the following message should appear.

```
rlghncxa03w 06-10-28 21:17:37 GMT EAGLE5 36.0.0
CHG-APPL-SOCK: MASP A - COMPLTD
```

NOTE: If step 2 was not performed in this procedure, skip step 17 and go to step 18.

17. Change the **open** parameter value back to **yes** by using the **chg-appl-sock** command. For example, enter this command.

```
chg-appl-sock:sname=kchlr11201:open=yes
```

When this command has successfully completed, the following message should appear.

```
rlghncxa03w 06-10-28 21:18:37 GMT EAGLE5 36.0.0
CHG-APPL-SOCK: MASP A - COMPLTD
```

NOTE: If the card's application is **SS7IPGW** or **IPGWI**, skip steps 18 and 19, and go to step 20.

- 18 Activate the signaling link assigned to the socket using the **act-slk** command. For example, enter this command.

```
act-slk:loc=1203:link=a
```

When this command has successfully completed, the following message should appear.

```
rlghncxa03w 06-10-07 11:11:28 GMT EAGLE5 36.0.0
Activate Link message sent to card
```

19. Verify the status of the signaling link using the **rept-stat-slk** command. For example, enter this command.

```
rept-stat-slk:loc=1203:link=a
```

This is an example of the possible output.

```
rlghncxa03w 06-10-28 21:16:37 GMT EAGLE5 36.0.0
SLK      LSN      CLLI      PST      SST      AST
1203,A   e5e6a    -----  IS-NR    Avail    ----
Command Completed.
```

20. Verify the new application socket information in the database by entering the **rtrv-appl-sock** command with the socket name specified in step 16. For this example, enter this command.

```
rtrv-appl-sock:sname=kchlr11201
```

The following is an example of the possible output.

```
rlghncxa03w 06-10-28 21:15:37 GMT EAGLE5 36.0.0
SNAME kchlr11201
LINK   A
LHOST  ipnode1-1201
RHOST  kc-kc-kc
LPORT  7000          RPORT  7000
SERVER YES        DCMPS  1
REXMIT FIXED    RTT    60
OPEN   YES        ALW    YES

IP Appl Sock/Assoc table is (3 of 4000) 1% full
```

21. Back up the new changes using the `chg-db:action=backup:dest=fixed` command. These messages should appear, the active Maintenance and Administration Subsystem Processor (MASP) appears first.

```

BACKUP (FIXED) : MASP A - Backup starts on active MASP.
BACKUP (FIXED) : MASP A - Backup on active MASP to fixed disk complete.
BACKUP (FIXED) : MASP A - Backup starts on standby MASP.
BACKUP (FIXED) : MASP A - Backup on standby MASP to fixed disk complete.
    
```

Flowchart 3-18. Changing an Application Socket (Sheet 1 of 7)

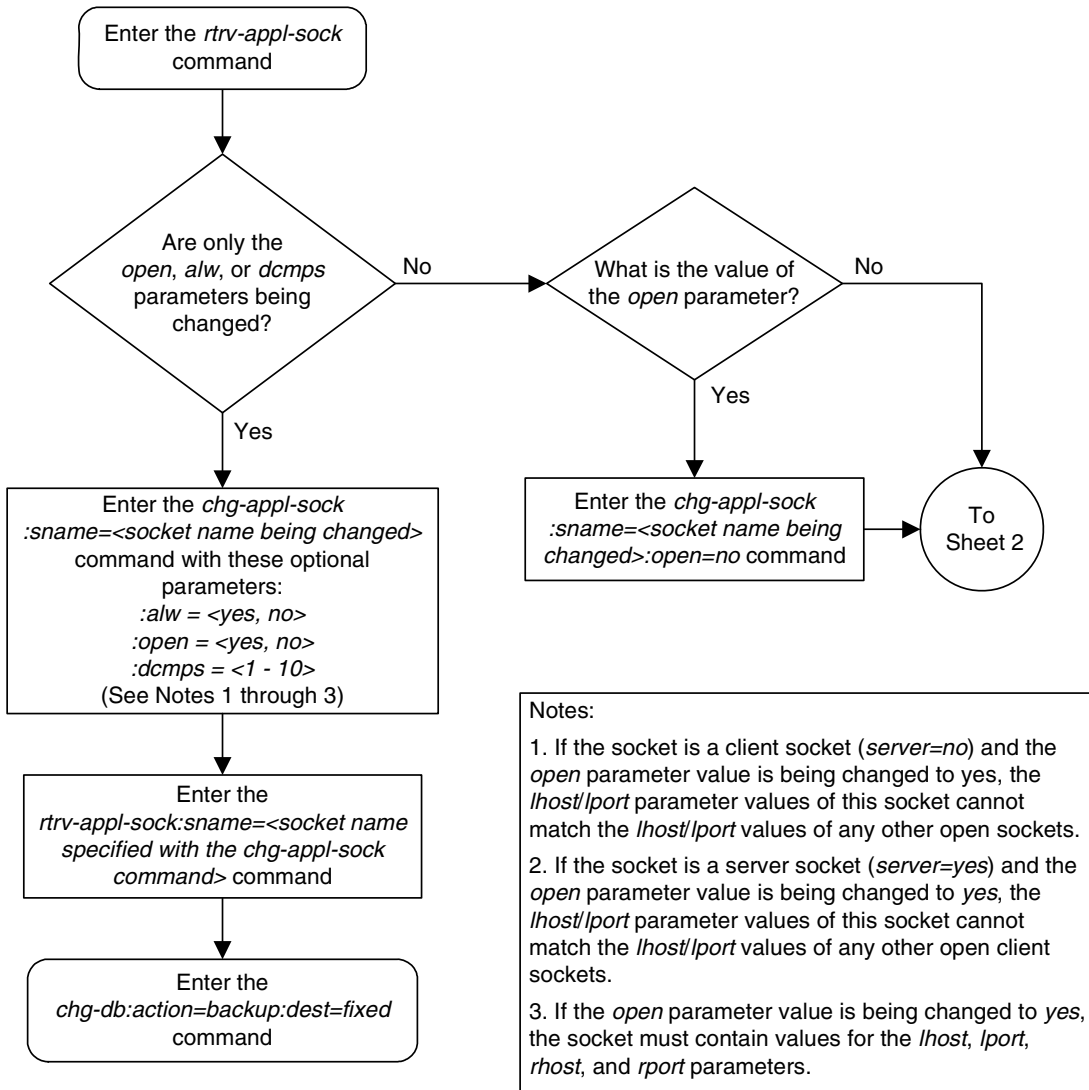

Flowchart 3-18. Changing an Application Socket (Sheet 2 of 7)

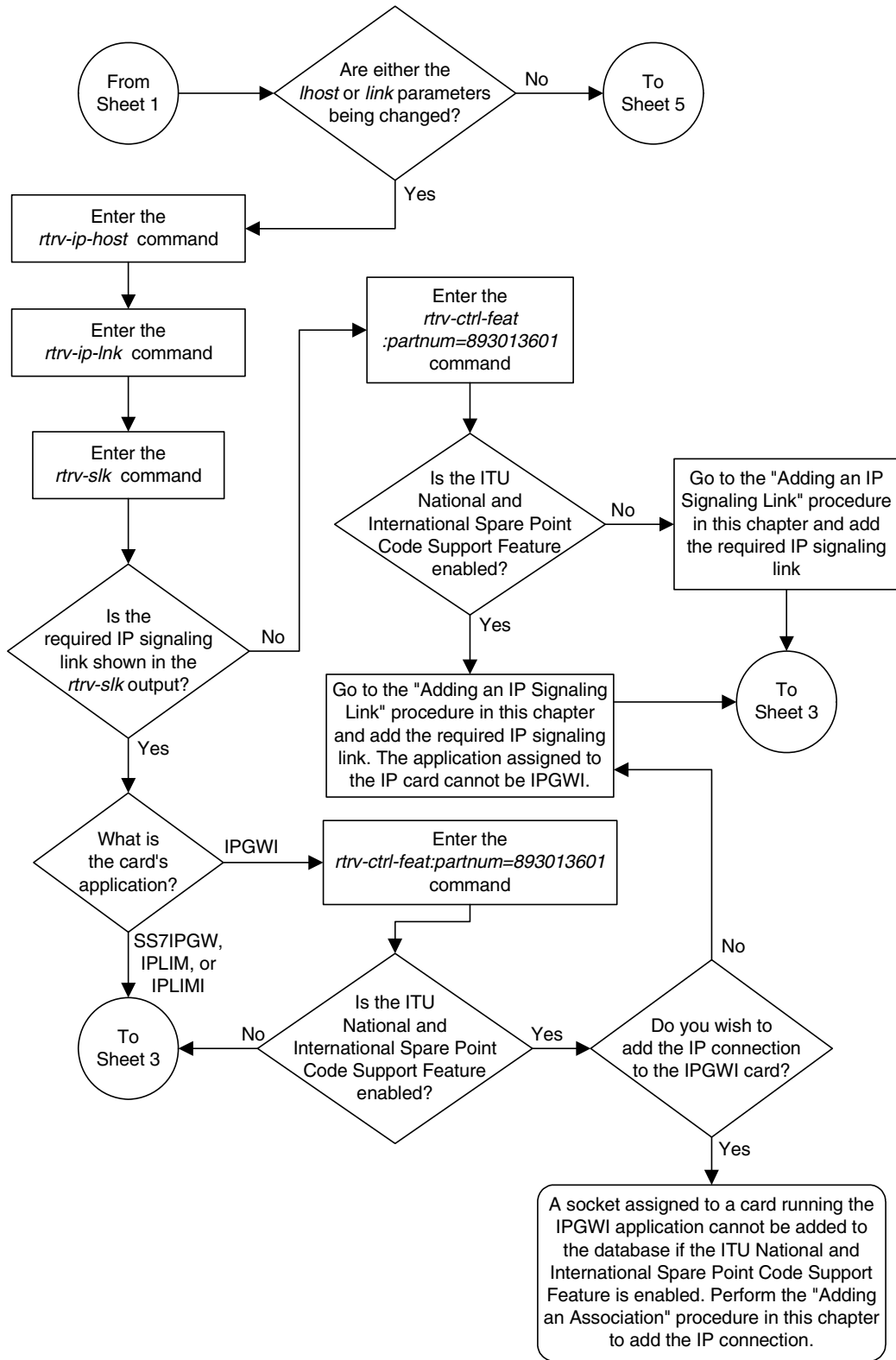

Flowchart 3-18. Changing an Application Socket (Sheet 3 of 7)

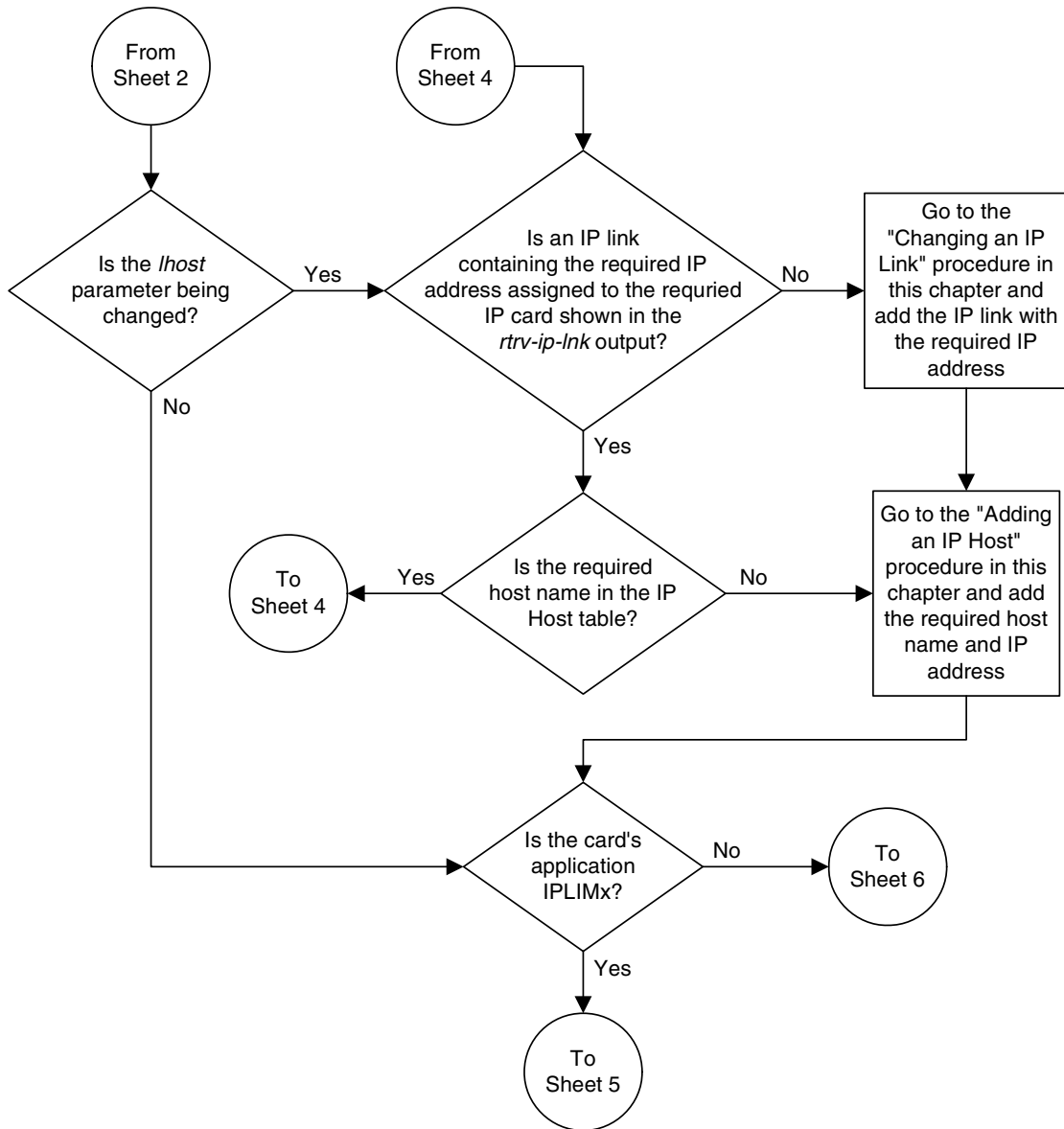

Flowchart 3-18. Changing an Application Socket (Sheet 4 of 7)

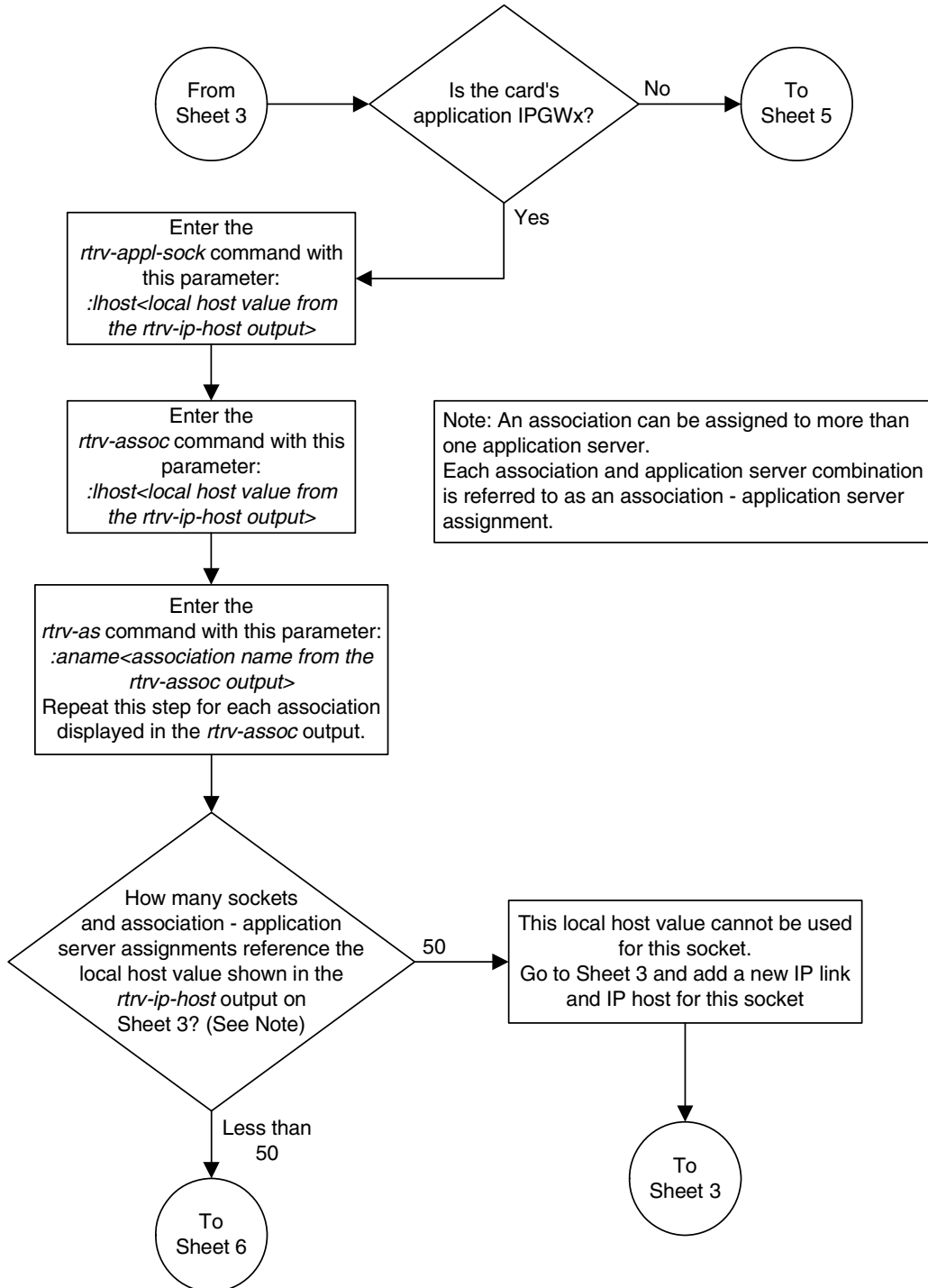

Flowchart 3-18. Changing an Application Socket (Sheet 5 of 7)

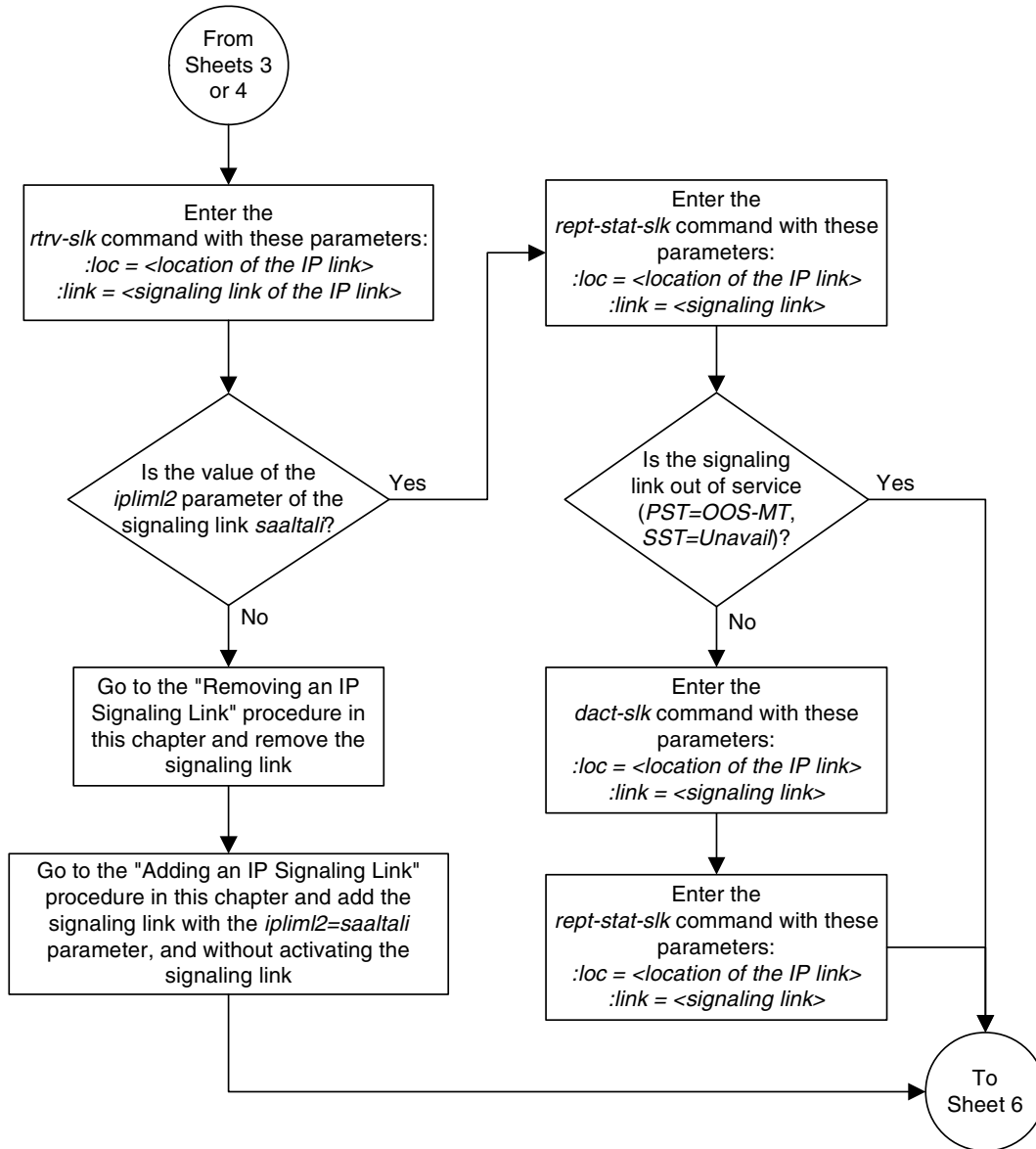

Flowchart 3-18. Changing an Application Socket (Sheet 6 of 7)

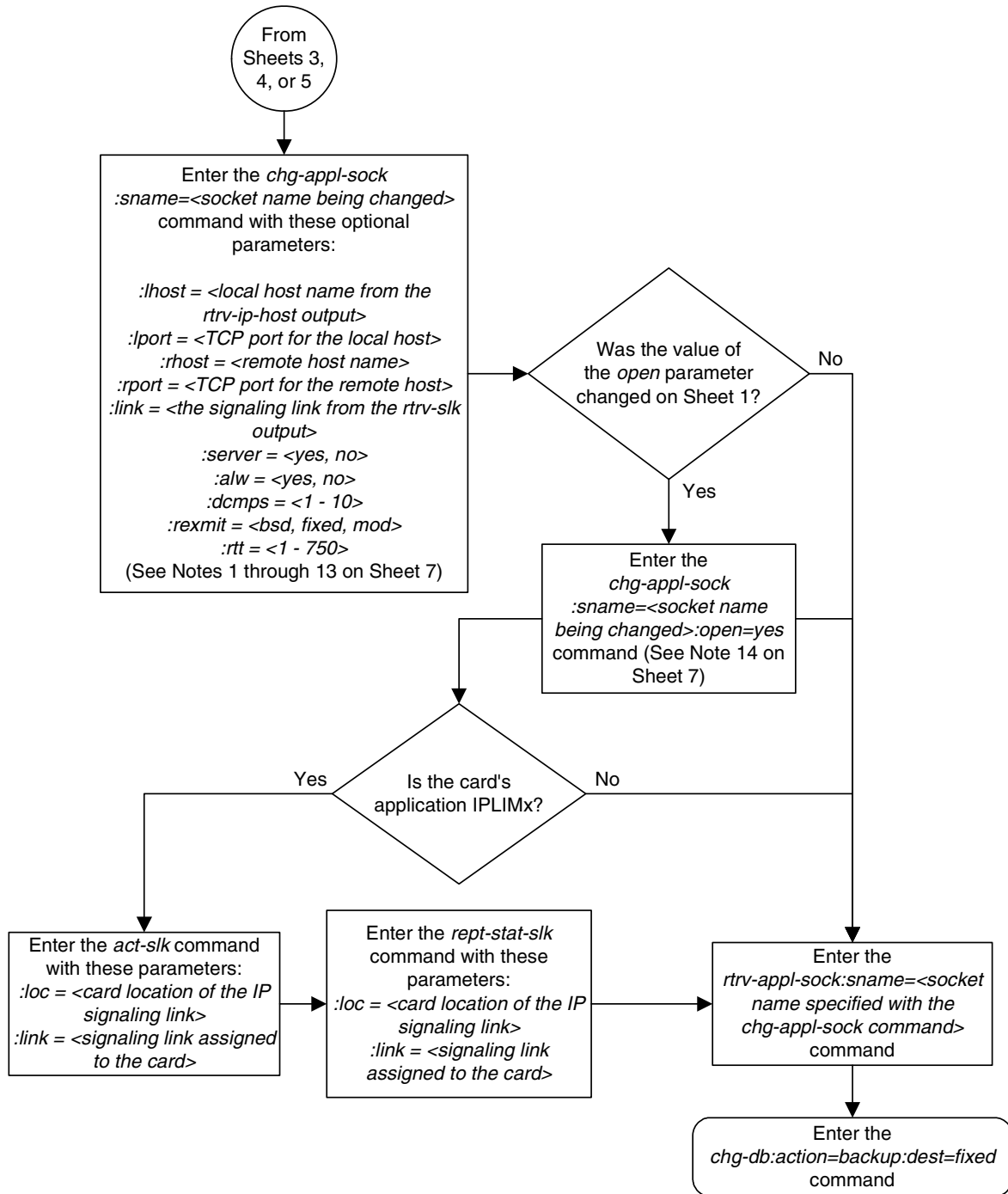

Flowchart 3-18. Changing an Application Socket (Sheet 7 of 7)

Notes:

1. If the card containing the signaling link is a DCM, the B Ethernet interface cannot be used. Single-slot EDCMs can use the B Ethernet interface.
2. The sum of the number of sockets and association – application server assignments on a card running either the *ss7ipgw* or *ipgwi* applications cannot exceed 50.
3. The EAGLE 5 ISS can contain a maximum of 4000 connections (association – application server assignments plus sockets).
4. Cards running either the *iplim* or *iplimi* applications can have only one connection for each signaling link and a maximum of two connections for each card, if the card is a dual-slot DCM. If the card is a single-slot EDCM, the card may contain a maximum of eight connections.
5. The value of the *lhost* and *rhost* parameters is a text string of up to 60 characters, with the first character being a letter.
6. If the socket is a client socket (*server=no*) and the *open* parameter value is being changed to *yes*, the *lhost/lport* parameter values of this socket cannot match the *lhost/lport* values of any other open sockets.
7. If the socket is a server socket (*server=yes*) and the *open* parameter value is being changed to *yes*, the *lhost/lport* parameter values of this socket cannot match the *lhost/lport* values of any other open client sockets.
8. The *rtt* parameter cannot be specified with the *rexmit=bsd* parameter.
9. When the *rexmit=fixed* or *rexmit=mod* parameters are specified, the *rtt* parameter must be specified.
10. The local host name must be shown in the *rtrv-ip-host* output in the *LOCAL HOST* column.
11. The remote host name does not have to be shown in the *rtrv-ip-host* output. If the remote host name is shown in the *rtrv-ip-host* output, it must be shown in the *REMOTE HOST* column.
12. Host names (local and remote) that contain dashes (-) must be enclosed in double quotes (“”).
13. The *port* parameter can be used in place of the *link* parameter to specify the signaling link assigned to the socket.
14. If the *open* parameter value is being changed to *yes*, the socket must contain values for the *lhost*, *lport*, *rhost*, and *rport* parameters.

Configuring IP Socket Retransmission Parameters

This procedure is used to configure the retransmission parameters for sockets using the `rexmit` and `rtt` parameters of the `chg-app1-sock` command.

`:rexmit` – Indicates the retransmission mode that the user wants the TCP stack to use for a socket. Possible values are `bsd` (standard), `fixed` (Tekelec version), or `mod` (combination of `bsd` and `fixed`). The default value is `fixed`.

`:rtt` – Indicates the measured or expected round trip time of the socket in milliseconds. Be aware that you are entering the round trip time, not the retransmission timeout that will be used for the socket. The initial retransmission timeout that is actually applied to the socket will be the next 125 millisecond increment above the entered round trip time. The default value is 60.

It is important to set the configured round trip time as accurately as possible. When the round trip time is configured too low, network congestion can occur, thus delaying (or preventing) the delivery of SS7 data, resulting in a negative impact on MSU throughput. If the round trip time is set too high, the TCP protocol layer may act unpredictably, resulting in the SS7 service being degraded. The MSU throughput would be lowered, possibly affecting the client application software. When the round trip time is configured correctly, the TCP network can deliver SS7 data in a timely manner with little or no network congestion.

The “Changing an Application Socket” procedure on page 3-202 is used to change the values of these parameters. In addition to using the “Changing an Application Socket” procedure, these pass commands are also used in this procedure.

- `ping` – tests for the presence of hosts on the network.
- `sockrtt` – displays the round trip time data
- `netstat -p tcp` – determines if retransmissions have occurred.

For more information of the `pass` commands, go to the *Commands Manual*.

The `rexmit` and `rtt` parameter values are set using the data collected from the `pass` commands.

The `rtt` parameter cannot be specified with the `rexmit=bsd` parameter.

When the `rexmit=fixed` or `rexmit=mod` parameters are specified, the `rtt` parameter must be specified.

Canceling the RTRV-APPL-SOCK Command

Because the `rtrv-app1-sock` command used in this procedure can output information for a long period of time, the `rtrv-app1-sock` command can be

canceled and the output to the terminal stopped. There are three ways that the `rtrv-appl-sock` command can be canceled.

- Press the **F9** function key on the keyboard at the terminal where the `rtrv-appl-sock` command was entered.
- Enter the `canc-cmd` without the `trm` parameter at the terminal where the `rtrv-appl-sock` command was entered.
- Enter the `canc-cmd:trm=<xx>`, where `<xx>` is the terminal where the `rtrv-appl-sock` command was entered, from another terminal other than the terminal where the `rtrv-appl-sock` command was entered. To enter the `canc-cmd:trm=<xx>` command, the terminal must allow Security Administration commands to be entered from it and the user must be allowed to enter Security Administration commands. The terminal's permissions can be verified with the `rtrv-secu-trm` command. The user's permissions can be verified with the `rtrv-user` or `rtrv-secu-user` commands.

For more information about the `canc-cmd` command, go to the *Commands Manual*.

Procedure

1. Display the current application socket information in the database by entering the `rtrv-appl-sock` command. The following is an example of the possible output.

```
rlghncxa03w 06-10-28 21:15:37 GMT EAGLE5 36.0.0
SNAME kchlr11201
  LINK  A
  LHOST ipnode1-1201
  RHOST kc-hlr1
  LPORT 7000          RPORT 7000
  SERVER YES         DCMP5 1
  REXMIT FIXED      RTT 60
  OPEN  YES         ALW  NO

SNAME kchlr11203
  LINK  A
  LHOST ipnode1-1203
  RHOST kc-hlr1
  LPORT 7005          RPORT 7005
  SERVER YES         DCMP5 10
  REXMIT FIXED      RTT 60
  OPEN  YES         ALW  YES

IP Appl Sock/Assoc table is (3 of 4000) 1% full
```

2. Display the IP address assigned to the remote host that will be pinged in step 4 using the `rtrv-ip-host` command with the remote host name shown in step 1. For this example, enter this command.

```
rtrv-ip-host:host="kc-hlr1"
```

The following is an example of the possible output

```
rlghncxa03w 06-10-28 21:15:37 GMT EAGLE5 36.0.0
```

```
LOCAL IPADDR    LOCAL HOST
192.1.1.30      KC-HLR1
```

```
IP Host table is (11 of 512) 2% full
```

3. Display the IP links assigned to the IP address shown in step 2 by entering the `rtrv-ip-lnk` command. The following is an example of the possible output.

```
rlghncxa03w 06-10-28 21:19:37 GMT EAGLE5 36.0.0
LOC  PORT IPADDR          SUBMASK          DUPLEX  SPEED  MACTYPE AUTO MCAST
1201 A    192.1.1.30          255.255.255.0   ----   ---   DIX     YES  NO
1203 A    192.1.1.12         255.255.255.0   ----   ---   DIX     YES  NO
1205 A    192.1.1.14         255.255.255.0   FULL   100   DIX     NO   NO
```

4. Using the outputs of steps 1 through 3 as a guide, enter the `pass:cmd="ping"` command specifying the card and the host name of the remote host. This command is entered several times to obtain the average round trip time. For this example, enter this command.

```
pass:loc=1201:cmd="ping kc-hlr1"
```

The following is an example of the possible output

```
rlghncxa03w 06-10-28 21:15:37 GMT EAGLE5 36.0.0
PASS: Command sent to card
```

```
rlghncxa03w 06-10-28 21:15:37 GMT EAGLE5 36.0.0
PING command in progress
```

```
rlghncxa03w 06-10-28 21:15:37 GMT EAGLE5 36.0.0
PING kc-hlr1 (192.1.1.30): 56 data bytes
64 bytes from tekral.nc.tekelec.com (192.1.1.30): icmp_seq=0. time=5. ms
64 bytes from tekral.nc.tekelec.com (192.1.1.30): icmp_seq=1. time=9. ms
64 bytes from tekral.nc.tekelec.com (192.1.1.30): icmp_seq=2. time=14. ms
----tekral PING Statistics----
3 packets transmitted, 3 packets received, 0% packet loss
round-trip (ms)  min/avg/max = 5/9/14
```

```
PING command complete
```

5. Go to the "Changing an Application Socket" procedure on page 3-202 and change the retransmission parameters (`rtt` and `rexit`) of the socket based on the results of pinging the remote host in step 4.
-

6. A TALI monitor (MONI) message is sent to the remote host.
-

7. Enter the `pass:cmd="sockrtd"` command to display the round trip time data collected during the sending of the TALI monitor acknowledgement (MONA) message. For this example, enter this command.

```
pass:loc=1201:cmd="sockrtd kc-hlr1"
```

The following is an example of the possible output

```
rlghncxa03w 06-10-28 21:15:37 GMT EAGLE5 36.0.0
PASS: Command sent to card

rlghncxa03w 06-10-28 21:15:37 GMT EAGLE5 36.0.0

SOCKRTT: Socket round-trip time report (in milliseconds)

Configured Traffic Round-Trip Time
Retransmission Mode           : MOD
Fixed Round Trip Time         : 250

Measured Normal Traffic Round-Trip Times

    Minimum round-trip time      : 5
    Maximum round-trip time      : 195
    Weighted Average round-trip time : 10
    Last recorded round-trip time  : 10

Measured Congested Traffic Round-Trip Times

    Minimum round-trip time      : 0
    Maximum round-trip time      : 0
    Weighted Average round-trip time : 0
    Last recorded round-trip time  : 0

rlghncxa03w 06-10-28 21:15:37 GMT EAGLE5 36.0.0
SOCKRTT command complete
```

8. Enter the **pass:cmd="netstat -p tcp"** command to determine if any retransmissions have occurred. For this example, enter this command.

```
pass:loc=1201:cmd="netstat -p tcp"
```

The following is an example of the possible output

```
rlghncxa03w 06-10-28 21:15:37 GMT EAGLE5 36.0.0
PASS: Command sent to card

rlghncxa03w 06-10-28 21:15:37 GMT EAGLE5 36.0.0
TCP:
  0 packet sent
    0 data packet (0 byte)
    0 data packet (0 byte) retransmitted
    0 ack-only packet (0 delayed)
    0 URG only packet
    0 window probe packet
    0 window update packet
    0 control packet
  0 packet received
    0 ack (for 0 byte)
    0 duplicate ack
    0 ack for unsend data
    0 packet (0 byte) received in-sequence
    0 completely duplicate packet (0 byte)
    0 packet with some dup. data (0 byte duped)
    0 out-of-order packet (0 byte)
    0 packet (0 byte) of data after window
    0 window probe
    0 window update packet
    0 packet received after close
    0 discarded for bad checksum
    0 discarded for bad header offset field
    0 discarded because packet too short
  0 connection request
  0 connection accept
  0 connection established (including accepts)
  0 connection closed (including 0 drop)
  0 embryonic connection dropped
  0 segment updated rtt (of 0 attempt)
  0 retransmit timeout
    0 connection dropped by rexmit timeout
  0 persist timeout
  0 keepalive timeout
    0 keepalive probe sent
    0 connection dropped by keepalive
  0 pcb cache lookup failed

rlghncxa03w 06-10-28 21:15:37 GMT EAGLE5 36.0.0
NETSTAT command complete
```

NOTE: If the results of the `pass:cmd="netstat -p tcp"` command show that the retransmission parameters do not need to be adjusted, do not perform this step. This procedure is finished.

9. Go to the "Changing an Application Socket" procedure on page 3-202 and adjust the retransmission parameter (`rtt` and `retransmit`) values of the socket based on the results of the `pass:cmd="netstat -p tcp"` command entered in step 8.

Flowchart 3-19. Configuring IP Retransmission Parameters

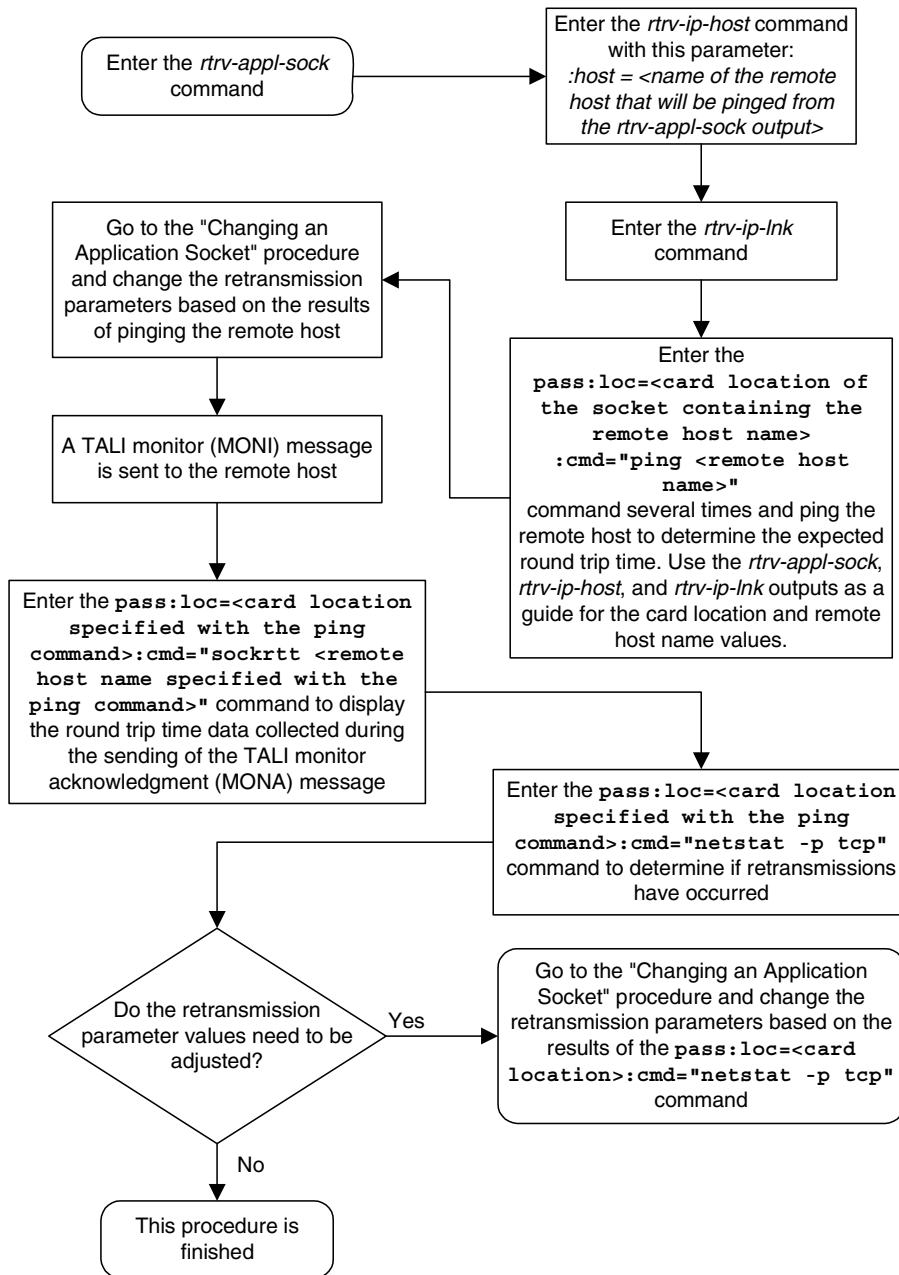

Changing a DCM Parameter Set

This procedure is used to change a Database Communication Module Parameter Set in the database using the **chg-dcmps** command. Parameter sets are sets of generic timers and parameters that can be used by any IP application.

NOTE: For IP, timers one through four correspond to timers T1, T2, T3, T4 in the TALI state machine.

The **chg-dcmps** command uses these parameters.

- :set**– The set number, 1 to 9.
- :timer** – The timer number within the set, 1 to 10. Only timers 1 to 4 are used. Timers 5 through 10 are not used.
- :tvalue** – The value the timer will be set to.
- :parm** – The parameter number within the timer, 1 to 10. Only parameter numbers 1 through 3 are used. Parameter numbers 4 through 10 are not used.
- :pvalue** – The numerical value that **pvalue** will be set to if specified.
- :srcset** – The source set of the copy, 1 - 10.

The values of the **timer**, **tvalue**, **parm**, and **pvalue** parameters is shown in the **rtrv-dcmps** output. The output shows the values for the **tvalue** and **pvalue** in bits. The values for these parameters are entered as a decimal number. Table 3-15 shows the decimal equivalent for the bit values shown in the **rtrv-dcmps** output.

Table 3-15. DCMPS Values

| Bit Value | Decimal Number Range |
|-----------|----------------------|
| 32 | 0 - 4294967295 |
| 8 | 0 - 255 |

While the value of the **pvalue** parameter when used with the **parm=3** parameter is 32 bits, or from 0 to 4294967295, only the first 6 bits (bits 0 - 5) are used. Bits 6-31 are reserved. This makes the decimal value of the **pvalue** parameter when used with the **parm=3** parameter from 0 to 63.

The value of the **pvalue** parameter when used with the **parm=2** parameter (enabling or disabling Nagle's Algorithm, TCP socket option) is either 0 (disabling Nagle's Algorithm) or 1 (enabling Nagle's Algorithm).

At least one of these parameters, **timer**, **parm**, or **srcset**, must be entered.

If the **srcset** parameter is specified, no other optional parameters can be entered.

If the **timer** parameter is specified, the **tvalue** parameter must be specified.

If the **parm** parameter is specified, the **pvalue** parameter must be specified.

NOTE: Set number 10 is a default parameter set and cannot be changed. In order to change the DCM parameters set for a socket using set number 10, use the `chg-appl-sock` command to change the DCM parameter set to a different set number, and then use the `chg-dcmps` command to modify the new set.

Canceling the `RTRV-DCMPS` Command

Because the `rtrv-dcmps` command used in this procedure can output information for a long period of time, the `rtrv-dcmps` command can be canceled and the output to the terminal stopped. There are three ways that the `rtrv-dcmps` command can be canceled.

- Press the **F9** function key on the keyboard at the terminal where the `rtrv-dcmps` command was entered.
- Enter the `canc-cmd` without the `trm` parameter at the terminal where the `rtrv-dcmps` command was entered.
- Enter the `canc-cmd:trm=<xx>`, where `<xx>` is the terminal where the `rtrv-dcmps` command was entered, from another terminal other than the terminal where the `rtrv-dcmps` command was entered. To enter the `canc-cmd:trm=<xx>` command, the terminal must allow Security Administration commands to be entered from it and the user must be allowed to enter Security Administration commands. The terminal's permissions can be verified with the `rtrv-secu-trm` command. The user's permissions can be verified with the `rtrv-user` or `rtrv-secu-user` commands.

For more information about the `canc-cmd` command, go to the *Commands Manual*.

Procedure

1. Display the DCM parameter set being changed in this procedure by entering the `rtrv-dcmps` command with the `set` parameter. For example, enter this command.

```
rtrv-dcmps:set=1
```

The following is an example of the possible output.

```
rlghncxa03w 06-10-28 21:15:37 GMT EAGLE5 36.0.0
SET  TIMER      TVALUE  PARM      PVALUE
  1      1         4000    1          255
  1      2         3000    2           1
  1      3         3000    3           1
  1      4        10000    4           0
  1      5           0      5           0
  1      6           0      6           0
  1      7           0      7           0
  1      8           0      8           0
  1      9           0      9           0
  1     10           0     10           0
```

```
TIMER 1: TALI T1 Timer, time (mS) between sending of TEST msgs by NE
TVALUE : Valid range = 32-bits
```

```
TIMER 2: TALI T2 Timer, time (mS) to wait for response to TEST msg
TVALUE : Valid range = 32-bits
```

```
TIMER 3: TALI T3 Timer, time (mS) to continue processing rcv'd service
          msgs after NE is prohibited
TVALUE : Valid range = 32-bits
```

```
TIMER 4: TALI T4 Timer, time (mS) between sending of MONI msgs by NE
TVALUE: Valid range = 32-bits
```

```
PARM  1: Type of Service (TOS), IP header socket option
PVALUE: Valid range = lowest 8-bits
```

```
PARM  2: Nagle's Algorithm, TCP socket option
PVALUE: Valid range = lowest bit: 0 = Disable Nagle, 1 = Enable Nagle
```

```
PARM  3: Default SORP Flags socket option. Each bit is used as an
          enabled/disabled flag for a particular socket option.
PVALUE: Valid range = 32-bits
```

| BIT | BIT VALUE |
|------------------------------------|------------------------|
| 0=Broadcast Phase MTPP Primitives; | 0=Disabled , 1=Enabled |
| 1=Response Method MTPP Primitives; | 0=Disabled , 1=Enabled |
| 2=SCCP with MTP; | 0=Disabled , 1=Enabled |
| 3=ISUP via MTP; | 0=Disabled , 1=Enabled |
| 4=Group Code in MTPP; | 0=Disabled , 1=Enabled |
| 5=Use XSRV; | 0=Disabled , 1=Enabled |
| 6-31=Reserved | |

NOTE: If a parameter set is not being copied to the parameter set being changed, skip this step and go to step 3.

2. Display the DCM parameter set that will be copied to the parameter set being changed in this procedure by entering the `rtrv-dcmps` command with the `set` parameter. For example, enter this command.

```
rtrv-dcmps:set=5
```

The following is an example of the possible output.

```
rlghncxa03w 06-10-28 21:15:37 GMT EAGLE5 36.0.0
SET  TIMER      TVALUE  PARM      PVALUE
 1      1          4000    1          255
 1      2          1500    2           1
 1      3          5000    3           1
 1      4         20000    4           0
 1      5           0      5           0
 1      6           0      6           0
 1      7           0      7           0
 1      8           0      8           0
 1      9           0      9           0
 1     10           0     10           0
```

TIMER 1: TALI T1 Timer, time (mS) between sending of TEST msgs by NE
TVALUE : Valid range = 32-bits

TIMER 2: TALI T2 Timer, time (mS) to wait for response to TEST msg
TVALUE : Valid range = 32-bits

TIMER 3: TALI T3 Timer, time (mS) to continue processing rcv'd service
msgs after NE is prohibited
TVALUE : Valid range = 32-bits

TIMER 4: TALI T4 Timer, time (mS) between sending of MONI msgs by NE
TVALUE: Valid range = 32-bits

PARM 1: Type of Service (TOS), IP header socket option
PVALUE: Valid range = lowest 8-bits

PARM 2: Nagle's Algorithm, TCP socket option
PVALUE: Valid range = lowest bit: 0 = Disable Nagle, 1 = Enable Nagle

PARM 3: Default SORP Flags socket option. Each bit is used as an
enabled/disabled flag for a particular socket option.
PVALUE: Valid range = 32-bits

| BIT | BIT VALUE |
|------------------------------------|------------------------|
| 0=Broadcast Phase MTPP Primitives; | 0=Disabled , 1=Enabled |
| 1=Response Method MTPP Primitives; | 0=Disabled , 1=Enabled |
| 2=SCCP with MTP; | 0=Disabled , 1=Enabled |
| 3=ISUP via MTP; | 0=Disabled , 1=Enabled |
| 4=Group Code in MTPP; | 0=Disabled , 1=Enabled |
| 5=Use XSRV; | 0=Disabled , 1=Enabled |
| 6-31=Reserved | |

3. Change the DCM parameter set information in the database by using the **chg-dcmps** command. For example, enter this command.

```
chg-dcmps:set=1:timer=1:tvalue=500
```

If a parameter set is being copied to the parameter set changed in this procedure, only the **set** and **srcset** parameters can be specified with the **chg-dcmps** command. The **set** parameter value must be the value specified in step 1. The **srcset** parameter value must be the value specified in step 2.

When this command has successfully completed, the following message should appear.

```
rlghncxa03w 06-10-28 21:16:37 GMT EAGLE5 36.0.0
CHG-DCMPS: MASP A - COMPLTD
```

4. Verify the new application socket information in the database by entering the **rtrv-dcmps** command. For example, enter this command.

```
rtrv-dcmps:set=1
```

The following is an example of the possible output.

```
rlghncxa03w 06-10-28 21:15:37 GMT EAGLE5 36.0.0
SET  TIMER      TVALUE  PARM      PVALUE
  1      1          500      1          255
  1      2          3000    2           1
  1      3          3000    3           1
  1      4          10000   4           0
  1      5           0        5           0
  1      6           0        6           0
  1      7           0        7           0
  1      8           0        8           0
  1      9           0        9           0
  1     10           0       10           0
```

```
TIMER 1: TALI T1 Timer, time (mS) between sending of TEST msgs by NE
TVALUE : Valid range = 32-bits
```

```
TIMER 2: TALI T2 Timer, time (mS) to wait for response to TEST msg
TVALUE : Valid range = 32-bits
```

```
TIMER 3: TALI T3 Timer, time (mS) to continue processing rcv'd service
         msgs after NE is prohibited
TVALUE : Valid range = 32-bits
```

```
TIMER 4: TALI T4 Timer, time (mS) between sending of MONI msgs by NE
TVALUE : Valid range = 32-bits
```

```
PARM 1: Type of Service (TOS), IP header socket option
PVALUE : Valid range = lowest 8-bits
```

```
PARM 2: Nagle's Algorithm, TCP socket option
PVALUE : Valid range = lowest bit: 0 = Disable Nagle, 1 = Enable Nagle
```

```
PARM 3: Default SORP Flags socket option. Each bit is used as an
         enabled/disabled flag for a particular socket option.
PVALUE : Valid range = 32-bits
```

| BIT | BIT VALUE |
|------------------------------------|------------------------|
| 0=Broadcast Phase MTPP Primitives; | 0=Disabled , 1=Enabled |
| 1=Response Method MTPP Primitives; | 0=Disabled , 1=Enabled |
| 2=SCCP with MTP; | 0=Disabled , 1=Enabled |

IP7 Secure Gateway Configuration Procedures

| | |
|-----------------------|------------------------|
| 3=ISUP via MTP; | 0=Disabled , 1=Enabled |
| 4=Group Code in MTPP; | 0=Disabled , 1=Enabled |
| 5=Use XSRV; | 0=Disabled , 1=Enabled |
| 6-31=Reserved | |

5. Back up the new changes using the **chg-db:action=backup:dest=fixed** command. These messages should appear, the active Maintenance and Administration Subsystem Processor (MASP) appears first.

```
BACKUP (FIXED) : MASP A - Backup starts on active MASP.  
BACKUP (FIXED) : MASP A - Backup on active MASP to fixed disk complete.  
BACKUP (FIXED) : MASP A - Backup starts on standby MASP.  
BACKUP (FIXED) : MASP A - Backup on standby MASP to fixed disk complete.
```

Flowchart 3-20. Changing an DCM Parameter Set

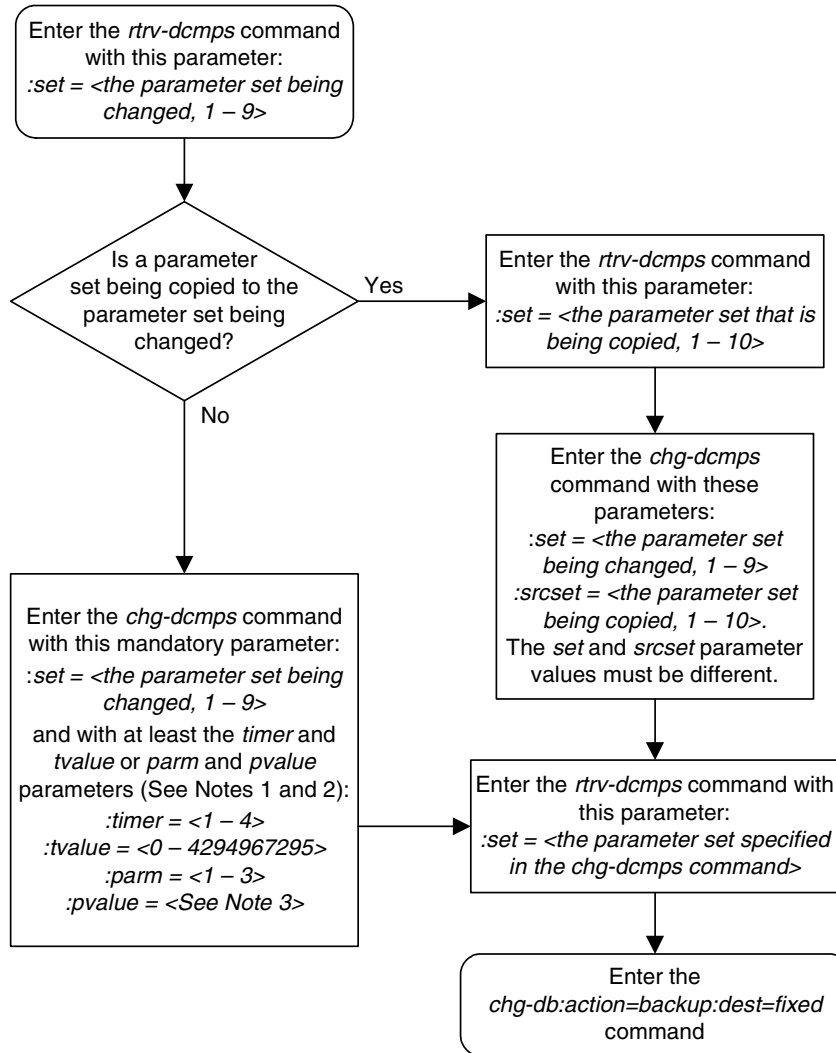

Notes:

1. If either the *timer* or *tvalue* parameters are specified, then both the *timer* and *tvalue* parameters must be specified.
2. If either the *parm* or *pvalue* parameters are specified, then both the *parm* and *pvalue* parameters must be specified.
3. If the *parm* parameter value is 1, the *pvalue* parameter is 0 – 255.
If the *parm* parameter value is 2, the *pvalue* parameter value is either 0 or 1.
If the *parm* parameter value is 3, the *pvalue* parameter value is 0 – 63. Each bit of the *pvalue* parameter value enables or disables certain functions. See the *rtrv-dcmps* command output for a list of the functions affected by the *parm=3* parameter.

Adding a Routing Key Containing a Socket

This procedure is used to add a routing key containing a socket to the database, or add a socket to an existing routing key containing sockets using the `ent-app1-rtkey` command.

A routing key defines a filter that checks the specified values in an incoming SS7 MSU to determine which, if any, socket or association receives the MSU. For more information about static routing keys, see “Understanding Routing for SS7IPGW and IPGWI Applications” on page 2-25.

The `ent-app1-rtkey` command uses these parameters.

`:dpc/dpca/dpci/dpcn/dpcn24` – The destination point code value that is used to filter incoming MSUs. This parameter must not specify a cluster route. The destination point code of the routing key cannot be the APC of an IPGWx linkset or the SAPC assigned to an IPGWx linkset.

`:opc/opca/opci/opcn/opcn24` – The originating point code value that is used to filter incoming MSUs. This parameter must not specify a cluster route. This parameter is valid only when the `si` parameter value is set to 4, 5, or 13. This parameter is required if `si=4, 5, or 13` and `type=full`.

NOTE: See the “Point Code Formats” section in the *Database Administration Manual - SS7* for a definition of the point code types that are used on the EAGLE 5 ISS and for a definition of the different formats that can be used for ITU national point codes.

`:si` – The service indicator value that is used to filter incoming MSUs. The range of values for the service indicator parameter (`si`) can be a numerical value from 0 to 15, or for selected service indicator values, a text string can be used instead of numbers. Table 3-16 shows the text strings that can be used in place of numbers for the service indicator values.

Table 3-16. Service Indicator Text String Values

| Service Indicator Value | Text String |
|-------------------------|-------------|
| 0 | snm |
| 1 | regtest |
| 2 | spltst |
| 3 | sccp |
| 4 | tup |
| 5 | isup |
| 13 | qbicc |

`:ssn` – The subsystem value that is used to filter incoming MSUs. The `ssn` parameter is only valid when the `si` parameter value is set to 3 or `sccp`.

:sname – The name of the socket that will receive the incoming MSU if the filter key values (**dpc**, **si**, **ssn**) match the values in the incoming MSU.

:cics – The starting circuit identification code that is used to filter incoming MSUs. When specified with **cice**, **cics** identifies the start of the range of circuit identification codes. The **cics** parameter is valid only when the **si** parameter value is set to 4, 5, or 13. The **cics** is required if **si=4**, 5, or 13 and **type=full**.

:cice – The ending circuit identification code that is used to filter incoming MSUs. When specified with **cics**, **cice** identifies the end of the range of circuit identification codes. The **cice** parameter is valid only when the **si** parameter value is set to 4, 5, or 13. The **cice** is required if **si=4**, 5, or 13 and **type=full**.

:type – The routing key type – Identifies the type of routing key that is being entered and used to route message signaling units (MSUs). One of three values, **full**/**partial**/**default**, can be specified for the type parameter (see Table 3-17 on page 3-235). If **type** is not explicitly specified, **type = full** is assumed.

The **ent-app1-rtkey** command also contains these parameters which cannot be used in this procedure.

:asname – The application server name

:rcontext – The routing context parameter.

These parameters and their use are discussed in more detail in the “Adding a Routing Key Containing an Application Server” procedure on page 3-250 procedure.

Application socket names are shown in the **rtrv-app1-sock** output.

A routing key can be associated with up to 16 socket names. There is a maximum of 1000 routing keys allowed for each EAGLE 5 ISS (if there are any dual-slot DCM cards), or 2500 routing keys allowed for each EAGLE 5 ISS (if all cards running the **ss7ipgw** or **ipgwi** application are SSEDCCM cards). Each of routing key’s socket or application server names must be uniquely named.

The number of static routing keys is limited by the **srkq** parameter that was specified on the **chg-sg-opts** command.

Routing keys are associated only with the **ss7ipgw** or **ipgwi** application.

Group codes are required for 14-bit ITU-N point codes (DPCN/OPCN) when the Duplicate Point Code feature is enabled.

The starting circuit identification code must be less than or equal to the ending circuit identification code.

The ISUP routing over IP feature must be on in order to enter a routing key with these parameters: **dpc**, **si**, **opc**, **cics**, and **cice**. The **IPISUP** field in the **rtrv-feat** command output shows whether or not this feature is on.

When a routing key is added to the database, the **pstncat** and **pstnid** parameter values are set to zero and the **norm** parameter is set to **no**. These values cannot be

changed with the `ent-app1-rtkey` command. To change these values, go to the “Changing the PSTN Presentation and Normalization Attributes in a Routing Key” procedure on page 3-303.

The parameter combinations used by the `ent-app1-rtkey` command are based on the type of routing key and the service indicator value in the routing key. The parameter combinations are shown in Table 3-17.

Table 3-17. Routing Key Parameter Combinations for Adding a Routing Key Containing a Socket

| SI=3 (SCCP) | | SI=4 (TUP), 5 (ISUP), 13 (QBICC) | | Other SI Values | | Default Routing Key |
|---------------------|------------------------|----------------------------------|-----------------------------|--|---|---------------------|
| Full Routing Key | Partial Routing Key | Full Routing Key | Partial Routing Key | Full Routing Key | Partial Routing Key | |
| dpc ^{1, 2} | sname | dpc ^{1, 2} | sname | dpc ^{1, 2} | sname | sname |
| si=3 ⁴ | type=partial | si=4, 5, 13 ⁴ | type=partial | si=value other than 3, 4, 5, 13 ⁴ | type=partial | type=default |
| ssn | dpc ^{1, 2, 3} | opc ^{1, 2} | dpc ^{1, 2, 3} | sname | dpc ^{1, 2, 3} | |
| type=full | si=3 ^{3, 4} | cics ^{5, 6, 7, 8, 9} | si=4, 5, 13 ^{3, 4} | type=full | si=value other than 3, 4, 5, 13 ^{3, 4} | |
| sname | | cice ^{5, 6, 7, 8, 9} | opc ^{1, 2, 3} | | | |
| | | type=full | | | | |
| | | sname | | | | |

Notes:

- The `dpc` and `opc` parameters can be either an ANSI point code (`dPCA`, `oPCA`), ITU-I point code (`dpci`, `opci`), 14-bit ITU-N point code (`dpcn`, `opcn`), or 24-bit ITU-N point code (`dpcn24`, `opcn24`). If the `dpc` and `opc` parameters are specified, the `dpc` and `opc` must be the same type of point code. For example, if the `dPCA` parameter is specified, the OPC is specified with the `oPCA` parameter. ITU-I and 14-bit ITU-N spare point codes cannot be assigned to a routing key containing a socket.
- If the ITU National Duplicate Point Code feature is on, the values for the `dpcn` and `opcn` parameters must have group codes assigned to them. The field `ITUDUPPC` in the `rtkv-feat` command output shows whether or not the ITU National Duplicate Point Code feature is on. If group codes are specified for ITU-N DPC and OPC, the groups codes must be the same.
- These parameters are optional for partial routing keys, but at least one these parameters must be specified with the `ent-app1-rtkey` command.
- Text strings can be used in place of some numerical service indicator values. See Table 3-16 on page 3-233 for a list of these text strings.

Table 3-17. Routing Key Parameter Combinations for Adding a Routing Key Containing a Socket (Continued)

| SI=3 (SCCP) | | SI=4 (TUP), 5 (ISUP), 13 (QBICC) | | Other SI Values | | Default Routing Key |
|---|---------------------|----------------------------------|---------------------|------------------|---------------------|---------------------|
| Full Routing Key | Partial Routing Key | Full Routing Key | Partial Routing Key | Full Routing Key | Partial Routing Key | |
| 5. When the service indicator parameter value equals 4 and an ANSI dpc is specified, the <code>opc</code> , <code>cics</code> , and <code>cice</code> parameters cannot be used. If the service indicator parameter value equals 4 and an ITU dpc is specified, the <code>opc</code> , <code>cics</code> , and <code>cice</code> parameters are required. | | | | | | |
| 6. If the service indicator parameter (<code>si</code>) value is 4, the values of the <code>cics</code> and <code>cice</code> parameters is from 0 to 4095. | | | | | | |
| 7. If the service indicator parameter (<code>si</code>) value is 5 and the point code in the routing key is either an ITU-I, 14-bit ITU-N, or 24-bit ITU-N point code, the values of the <code>cics</code> and <code>cice</code> parameters is from 0 to 4095. If the point code in the routing key is an ANSI point code, the values of the <code>cics</code> and <code>cice</code> parameters is from 0 to 16383. | | | | | | |
| 8. If the service indicator parameter value is 13, the values of the <code>cics</code> and <code>cice</code> parameters is from 0 to 4294967295. | | | | | | |
| 9. The CIC range, defined by the <code>cics</code> and <code>cice</code> parameters, cannot overlap the CIC range in an existing routing key. | | | | | | |

Canceling the `RTRV-APPL-SOCK` and `RTRV-APPL-RTKEY` Commands

Because the `rtrv-appl-sock` and `rtrv-appl-rtkey` commands used in this procedure can output information for a long period of time, the `rtrv-appl-sock` and `rtrv-appl-rtkey` commands can be canceled and the output to the terminal stopped. There are three ways that the `rtrv-appl-sock` and `rtrv-appl-rtkey` commands can be canceled.

- Press the **F9** function key on the keyboard at the terminal where the `rtrv-appl-sock` or `rtrv-appl-rtkey` commands were entered.
- Enter the `canc-cmd` without the `trm` parameter at the terminal where the `rtrv-appl-sock` or `rtrv-appl-rtkey` commands were entered.
- Enter the `canc-cmd:trm=<xx>`, where `<xx>` is the terminal where the `rtrv-appl-sock` and `rtrv-appl-rtkey` commands were entered, from another terminal other than the terminal where the `rtrv-appl-sock` or `rtrv-appl-rtkey` commands were entered. To enter the `canc-cmd:trm=<xx>` command, the terminal must allow Security Administration commands to be entered from it and the user must be allowed to enter Security Administration commands. The terminal's permissions can be verified with the `rtrv-secu-trm` command. The user's permissions can be verified with the `rtrv-user` or `rtrv-secu-user` commands.

For more information about the `canc-cmd` command, go to the *Commands Manual*.

Procedure

1. Display the current routing key information in the database by entering the `rtrv-appl-rtkey` command. The following is an example of the possible output.

```
rlghncxa03w 06-10-28 21:15:37 GMT EAGLE5 36.0.0
```

```

RCONTEXT      DPC          SI  ADPTR  ASNAME          TYPE      LOC
-----
123-234-123   5  TALI  -----        FULL     STATIC
123-234-123   5  TALI  -----        FULL     STATIC
005-005-001   5  TALI  -----        FULL     1105
005-005-001   5  TALI  -----        FULL     1105
006-006-001   5  TALI  -----        FULL     1107
006-006-001   5  TALI  -----        FULL     1107

```

```

RCONTEXT      DPCI          SI  ADPTR  ASNAME          TYPE      LOC
-----
s-6-006-6     3  TALI  -----        FULL     STATIC
6-006-7       6  TALI  -----        FULL     STATIC
s-6-006-6     5  TALI  -----        FULL     STATIC
s-6-006-6     5  TALI  -----        FULL     STATIC

```

```
RCONTEXT      DPCN          SI  ADPTR  ASNAME          TYPE      LOC
```

```
RCONTEXT      DPCN24        SI  ADPTR  ASNAME          TYPE      LOC
```

```

RCONTEXT      DPC          SI  ADPTR  ASNAME          TYPE      LOC
-----
*****      **  TALI  -----        DEFAULT  STATIC

```

```
STATIC Route Key table is (7 of 2000) 1% full
```

```
1105 Route Key table is (2 of 500) 1% full
```

```
1107 Route Key table is (2 of 500) 1% full
```

```
STATIC Route Key Socket Association table is (7 of 32000) 1% full
```

```
1105 Route Key Socket Association table is (2 of 8000) 1% full
```

```
1107 Route Key Socket Association table is (2 of 8000) 1% full
```

NOTE: If the routing key will be assigned to a new DPC, skip this step and go to step 3.

NOTE: The database can contain only one default routing key. If the `rtrv-appl-rtkey` output contains a default routing key, a default routing key cannot be added in this procedure. Continue this procedure with step 2 to add either a full or partial routing key with the desired socket. If the `rtrv-appl-rtkey` output in step 1 does not show a default routing key, skip this step and go to step 3.

2. Display the specific routing key information for the routing key that the new routing key will be added to by entering the `rtrv-appl-rtkey` command with the `display=all` parameter and the DPC value shown in the `rtrv-appl-rtkey` output in step 1. For this example, enter this command.

```
rtrv-appl-rtkey:dpc=123-234-123:display=all
```

This is an example of the possible output.

```
rlghncxa03w 06-10-28 21:16:37 GMT EAGLE5 36.0.0

RCONTEXT  DPC          SI SSN OPC          CICS      CICE      LOC
-----  123-234-123    5 --- 122-124-125    1         1000     STATIC

      ADPTR  TYPE      PSTNCAT  PSTNID  NORM  DUP
      TALI  FULL          0        0  N    N

      SNAMEs
      socket31

RCONTEXT  DPC          SI SSN OPC          CICS      CICE      LOC
-----  123-234-123    5 --- 100-100-100    1         50       STATIC

      ADPTR  TYPE      PSTNCAT  PSTNID  NORM  DUP
      TALI  FULL          0        0  N    N

      SNAMEs
      socket31

STATIC Route Key table is (7 of 2000) 1% full
1105  Route Key table is (2 of 500) 1% full
1107  Route Key table is (2 of 500) 1% full

STATIC Route Key Socket Association table is (7 of 32000) 1% full
1105  Route Key Socket Association table is (2 of 8000) 1% full
1107  Route Key Socket Association table is (2 of 8000) 1% full
```

If this routing key has an application server assigned to it, another socket cannot be assigned to the routing key. Continue this procedure with step 3 and add a new routing key with a new DPC and the desired socket.

NOTE: If the routing key being added will contain ITU-I or 14-bit ITU-N spare point codes, a socket cannot be assigned to the routing key. Only an application server can be assigned to a routing key that contains ITU-I or 14-bit ITU-N spare point codes. To add a new routing key with a socket, continue with this procedure at step 3 and add a new routing key with a new DPC, but not an ITU-I or 14-bit ITU-N spare point code, and the desired socket. To add a new routing key with an ITU-I or 14-bit ITU-N spare point code, perform the “Adding a Routing Key Containing an Application Server” on page 3-250.

3. Display the current application socket information in the database by entering the `rtrv-appl-sock` command. The following is an example of the possible output.

```
rlghncxa03w 06-10-28 21:15:37 GMT EAGLE5 36.0.0
SNAME socket31
  LINK      A
  LHOST     ipnode1-1201
  RHOST     kc-hlr1
  LPORT     7000          RPORT     7000
  SERVER    YES          DCMP5     1
  REXMIT    FIXED       RTT        60
  OPEN     YES          ALW       NO

SNAME kchlr11203
  LINK      A
  LHOST     ipnode1-1203
  RHOST     kc-hlr1
  LPORT     7005          RPORT     7005
  SERVER    YES          DCMP5     10
  REXMIT    FIXED       RTT        60
  OPEN     YES          ALW       YES
```

IP Appl Sock/Assoc table is (2 of 4000) 1% full

If the required socket is shown in the `rtrv-appl-sock` output, and a default routing key is being added, skip steps 4 through 7, and go to step 8.

If the required socket is not shown in the `rtrv-appl-sock` output, and a default routing key is being added, perform the "Adding an Application Socket" procedure on page 3-181 to add the socket. After the socket has been added, skip steps 4 through 7, and go to step 8.

If a partial or full routing key is being added, go to step 4.

4. The DPC of the routing key cannot be the APC of an IPGWx linkset or an SAPC assigned to an IPGWx linkset. Display the names of the IPGWx linksets by entering the `rept-stat-iptps` command. This is an example of the possible output.

```
rlghncxa03w 06-10-10 11:43:04 GMT EAGLE5 36.0.0

IP TPS USAGE REPORT
```

| | THRESH | CONFIG | | TPS | PEAK | PEAKTIMESTAMP |
|--------------------|--------|--------|------|------|------|-------------------|
| ----- | | | | | | |
| SYSTEM | | | | | | |
| RLGHNCXA03W | 100% | 30000 | TX: | 7200 | 7600 | 05-02-10 11:40:04 |
| | | | RCV: | 7200 | 7600 | 05-02-10 11:40:04 |
| ----- | | | | | | |
| LSN | | | | | | |
| LSGW1101 | 80% | 10000 | TX: | 7200 | 7600 | 05-02-10 11:40:04 |
| | | | RCV: | 7200 | 7600 | 05-02-10 11:40:04 |
| LSGW1103 | 80% | 10000 | TX: | 6700 | 7600 | 05-02-10 11:40:04 |
| | | | RCV: | 6500 | 7600 | 05-02-10 11:40:04 |
| LSGW1105 | 80% | 10000 | TX: | 7300 | 7450 | 05-02-10 11:40:04 |
| | | | RCV: | 7300 | 7450 | 05-02-10 11:40:04 |
| ----- | | | | | | |
| Command Completed. | | | | | | |

5. Display the IPGwx linksets shown in the `rept-stat-iptps` output in step 4 using the `rtrv-ls` command and specifying the name of the linkset shown in step 4. For this example, enter these commands.

rtrv-ls:lsn=lsgw1101

This is an example of the possible output

```
rlghncxa03w 06-10-28 16:31:35 GMT EAGLE5 36.0.0
                                L3T SLT                                GWS GWS GWS
LSN          APCA   (SS7)  SCRN  SET SET BEI LST LNKS ACT MES DIS SLSCI NIS
lsgw1101     240-020-000  scr1  1   1  yes A   1   off off off yes  off

IPGWAPC MATELSN   IPTPS LSUSEALM SLKUSEALM GTTMODE
yes      ----- 10000 70      % 70      % CdPA

                                L2T          L1          PCR  PCR
LOC  LINK SLC TYPE  SET  BPS      MODE TSET   ECM   N1   N2

                                LP          ATM
LOC  LINK SLC TYPE  SET  BPS      TSEL      VCI   VPI   LL

                                LP          ATM          E1ATM
LOC  LINK SLC TYPE  SET  BPS      TSEL      VCI   VPI   CRC4 SI SN

LOC  LINK SLC TYPE  IPLIML2

LOC  LINK SLC TYPE
1101 A   0   SS7IPGW

                                L2T          PCR  PCR  E1   E1
LOC  LINK SLC TYPE  SET  BPS      ECM   N1   N2   LOC  PORT TS

                                L2T          PCR  PCR  T1   T1
LOC  LINK SLC TYPE  SET  BPS      ECM   N1   N2   LOC  PORT TS
```

Link set table is (13 of 1024) 1% full

rtrv-ls:lsn=lsgw1103

This is an example of the possible output.

```
rlghncxa03w 06-10-17 11:43:04 GMT EAGLE5 36.0.0
                                L3T SLT                                GWS GWS GWS
LSN          APCN   (SS7)  SCRN  SET SET BEI LST LNKS ACT MES DIS SLSCI NIS
lsgw1103     2968          none  1   1  no  A   1   off off off ---  off

CLLI          TFATCABMLQ  MTPRSE  ASL8  SLRSRB  MULTGC  ITUTFR
-----      1          ---    ---    1      no      off

IPGWAPC MATELSN   IPTPS LSUSEALM SLKUSEALM GTTMODE
yes      ----- 10000 70      % 70      % CdPA

                                L2T          L1          PCR  PCR
LOC  LINK SLC TYPE  SET  BPS      MODE TSET   ECM   N1   N2

                                LP          ATM
LOC  LINK SLC TYPE  SET  BPS      TSEL      VCI   VPI   LL

                                LP          ATM          E1ATM
LOC  LINK SLC TYPE  SET  BPS      TSEL      VCI   VPI   CRC4 SI SN

LOC  LINK SLC TYPE  IPLIML2
```

IP7 Secure Gateway Configuration Procedures

```

LOC LINK SLC TYPE
1103 A 0 IPGWI

LOC LINK SLC TYPE L2T PCR PCR E1 E1
SET BPS ECM N1 N2 LOC PORT TS

LOC LINK SLC TYPE L2T PCR PCR T1 T1
SET BPS ECM N1 N2 LOC PORT TS

SAPCI
1-010-1

```

Link set table is (13 of 1024) 1% full.

rtrv-ls:lsn=lsgw1105

This is an example of the possible output.

```

rlghncxa03w 06-10-17 11:43:04 GMT EAGLE5 36.0.0
                                L3T SLT                                GWS GWS GWS
LSN          APCI  (SS7)  SCRN  SET SET BEI LST LNKS ACT MES DIS SLSCI NIS
lsgw1105     2-154-0      none  1  1  no  A  1  off off off --- off

CLLI          TFATCABMLQ  MTPRSE  ASL8  SLRSRB  MULTGC  ITUTFR
-----      1          ---      ---      1      no      off

IPGWAPC MATELSN  IPTPS LSUSEALM SLKUSEALM GTTMODE
yes      ----- 10000 70      % 70      % CdPA

LOC LINK SLC TYPE L2T L1 PCR PCR
SET BPS MODE TSET ECM N1 N2

LOC LINK SLC TYPE LP ATM
SET BPS TSEL VCI VPI LL

LOC LINK SLC TYPE LP ATM E1ATM
SET BPS TSEL VCI VPI CRC4 SI SN

LOC LINK SLC TYPE IPLIML2

LOC LINK SLC TYPE
1105 A 0 IPGWI

LOC LINK SLC TYPE L2T PCR PCR E1 E1
SET BPS ECM N1 N2 LOC PORT TS

LOC LINK SLC TYPE L2T PCR PCR T1 T1
SET BPS ECM N1 N2 LOC PORT TS

SAPCN
5823

```

Link set table is (13 of 1024) 1% full.

If the DPC of the routing key is shown in the **rtrv-ls** outputs in this step, choose another DPC value for the routing key that is not shown in the **rtrv-ls** outputs in this step.

If the required socket is shown in the **rtrv-appl-sock** output in step 3, continue this procedure with step 6.

If the required socket is not shown in the **rtrv-appl-sock** output in step 3, perform the "Adding an Application Socket" procedure on page 3-181 to add

the socket. After the socket has been added, continue this procedure with step 6.

NOTE: If a default routing key is being added to the database, or if the SI value of the routing key being added is a value other than 4, 5, or 13, skip steps 6 and 7, and go to step 8.

6. Verify that the ISUP Routing over IP feature is on, by entering the `rtrv-feat` command. If the ISUP Routing over IP feature is on, the `IPISUP` field should be set to `on`. For this example, the ISUP Routing over IP feature is off.

NOTE: The `rtrv-feat` command output contains other fields that are not used by this procedure. If you wish to see all the fields displayed by the `rtrv-feat` command, see the `rtrv-feat` command description in the *Commands Manual*.

NOTE: If the ISUP Routing over IP feature is on, skip step 7 and go to step 8.

7. Turn the ISUP Routing over IP feature on by entering this command.

```
chg-feat:ipisup=on
```

NOTE: Once the ISUP Routing over IP feature is turned on with the `chg-feat` command, it cannot be turned off.

The ISUP Routing over IP feature must be purchased before you turn this feature on with the `chg-feat` command. If you are not sure if you have purchased the ISUP Routing over IP feature, contact your Tekelec Sales Representative or Account Representative.

When the `chg-feat` has successfully completed, this message should appear.

```
rlghncxa03w 06-10-28 11:43:04 GMT EAGLE5 36.0.0
CHG-FEAT: MASP A - COMPLTD
```

8. Add a routing key entry to the database by entering the `ent-appl-rtkey` command. The parameters required for the `ent-appl-rtkey` command are determined by the type of routing key being added and the service indicator value in the routing key. See Table 3-17 on page 3-235 for the parameter combinations that can be used for the type of routing key being added to the database.

NOTE: If the DPC and OPC values are ITU-N point codes, these point codes must have group codes assigned to them if the ITU National Duplicate Point Code feature is on. The `ITUDUPPC` field in the `rtrv-feat` command executed in step 6 shows whether or not the ITU National Duplicate Point Code feature is on.

A socket can be added to an existing routing key if the DPC value specified in this procedure must be same as the DPC value shown in the existing routing key.

For this example, a full ISUP routing key is being added to the database. Enter this command.

```
ent-appl-rtkey:dpca=001-002-003:si=5:opca=100-100-100:cics=1
:cice=50:sname=socket5:type=full
```

When this command has successfully completed, the following message should appear.

```
rlghncxa03w 06-10-28 21:15:37 GMT EAGLE5 36.0.0
ENT-APPL-RTKEY: MASP A - COMPLTD
```

9. Verify the new routing key information in the database by entering the **rtrv-appl-rtkey** command with the socket name (**sname**) specified in step 8 and the **display=all** parameter. For this example, enter this command.

```
rtrv-appl-rtkey:sname=socket5:display=all
```

The following is an example of the possible output.

```
rlghncxa03w 06-10-28 21:16:37 GMT EAGLE5 36.0.0

RCONTEXT  DPC          SI SSN OPC          CICS      CICE      LOC
-----  -
001-002-003  5 --- 100-100-100  1         50        STATIC

ADPTR  TYPE      PSTNCAT  PSTNID  NORM  DUP
TALI   FULL          0       0  N    N

SNAMEs
socket5

STATIC Route Key table is ( 8 of 2000) 1% full
1105  Route Key table is ( 2 of 500) 1% full
1107  Route Key table is ( 2 of 500) 1% full

STATIC Route Key Socket Association table is (8 of 32000) 1% full
1105  Route Key Socket Association table is (2 of 8000) 1% full
1107  Route Key Socket Association table is (2 of 8000) 1% full
```

If a socket was assigned to the routing key added in this procedure and you wish to add other sockets to the routing key, repeat this procedure from step 3. If no other sockets are to be added to the routing key, go to step 10.

10. If you wish to change the PSTN presentation information in the routing key that was added in step 8, go to the "Changing the PSTN Presentation and Normalization Attributes in a Routing Key" procedure on page 3-303. Do not perform step 11.

If you do not wish to change the PSTN presentation information in the routing key, skip this step and go to step 9.

11. Back up the new changes using the **chg-db:action=backup:dest=fixed** command. These messages should appear, the active Maintenance and Administration Subsystem Processor (MASP) appears first.

```
BACKUP (FIXED) : MASP A - Backup starts on active MASP.  
BACKUP (FIXED) : MASP A - Backup on active MASP to fixed disk complete.  
BACKUP (FIXED) : MASP A - Backup starts on standby MASP.  
BACKUP (FIXED) : MASP A - Backup on standby MASP to fixed disk complete.
```

Flowchart 3-21. Adding a Routing Key Containing a Socket (Sheet 1 of 5)

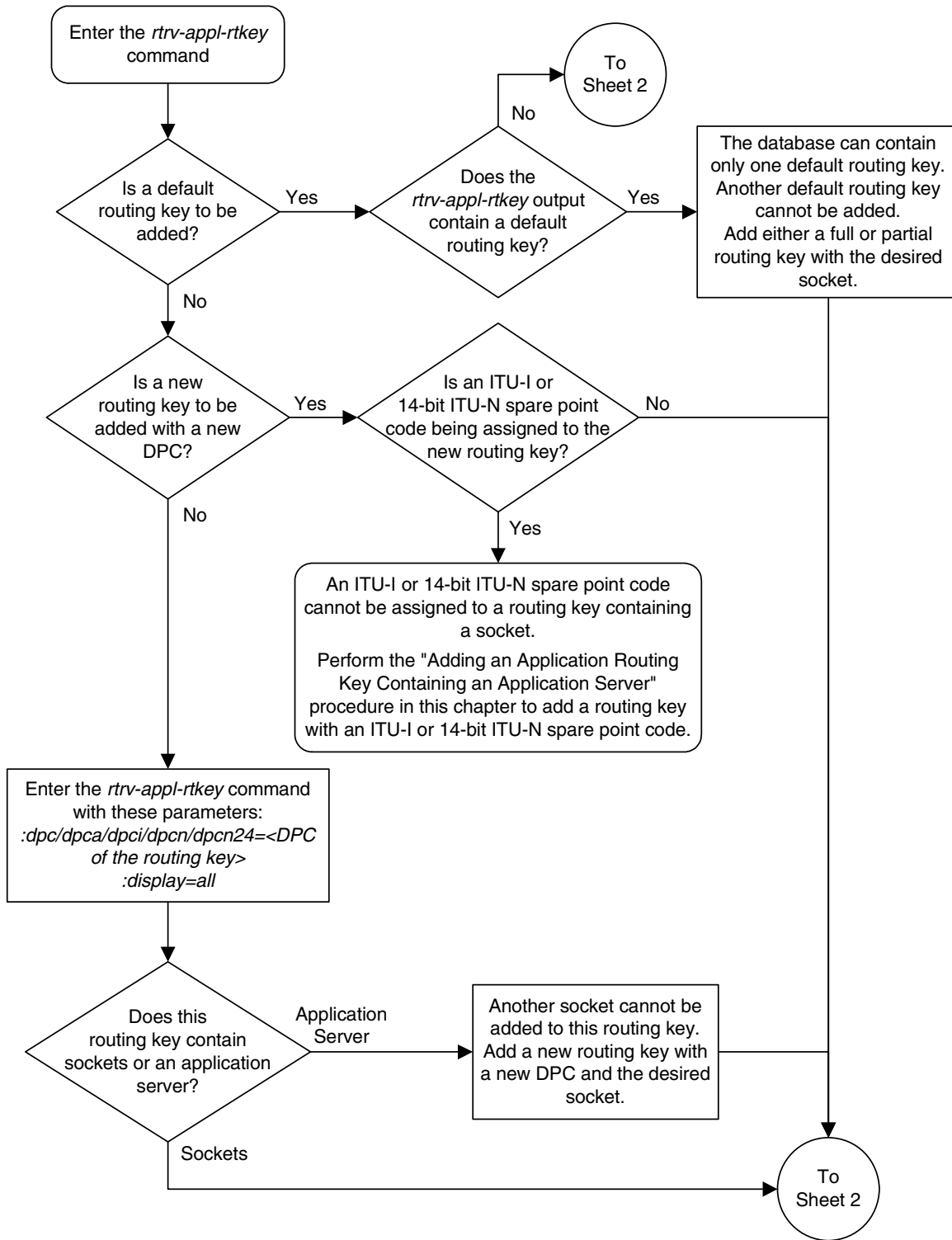

Flowchart 3-21. Adding a Routing Key Containing a Socket (Sheet 2 of 5)

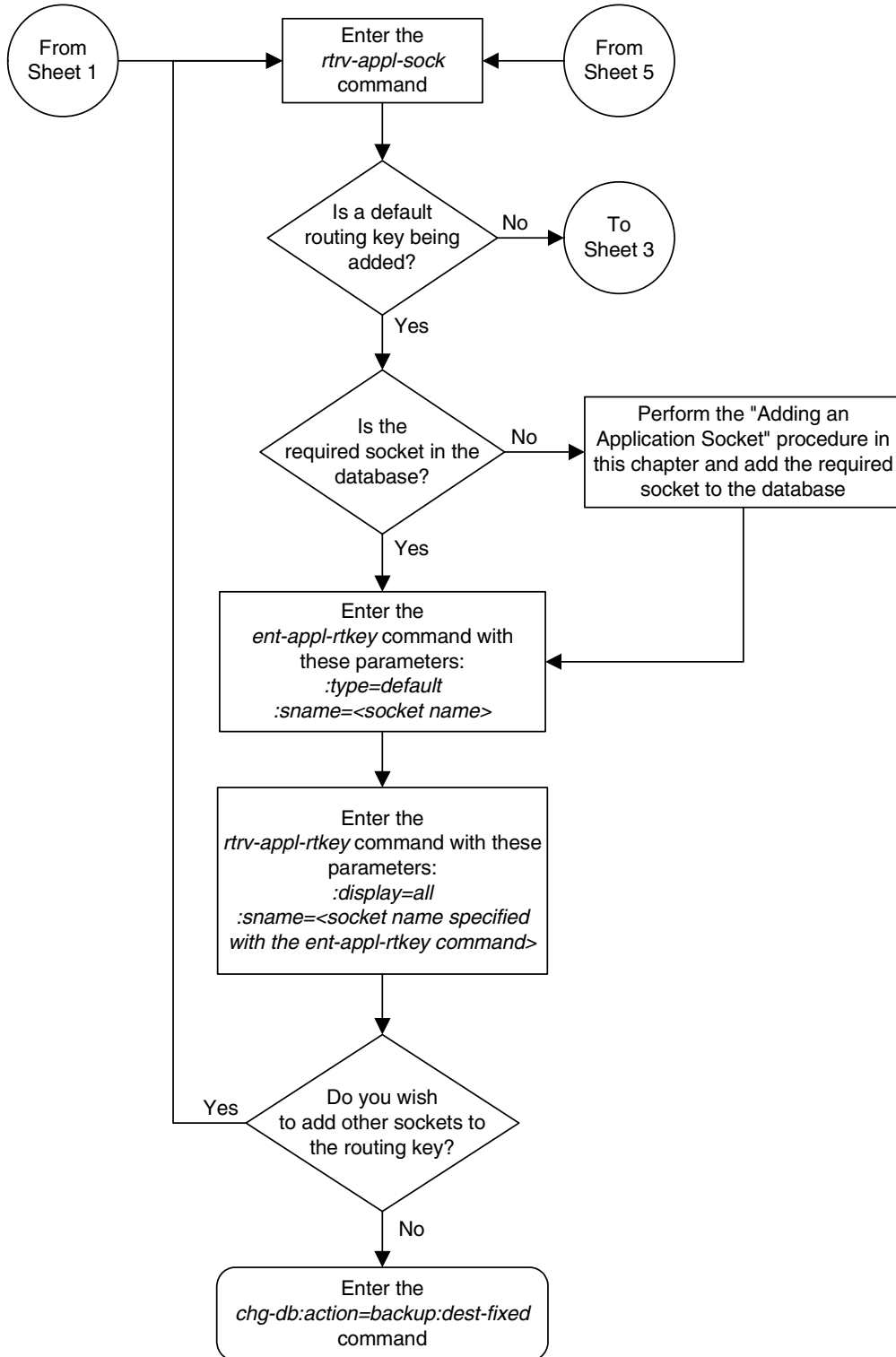

Flowchart 3-21. Adding a Routing Key Containing a Socket (Sheet 3 of 5)

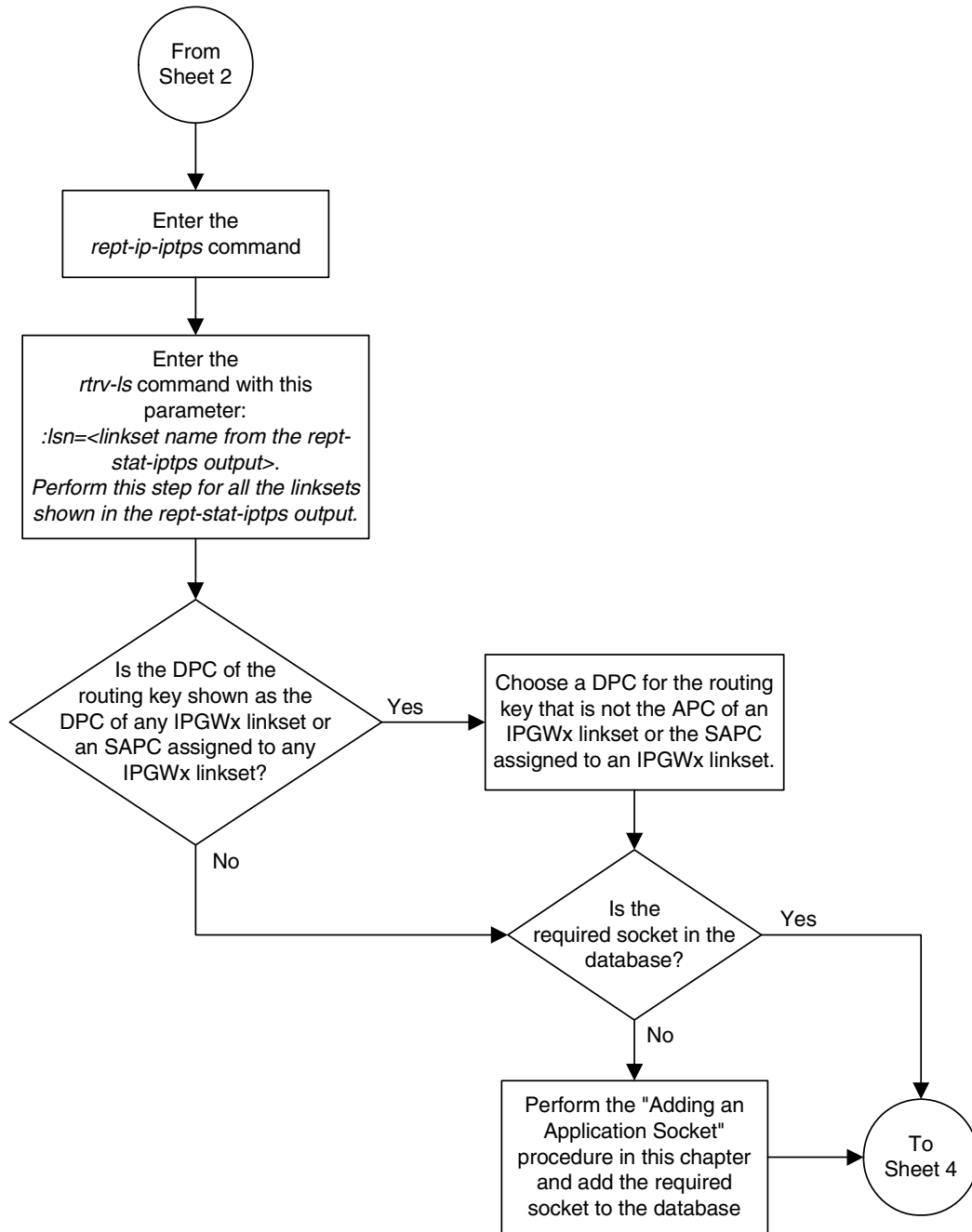

Flowchart 3-21. Adding a Routing Key Containing a Socket (Sheet 4 of 5)

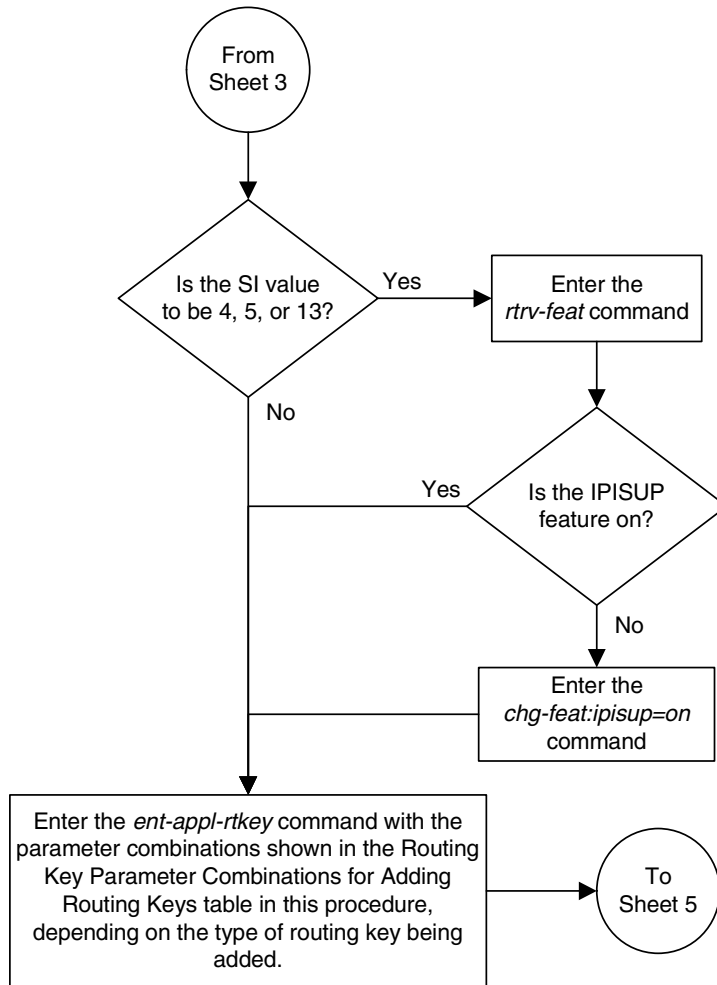

Flowchart 3-21. Adding a Routing Key Containing a Socket (Sheet 5 of 5)

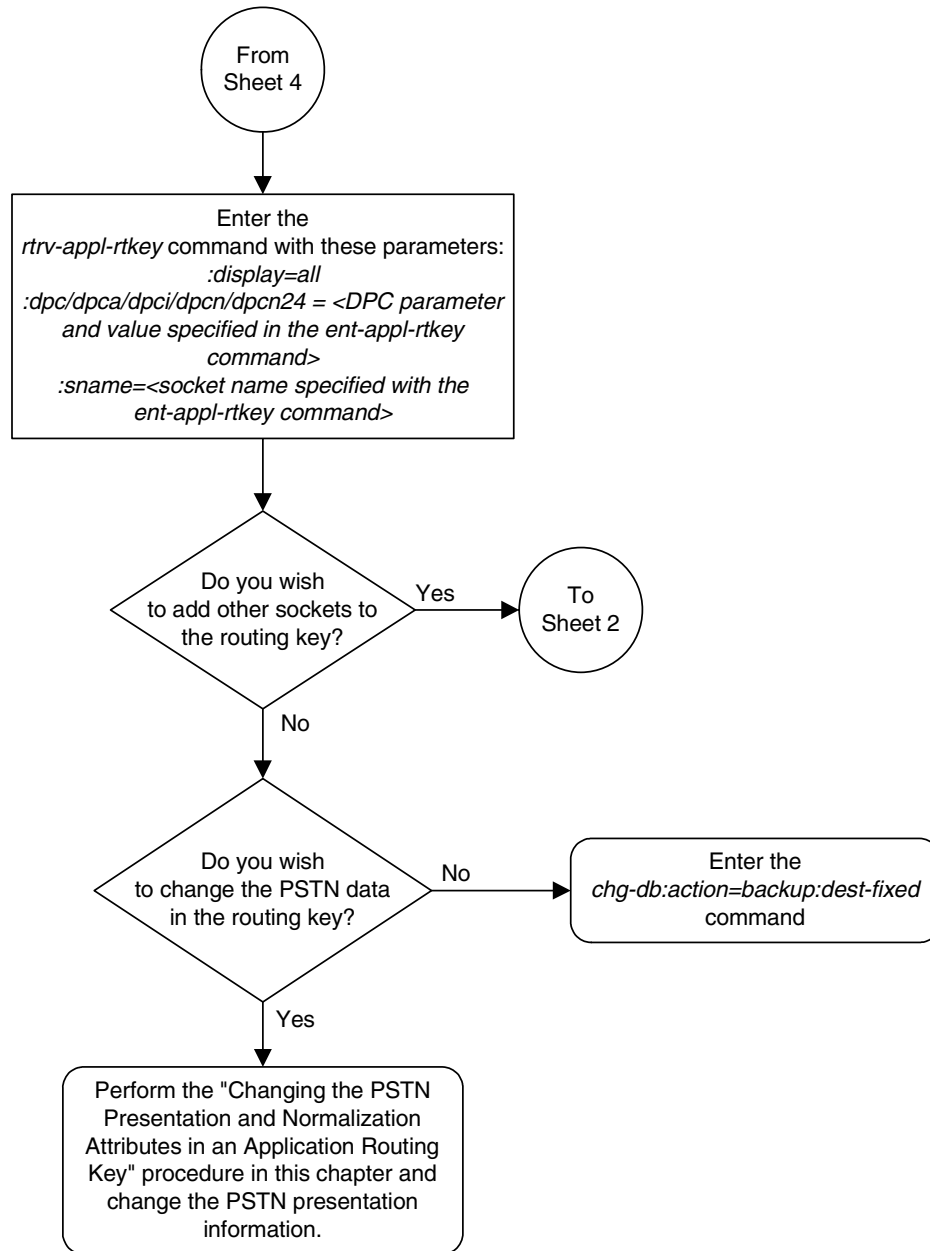

Adding a Routing Key Containing an Application Server

This procedure is used to add a routing key containing an application server to the database using the `ent-app1-rtkey` command.

A routing key defines a filter that checks the specified values in an incoming SS7 MSU to determine which, if any, socket or association receives the MSU. For more information about static routing keys, see “Understanding Routing for SS7IPGW and IPGWI Applications” on page 2-25.

The `ent-app1-rtkey` command uses these parameters.

:dpc/dpca/dpci/dpcn/dpcn24 – The destination point code value that is used to filter incoming MSUs. This parameter must not specify a cluster route. The destination point code of the routing key cannot be the APC of an IPGWx linkset or the SAPC assigned to an IPGWx linkset.

:opc/opca/opci/opcn/opcn24 – The originating point code value that is used to filter incoming MSUs. This parameter must not specify a cluster route. This parameter is valid only when the `si` parameter value is set to 4, 5, or 13. This parameter is required if `si=4, 5, or 13` and `type=full`.

NOTE: See the “Point Code Formats” section in the *Database Administration Manual - SS7* for a definition of the point code types that are used on the EAGLE 5 ISS and for a definition of the different formats that can be used for ITU national point codes.

:si – The service indicator value that is used to filter incoming MSUs. The range of values for the service indicator parameter (`si`) can be a numerical value from 0 to 15, or for selected service indicator values, a text string can be used instead of numbers. Table 3-18 shows the text strings that can be used in place of numbers for the service indicator values.

Table 3-18. Service Indicator Text String Values

| Service Indicator Value | Text String |
|-------------------------|-------------|
| 0 | snm |
| 1 | regtest |
| 2 | spltst |
| 3 | sccp |
| 4 | tup |
| 5 | isup |
| 13 | qbicc |

:ssn – The subsystem value that is used to filter incoming MSUs. The **ssn** parameter is only valid when the **si** parameter value is set to 3 or **sccp**.

:cics – The starting circuit identification code that is used to filter incoming MSUs. When specified with **cice**, **cics** identifies the start of the range of circuit identification codes. The **cics** parameter is valid only when the **si** parameter value is set to 4, 5, or 13. The **cics** is required if **si=4, 5, or 13** and **type=full**.

:cice – The ending circuit identification code that is used to filter incoming MSUs. When specified with **cics**, **cice** identifies the end of the range of circuit identification codes. The **cice** parameter is valid only when the **si** parameter value is set to 4, 5, or 13. The **cice** is required if **si=4, 5, or 13** and **type=full**.

:type – The routing key type – Identifies the type of routing key that is being entered and used to route message signaling units (MSUs). One of three values, **full/partial/default**, can be specified for the type parameter (see Table 3-19 on page 3-252). If **type** is not explicitly specified, **type = full** is assumed.

:asname – Application server (AS) name.

:rcontext – The routing context parameter, which has two functions:

- Provides an index of the application server traffic that the sending application server is configured or registered to receive.
- Identifies the SS7 network context for the message. The routing context parameter implicitly defines the SS7 point code format used, the SS7 network indicator value, and the SCCP protocol type/variant/version used.

The **ent-appl-rtkey** command also contains the **sname** (socket name) parameters which cannot be used in this procedure. The **sname** parameter and its use is discussed in more detail in the “Adding a Routing Key Containing a Socket” procedure on page 3-233 procedure.

Application server names are shown in the **rtrv-as** output.

Only one application server can be assigned to a routing key. There is a maximum of 1000 routing keys allowed per EAGLE 5 ISS (if there are any dual-slot DCM cards), or 2500 routing keys allowed per EAGLE 5 ISS (if all cards running the **ss7ipgw** or **ipgwi** application are SSEDCCM cards). Each of routing key's socket or application server names must be uniquely named.

The number of static routing keys is limited by the **srkq** parameter that was specified on the **chg-sg-opts** command.

Routing keys are associated only with the **ss7ipgw** or **ipgwi** application.

Group codes are required for 14-bit ITU-N point codes (DPCN/OPCN) when the Duplicate Point Code feature is enabled.

The starting circuit identification code must be less than or equal to the ending circuit identification code.

The ISUP routing over IP feature must be on in order to enter a routing key with these parameters: `dpc`, `si`, `opc`, `cics`, and `cice`. The `IPISUP` field in the `rtrv-feat` command output shows whether or not this feature is on.

The parameter combinations used by the `ent-app1-rtkey` command are based on the type of routing key and the service indicator value in the routing key. The parameter combinations are shown in Table 3-19.

Table 3-19. Routing Key Parameter Combinations for Adding a Routing Key Containing an Application Server

| SI=3 (SCCP) | | SI=4 (TUP), 5 (ISUP), 13 (QBICC) | | Other SI Values | | Default Routing Key |
|-------------------------------------|-------------------------------------|--|--|---|--|-------------------------------------|
| Full Routing Key | Partial Routing Key | Full Routing Key | Partial Routing Key | Full Routing Key | Partial Routing Key | |
| <code>dpc</code> ^{1, 2} | <code>type=partial</code> | <code>dpc</code> ^{1, 2} | <code>type=partial</code> | <code>dpc</code> ^{1, 2} | <code>type=partial</code> | <code>type=default</code> |
| <code>si=3</code> ⁴ | <code>dpc</code> ^{1, 2, 3} | <code>si=4, 5, 13</code> ⁴ | <code>dpc</code> ^{1, 2, 3} | <code>si=value other than 3, 4, 5, 13</code> ⁴ | <code>dpc</code> ^{1, 2, 3} | <code>asname</code> ¹⁰ |
| <code>ssn</code> | <code>si=3</code> ^{3, 4} | <code>opc</code> ^{1, 2} | <code>si=4, 5, 13</code> ^{3, 4, 10} | <code>type=full</code> | <code>si=value other than 3, 4, 5, 13</code> ^{3, 4, 10} | <code>rcontext</code> ¹⁰ |
| <code>type=full</code> | <code>asname</code> ¹⁰ | <code>cics</code> ^{5, 6, 7, 8, 9} | <code>opc</code> ^{1, 2, 3} | <code>asname</code> ¹⁰ | <code>asname</code> ¹⁰ | |
| <code>asname</code> ¹⁰ | <code>rcontext</code> ¹⁰ | <code>cice</code> ^{5, 6, 7, 8, 9} | <code>asname</code> ¹⁰ | <code>rcontext</code> ¹⁰ | <code>rcontext</code> ¹⁰ | |
| <code>rcontext</code> ¹⁰ | | <code>type=full</code> | <code>rcontext</code> ¹⁰ | | | |
| | | <code>asname</code> ¹⁰ | | | | |
| | | <code>rcontext</code> ¹⁰ | | | | |

Notes:

- The `dpc` and `opc` parameters can be either an ANSI point code (`dpca`, `opca`), ITU-I point code or ITU-I spare point code (`dpci`, `opci`), 14-bit ITU-N point code or 14-bit ITU-N spare point code (`dpcn`, `opcn`), or 24-bit ITU-N point code (`dpcn24`, `opcn24`). If the `dpc` and `opc` parameters are specified, the `dpc` and `opc` must be the same type of point code. For example, if the `dpca` parameter is specified, the OPC is specified with the `opca` parameter. If either point code value is a spare point code, the other point code value must be a spare point code on the same type. For example, if the `dpc` value is an ITU-I spare point code, the `opc` value must be an ITU-I spare point code.
- If the ITU National Duplicate Point Code feature is on, the values for the `dpcn` and `opcn` parameters must have group codes assigned to them. The field `ITUDUPPC` in the `rtrv-feat` command output shows whether or not the ITU National Duplicate Point Code feature is on. If group codes are specified for ITU-N DPC and OPC, the groups codes must be the same.
- These parameters are optional for partial routing keys, but at least one these parameters must be specified with the `ent-app1-rtkey` command.
- Text strings can be used in place of some numerical service indicator values. See Table 3-18 on page 3-250 for a list of these text strings.

Table 3-19. Routing Key Parameter Combinations for Adding a Routing Key Containing an Application Server (Continued)

| SI=3 (SCCP) | | SI=4 (TUP), 5 (ISUP), 13 (QBICC) | | Other SI Values | | Default Routing Key |
|---|---------------------|----------------------------------|---------------------|------------------|---------------------|---------------------|
| Full Routing Key | Partial Routing Key | Full Routing Key | Partial Routing Key | Full Routing Key | Partial Routing Key | |
| <p>5. When the service indicator parameter value equals 4 and an ANSI dpc is specified, the <code>opc</code>, <code>cics</code>, and <code>cice</code> parameters cannot be used. If the service indicator parameter value equals 4 and an ITU dpc is specified, the <code>opc</code>, <code>cics</code>, and <code>cice</code> parameters are required.</p> <p>6. If the service indicator parameter (<code>si</code>) value is 4, the values of the <code>cics</code> and <code>cice</code> parameters is from 0 to 4095.</p> <p>7. If the service indicator parameter (<code>si</code>) value is 5 and the point code in the routing key is either an ITU-I, 14-bit ITU-N, or 24-bit ITU-N point code, the values of the <code>cics</code> and <code>cice</code> parameters is from 0 to 4095. If the point code in the routing key is an ANSI point code, the values of the <code>cics</code> and <code>cice</code> parameters is from 0 to 16383.</p> <p>8. If the service indicator parameter value is 13, the values of the <code>cics</code> and <code>cice</code> parameters is from 0 to 4294967295.</p> <p>9. The CIC range, defined by the <code>cics</code> and <code>cice</code> parameters, cannot overlap the CIC range in an existing routing key.</p> <p>10. The following rules apply to using the <code>rcontext</code> parameter.</p> <ul style="list-style-type: none"> • The value of the <code>rcontext</code> parameter is from 0 to 4294967295. • The <code>rcontext</code> parameter is required for a routing key containing an SUA application server. • The <code>rcontext</code> parameter is optional for a routing key containing an M3UA application server. • The <code>rcontext</code> parameter value must be unique in the database. Multiple routing keys cannot have the same <code>rcontext</code> value assigned. • An application server can be assigned to only one routing key containing a routing context value. • If the application server being assigned to the new routing key is assigned to other routing keys that do not contain <code>rcontext</code> parameter values, the <code>rcontext</code> parameter cannot be specified for the new routing key. • An application server can be assigned to multiple routing keys if those routing keys do not contain a routing context value. • An application server can be assigned to either a routing key containing a routing context value, or to routing keys that do not contain a routing context value, but the application server cannot be assigned to both types of routing keys. • In order for an M3UA or SUA association to be assigned to multiple routing keys with a routing context value, the M3UA or SUA association must be assigned to multiple application servers and then each application server must be assigned to a routing key containing a routing context value. | | | | | | |

Canceling the `RTRV-AS` and `RTRV-APPL-RTKEY` Commands

Because the `rtrv-as` and `rtrv-appl-rtkey` commands used in this procedure can output information for a long period of time, the `rtrv-as` and `rtrv-appl-rtkey` commands can be canceled and the output to the terminal stopped. There are three ways that the `rtrv-as` and `rtrv-appl-rtkey` commands can be canceled.

- Press the **F9** function key on the keyboard at the terminal where the `rtrv-as` or `rtrv-appl-rtkey` commands were entered.

- Enter the **canc-cmd** without the **trm** parameter at the terminal where the **rtrv-as** or **rtrv-appl-rtkey** commands were entered.
- Enter the **canc-cmd:trm=<xx>**, where **<xx>** is the terminal where the **rtrv-as** and **rtrv-appl-rtkey** commands were entered, from another terminal other than the terminal where the **rtrv-as** or **rtrv-appl-rtkey** commands were entered. To enter the **canc-cmd:trm=<xx>** command, the terminal must allow Security Administration commands to be entered from it and the user must be allowed to enter Security Administration commands. The terminal's permissions can be verified with the **rtrv-secu-trm** command. The user's permissions can be verified with the **rtrv-user** or **rtrv-secu-user** commands.

For more information about the **canc-cmd** command, go to the *Commands Manual*.

Procedure

1. Display the current routing key information in the database by entering the **rtrv-appl-rtkey** command. The following is an example of the possible output.

```
rlghncxa03w 06-10-28 21:15:37 GMT EAGLE5 36.0.0

RCONTEXT  DPC          SI  ADPTR  ASNAME          TYPE  LOC
-----
123-234-123  5  TALI  -----  FULL  STATIC
123-234-123  5  TALI  -----  FULL  STATIC
005-005-001  5  TALI  -----  FULL  1105
005-005-001  5  TALI  -----  FULL  1105
006-006-001  5  TALI  -----  FULL  1107
006-006-001  5  TALI  -----  FULL  1107

RCONTEXT  DPCI          SI  ADPTR  ASNAME          TYPE  LOC
-----
2-100-7     6  M3UA  as4         FULL  STATIC
100         3-137-6     6  SUA   as1         FULL  STATIC
225         4-035-7     5  M3UA  as5         FULL  STATIC
-----
6-006-6     5  TALI  -----  FULL  STATIC
6-006-7     6  TALI  -----  FULL  STATIC
6-006-8     3  M3UA  as3         FULL  STATIC
6-006-8     5  M3UA  as2         FULL  STATIC
6-024-7     5  M3UA  as4         FULL  STATIC
6-024-7     5  M3UA  as4         FULL  STATIC
300         7-008-7     6  SUA   as6         FULL  STATIC

RCONTEXT  DPCN          SI  ADPTR  ASNAME          TYPE  LOC
-----

RCONTEXT  DPCN24        SI  ADPTR  ASNAME          TYPE  LOC
-----

RCONTEXT  DPC          SI  ADPTR  ASNAME          TYPE  LOC
-----
***** **  TALI  -----  DEFAULT  STATIC

STATIC Route Key table is (13 of 2000) 1% full
1105  Route Key table is (2 of 500) 1% full
1107  Route Key table is (2 of 500) 1% full

STATIC Route Key Socket Association table is (13 of 32000) 1% full
1105  Route Key Socket Association table is (2 of 8000) 1% full
1107  Route Key Socket Association table is (2 of 8000) 1% full
```

The database can contain only one default routing key. If the `rtrv-appl-rtkey` output contains a default routing key, a default routing key cannot be added in this procedure. Go to step 2 to add either a full or partial routing key with the desired application server.

2. Display the current application server information in the database by entering the `rtrv-as` command. The following is an example of the possible output.

```
rlghncxa03w 06-10-28 09:12:36 GMT EAGLE5 36.0.0

AS Name          Mode          Tr ms  Association Names
as1              LOADSHARE    10     assoc1
                LOADSHARE    10     assoc2
                LOADSHARE    10     assoc3
                LOADSHARE    10     assoc5
                LOADSHARE    10     assoc6

as2              OVERRIDE     10     assoc7

as3              LOADSHARE    10     assoc8
                LOADSHARE    10     assoc9

as4              LOADSHARE    10     assoc10
                LOADSHARE    10     assoc11

as5              LOADSHARE    10     assoc12
                LOADSHARE    10     assoc13

AS Table is (5 of 250) 1% full
```

If the required application server is not in the database, perform one of these procedures to add the application server:

- “Adding a New Association to a New Application Server” procedure on page 3-397
- “Adding an Existing Association to a New Application Server” procedure on page 3-406
- “Adding a New Association to an Existing Application Server” procedure on page 3-417
- “Adding an Existing Association to an Existing Application Server” procedure on page 3-429.

If the `rcontext` parameter will not be specified for the routing key, make sure that the `adapter` parameter value for the associations assigned to the new application server is **M3UA**.

If the `rcontext` parameter will be specified for the routing key, make sure that the `open` parameter value of the associations is set to `no`. The `adapter` parameter value of these associations can be either **SUA** or **M3UA**.

SUA associations, and their corresponding application server, can be assigned to only these types of routing keys:

- Full routing key – DPC/SI=3/SSN

- Partial routing key – DPC/SI=3
- Partial routing key – DPC only
- Partial routing key – SI=3 only
- Default routing key.

After the new application server is added to the database, go to step 4.

3. Display the routing keys containing the application server being used in this procedure by entering the **rtrv-app1-rtkey** command with the application server name and the **display=all** parameter. For this example, enter these commands.

```
rtrv-app1-rtkey:asname=as4:display=all
```

The following is an example of the possible output.

```
rlghncxa03w 06-10-28 09:12:36 GMT EAGLE5 36.0.0

RCONTEXT  DPCI          SI SSN OPCI          CICS    CICE    LOC
-----  -
          6-024-7    5 ---  1-057-4      150     175     STATIC

          ADPTR  TYPE      ASNAME
          M3UA  FULL     as4

          ANAMES
          assoc11          assoc12

RCONTEXT  DPCI          SI SSN OPCI          CICS    CICE    LOC
-----  -
          2-100-7    6 ---  -----      -----  -----  -----

          ADPTR  TYPE      ASNAME
          M3UA  FULL     as4

          ANAMES
          assoc11          assoc12

STATIC Route Key table is (7 of 2000) 1% full
1105  Route Key table is (2 of 500) 1% full
1107  Route Key table is (2 of 500) 1% full

STATIC Route Key Socket Association table is (7 of 32000) 1% full
1105  Route Key Socket Association table is (2 of 8000) 1% full
1107  Route Key Socket Association table is (2 of 8000) 1% full
```

rtrv-appl-rtkey:asname=as5:display=all

The following is an example of the possible output.

rlghncxa03w 06-10-28 09:12:36 GMT EAGLE5 36.0.0

| RCONTEXT | DPCI | SI | SSN | OPCI | CICS | CICE | LOC |
|----------|---------|----|-----|---------|------|------|--------|
| 225 | 4-035-7 | 5 | --- | 3-200-4 | 200 | 300 | STATIC |

| ADPTR | TYPE | ASNAME |
|-------|------|--------|
| M3UA | FULL | as5 |

| ANAMES |
|------------------------------------|
| assoc15 assoc16 |

STATIC Route Key table is (7 of 2000) 1% full

1105 Route Key table is (2 of 500) 1% full

1107 Route Key table is (2 of 500) 1% full

STATIC Route Key Socket Association table is (7 of 32000) 1% full

1105 Route Key Socket Association table is (2 of 8000) 1% full

1107 Route Key Socket Association table is (2 of 8000) 1% full

If the application server is not assigned to any routing keys, the **rcontext** parameter can be specified for the new routing key using this application server. Go to step 4.

An application server can be assigned to only one routing key containing a routing context value. If the application server is assigned to other routing keys, the **rcontext** parameter cannot be specified for the new routing key being added in this procedure. If you wish to use the **rcontext** parameter for the new routing key, perform one of these procedures to add the application server:

- “Adding a New Association to a New Application Server” procedure on page 3-397
- “Adding an Existing Association to a New Application Server” procedure on page 3-406
- “Adding a New Association to an Existing Application Server” procedure on page 3-417
- “Adding an Existing Association to an Existing Application Server” procedure on page 3-429.

After the new application server is added, go to step 6.

If the application server is assigned to other routing keys, and these routing keys do not contain **rcontext** parameter values, the application server can be assigned to the new routing key in this procedure, but the **rcontext** parameter cannot be specified for the new routing key.

If you do not wish to use the **rcontext** parameter for the new routing key, go to step 6.

4. Display the associations assigned to the application server displayed in step 3, to verify the **open** parameter value of the association, using the **rtrv-assoc** command with the association names shown in step 2. For this example, enter these commands.

```
rtrv-assoc:aname=assoc11
```

This is an example of possible output.

```
rlghncxa03w 06-10-28 09:12:36 GMT EAGLE5 36.0.0
ANAME assoc11
  LOC      1203          IPLNK PORT  A          LINK  A
  ADAPTER  M3UA          VER          M3UA RFC
  LHOST    gw110.nc.tekelec.com
  ALHOST   ---
  RHOST    gw100.nc.tekelec.com
  LPORT    1030          RPORT        1030
  ISTRMS   2            OSTRMS       2            BUFSIZE  16
  RMODE    LIN          RMIN         120          RMAX      800
  RTIMES   10          CWMIN        3000         UAPS      10
  OPEN     YES          ALW          YES

  ASNAMES
  as4
```

```
IP Appl Sock table is (10 of 4000) 1% full
Assoc Buffer Space Used (16 KB of 800 KB) on LOC = 1203
```

```
rtrv-assoc:aname=assoc12
```

This is an example of possible output.

```
rlghncxa03w 06-10-28 09:12:36 GMT EAGLE5 36.0.0
ANAME assoc12
  LOC      1204          IPLNK PORT  A          LINK  A
  ADAPTER  M3UA          VER          M3UA RFC
  LHOST    gw200.nc.tekelec.com
  ALHOST   ---
  RHOST    gw100.nc.tekelec.com
  LPORT    2564          RPORT        1030
  ISTRMS   2            OSTRMS       2            BUFSIZE  16
  RMODE    LIN          RMIN         120          RMAX      800
  RTIMES   10          CWMIN        3000         UAPS      10
  OPEN     YES          ALW          YES

  ASNAMES
  as4
```

```
IP Appl Sock table is (10 of 4000) 1% full
Assoc Buffer Space Used (16 KB of 800 KB) on LOC = 1204
```

```
rtrv-assoc:aname=assoc15
```

This is an example of possible output.

```
rlghncxa03w 06-10-28 09:12:36 GMT EAGLE5 36.0.0
ANAME assoc15
  LOC      1207          IPLNK PORT  A          LINK  A
  ADAPTER  SUA           VER          SUA RFC
  LHOST    gw150.nc.tekelec.com
  ALHOST   ---
  RHOST    gw100.nc.tekelec.com
  LPORT    1500          RPORT        1030
  ISTRMS   2            OSTRMS       2            BUFSIZE  16
```

IP7 Secure Gateway Configuration Procedures

```
RMODE    LIN           RMIN      120      RMAX      800
RTIMES   10           CWMIN    3000    UAPS      10
OPEN     YES          ALW      YES
```

```
ASNAMES
as5
```

```
IP Appl Sock table is (4 of 4000) 1% full
Assoc Buffer Space Used (16 KB of 800 KB) on LOC = 1207
```

```
rtrv-assoc:aname=assoc16
```

This is an example of possible output.

```
rlghncxa03w 06-10-28 09:12:36 GMT EAGLE5 36.0.0
ANAME assoc16
  LOC      1211          IPLNK PORT  A          LINK  A
  ADAPTER  SUA          VER        SUA RFC
  LHOST    gw160.nc.tekelec.com
  ALHOST   ---
  RHOST    gw100.nc.tekelec.com
  LPORT    3571          RPORT      1030
  ISTRMS   2            OSTRMS     2          BUFSIZE  16
  RMODE    LIN           RMIN      120      RMAX      800
  RTIMES   10           CWMIN    3000    UAPS      10
  OPEN     YES          ALW      YES

ASNAMES
as5
```

```
IP Appl Sock table is (4 of 4000) 1% full
Assoc Buffer Space Used (16 KB of 800 KB) on LOC = 1211
```

Repeat this step for each association name displayed in step 3 to verify the **open** parameter of each association assigned to the application server.

NOTE: If a new application server was added in step 2, skip step 5 and go to step 6.

NOTE: If the **rcontext** parameter is not being specified in this procedure, skip step 5 and go to step 6.

NOTE: If the **open** parameter value for all the associations assigned to the application server is **no** (shown in step 4), skip step 5 and go to step 6.

5. Change the value of the **open** parameter to **no** by specifying the **chg-assoc** command with the **open=no** parameter. For this example, enter this command.

```
chg-assoc:aname=assoc11:open=no
```

```
chg-assoc:aname=assoc12:open=no
```

```
chg-assoc:aname=assoc15:open=no
```

```
chg-assoc:aname=assoc16:open=no
```

```
chg-assoc:aname=assoc20:open=no
```

When each of these commands have successfully completed, this message should appear.

```
rlghncxa03w 06-10-28 09:12:36 GMT EAGLE5 36.0.0
CHG-ASSOC: MASP A - COMPLTD
```



CAUTION: The IP connections using the associations specified in this step will not be able to carry any traffic when the `open` parameter is changed to `no`.

Repeat this step for all the associations assigned to the application server that have the `open=yes` parameter value.

NOTE: If a default routing key with an application server name is being added in this procedure, skip steps 6, 7, 8, 9, and 10, and go to step 11.

NOTE: If ITU-I or 14-bit ITU-N spare point codes are not being assigned to the routing key, or if ITU-I or 14-bit ITU-N spare point codes are shown in any routing keys shown in the `rtrv-app-rtkey` output in step 1, skip this step and go to step 7.

6. Display the status of the ITU National and International Spare Point Code Support feature by entering the `rtrv-ctrl-feat` command with the ITU National and International Spare Point Code Support feature part number. Enter this command.

```
rtrv-ctrl-feat:partnum=893013601
```

The following is an example of the possible output.

```
rlghncxa03w 06-10-28 21:15:37 GMT EAGLE5 36.0.0
The following features have been permanently enabled:
```

| Feature Name | Partnum | Status | Quantity |
|--------------------------|-----------|--------|----------|
| Spare Point Code Support | 893013601 | on | ---- |

The following features have been temporarily enabled:

| Feature Name | Partnum | Status | Quantity | Trial Period Left |
|---------------------|---------|--------|----------|-------------------|
| Zero entries found. | | | | |

The following features have expired temporary keys:

| Feature Name | Partnum |
|---------------------|---------|
| Zero entries found. | |

If the ITU National and International Spare Point Code Support feature is not enabled, perform the “Activating the ITU National and International Spare Point Code Support feature” procedure in the *Database Administration Manual - SS7* and enable and turn on the ITU National and International Spare Point Code Support feature.

-
7. The DPC of the routing key cannot be the APC of an IPGWx linkset or an SAPC assigned to an IPGWx linkset. Display the names of the IPGWx linksets by entering the `rept-stat-iptps` command. This is an example of the possible output.

```
rlghncxa03w 06-10-10 11:43:04 GMT EAGLE5 36.0.0
```

```
IP TPS USAGE REPORT
```

| THRESH | CONFIG | TPS | PEAK | PEAKTIMESTAMP |
|--------|--------|-----|------|---------------|
|--------|--------|-----|------|---------------|

IP7 Secure Gateway Configuration Procedures

```

-----
SYSTEM
RLGHNCXA03W 100% 50000 TX: 7200 7600 05-02-10 11:40:04
                    RCV: 7200 7600 05-02-10 11:40:04
-----
LSN
LSGW1201      80% 10000 TX: 7200 7600 05-02-10 11:40:04
                    RCV: 7200 7600 05-02-10 11:40:04
LSGW1204      80% 10000 TX: 6700 7600 05-02-10 11:40:04
                    RCV: 6500 7600 05-02-10 11:40:04
LSGW1207      80% 10000 TX: 7300 7450 05-02-10 11:40:04
                    RCV: 7300 7450 05-02-10 11:40:04
LSGW1211      80% 10000 TX: 7400 7450 05-02-10 11:40:04
                    RCV: 7400 7450 05-02-10 11:40:04
-----
Command Completed.

```

8. Display the IPGWx linksets shown in the `rept-stat-iptps` output in step 7 using the `rtrv-ls` command and specifying the name of the linkset shown in step 7. For this example, enter these commands.

```
rtrv-ls:lsn=lsgw1201
```

This is an example of the possible output

```

rlghncxa03w 06-10-28 16:31:35 GMT EAGLE5 36.0.0
                    L3T SLT                      GWS GWS GWS
LSN      APCA  (SS7)  SCRN  SET SET BEI LST LNKS ACT MES DIS SLSCI NIS
lsgw1201 240-020-000 scr1  1  1  yes A  1  off off off yes  off

IPGWAPC MATELSN  IPTPS LSUSEALM SLKUSEALM GTTMODE
yes      ----- 10000 70      % 70      % CdPA

LOC LINK SLC TYPE          L2T          L1          PCR PCR
SET BPS          MODE TSET  ECM  N1  N2

LOC LINK SLC TYPE          LP          ATM          VCI  VPI  LL
SET BPS          TSEL

LOC LINK SLC TYPE          LP          ATM          VCI  VPI  CRC4 SI SN
SET BPS          TSEL

LOC LINK SLC TYPE          IPLIML2

LOC LINK SLC TYPE
1201 A  0  SS7IPGW

LOC LINK SLC TYPE          L2T          PCR PCR  E1  E1
SET BPS          ECM  N1  N2  LOC PORT TS

LOC LINK SLC TYPE          L2T          PCR PCR  T1  T1
SET BPS          ECM  N1  N2  LOC PORT TS

Link set table is (14 of 1024) 1% full

```

```
rtrv-ls:lsn=lsgw1204
```

This is an example of the possible output.

```

rlghncxa03w 06-10-17 11:43:04 GMT EAGLE5 36.0.0
                    L3T SLT                      GWS GWS GWS
LSN      APCN  (SS7)  SCRN  SET SET BEI LST LNKS ACT MES DIS SLSCI NIS
lsgw1204 2968          none  1  1  no  A  1  off off off ---  off

```

IP⁷ Secure Gateway Configuration Procedures

```

CLLI          TFATCABMLQ  MTPRSE  ASL8  SLRSRB  MULTGC  ITUTFR
----- 1          ---    ---    1      no      off

IPGWAPC MATELSN  IPTPS  LSUSEALM  SLKUSEALM  GTTMODE
yes      ----- 10000 70      % 70      % CdPA

LOC LINK SLC TYPE      L2T      L1      PCR PCR
SET BPS  MODE TSET  ECM  N1  N2

LOC LINK SLC TYPE      LP      ATM
SET BPS  TSEL      VCI  VPI  LL

LOC LINK SLC TYPE      LP      ATM      E1ATM
SET BPS  TSEL      VCI  VPI  CRC4 SI SN

LOC LINK SLC TYPE      IPLIML2

LOC LINK SLC TYPE
1204 A  0  IPGWI

LOC LINK SLC TYPE      L2T      PCR PCR  E1  E1
SET BPS  ECM  N1  N2  LOC  PORT TS

LOC LINK SLC TYPE      L2T      PCR PCR  T1  T1
SET BPS  ECM  N1  N2  LOC  PORT TS

SAPCI
1-010-1

```

Link set table is (14 of 1024) 1% full.

rtrv-ls:lsn=lsgw1207

This is an example of the possible output.

```

rlghncxa03w 06-10-17 11:43:04 GMT EAGLE5 36.0.0
                L3T SLT                GWS GWS GWS
LSN          APCI  (SS7)  SCRNR  SET SET BEI LST LNKS ACT MES DIS SLSCI NIS
lsgw1207     2-154-0      none  1  1  no  A  1  off off off ---  off

CLLI          TFATCABMLQ  MTPRSE  ASL8  SLRSRB  MULTGC  ITUTFR
----- 1          ---    ---    1      no      off

IPGWAPC MATELSN  IPTPS  LSUSEALM  SLKUSEALM  GTTMODE
yes      ----- 10000 70      % 70      % CdPA

LOC LINK SLC TYPE      L2T      L1      PCR PCR
SET BPS  MODE TSET  ECM  N1  N2

LOC LINK SLC TYPE      LP      ATM
SET BPS  TSEL      VCI  VPI  LL

LOC LINK SLC TYPE      LP      ATM      E1ATM
SET BPS  TSEL      VCI  VPI  CRC4 SI SN

LOC LINK SLC TYPE      IPLIML2

LOC LINK SLC TYPE
1207 A  0  IPGWI

LOC LINK SLC TYPE      L2T      PCR PCR  E1  E1
SET BPS  ECM  N1  N2  LOC  PORT TS

```

IP7 Secure Gateway Configuration Procedures

```

                L2T          PCR PCR T1 T1
LOC LINK SLC TYPE SET BPS ECM N1 N2 LOC PORT TS

SAPCN
5823

```

Link set table is (14 of 1024) 1% full.

rtrv-ls:lsn=lsgw1211

This is an example of the possible output

```

rlghncxa03w 06-10-28 16:31:35 GMT EAGLE5 36.0.0
                L3T SLT          GWS GWS GWS
LSN          APCA (SS7) SCRN SET SET BEI LST LNKS ACT MES DIS SLSCI NIS
lsgw1211     010-130-057 scr1 1 1 yes A 1 off off off yes off

IPGWAPC MATELSN IPTPS LSUSEALM SLKUSEALM GTTMODE
yes ----- 10000 70 % 70 % CdPA

                L2T          L1          PCR PCR
LOC LINK SLC TYPE SET BPS MODE TSET ECM N1 N2

                LP          ATM
LOC LINK SLC TYPE SET BPS TSEL VCI VPI LL

                LP          ATM          E1ATM
LOC LINK SLC TYPE SET BPS TSEL VCI VPI CRC4 SI SN

LOC LINK SLC TYPE IPLIML2

LOC LINK SLC TYPE
1211 A 0 SS7IPGW

                L2T          PCR PCR E1 E1
LOC LINK SLC TYPE SET BPS ECM N1 N2 LOC PORT TS

                L2T          PCR PCR T1 T1
LOC LINK SLC TYPE SET BPS ECM N1 N2 LOC PORT TS

```

Link set table is (14 of 1024) 1% full

If the DPC of the routing key is shown in the **rtrv-ls** outputs in this step, choose another DPC value for the routing key that is not shown in the **rtrv-ls** outputs in this step.

NOTE: If the SI value of the routing key being added is a value other than 4, 5, or 13, skip steps 9 and 10, and go to step 11.

- Verify that the ISUP Routing over IP feature is on, by entering the **rtrv-feat** command. If the ISUP Routing over IP feature is on, the **IPISUP** field should be set to **on**. For this example, the ISUP Routing over IP feature is off.

NOTE: The **rtrv-feat** command output contains other fields that are not used by this procedure. If you wish to see all the fields displayed by the **rtrv-feat** command, see the **rtrv-feat** command description in the *Commands Manual*.

NOTE: If the ISUP Routing over IP feature is on, skip step 10 and go to step 11.

10. Turn the ISUP Routing over IP feature on by entering this command.

```
chg-feat:ipisup=on
```

NOTE: Once the ISUP Routing over IP feature is turned on with the `chg-feat` command, it cannot be turned off.

The ISUP Routing over IP feature must be purchased before you turn this feature on with the `chg-feat` command. If you are not sure if you have purchased the ISUP Routing over IP feature, contact your Tekelec Sales Representative or Account Representative.

When the `chg-feat` has successfully completed, this message should appear.

```
rlghncxa03w 06-10-28 11:43:04 GMT EAGLE5 36.0.0
CHG-FEAT: MASP A - COMPLTD
```

11. Add a routing key entry to the database by entering the `ent-appl-rtkey` command. The parameters required for the `ent-appl-rtkey` command are determined by the type of routing key being added and the service indicator value in the routing key. See Table 3-19 on page 3-252 for the parameter combinations that can be used for the type of routing key being added to the database.

For this example, enter these commands.

```
ent-appl-rtkey:dpci=3-009-3:si=5:opci=4-100-3:cics=100
:cice=500:asname=as3:type=full
```

```
ent-appl-rtkey:dpci=1-050-2:si=5:opci=6-077-7:cics=200
:cice=300:asname=as20:type=full:rcontext=2000
```

NOTE: A routing key cannot be added with the application server `as4`, displayed in step 3, because application server `as4` is assigned to a routing key containing a routing context value. Only one application server can be assigned to a routing key containing a routing context value.

When each of these commands have successfully completed, the following message should appear.

```
rlghncxa03w 06-10-28 21:15:37 GMT EAGLE5 36.0.0
ENT-APPL-RTKEY: MASP A - COMPLTD
```

12. Verify the new routing key information in the database by entering the **rtrv-appl-rtkey** command with the routing key parameters specified in step 11 (**dpc**, **si**, **opc**, **cics**, **cice**, **ssn**, **asname**, **type**, and **rcontext**, as applicable) with the **display=all** parameter. For this example, enter these commands.

```
rtrv-appl-rtkey:dpci=3-009-3:si=5:opci=4-100-3:cics=100
:cice=500:asname=as3:type=full:display=all
```

The following is an example of the possible output.

```
rlghncxa03w 06-10-28 21:16:37 GMT EAGLE5 36.0.0
```

| RCONTEXT | DPCI | SI | SSN | OPCI | CICS | CICE | LOC |
|----------|---------|----|-----|---------|------|------|--------|
| ----- | 3-009-3 | 5 | --- | 4-100-3 | 100 | 500 | STATIC |

| ADPTR | TYPE | ASNAME |
|-------|------|--------|
| M3UA | FULL | as3 |

| ANAMES |
|------------------------------------|
| assoc11 assoc12 |

```
STATIC Route Key table is (12 of 2000) 1% full
1105 Route Key table is (2 of 500) 1% full
1107 Route Key table is (2 of 500) 1% full
```

```
STATIC Route Key Socket Association table is (12 of 32000) 1% full
1105 Route Key Socket Association table is (2 of 8000) 1% full
1107 Route Key Socket Association table is (2 of 8000) 1% full
```

```
rtrv-appl-rtkey:dpci=1-050-2:si=5:opci=6-077-7:cics=200
:cice=300:asname=as20:type=full:rcontext=2000:display=all
```

The following is an example of the possible output.

```
rlghncxa03w 06-10-28 21:16:37 GMT EAGLE5 36.0.0
```

| RCONTEXT | DPCI | SI | SSN | OPCI | CICS | CICE | LOC |
|----------|---------|----|-----|---------|------|------|--------|
| 2000 | 1-050-2 | 5 | --- | 6-077-7 | 200 | 300 | STATIC |

| ADPTR | TYPE | ASNAME |
|-------|------|--------|
| SUA | FULL | as20 |

| ANAMES |
|---------|
| assoc20 |

```
STATIC Route Key table is (12 of 2000) 1% full
1105 Route Key table is (2 of 500) 1% full
1107 Route Key table is (2 of 500) 1% full
```

```
STATIC Route Key Socket Association table is (12 of 32000) 1% full
1105 Route Key Socket Association table is (2 of 8000) 1% full
1107 Route Key Socket Association table is (2 of 8000) 1% full
```

NOTE: If the **open** parameter value of the associations assigned to the routing key added in this procedure was not changed (step 5 was not performed), skip this step and go to step 12.

13. Change the value of the **open** parameter of the associations that were changed in step 5 to **yes** by specifying the **chg-assoc** command with the **open=yes** parameter. For this example, enter these commands.

```
chg-assoc:aname=assoc11:open=yes
chg-assoc:aname=assoc12:open=yes
chg-assoc:aname=assoc15:open=yes
chg-assoc:aname=assoc16:open=yes
chg-assoc:aname=assoc20:open=yes
```

When each of these commands have successfully completed, this message should appear.

```
rlghncxa03w 06-10-28 09:12:36 GMT EAGLE5 36.0.0
CHG-ASSOC: MASP A - COMPLTD;
```

Repeat this step for all the associations that were changed in step 5.

14. Back up the new changes using the **chg-db:action=backup:dest=fixed** command. These messages should appear, the active Maintenance and Administration Subsystem Processor (MASP) appears first.

```
BACKUP (FIXED) : MASP A - Backup starts on active MASP.
BACKUP (FIXED) : MASP A - Backup on active MASP to fixed disk complete.
BACKUP (FIXED) : MASP A - Backup starts on standby MASP.
BACKUP (FIXED) : MASP A - Backup on standby MASP to fixed disk complete.
```

Flowchart 3-22. Adding a Routing Key Containing an Application Server
(Sheet 1 of 5)

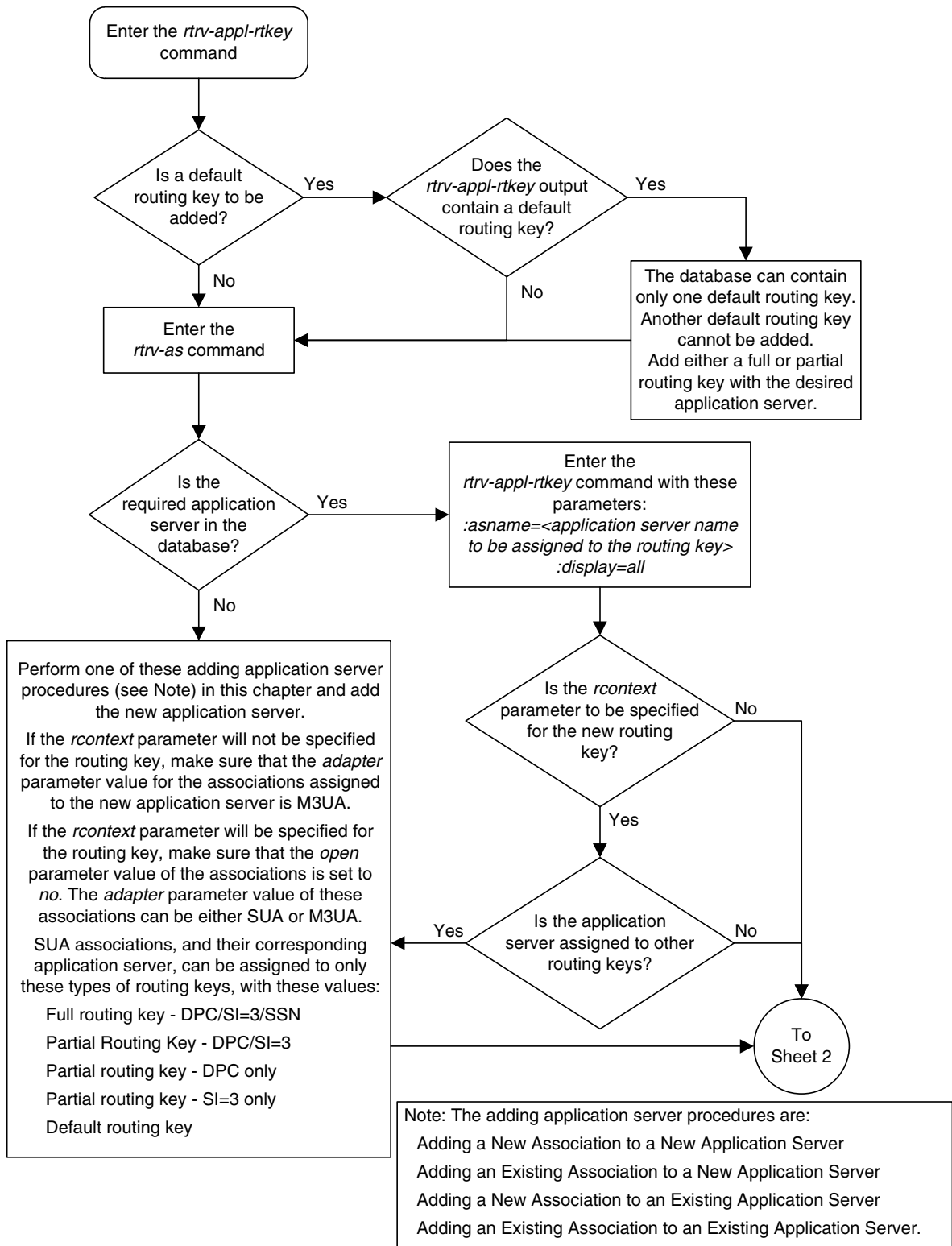

Flowchart 3-22. Adding a Routing Key Containing an Application Server
(Sheet 2 of 5)

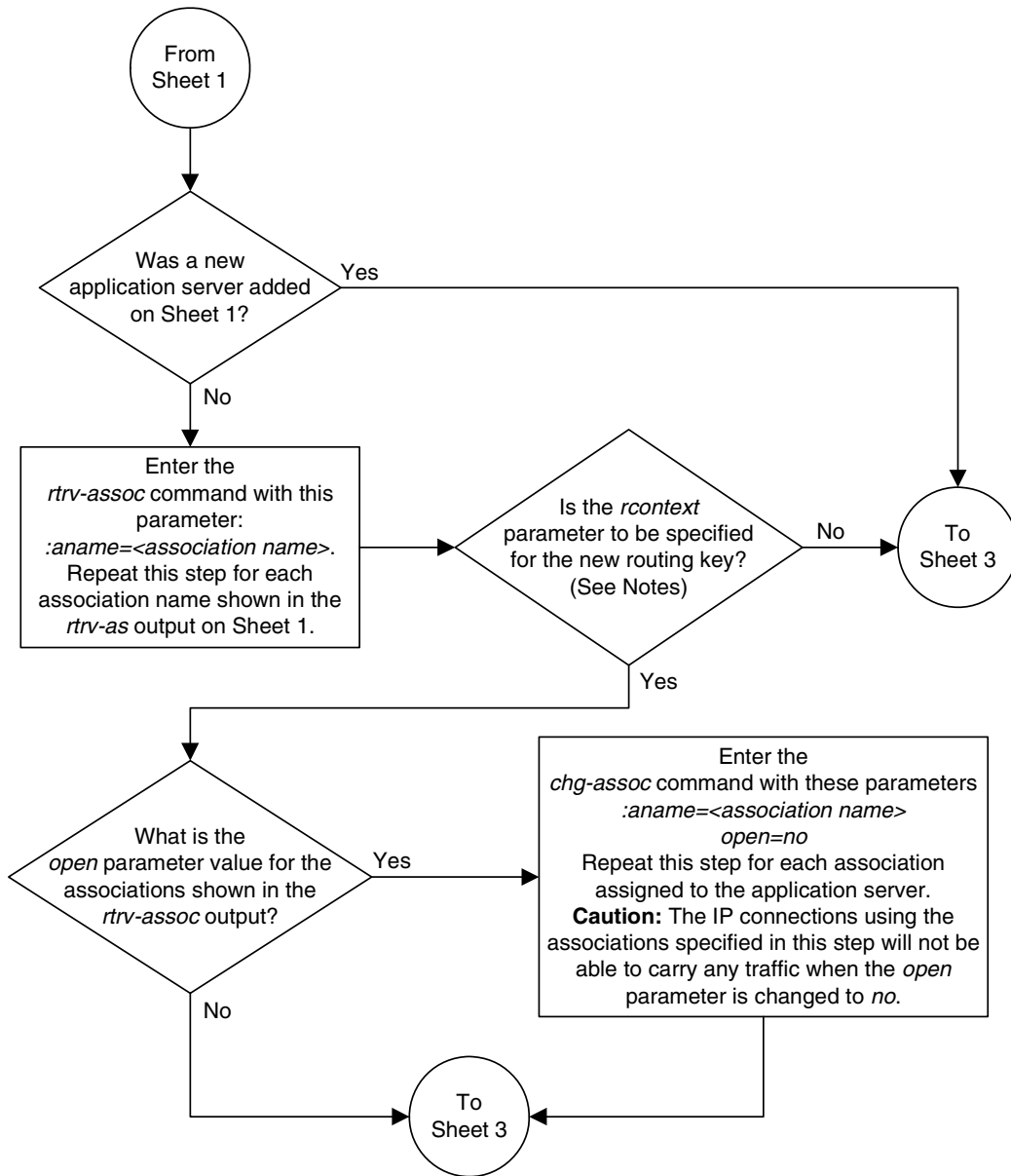

Notes:

1. If the *adapter* parameter value for the application server is SUA, and a new application server is specified for the routing key, the *rcontext* parameter is required.
2. If the *adapter* parameter value for the application server is M3UA, and a new application server is specified for the routing key, the *rcontext* parameter is optional.
3. If the application server is assigned to other routing keys, the *rcontext* parameter cannot be specified for this routing key. An application server can be assigned to only one routing key that contains an *rcontext* parameter value.

Flowchart 3-22. Adding a Routing Key Containing an Application Server
(Sheet 3 of 5)

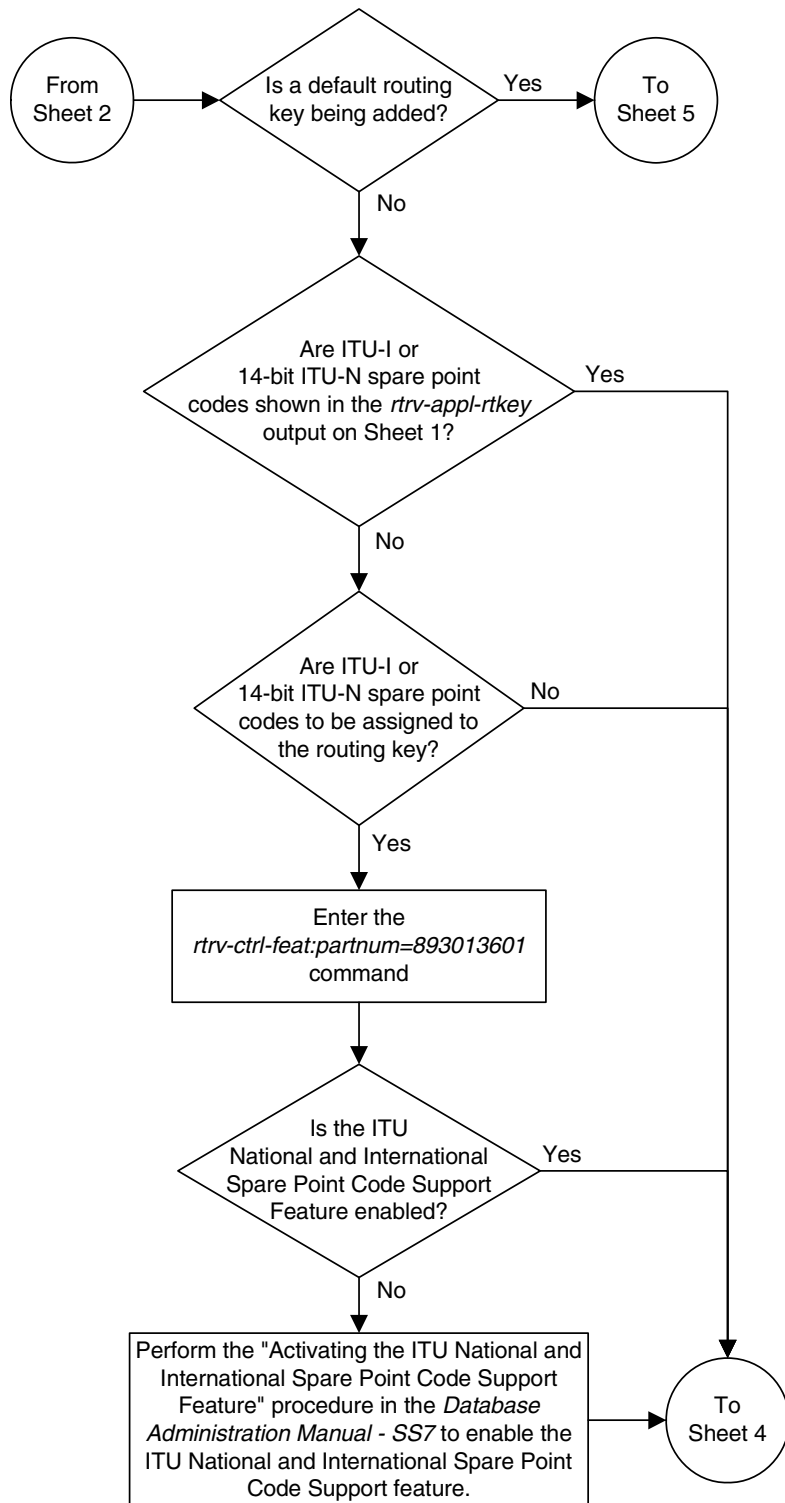

Flowchart 3-22. Adding a Routing Key Containing an Application Server
(Sheet 4 of 5)

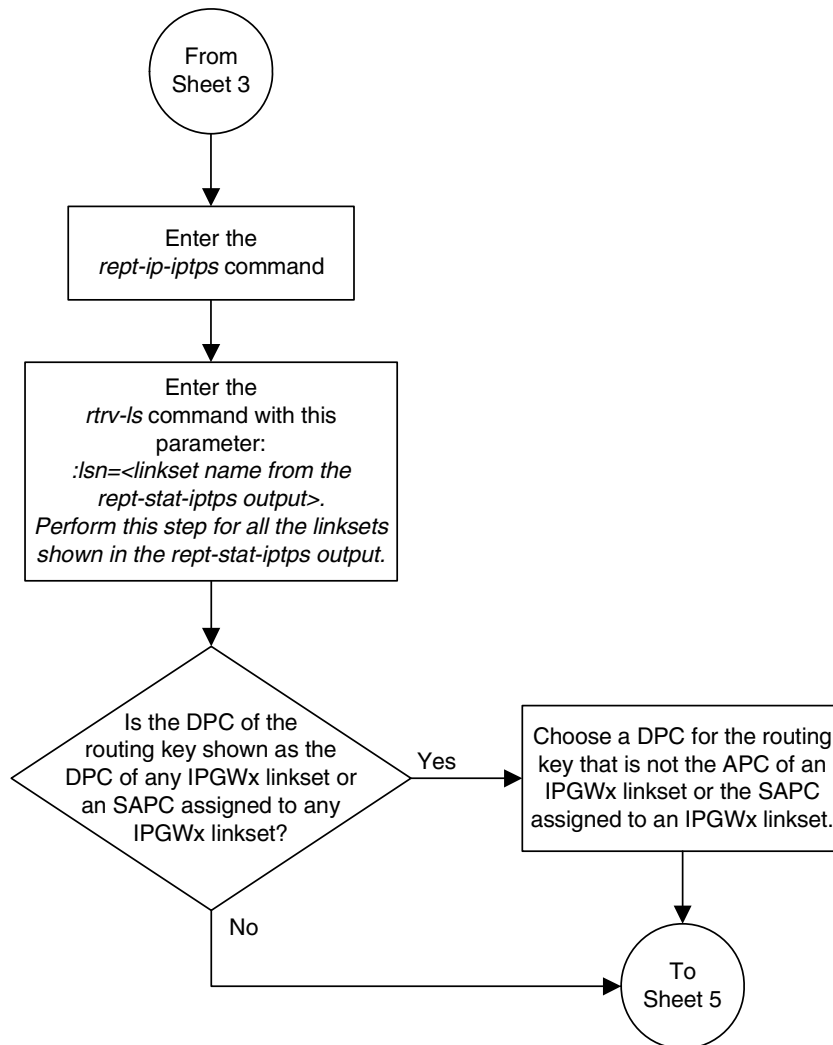

Flowchart 3-22. Adding a Routing Key Containing an Application Server
(Sheet 5 of 5)

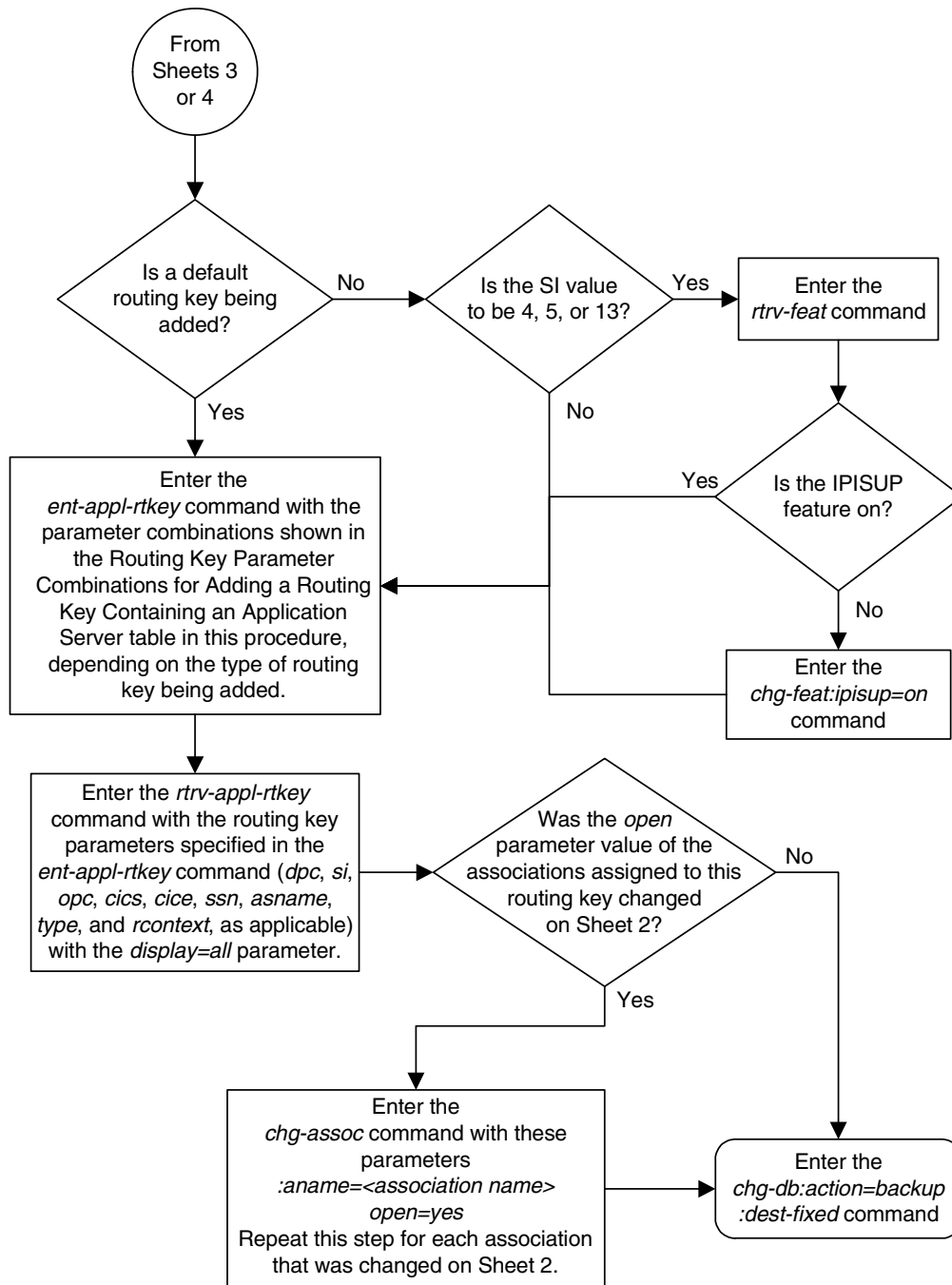

Removing a Routing Key

This procedure is used to remove a static or dynamic routing key from the database using the `dlt-appl-rtkey` command. For more information about static and dynamic routing keys, see "Understanding Routing for SS7IPGW and IPGWI Applications" on page 2-25.

The `dlt-appl-rtkey` command uses these parameters.

:dpc/dpca/dpci/dpcn/dpca24 – The destination point code value that is used to filter incoming MSUs.

:opc/opca/opci/opcn/opcn24 – The originating point code value that is used to filter incoming MSUs. This parameter must not specify a cluster route. This parameter is only valid when the **si** parameter value is set to 4, 5, or 13. This parameter is required if **si=4, 5, or 13** and **type=full**.

NOTE: See the "Point Code Formats" section in the *Database Administration Manual - SS7* for a definition of the point code types that are used on the EAGLE 5 ISS and for a definition of the different formats that can be used for ITU national point codes.

:si – The service indicator value that is used to filter incoming MSUs. The range of values for the service indicator parameter (**si**) can be a numerical value from 0 to 15, or for selected service indicator values, a text string can be used instead of numbers. Table 3-20 shows the text strings that can be used in place of numbers for the service indicator values.

Table 3-20. Service Indicator Text String Values

| Service Indicator Value | Text String | Service Indicator Value | Text String |
|-------------------------|-------------|-------------------------|-------------|
| 0 | snm | 4 | tup |
| 1 | regtest | 5 | isup |
| 2 | spltst | 13 | qbicc |
| 3 | sccp | | |

:ssn – The subsystem value that is used to filter incoming MSUs. The **ssn** parameter is only valid when the **si** parameter value is set to 3 or **sccp**.

:sname – The name of the socket that will receive the incoming MSU.

:cics – The starting circuit identification code that is used to filter incoming MSUs. Specify with **cice** to delete routing keys with the circuit identification code or range of circuit identification codes. The **cics** parameter is only valid when the **si** parameter value is set to 4, 5, or 13. The **cics** is required if **si=4, 5, or 13** and **type=full**.

:cice - The ending circuit identification code that is used to filter incoming MSUs. Specify with **cics** to delete routing keys with the circuit identification code or range of circuit identification codes. The **cice** parameter is only valid when the **si** parameter value is set to 4, 5, or 13. The **cics** is required if **si=4, 5, or 13** and **type=full**.

:loc - Card location that indicates from which **ss7ipgw** or **ipgwi** card to delete a dynamic routing key entry. If this parameter is not specified, a static entry is deleted.

:type - Identifies the type of routing key that is being deleted. One of three values, **type = full/partial/default**. If **type** is not explicitly specified, **type = full** is assumed.

:asname - Application server (AS) name.

:rcontext - The routing context parameter value assigned to the routing key.

The parameter combinations used by the **dlr-app1-rtkey** command are based on the type of routing key and the service indicator value in the routing key. The parameter combinations are shown in Table 3-21 on page 3-273.

Table 3-21. Routing Key Parameter Combinations for Removing Routing Keys

| SI=3 (SCCP) | | SI=4 (TUP), 5 (ISUP), 13 (QBICC) | | Other SI Values | | Default Routing Key ^{1, 5, 6} |
|-------------------------------------|--|-------------------------------------|--|--|---|--|
| Full Routing Key ^{1, 5, 6} | Partial Routing Key ^{1, 5, 6} | Full Routing Key ^{1, 5, 6} | Partial Routing Key ^{1, 5, 6} | Full Routing Key ^{1, 5, 6} | Partial Routing Key ^{1, 5, 6} | |
| dpc | sname | dpc | sname | dpc | sname | sname |
| si=3 ¹ | type=partial | si=4, 5, 13 ¹ | type=partial | si=value other than 3, 4, 5, 13 ¹ | type=partial | type=default |
| ssn | dpc ² | opc | dpc ² | sname | dpc ² | asname |
| type=full | si=3 ^{1, 2} | cics | si=4, 5, 13 ^{1, 2} | type=full | si=value other than 3, 4, 5, 13 ^{1, 2} | loc ³ |
| sname | asname | cice | opc ² | asname | asname | rcontext ^{4, 5, 6} |
| asname | loc ³ | type=full | asname | loc ³ | loc ³ | |
| loc ³ | rcontext ^{4, 5, 6} | sname | loc ³ | rcontext ^{4, 5, 6} | rcontext ^{4, 5, 6} | |
| rcontext ^{4, 5, 6} | | asname | rcontext ^{4, 5, 6} | | | |
| | | loc ³ | | | | |
| | | rcontext ^{4, 5, 6} | | | | |

Table 3-21. Routing Key Parameter Combinations for Removing Routing Keys (Continued)

| SI=3 (SCCP) | | SI=4 (TUP), 5 (ISUP), 13 (QBICC) | | Other SI Values | | Default Routing Key ^{1, 5, 6} |
|---|--|-------------------------------------|--|-------------------------------------|--|--|
| Full Routing Key ^{1, 5, 6} | Partial Routing Key ^{1, 5, 6} | Full Routing Key ^{1, 5, 6} | Partial Routing Key ^{1, 5, 6} | Full Routing Key ^{1, 5, 6} | Partial Routing Key ^{1, 5, 6} | |
| Notes: | | | | | | |
| <p>1. The values for these parameters must be entered exactly as shown in the <code>rtrv-appl-rtkey</code> command output for the routing key being removed. However, text strings can be used in place of some numerical service indicator values. See Table 3-20 on page 3-272 for a list of these text strings.</p> <p>2. These parameters are optional for partial routing keys, but at least one these parameters must be specified with the <code>dlt-appl-rtkey</code> command.</p> <p>3. If the <code>loc</code> parameter is not specified, a static entry that matches the other specified parameters is deleted. The <code>loc</code> parameter can be specified only for dynamic routing key entries, entries that have a card location in the <code>LOC</code> column in the <code>rtrv-appl-rtkey</code> output. If the value in the <code>LOC</code> column is <code>STATIC</code>, the <code>loc</code> parameter cannot be used.</p> <p>4. The <code>rcontext</code> parameter can be specified only for static routing key entries containing a numerical value in the <code>RCONTEXT</code> column in the <code>rtrv-appl-rtkey</code> output. A static routing key contains the entry <code>STATIC</code> in the <code>LOC</code> column of the <code>rtrv-appl-rtkey</code> output. If the value in the <code>RCONTEXT</code> column is dashes, the <code>rcontext</code> parameter cannot be used.</p> <p>5. If the routing key contains a numerical value in the <code>RCONTEXT</code> column in the <code>rtrv-appl-rtkey</code> output, the <code>dlt-appl-rtkey</code> command can be specified with only the <code>rcontext</code> parameter and value instead of the <code>dpc</code>, <code>si</code>, <code>ssn</code>, <code>opc</code>, <code>cics</code>, <code>cice</code>, or <code>type</code> parameters and values to remove the routing key.</p> <p>6. If the routing key contains dashes in the <code>RCONTEXT</code> column in the <code>rtrv-appl-rtkey</code> output, the <code>dpc</code>, <code>si</code>, <code>ssn</code>, <code>opc</code>, <code>cics</code>, <code>cice</code>, or <code>type</code> parameters and values must be used with the <code>dlt-appl-rtkey</code> command to remove the routing key.</p> | | | | | | |

Canceling the RTRV-APPL-RTKEY Command

Because the `rtrv-appl-rtkey` command used in this procedure can output information for a long period of time, the `rtrv-appl-rtkey` command can be canceled and the output to the terminal stopped. There are three ways that the `rtrv-appl-rtkey` command can be canceled.

- Press the **F9** function key on the keyboard at the terminal where the `rtrv-appl-rtkey` command was entered.
- Enter the `cancel-cmd` without the `trm` parameter at the terminal where the `rtrv-appl-rtkey` command was entered.
- Enter the `cancel-cmd:trm=<xx>`, where `<xx>` is the terminal where the `rtrv-appl-rtkey` commands were entered, from another terminal other than the terminal where the `rtrv-appl-rtkey` command was entered. To enter the `cancel-cmd:trm=<xx>` command, the terminal must allow Security Administration commands to be entered from it and the user must be allowed to enter Security Administration commands. The terminal's permissions can be verified with the `rtrv-secu-trm` command. The user's permissions can be verified with the `rtrv-user` or `rtrv-secu-user` commands.

For more information about the `cancel-cmd` command, go to the *Commands Manual*.

Procedure

1. Display the current routing key information in the database by entering the `rtrv-appl-rtkey` command. The following is an example of the possible output.

```
rlghncxa03w 06-10-28 21:15:37 GMT EAGLE5 36.0.0
```

```

RCONTEXT      DPC          SI  ADPTR  ASNAME          TYPE      LOC
-----
123-234-123   5  TALI  -----  FULL      STATIC
123-234-123   5  TALI  -----  FULL      STATIC
005-005-001   5  TALI  -----  FULL      1105
005-005-001   5  TALI  -----  FULL      1105
006-006-001   5  TALI  -----  FULL      1107
006-006-001   5  TALI  -----  FULL      1107

```

```

RCONTEXT      DPCI          SI  ADPTR  ASNAME          TYPE      LOC
-----
2-100-7       6  M3UA  as4        FULL      STATIC
100           3-137-6       6  SUA    as1        FULL      STATIC
225           4-035-7       5  M3UA  as7        FULL      STATIC
-----
6-006-6       5  M3UA  as2        FULL      STATIC
6-006-7       5  M3UA  as8        FULL      STATIC
6-006-6       5  M3UA  as2        FULL      STATIC
6-006-6       5  M3UA  as2        FULL      STATIC
6-006-8       3  M3UA  as3        FULL      STATIC
6-006-8       5  M3UA  as5        FULL      STATIC
6-024-7       5  M3UA  as4        FULL      STATIC
6-024-7       5  M3UA  as4        FULL      STATIC
300           7-008-7       6  SUA    as6        FULL      STATIC

```

```
RCONTEXT      DPCN          SI  ADPTR  ASNAME          TYPE      LOC
```

```
RCONTEXT      DPCN24        SI  ADPTR  ASNAME          TYPE      LOC
```

```

RCONTEXT      DPC          SI  ADPTR  ASNAME          TYPE      LOC
-----
*****      **  TALI  -----  DEFAULT  STATIC

```

```
STATIC Route Key table is (15 of 2000) 1% full
```

```
1105 Route Key table is (2 of 500) 1% full
```

```
1107 Route Key table is (2 of 500) 1% full
```

```
STATIC Route Key Socket Association table is (15 of 32000) 1% full
```

```
1105 Route Key Socket Association table is (2 of 8000) 1% full
```

```
1107 Route Key Socket Association table is (2 of 8000) 1% full
```

NOTE: If a routing context value is not assigned to the the routing key being removed in this procedure, skip step 2 and go to step 3.

2. Display the specific routing key information for the routing key being removed from the database by entering the `rtrv-appl-rtkey` command with the `display=all` parameter and the `RCONTEXT` values shown in the `rtrv-appl-rtkey` output in step 1 for the routing key being removed. For this example, enter this command.

```
rtrv-appl-rtkey:rcontext=225
```

This is an example of the possible output.

```
rlghncxa03w 06-10-28 21:16:37 GMT EAGLE5 36.0.0
```

```

RCONTEXT  DPCI          SI SSN OPC1          CICS      CICE      LOC
225       4-035-7       5 --- 2-007-3       2000     3000     STATIC

      ADPTR  TYPE      ASNAME
      M3UA  FULL      as7

      ANAMES
      assoc15
    
```

```

STATIC Route Key table is (15 of 2000) 1% full
1105  Route Key table is (2 of 500) 1% full
1107  Route Key table is (2 of 500) 1% full

STATIC Route Key Socket Association table is (15 of 32000) 1% full
1105  Route Key Socket Association table is (2 of 8000) 1% full
1107  Route Key Socket Association table is (2 of 8000) 1% full
    
```

After this step is performed, skip step 3 and go to step 4.

3. Display the specific routing key information for the routing key being removed from the database by entering the `rtrv-appl-rtkey` command with the `display=all` parameter and the `DPC`, `SI`, `TYPE`, and the `asname` (application server name, if an application server is assigned to the routing key) values shown in the `rtrv-appl-rtkey` output in step 1 for the routing key being removed. For this example, enter these commands.

```
rtrv-appl-rtkey:dPCA=006-006-001:si=5:display=all:type=full
```

This is an example of the possible output.

```

rlghncxa03w 06-10-28 21:16:37 GMT EAGLE5 36.0.0

RCONTEXT  DPC          SI SSN OPC          CICS      CICE      LOC
-----  006-006-001  5 --- 011-011-001  501       1000     1107

      ADPTR  TYPE      PSTNCAT  PSTNID  NORM  DUP
      TALI  FULL      0        0      N    N

      SNAMEs
      socket31

RCONTEXT  DPC          SI SSN OPC          CICS      CICE      LOC
-----  006-006-001  5 --- 012-012-012  1001     1500     1107

      ADPTR  TYPE      PSTNCAT  PSTNID  NORM  DUP
      TALI  FULL      0        0      N    N

      SNAMEs
      socket32

STATIC Route Key table is (15 of 2000) 1% full
1105  Route Key table is (2 of 500) 1% full
1107  Route Key table is (2 of 500) 1% full

STATIC Route Key Socket Association table is (15 of 32000) 1% full
1105  Route Key Socket Association table is (2 of 8000) 1% full
1107  Route Key Socket Association table is (2 of 8000) 1% full
    
```

```
rtrv-appl-rtkey:dpci=6-006-6:si=3:display=all:type=full
:asname=as2
```

This is an example of the possible output.

```
rlghncxa03w 06-10-28 09:12:36 GMT EAGLE5 36.0.0

RCONTEXT   DPCI           SI SSN OPCI           CICS          CICE          LOC
-----
          6-006-6           3 170 -----
          -----
          ADPTR   TYPE      ASNAME
          M3UA   FULL      as2

          ANAMES
          assoc1

STATIC Route Key table is (15 of 2000) 1% full
1105  Route Key table is (2 of 500) 1% full
1107  Route Key table is (2 of 500) 1% full

STATIC Route Key Socket Association table is (15 of 32000) 1% full
1105  Route Key Socket Association table is (2 of 8000) 1% full
1107  Route Key Socket Association table is (2 of 8000) 1% full
```

NOTE: If an socket is assigned to the routing key, skip steps 4 and 5, and go to step 6.

4. Display the associations assigned to the routing key by entering the **rtrv-assoc** parameter with the association name shown in either steps 2 or 3. For this example, enter these commands.

```
rtrv-assoc:aname=assoc1
```

This is an example of possible output.

```
rlghncxa03w 06-10-28 09:12:36 GMT EAGLE5 36.0.0
ANAME assoc1
  LOC      1203           IPLNK PORT  A           LINK  A
  ADAPTER  M3UA           VER        M3UA RFC
  LHOST    gw105.nc.tekelec.com
  ALHOST    ---
  RHOST    gw100.nc.tekelec.com
  LPORT    1030           RPORT      1030
  ISTRMS   2             OSTRMS     2           BUFSIZE  16
  RMODE    LIN           RMIN       120         RMAX     800
  RTIMES   10           CWMIN      3000        UAPS     10
  OPEN     YES           ALW        YES

  ANAMES
  as2

IP Appl Sock table is (8 of 4000) 1% full
Assoc Buffer Space Used (16 KB of 800 KB) on LOC = 1203
```

```
rtrv-assoc:aname=assoc15
```

This is an example of possible output.

```
rlghncxa03w 06-10-28 09:12:36 GMT EAGLE5 36.0.0
ANAME assoc15
  LOC      1205           IPLNK PORT  A           LINK  A
  ADAPTER  M3UA           VER        M3UA RFC
```

```
LHOST    gw115.nc.tekelec.com
ALHOST   ---
RHOST    gw100.nc.tekelec.com
LPORT    2000          RPORT      2000
ISTRMS   2           OSTRMS      2           BUFSIZE    16
RMODE    LIN         RMIN        120          RMAX        800
RTIMES   10          CWMIN       3000         UAPS        10
OPEN     YES         ALW         YES
```

ASNAMES
as7

```
IP Appl Sock table is (8 of 4000) 1% full
Assoc Buffer Space Used (16 KB of 800 KB) on LOC = 1203
```

Repeat this step for all the associations shown in steps 2 or 3.

NOTE: If the `open` parameter value of all the associations shown in step 4 is `no`, skip step 5 and go to step 6.

5. Change the `open` parameter value of the association to `no` by using the `chg-assoc` command. For example, enter these commands.

```
chg-assoc:aname=assoc1:open=no
chg-assoc:aname=assoc15:open=no
```

When this command has successfully completed, the following message should appear.

```
rlghncxa03w 06-10-28 21:18:37 GMT EAGLE5 36.0.0
CHG-ASSOC: MASP A - COMPLTD
```



CAUTION: The IP connections using the associations specified in this step will not be able to carry any traffic when the `open` parameter is changed to `no`.

Repeat this step for all the associations shown in step 4 that contain the `open=yes` parameter value.

-
6. Remove the routing key information from the database by entering the `dlt-appl-rtkey` command. The parameters required for the `dlt-appl-rtkey` command are determined by the type of routing key being added and the service indicator value in the routing key. See Table 3-21 on page 3-273 for the parameter combinations that can be used for the type of routing key being added to the database. For example, enter these commands.

```
dlt-appl-rtkey:dpca=006-006-001:loc=1107:si=5:cics=501
:cice=1000:sname=socket31
dlt-appl-rtkey:dpci=6-006-6:si=3:ssn=170:asname=as2
dlt-appl-rtkey:rcontext=225
```

When each of these commands have successfully completed, the following message should appear.

```
rlghncxa03w 06-10-28 21:16:37 GMT EAGLE5 36.0.0
DLT-APPL-RTKEY: MASP A - COMPLTD
```

7. Verify the changes by entering the `rtrv-appl-rtkey` command with the routing key parameters specified in step 6 (`dpc`, `si`, `opc`, `cics`, `cice`, `ssn`, `asname`, `sname`, `type`, and `loc`, as applicable). For this example, enter these commands.

```
rtrv-appl-rtkey:dPCA=006-006-001:loc=1107:si=5:cics=501  
:cice=1000
```

The following is an example of the possible output.

```
rlghncxa03w 06-10-28 21:15:37 GMT EAGLE5 36.0.0
```

```
STATIC Route Key table is (12 of 2000) 1% full  
1105 Route Key table is (2 of 500) 1% full  
1107 Route Key table is (1 of 500) 1% full
```

```
STATIC Route Key Socket Association table is (12 of 32000) 1% full  
1105 Route Key Socket Association table is (2 of 8000) 1% full  
1107 Route Key Socket Association table is (1 of 8000) 1% full
```

```
rtrv-appl-rtkey:dpci=6-006-6:si=3:ssn=170:asname=as2
```

The following is an example of the possible output.

```
rlghncxa03w 06-10-28 21:15:37 GMT EAGLE5 36.0.0
```

```
STATIC Route Key table is (12 of 2000) 1% full  
1105 Route Key table is (2 of 500) 1% full  
1107 Route Key table is (1 of 500) 1% full
```

```
STATIC Route Key Socket Association table is (6 of 32000) 1% full  
1105 Route Key Socket Association table is (2 of 8000) 1% full  
1107 Route Key Socket Association table is (1 of 8000) 1% full
```

```
rtrv-appl-rtkey:rcontext=225
```

The following is an example of the possible output.

```
STATIC Route Key table is (12 of 2000) 1% full  
1105 Route Key table is (2 of 500) 1% full  
1107 Route Key table is (1 of 500) 1% full
```

```
STATIC Route Key Socket Association table is (12 of 32000) 1% full  
1105 Route Key Socket Association table is (2 of 8000) 1% full  
1107 Route Key Socket Association table is (1 of 8000) 1% full
```

NOTE: If step 5 was not performed, skip step 7 and go to step 8.

7. Change the **open** parameter value of the associations that were changed in step 4 to **yes** by using the **chg-assoc** command. For example, enter these commands.

```
chg-assoc:aname=assoc1:open=yes
```

```
chg-assoc:aname=assoc15:open=yes
```

When this command has successfully completed, the following message should appear.

```
rlghncxa03w 06-10-28 21:18:37 GMT EAGLE5 36.0.0  
CHG-ASSOC: MASP A - COMPLTD
```

Repeat this step for all the associations that were changed in step 5.

-
8. Back up the new changes using the **chg-db:action=backup:dest=fixed** command. These messages should appear, the active Maintenance and Administration Subsystem Processor (MASP) appears first.

```
BACKUP (FIXED) : MASP A - Backup starts on active MASP.  
BACKUP (FIXED) : MASP A - Backup on active MASP to fixed disk complete.  
BACKUP (FIXED) : MASP A - Backup starts on standby MASP.  
BACKUP (FIXED) : MASP A - Backup on standby MASP to fixed disk complete.
```

Flowchart 3-23. Removing a Routing Key (Sheet 1 of 2)

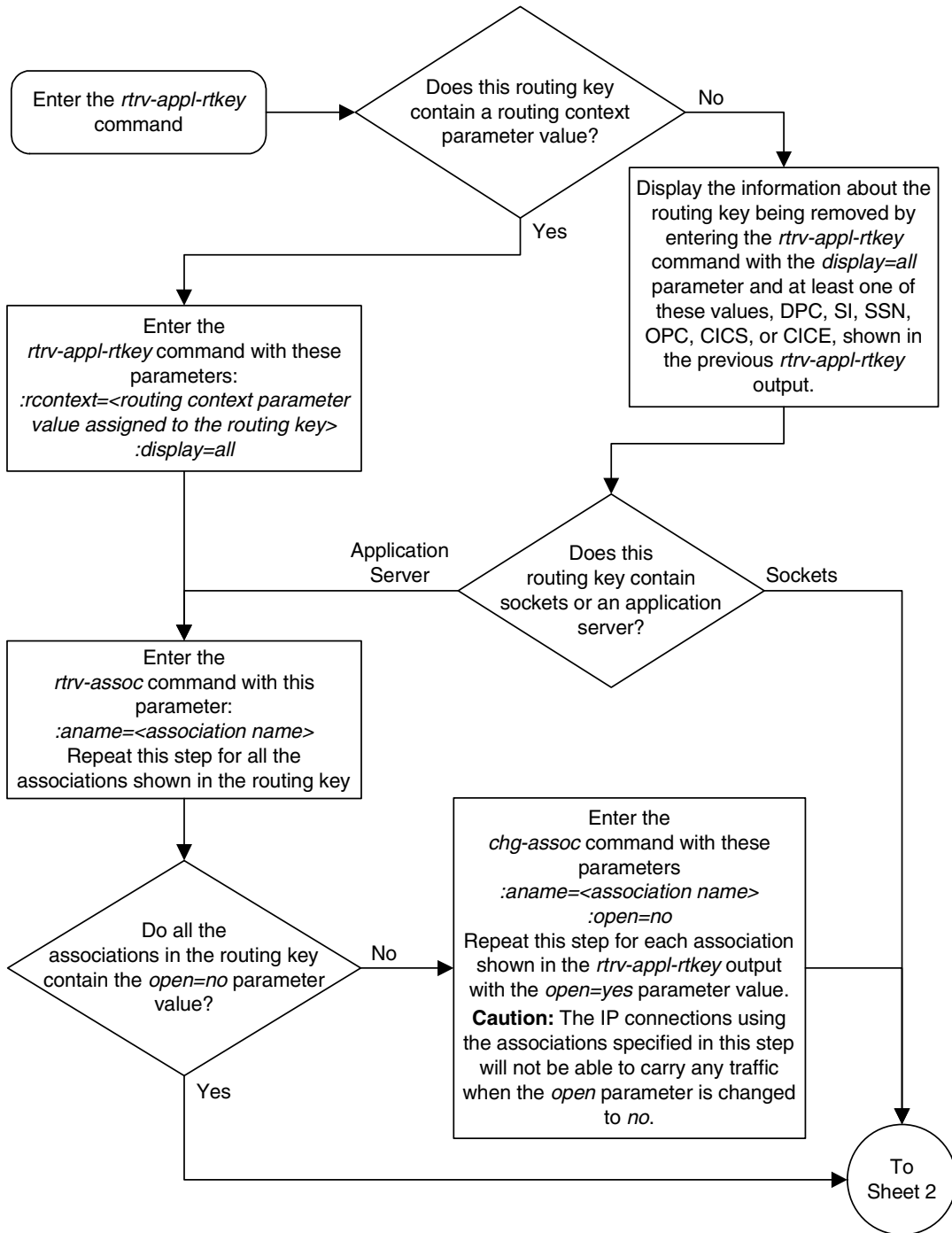

Flowchart 3-23. Removing a Routing Key (Sheet 2 of 2)

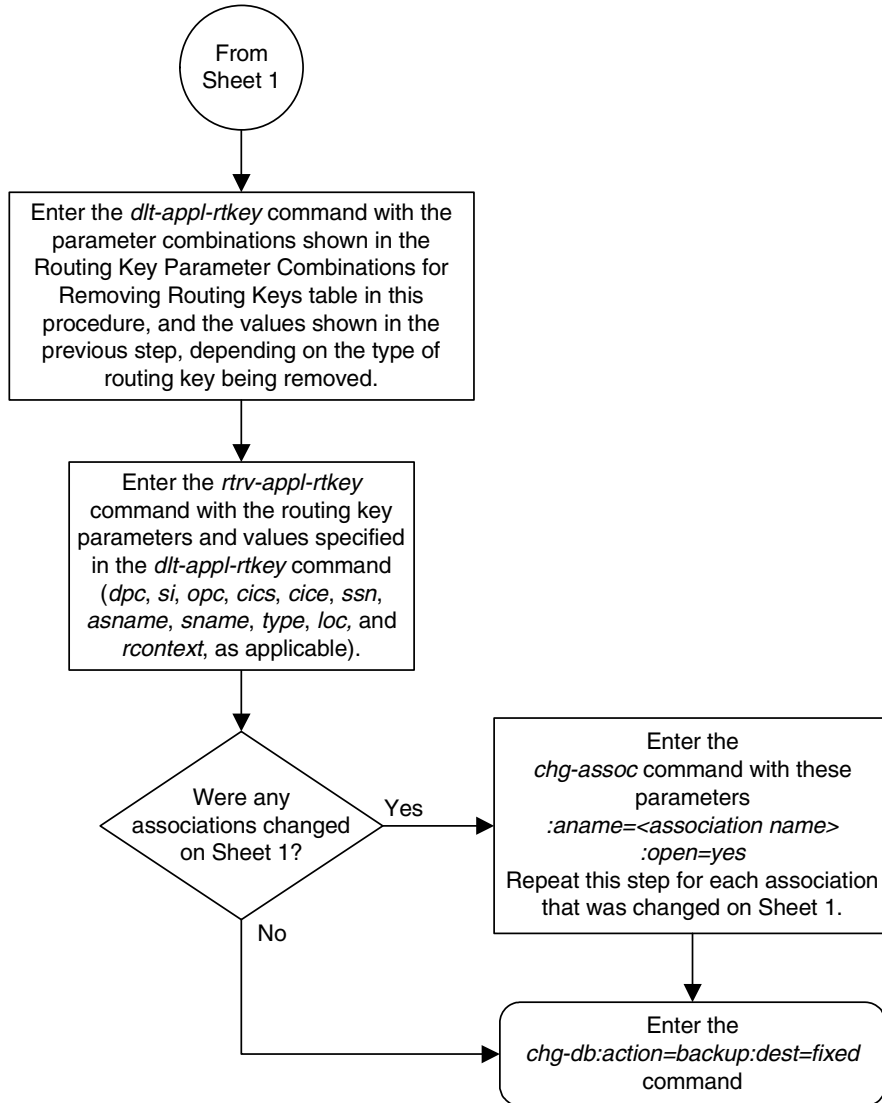

Changing the CIC Values in an Existing Routing Key

This procedure is used to change the CIC values in an existing routing key using the `chg-app1-rtkey` command. These parameters are used in this procedure.

`:dpc/dpca/dpci/dpcn/dpcn24` – Destination point code value that is used to filter incoming MSUs.

`:opc/opca/opci/opcn/opcn24` - The originating point code value that is used to filter incoming MSUs. This value must not specify a cluster route.

NOTE: See the “Point Code Formats” section in the *Database Administration Manual - SS7* for a definition of the point code types that are used on the EAGLE 5 ISS and for a definition of the different formats that can be used for ITU national point codes.

`:si` – The service indicator value that is used to filter incoming MSUs. The range of values for the service indicator parameter (`si`) can be a numerical value either 4, 5, or 13, or for selected service indicator values, a text string can be used instead of numbers. Table 3-22 shows the text strings that can be used in place of numbers for the service indicator values.

Table 3-22. Service Indicator Text String Values

| Service Indicator Value | Text String |
|-------------------------|-------------|
| 4 | tup |
| 5 | isup |
| 13 | qbicc |

`:cics` - Starting circuit identification code that is used to filter incoming MSUs. Specify with `cice` to identify the routing key to be changed.

`:cice` - Ending circuit identification code that is used to filter incoming MSUs. Specify with `cics` to identify the routing key to be changed.

`:ncics` - New starting circuit identification code that is used to filter incoming MSUs. Specify the `ncics` parameter and/or the `ncice` parameter to change the range of circuit identification codes assigned to the routing key.

`:ncice` - New ending circuit identification code that is used to filter incoming MSUs. Specify the `ncice` parameter and/or the `ncics` parameter to change the range of circuit identification codes assigned to the routing key.

`:split` - The circuit identification code value where the specified range of CIC values for the routing key specified by the `cics` and `cice` values is to be split into two routing keys. The CIC values in one routing key ranges from the `cics` value of the original routing key to a value equal to one less than the `split` value. The CIC values in the other routing key ranges from the `split` value to the `cice` value of the original routing key. All other parameters in both routing keys remain the same as in the original routing key. The range of

CIC values cannot be split if the routing key contains a routing context parameter value.

:type - Key type. Identifies the type of routing key that will be changed. One of three values, **type = full/partial/default**. If **type** is not explicitly specified, **type = full** is assumed. Only the **type=full** parameter can be used in this procedure.

:rcontext - The routing context parameter value assigned to the routing key.

The **chg-appl-rtkey** command contains other parameters that are not used in this procedure.

:ssn - The subsystem number value that is used to filter incoming MSUs. See the "Adding a Routing Key Containing a Socket" procedure on page 3-233 for more information on using the **ssn** parameter with a routing key.

:pstncat - The PSTN category assigned to the routing key.

:pstnid - The PSTN ID assigned to the routing key.

:norm - Specifies whether the ISUP Normalization process is enabled or disabled for MSUs using the routing key.

:nrcontext - The new routing context parameter value.

See the "Changing the Routing Context Value in an Existing Routing Key" procedure on page 3-295 for changing the routing context parameter value in an existing routing key.

See the "Changing the PSTN Presentation and Normalization Attributes in a Routing Key" procedure on page 3-303 for changing a routing key using the **pstncat**, **pstnid**, and **norm** parameters.

Rules for Changing the Range of CIC Values in an Existing Routing Key

The parameter combinations used by the `chg-app1-rtkey` command to change the range of CIC values in the routing key are shown in Table 3-23.

Table 3-23. Routing Key Parameter Combinations for Changing the Range of CIC Values in an Existing Routing Key

| SI=4 (TUP) | SI=5 (ISUP) | | SI=13 (QBICC) |
|---|---|---|---|
| dpci/dpcn/dpcn24=<the DPC assigned to the routing key> ¹ | dpc/dpca=<the DPC assigned to the routing key> ¹ | dpci/dpcn/dpcn24=<the DPC assigned to the routing key> ¹ | dpc/dpca/dpci/dpcn/dpcn24=<the DPC assigned to the routing key> ¹ |
| si=4 ¹ | si=5 ¹ | si=5 ¹ | si=13 ¹ |
| opci/opcn/opcn24=<the OPC assigned to the routing key> ¹ | opc/opca=<the OPC assigned to the routing key> ¹ | opci/opcn/opcn24=<the OPC assigned to the routing key> ¹ | opc/opca/opci/opcn/opcn24=<the OPC assigned to the routing key> ¹ |
| cics=<the CICS value assigned to the routing key> ^{1, 2} | cics=<the CICS value assigned to the routing key> ^{1, 2} | cics=<the CICS value assigned to the routing key> ^{1, 2} | cics=<the CICS value assigned to the routing key> ^{1, 2} |
| cice=<the CICE value assigned to the routing key> ^{1, 2} | cice=<the CICE value assigned to the routing key> ^{1, 2} | cice=<the CICE value assigned to the routing key> ^{1, 2} | cice=<the CICE value assigned to the routing key> ^{1, 2} |
| type=full | type=full | type=full | type=full |
| ncics=<0 to 4095> ^{2, 3} | ncics=<0 to 16383> ^{2, 3} | ncics=<0 to 4095> ^{2, 3} | ncics=<0 to 4294967295> ^{2, 3} |
| ncice=<0 to 4095> ^{2, 3} | ncice=<0 to 16383> ^{2, 3} | ncice=<0 to 4095> ^{2, 3} | ncice=<0 to 4294967295> ^{2, 3} |
| rcontext=<the current routing context value assigned to the routing key> ^{4, 5, 6} | rcontext=<the current routing context value assigned to the routing key> ^{4, 5, 6} | rcontext=<the current routing context value assigned to the routing key> ^{4, 5, 6} | rcontext=<the current routing context value assigned to the routing key> ^{4, 5, 6} |

Table 3-23. Routing Key Parameter Combinations for Changing the Range of CIC Values in an Existing Routing Key (Continued)

| SI=4 (TUP) | SI=5 (ISUP) | SI=13 (QBICC) |
|--|-------------|---------------|
| <p>1. The values for these parameters must be entered exactly as shown in the <code>rtrv-appl-rtkey</code> command output for the routing key being changed. However, text strings can be used in place of some numerical service indicator values. See Table 3-22 on page 3-283 for a list of these text strings. The text string must correspond to the numerical value shown in the routing key being changed.</p> <p>2. The <code>cics</code> and <code>cice</code> parameters must be specified and either the <code>ncics</code> or <code>ncice</code> parameters, or both, must be specified. If both the <code>ncics</code> and <code>ncice</code> parameters are specified, the value of the <code>ncics</code> parameter must be less than the value of the <code>ncice</code> parameter. If the <code>ncics</code> parameter is not specified, the value of the <code>ncice</code> parameter must be greater than or equal to the <code>cics</code> parameter value. If the <code>ncice</code> parameter is not specified, the value of the <code>ncics</code> parameter must be less than or equal to the <code>cice</code> parameter value.</p> <p>3. The new CIC range cannot overlap the CIC range in an existing routing key.</p> <p>4. The <code>rcontext</code> parameter can be specified only for static routing key entries containing a numerical value in the <code>RCONTEXT</code> column in the <code>rtrv-appl-rtkey</code> output. A static routing key contains the entry <code>STATIC</code> in the <code>LOC</code> column of the <code>rtrv-appl-rtkey</code> output. If the value in the <code>RCONTEXT</code> column is dashes, the <code>rcontext</code> parameter cannot be used.</p> <p>5. If the routing key contains a numerical value in the <code>RCONTEXT</code> column in the <code>rtrv-appl-rtkey</code> output, the <code>rcontext</code> parameter and value can be used in place of the <code>dpc</code>, <code>si</code>, <code>opc</code>, <code>cics</code>, <code>cice</code>, or <code>type=full</code> parameters and values to identify the routing that is being changed with the <code>chg-appl-rtkey</code> command. However, if only the <code>rcontext</code> parameter is used to identify the routing key being changed, only one of these parameters, <code>ncics</code> or <code>ncice</code> can be specified with the <code>chg-appl-rtkey</code> parameter. If you wish to specify the <code>ncics</code> and <code>ncice</code> parameters with the <code>chg-appl-rtkey</code> parameter, the <code>dpc</code>, <code>si</code>, <code>opc</code>, <code>cics</code>, <code>cice</code>, or <code>type=full</code> parameters and values must be specified with the <code>chg-appl-rtkey</code> command.</p> <p>6. If the routing key contains dashes in the <code>RCONTEXT</code> column in the <code>rtrv-appl-rtkey</code> output, the <code>dpc</code>, <code>si</code>, <code>opc</code>, <code>cics</code>, <code>cice</code>, or <code>type</code> parameters and values must be used with the <code>chg-appl-rtkey</code> command to identify the routing key being changed.</p> | | |

Rules for Splitting the Range of CIC Values in an Existing Routing Key

The parameter combinations used by the `chg-app1-rtkey` command to split the range of CIC values in the routing key are shown in Table 3-24.

Splitting the range of CIC values creates two routing keys. The CIC values in one routing key ranges from the `cics` value of the original routing key to a value equal to one less than the `split` value. The CIC values in the other routing key ranges from the `split` value to the `cice` value of the original routing key. All other parameters in both routing keys remain the same as in the original routing key. The range of CIC values cannot be split if the routing key contains a routing context parameter value.

Table 3-24. Routing Key Parameter Combinations for Splitting the Range of CIC Values in an Existing Routing Key

| SI=4 (TUP) | SI=5 (ISUP) | | SI=13 (QBICC) |
|--|--|---|--|
| dpci/dpcn/dpcn24=<the DPC assigned to the routing key> ¹ | dpc/dpca=<the DPC assigned to the routing key> ¹ | dpci/dpcn/dpcn24=<the DPC assigned to the routing key> ¹ | dpc/dpca/dpci/dpcn/dpcn24=<the DPC assigned to the routing key> ¹ |
| si=4 ¹ | si=5 ¹ | si=5 ¹ | si=13 ¹ |
| opci/opcn/opcn24=<the OPC assigned to the routing key> ¹ | opc/opca=<the OPC assigned to the routing key> ¹ | opci/opcn/opcn24=<the OPC assigned to the routing key> ¹ | opc/opca/opci/opcn/opcn24=<the OPC assigned to the routing key> ¹ |
| cics=<the CICS value assigned to the routing key> ¹ | cics=<the CICS value assigned to the routing key> ¹ | cics=<the CICS value assigned to the routing key> ¹ | cics=<the CICS value assigned to the routing key> ¹ |
| cice=<the CICE value assigned to the routing key> ¹ | cice=<the CICE value assigned to the routing key> ¹ | cice=<the CICE value assigned to the routing key> ¹ | cice=<the CICE value assigned to the routing key> ¹ |
| type=full | type=full | type=full | type=full |
| split=<0 to 4095> ² | split=<0 to 16383> ² | split=<0 to 4095> ² | split=<0 to 4294967295> ² |
| <p>1. The values for these parameters must be entered exactly as shown in the <code>rtrv-app1-rtkey</code> command output for the routing key being changed. However, text strings can be used in place of some numerical service indicator values. See Table 3-22 on page 3-283 for a list of these text strings. The text string must correspond to the numerical value shown in the routing key being changed.</p> <p>2. The <code>split</code> parameter value must be greater than the <code>cics</code> parameter value and less than the <code>cice</code> parameter value.</p> | | | |

Canceling the RTRV-APPL-RTKEY Command

Because the `rtrv-appl-rtkey` command used in this procedure can output information for a long period of time, the `rtrv-appl-rtkey` command can be canceled and the output to the terminal stopped. There are three ways that the `rtrv-appl-rtkey` command can be canceled.

- Press the **F9** function key on the keyboard at the terminal where the `rtrv-appl-rtkey` command was entered.
- Enter the `canc-cmd` without the `trm` parameter at the terminal where the `rtrv-appl-rtkey` command was entered.
- Enter the `canc-cmd:trm=<xx>`, where `<xx>` is the terminal where the `rtrv-appl-rtkey` command was entered, from another terminal other than the terminal where the `rtrv-appl-rtkey` command was entered. To enter the `canc-cmd:trm=<xx>` command, the terminal must allow Security Administration commands to be entered from it and the user must be allowed to enter Security Administration commands. The terminal's permissions can be verified with the `rtrv-secu-trm` command. The user's permissions can be verified with the `rtrv-user` or `rtrv-secu-user` commands.

For more information about the `canc-cmd` command, go to the *Commands Manual*.

Procedure

1. Display the current routing key information in the database by entering the `rtrv-appl-rtkey` command. The following is an example of the possible output.

```
rlghncxa03w 06-10-28 21:15:37 GMT EAGLE5 36.0.0

RCONTEXT      DPC      SI  ADPTR  ASNAME      TYPE      LOC
-----
----- 123-234-123  5  TALI  -----  FULL  STATIC
----- 123-234-123  5  TALI  -----  FULL  STATIC
----- 005-005-001  5  TALI  -----  FULL  1105
----- 005-005-001  5  TALI  -----  FULL  1105
----- 006-006-001  5  TALI  -----  FULL  1107
----- 006-006-001  5  TALI  -----  FULL  1107

RCONTEXT      DPCI      SI  ADPTR  ASNAME      TYPE      LOC
-----
----- 2-100-7      6  M3UA  as4      FULL  STATIC
100      3-137-6      6  SUA    as1      FULL  STATIC
225      4-035-7      5  M3UA  as7      FULL  STATIC
----- 6-006-6      5  M3UA  as2      FULL  STATIC
----- 6-006-7      5  M3UA  as8      FULL  STATIC
----- 6-006-6      5  M3UA  as2      FULL  STATIC
----- 6-006-6      5  M3UA  as2      FULL  STATIC
----- 6-006-8      3  M3UA  as3      FULL  STATIC
----- 6-006-8      5  M3UA  as5      FULL  STATIC
----- 6-024-7      5  M3UA  as4      FULL  STATIC
----- 6-024-7      5  M3UA  as4      FULL  STATIC
300      7-008-7      6  SUA    as6      FULL  STATIC

RCONTEXT      DPCN      SI  ADPTR  ASNAME      TYPE      LOC
-----
RCONTEXT      DPCN24    SI  ADPTR  ASNAME      TYPE      LOC
```

```

RCONTEXT      DPC          SI  ADPTR  ASNAME          TYPE      LOC
-----
*****      **  TALI  -----
                DEFAULT  STATIC

STATIC Route Key table is (2 of 2000) 1% full
1105  Route Key table is (2 of 500) 1% full
1107  Route Key table is (2 of 500) 1% full

STATIC Route Key Socket Association table is (2 of 32000) 1% full
1105  Route Key Socket Association table is (2 of 8000) 1% full
1107  Route Key Socket Association table is (2 of 8000) 1% full

```

2. Display the specific routing key information for the routing key being changed by entering the `rtrv-appl-rtkey` command with the `display=all` parameter.

If the routing key being changed contains a routing context value, specify the `rcontext` parameter and value shown in the `rtrv-appl-rtkey` output in step 1 for the routing key being changed.

If the routing key being changed does not contain a routing context value, specify the `DPC`, `SI`, and `TYPE` values shown in the `rtrv-appl-rtkey` output in step 1 for the routing key being changed. The service indicator value for the routing key to be used in this procedure is either 4, 5, or 13.

For this example, enter these commands.

```
rtrv-appl-rtkey:dpc=123-234-123:si=5:type=full:display=all
```

This is an example of the possible output.

```

rlghncxa03w 06-10-28 21:16:37 GMT EAGLE5 36.0.0

RCONTEXT      DPC          SI  SSN  OPC          CICS      CICE      LOC
-----
123-234-123    5  ---  122-124-125  1          1000      STATIC

      ADPTR  TYPE      PSTNCAT  PSTNID  NORM  DUP
      TALI   FULL          0        0    N    N

      SNAMEs
      kchlr11201

STATIC Route Key table is (15 of 2000) 1% full
1105  Route Key table is (2 of 500) 1% full
1107  Route Key table is (2 of 500) 1% full

STATIC Route Key Socket Association table is (15 of 32000) 1% full
1105  Route Key Socket Association table is (2 of 8000) 1% full
1107  Route Key Socket Association table is (2 of 8000) 1% full

```

```
rtrv-appl-rtkey:rcontext=225:display=all
```

This is an example of the possible output.

```

rlghncxa03w 06-10-28 21:16:37 GMT EAGLE5 36.0.0

RCONTEXT      DPCI          SI  SSN  OPC          CICS      CICE      LOC
-----
225            4-035-7        5  ---  2-007-3      2000      3000      STATIC

      ADPTR  TYPE      ASNAME
      M3UA   FULL      as7

```

```
ANAMES
assoc15
```

```
STATIC Route Key table is (15 of 2000) 1% full
1105 Route Key table is (2 of 500) 1% full
1107 Route Key table is (2 of 500) 1% full

STATIC Route Key Socket Association table is (15 of 32000) 1% full
1105 Route Key Socket Association table is (2 of 8000) 1% full
1107 Route Key Socket Association table is (2 of 8000) 1% full
```

3. Change the CIC values of the routing key by entering the **chg-appl-rtkey** command. The parameters required for the **chg-appl-rtkey** command are determined by the type of change being made to the routing key. Go to one of these sections to determine the required parameter combination.
 - “Rules for Changing the Range of CIC Values in an Existing Routing Key” on page 3-285
 - “Rules for Splitting the Range of CIC Values in an Existing Routing Key” on page 3-287

NOTE: If the routing key contains a routing context value, the range of CIC values cannot be split.

To change the range of CIC values for this example, enter these commands.

```
chg-appl-rtkey:dpc=123-234-123:si=5:opca=122-124-125:cics=1
:cice=1000:ncice=2000
chg-appl-rtkey:dpci=4-035-7:si=5:opci=2-007-3:cics=2000
:cice=3000:ncice=4000
```

If a routing context value is assigned to the routing key, the **rcontext** parameter and value assigned to the routing key can be used to identify the routing key being changed instead of the **dpc**, **si**, **opc**, **cics**, and **cice** parameters. If the **rcontext** parameter is specified only one of these parameters, **ncics** or **ncice**, can be specified with the **chg-appl-rtkey** parameter.

For this example, enter this command.

```
chg-appl-rtkey:rcontext=225:ncice=4000
```

To split the range of CIC values for this example, enter this command.

```
chg-appl-rtkey:dpc=123-234-123:si=5:opca=122-124-125:cics=1
:cice=1000:split=500
```

When this command has successfully completed, the following message should appear.

```
rlghncxa03w 06-10-28 21:16:37 GMT EAGLE5 36.0.0
CHG-APPL-RTKEY: MASP A - COMPLTD
```

4. Display the new routing key information in the database by entering the **rtrv-appl-rtkey** command with the **display=all** parameter.

If the routing key being changed contains a routing context value, specify the **rcontext** parameter and value specified in the **chg-appl-rtkey** command in step 3. The **DPC**, **SI**, **CICS**, and **CICE** parameters and values used in step 3 can be specified in the **rtrv-appl-rtkey** command for routing keys containing routing context values.

If the routing key being changed does not contain a routing context value, specify the **DPC**, **SI**, **CICS**, and **CICE** parameters and values specified in the **chg-appl-rtkey** command in step 3. If the **ncics** or **ncice** parameters were specified in step 3, the **NCICS** or **NCICE** values specified in step 3 must be specified for the **cics** or **cice** parameters in this step.

For this example, enter these commands.

```
rtrv-appl-rtkey:dpca=123-234-123:si=5:cics=1:cice=2000
:display=all
```

```
rlghncxa03w 06-10-28 21:16:37 GMT EAGLE5 36.0.0
RCONTEXT  DPC          SI SSN OPC          CICS      CICE      LOC
-----  123-234-123    5 --- 122-124-125    1         2000     STATIC

      ADPTR  TYPE      PSTNCAT  PSTNID  NORM  DUP
      TALI   FULL          0        0    N    N

      SNAMEs
      socket2
```

```
STATIC Route Key table is (15 of 2000) 1% full
1105  Route Key table is (2 of 500) 1% full
1107  Route Key table is (2 of 500) 1% full
```

```
STATIC Route Key Socket Association table is (15 of 32000) 1% full
1105  Route Key Socket Association table is (2 of 8000) 1% full
1107  Route Key Socket Association table is (2 of 8000) 1% full
```

```
rtrv-appl-rtkey:dpci=4-035-7:si=5:cics=2000:cice=4000
:display=all
```

OR

```
rtrv-appl-rtkey:rcontext=225:display=all
```

This is an example of the possible output.

```
rlghncxa03w 06-10-28 21:16:37 GMT EAGLE5 36.0.0
RCONTEXT  DPCI          SI SSN OPC          CICS      CICE      LOC
-----  4-035-7      5 --- 2-007-3    2000     4000     STATIC

      ADPTR  TYPE      ASNAME
      M3UA   FULL          as7

      ANAMES
      assoc15
```

```
STATIC Route Key table is (15 of 2000) 1% full
1105  Route Key table is (2 of 500) 1% full
```

```
1107 Route Key table is (2 of 500) 1% full

STATIC Route Key Socket Association table is (15 of 32000) 1% full
1105 Route Key Socket Association table is (2 of 8000) 1% full
1107 Route Key Socket Association table is (2 of 8000) 1% full
```

**rtrv-appl-rtkey:dPCA=123-234-123:si=5:cics=1:cice=1000
:display=all**

rlghncxa03w 06-10-28 21:16:37 GMT EAGLE5 36.0.0

| RCONTEXT | DPC | SI | SSN | OPC | CICS | CICE | LOC |
|----------|-------------|----|-----|-------------|------|------|--------|
| ----- | 123-234-123 | 5 | --- | 100-100-100 | 1 | 499 | STATIC |

| ADPTR | TYPE | PSTNCAT | PSTNID | NORM | DUP |
|-------|------|---------|--------|------|-----|
| TALI | FULL | 0 | 0 | N | N |

SNAMEs
socket2

| RCONTEXT | DPC | SI | SSN | OPC | CICS | CICE | LOC |
|----------|-------------|----|-----|-------------|------|------|--------|
| ----- | 123-234-123 | 5 | --- | 122-124-125 | 500 | 1000 | STATIC |

| ADPTR | TYPE | PSTNCAT | PSTNID | NORM | DUP |
|-------|------|---------|--------|------|-----|
| TALI | FULL | 0 | 0 | N | N |

SNAMEs
socket2

```
STATIC Route Key table is (16 of 2000) 1% full
1105 Route Key table is (2 of 500) 1% full
1107 Route Key table is (2 of 500) 1% full

STATIC Route Key Socket Association table is (16 of 32000) 1% full
1105 Route Key Socket Association table is (2 of 8000) 1% full
1107 Route Key Socket Association table is (2 of 8000) 1% full
```

5. Back up the new changes using the **chg-db:action=backup:dest=fixed** command. These messages should appear, the active Maintenance and Administration Subsystem Processor (MASP) appears first.

```
BACKUP (FIXED) : MASP A - Backup starts on active MASP.
BACKUP (FIXED) : MASP A - Backup on active MASP to fixed disk complete.
BACKUP (FIXED) : MASP A - Backup starts on standby MASP.
BACKUP (FIXED) : MASP A - Backup on standby MASP to fixed disk complete.
```

Flowchart 3-24. Changing the CIC values in an Existing Routing Key
(Sheet 1 of 2)

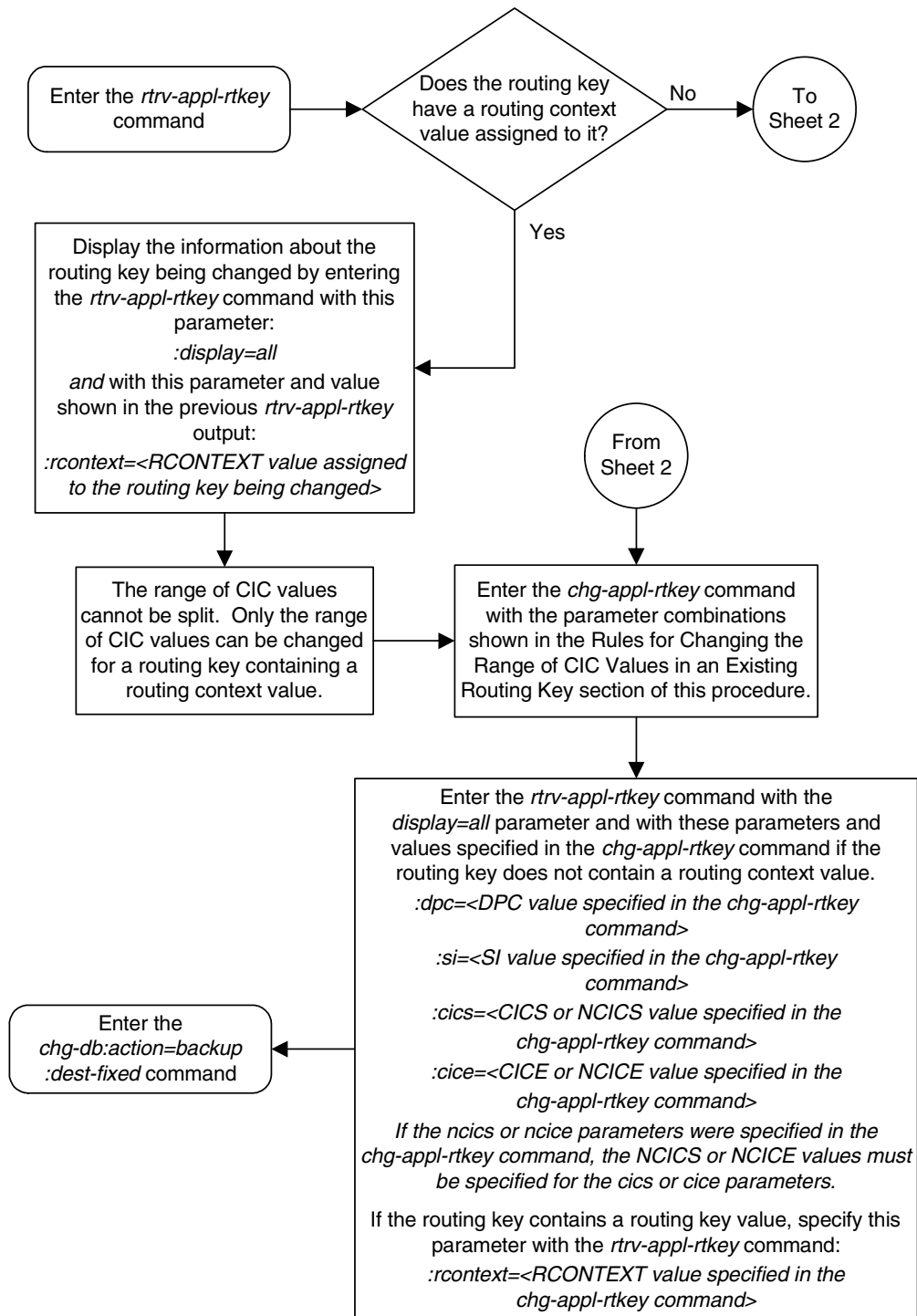

Flowchart 3-24. Changing the CIC values in an Existing Routing Key
(Sheet 2 of 2)

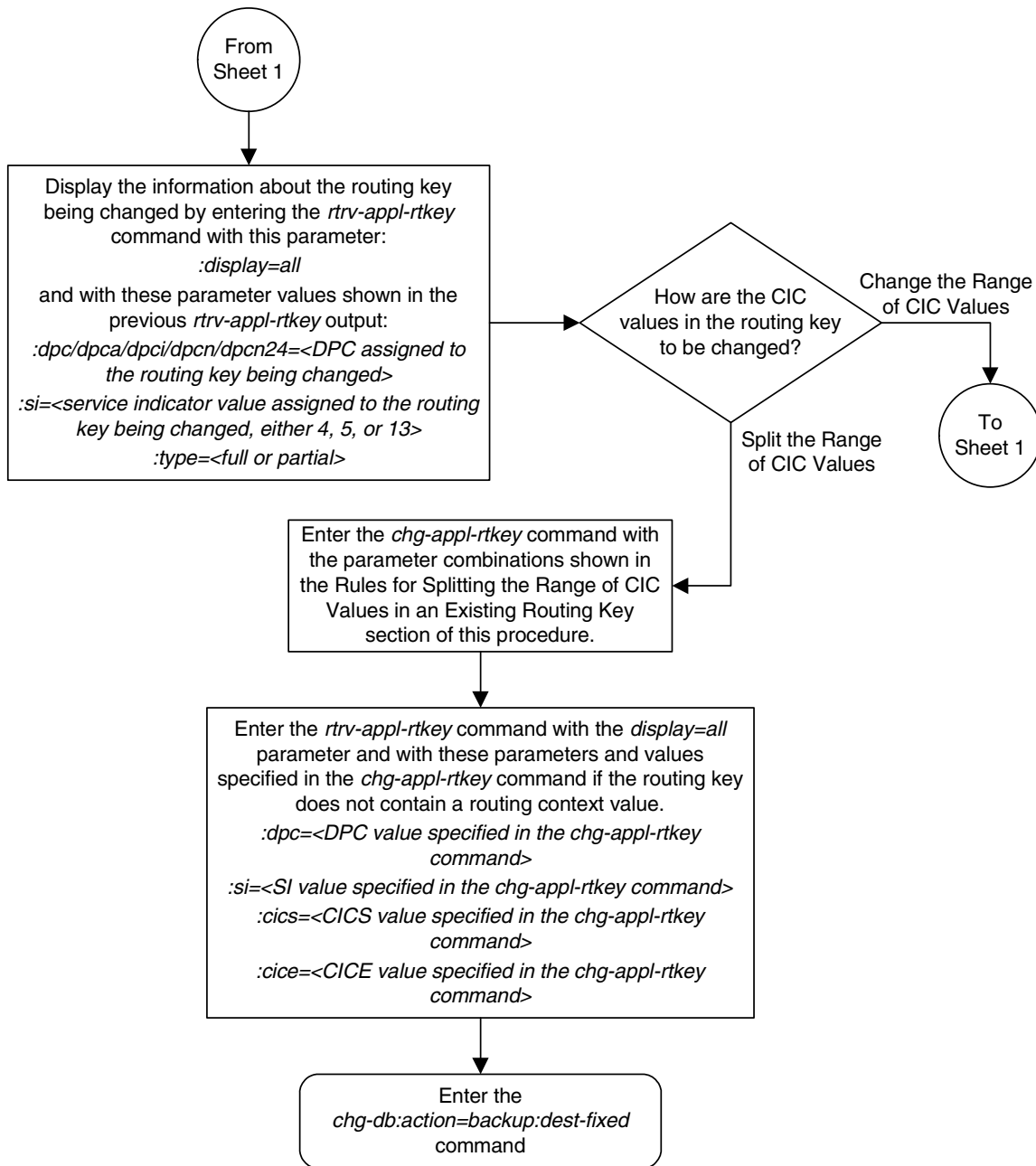

Changing the Routing Context Value in an Existing Routing Key

This procedure is used to change the routing context value in an existing routing key using the **chg-app1-rtkey** command.

The routing key being changed in this procedure must contain a number for the routing context value. If the routing context value shown for the routing key contains dashes (-), this routing key cannot be used in this procedure. The dashes shows that the routing key does not have a routing context assigned to it.

To assign a routing context value to an existing M3UA routing key, the routing key must be removed by performing the "Removing a Routing Key" procedure on page 3-272, then re-enter the routing key with the routing context value by performing the "Adding a Routing Key Containing an Application Server" procedure on page 3-250. A routing context value cannot be assigned to a TALI routing key. A routing context value must always be assigned to an SUA routing key.

These parameters are used in this procedure.

:rcontext – The current routing context parameter value, which has two functions:

- Provides an index of the application server traffic that the sending ASP is configured or registered to receive.
- Identifies the SS7 network context for the message. The routing context parameter implicitly defines the SS7 point code format used, the SS7 network indicator value, and the SCCP protocol type/variant/version used.

:nrcontext – The new routing context parameter value, from 0 to 4294967295. The new routing context value cannot be assigned to other routing keys.

The **chg-app1-rtkey** command contains other parameters that are not used in this procedure.

:dpc/dpca/dpci/dpcn/dpcn24 – Destination point code value that is used to filter incoming MSUs.

:opc/opca/opci/opcn/opcn24 - The originating point code value that is used to filter incoming MSUs. This value must not specify a cluster route.

:si – The service indicator value that is used to filter incoming MSUs. The range of values for the service indicator parameter (**si**) can be a numerical value from 0 to 15, or for selected service indicator values, a text string can be used instead of numbers. Table 3-25 shows the text strings that can be used in place of numbers for the service indicator values.

Table 3-25. Service Indicator Text String Values

| Service Indicator Value | Text String | Service Indicator Value | Text String |
|-------------------------|-------------|-------------------------|-------------|
| 0 | snm | 4 | tup |
| 1 | regtest | 5 | isup |
| 2 | spltst | 13 | qbicc |
| 3 | sccp | | |

:ssn – The subsystem number value that is used to filter incoming MSUs.

:cics - Starting circuit identification code that is used to filter incoming MSUs.

:cice - Ending circuit identification code that is used to filter incoming MSUs.

:type - Key type. Identifies the type of routing key that will be changed. One of three values, **type = full/partial/default**. If **type** is not explicitly specified, **type = full** is assumed.

:ncics - New starting circuit identification code that is used to filter incoming MSUs.

:ncice - New ending circuit identification code that is used to filter incoming MSUs.

:split - The circuit identification code value where the specified range of the routing key specified by the **cics** and **cice** values is to be split into two entries.

:pstncat – The PSTN category assigned to the routing key.

:pstnid – The PSTN ID assigned to the routing key.

:norm – Specifies whether the ISUP Normalization process is enabled or disabled for MSUs using the routing key.

See the “Changing the CIC Values in an Existing Routing Key” procedure on page 3-283 for changing a routing key using the **ncics**, **ncice**, and **split** parameters.

See the “Changing the PSTN Presentation and Normalization Attributes in a Routing Key” procedure on page 3-303 for changing a routing key using the **pstncat**, **pstnid**, and **norm** parameters.

Canceling the RTRV-APPL-RTKEY Command

Because the **rtrv-appl-rtkey** command used in this procedure can output information for a long period of time, the **rtrv-appl-rtkey** command can be

canceled and the output to the terminal stopped. There are three ways that the `rtrv-appl-rtkey` command can be canceled.

- Press the **F9** function key on the keyboard at the terminal where the `rtrv-appl-rtkey` command was entered.
- Enter the `canc-cmd` without the `trm` parameter at the terminal where the `rtrv-appl-rtkey` command was entered.
- Enter the `canc-cmd:trm=<xx>`, where `<xx>` is the terminal where the `rtrv-appl-rtkey` command was entered, from another terminal other than the terminal where the `rtrv-appl-rtkey` command was entered. To enter the `canc-cmd:trm=<xx>` command, the terminal must allow Security Administration commands to be entered from it and the user must be allowed to enter Security Administration commands. The terminal's permissions can be verified with the `rtrv-secu-trm` command. The user's permissions can be verified with the `rtrv-user` or `rtrv-secu-user` commands.

For more information about the `canc-cmd` command, go to the *Commands Manual*.

Procedure

1. Display the current routing key information in the database by entering the `rtrv-appl-rtkey` command. The following is an example of the possible output.

```
rlghncxa03w 06-10-28 21:15:37 GMT EAGLE5 36.0.0

RCONTEXT      DPC      SI  ADPTR  ASNAME      TYPE      LOC
-----
123-234-123    5  TALI  -----  FULL      STATIC
123-234-123    5  TALI  -----  FULL      STATIC
005-005-001    5  TALI  -----  FULL      1105
005-005-001    5  TALI  -----  FULL      1105
006-006-001    5  TALI  -----  FULL      1107
006-006-001    5  TALI  -----  FULL      1107

RCONTEXT      DPCI     SI  ADPTR  ASNAME      TYPE      LOC
-----
2-100-7        6  M3UA  as4        FULL      STATIC
100            3-137-6  6  SUA    as1        FULL      STATIC
225           4-035-7  5  M3UA  as7        FULL      STATIC
310           6-006-6  5  SUA    as2        FULL      STATIC
6-006-7       5  M3UA  as8        FULL      STATIC
1000          6-006-6  5  SUA    as2        FULL      STATIC
500           6-006-6  5  SUA    as2        FULL      STATIC
6-006-8       3  M3UA  as3        FULL      STATIC
6-006-8       5  M3UA  as5        FULL      STATIC
6-024-7       5  M3UA  as4        FULL      STATIC
6-024-7       5  M3UA  as4        FULL      STATIC
300           7-008-7  6  SUA    as6        FULL      STATIC

RCONTEXT      DPCN     SI  ADPTR  ASNAME      TYPE      LOC
-----

RCONTEXT      DPCN24   SI  ADPTR  ASNAME      TYPE      LOC
-----

RCONTEXT      DPC      SI  ADPTR  ASNAME      TYPE      LOC
-----
*****      **  TALI  -----  DEFAULT  STATIC
```

```

STATIC Route Key table is (15 of 2000) 1% full
1105 Route Key table is (2 of 500) 1% full
1107 Route Key table is (2 of 500) 1% full

```

```

STATIC Route Key Socket Association table is (15 of 32000) 1% full
1105 Route Key Socket Association table is (2 of 8000) 1% full
1107 Route Key Socket Association table is (2 of 8000) 1% full

```

2. Display the specific routing key information for the routing key being changed by entering the `rtrv-appl-rtkey` command with the `display=all` parameter and the `RCONTEXT` value shown in the `rtrv-appl-rtkey` output in step 1 for the routing key being changed. For this example, enter this command.

```
rtrv-appl-rtkey:rcontext=310:display=all
```

This is an example of the possible output.

```
rlghncxa03w 06-10-28 21:16:37 GMT EAGLE5 36.0.0
```

| RCONTEXT | DPCI | SI | SSN | OPCI | CICS | CICE | LOC |
|----------|---------|----|-----|---------|------|------|--------|
| 310 | 6-006-6 | 5 | --- | 1-002-3 | 75 | 100 | STATIC |

| ADPTR | TYPE | ASNAME |
|-------|------|--------|
| SUA | FULL | as2 |

```

ANAMES
assoc1

```

```

STATIC Route Key table is (15 of 2000) 1% full
1105 Route Key table is (2 of 500) 1% full
1107 Route Key table is (2 of 500) 1% full

```

```

STATIC Route Key Socket Association table is (15 of 32000) 1% full
1105 Route Key Socket Association table is (2 of 8000) 1% full
1107 Route Key Socket Association table is (2 of 8000) 1% full

```

If the routing context value shown for the routing key is dashes (-), this routing key cannot be used in this procedure. The dashes show that the routing key does not have a routing context assigned to it.

To assign a routing context value to a M3UA routing key that does not have a routing context value, the routing key must be removed by performing the “Removing a Routing Key” procedure on page 3-272. Re-enter the routing key with the routing context value by performing the “Adding a Routing Key Containing an Application Server” procedure on page 3-250. If you do not wish to assign a routing context value to this routing key, but you wish to change the routing context value in another routing key, repeat this step with another routing key shown in step 1. If you do not wish to assign a routing context value to this routing key, and do not wish to change the routing context value in another routing key, this procedure cannot be performed.

If the routing key contains a routing context value, go to step 3.

3. Display the association displayed in the `rtrv-appl-rtkey` output in step 2, using the `rtrv-assoc` command with the association name shown in step 2.

```
rtrv-assoc:aname=assoc1
```

This is an example of possible output.

```
rlghncxa03w 06-10-28 09:12:36 GMT EAGLE5 36.0.0
ANAME assoc1
      LOC      1203          IPLNK PORT  A          LINK  A
      ADAPTER  SUA          VER          SUA RFC
      LHOST    gw105.nc.tekelec.com
      ALHOST    ---
      RHOST    gw100.nc.tekelec.com
      LPORT    1030          RPORT      1030
      ISTRMS   2            OSTRMS     2            BUFSIZE  16
      RMODE    LIN          RMIN       120          RMAX     800
      RTIMES   10          CWMIN      3000
      OPEN     YES          ALW        YES

ASNAMES
as2
```

```
IP Appl Sock table is (4 of 4000) 1% full
Assoc Buffer Space Used (16 KB of 800 KB) on LOC = 1203
```

Repeat this step for each association name displayed in step 2.

NOTE: If the `open` parameter value for all the associations assigned to the application server is `no` (shown in step 3), skip step 4 and go to step 5.

4. Change the value of the `open` parameter to `no` by specifying the `chg-assoc` command with the `open=no` parameter. For this example, enter this command.

```
chg-assoc:aname=assoc1:open=no
```

When this command has successfully completed, this message should appear.

```
rlghncxa03w 06-10-28 09:12:36 GMT EAGLE5 36.0.0
CHG-ASSOC: MASP A - COMPLTD;
```



CAUTION: The IP connections using the associations specified in this step will not be able to carry any traffic when the `open` parameter is changed to `no`.

Repeat this step for all the associations assigned to the application server that have the `open=yes` parameter value.

5. Change the routing key information to the database by entering the `chg-appl-rtkey` command with the current and new routing context values.

.

For this example, enter this command.

```
chg-appl-rtkey:nrcontext=5280:rcontext=310
```

When this command has successfully completed, the following message should appear.

```
rlghncxa03w 06-10-28 21:16:37 GMT EAGLE5 36.0.0
CHG-APPL-RTKEY: MASP A - COMPLTD
```

6. Display the new routing key information in the database by entering the **rtvr-appl-rtkey** command with the new routing context value specified in step 5 and the **display=all** parameter. For this example, enter this command.

```
rtvr-appl-rtkey:rcontext=5280:display=all
```

This is an example of the possible output.

```
rlghncxa03w 06-10-28 21:15:37 GMT EAGLE5 36.0.0

RCONTEXT  DPCI          SI SSN OPCI          CICS      CICE      LOC
5280      6-006-6        5 --- 1-002-3        75        100      STATIC

      ADPTR  TYPE      ASNAME
      SUA   FULL      as2

      ANAMES
      assoc1

STATIC Route Key table is (7 of 2000) 1% full
1105  Route Key table is (2 of 500) 1% full
1107  Route Key table is (2 of 500) 1% full

STATIC Route Key Socket Association table is (7 of 32000) 1% full
1105  Route Key Socket Association table is (2 of 8000) 1% full
1107  Route Key Socket Association table is (2 of 8000) 1% full
```

NOTE: If step 4 was not performed in this procedure, skip this step and go to step 8.

7. Change the value of the **open** parameter of the associations that were changed in step 4 to **yes** by specifying the **chg-assoc** command with the **open=yes** parameter. For this example, enter this command.

```
chg-assoc:aname=assoc1:open=yes
```

When this command has successfully completed, this message should appear.

```
rlghncxa03w 06-10-28 09:12:36 GMT EAGLE5 36.0.0
CHG-ASSOC: MASP A - COMPLTD;
```

Repeat this step for all the associations that were changed in step 4.

-
8. Back up the new changes using the **chg-db:action=backup:dest=fixed** command. These messages should appear, the active Maintenance and Administration Subsystem Processor (MASP) appears first.

```
BACKUP (FIXED) : MASP A - Backup starts on active MASP.
BACKUP (FIXED) : MASP A - Backup on active MASP to fixed disk complete.
BACKUP (FIXED) : MASP A - Backup starts on standby MASP.
BACKUP (FIXED) : MASP A - Backup on standby MASP to fixed disk complete.
```

Flowchart 3-25. Changing the Routing Context Value in an Existing Routing Key
(Sheet 1 of 2)

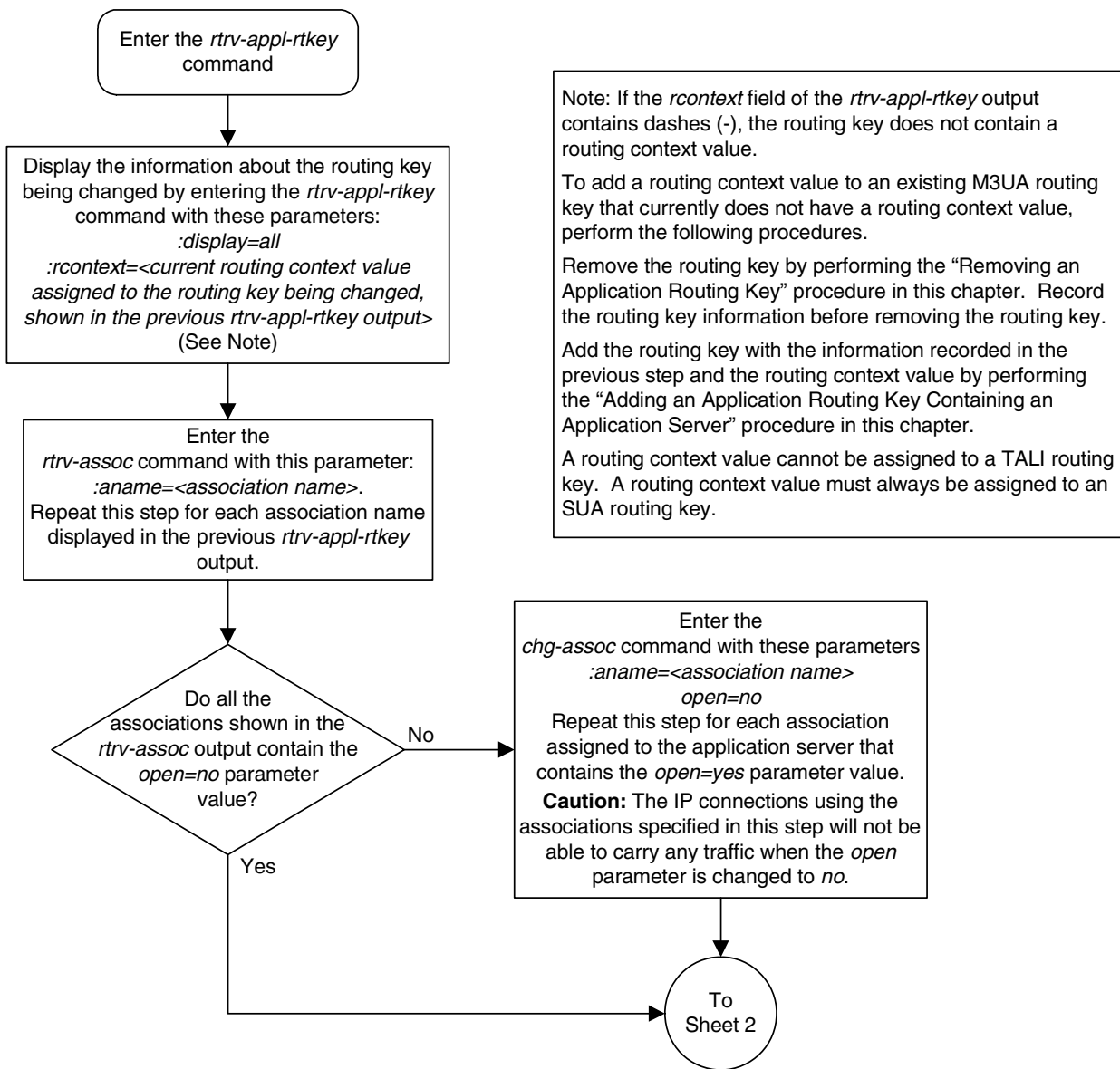

Flowchart 3-25. Changing the Routing Context Value in an Existing Routing Key (Sheet 2 of 2)

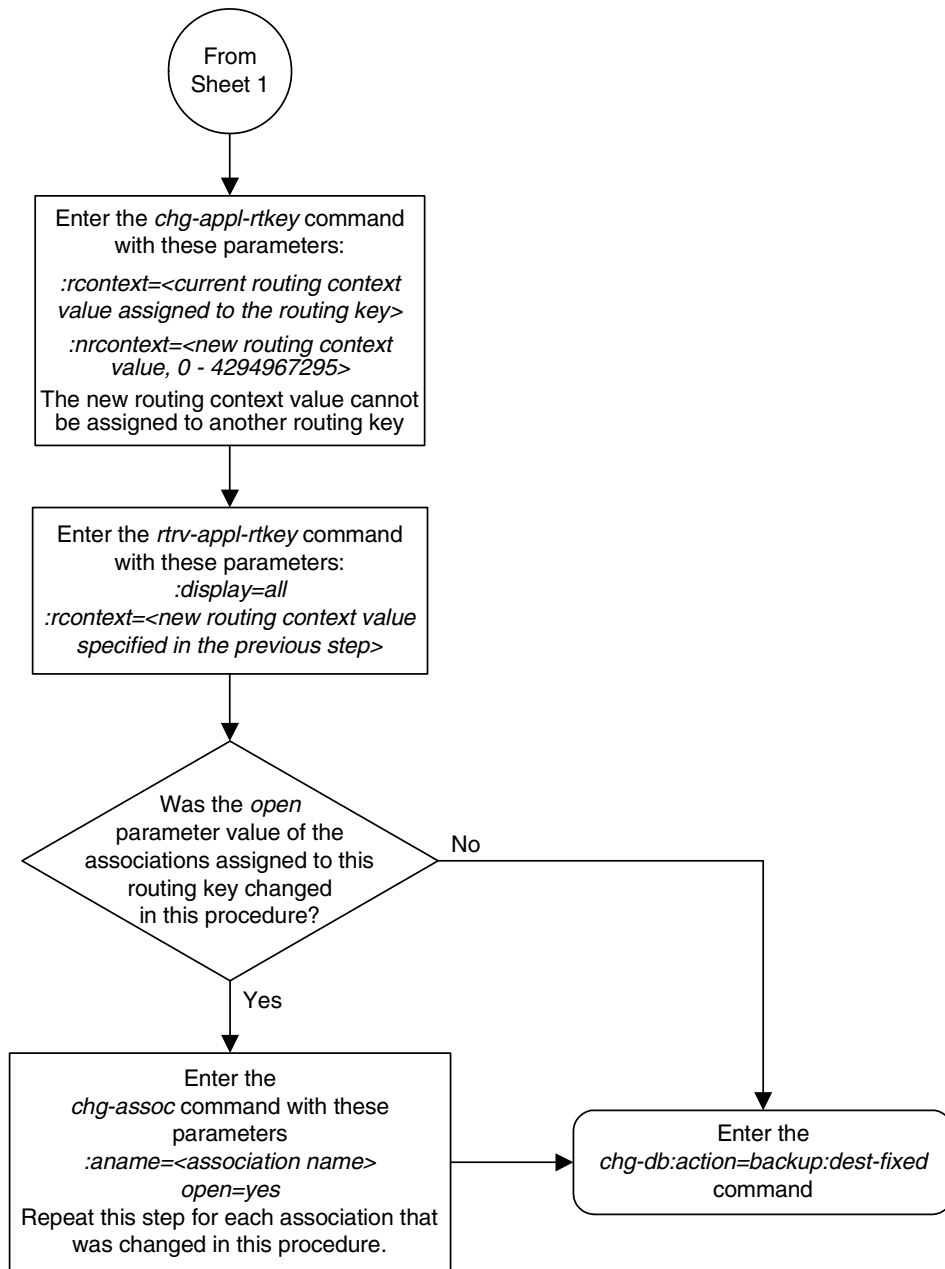

Changing the PSTN Presentation and Normalization Attributes in a Routing Key

This procedure is used for the `ss7ipgw` and `ipgwi` applications to change the PSTN (public switched telephone network) presentation and normalization settings in a routing key using the `chg-appl-rtkey` command with these parameters.

- `:pstncat` – The PSTN category assigned to the routing key.
- `:pstnid` – The PSTN ID assigned to the routing key.
- `:norm` – Specifies whether the ISUP Normalization process is enabled or disabled for MSUs using the routing key.

The PSTN presentation information is a 32-bit value indicating the format of the MTP-3 data portion of a MSU while it exists in a public switched telephone network. It consists of a PSTN category and PSTN ID value which identifies the protocol that is used to encode or decode the data in the MTP-3 portion of MSUs. The PSTN category is used to identify a logical partitioning of groups of PSTN IDs. The PSTN ID uniquely identifies a presentation within a given PSTN category.

The `pstncat`, `pstnid`, and `norm` values are used to identify the PSTN presentation and normalization attributes for the routing key. These values allow the EAGLE 5 ISS to convey the PSTN format information to IP devices and control the normalization process for MSUs using the routing key.

Table 4-1 on page 4-3 shows the PSTN presentation information used by these parameters and supported by the EAGLE 5 ISS. The values shown in the PSTN Category and PSTN ID columns in Table 4-1 are used as the values for the `pstncat` and `pstnid` parameters of the `chg-appl-rtkey` command.

The information in Table 4-1 is also shown in the output of the `rtrv-pstn-pres` command. The values in the `PSTNCAT Value(s)` and `Valid PSTNID Value(s) in PSTNCAT` columns in the following output example are the values that can be used by the `pstncat` and `pstnid` parameters of the `chg-appl-rtkey` command.

```
rlghncxa03w 06-10-28 21:17:37 GMT EAGLE5 36.0.0

PSTNCAT      PSTNID      PSTNDESC
00001        00001      ITU Q.767
00001        00002      ETSI V3
00001        00003      UK PNO-ISC7
00001        00004      GERMAN ISUP
00001        00020      MEXICO
04096        01000      User Defined 4096/1000
```

These parameters are also used by the `chg-appl-rtkey` command to change the PSTN presentation and normalization settings in the routing key.

:dpc/dpca/dpci/dpcn/dpcn24 – Destination point code value that is used to filter incoming MSUs.

NOTE: See the “Point Code Formats” section in the *Database Administration Manual - SS7* for a definition of the point code types that are used on the EAGLE 5 ISS and for a definition of the different formats that can be used for ITU national point codes.

:si – The service indicator value that is used to filter incoming MSUs. The range of values for the service indicator parameter (**si**) can be a numerical value from 0 to 15, or for selected service indicator values, a text string can be used instead of numbers. Table 3-26 shows the text strings that can be used in place of numbers for the service indicator values.

Table 3-26. Service Indicator Text String Values

| Service Indicator Value | Text String |
|-------------------------|-------------|
| 0 | snm |
| 1 | regtest |
| 2 | spltst |
| 3 | sccp |
| 4 | tup |
| 5 | isup |
| 13 | qbicc |

:opc/opca/opci/opcn/opcn24 - The originating point code value that is used to filter incoming MSUs. This value must not specify a cluster route.

NOTE: See the “Point Code Formats” section in the *Database Administration Manual - SS7* for a definition of the point code types that are used on the EAGLE 5 ISS and for a definition of the different formats that can be used for ITU national point codes.

:cics - Starting circuit identification code that is used to filter incoming MSUs. Specify with **cice** to identify the routing key to be changed.

:cice - Ending circuit identification code that is used to filter incoming MSUs. Specify with **cics** to identify the routing key to be changed.

:type - Key type. Identifies the type of routing key that will be changed. If the **type** parameter is not explicitly specified, **type = full** is assumed.

:ssn – The subsystem number value that is used to filter incoming MSUs.

The `chg-appl-rtkey` command also contains these parameters, but these parameters cannot be used when changing the PSTN presentation information in

the routing key. For more information on these parameters, see either the “Changing the CIC Values in an Existing Routing Key” procedure on page 3-283 or “Changing the Routing Context Value in an Existing Routing Key” procedure on page 3-295.

:nsname – The name of the new socket that will receive the incoming MSU.

:ncics – New starting circuit identification code that is used to filter incoming MSUs.

:ncice – New ending circuit identification code that is used to filter incoming MSUs.

:split – The circuit identification code value where the specified range of the routing key specified by the **cics** and **cice** values is to be split into two entries.

:nasname – The name of the new application server that will receive the incoming MSU.

:rcontext – The routing context value assigned to the routing key.

:nrcontext – The new routing context parameter value.

The **pstnid=0** parameter can be specified only with the **pstncat=0** parameter.

The values 2 through 4095 for the **pstncat** parameter are reserved and cannot be used.

If the value of the **pstncat** parameter is from 4096 to 65536, the value of the **pstnid** parameter can be from 0 to 65535.

The **norm=no** parameter can be specified for all values of the **pstncat** parameter. The **pstncat=1** and the **pstnid=<1,2,3, or 4>** parameters are specified with the **norm=no** parameter, ISUP normalization will not be performed on MSUs using the routing key.

The **pstncat=1** parameter may only be used with 14-bit ITU-N, 24-bit ITU-N, or ITU-I point codes and when the value of the service indicator parameter is 5. The value of the **pstnid** parameter specified with the **pstncat=1** parameter can range from 1 to 32.

The **norm=yes** parameter can be specified only under these conditions:

- The value of the **pstncat** parameter must be 1
- The value of the **pstnid** parameter values can range from 1 to 32.
- The ISUP Normalization controlled feature must be enabled and its status must be on.
- The value of the service indicator parameter in the routing key must be 5.
- The point code in the routing key must be either an ITU-I, 14-bit ITU-N, or 24-bit ITU-N point code.
- The controlled feature associated with the **pstnid** parameter values 1 to 32 must be enabled and its status must be on.

The **rtrv-ctrl-feat** command shows whether or not the controlled features are enabled. If any of the required controlled features are not enabled, enter the **enable-ctrl-feat** command with the feature part number and the feature access key for the required controlled feature. The status of these controlled features is set to **on** with the **chg-ctrl-feat** command.

NOTE: If you do not have the part number or the feature access key for the required controlled feature, contact your Tekelec sales representative or account representative.

Table 4-1 on page 4-3 also shows the part numbers of the controlled features used in this procedure. The Quantity Control feature allows a customer to provision a specified quantity of user-defined variants within the PSTN categories 4096 - 65535. Each Quantity Control Feature is associated with a specific quantity of variants. To provision user-defined variants, it is necessary to purchase the appropriate Feature Access Keys from Tekelec. Variants enabled using the Quantity Control feature do not have associated PSTN Presentation values.

The part number for user-defined variants is 893-0100-nn, where nn is a number ranging from 01 to 20. Use part number 893-0100-01 to order one new variant, 893-0100-05 to order five new variants, and so on.

The values of the **dpc**, **opc**, **si**, **cics**, and **cice** parameters specified in this procedure must match the values in the routing key that is being changed in this procedure.

If the ITU National Duplicate Point Code feature is on, the values for the **dpcn** and **opc** parameters must have group codes assigned to them. The field **ITUDUPPC** in the **rtrv-feat** command output shows whether or not the ITU National Duplicate Point Code feature is on. If group codes are specified for ITU-N DPC and OPC, the groups codes must be the same.

Canceling the **RTRV-APPL-RTKEY** Command

Because the **rtrv-appl-rtkey** command used in this procedure can output information for a long period of time, the **rtrv-appl-rtkey** command can be canceled and the output to the terminal stopped. There are three ways that the **rtrv-appl-rtkey** command can be canceled.

- Press the **F9** function key on the keyboard at the terminal where the **rtrv-appl-rtkey** command was entered.
- Enter the **canc-cmd** without the **trm** parameter at the terminal where the **rtrv-appl-rtkey** command was entered.
- Enter the **canc-cmd:trm=<xx>**, where **<xx>** is the terminal where the **rtrv-appl-rtkey** command was entered, from another terminal other than the terminal where the **rtrv-appl-rtkey** command was entered. To enter the **canc-cmd:trm=<xx>** command, the terminal must allow Security Administration commands to be entered from it and the user must be allowed to enter Security Administration commands. The terminal's permissions can be verified with the **rtrv-secu-trm** command. The user's permissions can be verified with the **rtrv-user** or **rtrv-secu-user** commands.

For more information about the **canc-cmd** command, go to the *Commands Manual*.

Procedure

1. Display the current routing key information in the database by entering the **rtrv-app1-rtkey** command. The following is an example of the possible output.

```
rlghncxa03w 06-10-28 21:15:37 GMT EAGLE5 36.0.0

RCONTEXT      DPC          SI  ADPTR  ASNAME          TYPE      LOC
-----
----- 123-234-123  5  TALI  -----  FULL    STATIC
----- 123-234-123  5  TALI  -----  FULL    STATIC
----- 005-005-001  5  TALI  -----  FULL    1105
----- 005-005-001  5  TALI  -----  FULL    1105
----- 006-006-001  5  TALI  -----  FULL    1107
----- 006-006-001  5  TALI  -----  FULL    1107

STATIC Route Key table is (2 of 2000) 1% full
1105  Route Key table is (2 of 500) 1% full
1107  Route Key table is (2 of 500) 1% full

STATIC Route Key Socket Association table is (2 of 32000) 1% full
1105  Route Key Socket Association table is (2 of 8000) 1% full
1107  Route Key Socket Association table is (2 of 8000) 1% full
```

2. Display the current values of the **pstncat**, **pstnid**, and **norm** parameters of the routing key by entering the **rtrv-app1-rtkey** command with the DPC of the routing key shown in step 1 and the **display=all** parameter. For this example, enter this command.

```
rtrv-app1-rtkey:dpcn=12323-de:display=all
```

This is an example of the possible output.

```
rlghncxa03w 06-10-28 21:16:37 GMT EAGLE5 36.0.0

RCONTEXT      DPCN          SI  SSN  OPCN          CICS      CICE      LOC
-----
----- 12323-DE    5  --- 12212-DE      1         1000     STATIC

      ADPTR  TYPE      PSTNCAT  PSTNID  NORM  DUP
      TALI   FULL          0        0  N    N

      SNAMEs
      socket6

STATIC Route Key table is (2 of 2000) 1% full
1105  Route Key table is (2 of 500) 1% full
1107  Route Key table is (2 of 500) 1% full

STATIC Route Key Socket Association table is (2 of 32000) 1% full
1105  Route Key Socket Association table is (2 of 8000) 1% full
1107  Route Key Socket Association table is (2 of 8000) 1% full
```

NOTE: If the value of the `norm` parameter is being set to `no`, skip steps 3 and 4, and go to step 5.

- Verify that the ISUP Normalization controlled feature is enabled and activated by entering the `rtrv-ctrl-feat` command. If the ISUP Normalization controlled feature is enabled, the ISUP Normalization controlled feature name should be shown in the **Feature Name** field of the output, and the status of the ISUP Normalization controlled feature, in the **status** field, should be set to `on`. The following is an example of the possible output

```
rlghncxa03w 06-10-28 21:15:37 GMT EAGLE5 36.0.0
The following features have been permanently enabled:
```

| Feature Name | Partnum | Status | Quantity |
|-----------------------|-----------|--------|----------|
| IPGWx Signaling TPS | 893012814 | on | 20000 |
| ISUP Normalization | 893000201 | on | ---- |
| ETSI v3 Normalization | 893000601 | on | ---- |

The following features have been temporarily enabled:

| Feature Name | Partnum | Status | Quantity | Trial Period Left |
|---------------------|---------|--------|----------|-------------------|
| Zero entries found. | | | | |

The following features have expired temporary keys:

| Feature Name | Partnum |
|---------------------|---------|
| Zero entries found. | |

If the ISUP Normalization controlled feature is not enabled and turned on, go to the “Enabling Controlled Features” procedure on page 6-2 and to “Turning On and Off Controlled Features” procedure on page 6-10 to enable and turn on the ISUP Normalization controlled feature.

- Display the PSTN presentation information supported by the EAGLE 5 ISS by entering the `rtrv-pstn-pres` command. The following is an example of the possible output.

```
rlghncxa03w 06-10-28 21:17:37 GMT EAGLE5 36.0.0
PSTNCAT PSTNID PSTNDESC
00001 00001 ITU Q.767
00001 00002 ETSI V3
00001 00003 UK PNO-ISC7
00001 00004 GERMAN ISUP
04096 01000 User Defined 4096/1000
```

ISUP Variant table is (6 of 21) 29% full

NOTE: An `*` will be displayed next to the PSTN Category for entries that are no longer usable. These are entries that are disabled because their temporary feature key expired.

The output of the `rtrv-pstn-pres` command shows the values in the **PSTNCAT Value(s)** and **Valid PSTNID Value(s)** in **PSTNCAT** columns that can be used by the `pstncat` and `pstnid` parameters of the `chg-appl-rtkey` command

If the value of the `norm` parameter is being set to `yes`, and the `rtrv-ctrl-feat` output in step 3 shows that the controlled feature that corresponds to the PSTNID parameter value being specified in this procedure

is not enabled and turned on, go to the “Enabling Controlled Features” procedure on page 6-2 and to “Turning On and Off Controlled Features” procedure on page 6-10 to enable and turn on the required controlled feature.

Table 4-1 on page 4-3 shows the part numbers of the controlled features and the `ptsnid` parameter values that can be used in this procedure.

NOTE: If 14-bit ITU-N point codes (`dpcn`, `opc`) are not being specified for the routing key, skip step 5 and go to step 6.

5. Verify whether or not the ITU National Duplicate Point Code feature is on, by entering the `rtrv-feat` command. If the ITU National Duplicate Point Code feature is on, the `ITUDUPPC` field will be set to `on`.

NOTE: The `rtrv-feat` command output contains other fields that are not used by this procedure. If you wish to see all the fields displayed by the `rtrv-feat` command, see the `rtrv-feat` command description in the *Commands Manual*.

6. Change PSTN presentation information in the routing key by entering the `chg-appl-rtkey` command with the `pstncat`, `ptsnid`, and `norm` parameters.

```
chg-appl-rtkey:dpcn=12323-de:si=5:opc=12212-de:cics=1
:cice=1000:pstncat=1:ptsnid=2:norm=yes
```

NOTE: If the DPC and OPC values are ITU-N point codes, these point codes must have group codes assigned to them if the ITU National Duplicate Point Code feature is on. The `ITUDUPPC` field in the `rtrv-feat` command executed in step 5 shows whether or not the ITU National Duplicate Point Code feature is on.

When this command has successfully completed, the following message should appear.

```
rlghncxa03w 06-10-28 21:16:37 GMT EAGLE5 36.0.0
CHG-APPL-RTKEY: MASP A - COMPLTD
```

7. Verify the new values of the `pstncat`, `ptsnid`, and `norm` parameters that were changed in step 6 by entering the `rtrv-appl-rtkey` command with the DPC of the routing key specified in step 6 and the `display=all` parameter. For this example, enter this command.

```
rtrv-appl-rtkey:dpcn=12323-de:display=all
```

This is an example of the possible output.

```
rlghncxa03w 06-10-28 21:16:37 GMT EAGLE5 36.0.0
```

| RCONTEXT | DPCN | SI | SSN | OPCN | CICS | CICE | LOC |
|----------|----------|---------|--------|----------|------|------|--------|
| ----- | 12323-DE | 5 | --- | 12212-DE | 1 | 1000 | STATIC |
| ADPTR | TYPE | PSTNCAT | PSTNID | NORM | DUP | | |
| TALI | FULL | 1 | 2 | Y | N | | |
| SNAMEs | | | | | | | |
| socket6 | | | | | | | |

```
STATIC Route Key table is (2 of 2000) 1% full
1105 Route Key table is (2 of 500) 1% full
1107 Route Key table is (2 of 500) 1% full
```

```
STATIC Route Key Socket Association table is (2 of 32000) 1% full
1105 Route Key Socket Association table is (2 of 8000) 1% full
1107 Route Key Socket Association table is (2 of 8000) 1% full
```

8. Back up the new changes using the **chg-db:action=backup:dest=fixed** command. These messages should appear, the active Maintenance and Administration Subsystem Processor (MASP) appears first.

```
BACKUP (FIXED) : MASP A - Backup starts on active MASP.
BACKUP (FIXED) : MASP A - Backup on active MASP to fixed disk complete.
BACKUP (FIXED) : MASP A - Backup starts on standby MASP.
BACKUP (FIXED) : MASP A - Backup on standby MASP to fixed disk complete.
```

Flowchart 3-26. Changing the PSTN Presentation and Normalization Attributes in a Routing Key (Sheet 1 of 6)

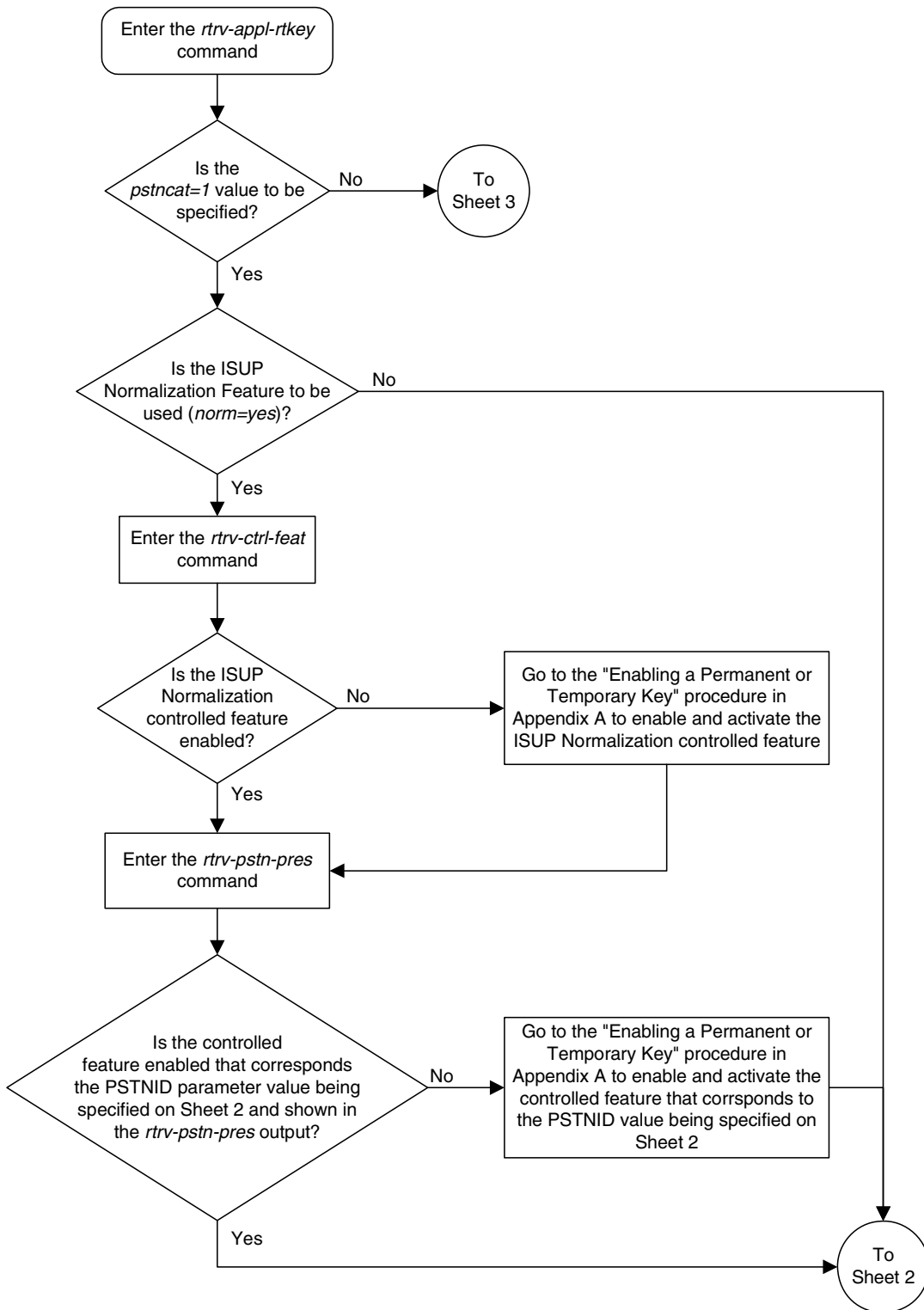

Flowchart 3-26. Changing the PSTN Presentation and Normalization Attributes in an Routing Key (Sheet 2 of 6)

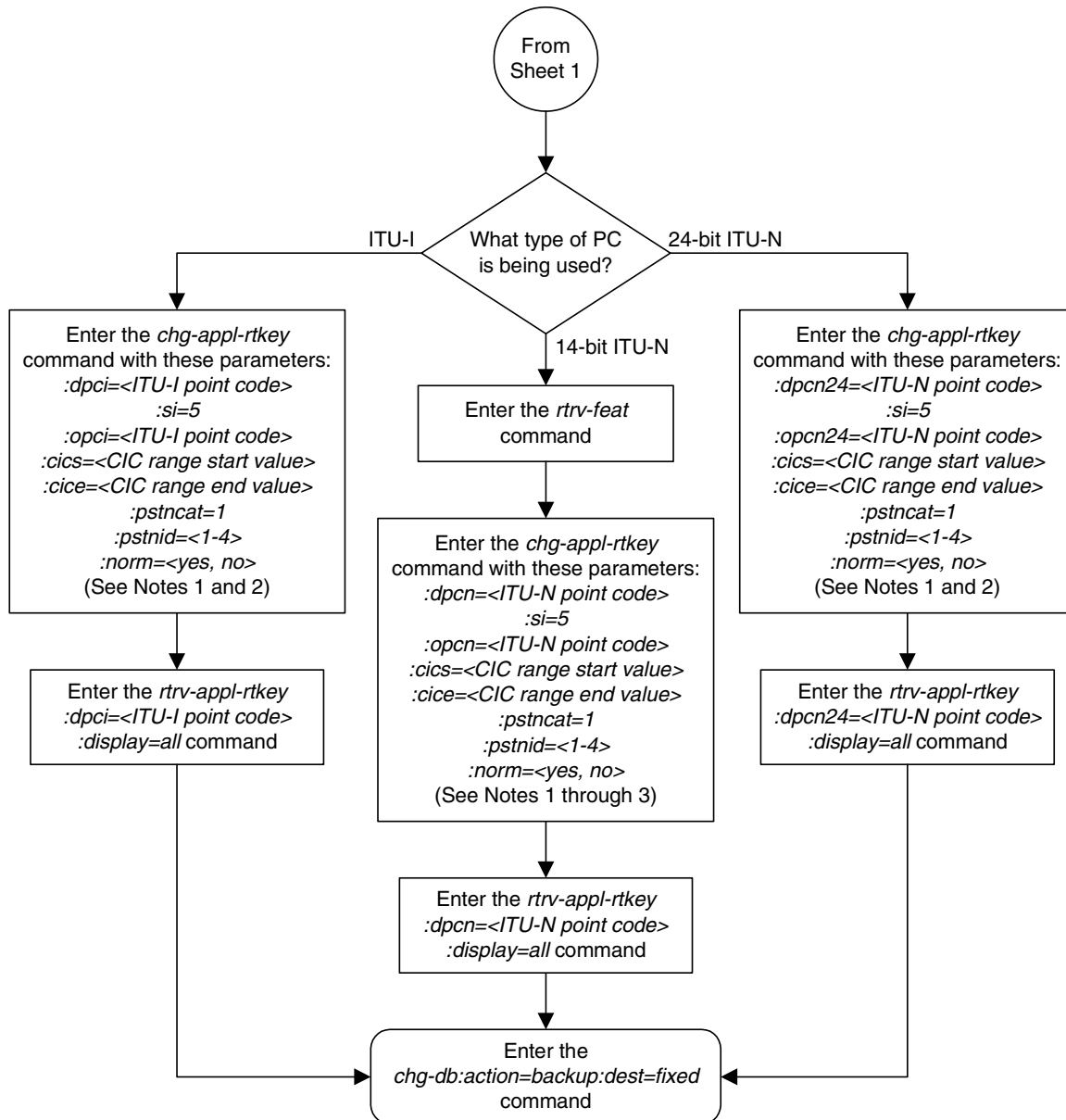

Notes:

1. The *norm=yes* parameter is only required if the ISUP Normalization feature is to be used for the MSUs using the routing key.
2. The values for the DPC, OPC, SI, CICS, and CICE parameters must match the values shown in the routing key being changed.
3. If the Duplicate Point Code feature is on, the DPCN and OPCN values must have a group code assigned to the point code. If both the DPCN and OPCN parameters are specified, the group codes must be the same. The ITUDUPPC field in the *rtrv-feat* command shows whether or not this feature is on.

Flowchart 3-26. Changing the PSTN Presentation and Normalization Attributes in an Routing Key (Sheet 3 of 6)

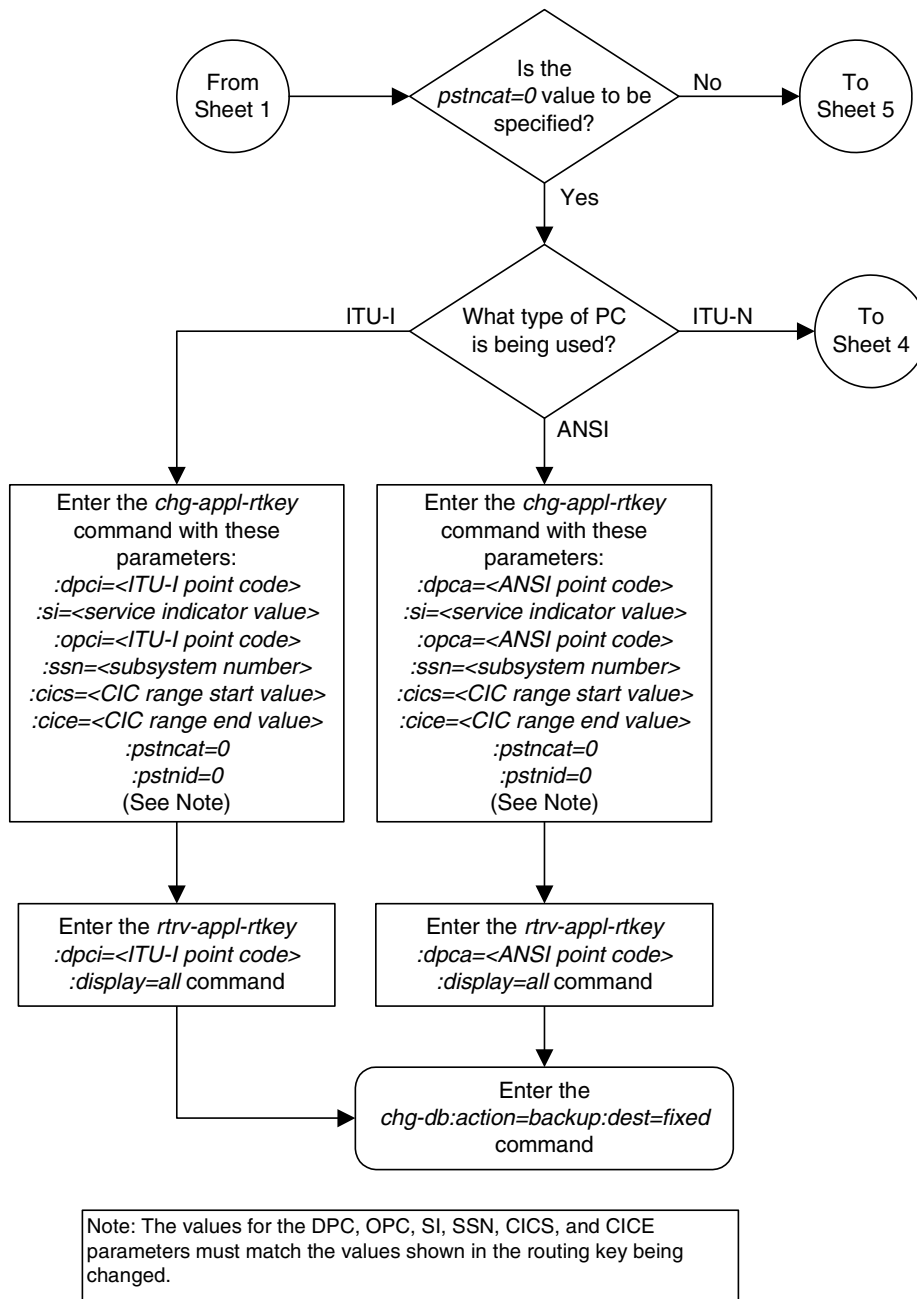

Flowchart 3-26. Changing the PSTN Presentation and Normalization Attributes in an Routing Key (Sheet 4 of 6)

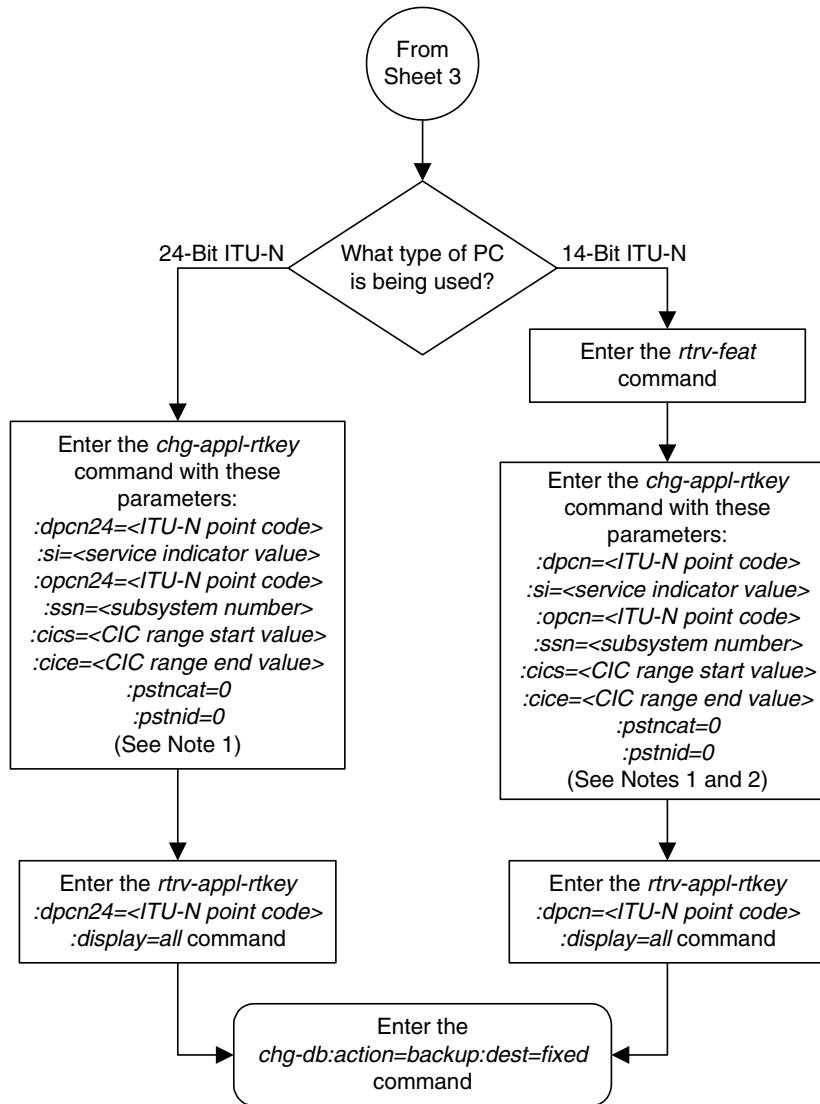

Notes:
 1. The values for the DPC, OPC, SI, SSN, CICS, and CICE parameters must match the values shown in the routing key being changed.
 2. If the Duplicate Point Code feature is on, the DPCN and OPCN values must have a group code assigned to the point code. If both the DPCN and OPCN parameters are specified, the group codes must be the same. The ITUDUPPC field in the *rtrv-feat* command shows whether or not this feature is on.

Flowchart 3-26. Changing the PSTN Presentation and Normalization Attributes in a Routing Key (Sheet 5 of 6)

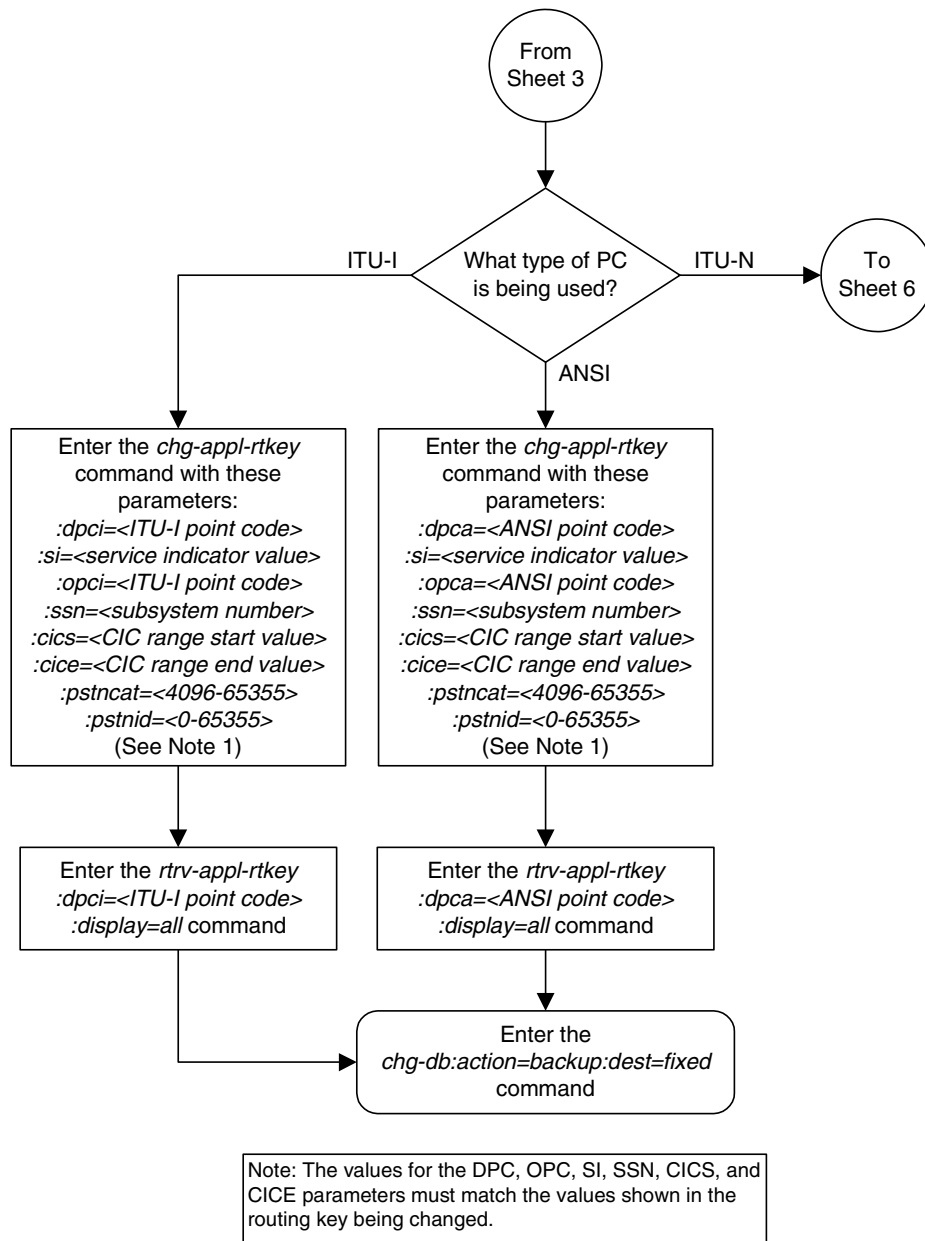

Flowchart 3-26. Changing the PSTN Presentation and Normalization Attributes in an Routing Key (Sheet 6 of 6)

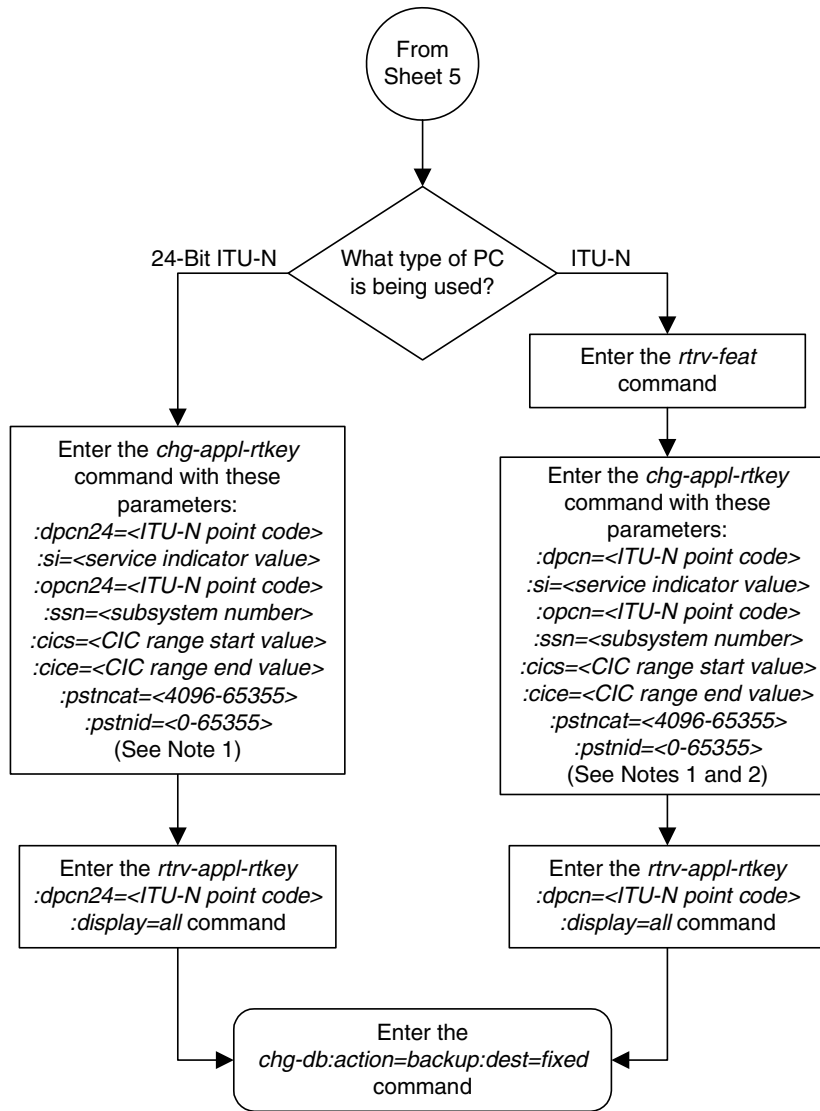

Notes:
 1. The values for the DPC, OPC, SI, SSN, CICS, and CICE parameters must match the values shown in the routing key being changed.
 2. If the Duplicate Point Code feature is on, the DPCN and OPCN values must have a group code assigned to the point code. If both the DPCN and OPCN parameters are specified, the group codes must be the same. The ITUDUPPC field in the *rtrv-feat* command shows whether or not this feature is on.

Increasing the System-Wide IPGWx Signaling TPS

This procedure is used with **IPGWx** applications (IP cards running either the **ss7ipgw** or **ipgwi** applications) and increases the system-wide IP transactions per second (TPS), using the **enable-ctrl-feat** command.

The EAGLE 5 ISS is shipped with a default TPS rate of 200 transactions per second.

The **enable-ctrl-feat** command uses these parameters.

:partnum – The Tekelec-issued part number associated with the controlled feature. The part number is a 9-digit number, not including dashes; the first three digits must be 893 (that is, 893xxxxxx, where x is a numeric value). Table 3-27 on page 3-318 shows the part numbers that can be used with this procedure.

:fak – The feature access key obtained from the Tekelec Customer Service department. The feature access key contains 13 alphanumeric characters and is not case sensitive.

NOTE: The number of system-wide IP transactions per second cannot be enabled with a temporary feature access key.

NOTE: If you do not have the feature access key, you can obtain it from your Tekelec Sales Representative or Account Representative.

The **enable-ctrl-feat** command requires that the database contain a valid serial number for the EAGLE 5 ISS, and that this serial number is locked. This can be verified with the **rtrv-serial-num** command. The EAGLE 5 ISS is shipped with a serial number in the database, but the serial number is not locked. The serial number can be changed, if necessary, and locked once the EAGLE 5 ISS is on-site, by using the **ent-serial-num** command. The **ent-serial-num** command uses these parameters.

:serial – The serial number assigned to the EAGLE 5 ISS. The serial number is not case sensitive.

:lock – Specifies whether or not the serial number is locked. This parameter has only one value, **yes**, which locks the serial number. Once the serial number is locked, it cannot be changed.

NOTE: To enter and lock the EAGLE 5 ISS's serial number, the **ent-serial-num** command must be entered twice, once to add the correct serial number to the database with the **serial** parameter, then again with the **serial** and the **lock=yes** parameters to lock the serial number. You should verify that the serial number in the database is correct before locking the serial number. The serial number can be found on a label affixed to the control shelf (shelf 1100).

The TPS rate specified in this procedure must be greater than the current TPS rate.

Table 3-27. System-Wide IPGWx Signaling TPS Part Numbers

| Part Number | IPGWx System IP TPS | Part Number | IPGWx System IP TPS | Part Number | IPGWx System IP TPS |
|-------------|---------------------|-------------|---------------------|-------------|---------------------|
| 893-0128-01 | 200 | 893-0128-21 | 34,000 | 893-0128-41 | 74,000 |
| 893-0128-02 | 400 | 893-0128-22 | 36,000 | 893-0128-42 | 76,000 |
| 893-0128-03 | 600 | 893-0128-23 | 38,000 | 893-0128-43 | 78,000 |
| 893-0128-04 | 1,000 | 893-0128-24 | 40,000 | 893-0128-44 | 80,000 |
| 893-0128-05 | 2,000 | 893-0128-25 | 42,000 | 893-0128-45 | 82,000 |
| 893-0128-06 | 4,000 | 893-0128-26 | 44,000 | 893-0128-46 | 84,000 |
| 893-0128-07 | 6,000 | 893-0128-27 | 46,000 | 893-0128-47 | 86,000 |
| 893-0128-08 | 8,000 | 893-0128-28 | 48,000 | 893-0128-48 | 88,000 |
| 893-0128-09 | 10,000 | 893-0128-29 | 50,000 | 893-0128-49 | 90,000 |
| 893-0128-10 | 12,000 | 893-0128-30 | 52,000 | 893-0128-50 | 92,000 |
| 893-0128-11 | 14,000 | 893-0128-31 | 54,000 | 893-0128-51 | 94,000 |
| 893-0128-12 | 16,000 | 893-0128-32 | 56,000 | 893-0128-52 | 96,000 |
| 893-0128-13 | 18,000 | 893-0128-33 | 58,000 | 893-0128-53 | 98,000 |
| 893-0128-14 | 20,000 | 893-0128-34 | 60,000 | 893-0128-54 | 100,000 |
| 893-0128-15 | 22,000 | 893-0128-35 | 62,000 | 893-0128-55 | 102,000 |
| 893-0128-16 | 24,000 | 893-0128-36 | 64,000 | 893-0128-56 | 104,000 |
| 893-0128-17 | 26,000 | 893-0128-37 | 66,000 | 893-0128-57 | 106,000 |
| 893-0128-18 | 28,000 | 893-0128-38 | 68,000 | 893-0128-58 | 108,000 |
| 893-0128-19 | 30,000 | 893-0128-39 | 70,000 | 893-0128-59 | 110,000 |
| 893-0128-20 | 32,000 | 893-0128-40 | 72,000 | 893-0128-60 | 112,000 |

Procedure

1. Display enabled controlled feature information in the database by entering the `rtrv-ctrl-feat` command. The following is an example of the possible output.

IP7 Secure Gateway Configuration Procedures

```
rlghncxa03w 06-10-28 21:15:37 GMT EAGLE5 36.0.0
The following features have been permanently enabled:
```

| Feature Name | Partnum | Status | Quantity |
|-----------------------|-----------|--------|----------|
| IPGWx Signaling TPS | 893012801 | on | 200 |
| ISUP Normalization | 893000201 | on | ---- |
| ETSI v3 Normalization | 893000601 | on | ---- |
| HC-MIM SLK Capacity | 893012707 | on | 64 |

```
The following features have been temporarily enabled:
```

| Feature Name | Partnum | Status | Quantity | Trial Period Left |
|---------------------|---------|--------|----------|-------------------|
| Zero entries found. | | | | |

```
The following features have expired temporary keys:
```

| Feature Name | Partnum |
|---------------------|---------|
| Zero entries found. | |

NOTE: If the `rtrv-ctrl-feat` output in step 1 shows any controlled features are enabled, or if the IPGWx Signaling TPS quantity is greater than 200, skip steps 2 through 5, and go to step 6.

2. Display the serial number in the database with the `rtrv-serial-num` command. This is an example of the possible output.

```
rlghncxa03w 06-10-28 21:15:37 GMT EAGLE5 36.0.0
System serial number = nt00001231
```

```
System serial number is not locked.
```

```
rlghncxa03w 06-10-28 21:15:37 GMT EAGLE5 36.0.0
Command Completed
```

NOTE: If the serial number is correct and locked, skip steps 3, 4, and 5, and go to step 6. If the serial number is correct but not locked, skip steps 3 and 4, and go to step 5. If the serial number is not correct, but is locked, this feature cannot be enabled and the remainder of this procedure cannot be performed. Contact the Customer Care Center to get an incorrect and locked serial number changed. Refer to "Customer Care Center" on page 1-9 for the contact information. The serial number can be found on a label affixed to the control shelf (shelf 1100).

3. Enter the correct serial number into the database using the `ent-serial-num` command with the `serial` parameter.

For this example, enter this command.

```
ent-serial-num:serial=<EAGLE 5 ISS's correct serial number>
```

When this command has successfully completed, the following message should appear.

```
rlghncxa03w 06-10-28 21:15:37 GMT EAGLE5 36.0.0
ENT-SERIAL-NUM: MASP A - COMPLTD
```

4. Verify that the serial number entered into step 3 was entered correctly using the **rtrv-serial-num** command. This is an example of the possible output.

```
rlghncxa03w 06-10-28 21:15:37 GMT EAGLE5 36.0.0
System serial number = nt00001231
```

System serial number is not locked.

```
rlghncxa03w 06-10-28 21:15:37 GMT EAGLE5 36.0.0
Command Completed
```

If the serial number was not entered correctly, repeat steps 3 and 4 and re-enter the correct serial number.

5. Lock the serial number in the database by entering the **ent-serial-num** command with the serial number shown in step 2, if the serial number shown in step 2 is correct, or with the serial number shown in step 4, if the serial number was changed in step 3, and with the **lock=yes** parameter.

For this example, enter this command.

```
ent-serial-num:serial=<EAGLE 5 ISS's serial number>:lock=yes
```

When this command has successfully completed, the following message should appear.

```
rlghncxa03w 06-10-28 21:15:37 GMT EAGLE5 36.0.0
ENT-SERIAL-NUM: MASP A - COMPLTD
```

6. Increase the system-wide IP transactions per second (TPS) by entering the **enable-ctrl-feat** command with the part number corresponding to the desired quantity (without the dashes), shown in Table 3-27 on page 3-318, and the feature access key for the desired quantity. For example, enter this command.

```
enable-ctrl-feat:partnum=893012814:fak=<feature access key>
```

NOTE: The number of system-wide IP transactions per second cannot be enabled with a temporary feature access key.

NOTE: If you do not have the feature access key, you can obtain it from your Tekelec Sales Representative or Account Representative.

When this command has successfully completed, the following message should appear.

```
rlghncxa03w 06-10-28 21:16:37 GMT EAGLE5 36.0.0
ENABLE-CTRL-FEAT: MASP A - COMPLTD
```

7. Verify the new feature information in the database by entering the **rtrv-ctrl-feat** command with the part number specified in step 6. For this example, enter this command.

```
rtrv-ctrl-feat:partnum=893012814
```

The following is an example of the possible output.

```
rlghncxa03w 06-10-28 21:17:37 GMT EAGLE5 36.0.0
```

The following features have been permanently enabled:

| Feature Name | Partnum | Status | Quantity |
|---------------------|-----------|--------|----------|
| IPGWx Signaling TPS | 893012814 | on | 20000 |

The following features have been temporarily enabled:

| Feature Name | Partnum | Status | Quantity | Trial Period Left |
|---------------------|---------|--------|----------|-------------------|
| Zero entries found. | | | | |

The following features have expired temporary keys:

| Feature Name | Partnum |
|---------------------|---------|
| Zero entries found. | |

-
8. Back up the new changes using the **chg-db:action=backup:dest=fixed** command. These messages should appear, the active Maintenance and Administration Subsystem Processor (MASP) appears first.

```
BACKUP (FIXED) : MASP A - Backup starts on active MASP.  
BACKUP (FIXED) : MASP A - Backup on active MASP to fixed disk complete.  
BACKUP (FIXED) : MASP A - Backup starts on standby MASP.  
BACKUP (FIXED) : MASP A - Backup on standby MASP to fixed disk complete.
```

Flowchart 3-27. Increasing the IPGWx Signaling TPS (Sheet 1 of 2)

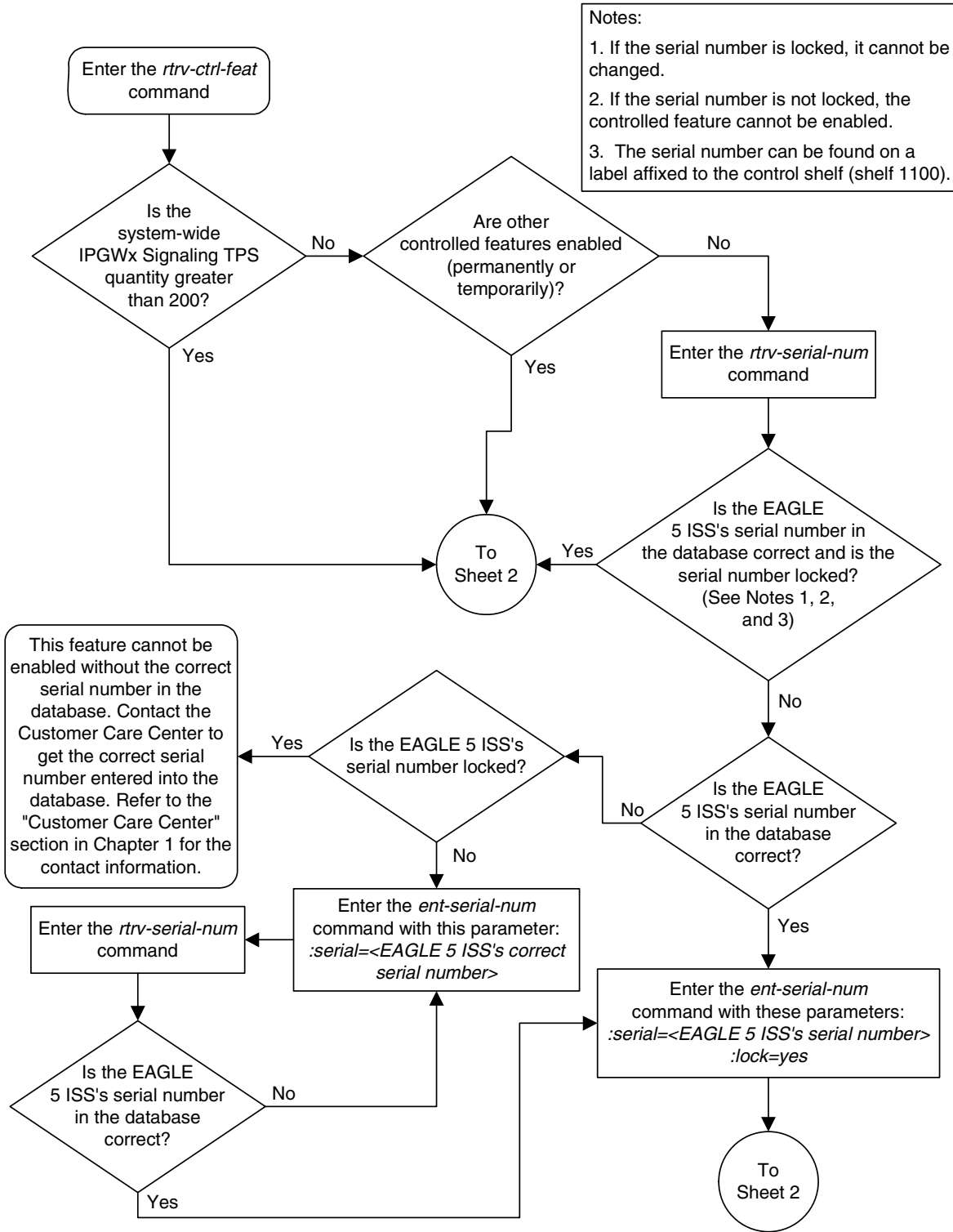

Flowchart 3-27. Increasing the IPGWx Signaling TPS (Sheet 2 of 2)

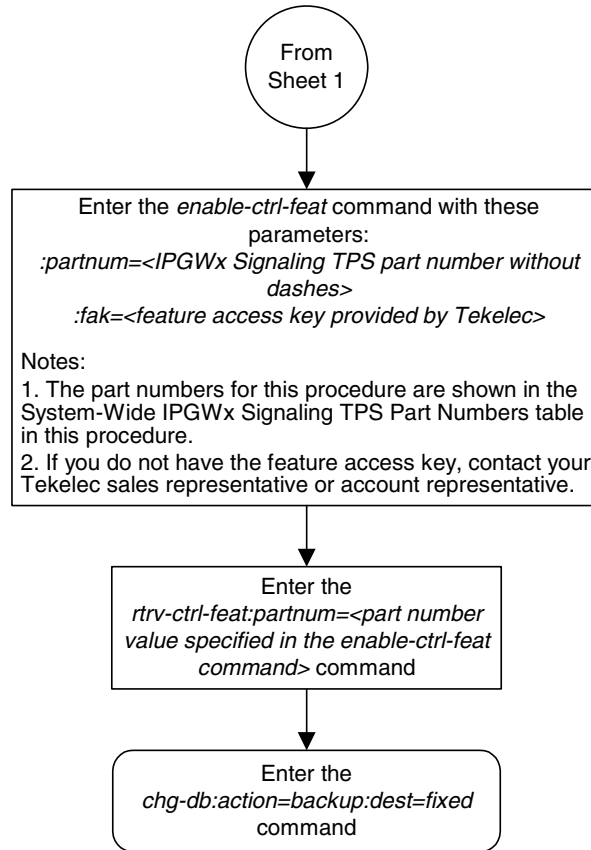

Configuring the IP TPS Alarm Threshold

The IP TPS alarm threshold is the percentage of the IPGWx signaling TPS at which an alarm is raised. This threshold is set with the `iptpsalmthresh` parameter of the `chg-sg-opts` command. The values for the `iptpsalmthresh` parameter are from 10 to 100 percent, with the system default value of 80 percent. The value of the IP TPS alarm threshold is shown in the `IPTPSALMTHRESH` field of the `rtrv-sg-opts` command output.

When this threshold is exceeded, UAM 0114, System IP TPS Threshold exceeded, is generated. UAM 0114 is automatically cleared when the percentage of the IPGWx signaling TPS calculated by the EAGLE 5 ISS falls below the value of the `iptpsalmthresh` parameter value. UAM 0117, System IP TPS normal, is generated when UAM 0114 is cleared.



CAUTION: UAM 0114 is also generated if the IP TPS alarm threshold is set to a percentage that is less than the current percentage of the IPGWx signaling TPS calculated by the EAGLE 5 ISS. If UAM 0114 is not automatically cleared after performing this procedure, perform the alarm clearing procedure for UAM 0114 in the *Maintenance Manual*.

Procedure

1. Display the current IP options in the database by entering the `rtrv-sg-opts` command. The following is an example of the possible output.

```
rlghncxa03w 06-10-28 21:16:37 GMT EAGLE5 36.0.0
SYNC:          TALI
SRKQ:          250
DRKQ:          750
SNMPCONT:      john doe 555-123-4567
GETCOMM:       public
SETCOMM:       private
TRAPCOMM:      public
INHFEPALM:     NO
SCTPCSUM:      crc32c
IPGWABATE:     NO
IPLIMABATE:    NO
IPTPSALMTHRESH: 80
```

2. Change the IP TPS alarm threshold using the `chg-sg-opts` command and the `iptpsalmthresh` parameter. For this example, enter this command.

```
chg-sg-opts:iptpsalmthresh=90
```

When this command has successfully completed, the following message should appear.

```
rlghncxa03w 06-10-28 21:19:37 GMT EAGLE5 36.0.0
CHG-SG-OPTS: MASP A - COMPLTD
```



CAUTION: UAM 0114 is generated if the IP TPS alarm threshold is set to a percentage that is less than the current percentage of the IPGWx signaling TPS calculated by the EAGLE 5 ISS. If UAM 0114 is not automatically cleared after performing this procedure, perform the alarm clearing procedure for UAM 0114 in the *Maintenance Manual*.

3. Verify the new IP options in the database using the `rtrv-sg-opts` command. The following is an example of the possible output.

```
rlghncxa03w 06-10-28 21:16:37 GMT EAGLE5 36.0.0
SYNC:          SASSI
SRKQ:          250
DRKQ:          750
SNMPCONT:     john doe 555-123-4567
GETCOMM:      public
SETCOMM:      private
TRAPCOMM:     public
INHFEPALM:    NO
SCTPCSUM:     crc32c
IPGWABATE:    NO
IPLIMABATE:   NO
IPTPSALMTHRESH: 90
```

4. Back up the new changes using the `chg-db:action=backup:dest=fixed` command. These messages should appear, the active Maintenance and Administration Subsystem Processor (MASP) appears first.

```
BACKUP (FIXED) : MASP A - Backup starts on active MASP.
BACKUP (FIXED) : MASP A - Backup on active MASP to fixed disk complete.
BACKUP (FIXED) : MASP A - Backup starts on standby MASP.
BACKUP (FIXED) : MASP A - Backup on standby MASP to fixed disk complete.
```

Flowchart 3-28. Configuring the IP TPS Alarm Threshold

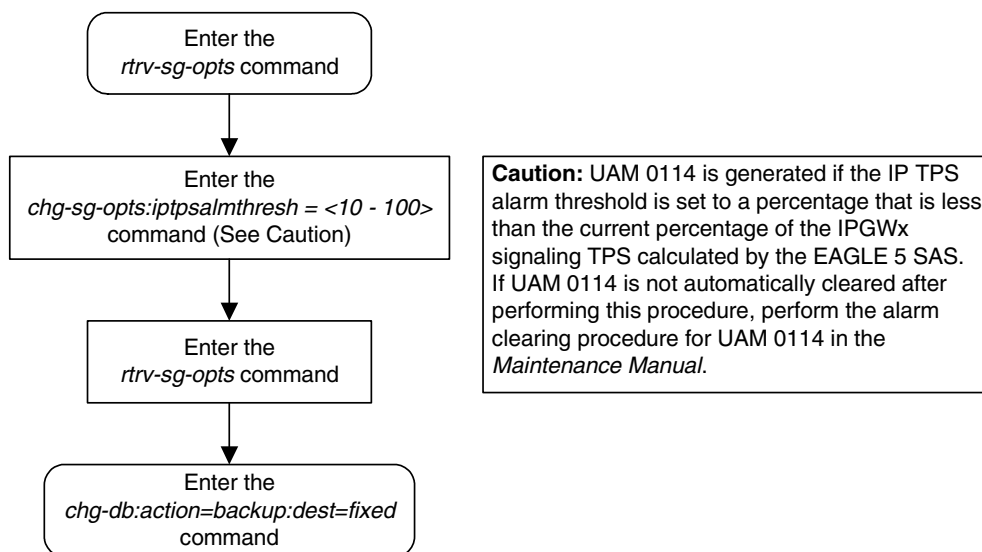

IETF Adapter Layer Configuration

To provision the IETF adapter layer, associations, application server processes, and application servers must be configured in the database, in this order:

1. Associations
2. Application servers (AS).

NOTE: The M2PA adapter layers on cards running either the IPLIM or IPLIMI applications (IPLIMx cards) does not support application servers. Application servers cannot be provisioned for associations assigned to IPLIMx cards. The SUA and M3UA adapter layer on cards running either the SS7IPGW or IPGWI applications (IPGWx cards) does support application servers. Application servers can be provisioned for associations assigned to IPGWx cards.

The application server is then assigned to a routing key. The following procedures show the steps necessary to provision the associations and application servers.

These procedures use a variety of commands. If more information on these commands is needed, go to the *Commands Manual* to find the required information.

Adding an Association

This procedure is used to configure SCTP associations in the socket table using the **ent-assoc** command. The combination of a local host, local SCTP port, remote host and remote SCTP port defines an association.

The **ent-assoc** command uses these parameters:

- :aname** – The name assigned to the association. Valid association names can contain up to 15 alphanumeric characters where the first character is a letter and the remaining characters are alphanumeric characters. The **aname** parameter value is not case-sensitive.
- :lhost** – Local Hostname. The logical name assigned to the local host device.
- :lport** – The SCTP port number for the local host.
- :rhost** – Remote Hostname. The logical name assigned to the remote host device.
- :rport** – The SCTP port number for the remote host.
- :link** – The signaling link on the IP card. If a signaling link is not specified for a socket when it is entered, the socket defaults to signaling link A. If the card's application is **iplim** or **iplimi**, and the card is a dual-slot DCM, the values for the **link** parameter can be only **a** or **b**. If the card's application is **iplim** or **iplimi**, and the card is a single-slot EDCM, the values for the **link** parameter can be **a**, **a1**, **a2**, **a3**, **b**, **b1**, **b2**, or **b3**. If the card's application is **iplim** or **iplimi**, and the card is an E5-ENET card, the values for the **link** parameter can be **a**, **a1**, **a2**, **a3**, **a4**, **a5**, **a6**, **a7**, **b**, **b1**, **b2**, **b3**, **b4**, **b5**, **b6**, or **b7**. If the IP card's application is **ss7ipgw** or **ipgwi**, only **link=a** can be specified.

NOTE: The **port** parameter can be used in place of the **link** parameter to specify the signaling link on the card.

- :adapter** – The adapter layer for this association, either **m3ua**, **sua**, **m2pa**. The **adapter** parameter is optional. If the association is an IPGWx association, the default value for the **adapter** parameter is **m3ua**. If the association is an IPLIMx association, the default value for the **adapter** parameter is **m2pa**.
- :alhost** – The alternate local host name.
- :m2patset** – The M2PA timer set assigned to the association. The **m2patset** parameter can be specified only with the **adatper=m2pa** parameter. If the **adapter=m2pa** parameter is specified, and the **m2patset** parameter is not specified with the **ent-assoc** command, the default value for the **m2patset** parameter (1 - M2PA timer set 1) is assigned to the association.

The socket table, which contains both the socket and association data, contains fields whose values are not assigned using the **ent-assoc** command. When an association is added to the database, these fields receive their default values. If a different value is desired, the **chg-assoc** command must be used. To change these values perform the "Changing an Association" procedure on page 3-348.

These fields and their default values are:

```

open=no      rmax=800      cwmn=3000   alw=no      uaps=10
istrms=2    rmode=lin     rtimes=10   ostrms=2    rmin=120
ver=rfc (applies only when the adapter=m2pa parameter is specified)
bufsize – If the association is an IPLIMx association, the default bufsize
value is 200. If the association is an IPGWx association, the default
bufsize value is 16.
    
```

The size of the buffers on the IP cards are shown in Table 3-28.

Table 3-28. SCTP Buffer Limits

| IP Card Application | Card Type | | |
|---------------------|---------------|------------------|--------------|
| | Dual-Slot DCM | Single-Slot EDCM | E5-ENET Card |
| IPLIMx | 400 kB | 1600 kB | 3200 kB |
| IPGWx | N/A | 800 kB | 3200 kB |

The size of the buffers assigned to each association that is assigned to the IP card cannot exceed the maximum buffer size for the IP card. When a new association is added, the default buffer size for the association is assigned to the association. If adding the new association causes the total buffer size for all the associations on the IP card to exceed the maximum buffer size for that IP card, the **ent-assoc** command will be rejected. If you wish to add the association and the maximum buffer size for the IP card will be exceeded, the buffer size of the other associations assigned to the IP card must be decreased by performing the “Changing an Association” procedure on page 3-348. The available size of the buffers on the IP card can be verified by entering this command.

```

rtrv-assoc:lhost=<local host name assigned to the association
being changed>
    
```

The **alhost** parameter can also be used with the **rtrv-assoc** command to display the available size of the buffers on the IP card.

The **aname** parameter can be used with the **rtrv-assoc** command to display the available size of the buffers on the IP card and the size of the buffer assigned to the association.

The value of the **lhost**, **rhost**, or **alhost** parameters is a text string of up to 60 characters, with the first character being a letter. The command line on the terminal can contain up to 150 characters. If the host names are too long to fit on the **ent-assoc** command line, go to the “Changing an Association” procedure on page 3-348 to complete the entry of the host names.

The EAGLE 5 ISS can contain a maximum of 4000 connections (association to application server assignments plus sockets).

For the **iplim** and **iplimi** applications, the IP card can have one association for each signaling link on the card. The dual-slot DCM can contain only two signaling links, resulting in a maximum of two associations on these cards. The single-slot EDCM can contain a maximum of eight signaling links, resulting in a maximum of eight associations for this card. The E5-ENET card can contain a maximum of 16 signaling links, resulting in a maximum of 16 associations for this card.

The B Ethernet interface of the IP card can be used only if the IP card is a single-slot EDCM or E5-ENET card.

If the association is to be activated in this procedure, with the **chg-assoc** command, the association must contain values for the **lhost**, **lport**, **rhost**, **rport** parameters.

If the card's application is either IPLIM or IPLIMI:

- The **iplim12** parameter value of the signaling link assigned to the association must be **m2pa**. The **adapter** parameter value of the association must be **m2pa**.
- The signaling link being assigned to the association must be out of service. This state is shown in the **rept-stat-slk** output with the entries **OOS-MT** in the **PST** field and **Unavail** in the **SST** field.
- If the association is being opened in this procedure with the **chg-assoc** command and the **open=yes** parameter, the signaling link assigned to the association must be in the database and the **iplim12** parameter value of the signaling link assigned to the association must be **m2pa**.

If the card's application is either SS7IPGW or IPGWI, the signaling link being assigned to the association must be in service. This state is shown in the **rept-stat-slk** output with the entries **IS-NR** in the **PST** field and **Avail** in the **SST** field.

Uni-homed endpoints are associations configured with the **lhost** parameter only. The **lhost** parameter value represents an IP address that corresponds to either the A or B network interface of the IP card. Multi-homed endpoints are associations configured with both the **lhost** and **alhost** parameters. The **lhost** parameter value represents an IP address corresponding to one of the network interfaces (A or B) of the IP card while the **alhost** parameter value represents an IP address corresponding to the other network interface of the same IP card.

Canceling the RTRV-ASSOC Command

Because the **rtrv-assoc** command used in this procedure can output information for a long period of time, the **rtrv-assoc** command can be canceled and the output to the terminal stopped. There are three ways that the **rtrv-assoc** command can be canceled.

- Press the **F9** function key on the keyboard at the terminal where the **rtrv-assoc** command was entered.
- Enter the **canc-cmd** without the **trm** parameter at the terminal where the **rtrv-assoc** command was entered.

- Enter the `canc-cmd:trm=<xx>`, where `<xx>` is the terminal where the `rtrv-assoc` command was entered, from another terminal other than the terminal where the `rtrv-assoc` command was entered. To enter the `canc-cmd:trm=<xx>` command, the terminal must allow Security Administration commands to be entered from it and the user must be allowed to enter Security Administration commands. The terminal's permissions can be verified with the `rtrv-secu-trm` command. The user's permissions can be verified with the `rtrv-user` or `rtrv-secu-user` commands.

For more information about the `canc-cmd` command, go to the *Commands Manual*.

Procedure

1. Display the associations in the database using the `rtrv-assoc` command. This is an example of possible output.

```
rlghncxa03w 06-10-28 09:12:36 GMT EAGLE5 36.0.0

          CARD IPLNK
ANAME      LOC  PORT  LINK ADAPTER  LPORT  RPORT  OPEN  ALW
swbel32    1201 A     A    M3UA   1030   2345   YES   YES
a2          1305 A     A    SUA    1030   2345   YES   YES
a3          1307 A     A    SUA    1030   2346   YES   YES
assoc3     1203 A     A1   M2PA   2048   1030   NO    NO
```

NOTE: If the required IP link is shown in the `rtrv-assoc` output in step 1, skip step 2 and go to step 3.

2. Display the IP links in the database by entering the `rtrv-ip-lnk` command. The following is an example of the possible output.

```
rlghncxa03w 06-10-28 21:19:37 GMT EAGLE5 36.0.0
LOC  PORT  IPADDR          SUBMASK          DUPLEX  SPEED  MACTYPE  AUTO  MCAST
1201 A    192.1.1.10     255.255.255.0   -----  ---   DIX      YES  NO
1203 A    192.1.1.12     255.255.255.0   -----  ---   DIX      YES  NO
1205 A    192.1.1.14     255.255.255.0   FULL    100   DIX      NO   NO
```

If the required IP link is not in the database, add the IP link using the "Changing an IP Link" on page 3-135 procedure.

3. Verify that the local host name to be assigned to the association is in the database by using the `rtrv-ip-host` command. The following is an example of the possible output.

```
rlghncxa03w 06-10-28 21:15:37 GMT EAGLE5 36.0.0

LOCAL IPADDR  LOCAL HOST
192.1.1.10    IPNODE1-1201
192.1.1.12    IPNODE1-1203
192.1.1.14    IPNODE1-1205
192.1.1.20    IPNODE2-1201
192.1.1.22    IPNODE2-1203
192.1.1.24    IPNODE2-1205
192.1.1.30    KC-HLR1
192.1.1.32    KC-HLR2
```

IP⁷ Secure Gateway Configuration Procedures

```
192.1.1.50      DN-MS1
192.1.1.52      DN-MS2

REMOTE IPADDR   REMOTE HOST
150.1.1.5       NCDEPTECONOMIC_DEVELOPMENT.SOUTHEASTERN_COORIDOR_ASHVL.GOV
```

IP Host table is (11 of 512) 2% full

The IP address of the IP link should be assigned to the local host name that will be assigned to the association.

If the local host name references a card running either the IPLIM or IPLIMI applications, the `iplim12` parameter value of the signaling link must be `m2pa`.

The values of the `lhost` and `alhost` parameters must be in the `LOCAL HOST` column in the `rtrv-ip-host` output.

If the required hostname is not in the database, add the IP host name using the "Adding an IP Host" on page 3-153 procedure.

-
4. Display the application running on the IP card shown in either step 1 or step 2 using the `rept-stat-card` command specifying the location of the IP card. For this example, enter this command.

```
rept-stat-card:loc=1203
```

This is an example of the possible output.

```
rlghncxa03w 06-10-27 17:00:36 GMT EAGLE5 36.0.0
CARD VERSION      TYPE      APPL      PST          SST          AST
1203  114-000-000  DCM      IPLIM      IS-NR        Active       -----
ALARM STATUS      = No Alarms.
BPDCM GPL         = 002-102-000
IMT BUS A         = Conn
IMT BUS B         = Conn
SIGNALING LINK STATUS
SLK  PST          LS          CLLI
A    IS-NR        e5e6a      -----
```

Command Completed.

NOTE: If a new IP host was added in step 3, skip step 5 and go to step 6.

5. Verify the available buffer size for the IP card that will contain the association being added in this procedure by entering the `rtrv-assoc` command with the local host name assigned to the association being added. For this example, enter this command.

```
rtrv-assoc:lhost=IPNODE2-1203
```

This is an example of the possible output.

```
rlghncxa03w 06-10-28 09:12:36 GMT EAGLE5 36.0.0
CARD IPLNK
ANAME          LOC  PORT  LINK ADAPTER  LPORT  RPORT  OPEN  ALW
assoc2         1203 A    A1   M2PA        2048   1030   NO    NO
```

```
IP Appl Sock/Assoc table is (8 of 4000) 1% full
Assoc Buffer Space Used (200 KB of 1600 KB) on LOC = 1203
```

If adding the new association causes the total buffer size for all the associations on the IP card to exceed the maximum buffer size for that IP card, the **ent-assoc** command will be rejected.

The default buffer value for an IPLIMx association is 200. The default buffer value for an IPGWx association is 16.

If you wish to add the association and the maximum buffer size for the IP card will be exceeded, the buffer size of the other associations assigned to the IP card must be decreased by performing the “Changing an Association” procedure on page 3-348.

NOTE: If the card’s application is SS7IPGW or IPGWI, shown in the APPL column in the **rept-stat-card** output in step 4, skip steps 6, 7, 8, 9, and 10, and go to step 11.

6. Display the signaling link referenced by the IP link that will be assigned to the association by entering the **rtrv-slk** command and specifying the card location and signaling link. For this example, enter this command.

```
rtrv-slk:loc=1203:link=a
```

This is an example of the possible output.

```
rlghncxa03w 06-10-19 21:17:04 GMT EAGLE5 36.0.0
LOC  LINK LSN          SLC TYPE   IPLIML2
1203 A    e5e6a          1  IPLIM    M2PA
```

When the IP card’s application is either IPLIM or IPLIMI, the **ipliml2** parameter value for the signaling link assigned to the association must be **m2pa**, and must match the value of the **adapter** parameter specified in step 11. If the **ipliml2** parameter is not **m2pa**, remove the signaling link using the “Removing an IP Signaling Link” procedure on page 3-113. Add the signaling link back into the database with the **ipliml2=m2pa** parameter, and without activating the signaling link, using the “Adding an IP Signaling Link” procedure on page 3-84.

NOTE: If the “Adding an IP Signaling Link” procedure on page 3-84 was performed in step 6, skip steps 7, 8, and 9, and go to step 10.

7. Display the status of the signaling link shown in step 6 using the **rept-stat-slk** command specifying the card location and signaling link. For example, enter this command.

```
rept-stat-slk:loc=1203:link=a
```

This is an example of the possible output.

```
rlghncxa03w 06-10-28 21:16:37 GMT EAGLE5 36.0.0
SLK   LSN      CLLI      PST      SST      AST
1203,A e5e6a     -----  IS-NR    Avail    ----
Command Completed.
```

NOTE: If the primary state (PST) of the signaling link is `OOS-MT` and the secondary state (SST) is `Unavail`, skip steps 8 and 9, and go to step 10.

8. Deactivate the signaling link from step 7 using the `dact-slk` command. For example, enter this command.

```
dact-slk:loc=1203:link=a
```

When this command has successfully completed, the following message should appear.

```
rlghncxa03w 06-10-07 11:11:28 GMT EAGLE5 36.0.0
Deactivate Link message sent to card
```

9. Verify the status of the signaling link using the `rept-stat-slk` command. For example, enter this command.

```
rept-stat-slk:loc=1203:link=a
```

This is an example of the possible output.

```
rlghncxa03w 06-10-28 21:16:37 GMT EAGLE5 36.0.0
SLK      LSN      CLLI      PST      SST      AST
1203,A   e5e6a     -----  OOS-MT   Unavail   ----
Command Completed.
```

10. Verify the values of the M2PA timer set you wish to assign to the association by entering the `rtrv-m2pa-tset` command with the `ver=rfc` parameter. When an M2PA association is provisioned in this procedure, the RFC M2PA version is assigned to the M2PA association by default.

The M2PA version of the association determines the version of the M2PA timer set that is assigned to the association. For example, if M2PA timer set 3 is assigned to the M2PA association, and the association is an RFC M2PA association, the RFC version of M2PA timer set 3 is used with the association. If M2PA timer set 7 is assigned to the M2PA association, and the association is a Draft 6 M2PA association, the Draft 6 version of M2PA timer set 7 is used with the association.

If you wish to assign the Draft 6 M2PA version to this association and use the Draft 6 M2PA timer sets, perform the “Changing an Association” procedure on page 3-348 after this procedure is completed to change the M2PA version of this association.

NOTE: If the `m2patset` parameter will not be specified with the `ent-assoc` command, the M2PA timer set 1 will be assigned to the association.

To display the M2PA Draft 6 timer values, enter this command.

```
rtrv-m2pa-tset:ver=d6
```

This is an example of the possible output.

```
rlghncxa03w 06-10-28 21:16:37 GMT EAGLE5 36.0.0
M2PA Draft 6 Timers (in msec, T16 in microsec)
```

IP⁷ Secure Gateway Configuration Procedures

| TSET | T1 | T2 | T3 | T4N | T4E | T5 | T6 | T7 | T16 | T17 | T18 |
|------|--------|-------|-------|-------|-----|-------|------|------|--------|-----|-------|
| 1 | 6000 | ----- | 5000 | 20000 | 500 | 5000 | 4000 | 1000 | 100000 | 150 | 500 |
| 2 | 7500 | ----- | 1500 | 2000 | 500 | 9000 | 1250 | 300 | 150000 | 175 | 600 |
| 3 | 100000 | ----- | 2000 | 3000 | 500 | 4000 | 1500 | 500 | 170000 | 200 | 800 |
| 4 | 200000 | ----- | 20000 | 4000 | 500 | 6000 | 2000 | 700 | 480000 | 225 | 900 |
| 5 | 250000 | ----- | 30000 | 30000 | 500 | 100 | 2250 | 400 | 400000 | 400 | 8000 |
| 6 | 50000 | ----- | 50000 | 60000 | 500 | 500 | 4500 | 800 | 300000 | 300 | 7000 |
| 7 | 10000 | ----- | 10000 | 10000 | 500 | 1000 | 3000 | 1200 | 200000 | 250 | 1000 |
| 8 | 80000 | ----- | 1500 | 15000 | 500 | 8000 | 2750 | 1100 | 350000 | 350 | 5000 |
| 9 | 27500 | ----- | 3850 | 4859 | 450 | 5700 | 3750 | 1150 | 250 | 375 | 8750 |
| 10 | 90000 | ----- | 2500 | 50000 | 500 | 7500 | 5000 | 1750 | 440000 | 450 | 3000 |
| 11 | 20000 | ----- | 4500 | 5500 | 500 | 6500 | 5500 | 1600 | 250000 | 475 | 4500 |
| 12 | 30000 | ----- | 7500 | 7000 | 500 | 750 | 4250 | 1800 | 275000 | 275 | 3500 |
| 13 | 40000 | ----- | 35000 | 9000 | 500 | 1250 | 3500 | 1900 | 500 | 325 | 9000 |
| 14 | 70000 | ----- | 45000 | 11000 | 500 | 1500 | 1750 | 900 | 1000 | 125 | 6000 |
| 15 | 9000 | ----- | 25000 | 40000 | 500 | 2500 | 3250 | 600 | 5000 | 425 | 5500 |
| 16 | 75000 | ----- | 15000 | 25000 | 500 | 4500 | 1600 | 1400 | 6000 | 240 | 9500 |
| 17 | 350000 | ----- | 60000 | 70000 | 600 | 10000 | 6000 | 2000 | 500000 | 500 | 10000 |
| 18 | 150000 | ----- | 55000 | 35000 | 500 | 3500 | 5750 | 1500 | 125000 | 440 | 750 |
| 19 | 175000 | ----- | 12500 | 45000 | 500 | 1100 | 2600 | 1300 | 7000 | 340 | 850 |
| 20 | 1000 | ----- | 1000 | 1000 | 400 | 80 | 1000 | 200 | 100 | 100 | 100 |

To display the M2PA RFC values, enter this command.

```
rtrv-m2pa-tset:ver=rfc
```

This is an example of the possible output.

```
rlghncxa03w 06-10-28 21:16:37 GMT EAGLE5 36.0.0
```

```
M2PA RFC Timers (in msec, T16 in microsec)
```

| TSET | T1 | T2 | T3 | T4N | T4E | T5 | T6 | T7 | T16 | T17 | T18 |
|------|--------|--------|-------|-------|-----|-------|------|------|--------|-----|-------|
| 1 | 6000 | 75000 | 5000 | 20000 | 500 | 5000 | 4000 | 1000 | 100000 | 150 | 500 |
| 2 | 7500 | 8000 | 1500 | 2000 | 500 | 9000 | 1250 | 300 | 150000 | 175 | 600 |
| 3 | 100000 | 10000 | 2000 | 3000 | 500 | 4000 | 1500 | 500 | 170000 | 200 | 800 |
| 4 | 200000 | 6000 | 20000 | 4000 | 500 | 6000 | 2000 | 700 | 480000 | 225 | 900 |
| 5 | 250000 | 140000 | 30000 | 30000 | 500 | 100 | 2250 | 400 | 400000 | 400 | 8000 |
| 6 | 50000 | 100000 | 50000 | 60000 | 500 | 500 | 4500 | 800 | 300000 | 300 | 7000 |
| 7 | 300000 | 20000 | 2000 | 10000 | 500 | 1000 | 3000 | 1200 | 200000 | 250 | 1000 |
| 8 | 80000 | 130000 | 1500 | 15000 | 500 | 8000 | 2750 | 1100 | 350000 | 350 | 5000 |
| 9 | 27500 | 120000 | 3850 | 4859 | 450 | 5700 | 3750 | 1150 | 250 | 375 | 8750 |
| 10 | 90000 | 9000 | 2500 | 50000 | 500 | 7500 | 5000 | 1750 | 440000 | 450 | 3000 |
| 11 | 20000 | 60000 | 4500 | 5500 | 500 | 6500 | 5500 | 1600 | 250000 | 475 | 4500 |
| 12 | 30000 | 50000 | 7500 | 7000 | 500 | 750 | 4250 | 1800 | 275000 | 275 | 3500 |
| 13 | 40000 | 90000 | 35000 | 9000 | 500 | 1250 | 3500 | 1900 | 500 | 325 | 9000 |
| 14 | 70000 | 45000 | 45000 | 11000 | 500 | 1500 | 1750 | 900 | 1000 | 125 | 6000 |
| 15 | 9000 | 30000 | 25000 | 40000 | 500 | 2500 | 3250 | 600 | 5000 | 425 | 5500 |
| 16 | 75000 | 15000 | 15000 | 25000 | 500 | 4500 | 1600 | 1400 | 6000 | 240 | 9500 |
| 17 | 350000 | 150000 | 60000 | 70000 | 600 | 10000 | 6000 | 2000 | 500000 | 500 | 10000 |
| 18 | 150000 | 20000 | 55000 | 35000 | 500 | 3500 | 5750 | 1500 | 125000 | 440 | 750 |
| 19 | 175000 | 12500 | 12500 | 45000 | 500 | 1100 | 2600 | 1300 | 7000 | 340 | 850 |
| 20 | 1000 | 5000 | 1000 | 1000 | 400 | 80 | 1000 | 200 | 100 | 100 | 100 |

If the **ver** parameter is not specified when entering the **rtrv-m2pa-tset** command, both the Draft 6 and RFC values are displayed. This is an example of the possible output.

```
rlghncxa03w 06-10-28 21:16:37 GMT EAGLE5 36.0.0
```

```
M2PA Draft 6 Timers (in msec, T16 in microsec)
```

IP7 Secure Gateway Configuration Procedures

| TSET | T1 | T2 | T3 | T4N | T4E | T5 | T6 | T7 | T16 | T17 | T18 |
|------|--------|-------|-------|-------|-----|-------|------|------|--------|-----|-------|
| 1 | 6000 | ----- | 5000 | 20000 | 500 | 5000 | 4000 | 1000 | 100000 | 150 | 500 |
| 2 | 7500 | ----- | 1500 | 2000 | 500 | 9000 | 1250 | 300 | 150000 | 175 | 600 |
| 3 | 100000 | ----- | 2000 | 3000 | 500 | 4000 | 1500 | 500 | 170000 | 200 | 800 |
| 4 | 200000 | ----- | 20000 | 4000 | 500 | 6000 | 2000 | 700 | 480000 | 225 | 900 |
| 5 | 250000 | ----- | 30000 | 30000 | 500 | 100 | 2250 | 400 | 400000 | 400 | 8000 |
| 6 | 50000 | ----- | 50000 | 60000 | 500 | 500 | 4500 | 800 | 300000 | 300 | 7000 |
| 7 | 10000 | ----- | 10000 | 10000 | 500 | 1000 | 3000 | 1200 | 200000 | 250 | 1000 |
| 8 | 80000 | ----- | 1500 | 15000 | 500 | 8000 | 2750 | 1100 | 350000 | 350 | 5000 |
| 9 | 27500 | ----- | 3850 | 4859 | 450 | 5700 | 3750 | 1150 | 250 | 375 | 8750 |
| 10 | 90000 | ----- | 2500 | 50000 | 500 | 7500 | 5000 | 1750 | 440000 | 450 | 3000 |
| 11 | 20000 | ----- | 4500 | 5500 | 500 | 6500 | 5500 | 1600 | 250000 | 475 | 4500 |
| 12 | 30000 | ----- | 7500 | 7000 | 500 | 750 | 4250 | 1800 | 275000 | 275 | 3500 |
| 13 | 40000 | ----- | 35000 | 9000 | 500 | 1250 | 3500 | 1900 | 500 | 325 | 9000 |
| 14 | 70000 | ----- | 45000 | 11000 | 500 | 1500 | 1750 | 900 | 1000 | 125 | 6000 |
| 15 | 9000 | ----- | 25000 | 40000 | 500 | 2500 | 3250 | 600 | 5000 | 425 | 5500 |
| 16 | 75000 | ----- | 15000 | 25000 | 500 | 4500 | 1600 | 1400 | 6000 | 240 | 9500 |
| 17 | 350000 | ----- | 60000 | 70000 | 600 | 10000 | 6000 | 2000 | 500000 | 500 | 10000 |
| 18 | 150000 | ----- | 55000 | 35000 | 500 | 3500 | 5750 | 1500 | 125000 | 440 | 750 |
| 19 | 175000 | ----- | 12500 | 45000 | 500 | 1100 | 2600 | 1300 | 7000 | 340 | 850 |
| 20 | 1000 | ----- | 1000 | 1000 | 400 | 80 | 1000 | 200 | 100 | 100 | 100 |

M2PA RFC Timers (in msec, T16 in microsec)

| TSET | T1 | T2 | T3 | T4N | T4E | T5 | T6 | T7 | T16 | T17 | T18 |
|------|--------|--------|-------|-------|-----|-------|------|------|--------|-----|-------|
| 1 | 6000 | 75000 | 5000 | 20000 | 500 | 5000 | 4000 | 1000 | 100000 | 150 | 500 |
| 2 | 7500 | 8000 | 1500 | 2000 | 500 | 9000 | 1250 | 300 | 150000 | 175 | 600 |
| 3 | 100000 | 10000 | 2000 | 3000 | 500 | 4000 | 1500 | 500 | 170000 | 200 | 800 |
| 4 | 200000 | 6000 | 20000 | 4000 | 500 | 6000 | 2000 | 700 | 480000 | 225 | 900 |
| 5 | 250000 | 140000 | 30000 | 30000 | 500 | 100 | 2250 | 400 | 400000 | 400 | 8000 |
| 6 | 50000 | 100000 | 50000 | 60000 | 500 | 500 | 4500 | 800 | 300000 | 300 | 7000 |
| 7 | 300000 | 20000 | 2000 | 10000 | 500 | 1000 | 3000 | 1200 | 200000 | 250 | 1000 |
| 8 | 80000 | 130000 | 1500 | 15000 | 500 | 8000 | 2750 | 1100 | 350000 | 350 | 5000 |
| 9 | 27500 | 120000 | 3850 | 4859 | 450 | 5700 | 3750 | 1150 | 250 | 375 | 8750 |
| 10 | 90000 | 9000 | 2500 | 50000 | 500 | 7500 | 5000 | 1750 | 440000 | 450 | 3000 |
| 11 | 20000 | 60000 | 4500 | 5500 | 500 | 6500 | 5500 | 1600 | 250000 | 475 | 4500 |
| 12 | 30000 | 50000 | 7500 | 7000 | 500 | 750 | 4250 | 1800 | 275000 | 275 | 3500 |
| 13 | 40000 | 90000 | 35000 | 9000 | 500 | 1250 | 3500 | 1900 | 500 | 325 | 9000 |
| 14 | 70000 | 45000 | 45000 | 11000 | 500 | 1500 | 1750 | 900 | 1000 | 125 | 6000 |
| 15 | 9000 | 30000 | 25000 | 40000 | 500 | 2500 | 3250 | 600 | 5000 | 425 | 5500 |
| 16 | 75000 | 15000 | 15000 | 25000 | 500 | 4500 | 1600 | 1400 | 6000 | 240 | 9500 |
| 17 | 350000 | 150000 | 60000 | 70000 | 600 | 10000 | 6000 | 2000 | 500000 | 500 | 10000 |
| 18 | 150000 | 20000 | 55000 | 35000 | 500 | 3500 | 5750 | 1500 | 125000 | 440 | 750 |
| 19 | 175000 | 12500 | 12500 | 45000 | 500 | 1100 | 2600 | 1300 | 7000 | 340 | 850 |
| 20 | 1000 | 5000 | 1000 | 1000 | 400 | 80 | 1000 | 200 | 100 | 100 | 100 |

If the M2PA timer set you wish to assign to the association does not contain the desired values, go to the “Changing an M2PA Timer Set” procedure on page 3-389 and changed the desired timer values.



CAUTION: Changing an M2PA timer set may affect the performance of any associations using the timer set being changed.

11. Add the associations using the `ent-assoc` command. For this example, enter these commands.

```
ent-assoc:aname=assoc1:lhost=gw105.nc.tekelec.com:lport=1030:
rhost=gw100.nc.tekelec.com:rport=1030:adapter=m3ua:link=a
ent-assoc:aname=assoc2:lhost=gw107.nc.tekelec.com:lport=2000:
rhost=gw100.nc.tekelec.com:rport=1030:adapter=m2pa:link=a
```

NOTE: The `port` parameter can be used in place of the `link` parameter to specify the signaling link on the card.

NOTE: See Flowchart 3-29 on page 3-343 (Sheet 6) for the rules that apply to the `ent-assoc` command.

When each of these commands have successfully completed, this message should appear.

```
rlghncxa03w 06-10-28 09:12:36 GMT EAGLE5 36.0.0
ENT-ASSOC: MASP A - COMPLTD
```

NOTE: If the association added in step 11 is not being activated in this procedure, skip step 12 and go to step 13.

12. Activate the association added in step 11 by entering the `chg-assoc` command with the association name specified in step 11 and the `open=yes` and `alw=yes` parameters. For example, enter this command.

```
chg-assoc:aname=assoc1:open=yes:alw=yes
chg-assoc:aname=assoc2:open=yes:alw=yes
```

When each of these commands have successfully completed, this message should appear.

```
rlghncxa03w 06-10-28 21:15:37 GMT EAGLE5 36.0.0
CHG-ASSOC: MASP A - COMPLTD
```

13. Verify the changes using the `rtrv-assoc` command specifying the association name specified in steps 11 and 12. For this example, enter these commands.

```
rtrv-assoc:aname=assoc1
```

This is an example of possible output.

```
rlghncxa03w 06-10-28 09:12:36 GMT EAGLE5 36.0.0
ANAME assoc1
      LOC      1207          IPLNK PORT  A          LINK  A
ADAPTER  M3UA          VER      M3UA RFC
LHOST    gw105.nc.tekelec.com
ALHOST   ---
RHOST    gw100.nc.tekelec.com
LPORT    1030          RPORT    1030
ISTRMS   2              OSTRMS   2          BUFSIZE  16
RMODE    LIN           RMIN     120        RMAX     800
RTIMES   10           CWMIN    3000
OPEN     YES           ALW      YES
ASNAMES
as2
```

```
IP Appl Sock table is (5 of 4000) 1% full
Assoc Buffer Space Used (16 KB of 800 KB) on LOC = 1207
```

rtrv-assoc:aname=assoc2

This is an example of possible output.

```
rlghncxa03w 06-10-28 09:12:36 GMT EAGLE5 36.0.0
ANAME assoc2
      LOC      1203          IPLNK PORT  A          LINK  A
      ADAPTER  M2PA          VER          M2PA RFC
      LHOST    gw105.nc.tekelec.com
      ALHOST    ---
      RHOST    gw100.nc.tekelec.com
      LPORT    1030          RPORT      1030
      ISTRMS   2             OSTRMS     2             BUFSIZE  200
      RMODE    LIN           RMIN       120            RMAX     800
      RTIMES   10           CWMIN      3000          M2PATSET 1
      OPEN     NO            ALW        NO
```

```
IP Appl Sock table is (5 of 4000) 1% full
Assoc Buffer Space Used (400 KB of 1600 KB) on LOC = 1203
```

NOTE: If the card's application is SS7IPGW or IPGWI, skip steps 14 and 15, and go to step 16.

- 14** Activate the signaling link assigned to the association using the **act-slk** command. For example, enter this command.

act-slk:loc=1203:link=a

When this command has successfully completed, the following message should appear.

```
rlghncxa03w 06-10-07 11:11:28 GMT EAGLE5 36.0.0
Activate Link message sent to card
```

- 15.** Verify the status of the signaling link using the **rept-stat-slk** command. For example, enter this command.

rept-stat-slk:loc=1203:link=a

This is an example of the possible output.

```
rlghncxa03w 06-10-28 21:16:37 GMT EAGLE5 36.0.0
SLK      LSN          CLLI          PST          SST          AST
1203,A   e5e6a          ----- IS-NR          Avail          ----
Command Completed.
```

- 16.** Back up the new changes, using the **chg-db:action=backup:dest=fixed** command. These messages should appear; the active Maintenance and Administration Subsystem Processor (MASP) appears first.

```
BACKUP (FIXED) : MASP A - Backup starts on active MASP.
BACKUP (FIXED) : MASP A - Backup on active MASP to fixed disk complete.
BACKUP (FIXED) : MASP A - Backup starts on standby MASP.
BACKUP (FIXED) : MASP A - Backup on standby MASP to fixed disk complete.
```

Flowchart 3-29. Adding an Association (Sheet 1 of 6)

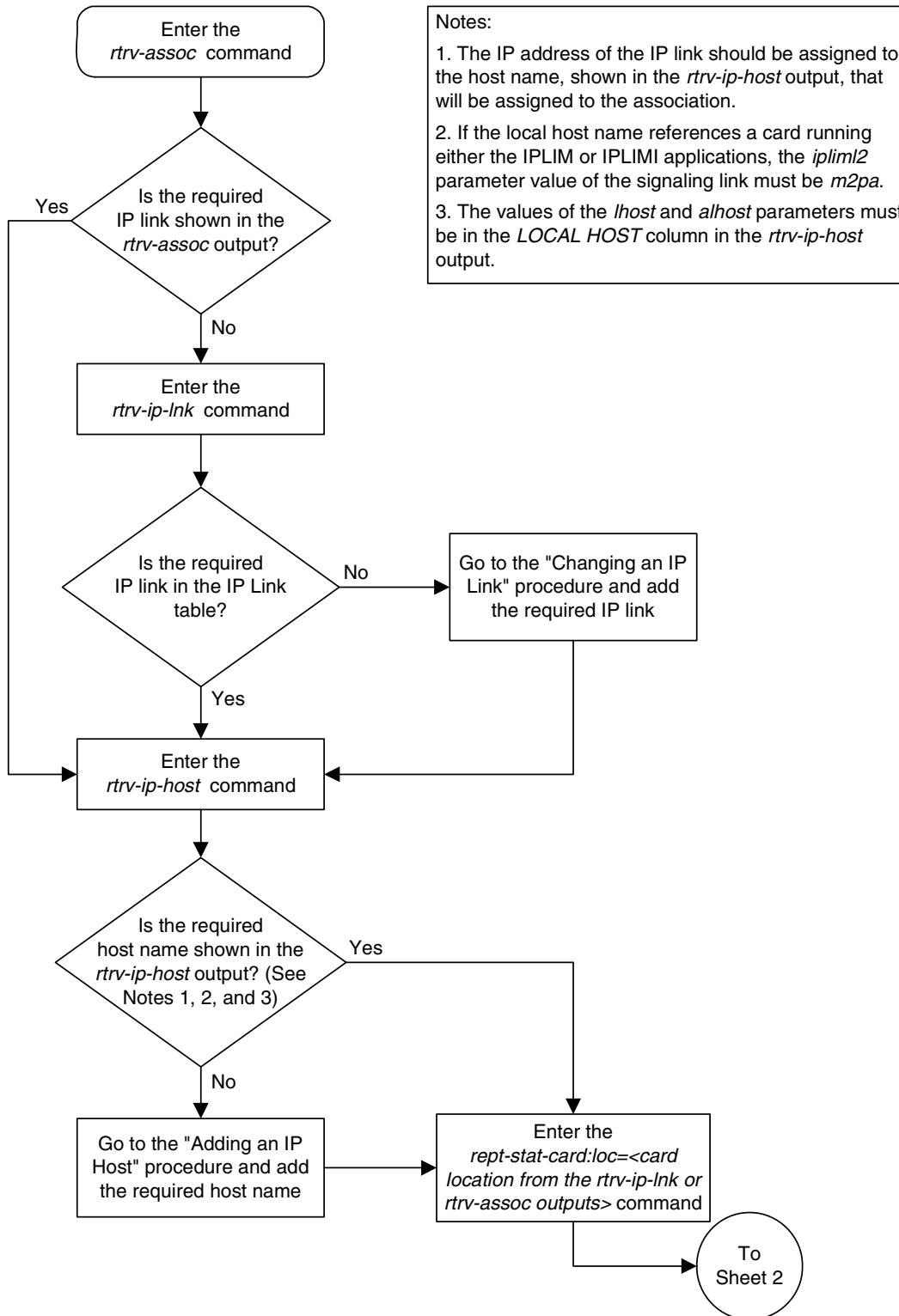

Notes:

1. The IP address of the IP link should be assigned to the host name, shown in the *rtrv-ip-host* output, that will be assigned to the association.
2. If the local host name references a card running either the IPLIM or IPLIMI applications, the *ipliml2* parameter value of the signaling link must be *m2pa*.
3. The values of the *lhost* and *alhost* parameters must be in the *LOCAL HOST* column in the *rtrv-ip-host* output.

Flowchart 3-29. Adding an Association (Sheet 2 of 6)

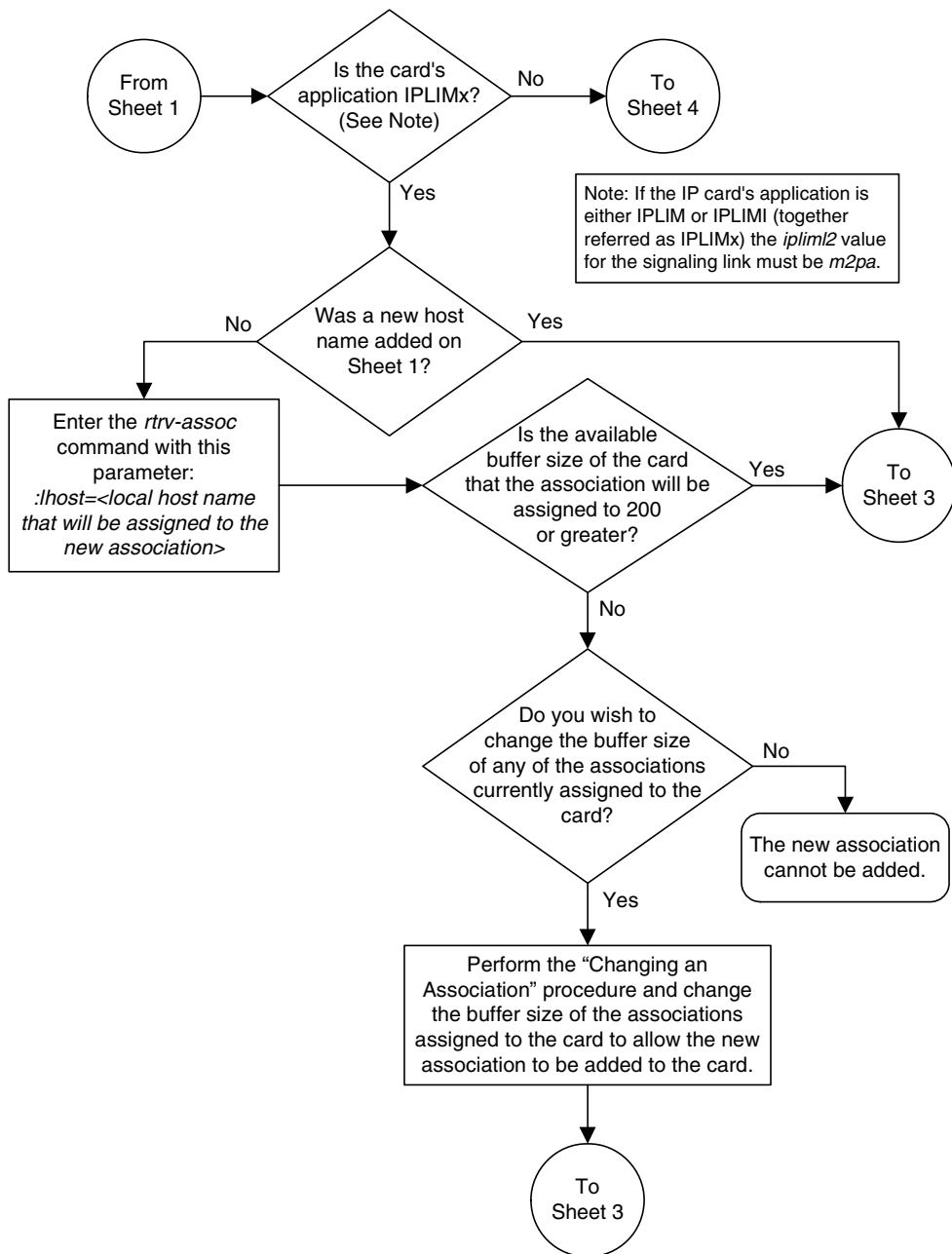

Flowchart 3-29. Adding an Association (Sheet 3 of 6)

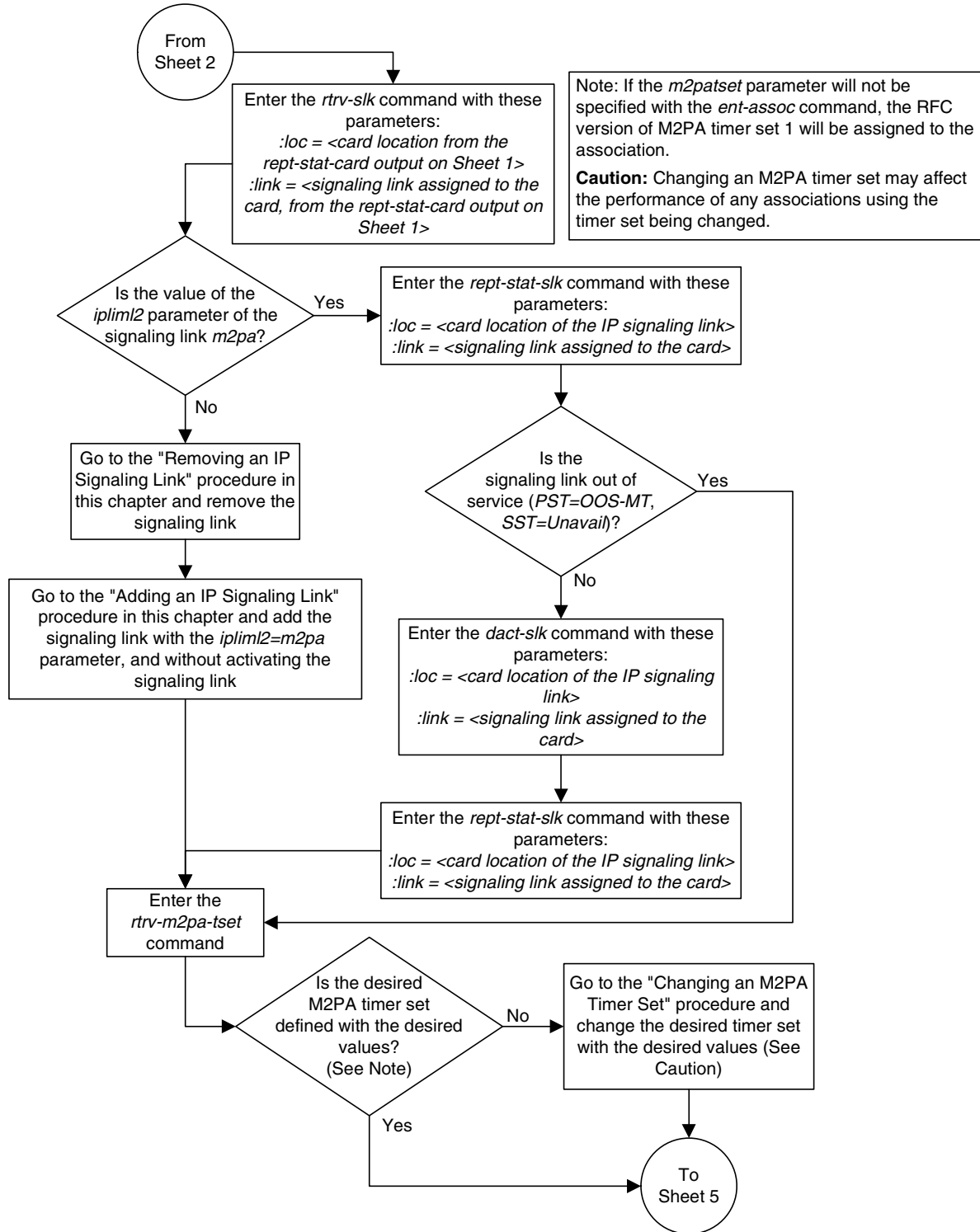

Flowchart 3-29. Adding an Association (Sheet 4 of 6)

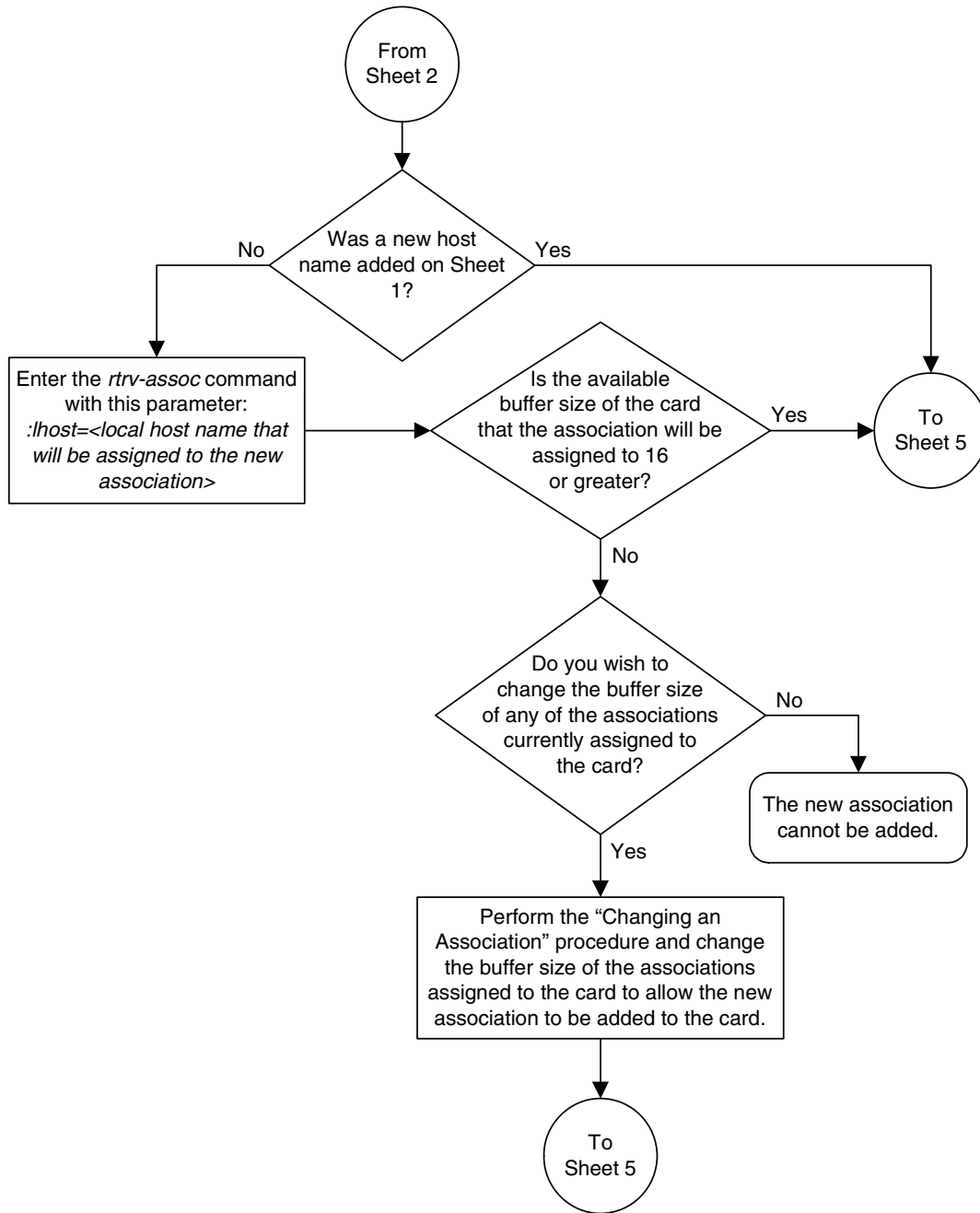

Flowchart 3-29. Adding an Association (Sheet 5 of 6)

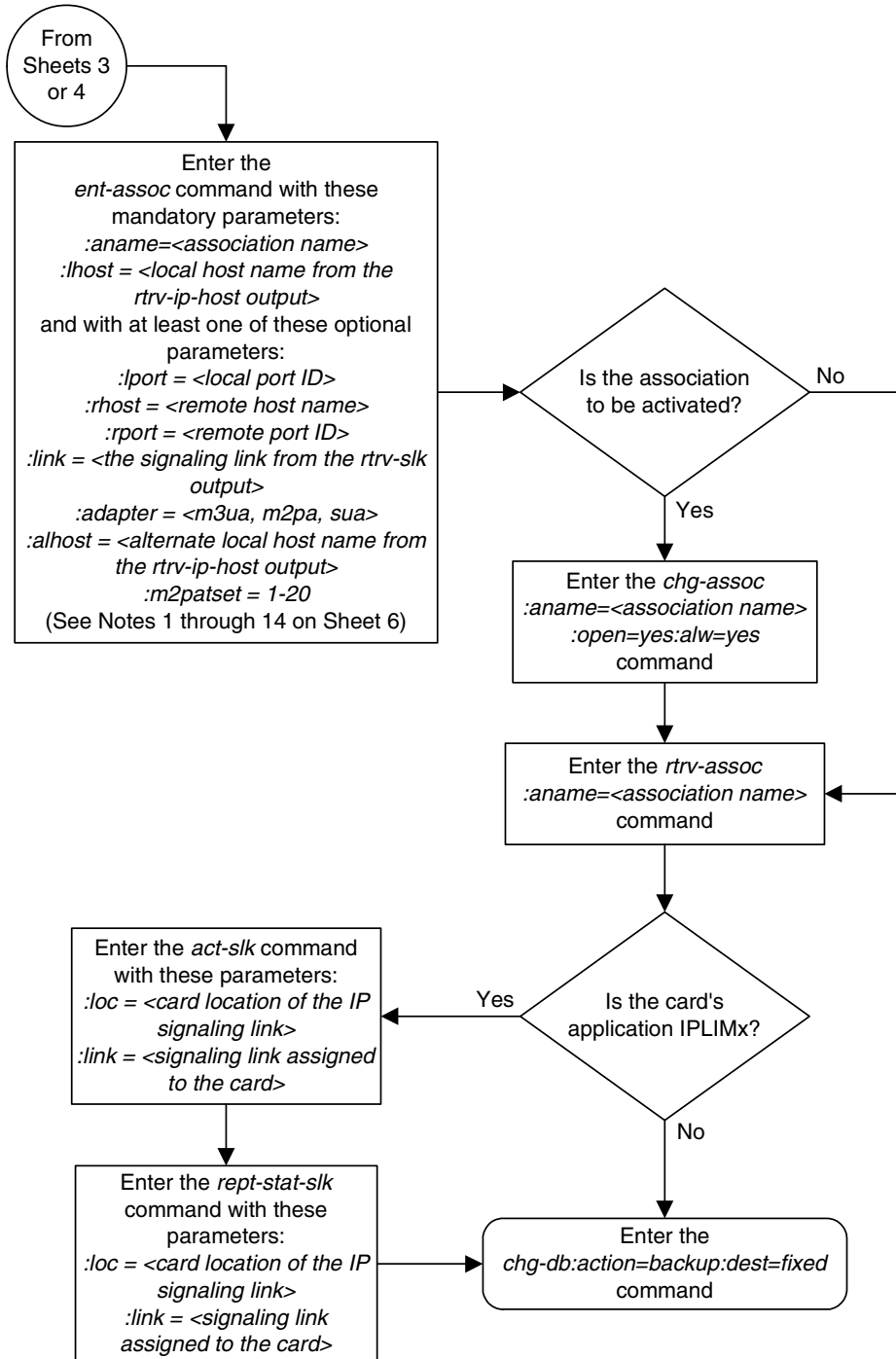

Flowchart 3-29. Adding an Association (Sheet 6 of 6)

Notes:

1. If the card containing the signaling link is a DCM, the B Ethernet interface cannot be used. Single-slot EDCMs or E5-ENET cards can use the B Ethernet interface.
2. If the card's application is either *iplim* or *iplimi*, the *adapter* parameter value must be *m2pa*. The value of the *ipliml2* parameter of the signaling link being assigned to this association must be *m2pa*.
3. Each local host on a card running either the *ss7ipgw* or *ipgwi* applications can contain a maximum of 50 connections (association – application server assignments plus sockets).
4. The EAGLE 5 ISS can contain a maximum of 4000 connections (association – application server assignments plus sockets).
5. Cards running either the *iplim* or *iplimi* applications can have only one connection for each signaling link and a maximum of two connections for each card, if the card is a dual-slot DCM. If the card is a single-slot EDCM, the card may contain a maximum of eight connections. If the card is an E5-ENET card, the card may contain a maximum of 16 connections.
6. The value of the *lhost*, *rhost*, or *alhost* parameters is a text string of up to 60 characters, with the first character being a letter. The command line on the terminal can contain up to 150 characters. If the host names are too long to fit on the *ent-assoc* command line, go to the "Changing an Association" procedure in this chapter to complete the entry of the host names.
7. If the new association is to be activated in this procedure with the *chg-assoc* command, the association must contain values for the *lhost*, *rhost*, *lport*, and *rport* parameters.
8. If the *lhost* and *alhost* are specified, the *lhost* parameter value represents the IP address corresponding to one of the network interfaces (A or B) on the IP card while the *alhost* parameter value represents the IP address corresponding to the other network interface of the same IP card.
9. Card's running either *ss7ipgw* or *ipgwi* applications can have only the values *m3ua* or *sua* for the *adapter* parameter.
10. The default value for the *adapter* parameter is *m3ua*, if the card's application is either *ss7ipgw* or *ipgwi*. If the card's application is either *iplim* or *iplimi*, the default value for the *adapter* parameter is *m2pa*.
11. The *m2patset* parameter can be specified only with the *adapter=m2pa* parameter.
12. The *m2patset* parameter value defaults to M2PA timer set 1 (*m2patset=1*) if the *m2patset* parameter is not specified.
13. The *port* parameter can be used in place of the *link* parameter to specify the signaling link assigned to the association.
14. When the *adapter=m2pa* parameter is specified, the RFC M2PA version is assigned to the M2PA association by default. If you wish to assign the Draft 6 M2PA version to this association, perform the "Changing an Association" procedure in this chapter after this procedure is completed to change the M2PA version of this association.

Removing an Association

This procedure is used to remove an association from the database using the `dlt-assoc` command.

The `dlt-assoc` command uses one parameter, `aname`, the name of the association being removed from the database. The association being removed must be in the database.

The `open` parameter must be set to `no` before the association can be removed. Use the `chg-assoc` command to change the value of the `open` parameter.

The association being removed from the database cannot be assigned to an application server. This can be verified with the `rtrv-as` command. If the association is assigned to any application servers, go to the “Removing an Association from an Application Server” procedure on page 3-441 and remove the association from the application servers.

Canceling the RTRV-ASSOC and RTRV-AS Commands

Because the `rtrv-assoc` and `rtrv-as` commands used in this procedure can output information for a long period of time, the `rtrv-assoc` and `rtrv-as` commands can be canceled and the output to the terminal stopped. There are three ways that the `rtrv-assoc` and `rtrv-as` commands can be canceled.

- Press the **F9** function key on the keyboard at the terminal where the `rtrv-assoc` or `rtrv-as` commands were entered.
- Enter the `canc-cmd` without the `trm` parameter at the terminal where the `rtrv-assoc` or `rtrv-as` commands were entered.
- Enter the `canc-cmd:trm=<xx>`, where `<xx>` is the terminal where the `rtrv-assoc` or `rtrv-as` commands were entered, from another terminal other than the terminal where the `rtrv-assoc` or `rtrv-as` commands were entered. To enter the `canc-cmd:trm=<xx>` command, the terminal must allow Security Administration commands to be entered from it and the user must be allowed to enter Security Administration commands. The terminal's permissions can be verified with the `rtrv-secu-trm` command. The user's permissions can be verified with the `rtrv-user` or `rtrv-secu-user` commands.

For more information about the `canc-cmd` command, go to the *Commands Manual*.

Procedure

1. Display the associations in the database using the `rtrv-assoc` command. This is an example of possible output.

```
rlghncxa03w 06-10-28 09:12:36 GMT EAGLE5 36.0.0
```

| ANAME | CARD | | LINK | ADAPTER | LPORT | RPORT | OPEN | ALW |
|----------|------|------|------|---------|-------|-------|------|-----|
| | LOC | PORT | | | | | | |
| swbel132 | 1201 | A | A | M3UA | 1030 | 2345 | YES | YES |
| a2 | 1305 | A | A | SUA | 1030 | 2345 | YES | YES |
| a3 | 1307 | A | A | SUA | 1030 | 2346 | YES | YES |
| assoc1 | 1203 | A | A1 | M2PA | 2048 | 1030 | NO | NO |

2. Display the application servers referencing the association being removed from the database using the `rtrv-as` command with the name of the association being removed in this procedure. For this example, enter this command.

```
rtrv-as:aname=assoc1
```

This is an example of possible output.

```
rlghncxa03w 06-10-28 09:12:36 GMT EAGLE5 36.0.0
```

| AS Name | Mode | Tr ms | Association Names |
|---------|-----------|-------|-------------------|
| as1 | LOADSHARE | 2000 | assoc1 |
| as2 | OVERRIDE | 10 | assoc1 |

```
AS Table is (2 of 250) 1% full
```

If the association is assigned to any application servers, go to the “Removing an Association from an Application Server” procedure on page 3-441 and remove the association from the application servers.

NOTE: If the value of the `open` parameter for the association being removed from the database (shown in step 1) is `no`, skip this step and go to step 4.

3. Change the value of the `open` parameter to `no` by specifying the `chg-assoc` command with the `open=no` parameter. For this example, enter this command.

```
chg-assoc:aname=assoc1:open=no
```

When this command has successfully completed, this message should appear.

```
rlghncxa03w 06-10-28 09:12:36 GMT EAGLE5 36.0.0
CHG-ASSOC: MASP A - COMPLTD;
```

4. Remove the association from the database using the `dlt-assoc` command. For this example, enter this command.

```
dlt-assoc:aname=assoc1
```

When this command has successfully completed, this message should appear.

```
rlghncxa03w 06-10-28 09:12:36 GMT EAGLE5 36.0.0
DLT-ASSOC: MASP A - COMPLTD
```

5. Verify the changes using the `rtrv-assoc` command with the name of the association specified in step 4. For this example, enter this command.

```
rtrv-assoc:aname=assoc1
```

This is an example of possible output.

```
rlghncxa03w 06-10-28 09:12:36 GMT EAGLE5 36.0.0  
IP Appl Sock table is (3 of 4000) 1% full
```

6. Back up the new changes, using the `chg-db:action=backup:dest=fixed` command. These messages should appear; the active Maintenance and Administration Subsystem Processor (MASP) appears first.

```
BACKUP (FIXED) : MASP A - Backup starts on active MASP.  
BACKUP (FIXED) : MASP A - Backup on active MASP to fixed disk complete.  
BACKUP (FIXED) : MASP A - Backup starts on standby MASP.  
BACKUP (FIXED) : MASP A - Backup on standby MASP to fixed disk complete.
```

Flowchart 3-30. Removing an Association

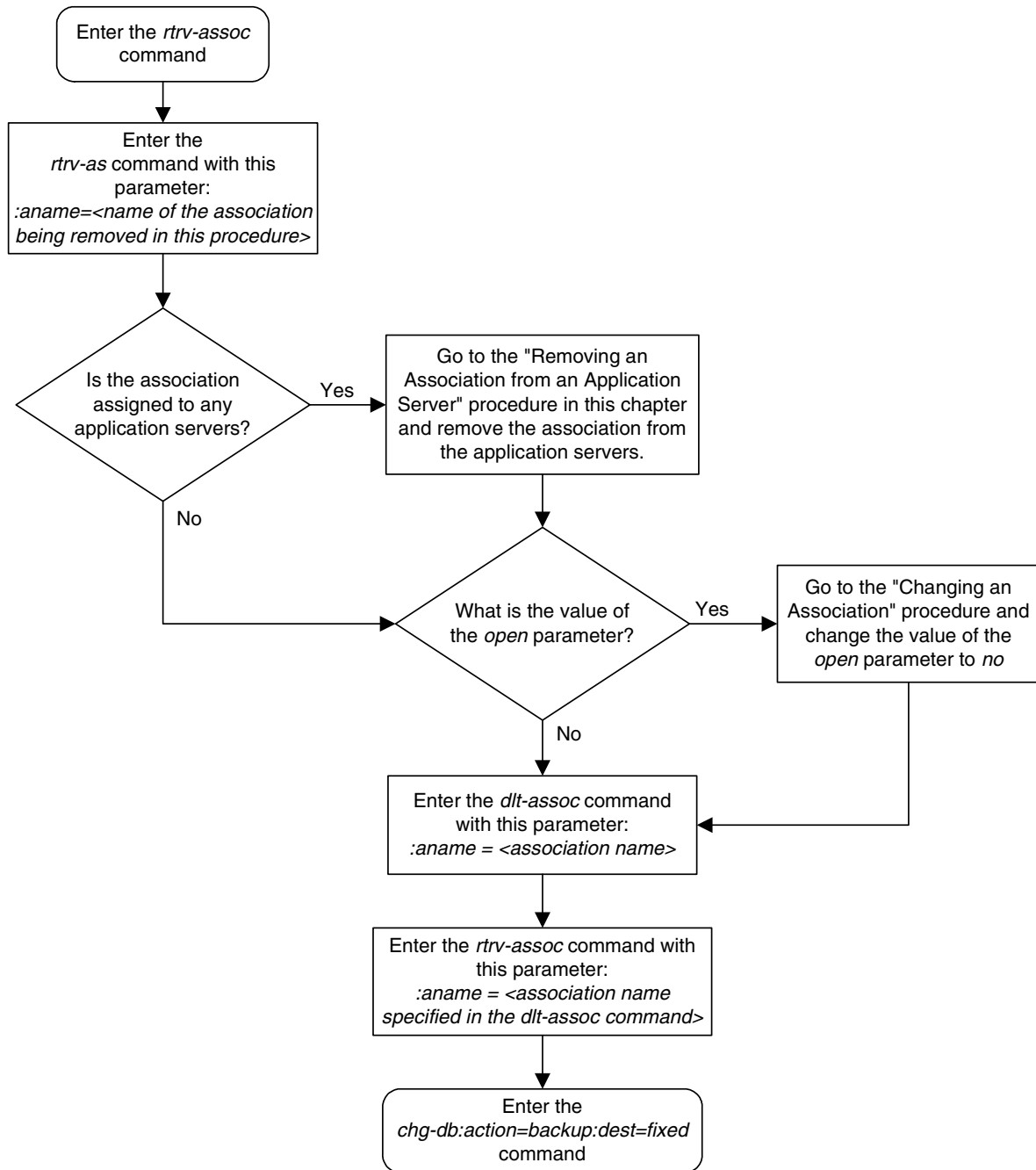

Changing an Association

This procedure is used to change the values of the attributes of the SCTP associations in the database using the **chg-assoc** command.

The **chg-assoc** command uses these parameters:

:aname – The name assigned to the association. Valid association names can contain up to 15 alphanumeric characters where the first character is a letter and the remaining characters are alphanumeric characters. The **aname** parameter value is not case-sensitive.

:lhost – The host name for the local host, **lhost** can be any string of characters starting with a letter and comprising these characters ['a'..'z', 'A'..'Z', '0'..'9', '-', '.']. Hostnames are not case-sensitive and can contain up to 60 characters. The default value of this optional parameter is empty (null string).

:lport – The SCTP port number for the local host.

:rhost – The host name for the remote host, **rhost** can be any string of characters starting with a letter and comprising these characters ['a'..'z', 'A'..'Z', '0'..'9', '-', '.']. Hostnames are not case-sensitive and can contain up to 60 characters. The default value of this optional parameter is empty (null string).

:rport – The SCTP port number for the remote host.

:link – The signaling link on the IP card. If the card's application is **iplim** or **iplimi**, and the card is a dual-slot DCM, the values for the **link** parameter can be only **a** or **b**. If the card's application is **iplim** or **iplimi**, and the card is a single-slot EDCM, the values for the **link** parameter can be **a**, **a1**, **a2**, **a3**, **b**, **b1**, **b2**, or **b3**. If the IP card's application is **ss7ipgw** or **ipgwi**, only **link=a** can be specified.

NOTE: The **port** parameter can be used in place of the **link** parameter to specify the signaling link on the card.

:adapter – The adapter layer for this association, either **m3ua**, **m2pa**, or **sua**.

:open – The connection state for this association. Valid values are **yes** or **no**. When the **open=yes** parameter is specified, the connection manager opens the association if the association is operational. When the **open=no** parameter is specified, the connection manager will not open the association.

:alw – The connection state for this association. Valid values are **yes** or **no**. When the **alw=yes** parameter is specified, the connection manager allows the association to carry SS7 traffic. When the **alw=no** parameter is specified, the connection manager prohibits the association from carrying SS7 traffic.

:rmode – The retransmission policy used when packet loss is detected. The values are **rfc** or **lin**.

- **rfc** – Standard RFC 2960 algorithm in the retransmission delay doubles after each retransmission. The RFC 2960 standard for congestion control is also used.
- **lin** – Tekelec's linear retransmission policy where each retransmission timeout value is the same as the initial transmission timeout and only the slow start algorithm is used for congestion control.

:rmin – The minimum value of the calculated retransmission timeout in milliseconds, from 10 - 1000.

:rmax – The maximum value of the calculated retransmission timeout in milliseconds, from 10 - 1000.

:rtimes – The number of times a data retransmission will occur before closing the association from 3 - 12.

:cwmn – The minimum size in bytes of the association's congestion window and the initial size in bytes of the congestion window, from 1500 - 196608.

The **rmode**, **rmin**, **rmax**, **rtimes**, and **cwmn** parameters are used to configure the SCTP retransmission controls for an association, in addition to other commands. Go to the “Configuring SCTP Retransmission Control for an Association” procedure on page 3-381 to configure the SCTP retransmission controls for an association.

:istrms – The number of inbound streams (1 or 2) advertised by the SCTP layer for the association.

:ostrms – The number of outbound streams (1 or 2) advertised by the SCTP layer for the association.

:m2patset – The M2PA timer set assigned to the association. The **m2patset** parameter can be specified only with the **adatper=m2pa** parameter, or if the association already has the **adapter=m2pa** parameter assigned and the **adapter** parameter value is not being changed. If the **adapter** parameter value is being changed to **m2pa**, and the **m2patset** parameter is not specified, the default value for the **m2patset** parameter (1 - M2PA timer set 1) is assigned to the association. If the **adapter** parameter value for the association is **m2pa**, is not being changed, and the **m2patset** parameter is not specified with the **chg-assoc** command, the **m2patset** parameter value is not changed.

:uaps – The UA parameter set value being assigned to either an M3UA or SUA association.

:ver – The M2PA version assigned to the M2PA association, either the RFC version (**ver=rfc**), or the Draft 6 version (**ver=d6**). The **ver** parameter can be specified only if, when this procedure is completed, the **adapter** parameter value is **m2pa**. If the **adapter** parameter value is being changed to **m2pa**, and the **ver** parameter is not specified, the default M2PA version of RFC is

assigned to the association. To change the **ver** parameter value, the **open** parameter value for the association must be **no**.

:bufsize – The size, in kilobytes, of the buffer used by the association. The values for this parameter are 8 kilobytes to 400 kilobytes. The maximum size of the buffers on the IP cards are shown in Table 3-29.

Table 3-29. SCTP Buffer Limits

| IP Card Application | Card Type | | |
|---------------------|---------------|------------------|--------------|
| | Dual-Slot DCM | Single-Slot EDCM | E5-ENET Card |
| IPLIMx | 400 kB | 1600 kB | 3200 kB |
| IPGWx | N/A | 800 kB | 3200 kB |

The size of the buffers assigned to each association that is assigned to the IP card cannot exceed the maximum buffer size for that card. If the **bufsize** parameter value causes the total buffer size for all the associations on the IP card to exceed the maximum buffer size for that IP card, the **chg-assoc** command will be rejected. The available size of the buffers on the IP card can be verified by entering this command.

```
rtrv-assoc:lhost=<local host name assigned to the association being changed>
```

The **alhost** parameter can also be used with the **rtrv-assoc** command to display the available size of the buffers on the IP card.

The **aname** parameter can be used with the **rtrv-assoc** command to display the available size of the buffers on the IP card and the size of the buffer assigned to the association.

If you wish to increase the buffer size for this association to a value that is greater than available buffer size for the card, the buffer size of the other associations assigned to the card must be decreased.

If the value of the **open** parameter is **yes**, only the value of the **alw** parameter can be changed. To change the values of other parameters, the value of the **open** parameter must be **no**.

To set the **open** parameter value to **yes**, the association specified by the **aname** parameter must contain values for the **lhost**, **lport**, **rhost**, and **rport** parameters. The **lhost** parameter value must have a signaling link assigned to it.

At least one optional parameter is required.

The command input is limited to 150 characters, including the hostnames.

The maximum number of TALI sockets and SCTP association to application server assignments that can be hosted by an IPGWx card (referenced by the `lhost` parameter of the socket and association) is 50. For example, if the IPGWx card contains 12 TALI sockets, the maximum number of SCTP association to application server assignments that the IPGWx card can support is 38. The SCTP association to application server assignments could be one SCTP association assigned to 38 application servers, two SCTP associations assigned to 19 application servers, or any combination of SCTP associations assigned to application servers that add up to 38. The number of TALI sockets can be verified with the `rtrv-appl-sock:lhost=<local host name>` command. The SCTP association to application server assignments can be verified with the `rtrv-assoc:lhost=<local host name>` and `rtrv-as:aname=<association name>` commands.

Table 3-30. Examples of IPGWx Card Provisioning Limits

| Number of Associations hosted by the IPGWx card | Number of Application Servers each Association is Assigned to * | Number of TALI Sockets Hosted by the IPGWx card | Total Association - Application Server Assignments and TALI Sockets maintained by the IPGWx card |
|---|---|---|--|
| 1 | 50 | 0 | 50 |
| 50 | 1 | 0 | 50 |
| 25 | 1 | 25 | 50 |
| 25 | 2 | 0 | 50 |
| 0 | 0 | 50 | 50 |
| 38 | 1 | 12 | 50 |
| 19 | 2 | 12 | 50 |

* The EAGLE 5 ISS can contain a maximum of 250 application servers.

The EAGLE 5 ISS can contain a maximum of 4000 connections (association to application server assignments plus sockets).

For the `iplim` and `iplimi` applications, the IP card can have one association for each signaling link on the card. The dual-slot DCM can contain only two signaling links, resulting in a maximum of two associations on these cards. The single-slot EDCM can contain a maximum of eight signaling links, resulting in a maximum of eight associations for this card.

The B Ethernet interface of the IP card can be used only if the IP card is a single-slot EDCM.

The `adapter` parameter value cannot be changed if the association is assigned to an application server. This can be verified with the `rtrv-as` command. If the association is assigned to any application servers, go to the “Removing an Association from an Application Server” procedure on page 3-441 and remove the association from the application servers.

The value of the **rmin** parameter must be less than or equal to the **rmax** parameter value.

For associations assigned to the **ss7ipgw** or **ipgwi** applications, the value of the **cwmin** parameter must be less than or equal to 16384.

If the card's application is either IPLIM or IPLIMI:

- The **iplim12** parameter value of the signaling link assigned to the association must be **m2pa**. The **adapter** parameter value of the association must match the **iplim12** parameter value.
- The signaling link being assigned to the association must be out of service. This state is shown in the **rept-stat-slk** output with the entries **OOS-MT** in the **PST** field and **Unavail** in the **SST** field.
- If the association is being opened in this procedure with the **chg-assoc** command and the **open=yes** parameter, the signaling link assigned to the association must be in the database and the **iplim12** parameter value of the signaling link assigned to the association must be **m2pa**.

If the card's application is either SS7IPGW or IPGWI, the signaling link being assigned to the association must be in service. This state is shown in the **rept-stat-slk** output with the entries **IS-NR** in the **PST** field and **Avail** in the **SST** field.

Uni-homed endpoints are associations configured with the **lhost** parameter only. The **lhost** parameter value represents an IP address that corresponds to either the A or B network interface of the IP card. Multi-homed endpoints are associations configured with both the **lhost** and **alhost** parameters. The **lhost** parameter value represents an IP address corresponding to one of the network interfaces (A or B) of the IP card while the **alhost** parameter value represents an IP address corresponding to the other network interface of the same IP card.

The **alhost=none** parameter removes the alternate local host from the specified association, which also removes the multi-homed endpoint capability.

Canceling the RTRV-ASSOC and RTRV-AS Commands

Because the **rtrv-assoc** and **rtrv-as** commands used in this procedure can output information for a long period of time, the **rtrv-assoc** and **rtrv-as** commands can be canceled and the output to the terminal stopped. There are three ways that the **rtrv-assoc** and **rtrv-as** commands can be canceled.

- Press the **F9** function key on the keyboard at the terminal where the **rtrv-assoc** or **rtrv-as** commands were entered.
- Enter the **canc-cmd** without the **trm** parameter at the terminal where the **rtrv-assoc** or **rtrv-as** commands were entered.
- Enter the **canc-cmd:trm=<xx>**, where **<xx>** is the terminal where the **rtrv-assoc** or **rtrv-as** commands were entered, from another terminal other than the terminal where the **rtrv-assoc** or **rtrv-as** commands were entered. To enter the **canc-cmd:trm=<xx>** command, the terminal must allow

Security Administration commands to be entered from it and the user must be allowed to enter Security Administration commands. The terminal's permissions can be verified with the `rtrv-secu-trm` command. The user's permissions can be verified with the `rtrv-user` or `rtrv-secu-user` commands.

For more information about the `canc-cmd` command, go to the *Commands Manual*.

Procedure

1. Display the associations in the database using the `rtrv-assoc` command. This is an example of possible output.

```
rlghncxa03w 06-10-28 09:12:36 GMT EAGLE5 36.0.0
```

| ANAME | CARD | | IPLNK | | ADAPTER | LPORT | RPORT | OPEN | ALW |
|---------|------|------|-------|--|---------|-------|-------|------|-----|
| | LOC | PORT | LINK | | | | | | |
| swbel32 | 1201 | A | A | | M3UA | 1030 | 2345 | YES | YES |
| a2 | 1305 | A | A | | SUA | 1030 | 2345 | YES | YES |
| a3 | 1307 | A | A | | SUA | 1030 | 2346 | YES | YES |
| assoc1 | 1201 | A | A | | M3UA | 2000 | 1030 | YES | YES |
| assoc2 | 1205 | A | A | | M3UA | 2048 | 2048 | YES | YES |
| assoc3 | 1205 | A | A | | M3UA | 3000 | 3000 | YES | YES |
| assoc5 | 1205 | A | A | | M3UA | 1500 | 3000 | YES | YES |

NOTE: To change the values of these parameters: `lhost`, `lport`, `rhost`, `rport`, `link`, `adapter`, `rmode`, `rmin`, `rmax`, `rtimes`, `cwmin`, `istrms`, `ostrms`, `ver`, `uaps`, or `bufsize`, the value of the `open` parameter must be `no`. If the values of any of these parameters are being changed and the `open` parameter value for the association being changed is `no`, skip this step and go to step 3.

NOTE: If only the values of the `alw` or `open` parameters are being changed, skip steps 2 through 19, and go to step 20.

2. Change the value of the `open` parameter to `no` by specifying the `chg-assoc` command with the `open=no` parameter. For this example, enter this command.

```
chg-assoc : aname=assoc2 : open=no
```

When this command has successfully completed, this message should appear.

```
rlghncxa03w 06-10-28 09:12:36 GMT EAGLE5 36.0.0
CHG-ASSOC: MASP A - COMPLTD;
```

3. Display the association being changed by entering the `rtrv-assoc` command with the `aname` parameter specified in step 2. For this example, enter this command.

```
rtrv-assoc:aname=assoc2
```

This is an example of the possible output.

```
rlghncxa03w 06-10-28 21:14:37 GMT EAGLE5 36.0.0
ANAME assoc2
  LOC      1205          IPLNK PORT  A          LINK  A
ADAPTER  M3UA          VER          M3UA RFC
LHOST    IPNODE2-1205
ALHOST   ---
RHOST    remotehost1
LPORT    2048          RPORT      2048
ISTRMS   2            OSTRMS     2          BUFSIZE  200
RMODE    LIN          RMIN       120        RMAX     800
RTIMES   10          CWMIN      3000      UAPS     10
OPEN     No           ALW        YES
ASNAMES
as1          as4          as6
```

```
IP Appl Sock/Assoc table is (8 of 4000) 1% full
Assoc Buffer Space Used (800 KB of 800 KB) on LOC = 1205
```

NOTE: If the buffer size of the association is not being changed, skip steps 4 through 6, and go to step 7.

4. If the `bufsize` parameter value causes the total buffer size for all the associations on the IP card to exceed the maximum buffer size for that IP card, the `chg-assoc` command will be rejected. If you wish to increase the buffer size for this association to a value that is greater than available buffer size for the card, the buffer size of the other associations assigned to the card must be decreased. Perform this step and steps 5 and 6.

If the buffers on the other associations assigned to the card do not need to be changed, skip this step and steps 5 and 6, and go to step 7.

Display the associations assigned to the IP card (and its corresponding local host) by entering the `rtrv-assoc` command with the local host name assigned to the association being changed. For this example, enter this command.

```
rtrv-assoc:lhost=IPNODE2-1205
```

This is an example of the possible output.

```
rlghncxa03w 06-10-28 21:14:37 GMT EAGLE5 36.0.0
CARD IPLNK
ANAME      LOC  PORT  LINK ADAPTER LPORT RPORT OPEN ALW
assoc2     1205 A    A    M3UA  2048  2048 YES YES
assoc3     1205 A    A    M3UA  3000  3000 YES YES
assoc5     1205 A    A    M3UA  1500  3000 YES YES
```

```
IP Appl Sock/Assoc table is (8 of 4000) 1% full
Assoc Buffer Space Used (800 KB of 3200 KB) on LOC = 1205
```

5. Display each association shown in step 4 by entering the **rtrv-assoc** command with the name of each association shown in step 4. For this example, enter these commands.

rtrv-assoc:aname=assoc2

This is an example of the possible output.

```

ANAME assoc2
  LOC      1205          IPLNK PORT  A          LINK  A
  ADAPTER  M3UA          VER          M3UA RFC
  LHOST    IPNODE2-1205
  ALHOST   ---
  RHOST    remotehost1
  LPORT    2048          RPORT      2048
  ISTRMS   2             OSTRMS     2             BUFSIZE  200
  RMODE    LIN           RMIN        120            RMAX     800
  RTIMES   10           CWMIN       3000           UAPS     10
  OPEN     YES           ALW         YES

ASNAMES
as1          as4          as6
IP Appl Sock/Assoc table is (8 of 4000) 1% full
Assoc Buffer Space Used (800 KB of 800 KB) on LOC = 1205

```

rtrv-assoc:aname=assoc3

This is an example of the possible output.

```

ANAME assoc3
  LOC      1205          IPLNK PORT  A          LINK  A
  ADAPTER  M3UA          VER          M3UA RFC
  LHOST    IPNODE2-1205
  ALHOST   ---
  RHOST    remotehost3
  LPORT    3000          RPORT      3000
  ISTRMS   2             OSTRMS     2             BUFSIZE  400
  RMODE    LIN           RMIN        120            RMAX     800
  RTIMES   10           CWMIN       3000           UAPS     10
  OPEN     YES           ALW         YES

ASNAMES
as2          as3          as5
IP Appl Sock/Assoc table is (8 of 4000) 1% full
Assoc Buffer Space Used (800 KB of 800 KB) on LOC = 1205

```

rtrv-assoc:aname=assoc5

This is an example of the possible output.

```

ANAME assoc5
  LOC      1205          IPLNK PORT  A          LINK  A
  ADAPTER  M3UA          VER          M3UA RFC
  LHOST    IPNODE2-1205
  ALHOST   ---
  RHOST    remotehost3
  LPORT    1500          RPORT      3000
  ISTRMS   2             OSTRMS     2             BUFSIZE  200
  RMODE    LIN           RMIN        120            RMAX     800
  RTIMES   10           CWMIN       3000           UAPS     10
  OPEN     YES           ALW         YES

ASNAMES
as2          as3          as5

```

```
IP Appl Sock/Assoc table is (8 of 4000) 1% full
Assoc Buffer Space Used (800 KB of 800 KB) on LOC = 1205
```

6. Change the size of the buffers for one or more of the associations displayed in step 5 to allow the buffer of the association displayed in step 3 to be changed. Enter the `chg-assoc` command with the `bufsize` parameter. For this example, enter this command.

```
chg-assoc:aname=assoc3:bufsize=200
```

When this command has successfully completed, this message should appear.

```
rlghncxa03w 06-10-28 09:12:36 GMT EAGLE5 36.0.0
CHG-ASSOC: MASP A - COMPLTD;
```

NOTE: If the local host name assigned to the association is not being changed, skip steps 7 through 12 and go to step 13.

7. Verify that the local host name to be assigned to the association is in the database by using the `rtrv-ip-host` command. The following is an example of the possible output.

```
rlghncxa03w 06-10-28 21:15:37 GMT EAGLE5 36.0.0

LOCAL IPADDR      LOCAL HOST
192.1.1.10        IPNODE1-1201
192.1.1.12        GW105.NC.TEKELEC.COM
192.1.1.14        IPNODE1-1205
192.1.1.20        IPNODE2-1201
192.1.1.22        IPNODE2-1203
192.1.1.24        IPNODE2-1205
192.1.1.30        KC-HLR1
192.1.1.32        KC-HLR2
192.1.1.50        DN-MSC1
192.1.1.52        DN-MSC2

REMOTE IPADDR     REMOTE HOST
150.1.1.5         NCDEPTECONOMIC_DEVELOPMENT.SOUTHEASTERN_COORIDOR_ASHVL.GOV

IP Host table is (11 of 512) 2% full
```

8. Display the IP links in the database by entering the `rtrv-ip-lnk` command. The following is an example of the possible output.

```
rlghncxa03w 06-10-28 21:19:37 GMT EAGLE5 36.0.0
LOC  PORT  IPADDR          SUBMASK          DUPLEX  SPEED  MACTYPE  AUTO  MCAST
1201  A     192.1.1.10     255.255.255.0   ----   ---   DIX      YES  NO
1203  A     192.1.1.12     255.255.255.0   ----   ---   DIX      YES  NO
1205  A     192.1.1.14     255.255.255.0   FULL   100   DIX      NO   NO
```

If the required IP link, one that contains the desired IP address, is not shown in the `rtrv-ip-lnk` output, add the IP link using the “Changing an IP Link” on page 3-135 procedure. After the IP link has been added, assign the IP address of the IP link to the IP host name using the “Adding an IP Host” on page 3-153 procedure. Then go to step 12.

If the required IP link is shown in the `rtrv-ip-lnk` output, assign the IP address of the IP link to the IP host name using the “Adding an IP Host” on page 3-153 procedure. Then go to step 13.

If the required IP host was shown in step 7, the required IP link is shown in the `rtrv-ip-lnk` output in this step. Perform step 9 to verify the application running on the card whose IP address is assigned to the IP host.

9. Display the application running on the IP card shown in step 8 whose IP address is assigned to the IP host using the `rept-stat-card` command specifying the location of the IP card. For this example, enter this command.

`rept-stat-card:loc=1205`

This is an example of the possible output.

```
rlghncxa03w 06-10-27 17:00:36 GMT EAGLE5 36.0.0
CARD  VERSION      TYPE  APPL      PST          SST          AST
1205  114-000-000  DCM   SS7IPGW   IS-NR        Active       -----
ALARM STATUS      = No Alarms.
BPDCM GPL         = 002-102-000
IMT BUS A         = Conn
IMT BUS B         = Conn
SIGNALING LINK STATUS
SLK   PST          LS          CLLI
A     IS-NR        nc001      -----
```

Command Completed.

NOTE: If the card's application is IPLIM or IPLIMI, shown in the APPL column in the `rept-stat-card` output in step 9, or if the local host value being used in this procedure was configured with the "Adding an IP Host" procedure on page 3-153 in step 8, skip steps 10, 11, and 12, and go to step 13.

10. Display the sockets assigned to the local host that will be assigned to the socket being configured in this procedure by entering the `rtrv-appl-sock` command with the `lhost` parameter. For this example, enter this command.

```
rtrv-appl-sock:lhost=IPNODE2-1205
```

This is an example of the possible output.

```
rlghncxa03w 06-10-28 21:14:37 GMT EAGLE5 36.0.0
SNAME sock1
  LINK      A
  LHOST     IPNODE2-1205
  RHOST     remotehost1
  LPORT     1024          RPORT      2048
  SERVER    YES          DCMP5       10
  REXMIT    FIXED       RTT         60
  OPEN      YES          ALW         YES

SNAME sock2
  LINK      A
  LHOST     IPNODE2-1205
  RHOST     remotehost2
  LPORT     2000          RPORT      2000
  SERVER    YES          DCMP5       10
  REXMIT    FIXED       RTT         60
  OPEN      YES          ALW         YES
```

```
IP Appl Sock/Assoc table is (8 of 4000) 1% full
```

11. If the `rtrv-assoc` command was not performed in step 5, display the associations assigned to the local host that will be assigned to the association being configured in this procedure by entering the `rtrv-assoc` command with the `lhost` parameter. For this example, enter this command.

```
rtrv-assoc:lhost=IPNODE2-1205
```

This is an example of the possible output.

```
rlghncxa03w 06-10-28 21:14:37 GMT EAGLE5 36.0.0
          CARD IPLNK
ANAME      LOC  PORT  LINK ADAPTER  LPORT  RPORT  OPEN  ALW
assoc2     1205 A    A    M3UA    2048   2048   YES   YES
assoc3     1205 A    A    M3UA    3000   3000   YES   YES
assoc5     1205 A    A    M3UA    1500   3000   YES   YES
```

```
IP Appl Sock/Assoc table is (8 of 4000) 1% full
Assoc Buffer Space Used (600 KB of 3200 KB) on LOC = 1205
```

12. Display the application servers that the associations shown in step 11 are assigned to by entering `rtrv-as` command with the names of the associations shown in step 11.

NOTE: If the associations assigned to the IP card were displayed in step 5 with the `rtrv-assoc` command and the `aname` parameter, the `rtrv-as` command does need to be performed. The application servers assigned to the associations that are assigned to the IP card are displayed in the `rtrv-assoc` output in step 5.

For this example, enter these commands.

rtrv-as:aname=assoc2

This is an example of the possible output.

```
rlghncxa03w 06-10-28 21:14:37 GMT EAGLE5 36.0.0
AS Name           Mode           Tr ms   Association Names
as1                LOADSHARE     2000   assoc2

as4                LOADSHARE     2000   assoc2

as6                LOADSHARE     2000   assoc2

AS Table is (6 of 250) 1% full
```

rtrv-as:aname=assoc3

This is an example of the possible output.

```
rlghncxa03w 06-10-28 21:14:37 GMT EAGLE5 36.0.0
AS Name           Mode           Tr ms   Association Names
as2                LOADSHARE     2000   assoc3

as3                LOADSHARE     2000   assoc3

as5                LOADSHARE     2000   assoc3

AS Table is (6 of 250) 2% full
```

rtrv-as:aname=assoc5

This is an example of the possible output.

```
rlghncxa03w 06-10-28 21:14:37 GMT EAGLE5 36.0.0
AS Name           Mode           Tr ms   Association Names
as2                LOADSHARE     2000   assoc5

as3                LOADSHARE     2000   assoc5

as5                LOADSHARE     2000   assoc5

AS Table is (6 of 250) 2% full
```

The maximum number of TALI sockets and SCTP association to application server assignments that can be hosted by an IPGWx card (referenced by the `1host` parameter of the socket and association) is 50.

If the number of TALI sockets (shown in step 8) and SCTP association to application server assignments (shown in steps 5 or 12) is less than 50, go to step 11.

If the number of TALI sockets (shown in step 8) and SCTP association to application server assignments (shown in steps 5 or 12) is 50, the local host value cannot be used in this procedure.

Repeat steps 7 and 8 and select another IP link and IP host to use in this procedure or add a new IP link using the “Changing an IP Link” procedure on page 3-135. After the new IP link is added, perform the “Adding an IP Host” procedure on page 3-153 to assign this IP address to a new local host name. After the new local host name as been added, go to step 13.

NOTE: If the `link` parameter value is not being changed, skip this step and go to step 14.

13. Display the signaling link associated with the association being changed using the `rtrv-slk` command and specifying the card location shown in step 7, and the new `link` parameter value of the association for the `link` parameter value. The card location should reference the local host assigned to the association. The `rtrv-ip-lnk` output shows the card location associated with the IP address that is associated with the local host in step 7. If the `rtrv-ip-lnk` command was not executed in step 8, execute it now to get the card location and the IP address. To display the signaling link for this example, enter this command.

```
rtrv-slk:loc=1203:link=a
```

The following is an example of the possible output.

```
rlghncxa03w 06-10-19 21:17:04 GMT EAGLE5 36.0.0
LOC  LINK LSN          SLC TYPE  IPLIML2
1203 A    e5e6a          1  IPLIM   M2PA
```

If the required signaling link is not in the database, add the signaling link using the “Adding an IP Signaling Link” procedure on page 3-84 without activating the signaling link. If the application of the card containing the signaling link is IPLIM or IPLIMI, the `iplim12=m2pa` parameter must be specified for the signaling link and the `adapter=m2pa` parameter value must be specified for the association.

NOTE: If the `adapter` parameter value is not being changed, skip this step and go to step 15.

14. Display the application servers referencing the association being changed using the `rtrv-as` command with the name of the association being changed in this procedure.

NOTE: If the associations assigned to the IP card were displayed in either step 5 with the `rtrv-assoc` command and the `aname` parameter, or step 12 with the `rtrv-as` command, the `rtrv-as` command does need to be performed. The application servers assigned to the associations that are assigned to the IP card are displayed in the `rtrv-assoc` output in step 5 or in the `rtrv-as` output in step 12.

For this example, enter this command.

```
rtrv-as:aname=assoc2
```

This is an example of possible output.

```
rlghncxa03w 06-10-28 21:14:37 GMT EAGLE5 36.0.0
AS Name           Mode           Tr ms   Association Names
as1                LOADSHARE     2000    assoc2

as4                LOADSHARE     2000    assoc2

as6                LOADSHARE     2000    assoc2
```

AS Table is (6 of 250) 1% full

If the association is assigned to any application servers, go to the “Removing an Association from an Application Server” procedure on page 3-441 and remove the association from the application servers.

NOTE: If the `rept-stat-card` command was performed in step 9, skip step 15 and go to step 16.

15. Display the application running on the IP card shown in step 8 using the `rept-stat-card` command specifying the location of the IP card. For this example, enter this command.

```
rept-stat-card:loc=1205
```

This is an example of the possible output.

```
rlghncxa03w 06-10-27 17:00:36 GMT EAGLE5 36.0.0
CARD VERSION      TYPE  APPL  PST      SST      AST
1205 114-000-000  DCM   SS7IPGW IS-NR     Active   -----
ALARM STATUS      = No Alarms.
BPDCM GPL         = 002-102-000
IMT BUS A         = Conn
IMT BUS B         = Conn
SIGNALING LINK STATUS
SLK  PST          LS          CLLI
A    IS-NR        nc001      -----
```

Command Completed.

NOTE: If the card's application is SS7IPGW or IPGWI, shown in the APPL column in the `rept-stat-card` output in steps 9 or 15, skip steps 16, 17, 18, 19, and 20, and go to step 21.

NOTE: If a new signaling link was added in step 13, skip steps 16, 17, 18, and 19, and go to step 20.

16. Display the signaling link that will be assigned to the association by entering the `rtrv-slk` command and specifying the card location and signaling link. For this example, enter this command.

```
rtrv-slk:loc=1203:link=a
```

This is an example of the possible output.

```
rlghncxa03w 06-10-19 21:17:04 GMT EAGLE5 36.0.0
LOC LINK LSN          SLC TYPE  IPLIML2
1203 A    e5e6a        1  IPLIM   M2PA
```

When the IP card's application is either IPLIM or IPLIMI, the `ipliml2` parameter value for the signaling link assigned to the association must be `m2pa`. If the `ipliml2` parameter is not `m2pa`, remove the signaling link using the "Removing an IP Signaling Link" procedure on page 3-113. Add the signaling link back into the database with the `ipliml2=m2pa` parameter, and without activating the signaling link, using the "Adding an IP Signaling Link" procedure on page 3-84.

NOTE: If the "Adding an IP Signaling Link" procedure on page 3-84 was not performed in step 16, skip steps 17, 18, and 19, and go to step 20.

17. Display the status of the signaling link shown in step 16 using the `rept-stat-slk` command specifying the card location and signaling link. For example, enter this command.

```
rept-stat-slk:loc=1203:link=a
```

This is an example of the possible output.

```
rlghncxa03w 06-10-28 21:16:37 GMT EAGLE5 36.0.0
SLK      LSN          CLLI          PST          SST          AST
1203,A   e5e6a          ----- IS-NR          Avail          ----
Command Completed.
```

NOTE: If the primary state (PST) of the signaling link is `OOS-MT` and the secondary state (SST) is `Unavail`, skip steps 18 and 19, and go to step 20.

- 18 Deactivate the signaling link from step 17 using the `dact-slk` command. For example, enter this command.

```
dact-slk:loc=1203:link=a
```

When this command has successfully completed, the following message should appear.

```
rlghncxa03w 06-10-07 11:11:28 GMT EAGLE5 36.0.0
Deactivate Link message sent to card
```

19. Verify the status of the signaling link using the `rept-stat-slk` command. For example, enter this command.

```
rept-stat-slk:loc=1203:link=a
```

This is an example of the possible output.

```
rlghncxa03w 06-10-28 21:16:37 GMT EAGLE5 36.0.0
SLK      LSN      CLLI      PST      SST      AST
1203,A   e5e6a    -----  OOS-MT   Unavail  ----
Command Completed.
```

NOTE: If the current value of the association's `adapter` parameter is `m2pa` and the M2PA timer set assigned to the association will not be changed, skip steps 20 and 21, and go to step 22.

NOTE: If the current value of the association's `adapter` parameter is either `m3ua` or `sua` and will not be changed to `m2pa`, skip step 20 and go to step 21.

20. Verify the values of the M2PA timer set you wish to assign to the association by entering the `rtrv-m2pa-tset` command with the M2PA version (either `ver=rfc` to display the RFC M2PA timer values or `ver=d6` to display the Draft 6 M2PA timer values) of the timer set you wish to assign to the association. If the `ver` parameter is not specified with the `rtrv-m2pa-tset` command, both the RFC and Draft 6 timer values are displayed.

NOTE: If the `m2patset` parameter will not be specified with the `chg-assoc` command, and the `adapter` parameter value is being changed to `m2pa`, the RFC version of M2PA timer set 1 will be assigned to the association.

To display the M2PA Draft 6 timer values, enter this command.

```
rtrv-m2pa-tset:ver=d6
```

This is an example of the possible output.

```
rlghncxa03w 06-10-28 21:16:37 GMT EAGLE5 36.0.0

M2PA Draft 6 Timers (in msec, T16 in microsec)

TSET T1      T2      T3      T4N     T4E     T5      T6      T7      T16     T17     T18
1     6000    ----- 5000    20000   500     5000   4000  1000   100000  150     500
2     7500    ----- 1500    2000    500     9000   1250  300    150000  175     600
3     100000  ----- 2000    3000    500     4000   1500  500    170000  200     800
4     200000  ----- 20000   4000    500     6000   2000  700    480000  225     900
5     250000  ----- 30000   30000   500     100    2250  400    400000  400     8000
6     50000   ----- 50000   60000   500     500    4500  800    300000  300     7000
7     10000   ----- 10000   10000   500     1000   3000  1200   200000  250     1000
8     80000   ----- 1500    15000   500     8000   2750  1100   350000  350     5000
9     27500   ----- 3850    4859    450     5700   3750  1150   250     375     8750
10    90000   ----- 2500    50000   500     7500   5000  1750   440000  450     3000
11    20000   ----- 4500    5500    500     6500   5500  1600   250000  475     4500
12    30000   ----- 7500    7000    500     750    4250  1800   275000  275     3500
13    40000   ----- 35000   9000    500     1250   3500  1900   500     325     9000
14    70000   ----- 45000   11000   500     1500   1750  900    1000    125     6000
15    9000    ----- 25000   40000   500     2500   3250  600    5000    425     5500
16    75000   ----- 15000   25000   500     4500   1600  1400   6000    240     9500
17    350000  ----- 60000   70000   600     10000  6000  2000   500000  500     10000
18    150000  ----- 55000   35000   500     3500   5750  1500   125000  440     750
```

```
19 175000 ----- 12500 45000 500 1100 2600 1300 7000 340 850
20 1000 ----- 1000 1000 400 80 1000 200 100 100 100
```

To display the M2PA RFC values, enter this command.

rtrv-m2pa-tset:ver=rfc

This is an example of the possible output.

```
rlghncxa03w 06-10-28 21:16:37 GMT EAGLE5 36.0.0
```

M2PA RFC Timers (in msec, T16 in microsec)

| TSET | T1 | T2 | T3 | T4N | T4E | T5 | T6 | T7 | T16 | T17 | T18 |
|------|--------|--------|-------|-------|-----|-------|------|------|--------|-----|-------|
| 1 | 6000 | 75000 | 5000 | 20000 | 500 | 5000 | 4000 | 1000 | 100000 | 150 | 500 |
| 2 | 7500 | 8000 | 1500 | 2000 | 500 | 9000 | 1250 | 300 | 150000 | 175 | 600 |
| 3 | 100000 | 10000 | 2000 | 3000 | 500 | 4000 | 1500 | 500 | 170000 | 200 | 800 |
| 4 | 200000 | 6000 | 20000 | 4000 | 500 | 6000 | 2000 | 700 | 480000 | 225 | 900 |
| 5 | 250000 | 140000 | 30000 | 30000 | 500 | 100 | 2250 | 400 | 400000 | 400 | 8000 |
| 6 | 50000 | 100000 | 50000 | 60000 | 500 | 500 | 4500 | 800 | 300000 | 300 | 7000 |
| 7 | 300000 | 20000 | 2000 | 10000 | 500 | 1000 | 3000 | 1200 | 200000 | 250 | 1000 |
| 8 | 80000 | 130000 | 1500 | 15000 | 500 | 8000 | 2750 | 1100 | 350000 | 350 | 5000 |
| 9 | 27500 | 120000 | 3850 | 4859 | 450 | 5700 | 3750 | 1150 | 250 | 375 | 8750 |
| 10 | 90000 | 9000 | 2500 | 50000 | 500 | 7500 | 5000 | 1750 | 440000 | 450 | 3000 |
| 11 | 20000 | 60000 | 4500 | 5500 | 500 | 6500 | 5500 | 1600 | 250000 | 475 | 4500 |
| 12 | 30000 | 50000 | 7500 | 7000 | 500 | 750 | 4250 | 1800 | 275000 | 275 | 3500 |
| 13 | 40000 | 90000 | 35000 | 9000 | 500 | 1250 | 3500 | 1900 | 500 | 325 | 9000 |
| 14 | 70000 | 45000 | 45000 | 11000 | 500 | 1500 | 1750 | 900 | 1000 | 125 | 6000 |
| 15 | 9000 | 30000 | 25000 | 40000 | 500 | 2500 | 3250 | 600 | 5000 | 425 | 5500 |
| 16 | 75000 | 15000 | 15000 | 25000 | 500 | 4500 | 1600 | 1400 | 6000 | 240 | 9500 |
| 17 | 350000 | 150000 | 60000 | 70000 | 600 | 10000 | 6000 | 2000 | 500000 | 500 | 10000 |
| 18 | 150000 | 20000 | 55000 | 35000 | 500 | 3500 | 5750 | 1500 | 125000 | 440 | 750 |
| 19 | 175000 | 12500 | 12500 | 45000 | 500 | 1100 | 2600 | 1300 | 7000 | 340 | 850 |
| 20 | 1000 | 5000 | 1000 | 1000 | 400 | 80 | 1000 | 200 | 100 | 100 | 100 |

If the **ver** parameter is not specified when entering the **rtrv-m2pa-tset** command, both the Draft 6 and RFC values are displayed. This is an example of the possible output.

```
rlghncxa03w 06-10-28 21:16:37 GMT EAGLE5 36.0.0
```

M2PA Draft 6 Timers (in msec, T16 in microsec)

| TSET | T1 | T2 | T3 | T4N | T4E | T5 | T6 | T7 | T16 | T17 | T18 |
|------|--------|-------|-------|-------|-----|-------|------|------|--------|-----|-------|
| 1 | 6000 | ----- | 5000 | 20000 | 500 | 5000 | 4000 | 1000 | 100000 | 150 | 500 |
| 2 | 7500 | ----- | 1500 | 2000 | 500 | 9000 | 1250 | 300 | 150000 | 175 | 600 |
| 3 | 100000 | ----- | 2000 | 3000 | 500 | 4000 | 1500 | 500 | 170000 | 200 | 800 |
| 4 | 200000 | ----- | 20000 | 4000 | 500 | 6000 | 2000 | 700 | 480000 | 225 | 900 |
| 5 | 250000 | ----- | 30000 | 30000 | 500 | 100 | 2250 | 400 | 400000 | 400 | 8000 |
| 6 | 50000 | ----- | 50000 | 60000 | 500 | 500 | 4500 | 800 | 300000 | 300 | 7000 |
| 7 | 10000 | ----- | 10000 | 10000 | 500 | 1000 | 3000 | 1200 | 200000 | 250 | 1000 |
| 8 | 80000 | ----- | 1500 | 15000 | 500 | 8000 | 2750 | 1100 | 350000 | 350 | 5000 |
| 9 | 27500 | ----- | 3850 | 4859 | 450 | 5700 | 3750 | 1150 | 250 | 375 | 8750 |
| 10 | 90000 | ----- | 2500 | 50000 | 500 | 7500 | 5000 | 1750 | 440000 | 450 | 3000 |
| 11 | 20000 | ----- | 4500 | 5500 | 500 | 6500 | 5500 | 1600 | 250000 | 475 | 4500 |
| 12 | 30000 | ----- | 7500 | 7000 | 500 | 750 | 4250 | 1800 | 275000 | 275 | 3500 |
| 13 | 40000 | ----- | 35000 | 9000 | 500 | 1250 | 3500 | 1900 | 500 | 325 | 9000 |
| 14 | 70000 | ----- | 45000 | 11000 | 500 | 1500 | 1750 | 900 | 1000 | 125 | 6000 |
| 15 | 9000 | ----- | 25000 | 40000 | 500 | 2500 | 3250 | 600 | 5000 | 425 | 5500 |
| 16 | 75000 | ----- | 15000 | 25000 | 500 | 4500 | 1600 | 1400 | 6000 | 240 | 9500 |
| 17 | 350000 | ----- | 60000 | 70000 | 600 | 10000 | 6000 | 2000 | 500000 | 500 | 10000 |

IP7 Secure Gateway Configuration Procedures

```

18 150000 ----- 55000 35000 500 3500 5750 1500 125000 440 750
19 175000 ----- 12500 45000 500 1100 2600 1300 7000 340 850
20 1000 ----- 1000 1000 400 80 1000 200 100 100 100

```

M2PA RFC Timers (in msec, T16 in microsec)

| TSET | T1 | T2 | T3 | T4N | T4E | T5 | T6 | T7 | T16 | T17 | T18 |
|------|--------|--------|-------|-------|-----|-------|------|------|--------|-----|-------|
| 1 | 6000 | 75000 | 5000 | 20000 | 500 | 5000 | 4000 | 1000 | 100000 | 150 | 500 |
| 2 | 7500 | 8000 | 1500 | 2000 | 500 | 9000 | 1250 | 300 | 150000 | 175 | 600 |
| 3 | 100000 | 10000 | 2000 | 3000 | 500 | 4000 | 1500 | 500 | 170000 | 200 | 800 |
| 4 | 200000 | 6000 | 20000 | 4000 | 500 | 6000 | 2000 | 700 | 480000 | 225 | 900 |
| 5 | 250000 | 140000 | 30000 | 30000 | 500 | 100 | 2250 | 400 | 400000 | 400 | 8000 |
| 6 | 50000 | 100000 | 50000 | 60000 | 500 | 500 | 4500 | 800 | 300000 | 300 | 7000 |
| 7 | 300000 | 20000 | 2000 | 10000 | 500 | 1000 | 3000 | 1200 | 200000 | 250 | 1000 |
| 8 | 80000 | 130000 | 1500 | 15000 | 500 | 8000 | 2750 | 1100 | 350000 | 350 | 5000 |
| 9 | 27500 | 120000 | 3850 | 4859 | 450 | 5700 | 3750 | 1150 | 250 | 375 | 8750 |
| 10 | 90000 | 9000 | 2500 | 50000 | 500 | 7500 | 5000 | 1750 | 440000 | 450 | 3000 |
| 11 | 20000 | 60000 | 4500 | 5500 | 500 | 6500 | 5500 | 1600 | 250000 | 475 | 4500 |
| 12 | 30000 | 50000 | 7500 | 7000 | 500 | 750 | 4250 | 1800 | 275000 | 275 | 3500 |
| 13 | 40000 | 90000 | 35000 | 9000 | 500 | 1250 | 3500 | 1900 | 500 | 325 | 9000 |
| 14 | 70000 | 45000 | 45000 | 11000 | 500 | 1500 | 1750 | 900 | 1000 | 125 | 6000 |
| 15 | 9000 | 30000 | 25000 | 40000 | 500 | 2500 | 3250 | 600 | 5000 | 425 | 5500 |
| 16 | 75000 | 15000 | 15000 | 25000 | 500 | 4500 | 1600 | 1400 | 6000 | 240 | 9500 |
| 17 | 350000 | 150000 | 60000 | 70000 | 600 | 10000 | 6000 | 2000 | 500000 | 500 | 10000 |
| 18 | 150000 | 20000 | 55000 | 35000 | 500 | 3500 | 5750 | 1500 | 125000 | 440 | 750 |
| 19 | 175000 | 12500 | 12500 | 45000 | 500 | 1100 | 2600 | 1300 | 7000 | 340 | 850 |
| 20 | 1000 | 5000 | 1000 | 1000 | 400 | 80 | 1000 | 200 | 100 | 100 | 100 |

If the M2PA timer set you wish to assign to the association does not contain the desired values, go to the “Changing an M2PA Timer Set” procedure on page 3-389 and changed the desired timer values.



CAUTION: Changing an M2PA timer set may affect the performance of any associations using the timer set being changed.

NOTE: If the current adapter parameter value of the association is either `m3ua` or `sua` and the UA timer set assigned to the association will not be changed, skip step 21 and go to step 22.

NOTE: If the current adapter parameter value of the association is `m2pa` and will not be changed to either `m3ua` or `sua`, skip step 21 and go to step 22.

21. Verify the values of the UA parameter set you wish to assign to the association by entering the `rtrv-uaps` command with the desired parameter set.

NOTE: If the `uaps` parameter will not be specified with the `chg-assoc` command, and the adapter parameter value is being changed to either `m3ua` or `sua`, the UA parameter set 10 will be assigned to the association.

For this example, enter this command.

```
rtrv-uaps:set=3
```

This is an example of possible output.

```

rlghncxa03w 06-10-28 09:12:36 GMT EAGLE5 36.0.0
SET  TIMER      TVALUE  PARM      PVALUE
 3     1           10       1          3
 3     2          3000     2          0

```

| | | | | |
|---|----|-------|----|---|
| 3 | 3 | 10000 | 3 | 1 |
| 3 | 4 | 5000 | 4 | 0 |
| 3 | 5 | 0 | 5 | 0 |
| 3 | 6 | 0 | 6 | 0 |
| 3 | 7 | 0 | 7 | 0 |
| 3 | 8 | 0 | 8 | 0 |
| 3 | 9 | 0 | 9 | 0 |
| 3 | 10 | 0 | 10 | 0 |

TIMER 2: False IP Connection Congestion Timer, max time an association can be congested before failing due to false congestion. SS7IPGW and IPGWI applications enforce 0-30000(ms).

TVALUE : Valid range = 32-bits

TIMER 3: UA Heartbeat Period Timer T(beat), time (ms) between sending of BEAT msgs by NE, SS7IPGW and IPGWI applications enforce 100(ms)-60000(ms).

TVALUE : Valid range = 32-bits

TIMER 4: UA Heartbeat Received Timer T(beat ack), timeout period for response BEAT ACK msgs by NE, SS7IPGW and IPGWI applications enforce 100(ms)-10000(ms).

TVALUE : Valid range = 32-bits

PARAM 1: ASP SNM options. Each bit is used as an enabled/disabled flag for a particular ASP SNM option.

PVALUE : Valid range = 32-bits

| BIT | BIT VALUE |
|--------------------------------------|------------------------|
| 0=Broadcast | 0=Disabled , 1=Enabled |
| 1=Response Method | 0=Disabled , 1=Enabled |
| 2-5=Reserved | |
| 6=Broadcast Congestion Status Change | 0=Disabled , 1=Enabled |
| 7-31=Reserved | |

PARAM 2: ASP/AS Notification options. Each bit is used an enabled/disabled flag for a particular ASP/AS Notification option.

PVALUE : Valid range = 32-bits

| BIT | BIT VALUE |
|------------------------------|------------------------|
| 0=ASP Active Notifications | 0=Disabled , 1=Enabled |
| 1=ASP Inactive Notifications | 0=Disabled , 1=Enabled |
| 2=ASP AS State Query | 0=Disabled , 1=Enabled |
| 3-31=Reserved | |

PARAM 3: UA Serviceability Options. Each bit is used as an enabled/disabled flag for a particular UA serviceability option.

PVALUE : Valid range = 32-bits

| BIT | BIT VALUE |
|-----------------|------------------------|
| 0=UA Heartbeats | 0=Disabled , 1=Enabled |
| 1-31=Reserved | |

If the UA parameter set you wish to assign to the association does not contain the desired values, go to the "Changing a UA Parameter Set" procedure on page 3-486 and changed the desired parameter set values.

CAUTION: Changing a UA parameter set may affect the performance of any associations using the parameter set being changed.



22. Change the association using the **chg-assoc** command. For this example, enter this command.

```
chg-assoc:aname=assoc2:rhost="gw200.nc-tekelec.com":rport=3000
:bufsize=250
```

NOTE: See Flowchart 3-31 on pages 3-379 and 3-380 (Sheets 11 and 12) for the rules that apply to the **chg-assoc** command.

When this command has successfully completed, this message should appear.

```
rlghncxa03w 06-10-28 09:12:36 GMT EAGLE5 36.0.0
CHG-ASSOC: MASP A - COMPLTD;
```

NOTE: If the value of the **open** parameter was not changed in step 2, skip this step and go to step 24.

23. Change the value of the **open** parameter to **yes** by specifying the **chg-assoc** command with the **open=yes** parameter. For this example, enter this command.

```
chg-assoc:aname=assoc2:open=yes
```

When this command has successfully completed, this message should appear.

```
rlghncxa03w 06-10-28 09:12:36 GMT EAGLE5 36.0.0
CHG-ASSOC: MASP A - COMPLTD;
```

24. Verify the changes using the **rtrv-assoc** command specifying the association name specified in steps 22 and 23. For this example, enter this command.

```
rtrv-assoc:aname=assoc2
```

This is an example of possible output.

```
rlghncxa03w 06-10-28 09:12:36 GMT EAGLE5 36.0.0
ANAME assoc2
      LOC      1205          IPLNK PORT  A          LINK  A
ADAPTER M3UA          VER          M3UA RFC
LHOST    IPNODE2-1205
ALHOST   ---
RHOST    gw200.nc-tekelec.com
LPORT    2048          RPORT      3000
ISTRMS   2            OSTRMS     2          BUFSIZE  250
RMODE    LIN          RMIN       120        RMAX     800
RTIMES   10          CWMIN      3000       UAPS     10
OPEN     YES          ALW        YES
ASNAMES
as1          as4          as6
```

```
IP Appl Sock table is (8 of 4000) 1% full
Assoc Buffer Space Used (650 KB of 800 KB) on LOC = 1205
```

NOTE: If the card's application is IPLIM or IPLIMI, skip step 25, and go to step 26.

NOTE: If the "Removing an Association from an Application Server" procedure on page 3-441 in step 14 was not performed, skip steps 25, 26, and 27, and go to step 28.

25. Assign the association changed in step 22 to all applicable application servers by performing one of these procedures:

- “Adding an Existing Association to a New Application Server” procedure on page 3-406
- “Adding an Existing Association to an Existing Application Server” procedure on page 3-429.

After assigning the association to the application servers, skip steps 26 and 27, and go to step 28.

26. Activate the signaling link assigned to the association using the **act-slk** command. For example, enter this command.

```
act-slk:loc=1203:link=a
```

When this command has successfully completed, the following message should appear.

```
rlghncxa03w 06-10-07 11:11:28 GMT EAGLE5 36.0.0
Activate Link message sent to card
```

27. Verify the status of the signaling link using the **rept-stat-slk** command. For example, enter this command.

```
rept-stat-slk:loc=1203:link=a
```

This is an example of the possible output.

```
rlghncxa03w 06-10-28 21:16:37 GMT EAGLE5 36.0.0
SLK      LSN      CLLI      PST      SST      AST
1203,A   e5e6a    -----  IS-NR    Avail    ----
Command Completed.
```

28. Back up the new changes, using the **chg-db:action=backup:dest=fixed** command. These messages should appear; the active Maintenance and Administration Subsystem Processor (MASP) appears first.

```
BACKUP (FIXED) : MASP A - Backup starts on active MASP.
BACKUP (FIXED) : MASP A - Backup on active MASP to fixed disk complete.
BACKUP (FIXED) : MASP A - Backup starts on standby MASP.
BACKUP (FIXED) : MASP A - Backup on standby MASP to fixed disk complete.
```

Flowchart 3-31. Changing an Association (Sheet 1 of 12)

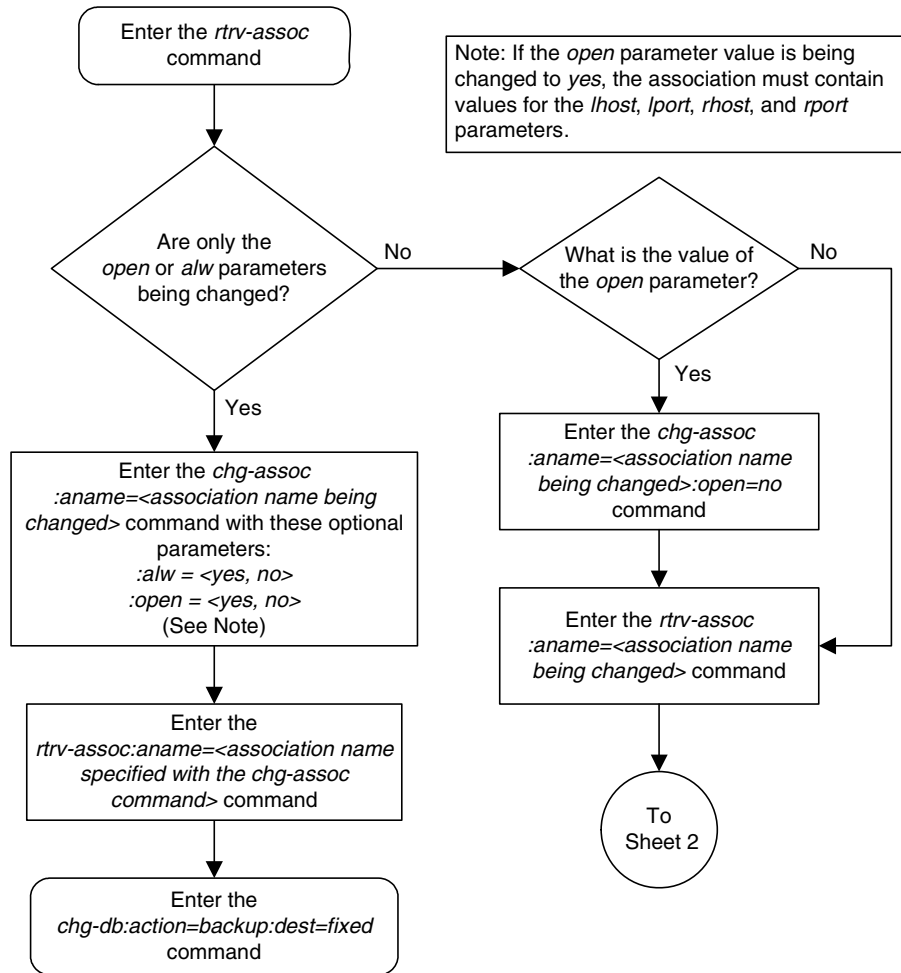

Flowchart 3-31. Changing an Association (Sheet 2 of 12)

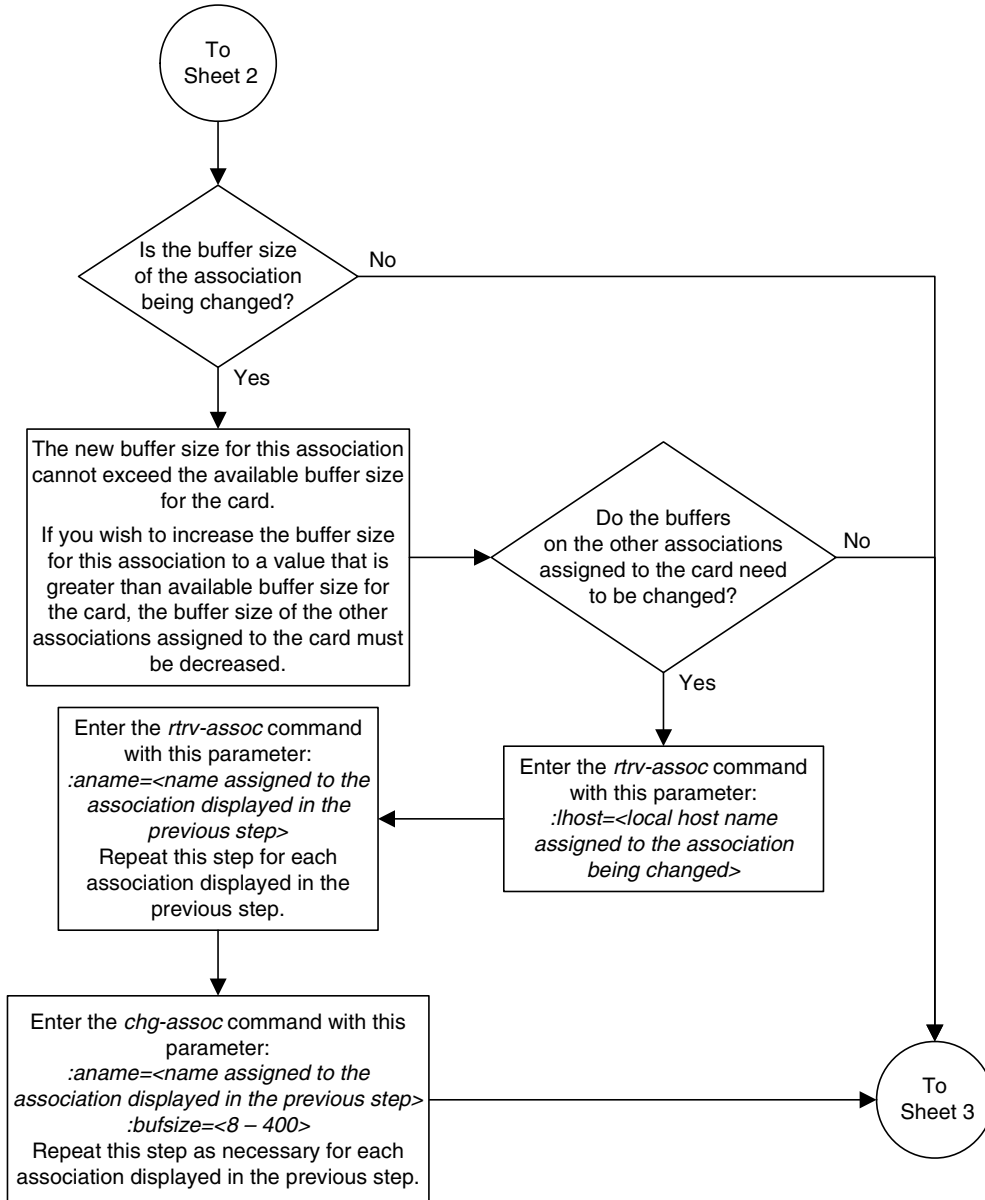

Flowchart 3-31. Changing an Association (Sheet 3 of 12)

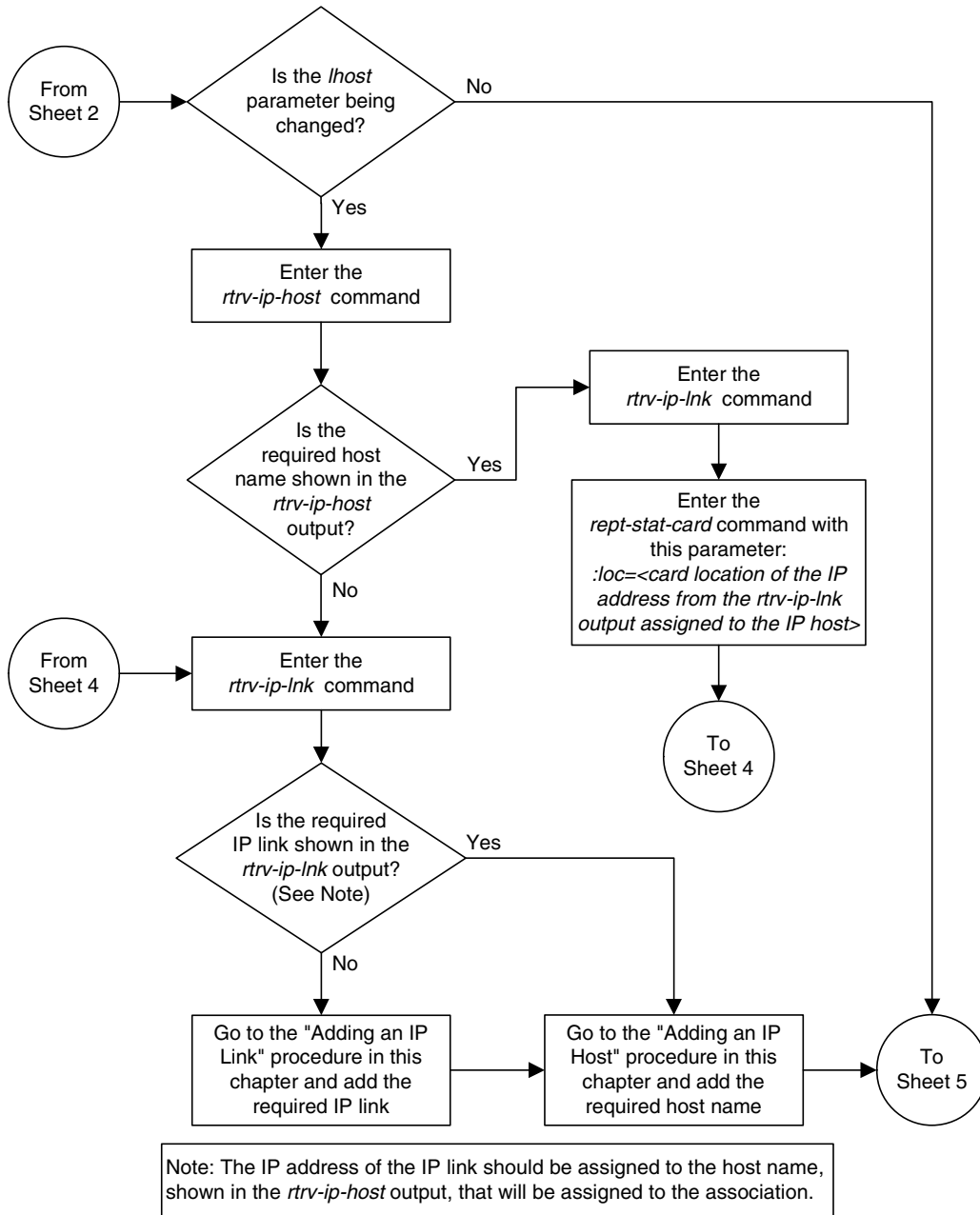

Flowchart 3-31. Changing an Association (Sheet 4 of 12)

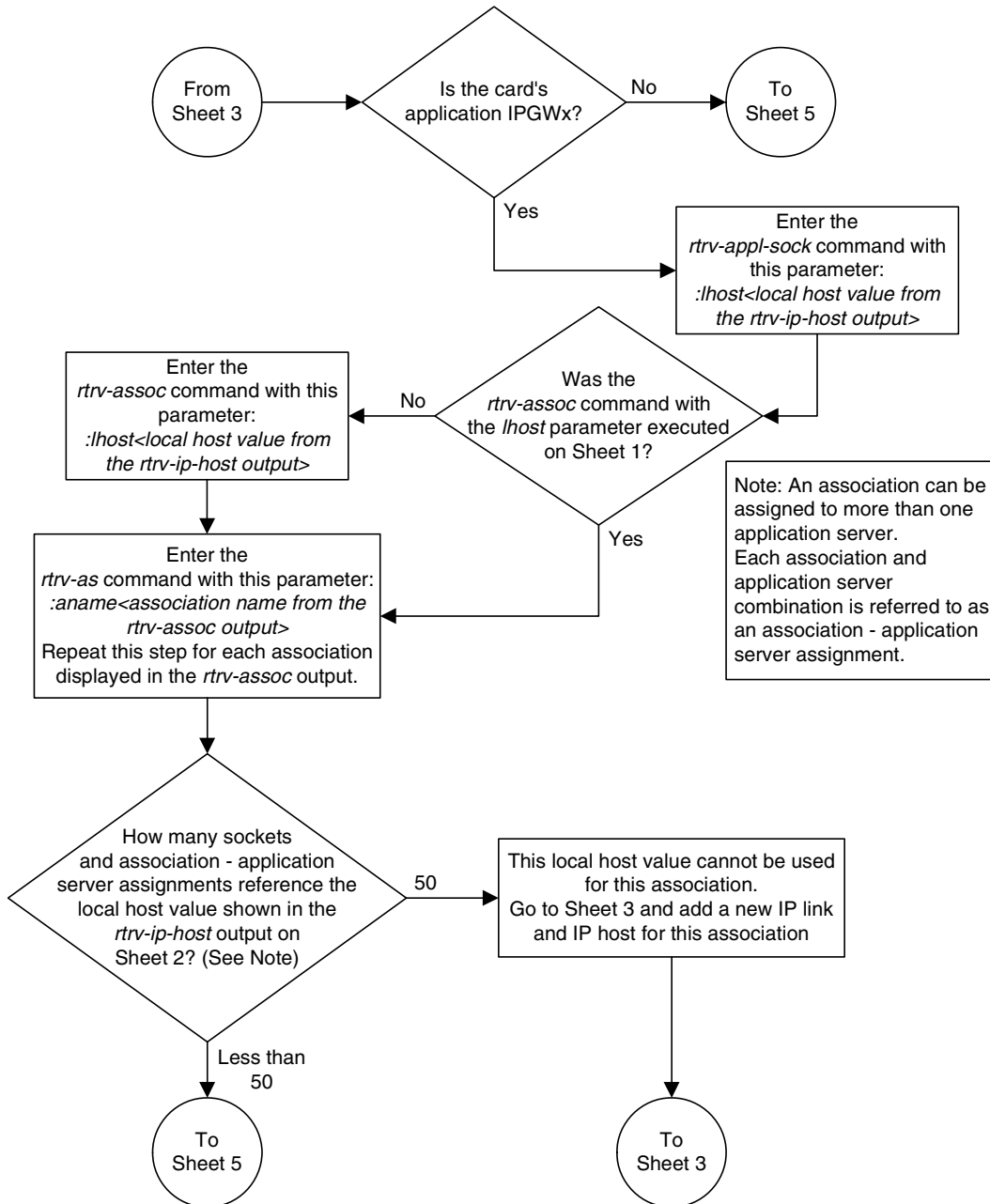

Flowchart 3-31. Changing an Association (Sheet 5 of 12)

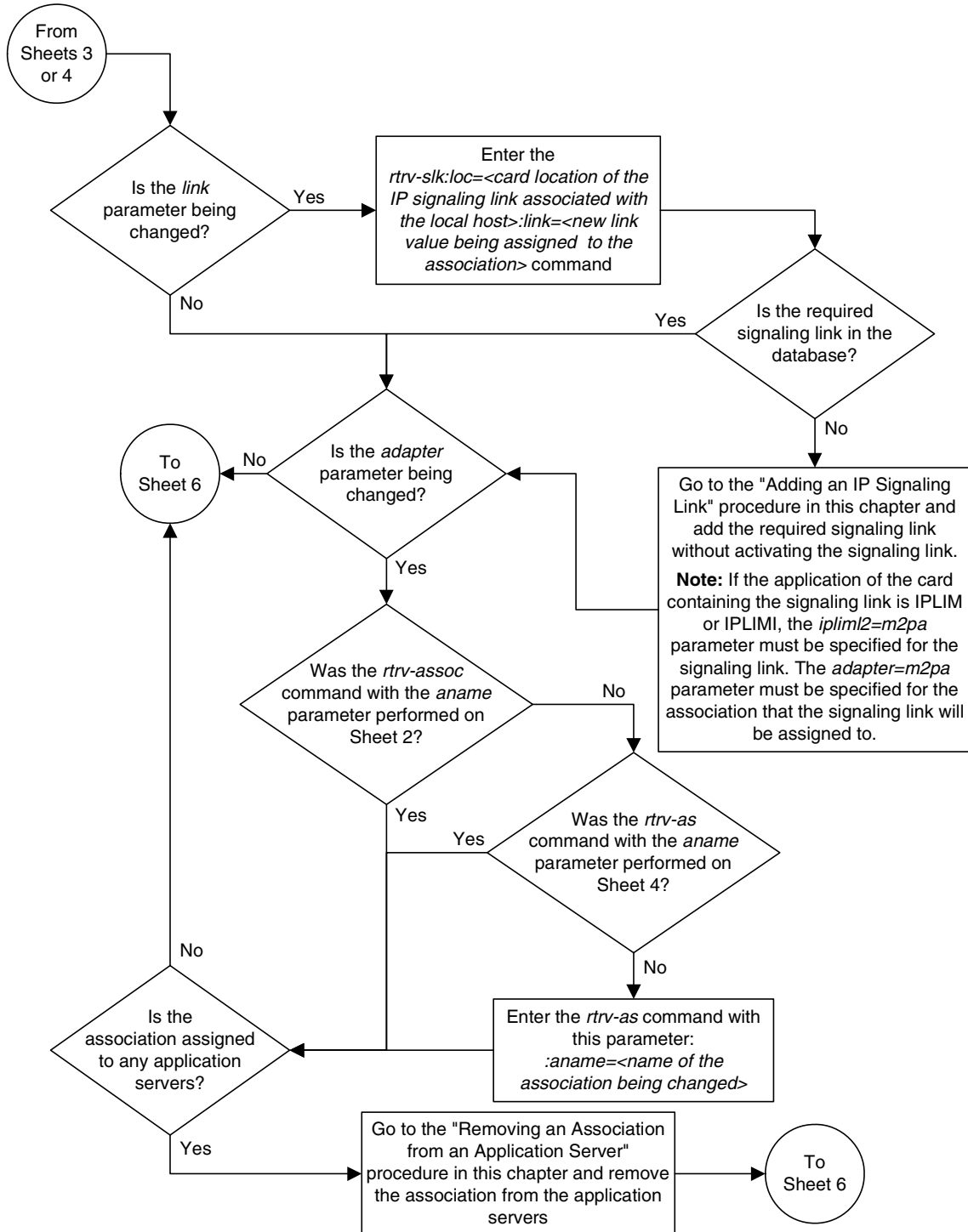

Flowchart 3-31. Changing an Association (Sheet 6 of 12)

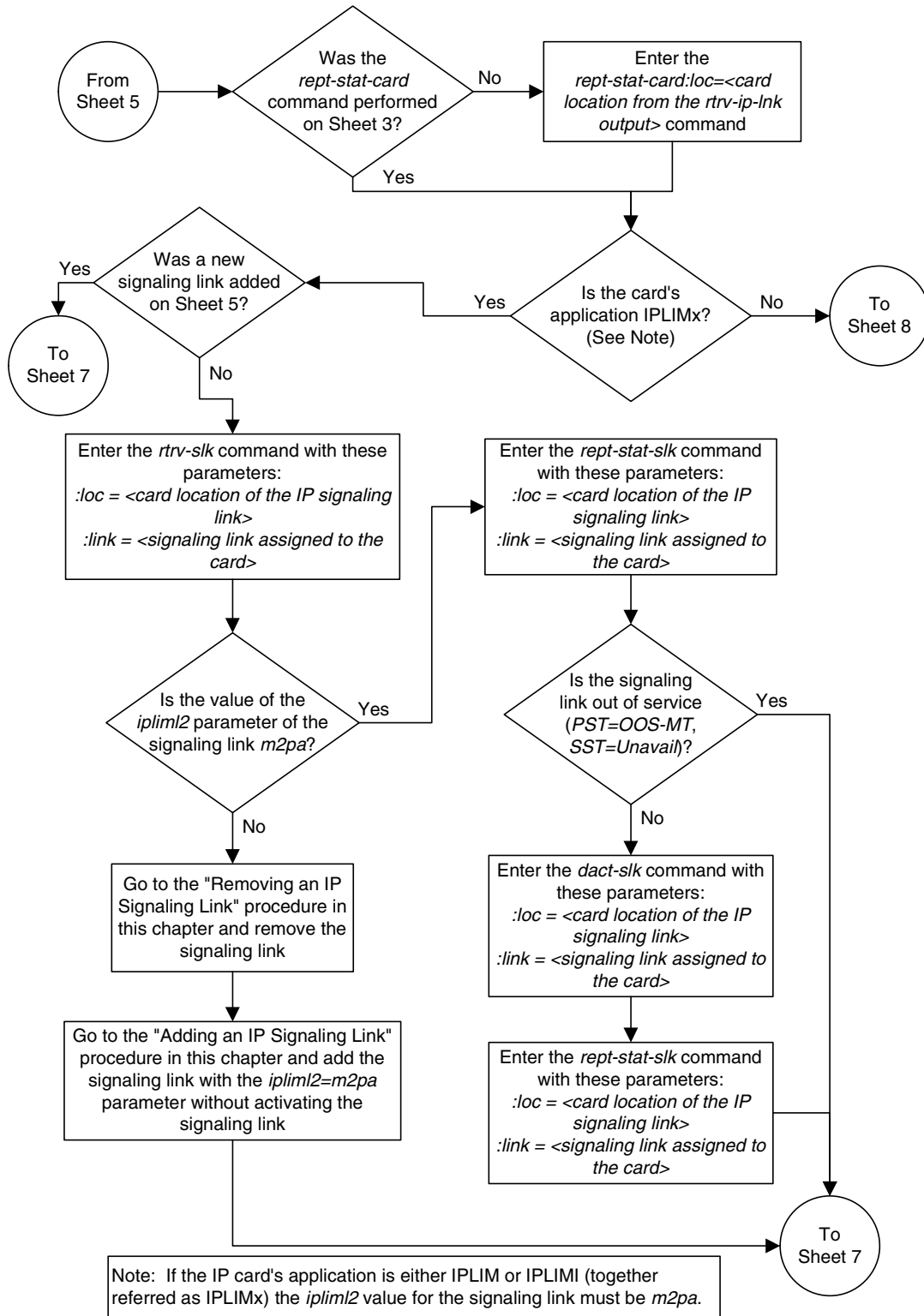

Flowchart 3-31. Changing an Association (Sheet 7 of 12)

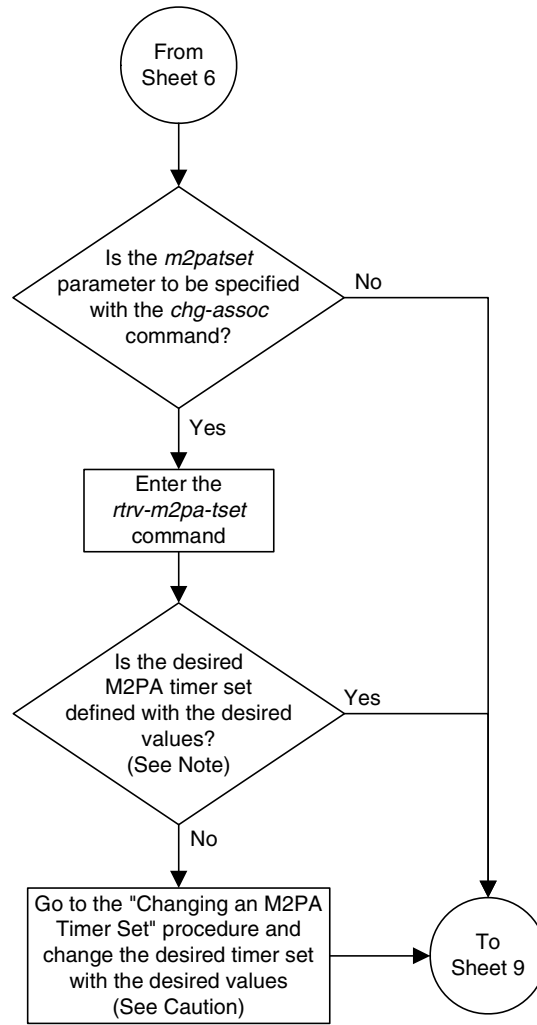

Note: If the *m2patset* parameter will not be specified with the *chg-assoc* command, and the *adapter* parameter value is being changed to *m2pa*, the M2PA timer set 1 will be assigned to the association.

Caution: Changing an M2PA timer set may affect the performance of any associations using the timer set being changed.

Flowchart 3-31. Changing an Association (Sheet 8 of 12)

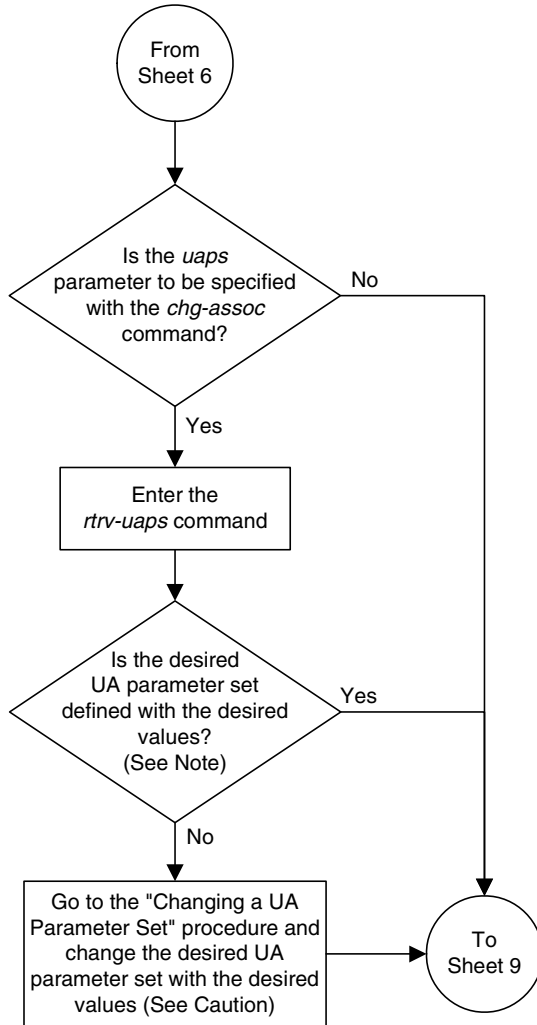

Note: If the *uaps* parameter will not be specified with the *chg-assoc* command, and the *adapter* parameter value is being changed to either *m3ua* or *sua*, the UA parameter set 10 will be assigned to the association.

Caution: Changing an UA parameter set may affect the performance of any associations using the UA parameter set being changed.

Flowchart 3-31. Changing an Association (Sheet 9 of 12)

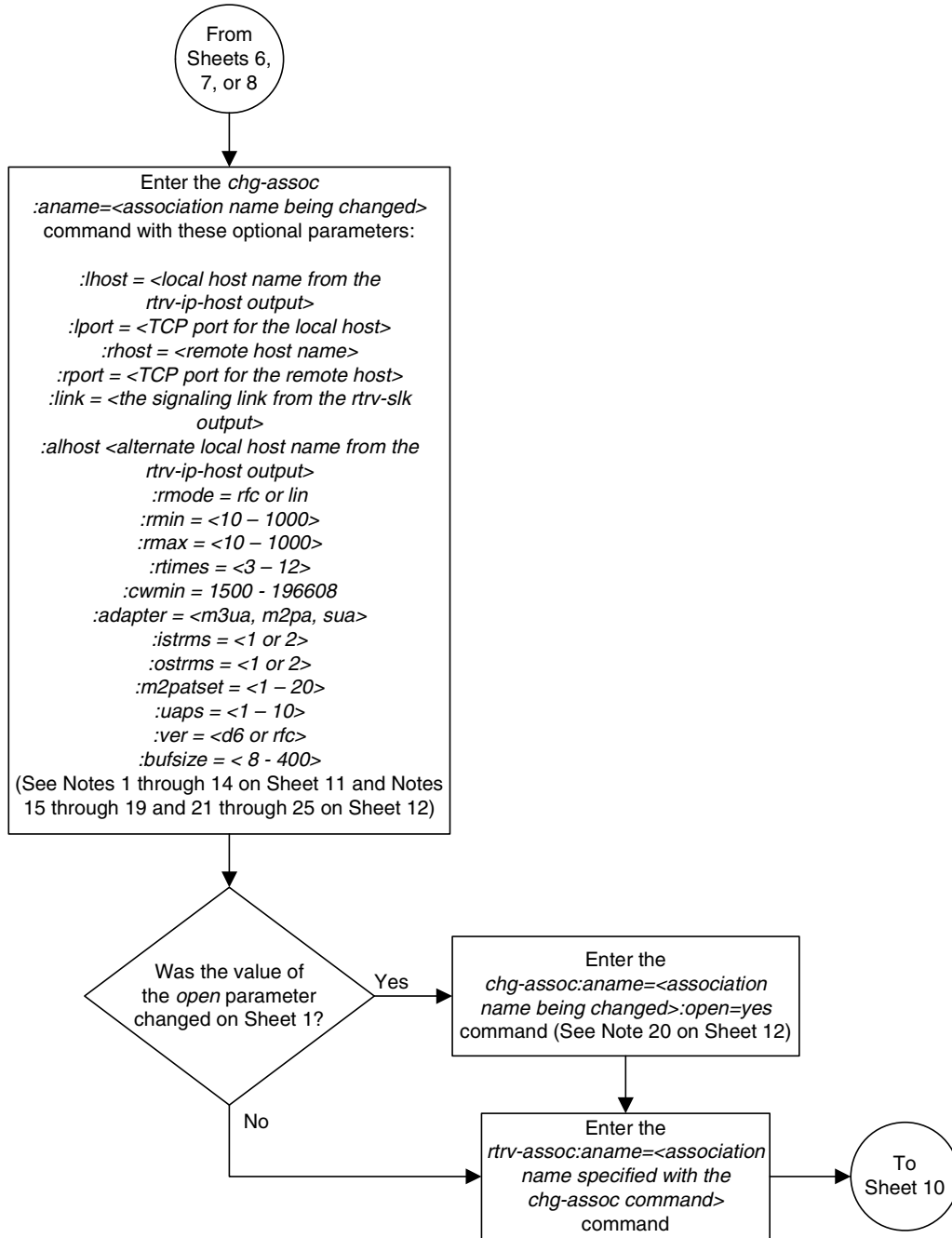

Flowchart 3-31. Changing an Association (Sheet 10 of 12)

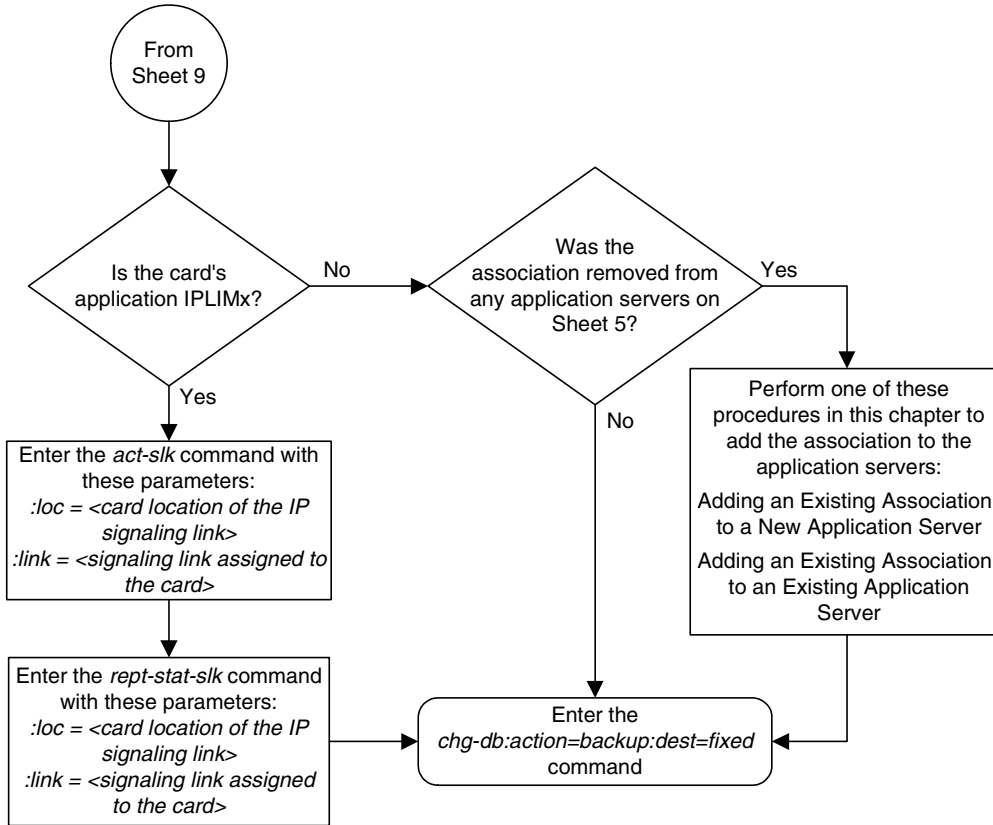

Flowchart 3-31. Changing an Association (Sheet 11 of 12)

Notes:

1. If any optional parameters are not specified with the *chg-assoc* command, those values are not changed.
2. If the card containing the signaling link is a DCM, the B Ethernet interface cannot be used. Single-slot EDCMs or E5-ENET cards can use the B Ethernet interface.
3. The sum of the number of sockets and association – application server assignments on a card running either the *ss7ipgw* or *ipgwi* applications cannot exceed 50.
4. The EAGLE 5 ISS can contain a maximum of 4000 connections (associations plus sockets).
5. Cards running either the *iplim* or *iplimi* applications can have only one connection for each signaling link and a maximum of two connections for each card, if the card is a dual-slot DCM. If the card is a single-slot EDCM, the card may contain a maximum of eight connections. If the card is an E5-ENET card, the card may contain a maximum of 16 connections.
6. The value of the *lhost* and *rhost* parameters is a text string of up to 60 characters, with the first character being a letter. The command input is limited to 150 characters, including the hostnames.
7. If the card's application is either *iplim* or *iplimi*, the *adapter* parameter value for the association must be *m2pa* and the *ipliml2=m2pa* parameter must be assigned to the signaling link on the *iplim* or *iplimi* card.
8. Specifying the *lhost* parameter only creates a uni-homed endpoint. The network portion of the endpoint's IP address must be the same as the network portion of the IP address assigned to either the A or B network interface of the IP card.
9. Specifying the *lhost* and *alhost* parameters creates a multi-homed endpoint. The network portion of the IP address associated with the *lhost* parameter must be the same as the network portion of the IP address assigned to one of the network interfaces (A or B) of the IP card, and the network portion of the IP address associated with the *alhost* parameter must be the same as the network portion of the IP address assigned to the other network interface on the IP card.
10. The *alhost=none* parameter removes the alternate local host from the specified association, which also removes the multi-homed endpoint capability.
11. If the value of the *open* parameter is *yes*, only the value of the *alw* parameter can be changed. To change the values of other parameters, the value of the *open* parameter must be *no*.
12. The value of the *rmin* parameter must be less than or equal to the *rmax* parameter value.
13. For associations assigned to the *ss7ipgw* or *ipgwi* applications, the value of the *cwmin* parameter must be less than or equal to 16384.
14. Cards running either *ss7ipgw* or *ipgwi* applications can have only the values *m3ua* or *sua* for the *adapter* parameter.

Flowchart 3-31. Changing an Association (Sheet 12 of 12)

Notes (Continued):

15. The *m2patset* parameter can be specified only with the *adapter=m2pa* parameter, or if the current *adapter* parameter value for the association is *m2pa*.
16. If the *mp2atset* parameter is not specified with the *chg-assoc* command, and the *adapter* parameter value is being changed to *m2pa*, the *m2patset* parameter value defaults to M2PA timer set 1 (*m2patset=1*).
17. The *uaps* parameter can be specified only with the *adapter=m3ua* or *adapter=sua* parameters, or if the current *adapter* parameter value for the association is either *m3ua* or *sua*.
18. If the *uaps* parameter is not specified with the *chg-assoc* command, and the *adapter* parameter value is being changed to either *m3ua* or *sua*, the *uaps* parameter value defaults to UA parameter set 10 (*uaps=10*).
19. The *port* parameter can be used in place of the *link* parameter to specify the signaling link assigned to the association.
20. If the *open* parameter value is being changed to *yes*, the association must contain values for the *lhost*, *lport*, *rhost*, and *rport* parameters. The *lhost* parameter value must have a signaling link assigned to it.
21. The *ver* parameter can be specified only if after the *chg-assoc* command is performed, the *adapter* parameter value is *m2pa*.
22. The M2PA version of the association determines the version of the M2PA timer set that is assigned to the association. For example, if M2PA timer set 3 is assigned to the M2PA association, and the association is an RFC M2PA association, the RFC version of M2PA timer set 3 is used with the association. If M2PA timer set 7 is assigned to the M2PA association, and the association is a Draft 6 M2PA association, the Draft 6 version of M2PA timer set 7 is used with the association.
23. If the *ver* parameter is not specified with the *chg-assoc* command, and the association's *adapter* parameter value is not changing, then the M2PA version of the association is not changed.
24. If the *adapter* parameter value of the association is changed to *m2pa* in this procedure and the *ver* parameter is not specified, the version of the association will be RFC. To make this association a M2PA Draft 6 association, the *ver=d6* parameter must be specified for this association.
25. The new buffer size for this association cannot exceed the available buffer size for the card. If you wish to increase the buffer size for this association to a value that is greater than available buffer size for the card, the buffer size of the other associations assigned to the card must be decreased.

Configuring SCTP Retransmission Control for an Association

This procedure is used to gather the information required to configure the retransmission parameters for associations. If any assistance is needed to configure the retransmission parameters for associations, contact the Customer Care Center. Refer to “Customer Care Center” on page 1-9 for the contact information.

The retransmission parameters are configured using the **rmode**, **rmin**, **rmax**, **rtimes**, and **cwmin** parameters of the **chg-assoc** command.

:rmode – The retransmission mode used when packet loss is detected. The values are **rfc** or **lin**.

- **rfc** – Standard RFC 2960 algorithm in the retransmission delay doubles after each retransmission. The RFC 2960 standard for congestion control is also used.
- **lin** – Tekelec's linear retransmission mode where each retransmission timeout value is the same as the initial transmission timeout and only the slow start algorithm is used for congestion control.

:rmin – The minimum value of the calculated retransmission timeout in milliseconds.

:rmax – The maximum value of the calculated retransmission timeout in milliseconds.

NOTE: The **rmin** and **rmax** parameter values form a range of retransmission values. The value of the **rmin** parameter must be less than or equal to the **rmax** parameter value.

:rtimes – The number of times a data retransmission occurs before closing the association.

:cwmin – The minimum size in bytes of the association's congestion window and the initial size in bytes of the congestion window.

For associations assigned to the **ss7ipgw** or **ipgwi** applications, the value of the **cwmin** parameter must be less than or equal to 16384.

The “Changing an Association” procedure on page 3-348 is used to change the values of these parameters. In addition to using the “Changing an Association” procedure, these pass commands are also used in this procedure.

- **ping** – tests for the presence of hosts on the network.
- **assocrtt** – displays the SCTP round trip times for a specified association. Minimum, maximum, and average times are kept for each open association. The Retransmission Mode (RFC or LIN) and the configured Minimum and Maximum Retransmission Timeout limits are also displayed.
- **sctp** – provides a summary list of all SCTP instances.

- **sctp -a <association name>** – displays the measurements and information for a specific association.

For more information on the **pass** commands, see the *Commands Manual*.

The **chg-assoc** command contains other optional parameters that can be used to configure an association. These parameters are not shown here because they are not necessary for configuring the SCTP retransmission parameters. These parameters are explained in more detail in the “Changing an Association” procedure on page 3-348, or in the **chg-assoc** command description in the *Commands Manual*.

Canceling the **RTRV-ASSOC** Command

Because the **rtrv-assoc** command used in this procedure can output information for a long period of time, the **rtrv-assoc** command can be canceled and the output to the terminal stopped. There are three ways that the **rtrv-assoc** command can be canceled.

- Press the **F9** function key on the keyboard at the terminal where the **rtrv-assoc** command was entered.
- Enter the **canc-cmd** without the **trm** parameter at the terminal where the **rtrv-assoc** command was entered.
- Enter the **canc-cmd:trm=<xx>**, where **<xx>** is the terminal where the **rtrv-assoc** command was entered, from another terminal other than the terminal where the **rtrv-assoc** command was entered. To enter the **canc-cmd:trm=<xx>** command, the terminal must allow Security Administration commands to be entered from it and the user must be allowed to enter Security Administration commands. The terminal's permissions can be verified with the **rtrv-secu-trm** command. The user's permissions can be verified with the **rtrv-user** or **rtrv-secu-user** commands.

For more information about the **canc-cmd** command, go to the *Commands Manual*.

Procedure

1. Display the associations in the database using the **rtrv-assoc** command. This is an example of possible output.

```
rlghncxa03w 06-10-28 09:12:36 GMT EAGLE5 36.0.0

          CARD IPLNK
ANAME      LOC  PORT  LINK ADAPTER LPORT RPORT OPEN ALW
swbel32    1201 A     A   M3UA   1030  2345  YES  YES
a2         1305 A     A   SUA    1030  2345  YES  YES
a3         1307 A     A   SUA    1030  2346  YES  YES
assoc1     1201 A     A   M3UA   2000  1030  YES  YES
```

2. Display the IP address assigned to the IPLINK assigned to the association being changed in this procedure by entering the **rtrv-ip-lnk** command with the card location and IPLINK port shown in step 1.

For this example, enter this command.

```
rtrv-ip-lnk:loc=1201:port=a
```

The following is an example of the possible output.

```
rlghncxa03w 06-10-28 21:19:37 GMT EAGLE5 36.0.0
LOC  PORT IPADDR          SUBMASK          DUPLEX  SPEED  MACTYPE AUTO MCAST
1201 A   192.1.1.30          255.255.255.0    ----   ---   DIX     YES  NO
```

3. Display the local host assigned to the IP address displayed in step 2 using the **rtrv-ip-host** command with the IP address shown in step 2. For this example, enter this command.

```
rtrv-ip-host:ipaddr=192.1.1.30
```

The following is an example of the possible output

```
rlghncxa03w 06-10-28 21:15:37 GMT EAGLE5 36.0.0

LOCAL IPADDR  LOCAL HOST
192.1.1.30    GW100.NC.TEKELEC.COM

IP Host table is (11 of 512) 2% full
```

4. Enter the **ping** pass command specifying the card location of the local host, shown in step 3, and the name of the remote host assigned to the association being changed, shown in step 1. This command is entered several times to obtain the average round trip time. For this example, enter this command.

```
pass:loc=1201:cmd="ping gw100.nc.tekelec.com"
```

The following is an example of the possible output

```
rlghncxa03w 06-10-28 21:15:37 GMT EAGLE5 36.0.0
PASS: Command sent to card

rlghncxa03w 06-10-28 21:15:37 GMT EAGLE5 36.0.0
PING command in progress
```

```

rlghncxa03w 06-10-28 21:15:37 GMT EAGLE5 36.0.0
PING GW100.NC.TEKELEC.COM (192.1.1.30): 56 data bytes
64 bytes from tekral.nc.tekelec.com (192.1.1.30): icmp_seq=0. time=5. ms
64 bytes from tekral.nc.tekelec.com (192.1.1.30): icmp_seq=1. time=9. ms
64 bytes from tekral.nc.tekelec.com (192.1.1.30): icmp_seq=2. time=14. ms
----tekral PING Statistics----
3 packets transmitted, 3 packets received, 0% packet loss
round-trip (ms)  min/avg/max = 5/9/14

```

PING command complete

NOTE: If the SCTP retransmission parameters are not to be changed, do not perform steps 5 through 9. This procedure is finished.

5. Go to the "Changing an Association" procedure on page 3-348 and change the retransmission parameters of the association based on the results of pinging the remote host.

6. Enter the **assocrtt** pass command to display the round trip time data collected after an association is established when an SCTP INIT message is sent and an acknowledgement is received.

The **assocrtt** command is entered with the card location from step 4 (the card location assigned to the association being changed), and the name of the association being changed. This association must contain the local host name used in step 2. For this example, enter this command.

```
pass:loc=1201:cmd="assocrtt assoc1"
```

The following is an example of the possible output

```

rlghncxa03w 06-10-28 21:15:37 GMT EAGLE5 36.0.0
PASS: Command sent to card

rlghncxa03w 06-10-28 21:15:37 GMT EAGLE5 36.0.0

ASSOCRTT: Association round-trip time report (in milliseconds)

Retransmission Configuration
  Retransmission Mode           : LIN
  Minimum RTO                   : 120
  Maximum RTO                   : 800

Traffic Round-Trip Times

  Minimum round-trip time       : 5
  Maximum round-trip time       : 120
  Weighted Average round-trip time : 10
  Last recorded round-trip time  : 10

Measured Congested Traffic Round-Trip Times

  Minimum round-trip time       : 0
  Maximum round-trip time       : 0
  Weighted Average round-trip time : 0
  Last recorded round-trip time  : 0
;
rlghncxa03w 06-10-28 21:15:37 GMT EAGLE5 36.0.0
ASSOCRTT command complete

```

7. Enter the `sctp -a <association name>` pass command to determine if retransmissions have occurred. The association name is the association name specified in step 6. Specify the card location used in step 6. For this example, enter this command.

`pass:loc=1201:cmd="sctp -a assoc1"`

The following is an example of the possible output

```

rlghncxa03w 06-10-28 21:15:37 GMT EAGLE5 36.0.0

Aname          Local          Local Remote          Remote
                IP Address      Port  Address          Port
Assoc1         192.168.110.12 2222  192.168.112.4   5555
                192.168.112.12

Configuration                                State
Retransmission Mode = LIN                    State = OPEN
Min. Retransmission Timeout = 10             ULP association id = 18
Max. Retransmission Timeout = 800           Number of nets = 2
Max. Number of Retries = 10                  Inbound Streams = 1
Min. Congestion Window = 3000                Outbound Streams = 2
Inbound Streams = 2
Outbound Streams = 2

Nets Data

IP Address  192.168.112.4    State  Reachable
Port        7777              Primary YES
MTU         1500              cwnd   16384
ssthresh    16384            RTO    120

IP Address  192.168.113.5    State  Reachable
Port        7777              Primary NO
MTU         1500              cwnd   16384
ssthresh    16384            RTO    120

Last Net Sent To = 192.168.112.4
Last Net Rcvd From = 192.168.112.4
Over All Error Count = 0
Peers Rwnd = 13880
My Rwnd = 16384
Max Window = 16384
Initial Seq Number = 24130
Next Sending Seq Number = 124686
Last Acked Seq Number = 124669
Maximum Outbound Char Count = 16384
Current Outbound Char Count = 2112
Number Unsent Char Count = 0
Outbound Data Chunk Count = 16
Number Unsent = 0
Number To Retransmit = 0

ip datagrams rcvd = 155402
ip datagrams with data chunks rcvd = 120844
data chunks rcvd = 367908
data chunks read = 367900
dup tsns rcvd = 8
sacks rcvd = 38734
gap ack blocks rcvd = 3
heartbeat requests rcvd = 135
heartbeat acks rcvd = 52

```

```
heartbeat requests sent = 52
  ip datagrams sent = 129254
ip datagrams with data chunks sent = 73084
  data chunks sent = 396330
  retransmit data chunks sent = 135
    sacks sent = 64872
    send failed = 0
  retransmit timer count = 0
  consecutive retransmit timeouts = 0
RTT between RMIN and RMAX inclusive = 6
  RTT greater than RMAX = 0
  fast retransmit count = 135
  recv timer count = 0
  heartbeat timer count = 244
  none left tosend = 0
  none left rwnd gate = 5
  none left cwnd gate = 8
```

SCTP command complete

NOTE: The **Weighted Average round-trip time** shown in the `assocrtt` pass command output in step 6, and the data retransmission counts shown in the `sctp -a` pass command output in step 7 are used as a guide to determine the appropriate values for the `rmode`, `rmin`, `rmax`, and `rtimes` parameters. If the retransmission parameters do not have to be adjusted, do not perform this step. This procedure is finished.

8. Go to the "Changing an Association" procedure on page 3-348 and change the retransmission parameters of the association based on the results of the outputs of steps 6 and 7.
-

Flowchart 3-32. Configuring an Association for SCTP Retransmission Control (Sheet 1 of 2)

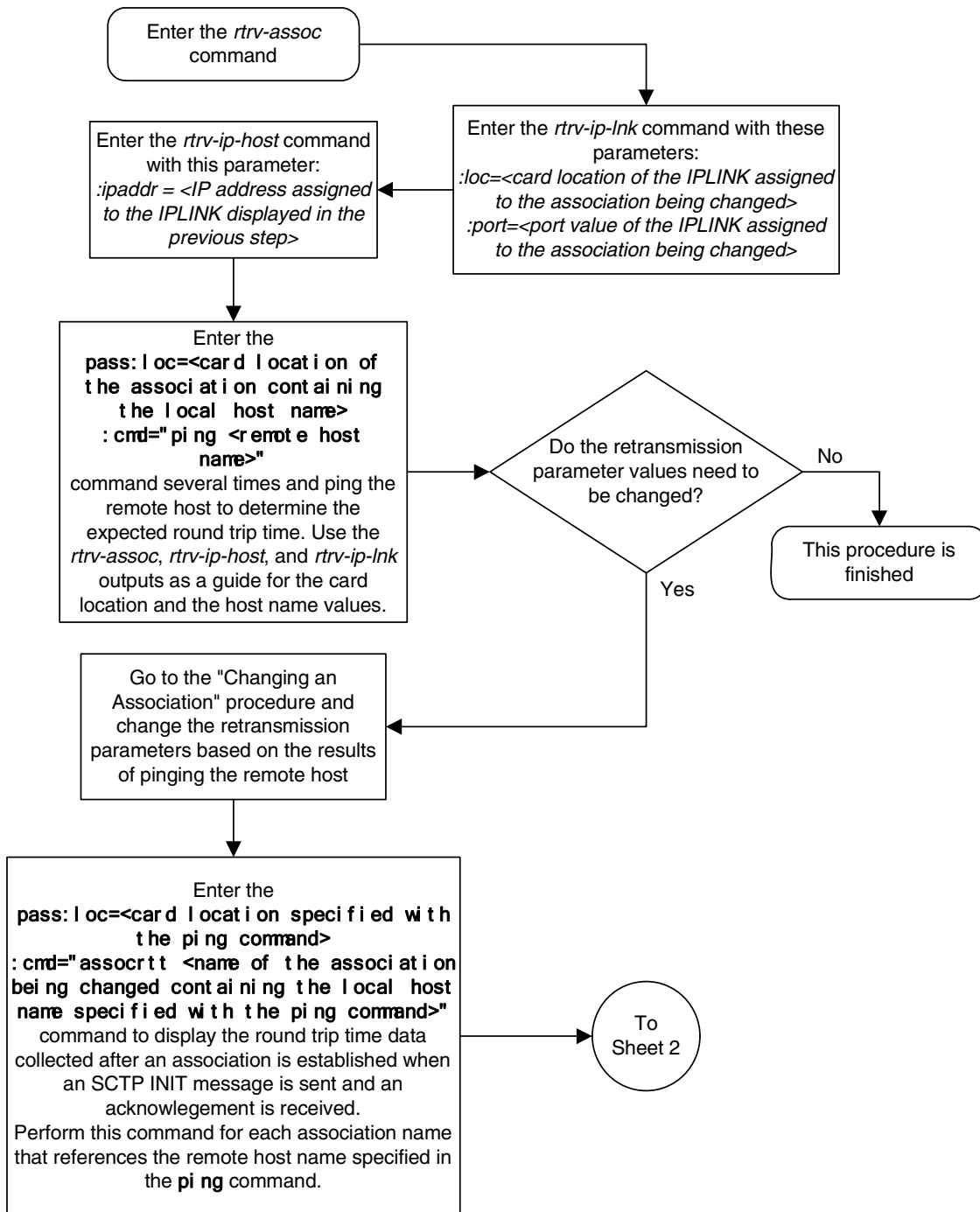

Flowchart 3-32. Configuring an Association for SCTP Retransmission Control (Sheet 2 of 2)

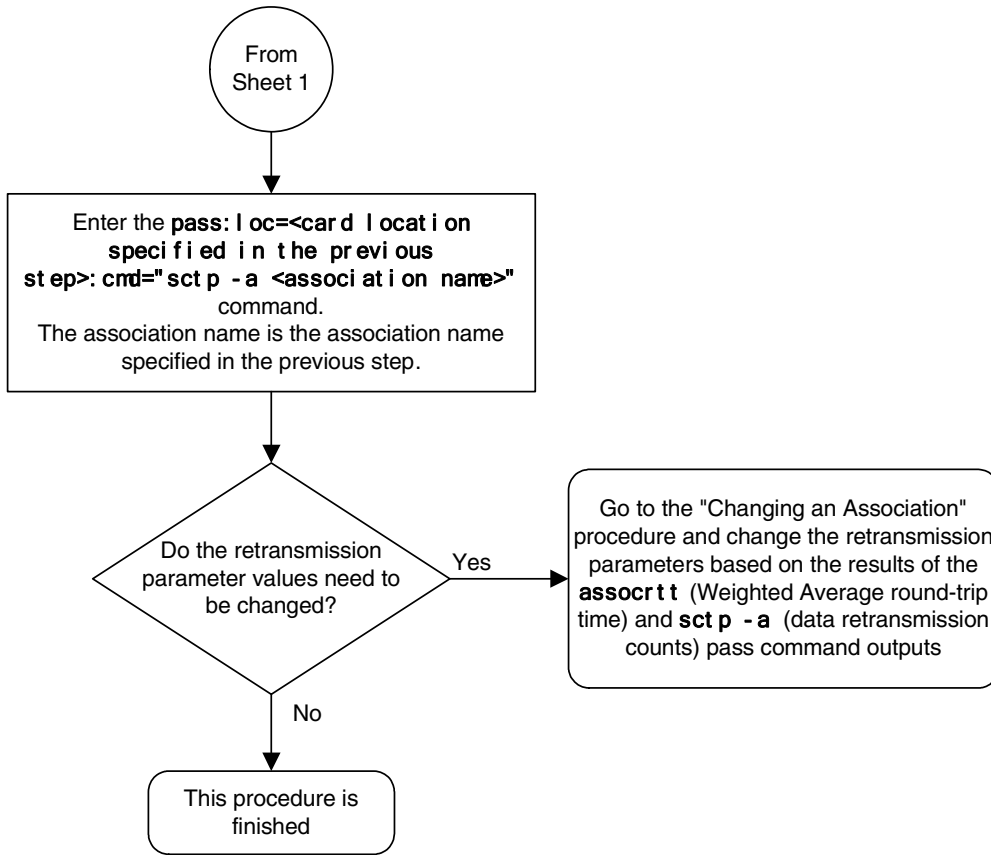

Changing an M2PA Timer Set

This procedure is used to change the values of the M2PA timers in an M2PA timer set using the `chg-m2pa-tset` command. The M2PA timers are used to control the behavior of the signaling link assigned to an M2PA association (an association containing the M2PA adapter layer - `adapter=m2pa`) during signaling link alignment and proving, and during times of transmit congestion.

The EAGLE 5 ISS contains 20 M2PA timer sets. One of these timer sets is assigned to an M2PA association using the `m2patset` parameter of either the `ent-assoc` or `chg-assoc` command. If the `m2patset` parameter is not specified with the `ent-assoc` command, or with the `chg-assoc` command if the adapter layer for that association is being changed to M2PA, timer set 1 is automatically assigned to the association.



CAUTION: Changing an M2PA timer set may affect the performance of all associations using the timer set being changed.

The `chg-m2pa-tset` command uses these parameters.

:tset – The M2PA timer set being changed, 1 - 20.

:srctset – The timer values in an existing M2PA timer set can be copied to another M2PA timer set, specified by the `tset` parameter. The `srctset` parameter specifies the timer set that is to be copied. If the `srctset` parameter is specified, no other timer values can be specified. The `srctset` parameter value cannot be the timer set specified by the `tset` parameter.

:ver – The M2PA version, either Draft 6 (`ver=d6`) or RFC (`ver=rfc`).

NOTE: The definitions of timers T1 and T3 for the Draft 6 version are different from the RFC version. The T2 timer applies only to the RFC version. The definitions of timers T4N, T4E, T5, T6, T7, T16, T17 and T18 for are the same for the Draft 6 version and the RFC version.

The timer parameter descriptions and values are shown in Table 3-31 on page 3-390.

Table 3-31. M2PA Timers

| Timer | Draft 6 Timer Name | RFC Timer Name | Definition | Value (in milliseconds) | DRAFT 6 System Default Value (in milliseconds) | RFC System Default Value (in milliseconds) |
|-------|------------------------|-------------------|--|-------------------------|--|--|
| :t1 | N/A | Ready Timer | The amount of time after proving the M2PA adapter layer waits to receive a Link Status Ready message from the peer. | 1000 - 350000 | N/A | 300000 |
| :t1 | Alignment Timer | N/A | The amount of time the M2PA adapter layer waits to receive a Link Status Alignment message from the peer. | 1000 - 350000 | 10000 | N/A |
| :t2 * | N/A | Not Aligned Timer | The the amount of time the M2PA adapter layer waits to receive a Link Status Alignment/Link Status Proving message after sending a Link Status Alignment message. Timer T2 is not used in M2PA Draft 6 timer sets. | 5000 - 150000 | N/A | 20000 |
| :t3 | N/A | Alignment Timer | The amount of time the M2PA layer waits to receive a Link Status Alignment message from the peer. | 1000 - 60000 | N/A | 2000 |
| | Ready Timer | N/A | The amount of time after proving the M2PA adapter layer waits to receive a Link Status Ready message from the peer. | 1000 - 60000 | 10000 | N/A |
| :t4n | Proving Timer (Normal) | | The amount of time the M2PA adapter layer generates Link Status Proving messages during normal proving. | 1000 - 70000 | 10000 | 30000 |

Table 3-31. M2PA Timers (Continued)

| Timer | Draft 6 Timer Name | RFC Timer Name | Definition | Value (in milliseconds) | DRAFT 6 System Default Value (in milliseconds) | RFC System Default Value (in milliseconds) |
|---|---------------------------------------|----------------|--|-------------------------|--|--|
| :t4e | Proving Timer (Emergency) | | The amount of time the M2PA adapter layer generates Link Status Proving messages during emergency proving. | 400 - 5000 | 500 | 500 |
| :t5 | Busy Rate Timer | | The amount of time between sending Link Status Busy messages while the link is in-service. | 80 - 10000 | 1000 | 100 |
| :t6 | Remote Congestion Timer | | The amount of time that a congested link will remain in service. | 1000 - 6000 | 3000 | 3000 |
| :t7 | Excess Delay in Acknowledgement Timer | | The maximum amount of time that may pass between when a user data message is transmitted and an acknowledgement for that message is received from the peer. If this timer expires, the link is taken out of service. | 200 - 2000 | 1200 | 1200 |
| :t16 | Proving Rate Timer | | The amount of time between sending Link Status Proving messages while the T4N or T4E timer is running. | 100 - 500000 ** | 200000 ** | 200000 ** |
| :t17 | Ready Rate Timer | | The amount of time between sending Link Status Ready messages while the T3 timer is running. | 100 - 500 | 250 | 250 |
| :t18 | Processor Outage Rate Timer | | The amount of time between sending Link Status Processor Outage messages while the link is in-service. | 100 - 10000 | 1000 | 1000 |
| * The T2 Timer can be specified only for the M2PA RFC version. ** The value of the T16 Timer is in microseconds. | | | | | | |

The value of any timer parameter not specified with the `chg-m2pa-tset` command is not changed.

Procedure

1. Display the M2PA timer sets in the database by entering the `rtrv-m2pa-tset` command with the version of the M2PA timer sets you wish to change with the `ver` parameter.

To display the M2PA Draft 6 timer values, enter this command.

```
rtrv-m2pa-tset:ver=d6
```

```
rlghncxa03w 06-10-28 21:16:37 GMT EAGLE5 36.0.0
```

```
M2PA Draft 6 Timers (in msec, T16 in microsec)
```

| TSET | T1 | T2 | T3 | T4N | T4E | T5 | T6 | T7 | T16 | T17 | T18 |
|------|-------|-------|-------|-------|-----|------|------|------|--------|-----|------|
| 1 | 6000 | ----- | 5000 | 20000 | 500 | 5000 | 3000 | 1000 | 200000 | 250 | 1000 |
| 2 | 10000 | ----- | 10000 | 10000 | 500 | 1000 | 3000 | 1200 | 200000 | 250 | 1000 |
| 3 | 10000 | ----- | 10000 | 10000 | 500 | 1000 | 3000 | 1200 | 200000 | 250 | 1000 |
| 4 | 10000 | ----- | 10000 | 10000 | 500 | 1000 | 3000 | 1200 | 200000 | 250 | 1000 |
| 5 | 10000 | ----- | 10000 | 10000 | 500 | 1000 | 3000 | 1200 | 200000 | 250 | 1000 |
| 6 | 10000 | ----- | 10000 | 10000 | 500 | 1000 | 3000 | 1200 | 200000 | 250 | 1000 |
| 7 | 10000 | ----- | 10000 | 10000 | 500 | 1000 | 3000 | 1200 | 200000 | 250 | 1000 |
| 8 | 10000 | ----- | 10000 | 10000 | 500 | 1000 | 3000 | 1200 | 200000 | 250 | 1000 |
| 9 | 27500 | ----- | 3850 | 4859 | 450 | 5700 | 3750 | 1150 | 250 | 375 | 8750 |
| 10 | 10000 | ----- | 10000 | 10000 | 500 | 1000 | 3000 | 1200 | 200000 | 250 | 1000 |
| 11 | 10000 | ----- | 10000 | 10000 | 500 | 1000 | 3000 | 1200 | 200000 | 250 | 1000 |
| 12 | 10000 | ----- | 10000 | 10000 | 500 | 1000 | 3000 | 1200 | 200000 | 250 | 1000 |
| 13 | 10000 | ----- | 10000 | 10000 | 500 | 1000 | 3000 | 1200 | 200000 | 250 | 1000 |
| 14 | 10000 | ----- | 10000 | 10000 | 500 | 1000 | 3000 | 1200 | 200000 | 250 | 1000 |
| 15 | 10000 | ----- | 10000 | 10000 | 500 | 1000 | 3000 | 1200 | 200000 | 250 | 1000 |
| 16 | 10000 | ----- | 10000 | 10000 | 500 | 1000 | 3000 | 1200 | 200000 | 250 | 1000 |
| 17 | 10000 | ----- | 10000 | 10000 | 500 | 1000 | 3000 | 1200 | 200000 | 250 | 1000 |
| 18 | 10000 | ----- | 10000 | 10000 | 500 | 1000 | 3000 | 1200 | 200000 | 250 | 1000 |
| 19 | 10000 | ----- | 10000 | 10000 | 500 | 1000 | 3000 | 1200 | 200000 | 250 | 1000 |
| 20 | 10000 | ----- | 10000 | 10000 | 500 | 1000 | 3000 | 1200 | 200000 | 250 | 1000 |

To display the M2PA RFC timer values, enter this command.

```
rtrv-m2pa-tset:ver=rfc
```

```
rlghncxa03w 06-10-28 21:16:37 GMT EAGLE5 36.0.0
```

```
M2PA RFC Timers (in msec, T16 in microsec)
```

| TSET | T1 | T2 | T3 | T4N | T4E | T5 | T6 | T7 | T16 | T17 | T18 |
|------|--------|-------|------|-------|-----|------|------|------|--------|-----|------|
| 1 | 6000 | 20000 | 5000 | 20000 | 500 | 5000 | 3000 | 1000 | 200000 | 250 | 1000 |
| 1 | 300000 | 20000 | 2000 | 30000 | 500 | 100 | 3000 | 1200 | 200000 | 250 | 1000 |
| 2 | 300000 | 20000 | 2000 | 30000 | 500 | 100 | 3000 | 1200 | 200000 | 250 | 1000 |
| 3 | 300000 | 20000 | 2000 | 30000 | 500 | 100 | 3000 | 1200 | 200000 | 250 | 1000 |
| 4 | 300000 | 20000 | 2000 | 30000 | 500 | 100 | 3000 | 1200 | 200000 | 250 | 1000 |
| 5 | 300000 | 20000 | 2000 | 30000 | 500 | 100 | 3000 | 1200 | 200000 | 250 | 1000 |
| 6 | 300000 | 20000 | 2000 | 30000 | 500 | 100 | 3000 | 1200 | 200000 | 250 | 1000 |
| 7 | 300000 | 20000 | 2000 | 30000 | 500 | 100 | 3000 | 1200 | 200000 | 250 | 1000 |
| 8 | 300000 | 20000 | 2000 | 30000 | 500 | 100 | 3000 | 1200 | 200000 | 250 | 1000 |
| 9 | 27500 | 10000 | 3850 | 4859 | 450 | 5700 | 3750 | 1150 | 250 | 375 | 8750 |
| 10 | 300000 | 20000 | 2000 | 30000 | 500 | 100 | 3000 | 1200 | 200000 | 250 | 1000 |
| 11 | 300000 | 20000 | 2000 | 30000 | 500 | 100 | 3000 | 1200 | 200000 | 250 | 1000 |
| 12 | 300000 | 20000 | 2000 | 30000 | 500 | 100 | 3000 | 1200 | 200000 | 250 | 1000 |
| 13 | 300000 | 20000 | 2000 | 30000 | 500 | 100 | 3000 | 1200 | 200000 | 250 | 1000 |
| 14 | 300000 | 20000 | 2000 | 30000 | 500 | 100 | 3000 | 1200 | 200000 | 250 | 1000 |
| 15 | 300000 | 20000 | 2000 | 30000 | 500 | 100 | 3000 | 1200 | 200000 | 250 | 1000 |

IP7 Secure Gateway Configuration Procedures

```
16 300000 20000 2000 30000 500 100 3000 1200 200000 250 1000
17 300000 20000 2000 30000 500 100 3000 1200 200000 250 1000
18 300000 20000 2000 30000 500 100 3000 1200 200000 250 1000
19 300000 20000 2000 30000 500 100 3000 1200 200000 250 1000
20 300000 20000 2000 30000 500 100 3000 1200 200000 250 1000
```

If the **ver** parameter is not specified when entering the **rtrv-m2pa-tset** command, both the Draft 6 and RFC values are displayed. This is an example of the possible output.

```
rlghncxa03w 06-10-28 21:16:37 GMT EAGLE5 36.0.0
```

```
M2PA Draft 6 Timers (in msec, T16 in microsec)
```

| TSET | T1 | T2 | T3 | T4N | T4E | T5 | T6 | T7 | T16 | T17 | T18 |
|------|-------|-------|-------|-------|-----|------|------|------|--------|-----|------|
| 1 | 6000 | ----- | 5000 | 20000 | 500 | 5000 | 3000 | 1000 | 200000 | 250 | 1000 |
| 2 | 10000 | ----- | 10000 | 10000 | 500 | 1000 | 3000 | 1200 | 200000 | 250 | 1000 |
| 3 | 10000 | ----- | 10000 | 10000 | 500 | 1000 | 3000 | 1200 | 200000 | 250 | 1000 |
| 4 | 10000 | ----- | 10000 | 10000 | 500 | 1000 | 3000 | 1200 | 200000 | 250 | 1000 |
| 5 | 10000 | ----- | 10000 | 10000 | 500 | 1000 | 3000 | 1200 | 200000 | 250 | 1000 |
| 6 | 10000 | ----- | 10000 | 10000 | 500 | 1000 | 3000 | 1200 | 200000 | 250 | 1000 |
| 7 | 10000 | ----- | 10000 | 10000 | 500 | 1000 | 3000 | 1200 | 200000 | 250 | 1000 |
| 8 | 10000 | ----- | 10000 | 10000 | 500 | 1000 | 3000 | 1200 | 200000 | 250 | 1000 |
| 9 | 27500 | ----- | 3850 | 4859 | 450 | 5700 | 3750 | 1150 | 250 | 375 | 8750 |
| 10 | 10000 | ----- | 10000 | 10000 | 500 | 1000 | 3000 | 1200 | 200000 | 250 | 1000 |
| 11 | 10000 | ----- | 10000 | 10000 | 500 | 1000 | 3000 | 1200 | 200000 | 250 | 1000 |
| 12 | 10000 | ----- | 10000 | 10000 | 500 | 1000 | 3000 | 1200 | 200000 | 250 | 1000 |
| 13 | 10000 | ----- | 10000 | 10000 | 500 | 1000 | 3000 | 1200 | 200000 | 250 | 1000 |
| 14 | 10000 | ----- | 10000 | 10000 | 500 | 1000 | 3000 | 1200 | 200000 | 250 | 1000 |
| 15 | 10000 | ----- | 10000 | 10000 | 500 | 1000 | 3000 | 1200 | 200000 | 250 | 1000 |
| 16 | 10000 | ----- | 10000 | 10000 | 500 | 1000 | 3000 | 1200 | 200000 | 250 | 1000 |
| 17 | 10000 | ----- | 10000 | 10000 | 500 | 1000 | 3000 | 1200 | 200000 | 250 | 1000 |
| 18 | 10000 | ----- | 10000 | 10000 | 500 | 1000 | 3000 | 1200 | 200000 | 250 | 1000 |
| 19 | 10000 | ----- | 10000 | 10000 | 500 | 1000 | 3000 | 1200 | 200000 | 250 | 1000 |
| 20 | 10000 | ----- | 10000 | 10000 | 500 | 1000 | 3000 | 1200 | 200000 | 250 | 1000 |

```
M2PA RFC Timers (in msec, T16 in microsec)
```

| TSET | T1 | T2 | T3 | T4N | T4E | T5 | T6 | T7 | T16 | T17 | T18 |
|------|--------|-------|------|-------|-----|------|------|------|--------|-----|------|
| 1 | 6000 | 20000 | 5000 | 20000 | 500 | 5000 | 3000 | 1000 | 200000 | 250 | 1000 |
| 2 | 300000 | 20000 | 2000 | 30000 | 500 | 100 | 3000 | 1200 | 200000 | 250 | 1000 |
| 3 | 300000 | 20000 | 2000 | 30000 | 500 | 100 | 3000 | 1200 | 200000 | 250 | 1000 |
| 4 | 300000 | 20000 | 2000 | 30000 | 500 | 100 | 3000 | 1200 | 200000 | 250 | 1000 |
| 5 | 300000 | 20000 | 2000 | 30000 | 500 | 100 | 3000 | 1200 | 200000 | 250 | 1000 |
| 6 | 300000 | 20000 | 2000 | 30000 | 500 | 100 | 3000 | 1200 | 200000 | 250 | 1000 |
| 7 | 300000 | 20000 | 2000 | 30000 | 500 | 100 | 3000 | 1200 | 200000 | 250 | 1000 |
| 8 | 300000 | 20000 | 2000 | 30000 | 500 | 100 | 3000 | 1200 | 200000 | 250 | 1000 |
| 9 | 27500 | 10000 | 3850 | 4859 | 450 | 5700 | 3750 | 1150 | 250 | 375 | 8750 |
| 10 | 300000 | 20000 | 2000 | 30000 | 500 | 100 | 3000 | 1200 | 200000 | 250 | 1000 |
| 11 | 300000 | 20000 | 2000 | 30000 | 500 | 100 | 3000 | 1200 | 200000 | 250 | 1000 |
| 12 | 300000 | 20000 | 2000 | 30000 | 500 | 100 | 3000 | 1200 | 200000 | 250 | 1000 |
| 13 | 300000 | 20000 | 2000 | 30000 | 500 | 100 | 3000 | 1200 | 200000 | 250 | 1000 |
| 14 | 300000 | 20000 | 2000 | 30000 | 500 | 100 | 3000 | 1200 | 200000 | 250 | 1000 |
| 15 | 300000 | 20000 | 2000 | 30000 | 500 | 100 | 3000 | 1200 | 200000 | 250 | 1000 |
| 16 | 300000 | 20000 | 2000 | 30000 | 500 | 100 | 3000 | 1200 | 200000 | 250 | 1000 |
| 17 | 300000 | 20000 | 2000 | 30000 | 500 | 100 | 3000 | 1200 | 200000 | 250 | 1000 |
| 18 | 300000 | 20000 | 2000 | 30000 | 500 | 100 | 3000 | 1200 | 200000 | 250 | 1000 |
| 19 | 300000 | 20000 | 2000 | 30000 | 500 | 100 | 3000 | 1200 | 200000 | 250 | 1000 |
| 20 | 300000 | 20000 | 2000 | 30000 | 500 | 100 | 3000 | 1200 | 200000 | 250 | 1000 |

- Change the desired timer set with the `chg-m2pa-tset` command. To change a specific timer set, enter the `chg-m2pa-tset` command with the `tset` and `ver` parameters and the timer parameters you wish to change. For this example, to change the values of the RFC version of timer set 1, enter this command.

```
chg-m2pa-tset:tset=1:t1=27500:t2=10000:t3=3850:t4e=450
:t4n=45000:t5=5700:t6=3750:t7=1150:t16=250000:t17=375:t18=8750
:ver=rfc
```

To change the values of the Draft 6 version of timer set 1, enter this command.

```
chg-m2pa-tset:tset=1:t1=27500:t3=3850:t4e=450:t4n=45000
:t5=5700:t6=3750:t7=1150:t16=250000:t17=375:t18=8750:ver=d6
```

NOTE: The values for the M2PA timers are shown in Table 3-31 on page 3-390.

To copy an M2PA timer set to another timer set, enter the `chg-m2pa-tset` command with the `tset`, `ver`, and `srctset` parameters. For this example, to copy the RFC version of timer set 9 to timer set 1, enter this command.

```
chg-m2pa-tset:tset=1:srctset=9:ver=rfc
```

To copy the Draft 6 version of timer set 9 to timer set 1, enter this command.

```
chg-m2pa-tset:tset=1:srctset=9:ver=d6
```

NOTE: The `ver` parameter is optional and does not have to be specified to change the M2PA RFC timer values. The default value for the `ver` parameter is `rfc`. If you wish to change the M2PA Draft 6 timer values, the `ver=d6` parameter must be specified with the `chg-m2pa-tset` command.

When the `chg-m2pa-tset` command has successfully completed, the following message should appear.

```
rlghncxa03w 06-10-28 21:16:37 GMT EAGLE5 36.0.0
CHG-M2PA-TSET: MASP A - COMPLTD
```

- Verify the changes by entering the `rtrv-m2pa-tset` command specifying the timer set and version parameter values specified in step 2. For this example, enter one of these commands.

```
rtrv-m2pa-tset:tset=1:ver=rfc
```

```
rlghncxa03w 06-10-28 21:16:37 GMT EAGLE5 36.0.0
```

M2PA RFC Timers (in msec, T16 in microsec)

| TSET | T1 | T2 | T3 | T4N | T4E | T5 | T6 | T7 | T16 | T17 | T18 |
|------|-------|-------|------|-------|-----|------|------|------|--------|-----|------|
| 1 | 27500 | 10000 | 3850 | 45000 | 450 | 5700 | 3750 | 1150 | 250000 | 375 | 8750 |

```
rtrv-m2pa-tset:tset=1:ver=d6
```

```
rlghncxa03w 06-10-28 21:16:37 GMT EAGLE5 36.0.0
```

M2PA Draft 6 Timers (in msec, T16 in microsec)

| TSET | T1 | T2 | T3 | T4N | T4E | T5 | T6 | T7 | T16 | T17 | T18 |
|------|-------|-------|------|-------|-----|------|------|------|--------|-----|------|
| 1 | 27500 | ----- | 3850 | 45000 | 450 | 5700 | 3750 | 1150 | 250000 | 375 | 8750 |

rtrv-m2pa-tset:tset=9:ver=rfc

rlghncxa03w 06-10-28 21:16:37 GMT EAGLE5 36.0.0

M2PA RFC Timers (in msec, T16 in microsec)

| TSET | T1 | T2 | T3 | T4N | T4E | T5 | T6 | T7 | T16 | T17 | T18 |
|------|-------|-------|------|-------|-----|------|------|------|--------|-----|------|
| 9 | 27500 | 10000 | 3850 | 45000 | 450 | 5700 | 3750 | 1150 | 250000 | 375 | 8750 |

rtrv-m2pa-tset:tset=9:ver=d6

rlghncxa03w 06-10-28 21:16:37 GMT EAGLE5 36.0.0

M2PA Draft 6 Timers (in msec, T16 in microsec)

| TSET | T1 | T2 | T3 | T4N | T4E | T5 | T6 | T7 | T16 | T17 | T18 |
|------|-------|-------|------|-------|-----|------|------|------|--------|-----|------|
| 9 | 27500 | ----- | 3850 | 45000 | 450 | 5700 | 3750 | 1150 | 250000 | 375 | 8750 |

-
4. Back up the new changes, using the **chg-db:action=backup:dest=fixed** command. These messages should appear; the active Maintenance and Administration Subsystem Processor (MASP) appears first.

```
BACKUP (FIXED) : MASP A - Backup starts on active MASP.  
BACKUP (FIXED) : MASP A - Backup on active MASP to fixed disk complete.  
BACKUP (FIXED) : MASP A - Backup starts on standby MASP.  
BACKUP (FIXED) : MASP A - Backup on standby MASP to fixed disk complete.
```

Flowchart 3-33. Changing an M2PA Timer Set

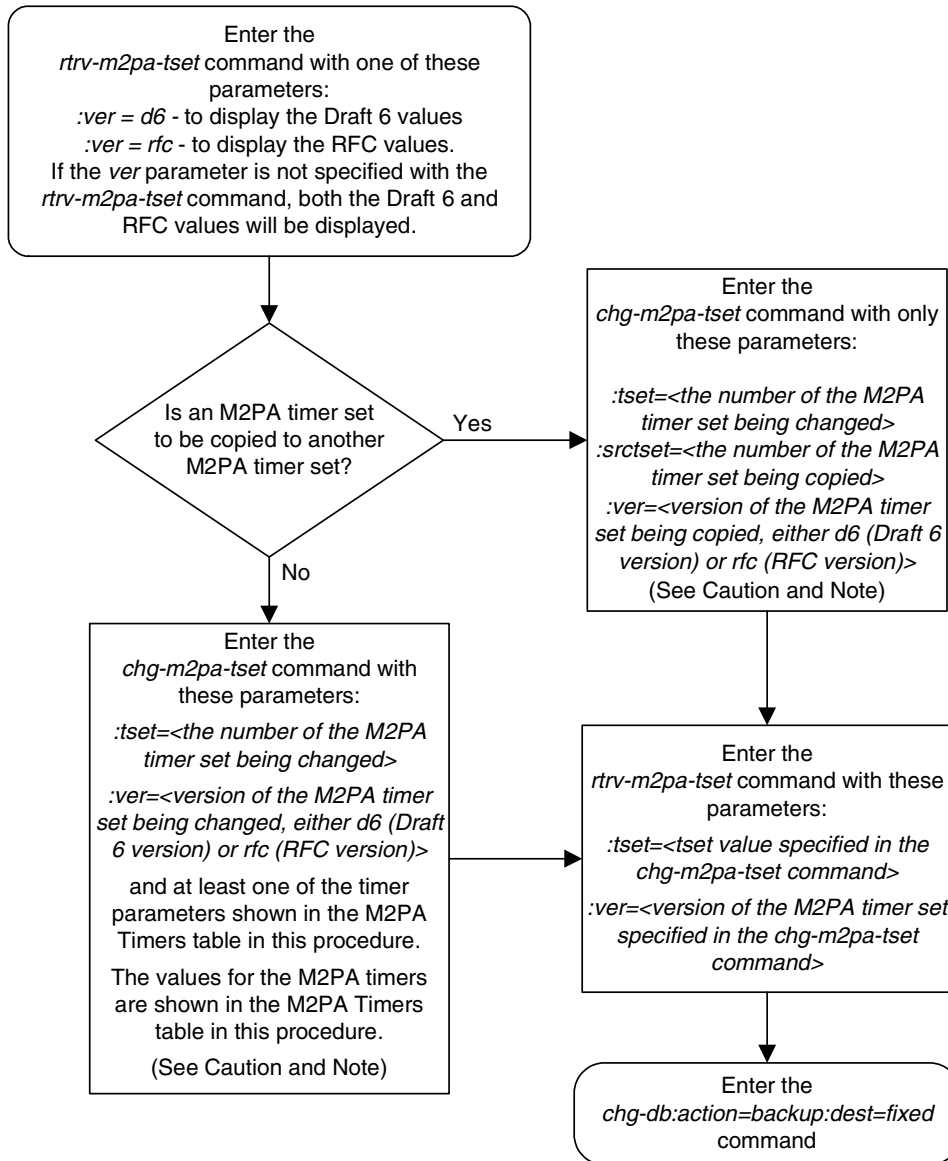

Notes:

1. Either the timer parameters or the *srctset* parameter must be specified with the *chg-m2pa-tset* command. Both the timer parameters and the *srctset* parameter cannot be specified with the *chg-m2pa-tset* command.
2. If the *ver* parameter is not specified with the *chg-m2pa-tset* command, the RFC values will be changed. To change the Draft 6 values, the *ver=d6* parameter must be specified with the *chg-m2pa-tset* command.

Caution: Changing an M2PA timer set may affect the performance of any associations using the timer set being changed.

Adding a New Association to a New Application Server

This procedure is used create a new application server and assign a new association to the application server using the `ent-as` command.

The `ent-as` command uses these parameters:

:asname – The name of the new application server. The name of the application server can contain up to 15 alphanumeric characters, with the first character being an alphabetic character. Application server names are not case sensitive.

:aname – The name of the association being assigned to the application server.

The maximum number of TALI sockets and SCTP association to application server assignments that can be hosted by an IPGWx card (referenced by the `lhost` parameter of the socket and association) is 50. For example, if the IPGWx card contains 12 TALI sockets, the maximum number of SCTP association to application server assignments that the IPGWx card can support is 38. The SCTP association to application server assignments could be one SCTP association assigned to 38 application servers, two SCTP associations assigned to 19 application servers, or any combination of SCTP associations assigned to application servers that add up to 38. The number of TALI sockets can be verified with the `rtrv-appl-sock:lhost=<local host name>` command. The SCTP association to application server assignments can be verified with the `rtrv-assoc:lhost=<local host name>` and `rtrv-as:aname=<association name>` commands.

Table 3-32. Examples of IPGWx Card Provisioning Limits

| Number of Associations hosted by the IPGWx card | Number of Application Servers each Association is Assigned to * | Number of TALI Sockets Hosted by the IPGWx card | Total Association - Application Server Assignments and TALI Sockets maintained by the IPGWx card |
|---|---|---|--|
| 1 | 50 | 0 | 50 |
| 50 | 1 | 0 | 50 |
| 25 | 1 | 25 | 50 |
| 25 | 2 | 0 | 50 |
| 0 | 0 | 50 | 50 |
| 38 | 1 | 12 | 50 |
| 19 | 2 | 12 | 50 |
| * The EAGLE 5 ISS can contain a maximum of 250 application servers. | | | |

The `open` parameter of the association must be set to `no` before the association can be assigned to the application server. This can be verified with the `rtrv-assoc` command.

M2PA associations (**adapter=m2pa**) cannot be assigned to application servers. Only M3UA (**adapter=m3ua**) and SUA (**adapter=sua**) associations can be assigned to application servers. This can be verified in the **ADAPTER** field in the **rtrv-assoc** output.

The application server recovery timer (the **tr** parameter of the **chg-as** command) for the application server is set by default to 10 milliseconds when an application server is added. The traffic mode (the **mode** parameter of the **chg-as** command) for the application server is set by default to **LOADSHARE** when an application server is added. Perform the “Changing an Application Server” procedure on page 3-447 to change these parameter values.

Canceling the **RTRV-AS**, **RTRV-APPL-SOCK**, and **RTRV-ASSOC** Commands

Because the **rtrv-as**, **rtrv-appl-sock**, and **rtrv-assoc** commands used in this procedure can output information for a long period of time, the **rtrv-as**, **rtrv-appl-sock**, and **rtrv-assoc** commands can be canceled and the output to the terminal stopped. There are three ways that the **rtrv-as**, **rtrv-appl-sock**, and **rtrv-assoc** commands can be canceled.

- Press the **F9** function key on the keyboard at the terminal where the **rtrv-as**, **rtrv-appl-sock**, or **rtrv-assoc** commands were entered.
- Enter the **canc-cmd** without the **trm** parameter at the terminal where the **rtrv-as**, **rtrv-appl-sock**, or **rtrv-assoc** commands were entered.
- Enter the **canc-cmd:trm=<xx>**, where **<xx>** is the terminal where the **rtrv-as**, **rtrv-appl-sock**, or **rtrv-assoc** commands were entered, from another terminal other than the terminal where the **rtrv-as**, **rtrv-appl-sock**, or **rtrv-assoc** commands were entered. To enter the **canc-cmd:trm=<xx>** command, the terminal must allow Security Administration commands to be entered from it and the user must be allowed to enter Security Administration commands. The terminal's permissions can be verified with the **rtrv-secu-trm** command. The user's permissions can be verified with the **rtrv-user** or **rtrv-secu-user** commands.

For more information about the **canc-cmd** command, go to the *Commands Manual*.

Procedure

1. Display the application servers in the database using the **rtrv-as** command. This is an example of possible output.

```
rlghncxa03w 06-10-28 09:12:36 GMT EAGLE5 36.0.0

AS Name           Mode           Tr ms   Association Names
as1                LOADSHARE     10      a2
                  LOADSHARE     10      a3
                  LOADSHARE     10      assoc1

as2                OVERRIDE      10      assoc7
as3                OVERRIDE      10      swbel32

AS table is (3 of 250) 1% full.
```

2. Display the associations in the database using the **rtrv-assoc** command. This is an example of possible output.

```
rlghncxa03w 06-10-28 09:12:36 GMT EAGLE5 36.0.0

          CARD IPLNK
ANAME     LOC  PORT  LINK ADAPTER LPORT RPORT OPEN ALW
swbel32   1201 A    A    M3UA   1030 2345 YES YES
a2        1305 A    A    SUA    2000 2345 YES YES
a3        1307 A    A    SUA    3000 3000 YES YES
assoc1    1305 A    A    SUA    4000 1030 YES YES
assoc7    1311 A    A    SUA    2500 2000 YES YES
```

3. Display the IP host names in the database by using the **rtrv-ip-host** command. The following is an example of the possible output.

```
rlghncxa03w 06-10-28 21:15:37 GMT EAGLE5 36.0.0

LOCAL IPADDR      LOCAL HOST
192.1.1.10        IPNODE1-1201
192.1.1.12        GW105.NC.TEKELEC.COM
192.1.1.14        IPNODE1-1205
192.1.1.20        IPNODE2-1201
192.1.1.22        IPNODE2-1203
192.1.1.24        IPNODE2-1205
192.1.1.30        KC-HLR1
192.1.1.32        KC-HLR2
192.1.1.50        DN-MSCL
192.1.1.52        DN-MSCL

REMOTE IPADDR     REMOTE HOST
150.1.1.5         NCDEPTECONOMIC_DEVELOPMENT.SOUTHEASTERN_COORIDOR_ASHVL.GOV

IP Host table is (11 of 512) 2% full
```

If the IP host name for the new association is not shown in the **LOCAL HOST** column of the **rtrv-ip-host** output, add the IP host name by performing the “Adding an IP Host” procedure on page 3-153. Then go to step 6.

If the IP host name for the new association is shown in the **LOCAL HOST** column of the **rtrv-ip-host** output, go to step 4.

4. Display the sockets assigned to the local host value that will be assigned to the association being configured in this procedure by entering the **rtrv-appl-sock** command with the **lhost** parameter. For this example, enter this command.

rtrv-appl-sock:lhost=IPNODE2-1205

This is an example of the possible output.

```
rlghncxa03w 06-10-28 21:14:37 GMT EAGLE5 36.0.0
SNAME sock1
  LINK      A
  LHOST     IPNODE2-1205
  RHOST     remotehost1
  LPORT     1024          RPORT      2048
  SERVER    YES          DCMPS      10
  REXMIT    FIXED       RTT         60
  OPEN      YES         ALW         YES
SNAME sock2
  LINK      A
  LHOST     IPNODE2-1205
  RHOST     remotehost2
  LPORT     2000          RPORT      2000
  SERVER    YES          DCMPS      10
  REXMIT    FIXED       RTT         60
  OPEN      YES         ALW         YES
IP Appl Sock/Assoc table is (8 of 4000) 1% full
```

5. Display the associations assigned to the local host value that will be assigned to the association being configured in this procedure by entering the **rtrv-assoc** command with the **lhost** parameter. For this example, enter this command.

rtrv-assoc:lhost=IPNODE2-1205

This is an example of the possible output.

```
rlghncxa03w 06-10-28 21:14:37 GMT EAGLE5 36.0.0
          CARD IPLNK
ANAME      LOC  PORT  LINK ADAPTER LPORT RPORT OPEN ALW
a2         1205 A   A   SUA   2000 2048 YES YES
a3         1205 A   A   SUA   3000 3000 YES YES
IP Appl Sock/Assoc table is (8 of 4000) 1% full
Assoc Buffer Space Used (32 KB of 3200 KB) on LOC = 1205
```

6. Display the application servers that the associations shown in step 5 are assigned to by entering **rtrv-as** command with the names of the associations shown in step 5. For this example, enter these commands.

```
rtrv-as:aname=a2
```

This is an example of the possible output.

```
rlghncxa03w 06-10-28 21:14:37 GMT EAGLE5 36.0.0
AS Name      Mode      Tr ms    Association Names
as1          LOADSHARE 2000     a2
AS Table is (3 of 250) 1% full
```

```
rtrv-as:aname=a3
```

This is an example of the possible output.

```
rlghncxa03w 06-10-28 21:14:37 GMT EAGLE5 36.0.0
AS Name      Mode      Tr ms    Association Names
as2          LOADSHARE 2000     a3
AS Table is (3 of 250) 2% full
```

The maximum number of TALI sockets and SCTP association to application server assignments that can be hosted by an IPGWx card (referenced by the **lhost** parameter of the socket and association) is 50.

If the number of TALI sockets and SCTP association to application server assignments is less than 50, go to step 7.

If the number of TALI sockets and SCTP association to application server assignments is 50, the local host value cannot be used in this procedure.

Repeat this procedure from step 3 and select another local IP host from the **rtrv-ip-host** output or perform the "Adding an IP Host" procedure on page 3-153 to add a new local IP host. After the new local IP host name as been added, go to step 7.

7. Add the new association by performing the "Adding an Association" procedure on page 3-327. The **open** parameter value for this association must be set to **no**.

NOTE: See Flowchart 3-34 on page 3-405 (Sheet 3) for the rules that apply to the new association and the new application server.

8. Assign the new association to the new application server and add the new application server to the database using the **ent-as** command. For this example, enter this command

```
ent-as:asname=as4:aname=assoc10
```

When this command has successfully completed, this message should appear.

```
rlghncxa03w 06-10-28 09:12:36 GMT EAGLE5 36.0.0
ENT-AS: MASP A - COMPLTD;
```

9. Verify the changes using the **rtrv-as** command with the application server name and association name specified in step 8. For this example, enter this command.

```
rtrv-as:asname=as4:aname=assoc10
```

This is an example of possible output.

```
rlghncxa03w 06-10-28 09:12:36 GMT EAGLE5 36.0.0
```

| AS Name | Mode | Tr ms | Association Names |
|---------|-----------|-------|-------------------|
| as4 | LOADSHARE | 10 | assoc10 |

```
AS table is (4 of 250) 1% full.
```

NOTE: If you do not wish to change the **open** parameter value of the association specified in step 8, skip step 10 and go to step 11.

10. Change the value of the **open** parameter to **yes** by specifying the **chg-assoc** command with the **open=yes** parameter. For this example, enter this command.

```
chg-assoc:aname=assoc10:open=yes
```

When this command has successfully completed, this message should appear.

```
rlghncxa03w 06-10-28 09:12:36 GMT EAGLE5 36.0.0
CHG-ASSOC: MASP A - COMPLTD;
```

11. Back up the new changes, using the **chg-db:action=backup:dest=fixed** command. These messages should appear; the active Maintenance and Administration Subsystem Processor (MASP) appears first.

```
BACKUP (FIXED) : MASP A - Backup starts on active MASP.
BACKUP (FIXED) : MASP A - Backup on active MASP to fixed disk complete.
BACKUP (FIXED) : MASP A - Backup starts on standby MASP.
BACKUP (FIXED) : MASP A - Backup on standby MASP to fixed disk complete.
```

Flowchart 3-34. Adding a New Association to a New Application Server
(Sheet 1 of 3)

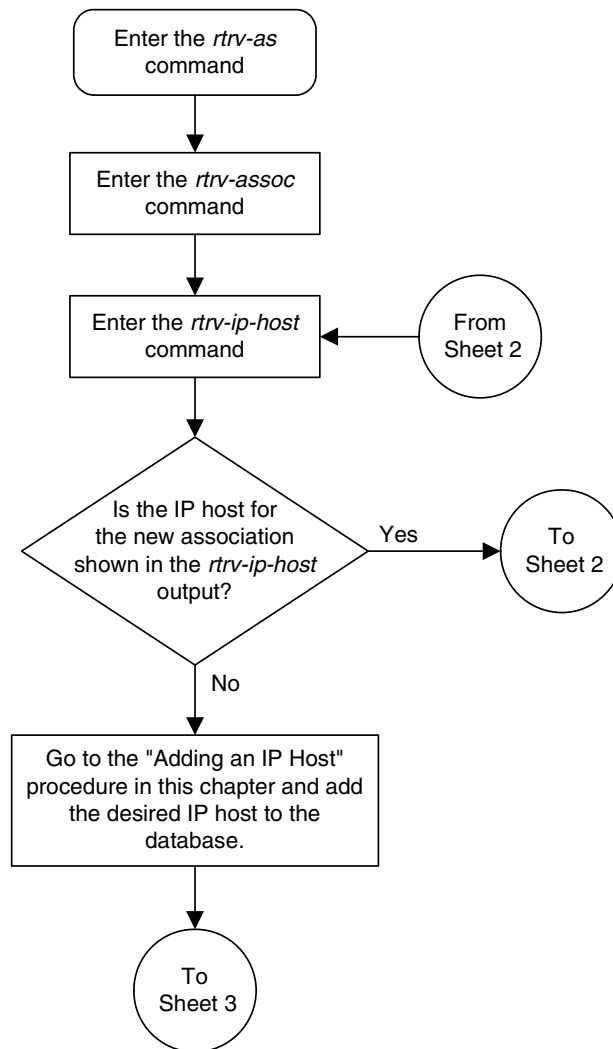

Flowchart 3-34. Adding a New Association to a New Application Server
(Sheet 2 of 3)

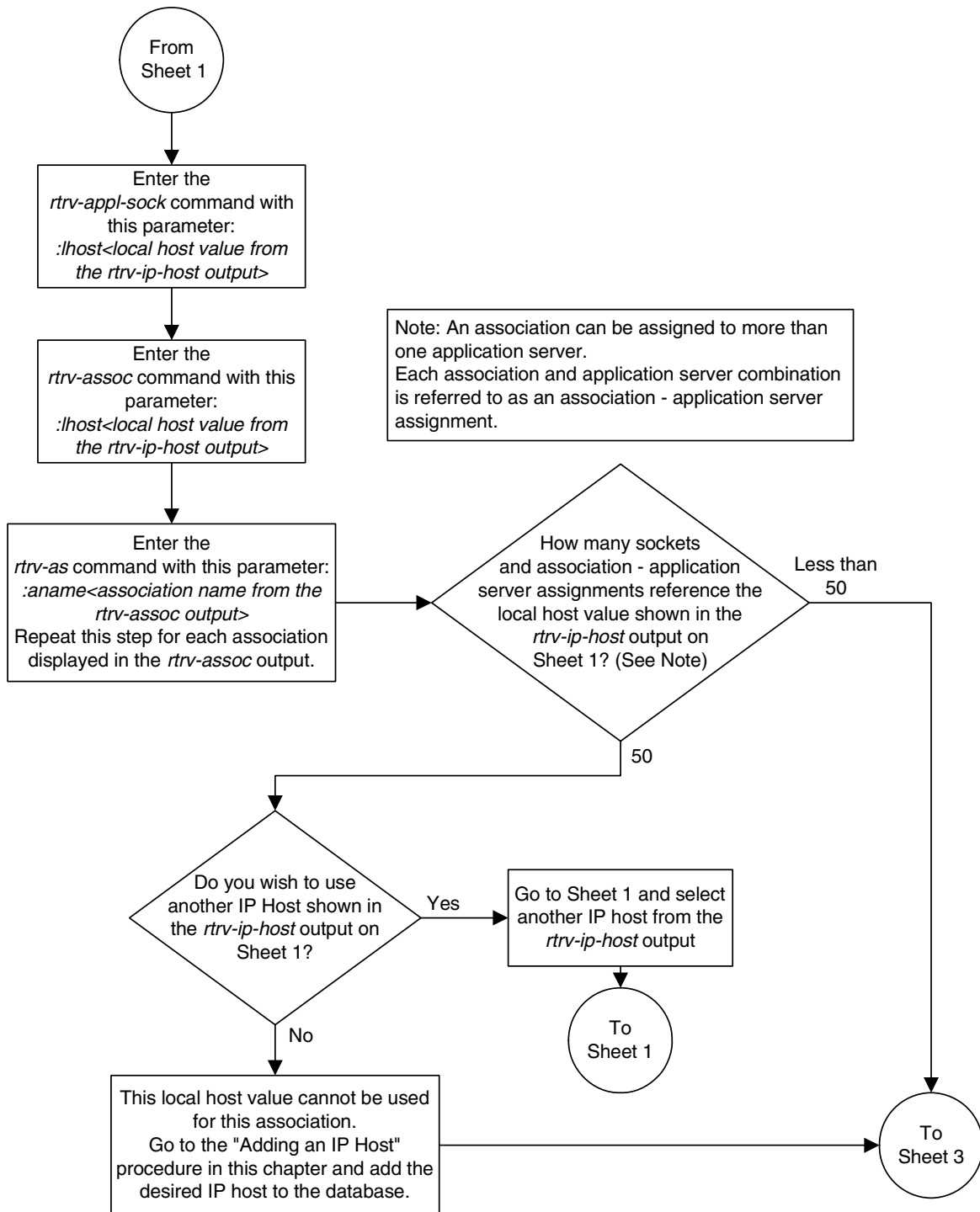

Flowchart 3-34. Adding a New Association to a New Application Server
(Sheet 3 of 3)

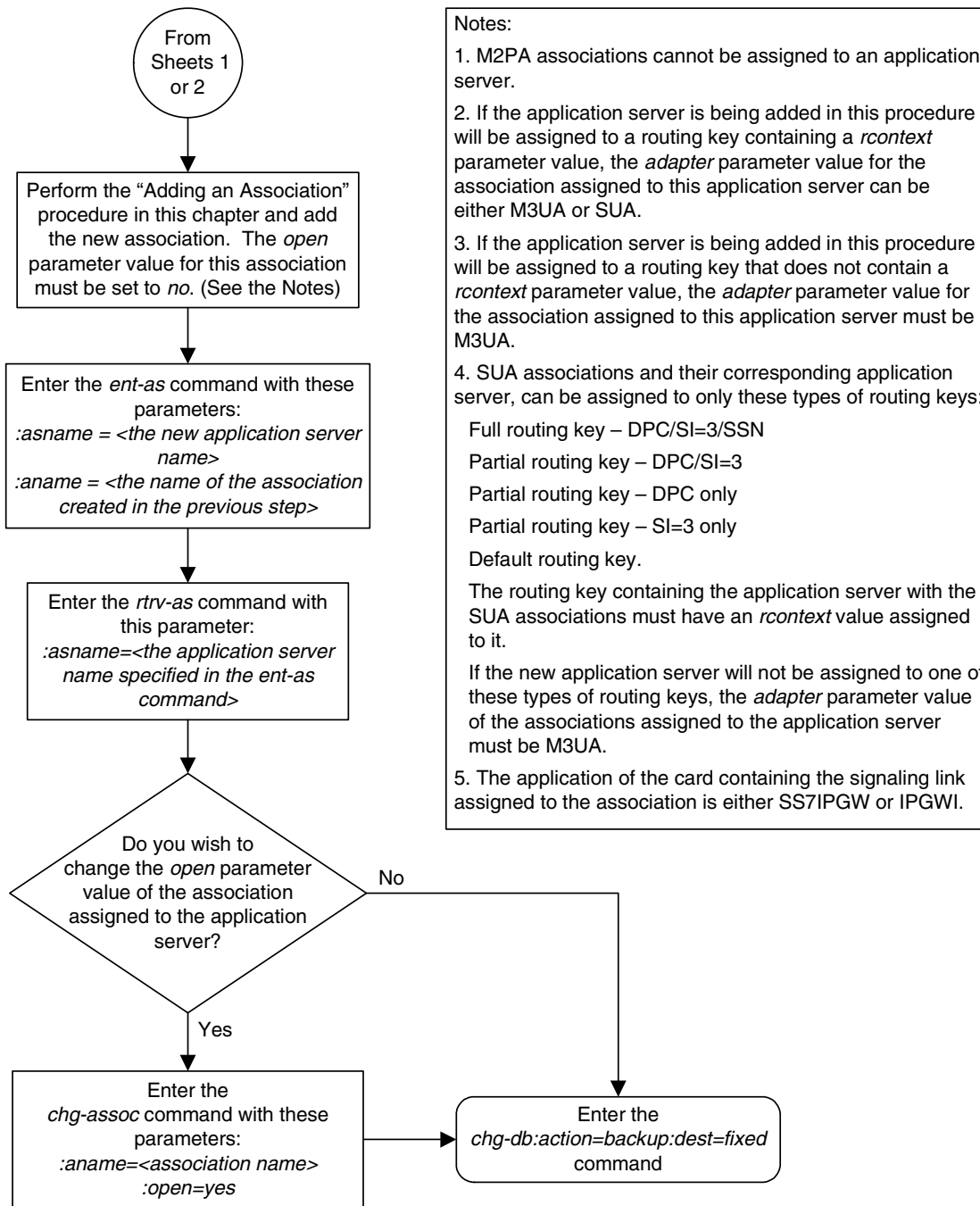

Notes:

1. M2PA associations cannot be assigned to an application server.
2. If the application server is being added in this procedure will be assigned to a routing key containing a *rcontext* parameter value, the *adapter* parameter value for the association assigned to this application server can be either M3UA or SUA.
3. If the application server is being added in this procedure will be assigned to a routing key that does not contain a *rcontext* parameter value, the *adapter* parameter value for the association assigned to this application server must be M3UA.
4. SUA associations and their corresponding application server, can be assigned to only these types of routing keys:
 - Full routing key – DPC/SI=3/SSN
 - Partial routing key – DPC/SI=3
 - Partial routing key – DPC only
 - Partial routing key – SI=3 only
 - Default routing key.
 The routing key containing the application server with the SUA associations must have an *rcontext* value assigned to it.
 If the new application server will not be assigned to one of these types of routing keys, the *adapter* parameter value of the associations assigned to the application server must be M3UA.
5. The application of the card containing the signaling link assigned to the association is either SS7IPGW or IPGWI.

Adding an Existing Association to a New Application Server

This procedure is used create a new application server and assign an existing association to the application server using the **ent-as** command.

The **ent-as** command uses these parameters:

:asname – The name of the new application server. The name of the application server can contain up to 15 alphanumeric characters, with the first character being an alphabetic character. Application server names are not case sensitive.

:aname – The name of the association being assigned to the application server.

The maximum number of TALI sockets and SCTP association to application server assignments that can be hosted by an IPGWx card (referenced by the **lhost** parameter of the socket and association) is 50. For example, if the IPGWx card contains 12 TALI sockets, the maximum number of SCTP association to application server assignments that the IPGWx card can support is 38. The SCTP association to application server assignments could be one SCTP association assigned to 38 application servers, two SCTP associations assigned to 19 application servers, or any combination of SCTP associations assigned to application servers that add up to 38. The number of TALI sockets can be verified with the **rtrv-appl-sock:lhost=<local host name>** command. The SCTP association to application server assignments can be verified with the **rtrv-assoc:lhost=<local host name>** and **rtrv-as:aname=<association name>** commands.

Table 3-33. Examples of IPGWx Card Provisioning Limits

| Number of Associations hosted by the IPGWx card | Number of Application Servers each Association is Assigned to * | Number of TALI Sockets Hosted by the IPGWx card | Total Association - Application Server Assignments and TALI Sockets maintained by the IPGWx card |
|---|---|---|--|
| 1 | 50 | 0 | 50 |
| 50 | 1 | 0 | 50 |
| 25 | 1 | 25 | 50 |
| 25 | 2 | 0 | 50 |
| 0 | 0 | 50 | 50 |
| 38 | 1 | 12 | 50 |
| 19 | 2 | 12 | 50 |
| * The EAGLE 5 ISS can contain a maximum of 250 application servers. | | | |

The **open** parameter of the association must be set to **no** before the association can be assigned to the application server. This can be verified with the **rtrv-assoc** command.

M2PA associations (**adapter=m2pa**) cannot be assigned to application servers. Only M3UA (**adapter=m3ua**) and SUA (**adapter=sua**) associations can be assigned to application servers. This can be verified in the **ADAPTER** field in the **rtrv-assoc** output.

The application server recovery timer (the **tr** parameter of the **chg-as** command) for the application server is set by default to 10 milliseconds when an application server is added. The traffic mode (the **mode** parameter of the **chg-as** command) for the application server is set by default to **LOADSHARE** when an application server is added. Perform the “Changing an Application Server” procedure on page 3-447 to change these parameter values.

Canceling the RTRV-AS, RTRV-APPL-SOCK, and RTRV-ASSOC Commands

Because the **rtrv-as**, **rtrv-appl-sock**, and **rtrv-assoc** commands used in this procedure can output information for a long period of time, the **rtrv-as**, **rtrv-appl-sock**, and **rtrv-assoc** commands can be canceled and the output to the terminal stopped. There are three ways that the **rtrv-as**, **rtrv-appl-sock**, and **rtrv-assoc** commands can be canceled.

- Press the **F9** function key on the keyboard at the terminal where the **rtrv-as**, **rtrv-appl-sock**, or **rtrv-assoc** commands were entered.
- Enter the **canc-cmd** without the **trm** parameter at the terminal where the **rtrv-as**, **rtrv-appl-sock**, or **rtrv-assoc** commands were entered.
- Enter the **canc-cmd:trm=<xx>**, where **<xx>** is the terminal where the **rtrv-as**, **rtrv-appl-sock**, or **rtrv-assoc** commands were entered, from another terminal other than the terminal where the **rtrv-as**, **rtrv-appl-sock**, or **rtrv-assoc** commands were entered. To enter the **canc-cmd:trm=<xx>** command, the terminal must allow Security Administration commands to be entered from it and the user must be allowed to enter Security Administration commands. The terminal's permissions can be verified with the **rtrv-secu-trm** command. The user's permissions can be verified with the **rtrv-user** or **rtrv-secu-user** commands.

For more information about the **canc-cmd** command, go to the *Commands Manual*.

Procedure

1. Display the application servers in the database using the **rtrv-as** command. This is an example of possible output.

```
rlghncxa03w 06-10-28 09:12:36 GMT EAGLE5 36.0.0

AS Name           Mode           Tr ms  Association Names
as1                LOADSHARE     10     a2
                  a3
                  assoc1

as2                OVERRIDE      10     assoc7
as3                OVERRIDE      10     swbel32

AS table is (3 of 250) 1% full.
```

NOTE: If the association being added to the application server is not shown in the `rtrv-as` output in step 1, skip step 2 and go to step 3.

2. Display the associations in the database using the `rtrv-assoc` command and specifying the association name shown in the `rtrv-as` output in step 1. For this example, enter this command.

```
rtrv-assoc:aname=assoc1
```

This is an example of possible output.

```
rlghncxa03w 06-10-28 09:12:36 GMT EAGLE5 36.0.0
ANAME assoc1
      LOC      1305          IPLNK PORT  A          LINK  A
ADAPTER  SUA          VER          SUA RFC
LHOST    gw102.nc.tekelec.com
ALHOST   ---
RHOST    gw100.nc.tekelec.com
LPORT    4000          RPORT      1030
ISTRMS   2            OSTRMS     2          BUFSIZE  16
RMODE    LIN          RMIN       120        RMAX     800
RTIMES   10          CWMIN      3000      UAPS     10
OPEN     YES          ALW        YES
ASNAMES
as1
```

```
IP Appl Sock table is (6 of 4000) 1% full
Assoc Buffer Space Used (16 KB of 800 KB) on LOC = 1305
```

If the association does not meet the requirements shown in Flowchart 3-35 on page 3-416 (Sheet 4), repeat this step with another association shown in step 1, or go to step 3.

If the association does meet the requirements shown in Flowchart 3-35 on page 3-416 (Sheet 4), skip step 3 and go to step 4.

3. Display the associations in the database using the **rtrv-assoc** command with the **display=all** parameter. This is an example of possible output.

```
rlghncxa03w 06-03-28 09:12:36 GMT EAGLE5 34.3.0
ANAME swbel32
  LOC      1201          IPLNK PORT  A          LINK  A
  ADAPTER  M3UA          VER      M3UA RFC
  LHOST    gw101.nc.tekelec.com
  ALHOST    ---
  RHOST    gw100.ncd-economic-development.southeastern-corridor-ash.gov
  LPORT    1030          RPORT    2345
  ISTRMS   2            OSTRMS   2          BUFSIZE 16
  RMODE    LIN          RMIN     120         RMAX    800
  RTIMES   10          CWMIN    3000        UAPS    10
  OPEN     YES          ALW      YES

ASNAMES
as3
```

```
IP Appl Sock table is (6 of 4000) 1% full
Assoc Buffer Space Used (16 KB of 800 KB) on LOC = 1201
```

```
ANAME a2
  LOC      1305          IPLNK PORT  A          LINK  A
  ADAPTER  SUA          VER      SUA RFC
  LHOST    gw102.nc.tekelec.com
  ALHOST    ---
  RHOST    gw100.nc.tekelec.com
  LPORT    2000          RPORT    2345
  ISTRMS   2            OSTRMS   2          BUFSIZE 16
  RMODE    LIN          RMIN     120         RMAX    800
  RTIMES   10          CWMIN    3000        UAPS    10
  OPEN     YES          ALW      YES

ASNAMES
as1
```

```
IP Appl Sock table is (6 of 4000) 1% full
Assoc Buffer Space Used (16 KB of 800 KB) on LOC = 1305
```

```
ANAME a3
  LOC      1307          IPLNK PORT  A          LINK  A
  ADAPTER  SUA          VER      SUA RFC
  LHOST    gw103.nc.tekelec.com
  ALHOST    ---
  RHOST    gw106.nc.tekelec.com
  LPORT    3000          RPORT    2346
  ISTRMS   2            OSTRMS   2          BUFSIZE 16
  RMODE    LIN          RMIN     120         RMAX    800
  RTIMES   10          CWMIN    3000        UAPS    10
  OPEN     YES          ALW      YES

ASNAMES
as1
```

```
IP Appl Sock table is (6 of 4000) 1% full
Assoc Buffer Space Used (16 KB of 800 KB) on LOC = 1307
```

```
ANAME assoc1
  LOC      1305          IPLNK PORT  A          LINK  A
  ADAPTER  SUA          VER      SUA RFC
  LHOST    gw102.nc.tekelec.com
  ALHOST    ---
```

```
RHOST gw100.nc.tekelec.com
LPORT 4000 RPORT 1030
ISTRMS 2 OSTRMS 2 BUFSIZE 16
RMODE LIN RMIN 120 RMAX 800
RTIMES 10 CWMIN 3000 UAPS 10
OPEN YES ALW YES

ASNAMES
as1
```

IP Appl Sock table is (6 of 4000) 1% full
 Assoc Buffer Space Used (16 KB of 800 KB) on LOC = 1305

```
assoc7 1311 A A SUA 2500 2000 YES YES
ANAME assoc7
LOC 1311 IPLNK PORT A LINK A
ADAPTER SUA VER SUA RFC
LHOST gw105.nc.tekelec.com
ALHOST ---
RHOST gw100.nc.tekelec.com
LPORT 2500 RPORT 2000
ISTRMS 2 OSTRMS 2 BUFSIZE 16
RMODE LIN RMIN 120 RMAX 800
RTIMES 10 CWMIN 3000 UAPS 10
OPEN YES ALW YES

ASNAMES
as2
```

IP Appl Sock table is (6 of 4000) 1% full
 Assoc Buffer Space Used (16 KB of 800 KB) on LOC = 1311

If the desired association is shown in the **rtrv-*assoc*** output, see Flowchart 3-35 on page 3-416 (Sheet 4) for the rules that apply to the association and the new application server, go to step 4.

If the desired association is not shown in the **rtrv-*assoc*** output, perform the “Adding a New Association to a New Application Server” procedure on page 3-397 to add a new association to a new application server.

-
4. Display the sockets assigned to the local IP host value shown in either steps 2 or 3 by entering the **rtrv-*appl-sock*** command with the **lhost** parameter. For this example, enter this command.

rtrv-*appl-sock*:lhost=gw102.nc.tekelec.com

This is an example of the possible output.

```
rlghncxa03w 06-10-28 21:14:37 GMT EAGLE5 36.0.0
SNAME sock1
LINK A
LHOST gw102.nc.tekelec.com
RHOST remotehost1
LPORT 1024 RPORT 2048
SERVER YES DCMP5 10
REXMIT FIXED RTT 60
OPEN YES ALW YES
```

IP Appl Sock/Assoc table is (6 of 4000) 1% full

5. Display the associations assigned to the local IP host value specified in step 4 by entering the `rtrv-assoc` command with the `lhost` parameter. For this example, enter this command.

```
rtrv-assoc:lhost=gw102.nc.tekelec.com
```

This is an example of the possible output.

```
rlghncxa03w 06-10-28 21:14:37 GMT EAGLE5 36.0.0
CARD IPLNK
ANAME      LOC  PORT  LINK ADAPTER LPORT RPORT OPEN ALW
assoc1     1305 A    A    SUA    4000 1030 YES YES

IP Appl Sock/Assoc table is (5 of 4000) 1% full
Assoc Buffer Space Used (16 KB of 3200 KB) on LOC = 1305
```

6. Display the application servers that the associations shown in step 5 are assigned to by entering `rtrv-as` command with the names of the associations shown in step 5. For this example, enter this command.

```
rtrv-as:aname=assoc1
```

This is an example of the possible output.

```
rlghncxa03w 06-10-28 21:14:37 GMT EAGLE5 36.0.0
AS Name      Mode      Tr ms  Association Names
as1          LOADSHARE  10     assoc1
AS Table is (3 of 250) 1% full
```

The maximum number of TALI sockets and SCTP association to application server assignments that can be hosted by an IPGWx card (referenced by the `lhost` parameter of the socket and association) is 50.

If the number of TALI sockets and SCTP association to application server assignments is less than 50, go to step 7.

If the number of TALI sockets and SCTP association to application server assignments is 50, the association shown in either steps 2 or 3 cannot be used in this procedure. Go back to step 1 and choose another association to assign to the new application server.

NOTE: If the value of the `open` parameter of the association being assigned to the application server in step 5 is `no`, skip this step and go to step 8.

7. Change the value of the `open` parameter to `no` by specifying the `chg-assoc` command with the `open=no` parameter. For this example, enter this command.

```
chg-assoc:aname=assoc1:open=no
```

When this command has successfully completed, this message should appear.

```
rlghncxa03w 06-10-28 09:12:36 GMT EAGLE5 36.0.0
CHG-ASSOC: MASP A - COMPLTD;
```

8. Add the application server to the database with the name of the association shown in either steps 2 or 3 using the **ent-as** command. For this example, enter this command.

```
ent-as:asname=as4:aname=assoc1
```

This is an example of the possible outputs.

```
rlghncxa03w 06-10-28 09:12:36 GMT EAGLE5 36.0.0
ENT-AS: MASP A - COMPLTD;
```

9. Verify the changes using the **rtrv-as** command with the application server name specified in step 8. For this example, enter this command.

```
rtrv-as:asname=as4
```

This is an example of the possible output.

```
rlghncxa03w 06-10-28 09:12:36 GMT EAGLE5 36.0.0

AS Name           Mode           Tr ms   Association Names
as4                LOADSHARE     10      assoc1

AS table is (4 of 250) 1% full.
```

NOTE: If you do not wish to change the **open** parameter value of the association specified in step 8, skip step 10 and go to step 11.

10. Change the value of the **open** parameter to **yes** by specifying the **chg-assoc** command with the **open=yes** parameter. For this example, enter this command.

```
chg-assoc:aname=assoc1:open=yes
```

When this command has successfully completed, this message should appear.

```
rlghncxa03w 06-10-28 09:12:36 GMT EAGLE5 36.0.0
CHG-ASSOC: MASP A - COMPLTD;
```

11. Back up the new changes, using the **chg-db:action=backup:dest=fixed** command. These messages should appear; the active Maintenance and Administration Subsystem Processor (MASP) appears first.

```
BACKUP (FIXED) : MASP A - Backup starts on active MASP.
BACKUP (FIXED) : MASP A - Backup on active MASP to fixed disk complete.
BACKUP (FIXED) : MASP A - Backup starts on standby MASP.
BACKUP (FIXED) : MASP A - Backup on standby MASP to fixed disk complete.
```

Flowchart 3-35. Adding an Existing Association to a New Application Server
(Sheet 1 of 4)

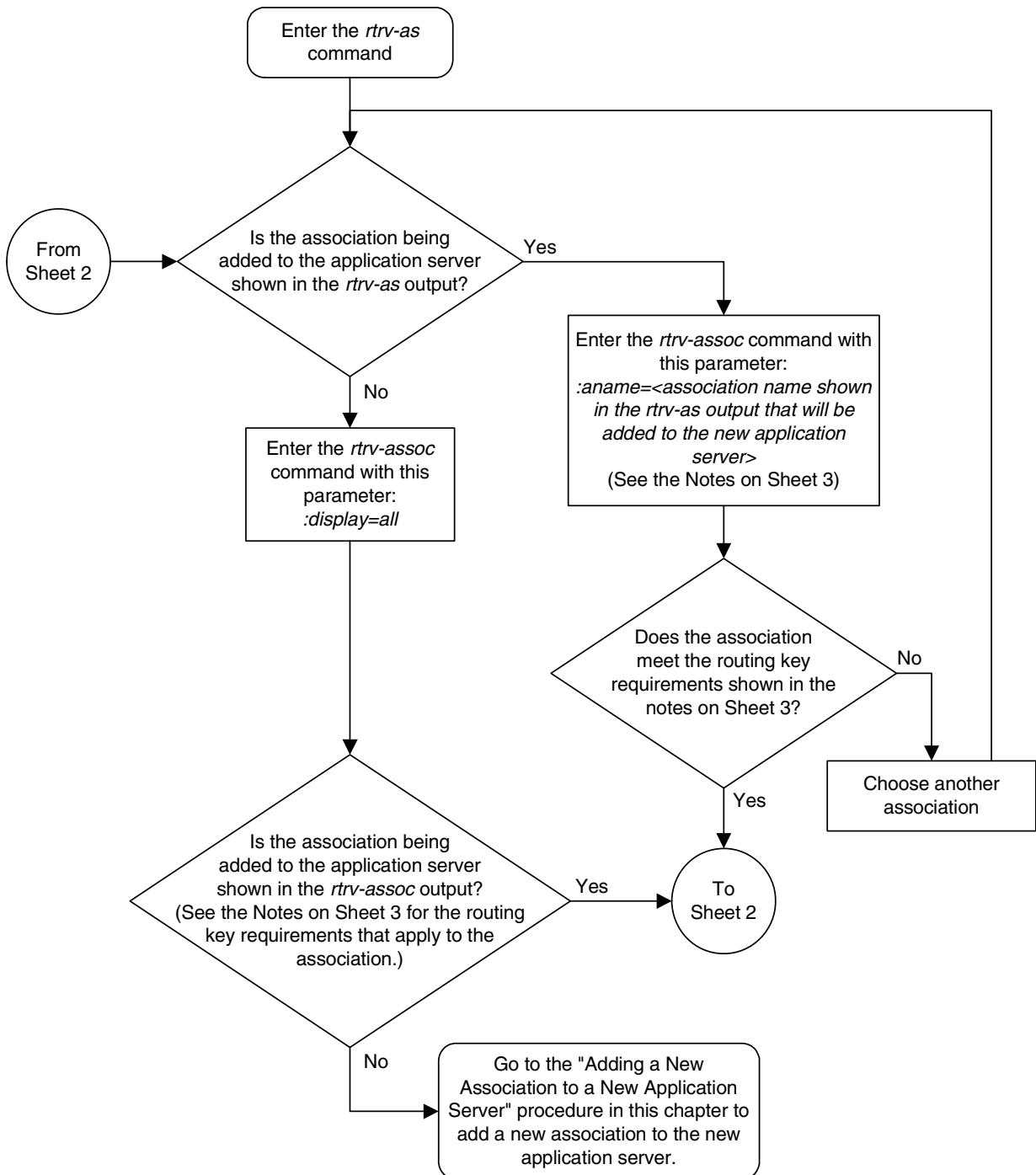

Flowchart 3-35. Adding an Existing Association to a New Application Server
(Sheet 2 of 4)

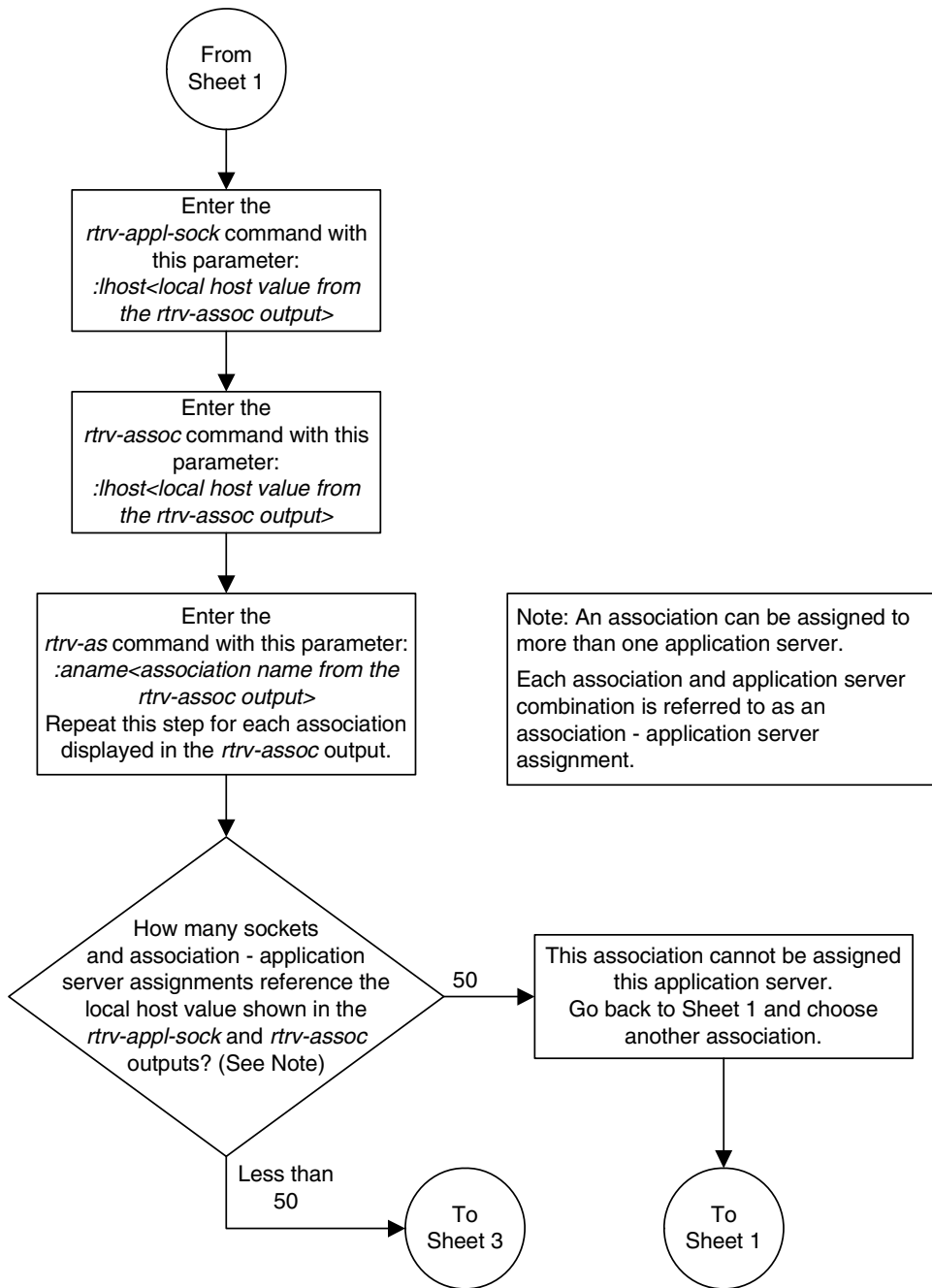

Flowchart 3-35. Adding an Existing Association to a New Application Server
(Sheet 3 of 4)

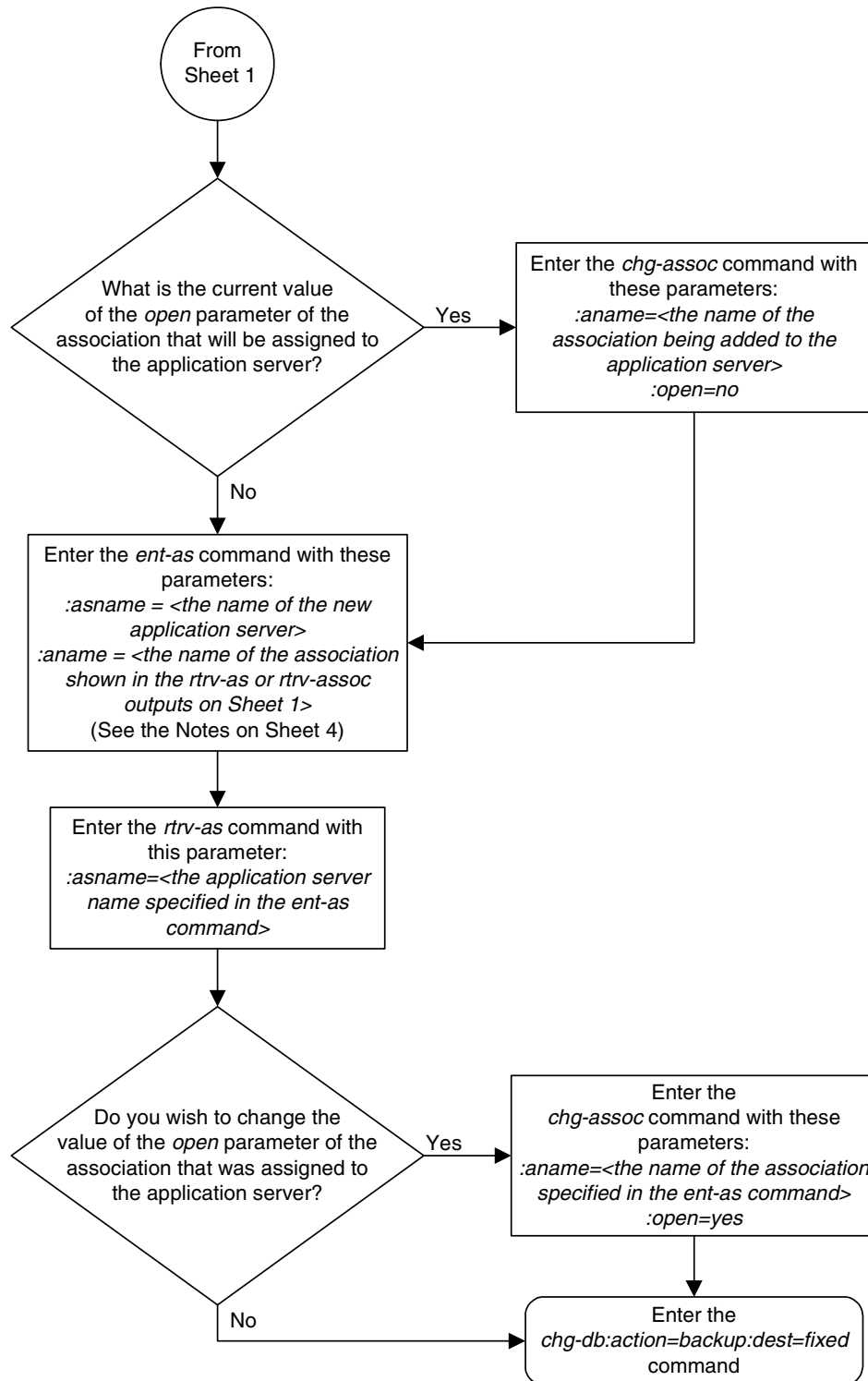

Flowchart 3-35. Adding an Existing Association to a New Application Server
(Sheet 4 of 4)

Notes:

1. If the application server is being added in this procedure will be assigned to a routing key containing a *rcontext* parameter value, the *adapter* parameter value for the association assigned to this application server can be either M3UA or SUA.

2. If the application server is being added in this procedure will be assigned to a routing key that does not contain a *rcontext* parameter value, the *adapter* parameter value for the association assigned to this application server must be M3UA.

3. SUA associations and their corresponding application server, can be assigned to only these types of routing keys:

Full routing key – DPC/SI=3/SSN

Partial routing key – DPC/SI=3

Partial routing key – DPC only

Partial routing key – SI=3 only

Default routing key.

The routing key containing the application server with the SUA associations must have an *rcontext* value assigned to it.

If the new application server will not be assigned to one of these types of routing keys, the *adapter* parameter value of the associations assigned to the application server must be M3UA.

4. M2PA associations cannot be assigned to application servers.

Adding a New Association to an Existing Application Server

This procedure is used assign a new association to an existing application server using the **ent-as** command.

The **ent-as** command uses these parameters:

:asname – The name of the new application server.

:aname – The name of the association being assigned to the application server.

The maximum number of TALI sockets and SCTP association to application server assignments that can be hosted by an IPGWx card (referenced by the **lhost** parameter of the socket and association) is 50. For example, if the IPGWx card contains 12 TALI sockets, the maximum number of SCTP association to application server assignments that the IPGWx card can support is 38. The SCTP association to application server assignments could be one SCTP association assigned to 38 application servers, two SCTP associations assigned to 19 application servers, or any combination of SCTP associations assigned to application servers that add up to 38. The number of TALI sockets can be verified with the **rtrv-appl-sock:lhost=<local host name>** command. The SCTP association to application server assignments can be verified with the **rtrv-assoc:lhost=<local host name>** and **rtrv-as:aname=<association name>** commands.

Table 3-34. Examples of IPGWx Card Provisioning Limits

| Number of Associations hosted by the IPGWx card | Number of Application Servers each Association is Assigned to * | Number of TALI Sockets Hosted by the IPGWx card | Total Association - Application Server Assignments and TALI Sockets maintained by the IPGWx card |
|---|---|---|--|
| 1 | 50 | 0 | 50 |
| 50 | 1 | 0 | 50 |
| 25 | 1 | 25 | 50 |
| 25 | 2 | 0 | 50 |
| 0 | 0 | 50 | 50 |
| 38 | 1 | 12 | 50 |
| 19 | 2 | 12 | 50 |

* The EAGLE 5 ISS can contain a maximum of 250 application servers.

A maximum of 16 associations can be assigned to an application server.

The **open** parameter of the association must be set to **no** before the association can be assigned to the application server. This can be verified with the **rtrv-assoc** command.

M2PA associations (**adapter=m2pa**) cannot be assigned to application servers. Only M3UA (**adapter=m3ua**) and SUA (**adapter=sua**) associations can be

assigned to application servers. This can be verified in the **ADAPTER** field in the **rtrv-assoc** output.

The application running on the card hosting the association that will be assigned to the application server must be the same as the application running on the cards hosting the other associations assigned to the application server.

Canceling the RTRV-AS, RTRV-APPL-SOCK, and RTRV-ASSOC Commands

Because the **rtrv-as**, **rtrv-appl-sock**, and **rtrv-assoc** commands used in this procedure can output information for a long period of time, the **rtrv-as**, **rtrv-appl-sock**, and **rtrv-assoc** commands can be canceled and the output to the terminal stopped. There are three ways that the **rtrv-as**, **rtrv-appl-sock**, and **rtrv-assoc** commands can be canceled.

- Press the **F9** function key on the keyboard at the terminal where the **rtrv-as**, **rtrv-appl-sock**, or **rtrv-assoc** commands were entered.
- Enter the **canc-cmd** without the **trm** parameter at the terminal where the **rtrv-as**, **rtrv-appl-sock**, or **rtrv-assoc** commands were entered.
- Enter the **canc-cmd:trm=<xx>**, where **<xx>** is the terminal where the **rtrv-as**, **rtrv-appl-sock**, or **rtrv-assoc** commands were entered, from another terminal other than the terminal where the **rtrv-as**, **rtrv-appl-sock**, or **rtrv-assoc** commands were entered. To enter the **canc-cmd:trm=<xx>** command, the terminal must allow Security Administration commands to be entered from it and the user must be allowed to enter Security Administration commands. The terminal's permissions can be verified with the **rtrv-secu-trm** command. The user's permissions can be verified with the **rtrv-user** or **rtrv-secu-user** commands.

For more information about the **canc-cmd** command, go to the *Commands Manual*.

Procedure

1. Display the application servers in the database using the **rtrv-as** command. This is an example of possible output.

```
rlghncxa03w 06-10-28 09:12:36 GMT EAGLE5 36.0.0

AS Name           Mode           Tr ms   Association Names
as1                LOADSHARE     10      assoc1
                  LOADSHARE     10      assoc2
                  LOADSHARE     10      assoc3
                  LOADSHARE     10      assoc5
                  LOADSHARE     10      assoc6
as2                OVERRIDE      10      assoc7

AS table is (2 of 250) 1% full.
```

2. Display the application server that the new association will be added to by entering the `rtrv-as` command with the name of the application server. For this example, enter this command.

```
rtrv-as:asname=as2
```

This is an example of possible output.

```
rlghncxa03w 06-10-28 09:12:36 GMT EAGLE5 36.0.0
```

| AS Name | Mode | Tr ms | Association Names |
|---------|----------|-------|-------------------|
| as2 | OVERRIDE | 10 | assoc7 |

```
AS table is (2 of 250) 1% full.
```

A maximum of 16 associations can be assigned to an application server. If the application server displayed in this step contains less than 16 associations, go to step 3.

If the application server displayed in this step contains 16 associations, either select another application server to use in this procedure and repeat this step, or perform the “Adding a New Association to a New Application Server” procedure on page 3-397 to add the new association to a new application server.

3. Display the one of the associations assigned to the application server shown in step 2 using the `rtrv-assoc` command and specifying the association name shown in the `rtrv-as` output from step 2. For this example, enter this command.

```
rtrv-assoc:aname=assoc7
```

This is an example of possible output.

```
rlghncxa03w 06-10-28 09:12:36 GMT EAGLE5 36.0.0
```

```
ANAME assoc7
```

| | | | | | |
|---------|----------------------|------------|---------|---------|-----|
| LOC | 1203 | IPLNK PORT | A | LINK | A |
| ADAPTER | SUA | VER | SUA RFC | | |
| LHOST | gw105.nc.tekelec.com | | | | |
| ALHOST | --- | | | | |
| RHOST | gw100.nc.tekelec.com | | | | |
| LPORT | 1030 | RPORT | 1030 | | |
| ISTRMS | 2 | OSTRMS | 2 | BUFSIZE | 16 |
| RMODE | LIN | RMIN | 120 | RMAX | 800 |
| RTIMES | 10 | CWMIN | 3000 | UAPS | 10 |
| OPEN | YES | ALW | YES | | |

```
ASNAMES
as2
```

```
IP Appl Sock table is (7 of 4000) 1% full
```

```
Assoc Buffer Space Used (16 KB of 800 KB) on LOC = 1203
```

The **adapter** parameter value of all the associations assigned to an application server must be the same. This step identifies the **adapter** value of the associations assigned to the application server.

The application running on the card hosting the new association must be the same as the application on the cards hosting the associations assigned to the application server.

-
4. Display the signaling link assigned to the card, shown in step 3 by entering the `rtrv-slk` command with the card location of the signaling link shown in step 3. For this example, enter this command.

```
rtrv-slk:loc=1203
```

The following is an example of the possible output.

```
rlghncxa03w 06-10-28 21:19:37 GMT EAGLE5 36.0.0
```

| LOC | LINK | LSN | SLC | TYPE |
|------|------|------|-----|---------|
| 1203 | A | lsn5 | 1 | SS7IPGW |

The application running on the card is shown in the **TYPE** column of the `rtrv-slk` output.

For this example, the new association must be assigned to a card running the **SS7IPGW** application.

NOTE: If the local host value shown in step 3 will be assigned to the new association, skip steps 5, 6, and 7, and go to step 8.

NOTE: If another local host value will be assigned to the new association, perform to step 5.

5. Display the IP host names in the database by using the `rtrv-ip-host` command. The following is an example of the possible output.

```
rlghncxa03w 06-10-28 21:15:37 GMT EAGLE5 36.0.0
```

| LOCAL IPADDR | LOCAL HOST |
|--------------|----------------------|
| 192.1.1.10 | IPNODE1-1201 |
| 192.1.1.12 | GW105.NC.TEKELEC.COM |
| 192.1.1.14 | IPNODE1-1205 |
| 192.1.1.20 | IPNODE2-1201 |
| 192.1.1.22 | IPNODE2-1203 |
| 192.1.1.24 | IPNODE2-1205 |
| 192.1.1.30 | KC-HLR1 |
| 192.1.1.32 | KC-HLR2 |
| 192.1.1.50 | DN-MS1 |
| 192.1.1.52 | DN-MS2 |

| REMOTE IPADDR | REMOTE HOST |
|---------------|--|
| 150.1.1.5 | NCDEPTECONOMIC_DEVELOPMENT.SOUTHEASTERN_COORIDOR_ASHVL.GOV |

```
IP Host table is (11 of 512) 2% full
```

If the local IP host name for the new association is not shown in the **LOCAL HOST** column of the `rtrv-ip-host` output, add the new IP host name by performing the “Adding an IP Host” procedure on page 3-153. The new local IP host must be assigned to a card running the application shown in step 4.

After the new local IP host has been added, skip steps 6 through 9, and go to step 10.

If the local IP host name for the new association is shown in the **LOCAL HOST** column of the **rtrv-ip-host** output, go to step 8.

6. Display the IP links in the database by entering the **rtrv-ip-lnk** command. The following is an example of the possible output.

```
rlghncxa03w 06-10-28 21:19:37 GMT EAGLE5 36.0.0
LOC  PORT IPADDR          SUBMASK          DUPLEX  SPEED MACTYPE AUTO MCAST
1201 A    192.1.1.10             255.255.255.0   ----   ---   DIX     YES  NO
1203 A    192.1.1.12             255.255.255.0   ----   ---   DIX     YES  NO
1205 A    192.1.1.14             255.255.255.0   FULL   100   DIX     NO   NO
```

7. Display the signaling link assigned to the card, shown in step 6, whose IP address is assigned to the local host shown in step 5 by entering the **rtrv-slk** command with the card location of the signaling link. For this example, enter this command.

```
rtrv-slk:loc=1205
```

The following is an example of the possible output.

```
rlghncxa03w 06-10-28 21:19:37 GMT EAGLE5 36.0.0

LOC  LINK LSN          SLC TYPE
1205 A  lsn5          1  SS7IPGW
```

The application running on the card is shown in the **TYPE** column of the **rtrv-slk** output.

For this example, the new association must be assigned to a card running the **SS7IPGW** application.

If the card's application shown in this step and in step 4 are the same, go to step 8.

If the card's application shown in this step and in step 4 are not the same, either repeat this procedure from step 5 with another local IP host, or add the new local IP host name by performing the "Adding an IP Host" procedure on page 3-153. The new local IP host must be assigned to a card running the application shown in step 4. After the new local IP host has been added, skip steps 8 and 9, and go to step 10.

8. Display the sockets assigned to the local IP host value that will be assigned to the new association by entering the **rtrv-appl-sock** command with the **lhost** parameter. For this example, enter this command.

```
rtrv-appl-sock:lhost=IPNODE-1205
```

This is an example of the possible output.

```
rlghncxa03w 06-10-28 21:14:37 GMT EAGLE5 36.0.0
SNAME sock1
      LINK      A
      LHOST     IPNODE-1205
```

```

RHOST    remotehost1
LPORT    1024          RPORT    2048
SERVER   YES          DCMPS   10
REXMIT   FIXED       RTT     60
OPEN     YES          ALW     YES
IP Appl Sock/Assoc table is (7 of 4000) 1% full

```

9. Display the associations assigned to the local IP host value specified in step 8 by entering the **rtrv-assoc** command with the **lhost** parameter. For this example, enter this command.

```
rtrv-assoc:lhost=IPNODE-1205
```

This is an example of the possible output.

```

rlghncxa03w 06-10-28 21:14:37 GMT EAGLE5 36.0.0
                CARD IPLNK
ANAME          LOC  PORT  LINK ADAPTER LPORT RPORT OPEN ALW
assoc1         1205 A    A    M3UA    1030 1030 YES YES
IP Appl Sock/Assoc table is (7 of 4000) 1% full
Assoc Buffer Space Used (16 KB of 3200 KB) on LOC = 1205

```

10. Display the application servers that the associations shown in step 9 are assigned to by entering **rtrv-as** command with the names of the associations shown in step 9. For this example, enter this command.

```
rtrv-as:aname=assoc1
```

This is an example of the possible output.

```

rlghncxa03w 06-10-28 21:14:37 GMT EAGLE5 36.0.0
AS Name      Mode      Tr ms  Association Names
as1          LOADSHARE 10     assoc1
AS Table is (2 of 250) 1% full

```

The maximum number of TALI sockets and SCTP association to application server assignments that can be hosted by an IPGWx card (referenced by the **lhost** parameter of the socket and association) is 50.

If the number of TALI sockets and SCTP association to application server assignments is less than 50, go to step 11.

If the number of TALI sockets and SCTP association to application server assignments is 50, either repeat this procedure from step 5 with another local IP host, or add the new local IP host name by performing the “Adding an IP Host” procedure on page 3-153. The new local IP host must be assigned to a card running the application shown in steps 4 and 7. After the new local IP host has been added, go to step 11.

11. Add the new association by performing the “Adding an Association” procedure on page 3-327. The **open** parameter value for this association must be set to **no**. The adapter value for this association must be the same as the adapter value shown in step 3.

NOTE: See Flowchart 3-36 on page 3-428 (Sheet 5) for the rules that apply to the new association and the application server.

12. Add the association to the application server using the **ent-as** command with the name of the application server specified in step 2 and the name of the new association. For this example, enter this command

```
ent-as:aname=as2:aname=assoc10
```

This is an example of possible output.

```
rlghncxa03w 06-10-28 09:12:36 GMT EAGLE5 36.0.0
ENT-AS: MASP A - COMPLTD;
```

13. Verify the changes using the **rtrv-as** command with the name of the application server specified in step 12. For this example, enter this command

```
rtrv-as:aname=as2
```

This is an example of possible output.

```
rlghncxa03w 06-10-28 09:12:36 GMT EAGLE5 36.0.0

AS Name           Mode           Tr ms   Association Names
as2                OVERRIDE      10      assoc7
                  assoc10

AS table is (2 of 250) 1% full.
```

NOTE: If you do not wish to change the **open** parameter value of the association specified in step 12, skip step 14 and go to step 15.

14. Change the value of the **open** parameter to **yes** by specifying the **chg-assoc** command with the **open=yes** parameter. For this example, enter this command.

```
chg-assoc:aname=assoc10:open=yes
```

When this command has successfully completed, this message should appear.

```
rlghncxa03w 06-10-28 09:12:36 GMT EAGLE5 36.0.0
CHG-ASSOC: MASP A - COMPLTD;
```

15. Back up the new changes, using the **chg-db:action=backup:dest=fixed** command. These messages should appear; the active Maintenance and Administration Subsystem Processor (MASP) appears first.

```
BACKUP (FIXED) : MASP A - Backup starts on active MASP.
BACKUP (FIXED) : MASP A - Backup on active MASP to fixed disk complete.
BACKUP (FIXED) : MASP A - Backup starts on standby MASP.
BACKUP (FIXED) : MASP A - Backup on standby MASP to fixed disk complete.
```

Flowchart 3-36. Adding a New Association to an Existing Application Server
(Sheet 1 of 5)

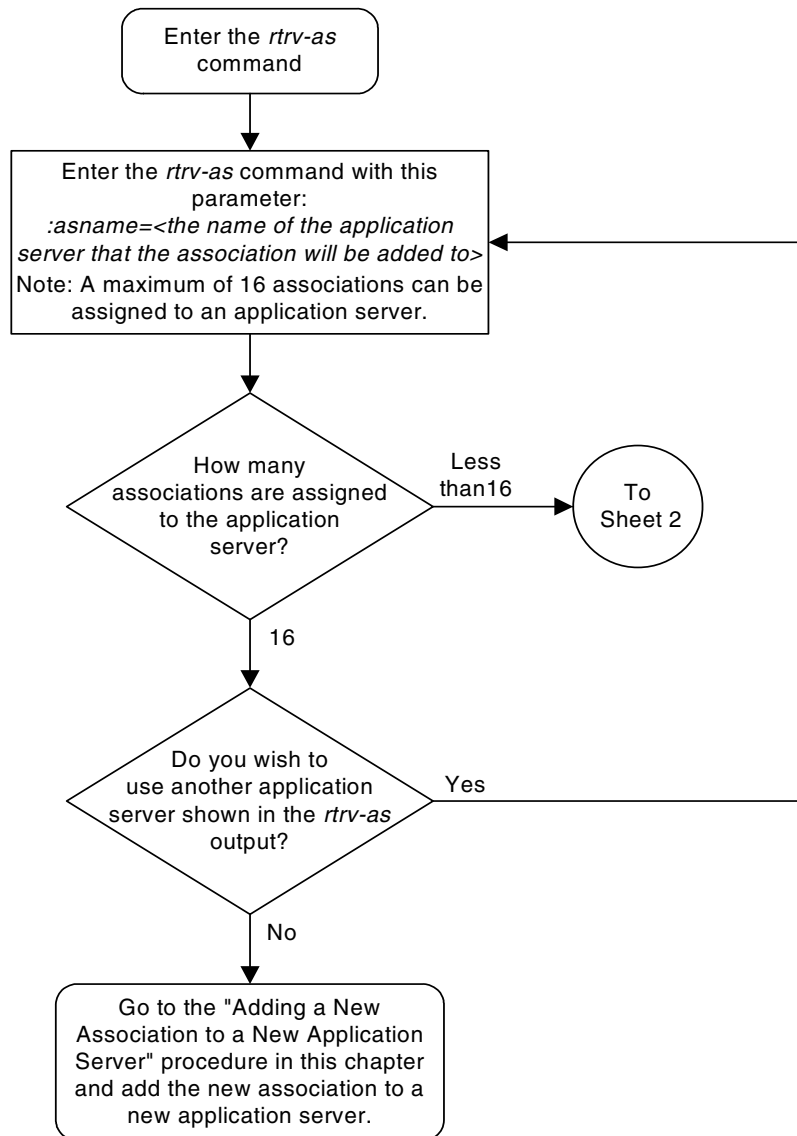

Flowchart 3-36. Adding a New Association to an Existing Application Server
(Sheet 2 of 5)

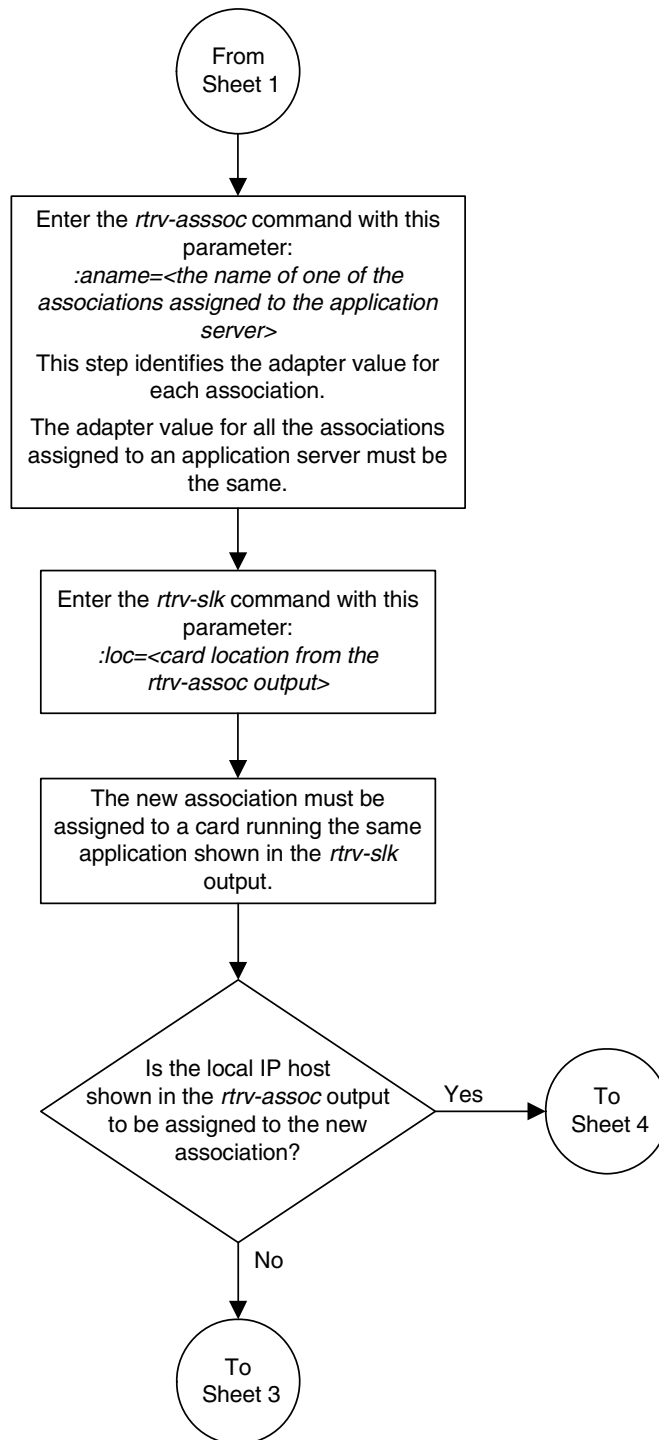

Flowchart 3-36. Adding a New Association to an Existing Application Server
(Sheet 3 of 5)

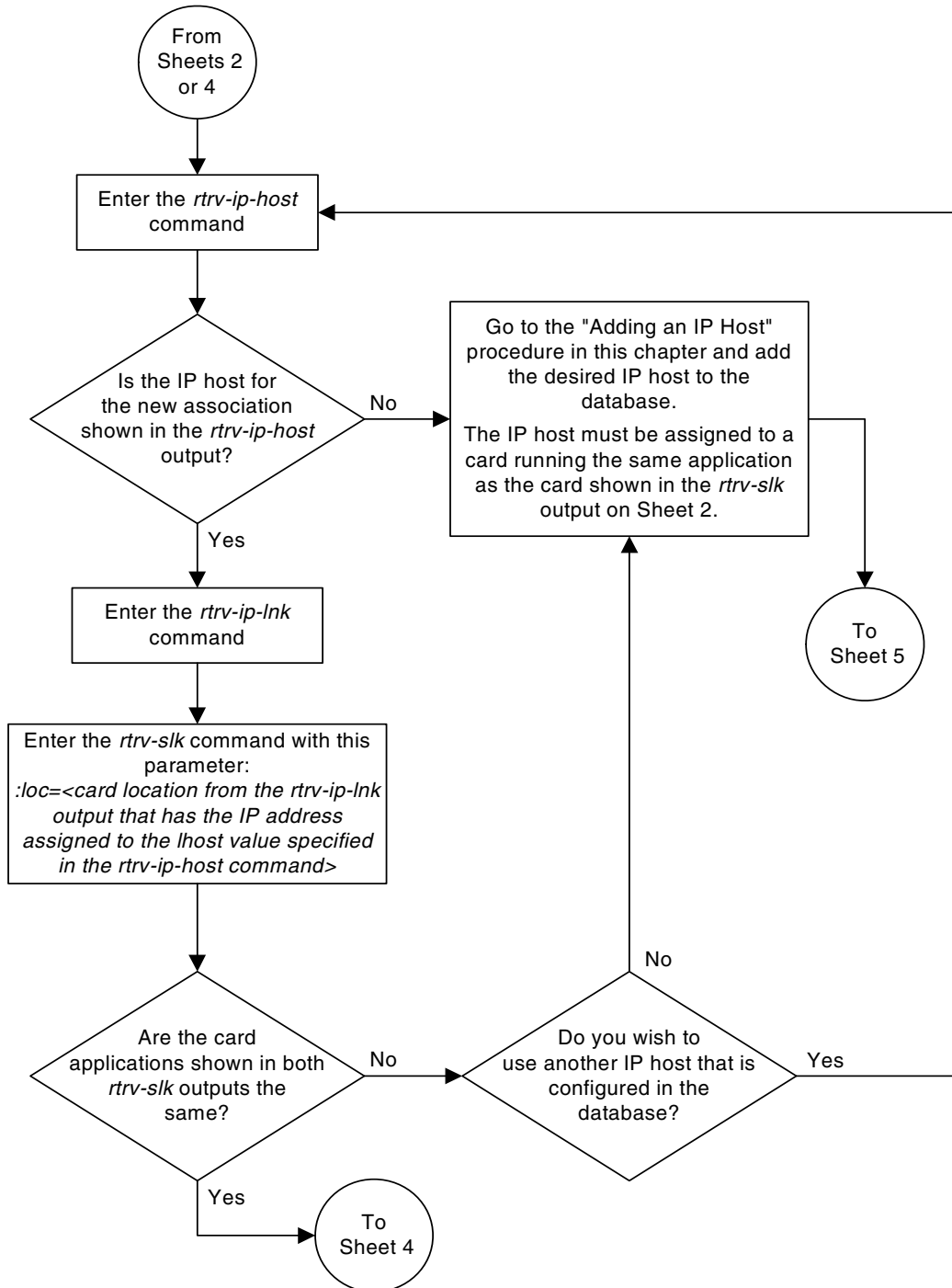

Flowchart 3-36. Adding a New Association to an Existing Application Server
(Sheet 4 of 5)

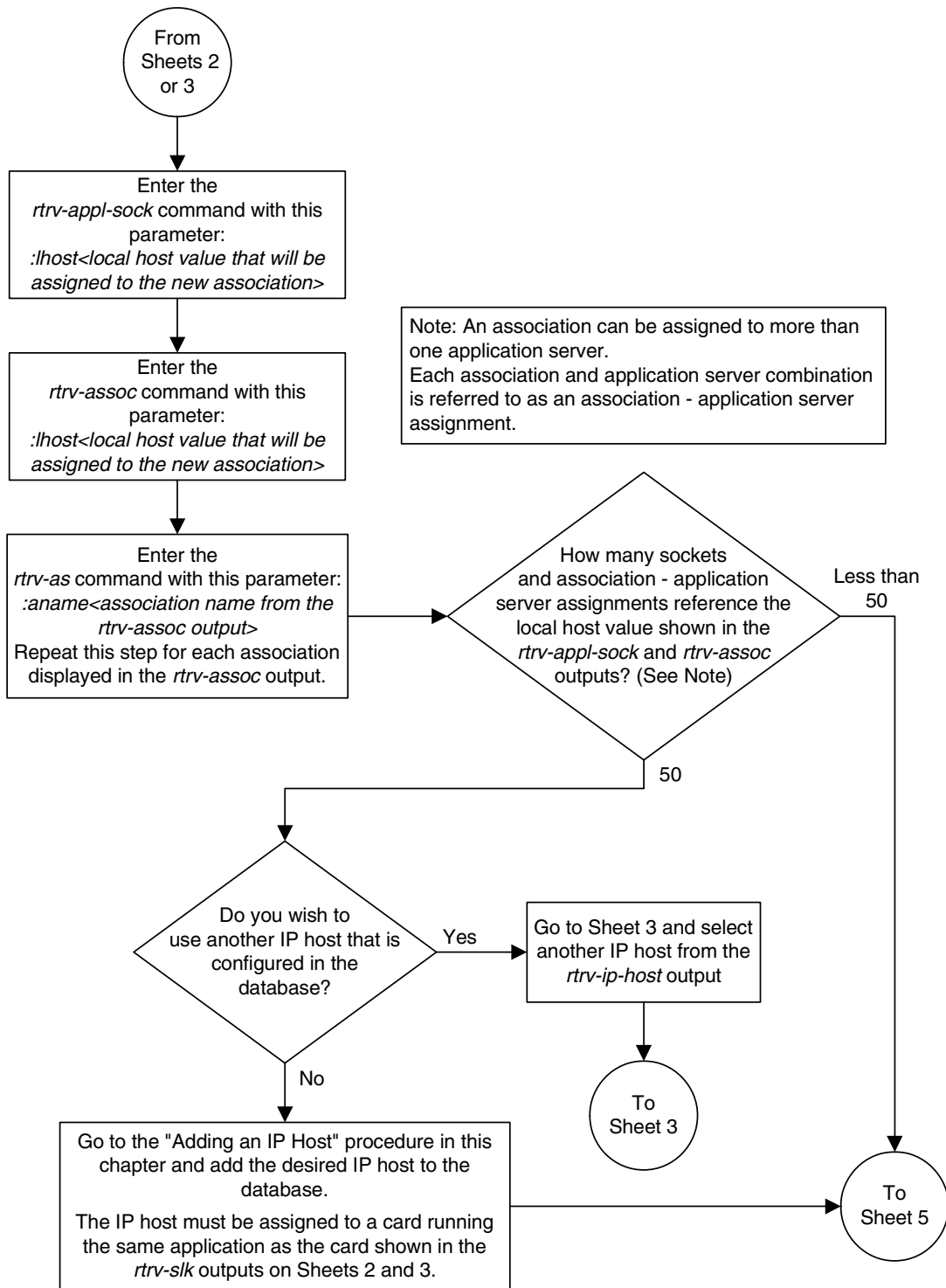

Flowchart 3-36. Adding a New Association to an Existing Application Server
(Sheet 5 of 5)

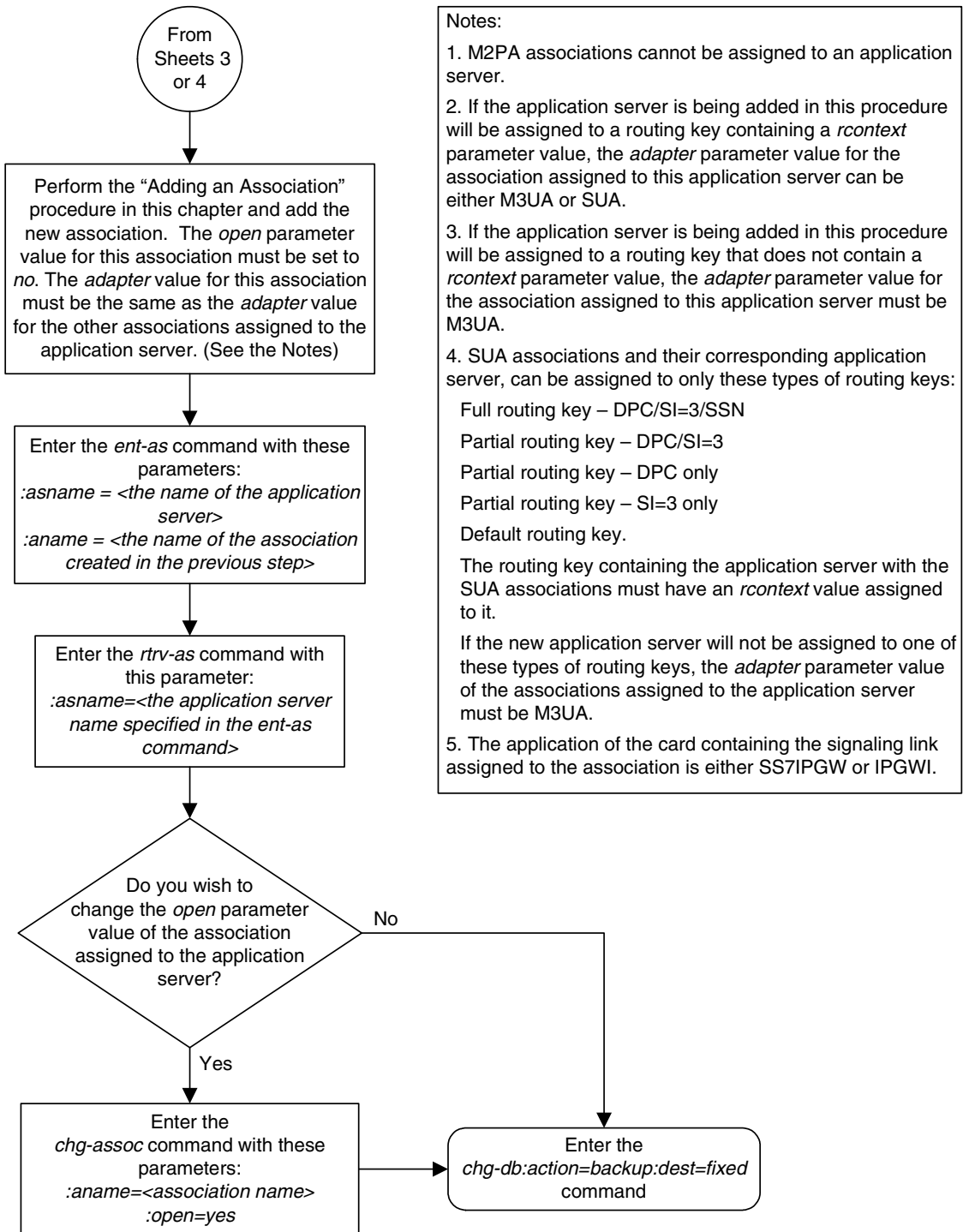

Adding an Existing Association to an Existing Application Server

This procedure is used assign an existing association to an existing application server using the `ent-as` command.

The `ent-as` command uses these parameters:

`:asname` – The name of the application server.

`:aname` – The name of the association being assigned to the application server.

The maximum number of TALI sockets and SCTP association to application server assignments that can be hosted by an IPGWx card (referenced by the `lhost` parameter of the socket and association) is 50. For example, if the IPGWx card contains 12 TALI sockets, the maximum number of SCTP association to application server assignments that the IPGWx card can support is 38. The SCTP association to application server assignments could be one SCTP association assigned to 38 application servers, two SCTP associations assigned to 19 application servers, or any combination of SCTP associations assigned to application servers that add up to 38. The number of TALI sockets can be verified with the `rtrv-appl-sock:lhost=<local host name>` command. The SCTP association to application server assignments can be verified with the `rtrv-assoc:lhost=<local host name>` command.

Table 3-35. Examples of IPGWx Card Provisioning Limits

| Number of Associations hosted by the IPGWx card | Number of Application Servers each Association is Assigned to * | Number of TALI Sockets Hosted by the IPGWx card | Total Association - Application Server Assignments and TALI Sockets maintained by the IPGWx card |
|---|---|---|--|
| 1 | 50 | 0 | 50 |
| 50 | 1 | 0 | 50 |
| 25 | 1 | 25 | 50 |
| 25 | 2 | 0 | 50 |
| 0 | 0 | 50 | 50 |
| 38 | 1 | 12 | 50 |
| 19 | 2 | 12 | 50 |

* The EAGLE 5 ISS can contain a maximum of 250 application servers.

A maximum of 16 associations can be assigned to an application server.

The `open` parameter of the association must be set to `no` before the association can be assigned to the application server. This can be verified with the `rtrv-assoc` command.

M2PA associations (`adapter=m2pa`) cannot be assigned to application servers. Only M3UA (`adapter=m3ua`) and SUA (`adapter=sua`) associations can be

assigned to application servers. This can be verified in the **ADAPTER** field in the **rtrv-assoc** output.

The application running on the card hosting the association that will be assigned to the application server must be the same as the application running on the cards hosting the other associations assigned to the application server.

Canceling the RTRV-AS, RTRV-APPL-SOCK, and RTRV-ASSOC Commands

Because the **rtrv-as**, **rtrv-appl-sock**, and **rtrv-assoc** commands used in this procedure can output information for a long period of time, the **rtrv-as**, **rtrv-appl-sock**, and **rtrv-assoc** commands can be canceled and the output to the terminal stopped. There are three ways that the **rtrv-as**, **rtrv-appl-sock**, and **rtrv-assoc** commands can be canceled.

- Press the **F9** function key on the keyboard at the terminal where the **rtrv-as**, **rtrv-appl-sock**, or **rtrv-assoc** commands were entered.
- Enter the **canc-cmd** without the **trm** parameter at the terminal where the **rtrv-as**, **rtrv-appl-sock**, or **rtrv-assoc** commands were entered.
- Enter the **canc-cmd:trm=<xx>**, where **<xx>** is the terminal where the **rtrv-as**, **rtrv-appl-sock**, or **rtrv-assoc** commands were entered, from another terminal other than the terminal where the **rtrv-as**, **rtrv-appl-sock**, or **rtrv-assoc** commands were entered. To enter the **canc-cmd:trm=<xx>** command, the terminal must allow Security Administration commands to be entered from it and the user must be allowed to enter Security Administration commands. The terminal's permissions can be verified with the **rtrv-secu-trm** command. The user's permissions can be verified with the **rtrv-user** or **rtrv-secu-user** commands.

For more information about the **canc-cmd** command, go to the *Commands Manual*.

Procedure

1. Display the application servers in the database using the **rtrv-as** command. This is an example of possible output.

```
rlghncxa03w 06-10-28 09:12:36 GMT EAGLE5 36.0.0

AS Name           Mode           Tr ms          Association Names
as1                LOADSHARE      10             a2
                  a3
                  assoc1

as2                OVERRIDE       10             assoc7
as3                OVERRIDE       10             swbel32

AS table is (3 of 250) 1% full.
```

2. Display the application server that the new association will be added to by entering the `rtrv-as` command with the name of the application server. For this example, enter this command.

```
rtrv-as:asname=as2
```

This is an example of possible output.

```
rlghncxa03w 06-10-28 09:12:36 GMT EAGLE5 36.0.0

AS Name           Mode           Tr ms   Association Names
as2                OVERRIDE      10      assoc7

AS table is (3 of 250) 1% full.
```

A maximum of 16 associations can be assigned to an application server. If the application server displayed in this step contains less than 16 associations, go to step 3.

If the application server displayed in this step contains 16 associations, either select another application server to use in this procedure and repeat this step, or perform the “Adding an Existing Association to a New Application Server” procedure on page 3-406 to add the association to a new application server.

NOTE: If the association being added to the application server is shown in the `rtrv-as` output in step 1, skip step 3 and go to step 4.

3. Display the associations in the database using the `rtrv-assoc` command. This is an example of possible output.

```
rlghncxa03w 06-10-28 09:12:36 GMT EAGLE5 36.0.0

          CARD IPLNK
ANAME     LOC  PORT  LINK ADAPTER LPORT RPORT OPEN ALW
swbel32   1201 A    A   M3UA  1030  2345 YES  YES
a2        1305 A    A   SUA   2000  2345 YES  YES
a3        1307 A    A   SUA   3000  2346 YES  YES
assoc1    1305 A    A   SUA   4000  1030 YES  YES
assoc7    1305 A    A   SUA   4500  1030 YES  YES
```

If the association being added to the application server is shown in this step, go to step 4.

If the association being added to the application server is not shown in this step, perform the “Adding a New Association to an Existing Application Server” procedure on page 3-417 to add a new association to the application server.

4. Display one of the associations assigned to the application server shown in step 2 using the `rtrv-assoc` command and specifying the association name shown in the `rtrv-as` output from step 2 or in the `rtrv-assoc` output in step 3. For this example, enter this command.

```
rtrv-assoc:aname=assoc7
```

This is an example of possible output.

```
rlghncxa03w 06-10-28 09:12:36 GMT EAGLE5 36.0.0
```

```

ANAME assoc7
  LOC      1203          IPLNK PORT  A          LINK  A
  ADAPTER  SUA          VER          SUA RFC
  LHOST    gw105.nc.tekelec.com
  ALHOST   ---
  RHOST    gw100.nc.tekelec.com
  LPORT    4500          RPORT      1030
  ISTRMS   2            OSTRMS     2            BUFSIZE  16
  RMODE    LIN          RMIN        120          RMAX     800
  RTIMES   10          CWMIN       3000         UAPS     10
  OPEN     YES          ALW          YES

```

ASNAMES
as2

IP Appl Sock table is (6 of 4000) 1% full
Assoc Buffer Space Used (16 KB of 800 KB) on LOC = 1203

The **adapter** parameter value of all the associations assigned to an application server must be the same. This step identifies the **adapter** value of the associations assigned to the application server.

The application running on the card hosting the new association must be the same as the application on the cards hosting the associations assigned to the application server.

-
5. Display the signaling link assigned to the card, shown in step 4 by entering the **rtrv-slk** command with the card location of the signaling link. For this example, enter this command.

```
rtrv-slk:loc=1205
```

The following is an example of the possible output.

```

rlghncxa03w 06-10-28 21:19:37 GMT EAGLE5 36.0.0

LOC LINK LSN          SLC TYPE
1205 A   lsn5          1  SS7IPGW

```

The application running on the card is shown in the **TYPE** column of the **rtrv-slk** output.

For this example, the new association must be assigned to a card running the **SS7IPGW** application.

-
6. Display the association being added to the application server using the **rtrv-assoc** command and specifying the name of the association being added. For this example, enter this command.

```
rtrv-assoc:aname=assoc1
```

This is an example of possible output.

```

rlghncxa03w 06-10-28 09:12:36 GMT EAGLE5 36.0.0
ANAME assoc1
  LOC      1203          IPLNK PORT  A          LINK  A
  ADAPTER  SUA          VER          SUA RFC
  LHOST    gw101.nc.tekelec.com
  ALHOST   ---

```

IP7 Secure Gateway Configuration Procedures

```
RHOST      gw100.nc.tekelec.com
LPORT      4000          RPORT      1030
ISTRMS     2          OSTRMS     2          BUFSIZE   16
RMODE      LIN        RMIN       120         RMAX      800
RTIMES     10        CWMIN      3000       UAPS      10
OPEN       YES        ALW        YES
```

ASNAMES
asl

```
IP Appl Sock table is (6 of 4000) 1% full
Assoc Buffer Space Used (16 KB of 800 KB) on LOC = 1203
```

If the local host and **adapter** values shown in this step are the same as the local host and **adapter** values shown in step 4, skip step 7 and go to step 8.

If the **adapter** value shown in this step is not the same as the **adapter** value shown in step 4, repeat this procedure from step 3.

If the local host value shown in this step is not the same as the local host value shown in step 4, but the **adapter** value shown in this step is the same as the **adapter** values shown in step 4, go to step 7.

-
7. Display the signaling link assigned to the card, shown in step 6 by entering the **rtrv-slk** command with the card location of the signaling link. For this example, enter this command.

```
rtrv-slk:loc=1201
```

The following is an example of the possible output.

```
rlghncxa03w 06-10-28 21:19:37 GMT EAGLE5 36.0.0

LOC LINK LSN          SLC TYPE
1201 A  lsn1          0  SS7IPGW
```

The application running on the card is shown in the **TYPE** column of the **rtrv-slk** output.

For this example, the association being added to the application server must be assigned to a card running the **SS7IPGW** application.

If the card applications shown in this step and in step 5 are the same, go to step 8.

If the card applications shown in this step and in step 5 are not the same, repeat this procedure from step 3.

8. Display the sockets assigned to the local IP host value of the association that will be assigned to the application server by entering the `rtrv-appl-sock` command with the `lhost` parameter. For this example, enter this command.

```
rtrv-appl-sock:lhost=gw101.nc.tekelec.com
```

This is an example of the possible output.

```
rlghncxa03w 06-10-28 21:14:37 GMT EAGLE5 36.0.0
SNAME sock1
  LINK      A
  LHOST     gw101.nc.tekelec.com
  RHOST     remotehost1
  LPORT     1024          RPORT      2048
  SERVER    YES           DCMPS      10
  REXMIT    FIXED        RTT         60
  OPEN      YES           ALW         YES
IP Appl Sock/Assoc table is (6 of 4000) 1% full
```

9. Display the associations assigned to the local IP host value specified in step 8 by entering the `rtrv-assoc` command with the `lhost` parameter. For this example, enter this command.

```
rtrv-assoc:lhost=gw101.nc.tekelec.com
```

This is an example of the possible output.

```
rlghncxa03w 06-10-28 21:14:37 GMT EAGLE5 36.0.0
          CARD IPLNK
ANAME      LOC  PORT  LINK ADAPTER LPORT RPORT OPEN ALW
assoc1     1203 A    A    SUA    4000 1030 YES  YES
IP Appl Sock/Assoc table is (6 of 4000) 1% full
Assoc Buffer Space Used (16 KB of 3200 KB) on LOC = 1203
```

10. Display the application servers that the associations shown in step 9 are assigned to by entering `rtrv-as` command with the names of the associations shown in step 9. For this example, enter this command.

```
rtrv-as:aname=assoc1
```

This is an example of the possible output.

```
rlghncxa03w 06-10-28 21:14:37 GMT EAGLE5 36.0.0
AS Name      Mode          Tr ms  Association Names
as1          LOADSHARE     10     assoc1
AS Table is (3 of 250) 1% full
```

The maximum number of TALI sockets and SCTP association to application server assignments that can be hosted by an IPGWx card (referenced by the `lhost` parameter of the socket and association) is 50.

If the number of TALI sockets and SCTP association to application server assignments is less than 50, go to step 11.

If the number of TALI sockets and SCTP association to application server assignments is 50, either repeat this procedure from step 3, or perform the “Adding a New Association to an Existing Application Server” procedure on page 3-417 to add a new association to this application server.

NOTE: If the value of the `open` parameter shown in step 6 is `no`, skip this step and go to step 12.

11. Change the value of the `open` parameter to `no` by specifying the `chg-assoc` command with the `open=no` parameter. For this example, enter this command.

```
chg-assoc : aname=assoc1 : open=no
```

When this command has successfully completed, this message should appear.

```
rlghncxa03w 06-10-28 09:12:36 GMT EAGLE5 36.0.0
CHG-ASSOC: MASP A - COMPLTD;
```

12. Add the association to the application server using the `ent-as` command. For this example, enter this command

```
ent-as : asname=as2 : aname=assoc1
```

This is an example of possible output.

```
rlghncxa03w 06-10-28 09:12:36 GMT EAGLE5 36.0.0
ENT-AS: MASP A - COMPLTD;
```

13. Verify the changes using the `rtrv-as` command with the application server name specified in step 12. For this example, enter this command.

```
rtrv-as : asname=as2
```

This is an example of possible output.

```
rlghncxa03w 06-10-28 09:12:36 GMT EAGLE5 36.0.0

AS Name           Mode           Tr ms   Association Names
as2                OVERRIDE      10      assoc1
                  assoc7

AS table is (3 of 250) 1% full.
```

NOTE: If you do not wish to change the `open` parameter value of the association specified in step 12, skip step 14 and go to step 15.

14. Change the value of the `open` parameter to `yes` by specifying the `chg-assoc` command with the `open=yes` parameter. For this example, enter this command.

```
chg-assoc : aname=assoc1 : open=yes
```

When this command has successfully completed, this message should appear.

```
rlghncxa03w 06-10-28 09:12:36 GMT EAGLE5 36.0.0
CHG-ASSOC: MASP A - COMPLTD;
```

15. Back up the new changes, using the `chg-db:action=backup:dest=fixed` command. These messages should appear; the active Maintenance and Administration Subsystem Processor (MASP) appears first.

```
BACKUP (FIXED) : MASP A - Backup starts on active MASP.
BACKUP (FIXED) : MASP A - Backup on active MASP to fixed disk complete.
BACKUP (FIXED) : MASP A - Backup starts on standby MASP.
BACKUP (FIXED) : MASP A - Backup on standby MASP to fixed disk complete.
```

Flowchart 3-37. Adding an Existing Association to an Existing Application Server (Sheet 1 of 5)

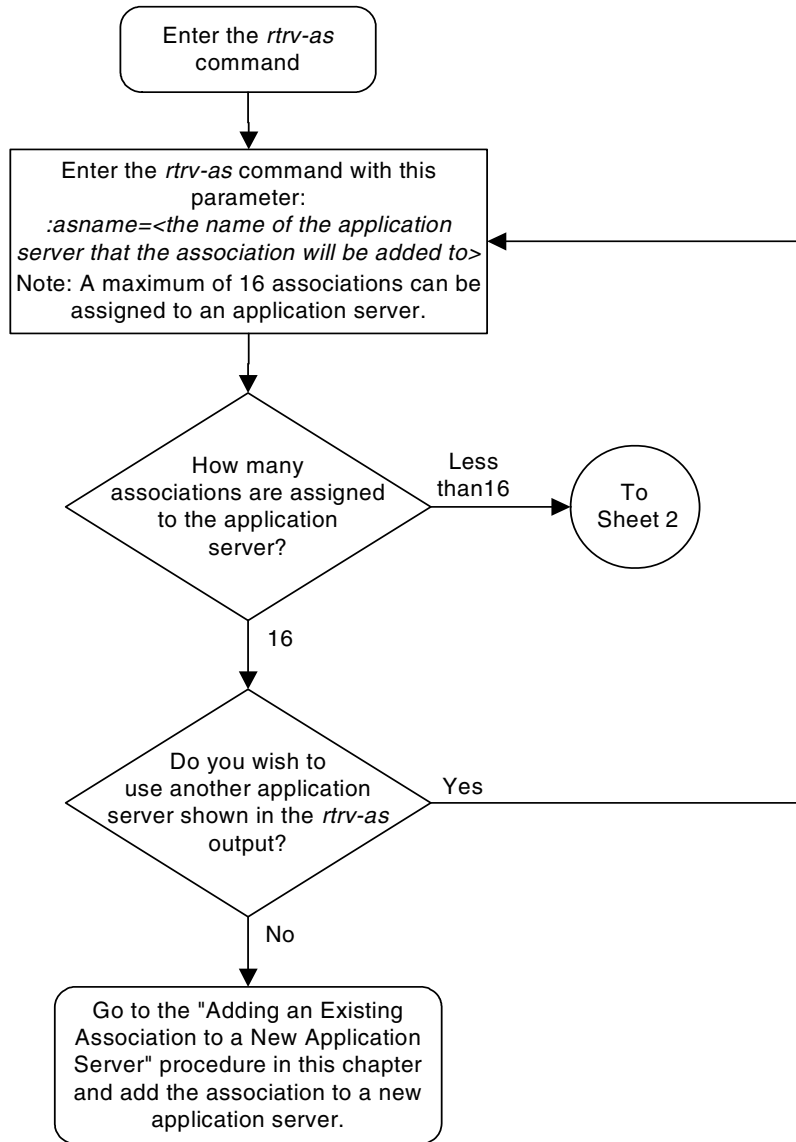

Flowchart 3-37. Adding an Existing Association to an Existing Application Server (Sheet 2 of 5)

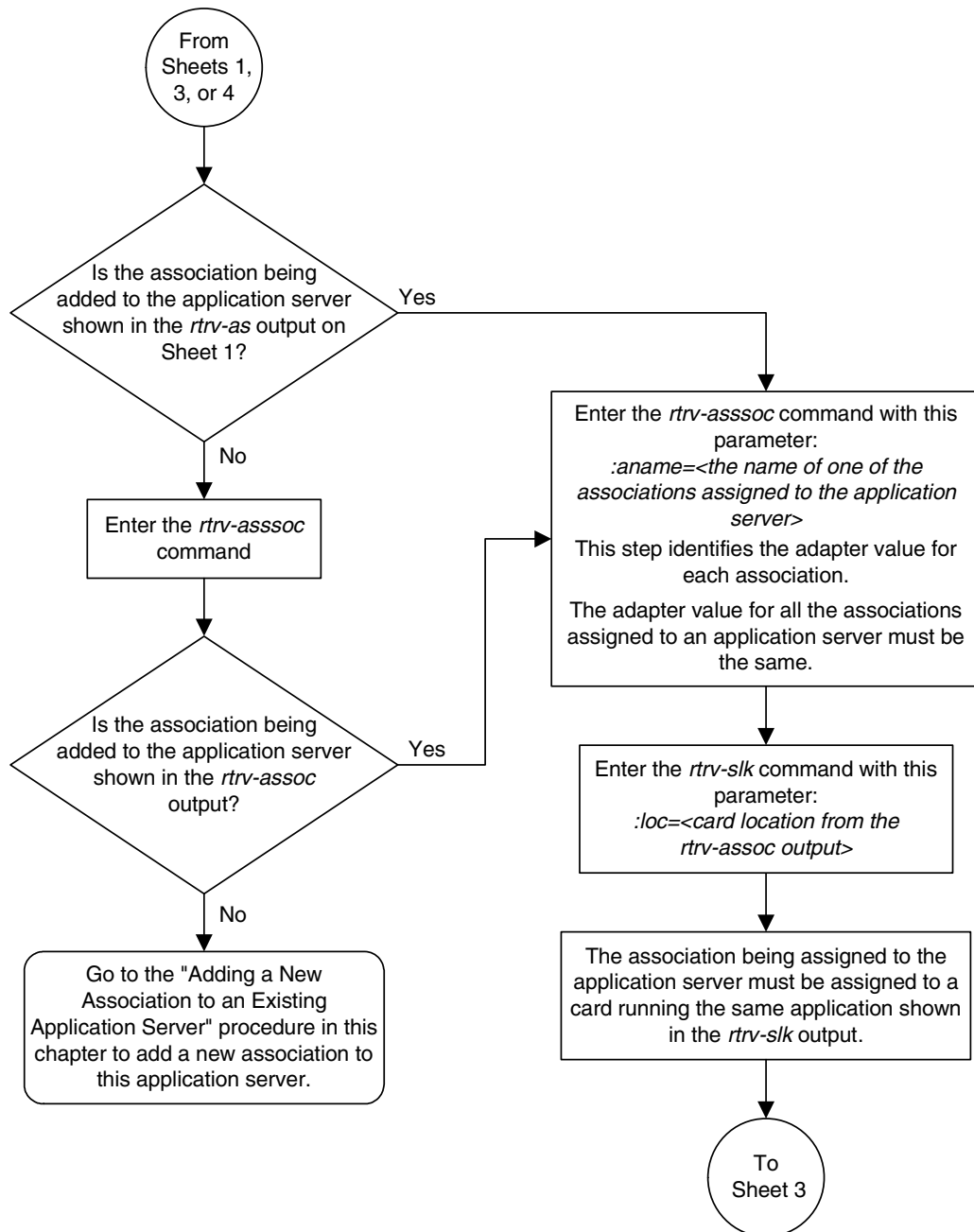

Flowchart 3-37. Adding an Existing Association to an Existing Application Server (Sheet 3 of 5)

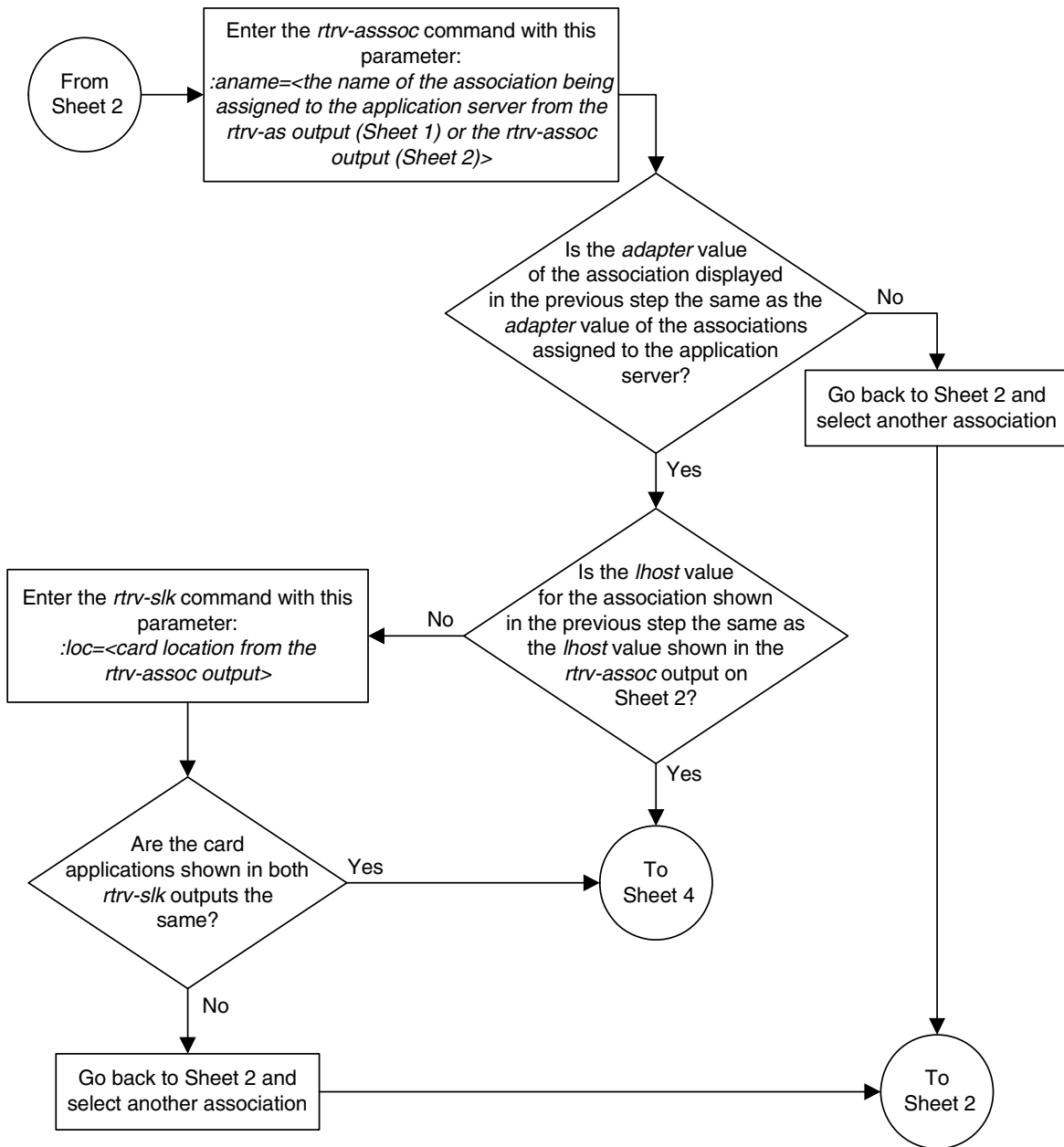

Flowchart 3-37. Adding an Existing Association to an Existing Application Server (Sheet 4 of 5)

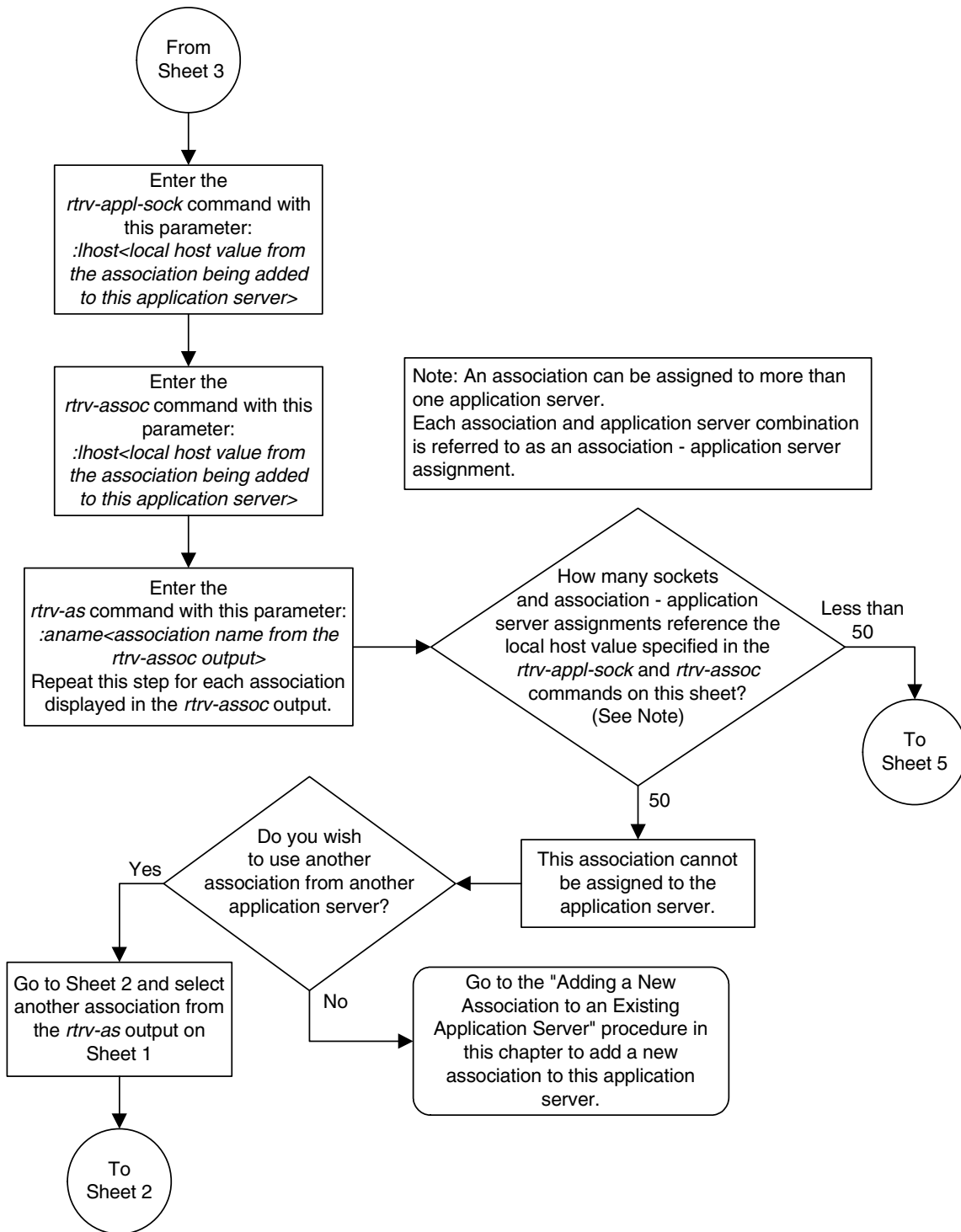

Flowchart 3-37. Adding an Existing Association to an Existing Application Server (Sheet 5 of 5)

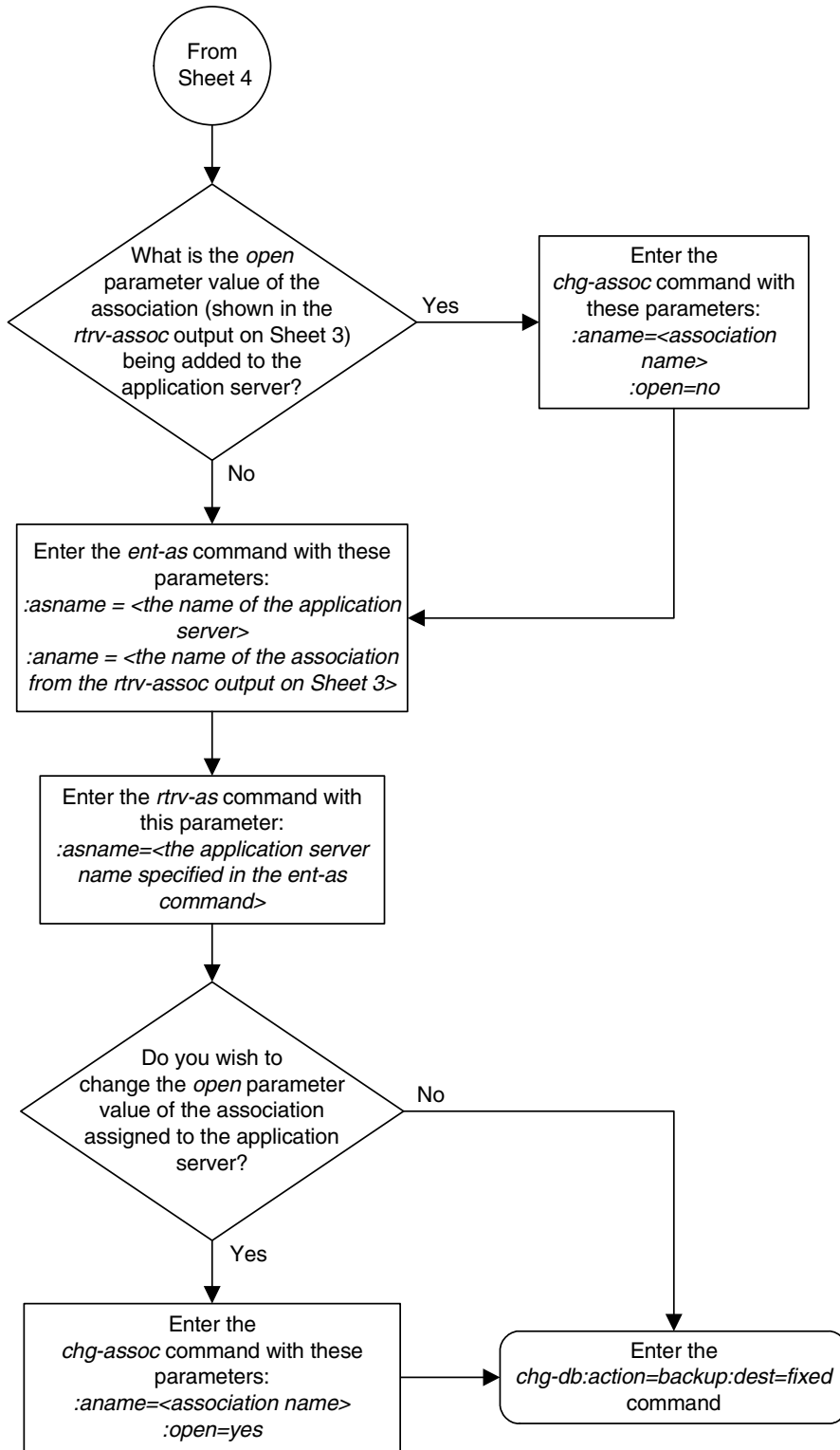

Removing an Association from an Application Server

This procedure is used to remove an association from an application server using the `dlt-as` command.

The `dlt-as` command uses these parameters:

- `:asname` – The application server name containing the association being removed in this procedure.
- `:aname` – The name of the association being removed from the application server.

The association name and application server name combination must be in the database.

The `open` parameter value in the association assigned to the application server specified in the `dlt-as` command must be `no`. This can be verified with the `rtrv-assoc` command. Use the `chg-assoc` command to change the value of the `open` parameter.

If the association is the only association assigned to the application server, the application server is removed from the database. The application server cannot be removed from the database if it is assigned to a routing key. This can be verified with the `rtrv-appl-rtkey` command.

Canceling the RTRV-AS, RTRV-ASSOC, and RTRV-APPL-RTKEY Commands

Because the `rtrv-as`, `rtrv-assoc`, and `rtrv-appl-rtkey` commands used in this procedure can output information for a long period of time, the `rtrv-as`, `rtrv-assoc`, and `rtrv-appl-rtkey` commands can be canceled and the output to the terminal stopped. There are three ways that the `rtrv-as`, `rtrv-assoc`, and `rtrv-appl-rtkey` commands can be canceled.

- Press the **F9** function key on the keyboard at the terminal where the `rtrv-as`, `rtrv-assoc`, or `rtrv-appl-rtkey` commands were entered.
- Enter the `canc-cmd` without the `trm` parameter at the terminal where the `rtrv-as`, `rtrv-assoc`, or `rtrv-appl-rtkey` commands were entered.
- Enter the `canc-cmd:trm=<xx>`, where `<xx>` is the terminal where the `rtrv-as`, `rtrv-assoc`, or `rtrv-appl-rtkey` commands were entered, from another terminal other than the terminal where the `rtrv-as`, `rtrv-assoc`, or `rtrv-appl-rtkey` commands were entered. To enter the `canc-cmd:trm=<xx>` command, the terminal must allow Security Administration commands to be entered from it and the user must be allowed to enter Security Administration commands. The terminal's permissions can be verified with the `rtrv-secu-trm` command. The user's permissions can be verified with the `rtrv-user` or `rtrv-secu-user` commands.

For more information about the `canc-cmd` command, go to the *Commands Manual*.

Procedure

1. Display the application servers in the database using the `rtrv-as` command. This is an example of possible output.

```
rlghncxa03w 06-10-28 09:12:36 GMT EAGLE5 36.0.0

AS Name           Mode           Tr ms   Association Names
as1                LOADSHARE     10      assoc1
                  LOADSHARE     10      assoc2
                  LOADSHARE     10      assoc3
                  LOADSHARE     10      assoc5
                  LOADSHARE     10      assoc6

as2                OVERRIDE      10      assoc7
as3                LOADSHARE     10      assoc4

AS table is (3 of 250) 1% full.
```

2. Display the associations to be removed from the application server using the `rtrv-assoc` command and specifying the association name shown in the `rtrv-as` output in step 1. For this example, enter this command.

```
rtrv-assoc:aname=assoc1
```

This is an example of possible output.

```
rlghncxa03w 06-10-28 09:12:36 GMT EAGLE5 36.0.0
ANAME assoc1
  LOC      1203           IPLNK PORT  A           LINK  A
ADAPTER  M3UA           VER        M3UA RFC
LHOST    gw105.nc.tekelec.com
ALHOST   ---
RHOST    gw100.nc.tekelec.com
LPORT    1030           RPORT      1030
ISTRMS   2              OSTRMS     2           BUFSIZE  16
RMODE    LIN           RMIN       120         RMAX     800
RTIMES   10            CWMIN      3000        UAPS     10
OPEN     YES           ALW        YES

ASNAMES
as1

IP Appl Sock table is (4 of 4000) 1% full
Assoc Buffer Space Used (16 KB of 800 KB) on LOC = 1203
```

NOTE: If the value of the `open` parameter shown in step 3 is `no`, skip this step and go to step 5.

3. Change the value of the `open` parameter to `no` by specifying the `chg-assoc` command with the `open=no` parameter. For this example, enter this command.

```
chg-assoc:aname=assoc1:open=no
```

When this command has successfully completed, this message should appear.

```
rlghncxa03w 06-10-28 09:12:36 GMT EAGLE5 36.0.0
CHG-ASSOC: MASP A - COMPLTD;
```

NOTE: If the application server specified in this procedure contains more than one association, skip this step and go to step 5.

4. If the association is the only association assigned to the application server, the application server is removed from the database. The application server cannot be removed from the database if it is assigned to a routing key. Verify the routing keys that the application server is assigned to by entering the **rtrv-appl-rtkey** command with the application server name that will be specified in step 5 and the **display=all** parameter. For this example, enter this command.

rtrv-appl-rtkey:asname=as1:display=all

rlghncxa03w 06-10-28 09:12:36 GMT EAGLE5 36.0.0

| RCONTEXT | DPCI | SI | SSN | OPCI | CICS | CICE | LOC |
|----------|---------|----|-----|---------|------|------|--------|
| ----- | 6-024-7 | 5 | --- | 1-057-4 | 150 | 175 | STATIC |

| ADPTR | TYPE | ASNAME |
|-------|------|--------|
| M3UA | FULL | as1 |

| ANAMES | assoc1 | assoc2 | assoc3 | assoc5 |
|--------|--------|--------|--------|--------|
| | assoc6 | | | |

| RCONTEXT | DPCI | SI | SSN | OPCI | CICS | CICE | LOC |
|----------|---------|----|-----|-------|-------|-------|--------|
| ----- | 2-100-7 | 6 | --- | ----- | ----- | ----- | STATIC |

| ADPTR | TYPE | ASNAME |
|-------|------|--------|
| M3UA | FULL | as1 |

| ANAMES | assoc1 | assoc2 | assoc3 | assoc5 |
|--------|--------|--------|--------|--------|
| | assoc6 | | | |

STATIC Route Key table is (7 of 2000) 1% full
 1105 Route Key table is (2 of 500) 1% full
 1107 Route Key table is (2 of 500) 1% full

STATIC Route Key Socket Association table is (7 of 32000) 1% full
 1105 Route Key Socket Association table is (2 of 8000) 1% full
 1107 Route Key Socket Association table is (2 of 8000) 1% full

If the application server is assigned to any routing keys, remove the routing keys referencing the application server by performing the "Removing a Routing Key" procedure on page 3-272.

- Remove the association from the application server from the database using the `dlt-as` command. For this example, enter this command.

```
dlt-as:asname=as1:aname=assoc1
```

NOTE: If the association being removed from the application server is the only association assigned to the application server, the application server is removed from the database.

This is an example of possible inputs and outputs:

```
rlghncxa03w 06-10-28 09:12:36 GMT EAGLE5 36.0.0
ENT-AS: MASP A - COMPLTD;
```

- Verify the changes using the `rtrv-as` command with the application server name specified in step 5. For this example, enter this command.

```
rtrv-as:asname=as1
```

This is an example of possible output.

```
rlghncxa03w 06-10-28 09:12:36 GMT EAGLE5 36.0.0

AS Name           Mode           Tr ms   Association Names
as1                LOADSHARE     10      assoc2
                  LOADSHARE     10      assoc3
                  LOADSHARE     10      assoc5
                  LOADSHARE     10      assoc6
```

```
AS table is (3 of 250) 1% full.
```

NOTE: If the value of the `open` parameter was not changed in step 3, skip this step and go to step 8.

- Change the value of the `open` parameter to `yes` by specifying the `chg-assoc` command with the `open=yes` parameter. For this example, enter this command.

```
chg-assoc:aname=assoc1:open=yes
```

When this command has successfully completed, this message should appear.

```
rlghncxa03w 06-10-28 09:12:36 GMT EAGLE5 36.0.0
CHG-ASSOC: MASP A - COMPLTD;
```

- Back up the new changes, using the `chg-db:action=backup:dest=fixed` command. These messages should appear; the active Maintenance and Administration Subsystem Processor (MASP) appears first.

```
BACKUP (FIXED) : MASP A - Backup starts on active MASP.
BACKUP (FIXED) : MASP A - Backup on active MASP to fixed disk complete.
BACKUP (FIXED) : MASP A - Backup starts on standby MASP.
BACKUP (FIXED) : MASP A - Backup on standby MASP to fixed disk complete.
```

Flowchart 3-38. Removing an Association from an Application Server
(Sheet 1 of 2)

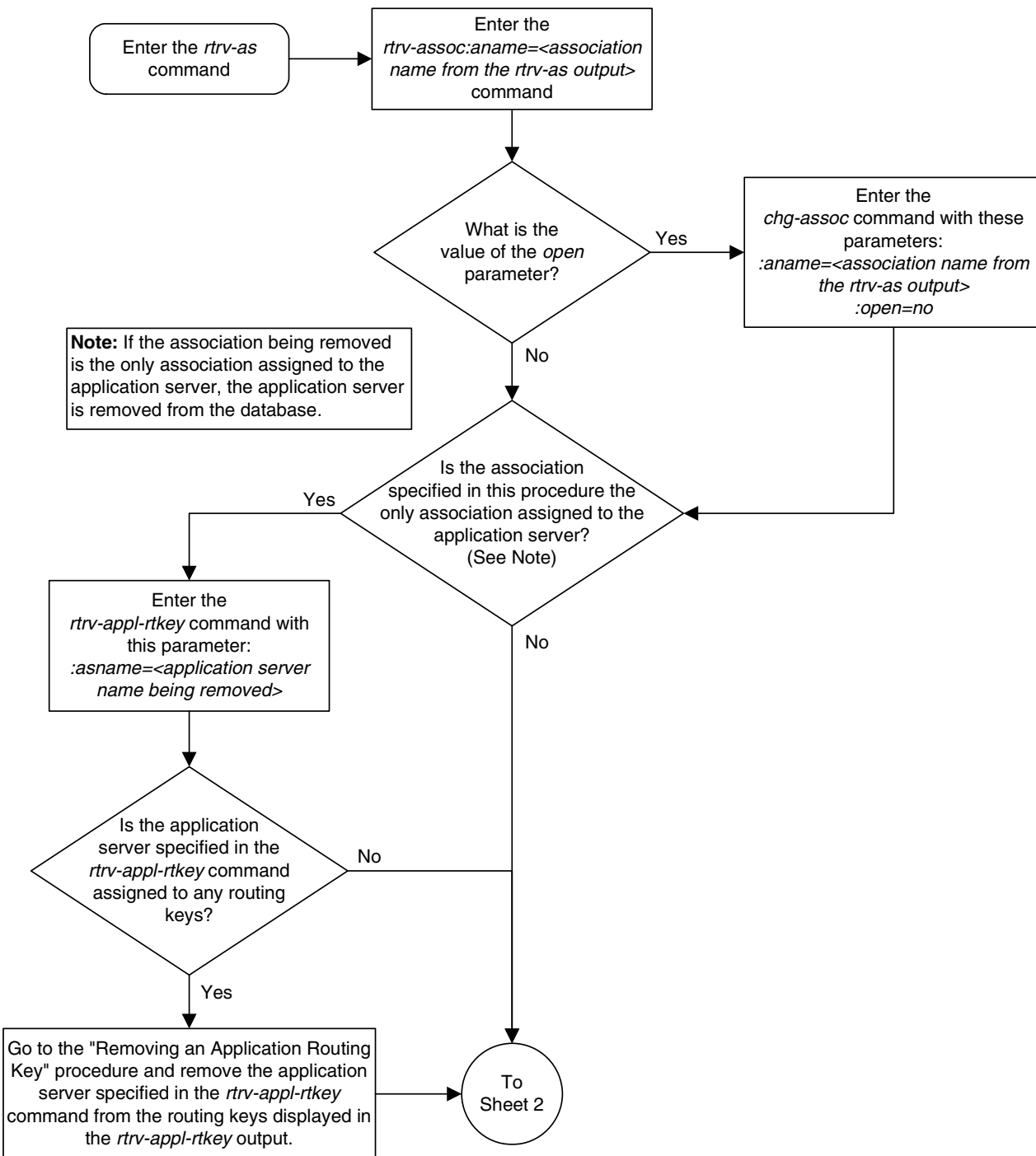

Flowchart 3-38. Removing an Association from an Application Server
(Sheet 2 of 2)

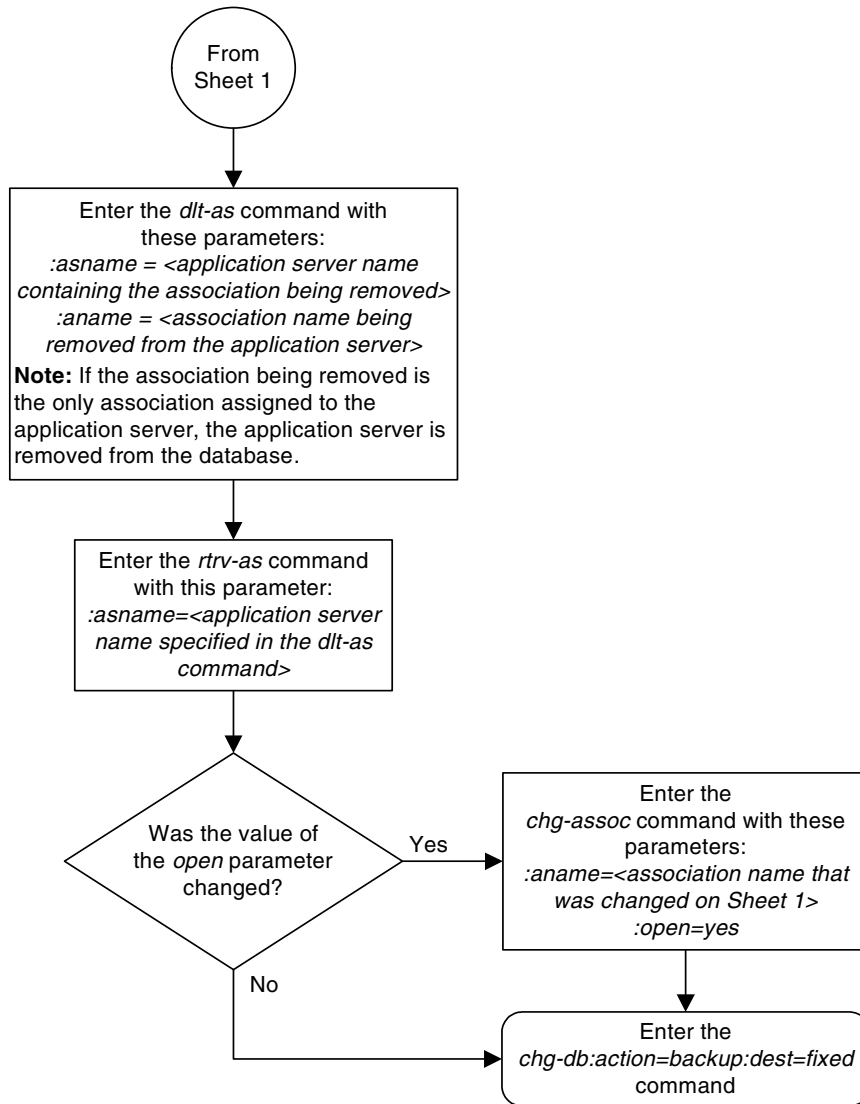

Changing an Application Server

This procedure is used change the characteristics of an existing application server using the **chg-as** command.

The **chg-as** command uses these parameters:

- :asname** – The name of the application server being changed.
- :mode** – The traffic mode assigned to the application server, either **loadshare** or **override**.
- :tr** – The application server recovery timer, 10 - 2000 milliseconds.

The **mode** parameter value cannot be changed unless the **open** parameter value of the all the associations assigned to the application server is set to **no**. This can be verified with the **rtrv-assoc** command.

The association assignments for an application server cannot be changed with this procedure. To change an association assignment for an application server, go to the “Removing an Association from an Application Server” procedure on page 3-441 and remove the association from the application server, then perform one of these procedures to add another association to the application server:

- “Adding a New Association to an Existing Application Server” procedure on page 3-417
- “Adding an Existing Association to an Existing Application Server” procedure on page 3-429.

Canceling the **RTRV-AS** and **RTRV-ASSOC** Commands

Because the **rtrv-as** and **rtrv-assoc** commands used in this procedure can output information for a long period of time, the **rtrv-as** and **rtrv-assoc** commands can be canceled and the output to the terminal stopped. There are three ways that the **rtrv-as** and **rtrv-assoc** commands can be canceled.

- Press the **F9** function key on the keyboard at the terminal where the **rtrv-as** or **rtrv-assoc** commands were entered.
- Enter the **canc-cmd** without the **trm** parameter at the terminal where the **rtrv-as** or **rtrv-assoc** commands were entered.
- Enter the **canc-cmd:trm=<xx>**, where **<xx>** is the terminal where the **rtrv-as** or **rtrv-assoc** commands were entered, from another terminal other than the terminal where the **rtrv-as** or **rtrv-assoc** commands were entered. To enter the **canc-cmd:trm=<xx>** command, the terminal must allow Security Administration commands to be entered from it and the user must be allowed to enter Security Administration commands. The terminal’s permissions can be verified with the **rtrv-secu-trm** command. The user’s permissions can be verified with the **rtrv-user** or **rtrv-secu-user** commands.

For more information about the **canc-cmd** command, go to the *Commands Manual*.

Procedure

1. Display the application servers in the database using the `rtrv-as` command. This is an example of possible output.

```
rlghncxa03w 06-10-28 09:12:36 GMT EAGLE5 36.0.0
AS Name           Mode           Tr ms   Association Names
as1               LOADSHARE     10      assoc1
                 LOADSHARE     10      assoc2
                 LOADSHARE     10      assoc3
                 LOADSHARE     10      assoc5
                 LOADSHARE     10      assoc6
as2               OVERRIDE      10      assoc7
as3               LOADSHARE     10      assoc4
AS table is (2 of 250) 1% full.
```

NOTE: If the `mode` parameter will not be specified with the `chg-as` command in step 5, skip steps 2 through 4 and go to step 5.

2. Display one of the associations assigned to the application server shown in step 1 using the `rtrv-assoc` command and specifying the association name shown in the `rtrv-as` output in step 1. For this example, enter this command.

```
rtrv-assoc:aname=assoc1
```

This is an example of possible output.

```
rlghncxa03w 06-10-28 09:12:36 GMT EAGLE5 36.0.0
ANAME assoc1
LOC          1203          IPLNK PORT A          LINK A
ADAPTER      M3UA          VER          M3UA RFC
LHOST        gw105.nc.tekelec.com
ALHOST      ---
RHOST        gw100.ncd-economic-development.southeastern-cooridor-ash.gov
LPORT        1030          RPORT        2345
ISTRMS       2              OSTRMS       2              BUFSIZE 16
RMODE        LIN          RMIN         120           RMAX        800
RTIMES       10             CWMIN        3000          UAPS        10
OPEN         YES           ALW          YES
ASNAMES
as1
IP Appl Sock table is (4 of 4000) 1% full
Assoc Buffer Space Used (16 KB of 800 KB) on LOC = 1203
```

NOTE: If the value of the `open` parameter shown in step 2 is `no`, skip this step and go to step 4.

3. Change the value of the `open` parameter to `no` by specifying the `chg-assoc` command with the `open=no` parameter. For this example, enter this command.

```
chg-assoc:aname=assoc1:open=no
```

When this command has successfully completed, this message should appear.

```
rlghncxa03w 06-10-28 09:12:36 GMT EAGLE5 36.0.0
CHG-ASSOC: MASP A - COMPLTD
```

NOTE: If all the associations assigned to the application server been displayed, skip this step and go to step 5.

- Repeat steps 2 through 4 for all associations assigned to the application server being changed.

-
- Change the application server in the database using the **chg-as** command. For this example, enter this command

```
chg-as:asname=as1:mode=override:tr=1000
```

This is an example of possible inputs and outputs:

```
rlghncxa03w 06-10-28 09:12:36 GMT EAGLE5 36.0.0
CHG-AS: MASP A - COMPLTD;
```

- Verify the changes using the **rtrv-as** command. This is an example of possible output.

```
rlghncxa03w 06-10-28 09:12:36 GMT EAGLE5 36.0.0

AS Name           Mode           Tr ms   Association Names
as1                OVERRIDE      1000    assoc1
                  assoc2
                  assoc3
                  assoc5
                  assoc6

as2                OVERRIDE      10      assoc7
as3                LOADSHARE     10      assoc4

AS table is (2 of 250) 1% full
```

NOTE: If the value of the open parameter was not changed in step 3, skip this step and go to step 8.

- Change the value of the **open** parameter to **yes** by specifying the **chg-assoc** command with the **open=yes** parameter. For this example, enter this command.

```
chg-assoc:aname=assoc1:open=yes
```

When this command has successfully completed, this message should appear.

```
rlghncxa03w 06-10-28 09:12:36 GMT EAGLE5 36.0.0
CHG-ASSOC: MASP A - COMPLTD
```

Repeat this step for all associations that were changed in step 3.

-
- Back up the new changes, using the **chg-db:action=backup:dest=fixed** command. These messages should appear; the active Maintenance and Administration Subsystem Processor (MASP) appears first.

```
BACKUP (FIXED) : MASP A - Backup starts on active MASP.
BACKUP (FIXED) : MASP A - Backup on active MASP to fixed disk complete.
BACKUP (FIXED) : MASP A - Backup starts on standby MASP.
BACKUP (FIXED) : MASP A - Backup on standby MASP to fixed disk complete.
```

Flowchart 3-39. Changing an Application Server (Sheet 1 of 2)

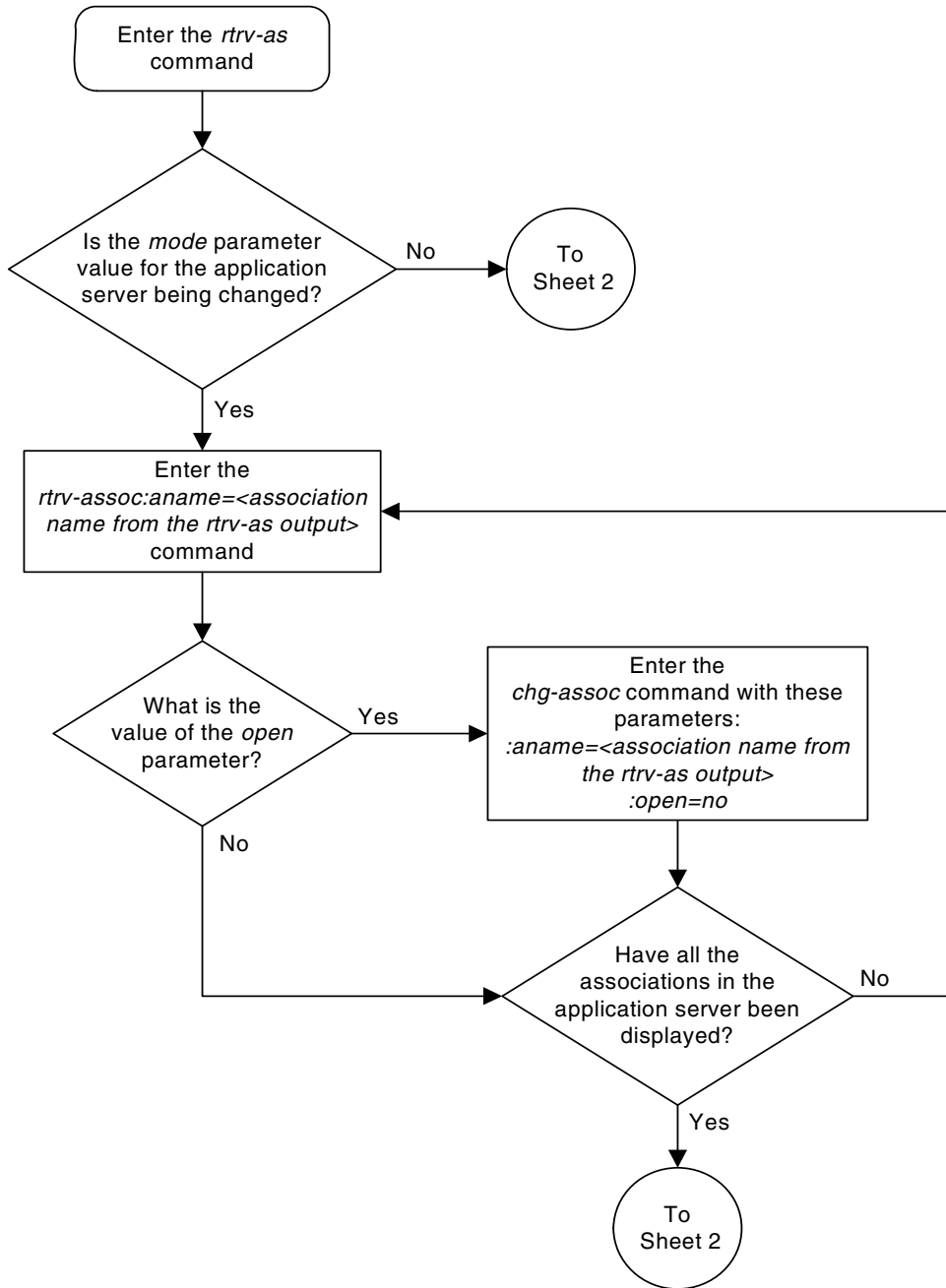

Flowchart 3-39. Changing an Application Server (Sheet 2 of 2)

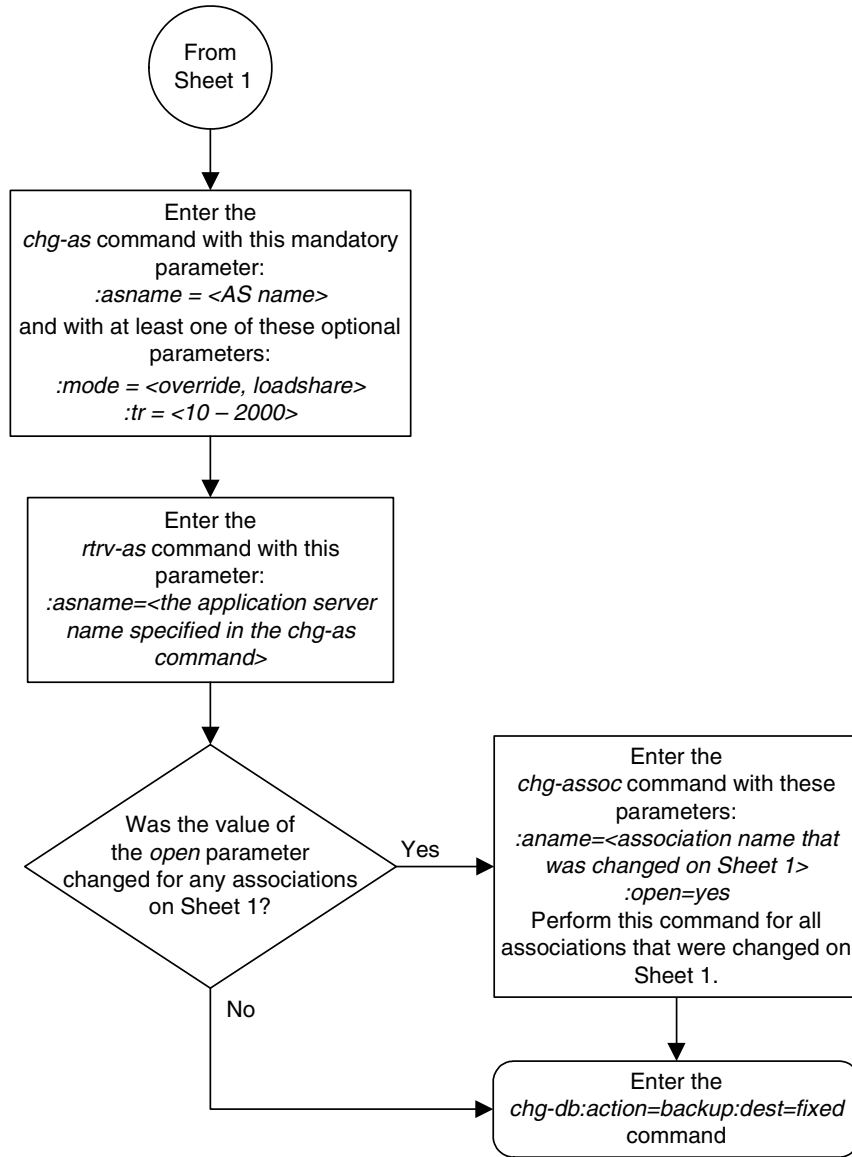

Adding a Network Appearance

The network appearance field identifies the SS7 network context for the message, for the purpose of logically separating the signaling traffic between the SGP (signaling gateway process) and the ASP (application server process) over a common SCTP (stream control transmission protocol) association. This field is contained in the DATA, DUNA, DAVA, DRST, DAUD, SCON, and DUPU messages.

The network appearance is provisioned in the database using the **ent-na** command with these parameters.

- :na** – the 32-bit value of the network appearance, from 0 to 4294967295.
- :type** – the network type of the network appearance, **ansi** (ANSI), **itui** (ITU-I), **itun** (14-bit ITU-N), **itun24** (24-bit ITU-N), **ituis** (ITU-I Spare), **ituns** (14-bit ITU-N Spare).
- :gc** – the specific ITU-N group code associated with the network appearance.

The **gc** parameter can be specified only with the **type=itun** or **type=ituns** parameters.

The **gc** parameter must be specified with the **type=itun** or **type=ituns** parameters if the ITU Duplicate Point Code feature is on. If the ITU Duplicate Point Code feature is off, the **gc** parameter cannot be specified.

The **gc** parameter value must be shown in the **rtrv-spc** or **rtrv-sid** outputs.

The **ituis** or **ituns** parameters can be specified only if the ITU National and International Spare Point Code Support feature is enabled.

Procedure

1. Display the network appearances in the database with the **rtrv-na** command. This is an example of the possible output.

```
rlghncxa03w 06-10-28 09:12:36 GMT EAGLE5 36.0.0
TYPE  GC          NA
ANSI  --          100
ITUN  FR  4000000000
ITUN  GE  1000000000
```

NOTE: If the gc parameter is not being specified in this procedure, skip this step and step 3, and go to step 4.

2. Display the self-identification of the EAGLE 5 ISS using the **rtrv-sid** command. This is an example of the possible output.

```
rlghncxa03w 06-10-28 09:12:36 GMT EAGLE5 36.0.0
PCA          PCI          PCN          CLLI          PCTYPE
001-001-001  1-200-6        13482       rlghncxa03w  OTHER

CPCA
002-002-002      002-002-003      002-002-004      002-002-005
002-002-006      002-002-007      002-002-008      002-002-009
004-002-001      004-003-003      144-212-003

CPCA (LNP)
005-005-002      005-005-004      005-005-005

CPCI
1-001-1          1-001-2          1-001-3          1-001-4

CPCN
02091            02092            02094            02097
02191            02192            11177
```

If the desired group code is shown in the **rtrv-sid** output, skip step 3 and go to step 4.

3. Display the secondary point codes in the database with the **rtrv-spc** command. This is an example of the possible output.

```
rlghncxa03w 06-10-28 09:12:36 GMT EAGLE5 36.0.0
SPC (Secondary Point Codes)

SPCA
001-010-010
002-010-010
003-010-010

SPC-I
1-253-5
2-254-6
3-255-7

SPC-N
10-01-11-1-fr
13-02-12-0-ge
13-02-12-0-uk

SPC-N24
none

Secondary Point Code table is (9 of 40) 23% full
```

If the desired group code is not shown in the **rtrv-spc** or **rtrv-sid** outputs, go to the "Adding a Secondary Point Code" procedure in the *Database Administration Manual - SS7* to turn the ITU Duplicate Point Code feature on, and add a secondary point code to the database with the desired group code value.

NOTE: If the `ituis` or `ituns` parameters will not be specified in this procedure, skip this step and go to step 5.

NOTE: If the `ituis` or `ituns` parameters will be specified in this procedure, and ITU-I spare or 14-bit ITU-N spare network appearances are shown in the `rtrv-na` output in step 1, or ITU-I spare or 14-bit ITU-N spare point codes are shown in the `rtrv-sid` output in step 2, skip this step and go to step 5.

4. Display the status of the ITU National and International Spare Point Code Support feature by entering the `rtrv-ctrl-feat` command with the ITU National and International Spare Point Code Support feature part number. Enter this command.

```
rtrv-ctrl-feat:partnum=893013601
```

The following is an example of the possible output.

```
rlghncxa03w 06-10-28 21:15:37 GMT EAGLE5 36.0.0
The following features have been permanently enabled:
```

| Feature Name | Partnum | Status | Quantity |
|--------------------------|-----------|--------|----------|
| Spare Point Code Support | 893013601 | on | ---- |

The following features have been temporarily enabled:

| Feature Name | Partnum | Status | Quantity | Trial Period Left |
|---------------------|---------|--------|----------|-------------------|
| Zero entries found. | | | | |

The following features have expired temporary keys:

| Feature Name | Partnum |
|---------------------|---------|
| Zero entries found. | |

If the ITU National and International Spare Point Code Support feature is not enabled, perform the “Activating the ITU National and International Spare Point Code Support feature” procedure in the *Database Administration Manual - SS7* and enable and turn on the ITU National and International Spare Point Code Support feature.

5. Add the network appearance to the database with the `ent-na` command. If the `gc` parameter is specified with the `ent-na` command, the `gc` parameter value must be shown in the `rtrv-sid` output in step 2, or assigned to an ITU-N point code (SPC-N) shown in the `rtrv-spc` output in step 3. For this example, enter these commands.

```
ent-na:na=1000:type=itui
```

```
ent-na:na=3:type=itun24
```

```
ent-na:na=15000:type=itun:gc=uk
```

```
ent-na:na=2000:type=ituis
```

```
ent-na:na=5000:type=ituns:gc=sp
```

When each of these commands have successfully completed, this message should appear.

```
rlghncxa03w 06-10-28 09:12:36 GMT EAGLE5 36.0.0
ENT-NA: MASP A - COMPLTD
```

6. Verify the changes using the `rtrv-na` command. This is an example of possible output.

```
rlghncxa03w 06-10-28 09:12:36 GMT EAGLE5 36.0.0
TYPE      GC          NA
ANSI      --          100
ITUI      --          1000
ITUN      uk          150000
ITUN      fr          4000000000
ITUN      ge          1000000000
ITUN24    --          3
ITUIS     --          2000
ITUNS     sp          5000
```

7. Back up the new changes, using the `chg-db:action=backup:dest=fixed` command. These messages should appear; the active Maintenance and Administration Subsystem Processor (MASP) appears first.

```
BACKUP (FIXED) : MASP A - Backup starts on active MASP.
BACKUP (FIXED) : MASP A - Backup on active MASP to fixed disk complete.
BACKUP (FIXED) : MASP A - Backup starts on standby MASP.
BACKUP (FIXED) : MASP A - Backup on standby MASP to fixed disk complete.
```

Flowchart 3-40. Adding a Network Appearance (Sheet 1 of 3)

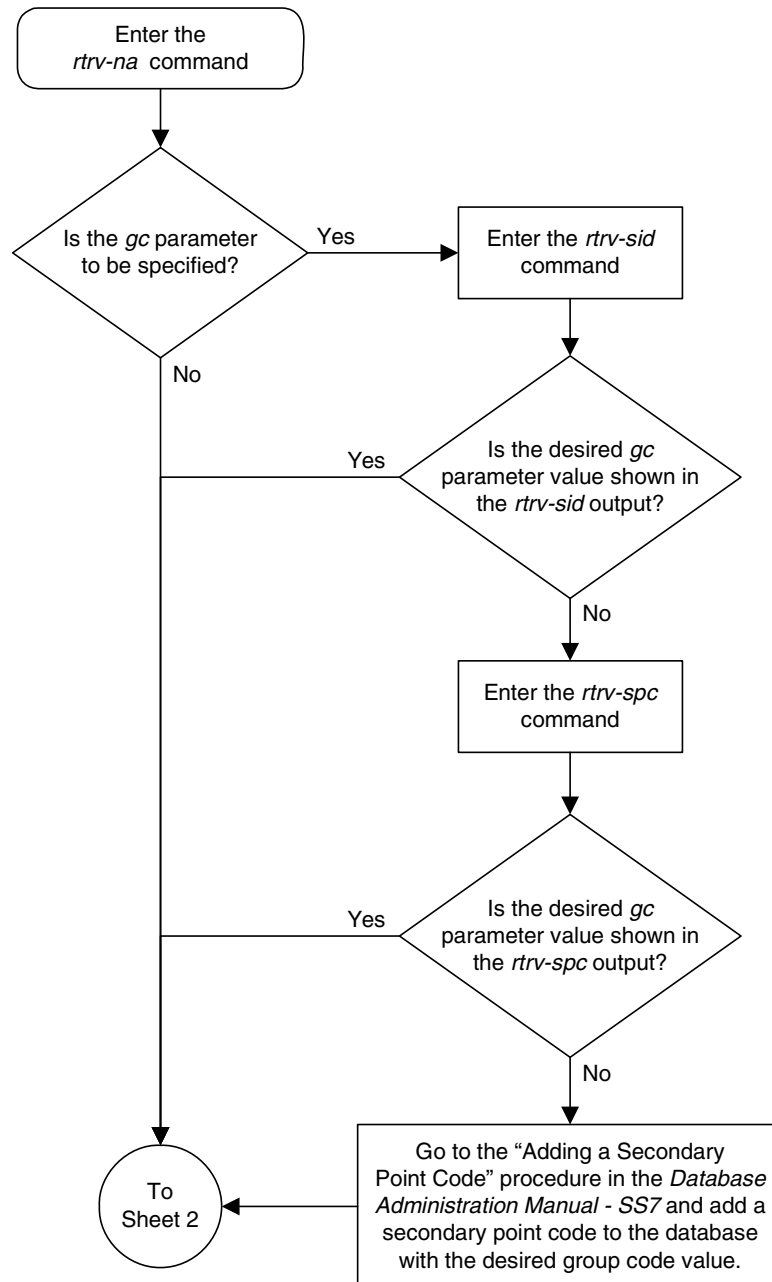

Flowchart 3-40. Adding a Network Appearance (Sheet 2 of 3)

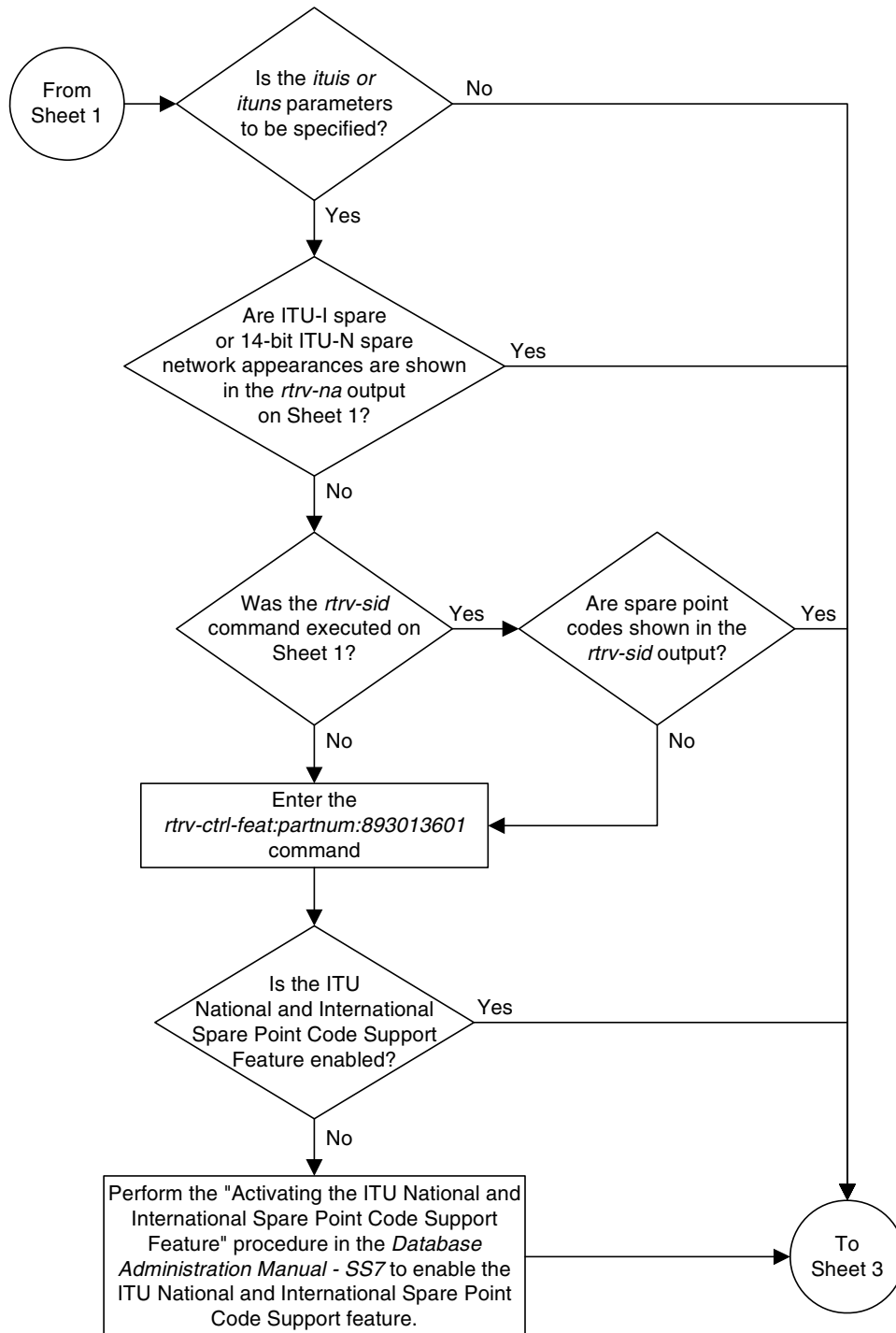

Flowchart 3-40. Adding a Network Appearance (Sheet 3 of 3)

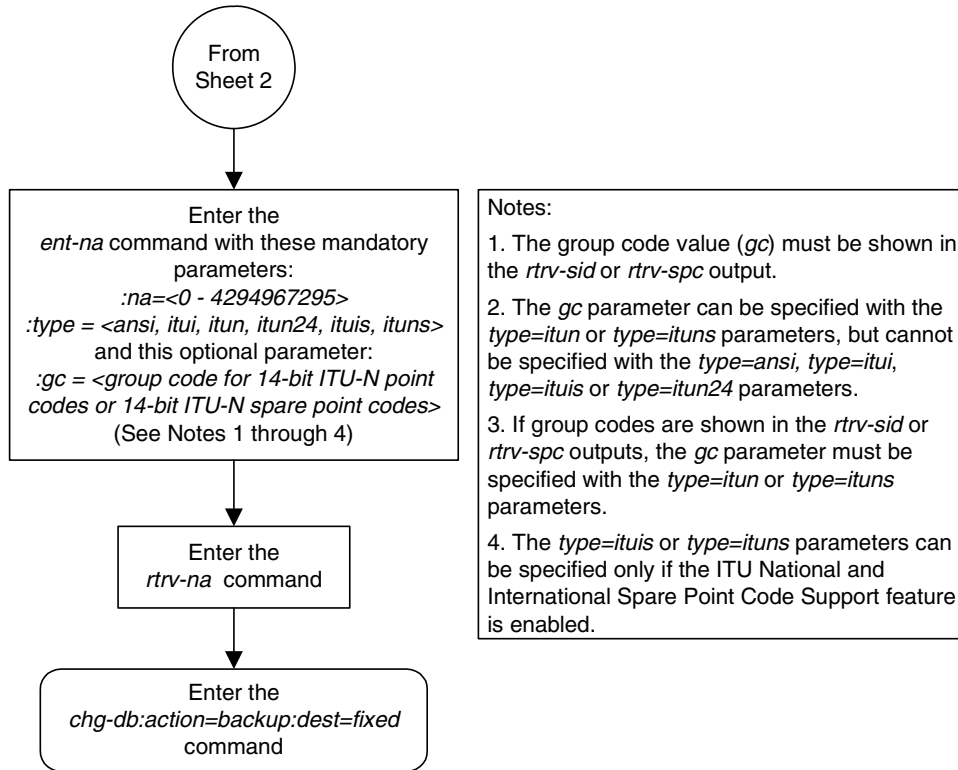

Removing a Network Appearance

This procedure removes the network appearance from the database using the `dlt-na` command with these parameters.

`:na` – the 32-bit value of the network appearance, from 0 to 4294967295.

`:type` – the network type of the network appearance, `ansi` (ANSI), `itui` (ITU-I), `itun` (14-bit ITU-N), `itun24` (24-bit ITU-N), `ituis` (ITU-I Spare), `ituns` (14-bit ITU-N Spare).

`:gc` – the specific ITU-N group code associated with the network appearance.

Specifying the `gc` parameter removes the specific network appearance containing the `na` and `gc` parameter values.

Specifying the `type=itun` or `type=ituns` parameter without the `gc` parameter removes all 14-bit ITU-N or 14-bit ITU-N spare network appearances containing the specified `na` parameter value.

Procedure

1. Display the network appearances in the database with the `rtrv-na` command. This is an example of the possible output.

```
rlghncxa03w 06-10-28 09:12:36 GMT EAGLE5 36.0.0
TYPE      GC      NA
ANSI      --      100
ITUI      --      1000
ITUN      uk      150000
ITUN      fr      4000000000
ITUN      ge      1000000000
ITUN24    --      3
ITUIS     --      2000
ITUNS     sp      5000
```

2. Remove the network appearance from the database with the `dlt-na` command. For this example, enter these commands.

```
dlt-na:na=100:type=ansi
```

```
dlt-na:na=4000000000:type=itun:gc=fr
```

When each of these commands have successfully completed, this message should appear.

```
rlghncxa03w 06-10-28 09:12:36 GMT EAGLE5 36.0.0
DLT-NA:  MASP A - COMPLTD
```

3. Verify the changes using the `rtrv-na` command. This is an example of possible output.

```
rlghncxa03w 06-10-28 09:12:36 GMT EAGLE5 36.0.0
TYPE      GC          NA
ITUI      --          1000
ITUN      uk          150000
ITUN      ge          1000000000
ITUN24    --          3
ITUIS     --          2000
ITUNS     sp          5000
```

4. Back up the new changes, using the `chg-db:action=backup:dest=fixed` command. These messages should appear; the active Maintenance and Administration Subsystem Processor (MASP) appears first.

```
BACKUP (FIXED) : MASP A - Backup starts on active MASP.
BACKUP (FIXED) : MASP A - Backup on active MASP to fixed disk complete.
BACKUP (FIXED) : MASP A - Backup starts on standby MASP.
BACKUP (FIXED) : MASP A - Backup on standby MASP to fixed disk complete.
```

Flowchart 3-41. Removing a Network Appearance

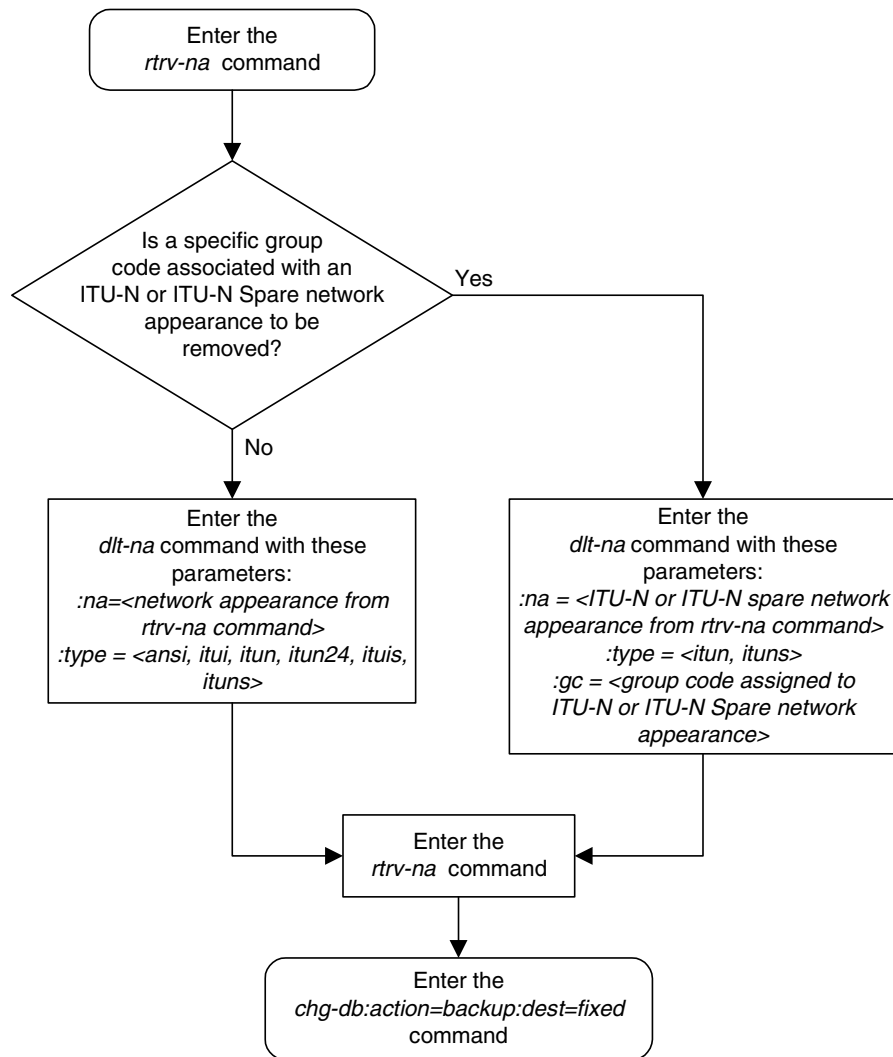

Changing the SCTP Checksum Algorithm Option

Use this procedure to change the SCTP checksum algorithm, either Adler-32 or CRC-32c, applied to traffic on SCTP associations. The `sctpchecksum` parameter of the `chg-sg-opts` command is used to change this option. This option is a system-wide option that applies to associations assigned to IP cards running the IPLIM, IPLIMI, SS7IPGW, and IPGWI applications.

Once the SCTP checksum option has been changed, the associations on each IP card need to be reset by changing the `open` parameter value for each association to `no`, then back to `yes`. This ensures that the associations on the IP card are using the new SCTP checksum algorithm.

Canceling the `RTRV-ASSOC` Command

Because the `rtrv-assoc` command used in this procedure can output information for a long period of time, the `rtrv-assoc` command can be canceled and the output to the terminal stopped. There are three ways that the `rtrv-assoc` command can be canceled.

- Press the **F9** function key on the keyboard at the terminal where the `rtrv-assoc` command was entered.
- Enter the `canc-cmd` without the `trm` parameter at the terminal where the `rtrv-assoc` command was entered.
- Enter the `canc-cmd:trm=<xx>`, where `<xx>` is the terminal where the `rtrv-assoc` command was entered, from another terminal other than the terminal where the `rtrv-assoc` command was entered. To enter the `canc-cmd:trm=<xx>` command, the terminal must allow Security Administration commands to be entered from it and the user must be allowed to enter Security Administration commands. The terminal's permissions can be verified with the `rtrv-secu-trm` command. The user's permissions can be verified with the `rtrv-user` or `rtrv-secu-user` commands.

For more information about the `canc-cmd` command, go to the *Commands Manual*.

Procedure

1. Display the current IP options in the database by entering the `rtrv-sg-opts` command. The following is an example of the possible output.

```
rlghncxa03w 06-10-28 21:16:37 GMT EAGLE5 36.0.0
SYNC:          TALI
SRKQ:          250
DRKQ:          750
SNMPCONT:      john doe 555-123-4567
GETCOMM:       public
SETCOMM:       private
TRAPCOMM:      public
INHFEPALM:    NO
SCTPCSUM:      adler32
IPGWABATE:     NO
IPLIMABATE:    NO
IPTPSALMTHRESH: 80
```

2. Display the cards in the EAGLE 5 ISS by entering the `rtrv-card` command. This is an example of the possible output.

```
rlghncxa03w 06-10-15 16:34:56 GMT EAGLE5 36.0.0
CARD  TYPE      APPL      LSET NAME      LINK SLC  LSET NAME      LINK SLC
1101  TSM          SCCP
1102  TSM          GLS
1104  ACMENET      STPLAN
1113  GSPM         EOAM
1114  TDM-A
1115  GSPM         EOAM
1116  TDM-B
1117  MDAL
1201  LIMDS0      SS7ANSI  lsn1           A  0  lsn2           B  1
1202  DCM         IPLIM    ipnode2        A  1
1203  LIMV35      SS7ANSI  lsn2           A  0  lsn1           B  1
1204  LIMATM      ATMANSI  atmgwy         A  0
1205  DCM         IPLIM    ipnode1        A  0  ipnode3        B  1
1207  DCM         IPLIM    ipnode2        A  0
1303  DCM         IPLIM    ipnode3        A  0  ipnode1        B  1
1305  DCM         IPLIM    ipnode4        A  0
1308  DCM         IPLIM    ipnode3        B  2
                             ipnode1        A1 2  ipnode4        B2 1
1315  DCM         SS7IPGW  ipgtwy1        A
1317  DCM         IPGWI    ipgtwy2        A
```

Record the card location, shown in the **LOC** column, and signaling link, shown in the **LINK** column, information for all cards running the IPLIM, IPLIMI, SS7IPGW, and IPGWI applications.

NOTE: If no cards running the IPLIM or IPLIMI applications are shown in the `rtrv-card` output in step 2, skip steps 3 through 15 and go to step 16.

3. Change the SCTP checksum option in the database using the `chg-sg-opts` command. For this example, enter this command.

```
chg-sg-opts:sctpcsum=crc32c
```

When this command has successfully completed, the following message should appear.

```
rlghncxa03w 06-10-28 21:19:37 GMT EAGLE5 36.0.0
CHG-SG-OPTS: MASP A - COMPLTD
```

4. Verify that the SCTP checksum algorithm was changed using the `rtrv-sg-opts` command. The SCTP checksum algorithm option value is shown in the `SCTPCSUM` parameter. The following is an example of the possible output.

```
rlghncxa03w 06-10-28 21:16:37 GMT EAGLE5 36.0.0
SYNC:          TALI
SRKQ:          250
DRKQ:          750
SNMPCONT:      john doe 555-123-4567
GETCOMM:       public
SETCOMM:       private
TRAPCOMM:      public
INHFEPALM:     NO
SCTPCSUM:      crc32c
IPGWABATE:     NO
IPLIMABATE:    NO
IPTPSALMTHRESH: 80
```

5. Select one of the IP cards shown in the `rtrv-card` output in step 2 running the IPLIM or IPLIMI applications. Place the signaling links on this card out of service using the `dact-slk` command. For this example, enter these commands.

```
dact-slk:loc=1308:link=a1
```

```
dact-slk:loc=1308:link=b
```

```
dact-slk:loc=1308:link=b2
```

When these commands have successfully completed, this message appears.

```
rlghncxa03w 06-10-12 09:12:36 GMT EAGLE5 36.0.0
Deactivate Link message sent to card
```

6. Display the IP addresses of the IP links in the database by entering the `rtrv-ip-lnk` command. The following is an example of the possible output.

```
rlghncxa03w 06-10-28 21:17:37 GMT EAGLE5 36.0.0
LOC  PORT  IPADDR          SUBMASK          DUPLEX  SPEED  MACTYPE  AUTO  MCAST
1202  A      192.1.1.10      255.255.255.0    HALF    10     DIX      NO    NO
1202  B      -----          -----          HALF    10     DIX      NO    NO
1205  A      192.1.1.12      255.255.255.0    HALF    10     DIX      NO    NO
1205  B      -----          -----          HALF    10     DIX      NO    NO
1207  A      192.1.1.14      255.255.255.0    HALF    10     DIX      NO    NO
1207  B      -----          -----          HALF    10     DIX      NO    NO
1303  A      192.1.1.20      255.255.255.0    HALF    10     DIX      NO    NO
```

IP⁷ Secure Gateway Configuration Procedures

```
1303 B ----- ----- HALF 10 DIX NO NO
1305 A 192.1.1.22 255.255.255.0 HALF 10 DIX NO NO
1305 B ----- ----- HALF 10 DIX NO NO
1308 A 192.1.1.24 255.255.255.0 HALF 10 DIX NO NO
1308 B ----- ----- HALF 10 DIX NO NO
1315 A 192.1.1.50 255.255.255.0 HALF 10 DIX NO NO
1315 B ----- ----- HALF 10 DIX NO NO
1317 A 192.1.1.52 255.255.255.0 HALF 10 DIX NO NO
1317 B ----- ----- HALF 10 DIX NO NO
```

```
IP-LNK table is (16 of 512) 3% full.
```

7. Display the current IP host information in the database by entering the **rtrv-ip-host** command. The following is an example of the possible output.

```
rlghncxa03w 06-10-28 21:17:37 GMT EAGLE5 36.0.0
```

```
LOCAL IPADDR LOCAL HOST
192.1.1.10 IPNODE1-1201
192.1.1.12 IPNODE1-1203
192.1.1.14 IPNODE1-1205
192.1.1.20 IPNODE2-1201
192.1.1.22 IPNODE2-1203
192.1.1.24 IPNODE2-1205
192.1.1.32 KC-HLR2
192.1.1.50 DN-MS1
192.1.1.52 DN-MS2

REMOTE IPADDR REMOTE HOST
150.1.1.5 NCDEPTECONOMIC_DEVELOPMENT.SOUTHEASTERN_COORIDOR_ASHVL.GOV
```

```
IP Host table is (10 of 512) 2% full
```

8. Display the associations assigned to the IP card specified in step 5, using the **rtrv-assoc** command with the local host name of the associations assigned to the IP card. To find the local host name of the association, the card location of the IP card is assigned to an IP address in the IP link table (**rtrv-ip-lnk** output). The IP address is assigned to a hostname in the IP host table (**rtrv-ip-host** output).

For this example, the local host name of associations assigned to the IP card 1308 (the card specified in step 5) is IPNODE2-1205. Enter this command.

```
rtrv-assoc:lhost=ipnode2-1205
```

The following is an example of the possible output.

```
rlghncxa03w 06-10-28 09:12:36 GMT EAGLE5 36.0.0
CARD IPLNK
ANAME LOC PORT LINK ADAPTER LPORT RPORT OPEN ALW
assoc2 1308 A A1 M2PA 2187 1025 YES YES
assoc4 1308 A B M2PA 3290 1025 YES YES
assoc5 1308 A B2 M2PA 1057 1025 YES YES
```

```
IP Appl Sock/Assoc table is (9 of 4000) 1% full
Assoc Buffer Space Used (600 KB of 3200 KB) on LOC = 1308
```

9. Change the value of the **open** parameter of the associations shown in step 8 to **no** by specifying the **chg-assoc** command with the **open=no** parameter. For this example, enter this command.

```
chg-assoc:aname=assoc2:open=no
chg-assoc:aname=assoc4:open=no
chg-assoc:aname=assoc5:open=no
```

When this command has successfully completed, this message should appear.

```
rlghncxa03w 06-10-28 09:12:36 GMT EAGLE5 36.0.0
CHG-ASSOC: MASP A - COMPLTD;
```

10. Change the value of the **open** parameter of the associations changed in step 9 to **yes** by specifying the **chg-assoc** command with the **open=yes** parameter. For this example, enter this command.

```
chg-assoc:aname=assoc2:open=yes
chg-assoc:aname=assoc4:open=yes
chg-assoc:aname=assoc5:open=yes
```

When this command has successfully completed, this message should appear.

```
rlghncxa03w 06-10-28 09:12:36 GMT EAGLE5 36.0.0
CHG-ASSOC: MASP A - COMPLTD;
```

11. Put the signaling links that were placed out of service in step 5 back into service using the **act-slk** command. For example, enter this command.

```
act-slk:loc=1308:link=a1
act-slk:loc=1308:link=b
act-slk:loc=1308:link=b2
```

When these commands have successfully completed, this message appears.

```
rlghncxa03w 06-10-07 11:11:28 GMT EAGLE5 36.0.0
Activate Link message sent to card
```

12. Verify the in-service normal (IS-NR) status of the signaling link by using the **rept-stat-slk** command and specifying the card location and link values specified in step 11. For example, enter these commands.

```
rept-stat-slk:loc=1308:link=a1
```

This message should appear.

```
rlghncxa03w 06-10-28 21:16:37 GMT EAGLE5 36.0.0
SLK      LSN      CLLI      PST      SST      AST
1308,A1  ipnode1  -----  IS-NR    Avail    ----
Command Completed.
```

```
rept-stat-slk:loc=1308:link=b
```

This message should appear.

```
rlghncxa03w 06-10-28 21:16:37 GMT EAGLE5 36.0.0
SLK      LSN      CLLI      PST      SST      AST
1308,B   ipnode3  -----  IS-NR    Avail    ----
Command Completed.
```



```
rept-stat-slk:loc=1308:link=b2
```

This message should appear.

```
rlghncxa03w 06-10-28 21:16:37 GMT EAGLE5 36.0.0
SLK      LSN      CLLI      PST      SST      AST
1308,B2  ipnode4  -----  IS-NR    Avail    ----
Command Completed.
```

13. Enter the `netstat -p sctp` pass command with the card location of the IP card to determine if any errors have occurred. For this example, enter this command.

```
pass:loc=1308:cmd="netstat -p sctp"
```

The following is an example of the possible output.

```
rlghncxa03w 06-10-28 21:16:37 GMT EAGLE5 36.0.0

SCTP:
  0 ip packets sent
    0 ip packets sent with data chunk
    0 control chunks (excludes retransmissions)
    0 ordered data chunks (excludes retransmissions)
    0 unordered data chunks (excludes retransmissions)
    0 user messages fragmented due to MTU
    0 retransmit data chunks sent
    0 sacks sent
    0 send failed
  0 ip packets received
    0 ip packets received with data chunk
    0 control chunks (excludes duplicates)
    0 ordered data chunks (excludes duplicates)
    0 unordered data chunks (excludes duplicates)
    0 user messages reassembled
    0 data chunks read
    0 duplicate tsns received
    0 sacks received
    0 gap ack blocks received
    0 out of the blue
    0 with invalid checksum
  0 connections established
    0 by upper layer
    0 by remote endpoint
  0 connections terminated
    0 ungracefully
    0 gracefully
  0 associations supported
  0 associations dropped due to retransmits
  0 consecutive retransmit timeouts
  0 retransmit timer count
  0 fast retransmit count
  0 heartbeat requests received
  0 heartbeat acks received
  0 heartbeat requests sent
  0 milliseconds cookie life at 4-way start-up handshake
  0 retransmission attempts are allowed at start-up phase

rlghncxa03w 06-10-28 21:16:37 GMT EAGLE5 36.0.0

NETSTAT command complete
```

If errors are shown in the pass command output, contact the Customer Care Center. Refer to "Customer Care Center" on page 1-9 for the contact information.

14. Repeat steps 5 through 13 to update the other IP cards in the EAGLE 5 ISS running the IPLIM and IPLIMI applications with the new SCTP checksum algorithm.

Once all the IP cards running the IPLIM and IPLIMI applications have been updated, and if the **rtrv-card** output in step 2 does not show any cards running the SS7IPGW or IPGWI applications, this procedure is finished after the database is backed up in step 16.

If the **rtrv-card** output in step 2 shows cards running the SS7IPGW or IPGWI applications, skip step 15 and go to step 16.

15. Back up the database by entering the **chg-db:action=backup:dest=fixed** command. These messages should appear, the active Maintenance and Administration Subsystem Processor (MASP) appears first.

```
BACKUP (FIXED) : MASP A - Backup starts on active MASP.
BACKUP (FIXED) : MASP A - Backup on active MASP to fixed disk complete.
BACKUP (FIXED) : MASP A - Backup starts on standby MASP.
BACKUP (FIXED) : MASP A - Backup on standby MASP to fixed disk complete.
```

16. At the IP near end node, stop all traffic to one of the IP cards running the SS7IPGW or IPGWI applications on the EAGLE 5 ISS.

17. At the EAGLE 5 ISS, enter the **msucount -1** pass command with the card location of the IP card selected in step 16. For this example, enter this command.

pass:loc=1315:cmd="msucount -1"

The following is an example of the possible output.

```
rlghncxa03w 06-10-28 21:16:37 GMT EAGLE5 36.0.0
PASS: Command sent to card
```

```
rlghncxa03w 06-10-28 21:16:37 GMT EAGLE5 36.0.0
MSUCOUNT: Command In Progress
```

```
rlghncxa03w 06-10-28 21:16:37 GMT EAGLE5 36.0.0
```

```
MSUCOUNT: MSU Count Report
```

```
-----
Link Measurements (Link A)
-----
```

| Transmit Counts | | | Receive Counts | | |
|-----------------|-------|-------|----------------|-------|-------|
| rate | msus | bytes | rate | msus | bytes |
| ----- | ----- | ----- | ----- | ----- | ----- |

IP⁷ Secure Gateway Configuration Procedures

```
2000 4294967295 4294967295      2000 4294967295 4294967295
```

```
MTP Primitive (MTPP) counts      Reroute Counts
-----
sent pdus   rcvd pdus   dscrd pdus   sent msus   rcvd msus
-----
4294967295 4294967295 4294967295 4294967295 4294967295
```

END of Report

-
- 18.** Display the IP addresses of the IP links in the database by entering the **rtrv-ip-lnk** command. The following is an example of the possible output.

```
rlghncxa03w 06-10-28 21:17:37 GMT EAGLE5 36.0.0
LOC  PORT  IPADDR          SUBMASK          DUPLEX  SPEED  MACTYPE  AUTO  MCAST
1202 A   192.1.1.10     255.255.255.0   HALF    10     DIX      NO   NO
1202 B   -----
1205 A   192.1.1.12     255.255.255.0   HALF    10     DIX      NO   NO
1205 B   -----
1207 A   192.1.1.14     255.255.255.0   HALF    10     DIX      NO   NO
1207 B   -----
1303 A   192.1.1.20     255.255.255.0   HALF    10     DIX      NO   NO
1303 B   -----
1305 A   192.1.1.22     255.255.255.0   HALF    10     DIX      NO   NO
1305 B   -----
1308 A   192.1.1.24     255.255.255.0   HALF    10     DIX      NO   NO
1308 B   -----
1315 A   192.1.1.50     255.255.255.0   HALF    10     DIX      NO   NO
1315 B   -----
1317 A   192.1.1.52     255.255.255.0   HALF    10     DIX      NO   NO
1317 B   -----
```

IP-LNK table is (16 of 512) 3% full.

-
- 19.** Display the current IP host information in the database by entering the **rtrv-ip-host** command. The following is an example of the possible output.

```
rlghncxa03w 06-10-28 21:17:37 GMT EAGLE5 36.0.0

LOCAL IPADDR  LOCAL HOST
192.1.1.10    IPNODE1-1201
192.1.1.12    IPNODE1-1203
192.1.1.14    IPNODE1-1205
192.1.1.20    IPNODE2-1201
192.1.1.22    IPNODE2-1203
192.1.1.24    IPNODE2-1205
192.1.1.32    KC-HLR2
192.1.1.50    DN-MS1
192.1.1.52    DN-MS2

REMOTE IPADDR  REMOTE HOST
150.1.1.5     NCDEPTECONOMIC_DEVELOPMENT.SOUTHEASTERN_COORIDOR_ASHVL.GOV
```

IP Host table is (10 of 512) 2% full

20. Display the associations assigned to the IP card specified in step 17, using the **rtrv-assoc** command with the local host name of the associations assigned to the IP card. To find the local host name of the association, the card location of the IP card is assigned to an IP address in the IP link table (**rtrv-ip-lnk** output). The IP address is assigned to a hostname in the IP host table (**rtrv-ip-host** output).

For this example, the local host name of associations assigned to the IP card 1315 (the card specified in step 17) is DN-MS1. Enter this command.

rtrv-assoc: lhost=dn-msc1

The following is an example of the possible output.

```
rlghncxa03w 06-10-28 21:17:37 GMT EAGLE5 36.0.0
CARD IPLNK
ANAME          LOC  PORT  LINK ADAPTER LPORT RPORT OPEN ALW
assoc3         1315 A    A    SUA    2345  1025  YES  YES
assoc6         1315 A    A    SUA    4156  1025  YES  YES

IP Appl Sock/Assoc table is (9 of 4000) 1% full
Assoc Buffer Space Used (32 KB of 3200 KB) on LOC = 1315
```

21. At the EAGLE 5 ISS, enter the **msucount -a** pass command with the card location specified in step 17 and the association names shown in step 20. For this example, enter this command.

pass: loc=1315: cmd="msucount -a assoc3"

The following is an example of the possible output.

```
rlghncxa03w 06-10-28 21:17:37 GMT EAGLE5 36.0.0
PASS: Command sent to card

rlghncxa03w 06-10-28 21:17:37 GMT EAGLE5 36.0.0
MSUCOUNT: Command In Progress

rlghncxa03w 06-10-28 21:17:37 GMT EAGLE5 36.0.0

MSUCOUNT: MSU Count Report
-----
IP Connection Measurements
-----

Receive Counts                               Transmit Counts
-----
msus          bytes                          msus          bytes
-----
4294967295    4294967295                                4294967295    4294967295

Receive Discard Counts                       Transmit Discard Counts
-----
reason          count                                       reason          count
-----
link state      4294967295                                sccp msg type   4294967295
sccp msg type   4294967295                                sccp class      4294967295
sccp class      4294967295                                normalization error 4294967295
sccp called party 4294967295                                invalid traffic type 4294967295
sccp calling party 4294967295                                M3UA conversion error 4294967295
isup sio        4294967295                                SUA conversion error 4294967295
```

IP7 Secure Gateway Configuration Procedures

```
normalization error 4294967295
error in XSRV packet 4294967295
M3UA PDU error      4294967295
SUA PDU error       4294967295
invalid rcontext    4294967295
```

```
Stored Transmit Discard Data
-----
no stored transmit discard data
```

```
Stored Receive Discard Data
-----
53 41 53 49 69 73 6f 74 11 00 87 0a 01 03 01 05
05 00 01 02 03 04 05 06 07 08 09 00 00 00 00 00
```

END of Report

pass:loc=1315:cmd="msucount -a assoc6"

The following is an example of the possible output.

```
rlghncxa03w 06-10-28 21:17:37 GMT EAGLE5 36.0.0
PASS: Command sent to card
```

```
rlghncxa03w 06-10-28 21:17:37 GMT EAGLE5 36.0.0
MSUCOUNT: Command In Progress
```

```
rlghncxa03w 06-10-28 21:17:37 GMT EAGLE5 36.0.0
```

MSUCOUNT: MSU Count Report

IP Connection Measurements

```
Receive Counts                      Transmit Counts
-----
msus          bytes                    msus          bytes
-----
4294967295    4294967295                    4294967295    4294967295

Receive Discard Counts              Transmit Discard Counts
-----
reason          count                    reason          count
-----
link state      4294967295                sccp msg type   4294967295
sccp msg type   4294967295                sccp class      4294967295
sccp class      4294967295                normalization error 4294967295
sccp called party 4294967295                invalid traffic type 4294967295
sccp calling party 4294967295                M3UA conversion error 4294967295
isup sio        4294967295                SUA conversion error 4294967295
normalization error 4294967295
error in XSRV packet 4294967295
M3UA PDU error  4294967295
SUA PDU error   4294967295
invalid rcontext 4294967295
```

```
Stored Transmit Discard Data
-----
no stored transmit discard data
```

```
Stored Receive Discard Data
```

```
-----
53 41 53 49 69 73 6f 74 11 00 87 0a 01 03 01 05
05 00 01 02 03 04 05 06 07 08 09 00 00 00 00 00
```

END of Report

-
22. At the IP near end node, disconnect all the associations attached to the IP card specified in step 21.
-

23. At the EAGLE 5 ISS, place the signaling link on this IP card out of service using the **dact-slk** command. For this example, enter this command.

```
dact-slk:loc=1315:link=a
```

When this command has successfully completed, this message appears.

```
rlghncxa03w 06-10-12 09:12:36 GMT EAGLE5 36.0.0
Deactivate Link message sent to card
```

NOTE: If the **chg-sg-opts** command was executed in step 3, skip steps 24 and 25, and go to step 26.

24. Change the SCTP checksum option in the database using the **chg-sg-opts** command. For this example, enter this command.

```
chg-sg-opts:sctpcsum=crc32c
```

When this command has successfully completed, the following message should appear.

```
rlghncxa03w 06-10-28 21:19:37 GMT EAGLE5 36.0.0
CHG-SG-OPTS: MASP A - COMPLTD
```

-
25. Verify that the SCTP checksum algorithm was changed using the **rtrv-sg-opts** command. The SCTP checksum algorithm option value is shown in the **SCTPCSUM** parameter. The following is an example of the possible output.

```
rlghncxa03w 06-10-28 21:16:37 GMT EAGLE5 36.0.0
SYNC:           TALI
SRKQ:           250
DRKQ:           750
SNMPCONT:      john doe 555-123-4567
GETCOMM:       public
SETCOMM:       private
TRAPCOMM:      public
INHFEPALM:     NO
SCTPCSUM:      crc32c
IPGWABATE:     NO
IPLIMABATE:    NO
IPTPSALMTHRESH: 80
```

26. Change the value of the **open** parameter of the associations shown in step 20 to **no** by specifying the **chg-assoc** command with the **open=no** parameter. For this example, enter this command.

```
chg-assoc:aname=assoc3:open=no
```

```
chg-assoc:aname=assoc6:open=no
```

When this command has successfully completed, this message should appear.

```
rlghncxa03w 06-10-28 09:12:36 GMT EAGLE5 36.0.0
CHG-ASSOC: MASP A - COMPLTD;
```

27. Change the value of the **open** parameter of the associations changed in step 26 to **yes** by specifying the **chg-assoc** command with the **open=yes** parameter. For this example, enter this command.

```
chg-assoc:aname=assoc3:open=yes
```

```
chg-assoc:aname=assoc6:open=yes
```

When this command has successfully completed, this message should appear.

```
rlghncxa03w 06-10-28 09:12:36 GMT EAGLE5 36.0.0
CHG-ASSOC: MASP A - COMPLTD;
```

28. At the IP near end node, configure all the associations attached to the IP card specified in step 27 to use the SCTP checksum algorithm.
-

29. Put the signaling link that was placed out of service in step 23 back into service using the **act-slk** command. For example, enter this command.

```
act-slk:loc=1315:link=a
```

When this command has successfully completed, this message appears.

```
rlghncxa03w 06-10-07 11:11:28 GMT EAGLE5 36.0.0
Activate Link message sent to card
```

30. Verify the in-service normal (IS-NR) status of the signaling link by using the **rept-stat-slk** command and specifying the card location and link value specified in step 29. For example, enter this command.

```
rept-stat-slk:loc=1315:link=a
```

The following is an example of the possible output.

```
rlghncxa03w 06-10-28 21:16:37 GMT EAGLE5 36.0.0
SLK      LSN      CLLI      PST      SST      AST
1315,A   ipgtwy1  -----  IS-NR    Avail    ----
Command Completed.
```

31. At the IP near end node, connect one of the associations attached to the IP card specified in step 29.
-

32. At the EAGLE 5 ISS, enter the **rept-stat-assoc** command specifying the association names specified with the **chg-assoc** command in steps 26 and 27 to verify that the association is established with the IP near end node. For this example, enter this command.

```
rept-stat-assoc:aname=assoc3
```

The following is an example of the possible output.

```
rlghncxa03w 06-10-28 21:16:37 GMT EAGLE5 36.0.0

                CARD IPLNK
ANAME           LOC  PORT  LINK  PST           SST           ASPID
as1             1315  A    A    IS-NR        ESTABLISHED  4294967295

ASNAME          ANAME          ASP-STATE
assoc3         as1             ASP-ACTIVE
```

Command Completed.

```
rept-stat-assoc:aname=assoc6
```

The following is an example of the possible output.

```
rlghncxa03w 06-10-28 21:16:37 GMT EAGLE5 36.0.0

                CARD IPLNK
ANAME           LOC  PORT  LINK  PST           SST           ASPID
as6             1315  A    A    IS-NR        ESTABLISHED  4294967295

ASNAME          ANAME          ASP-STATE
assoc6         as6             ASP-ACTIVE
```

Command Completed.

33. Enter the **netstat -p sctp** pass command with the card location of the IP card to determine if any errors have occurred. For this example, enter this command.

```
pass:loc=1315:cmd="netstat -p sctp"
```

The following is an example of the possible output.

```
rlghncxa03w 06-10-28 21:16:37 GMT EAGLE5 36.0.0

SCTP:
  0 ip packets sent
    0 ip packets sent with data chunk
    0 control chunks (excludes retransmissions)
    0 ordered data chunks (excludes retransmissions)
    0 unordered data chunks (excludes retransmissions)
    0 user messages fragmented due to MTU
    0 retransmit data chunks sent
    0 sacks sent
    0 send failed
  0 ip packets received
    0 ip packets received with data chunk
    0 control chunks (excludes duplicates)
    0 ordered data chunks (excludes duplicates)
    0 unordered data chunks (excludes duplicates)
```

IP7 Secure Gateway Configuration Procedures

```
0 user messages reassembled
0 data chunks read
0 duplicate tsns received
0 sacks received
0 gap ack blocks received
0 out of the blue
0 with invalid checksum
0 connections established
  0 by upper layer
  0 by remote endpoint
0 connections terminated
  0 ungracefully
  0 gracefully
0 associations supported
0 associations dropped due to retransmits
0 consecutive retransmit timeouts
0 retransmit timer count
0 fast retransmit count
0 heartbeat requests received
0 heartbeat acks received
0 heartbeat requests sent
0 milliseconds cookie life at 4-way start-up handshake
0 retransmission attempts are allowed at start-up phase
```

```
rlghncxa03w 06-10-28 21:16:37 GMT EAGLE5 36.0.0
```

```
NETSTAT command complete
```

If errors are shown in the pass command output, contact the Customer Care Center. Refer to "Customer Care Center" on page 1-9 for the contact information.

-
- 34.** At the IP near end node, connect all the other associations attached to the IP card specified in step 33.
-
- 35.** At the IP near end node, activate one of the associations attached to the IP card specified in step 33.
-
- 36.** At the EAGLE 5 ISS, enter the **msucount -1** pass command with the card location of the IP card specified in step 33. For this example, enter this command.

```
pass:loc=1315:cmd="msucount -1"
```

The following is an example of the possible output.

```
rlghncxa03w 06-10-28 21:16:37 GMT EAGLE5 36.0.0
PASS: Command sent to card
```

```
rlghncxa03w 06-10-28 21:16:37 GMT EAGLE5 36.0.0
MSUCOUNT: Command In Progress
```

```
rlghncxa03w 06-10-28 21:16:37 GMT EAGLE5 36.0.0
MSUCOUNT: MSU Count Report
```

```

-----
Link Measurements (Link A)
-----

Transmit Counts                                Receive Counts
-----
rate  msus      bytes          rate  msus      bytes
-----
2000  4294967295  4294967295   2000  4294967295  4294967295

MTP Primitive (MTPP) counts                    Reroute Counts
-----
sent pdus  rcvd pdus  dscrd pdus  sent msus  rcvd msus
-----
4294967295 4294967295 4294967295 4294967295 4294967295

END of Report

```

37. At the EAGLE 5 ISS, enter the **msucount -a** pass command with the card location specified in step 36 and the association names specified in step 32. For this example, enter this command.

pass:loc=1315:cmd="msucount -a assoc3"

The following is an example of the possible output.

```

rlghncxa03w 06-10-28 21:17:37 GMT EAGLE5 36.0.0
PASS: Command sent to card

rlghncxa03w 06-10-28 21:17:37 GMT EAGLE5 36.0.0
MSUCOUNT: Command In Progress

rlghncxa03w 06-10-28 21:17:37 GMT EAGLE5 36.0.0

MSUCOUNT: MSU Count Report
-----
IP Connection Measurements
-----

Receive Counts                                Transmit Counts
-----
msus      bytes          msus      bytes
-----
4294967295 4294967295   4294967295 4294967295

Receive Discard Counts                        Transmit Discard Counts
-----
reason          count          reason          count
-----
link state      4294967295    sccp msg type  4294967295
sccp msg type   4294967295    sccp class     4294967295
sccp class      4294967295    normalization error 4294967295
sccp called party 4294967295    invalid traffic type 4294967295
sccp calling party 4294967295    M3UA conversion error 4294967295
isup sio        4294967295    SUA conversion error 4294967295
normalization error 4294967295
error in XSRV packet 4294967295
M3UA PDU error  4294967295

```

IP7 Secure Gateway Configuration Procedures

```
SUA PDU error          4294967295
invalid rcontext       4294967295
```

```
Stored Transmit Discard Data
-----
no stored transmit discard data
```

```
Stored Receive Discard Data
-----
53 41 53 49 69 73 6f 74 11 00 87 0a 01 03 01 05
05 00 01 02 03 04 05 06 07 08 09 00 00 00 00 00
```

END of Report

pass:loc=1315:cmd="msucount -a assoc6"

The following is an example of the possible output.

```
rlghncxa03w 06-10-28 21:17:37 GMT EAGLE5 36.0.0
PASS: Command sent to card
```

```
rlghncxa03w 06-10-28 21:17:37 GMT EAGLE5 36.0.0
MSUCOUNT: Command In Progress
```

```
rlghncxa03w 06-10-28 21:17:37 GMT EAGLE5 36.0.0
```

MSUCOUNT: MSU Count Report

IP Connection Measurements

```
Receive Counts                      Transmit Counts
-----
msus          bytes                    msus          bytes
-----
4294967295    4294967295                    4294967295    4294967295

Receive Discard Counts              Transmit Discard Counts
-----
reason          count                          reason          count
-----
link state      4294967295                    sccp msg type   4294967295
sccp msg type   4294967295                    sccp class      4294967295
sccp class      4294967295                    normalization error 4294967295
sccp called party 4294967295                    invalid traffic type 4294967295
sccp calling party 4294967295                    M3UA conversion error 4294967295
isup sio        4294967295                    SUA conversion error 4294967295
normalization error 4294967295
error in XSRV packet 4294967295
M3UA PDU error  4294967295
SUA PDU error   4294967295
invalid rcontext 4294967295
```

```
Stored Transmit Discard Data
-----
no stored transmit discard data
```

```
Stored Receive Discard Data
-----
53 41 53 49 69 73 6f 74 11 00 87 0a 01 03 01 05
05 00 01 02 03 04 05 06 07 08 09 00 00 00 00 00
```

END of Report

If the outputs of the pass commands in steps 36 and 37 show that traffic is not flowing over the association, contact the Customer Care Center. Refer to "Customer Care Center" on page 1-9 for the contact information.

38. At the IP near end node, activate all the other associations attached to the IP card specified in step 37.
-

39. Repeat steps 16 through 38 to update the other IP cards in the EAGLE 5 ISS running the SS7IPGW and IPGWI applications with the new SCTP checksum algorithm.
-

40. Back up the new changes using the **chg-db:action=backup:dest=fixed** command. These messages should appear, the active Maintenance and Administration Subsystem Processor (MASP) appears first.

```
BACKUP (FIXED) : MASP A - Backup starts on active MASP.  
BACKUP (FIXED) : MASP A - Backup on active MASP to fixed disk complete.  
BACKUP (FIXED) : MASP A - Backup starts on standby MASP.  
BACKUP (FIXED) : MASP A - Backup on standby MASP to fixed disk complete.
```

Flowchart 3-42. Changing the SCTP Checksum Option (Sheet 1 of 7)

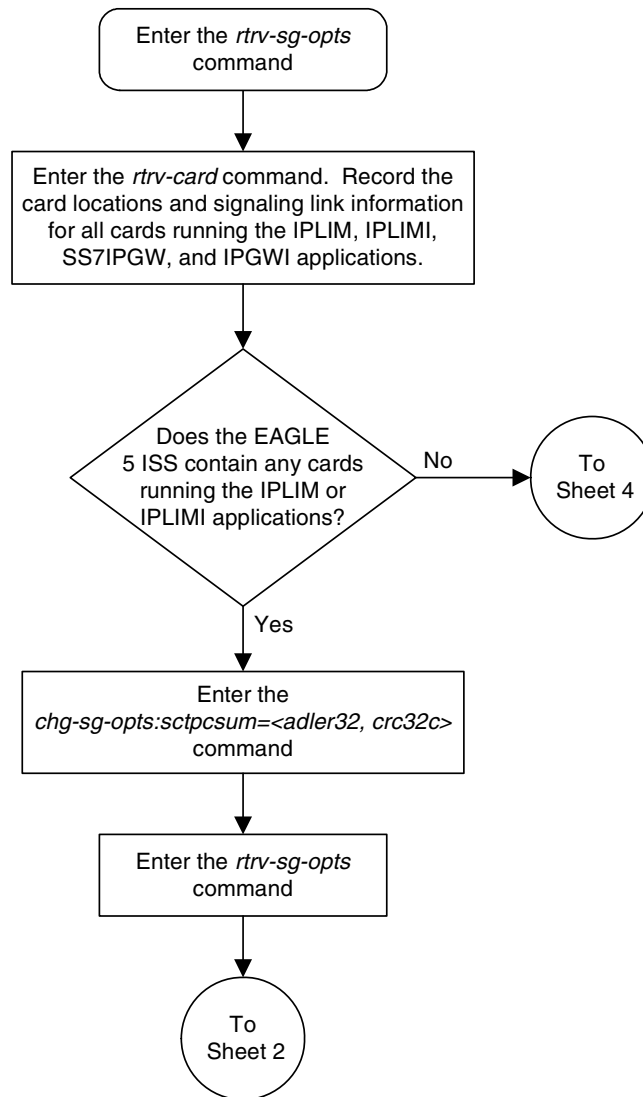

Flowchart 3-42. Changing the SCTP Checksum Option (Sheet 2 of 7)

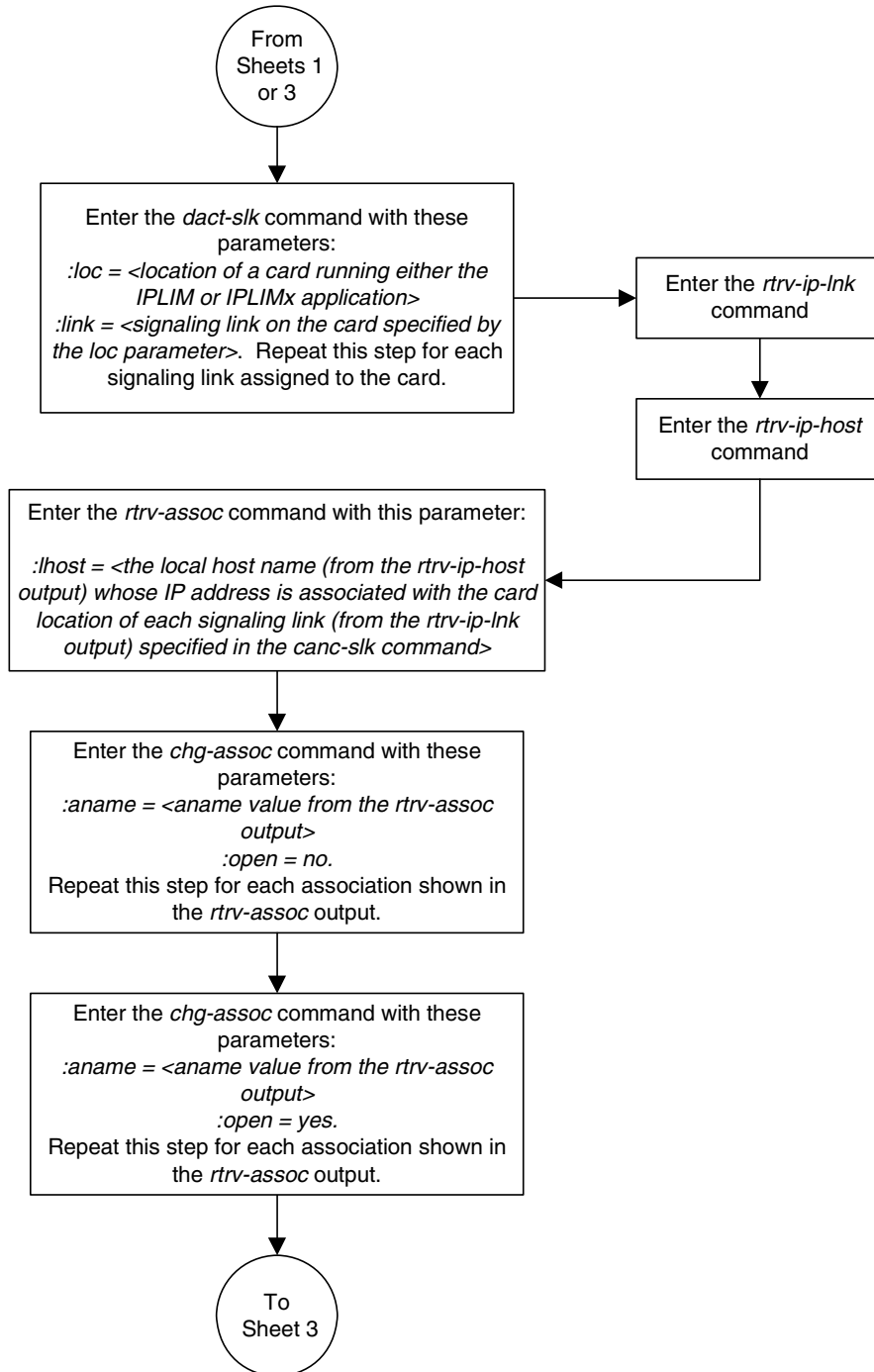

Flowchart 3-42. Changing the SCTP Checksum Option (Sheet 3 of 7)

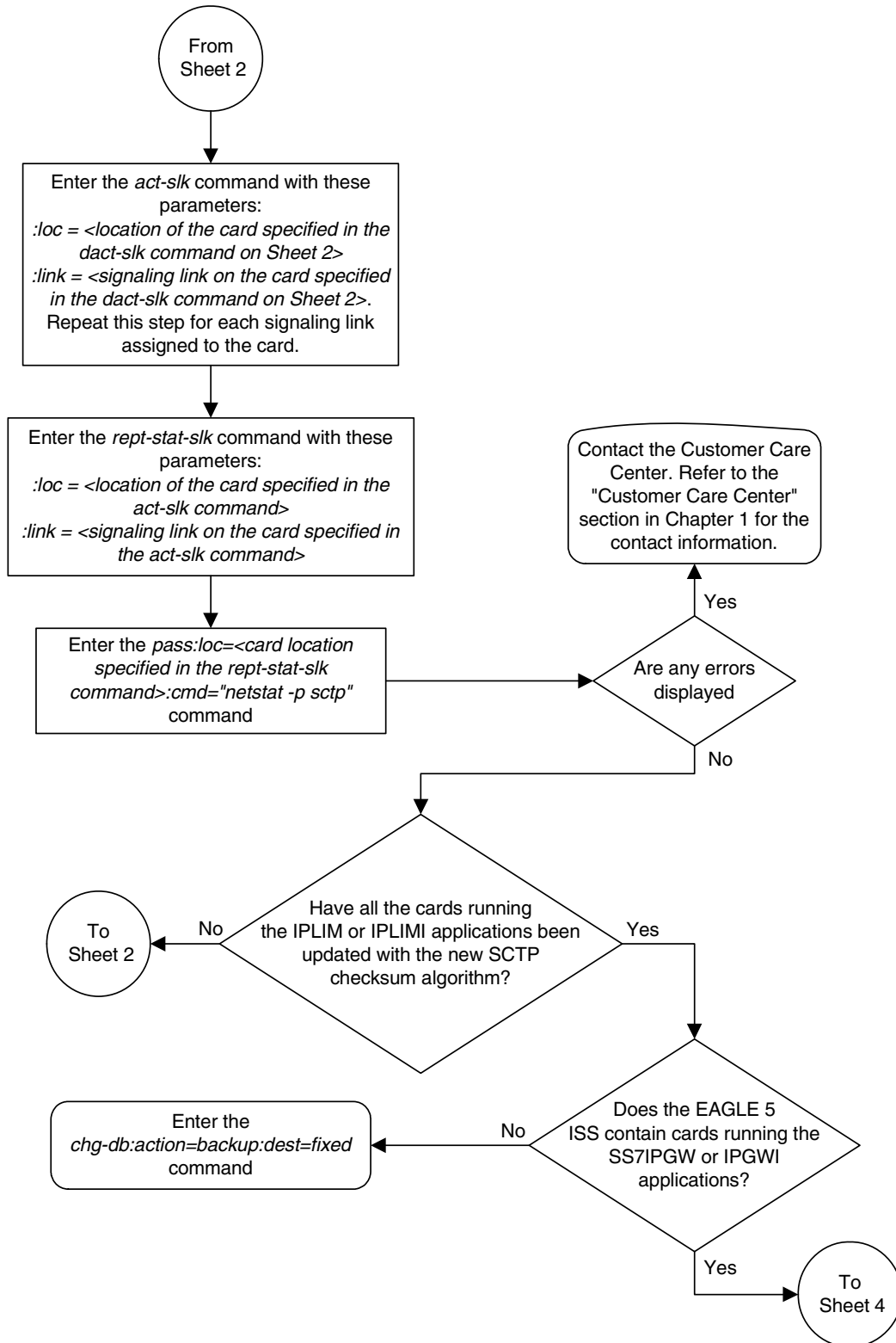

Flowchart 3-42. Changing the SCTP Checksum Option (Sheet 4 of 7)

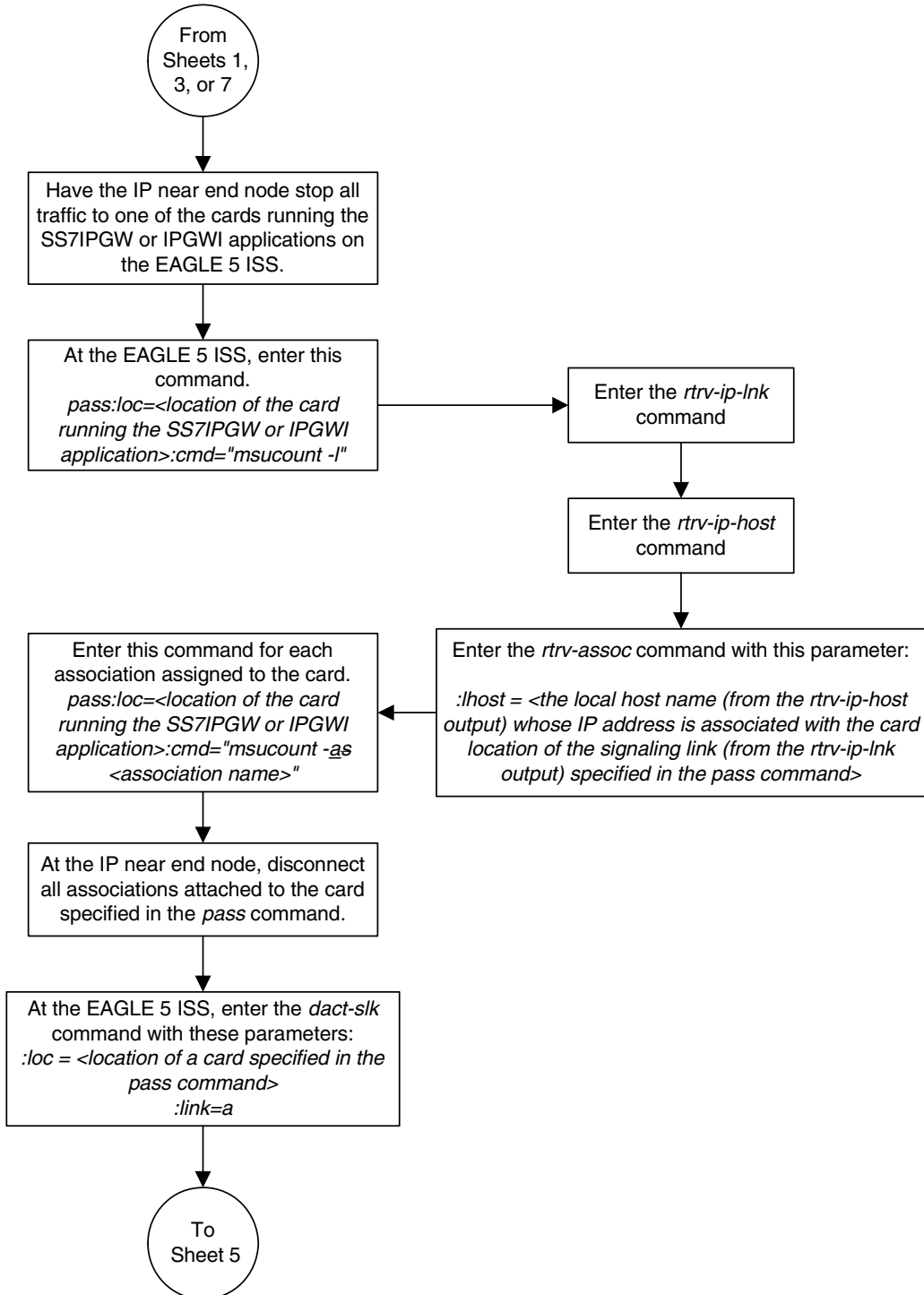

Flowchart 3-42. Changing the SCTP Checksum Option (Sheet 5 of 7)

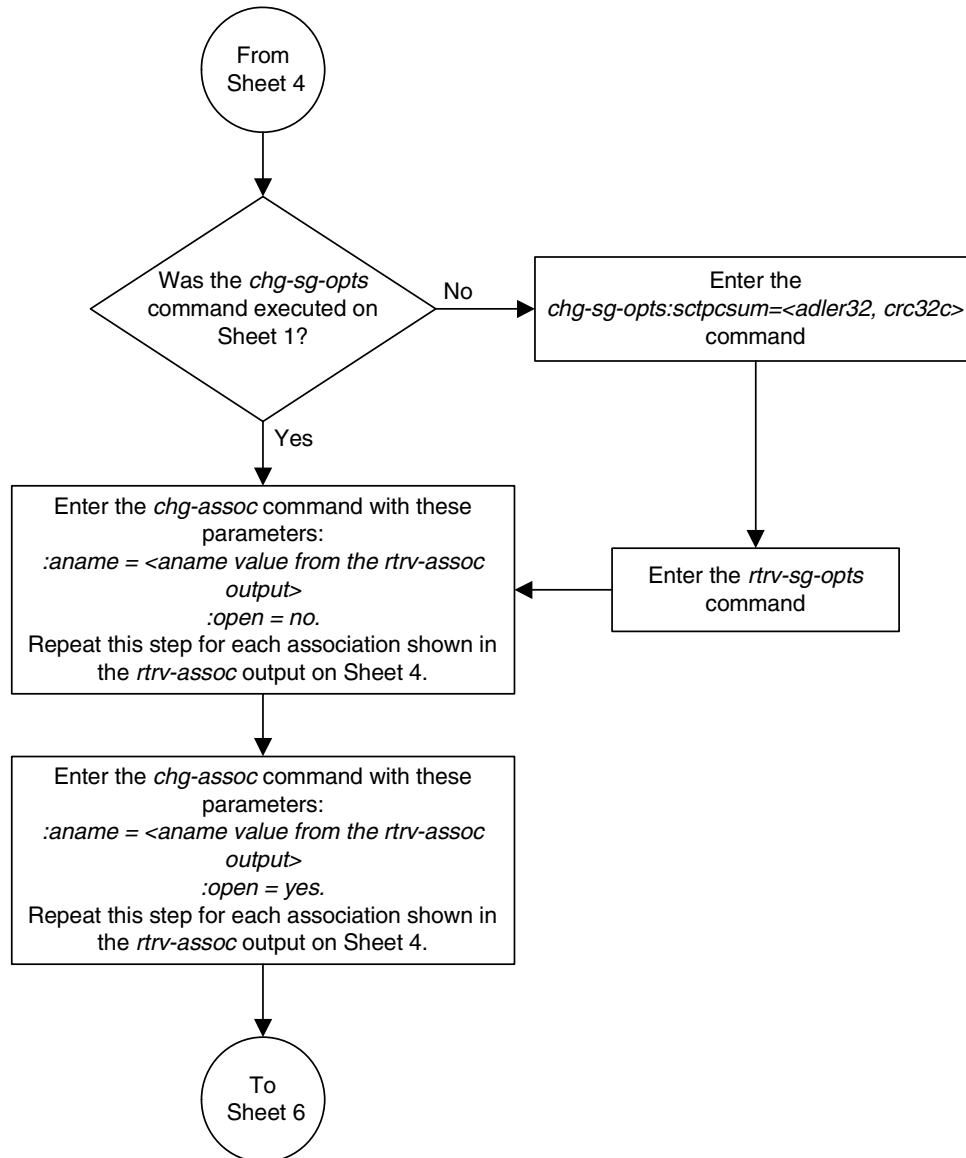

Flowchart 3-42. Changing the SCTP Checksum Option (Sheet 6 of 7)

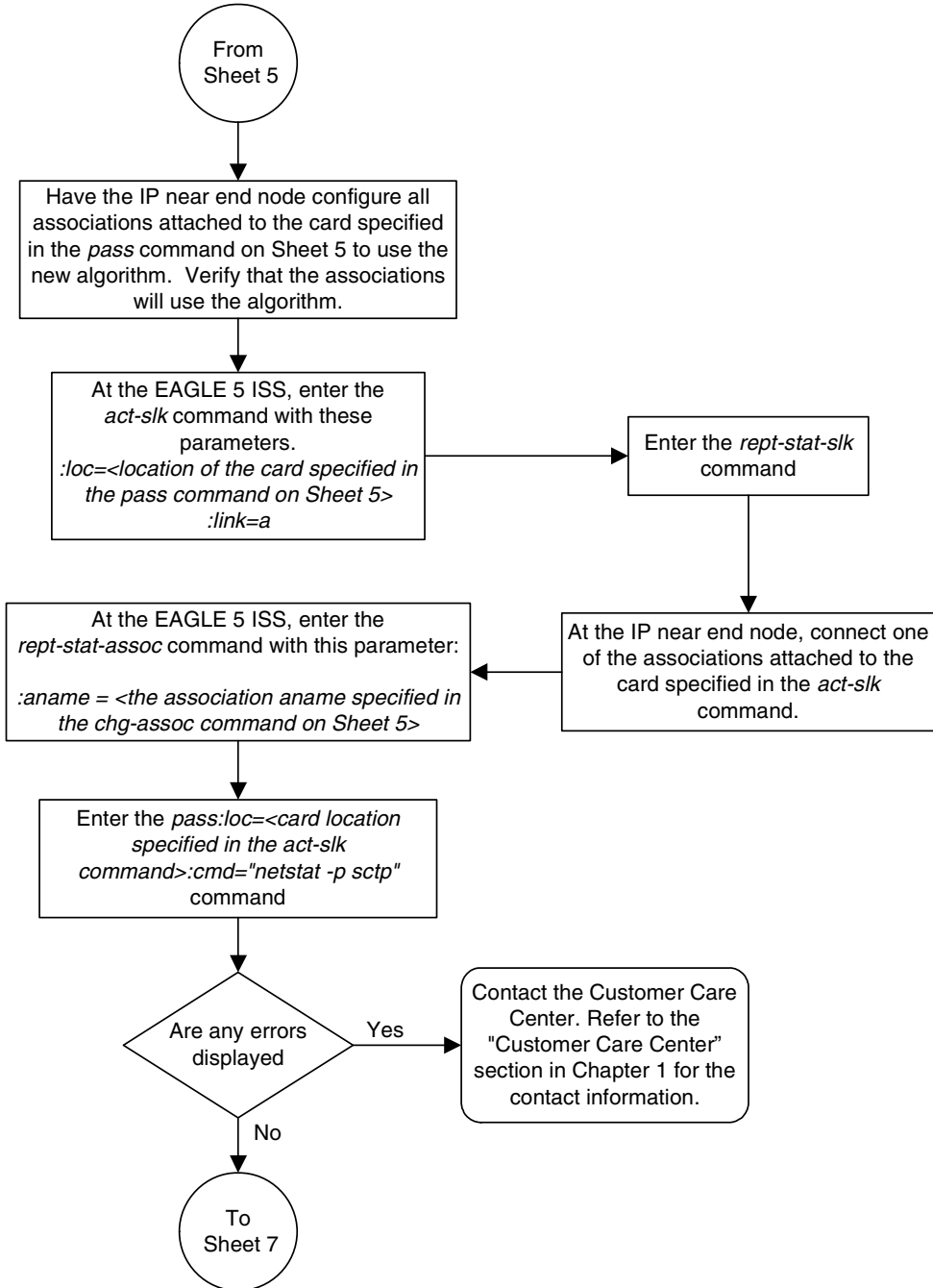

Flowchart 3-42. Changing the SCTP Checksum Option (Sheet 7 of 7)

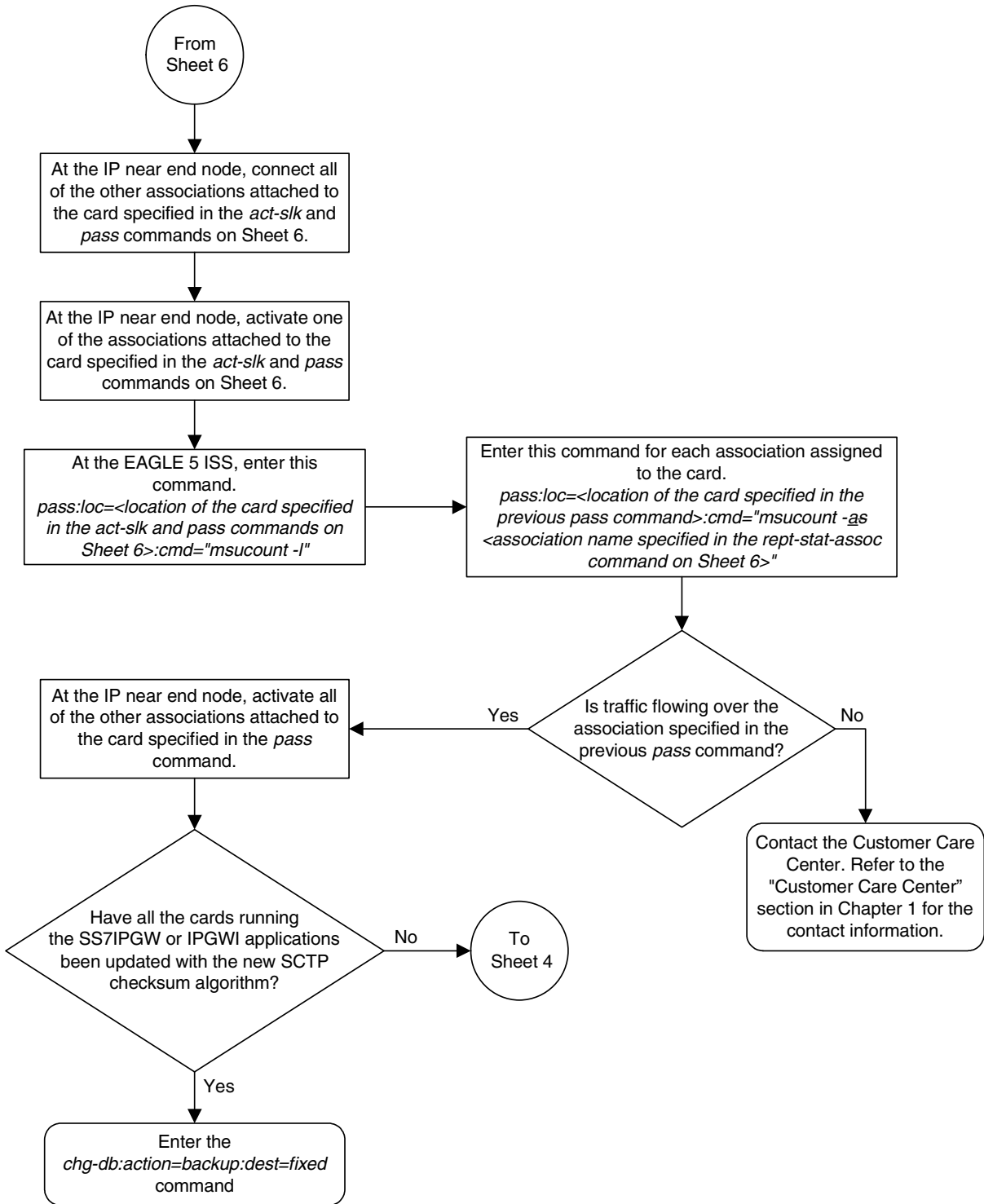

Changing a UA Parameter Set

Use this procedure to change the values in a UA (user adapter) parameter set using the **chg-uaps** command. The **chg-uaps** command uses these parameters:

:set – the UA parameter set being changed, from 1 - 9

:scrsset – the source UA parameter set used to copy the values from one UA parameter set to another, from 1 to 10.

:timer – the timer being changed, from 1 to 10. Currently, there are only three timers defined:

- Timer 2 – The False IP Connection Congestion Timer – the maximum amount of time (in milliseconds) that an association is allowed to remain congested before failing due to false connection congestion.
- Timer 3 – The UA Heartbeat Period Timer – The frequency, in milliseconds, that heartbeat messages are transmitted.
- Timer 4 – The UA Heartbeat Received Timer – The amount of time, in milliseconds, that the EAGLE 5 ISS waits for a response to the heartbeat message that was transmitted. If a response to the heartbeat message is not received in the amount of time defined by Timer 4, the association is torn down

:tvalue – The value of the timer specified by the **timer** parameter.

- The value of timer 2 is from 0 to 30,000 milliseconds. The system default value is 3,000 milliseconds.
- The value of timer 3 is from 0 to 60,000 milliseconds. The system default value is 10,000 milliseconds.
- The value of timer 4 is from 0 to 10,000 milliseconds. The system default value is 5,000 milliseconds.

:parm – the UA parameters, from 1 to 10. Currently, only two UA parameters are defined:

- 1 – Controlling ASP SNM Behavior
- 2 – Controlling ASP/Application Server State Notification Behavior
- 3 – UA Serviceability Options

:pvalue – the value of the UA parameters, which is dependent on the **parm** parameter value. The value of the **pvalue** parameter is a bit-mapped value, requiring a 0 in the specific bit position to disable the item, or a 1 in the specific bit position to enabled the item. The value of the **pvalue** parameter is a 32-bit number. Any bits not specified in the following lists are not used.

- If the **parm** value is 1, the bits used by the **pvalue** parameter are:
 - 0 – Broadcast – controls broadcast phase SNM TFPs, TFRs and TFAs

that are sent when a destination's status changes. If this flag is set, SNM TFPs/TFRs/TFAs are replicated to all associations/sockets that meet the Multicast SNM Criteria and have this enabled. The default is to enable all broadcast phase messages.

- 1 – Response Method – controls the sending of an SNM TFC/UPU as a reply to a message received on an association/socket for an unavailable destination. The SNM TFC/UPU is replicated to all associations/sockets that have this capability and meet the Response SNM Criteria. The default is to allow the response to be sent.
- 6 – Broadcast Congestion Status Change – controls the sending of unsolicited congestion status changes by an ASP. Unsolicited congestion status messages (TFCs generated when a destination's congestion status changes) are replicated to all ASPs who have this capability and meet the Multicast SNM Criteria. The default is to generate no unsolicited congestion status changes.

Table 3-36 shows the values can be entered for the **pvalue** parameter if the **parm** value is 1. The **pvalue** parameter value can be entered as a hexadecimal or a decimal number.

Table 3-36. Valid PVALUE Parameter Values if PARM=1

| Bits Enabled | Bits Disabled | Hexadecimal Value | Decimal Value |
|--|--|-------------------|---------------|
| None | Bit 0 - Broadcast Bit 1 - Response Method Bit 6 - Broadcast Congestion Status Change | h'0 | 0 |
| Bit 0 - Broadcast | Bit 1 - Response Method Bit 6 - Broadcast Congestion Status Change | h'1 | 1 |
| Bit 1 - Response Method | Bit 0 - Broadcast Bit 6 - Broadcast Congestion Status Change | h'2 | 2 |
| Bit 0 - Broadcast Bit 1 - Response Method | Bit 6 - Broadcast Congestion Status Change | h'3* | 3* |
| Bit 6 - Broadcast Congestion Status Change | Bit 0 - Broadcast Bit 1 - Response Method | h'40 | 64 |
| Bit 6 - Broadcast Congestion Status Change Bit 0 - Broadcast | Bit 1 - Response Method | h'41 | 65 |
| Bit 6 - Broadcast Congestion Status Change Bit 1 - Response Method | Bit 0 - Broadcast | h'42 | 66 |
| Bit 0 - Broadcast Bit 1 - Response Method Bit 6 - Broadcast Congestion Status Change | None | h'43 | 67 |

Table 3-36. Valid PVALUE Parameter Values if PARM=1 (Continued)

| Bits Enabled | Bits Disabled | Hexadecimal Value | Decimal Value |
|----------------------------|---------------|-------------------|---------------|
| * The system default value | | | |

- If the **parm** value is 2, the bits used by the **pvalue** parameter are:
 - 0 – ASP Active Notifications – controls the sending of ASP-Active notifications. If this value is specified, an ASP-Default notification is sent when an ASP transitions to the ASP-ACTIVE state. The default is not to send ASP-Active notifications.
 - 1 – ASP Inactive Notifications – controls the sending of ASP-Inactive notifications. If this value is specified, an ASP-Inactive notification is sent when an ASP transitions to the ASP-INACTIVE state. The default is not to send ASP-Inactive notifications.

NOTE: To see the ASP activations and inactivations, bits 0 and 1 of the **pvalue** parameter value need to be enabled. See Table 3-37 on page 3-488.

- 2 – ASP AS State Query – controls the sending of ASP/AS State notifications on request by an ASP. If this value is specified, the EAGLE 5 ISS responds with ASP and AS state notifications if the remote ASP sends ASP-UP or ASP-INACTIVE, while the local ASP is in the ASP-INACTIVE state, or the remote ASP sends an ASP-ACTIVE notification while the local ASP is in the ASP-ACTIVE state. The default is not to send ASP/AS state notifications.

Table 3-37 shows the values can be entered for the **pvalue** parameter if the **parm** value is 2. The **pvalue** parameter value can be entered as a hexadecimal or a decimal number.

Table 3-37. Valid PVALUE Parameter Values if PARM=2

| Bits Enabled | Bits Disabled | Hexadecimal Value | Decimal Value |
|--|--|-------------------|---------------|
| None | Bit 0 - ASP Activate Notifications Bit 1 - ASP Inactivate Notifications Bit 2 - ASP AS State Query | h'0* | 0* |
| Bit 0 - ASP Activate Notifications | Bit 1 - ASP Inactivate Notifications Bit 2 - ASP AS State Query | h'1 | 1 |
| Bit 1 - ASP Inactivate Notifications | Bit 0 - ASP Activate Notifications Bit 2 - ASP AS State Query | h'2 | 2 |
| Bit 0 - ASP Activate Notifications Bit 1 - ASP Inactivate Notifications | Bit 2 - ASP AS State Query | h'3 | 3 |
| Bit 2 - ASP AS State Query | Bit 0 - ASP Activate Notifications Bit 1 - ASP Inactivate Notifications | h'4 | 4 |

Table 3-37. Valid PVALUE Parameter Values if PARM=2 (Continued)

| Bits Enabled | Bits Disabled | Hexadecimal Value | Decimal Value |
|--|--------------------------------------|-------------------|---------------|
| Bit 0 - ASP Activate Notifications Bit 2 - ASP AS State Query | Bit 1 - ASP Inactivate Notifications | h'5 | 5 |
| Bit 1 - ASP Inactivate Notifications Bit 2 - ASP AS State Query | Bit 0 - ASP Activate Notifications | h'6 | 6 |
| Bit 0 - ASP Activate Notifications Bit 1 - ASP Inactivate Notifications Bit 2 - ASP AS State Query | None | h'7 | 7 |
| * The system default value | | | |

- If the **parm** value is 3, only bit 0 (UA heartbeats) is the only bit used by the **pvalue** parameter. If the value of this bit is 1 (h'1), heartbeat messages are transmitted in the ASP-Down, ASP-Active, and ASP-Inactive states on connections from the Eagle 5 ISS to the far-end node. If the value of this bit is 0, the heartbeat messages are not transmitted.

UA parameter set 10 contains the default values for the UA parameter sets and cannot be changed.

The **set** and **scrset** parameter values cannot be the same.

If the **scrset** parameter is specified, no other optional parameter may be specified.

The **timer** and **tvalue** parameters must be specified together. If one is specified, the other must be specified.

The **parm** and **pvalue** parameters must be specified together. If one is specified, the other must be specified.

Canceling the RTRV-UAPS Command

Because the **rtrv-uaps** command used in this procedure can output information for a long period of time, the **rtrv-uaps** command can be canceled and the output to the terminal stopped. There are three ways that the **rtrv-uaps** command can be canceled.

- Press the **F9** function key on the keyboard at the terminal where the **rtrv-uaps** command was entered.
- Enter the **canc-cmd** without the **trm** parameter at the terminal where the **rtrv-uaps** command was entered.
- Enter the **canc-cmd:trm=<xx>**, where **<xx>** is the terminal where the **rtrv-uaps** command was entered, from another terminal other than the terminal where the **rtrv-uaps** command was entered. To enter the **canc-cmd:trm=<xx>** command, the terminal must allow Security Administration commands to be entered from it and the user must be allowed to enter Security Administration commands. The terminal's permissions can

be verified with the `rtrv-secu-trm` command. The user's permissions can be verified with the `rtrv-user` or `rtrv-secu-user` commands.

For more information about the `canc-cmd` command, go to the *Commands Manual*.

Procedure

1. Display the values in the UA parameter set being changed by entering the `rtrv-uaps` command and specifying the desired UA parameter set number, from 1 to 9. For this example, enter this command.

```
rtrv-uaps:set=3
```

This is an example of possible output.

```
rlghncxa03w 06-10-28 09:12:36 GMT EAGLE5 36.0.0
SET  TIMER      TVALUE  PARM      PVALUE
 3      1          0        1          3
 3      2         3000     2          0
 3      3        10000    3          1
 3      4         5000     4          0
 3      5          0        5          0
 3      6          0        6          0
 3      7          0        7          0
 3      8          0        8          0
 3      9          0        9          0
 3     10          0       10          0
```

TIMER 2: False IP Connection Congestion Timer, max time an association can be congested before failing due to false congestion. SS7IPGW and IPGWI applications enforce 0-30000(ms).

TVALUE : Valid range = 32-bits

TIMER 3: UA Heartbeat Period Timer T(beat), time (ms) between sending of BEAT msgs by NE, SS7IPGW and IPGWI applications enforce 100(ms)-60000(ms).

TVALUE : Valid range = 32-bits

TIMER 4: UA Heartbeat Received Timer T(beat ack), timeout period for response BEAT ACK msgs by NE, SS7IPGW and IPGWI applications enforce 100(ms)-10000(ms).

TVALUE : Valid range = 32-bits

PARM 1: ASP SNM options. Each bit is used as an enabled/disabled flag for a particular ASP SNM option.

PVALUE : Valid range = 32-bits

| BIT | BIT VALUE |
|--------------------------------------|------------------------|
| 0=Broadcast | 0=Disabled , 1=Enabled |
| 1=Response Method | 0=Disabled , 1=Enabled |
| 2-5=Reserved | |
| 6=Broadcast Congestion Status Change | 0=Disabled , 1=Enabled |
| 7-31=Reserved | |

PARM 2: ASP/AS Notification options. Each bit is used an enabled/disabled flag for a particular ASP/AS Notification option.

PVALUE : Valid range = 32-bits

| BIT | BIT VALUE |
|----------------------------|------------------------|
| 0=ASP Active Notifications | 0=Disabled , 1=Enabled |

| | |
|------------------------------|------------------------|
| 1=ASP Inactive Notifications | 0=Disabled , 1=Enabled |
| 2=ASP AS State Query | 0=Disabled , 1=Enabled |
| 3-31=Reserved | |

PARM 3: UA Serviceability Options. Each bit is used as an enabled/disabled flag for a particular UA serviceability option.
PVALUE : Valid range = 32-bits
BIT BIT VALUE
0=UA Heartbeats 0=Disabled , 1=Enabled
1-31=Reserved

2. Change the UA parameter set values using the **chg-uaps** command with the UA parameter set value used in step 1. If the **parm** and **pvalue** parameters are being specified, see Table 3-36 on page 3-487, Table 3-37 on page 3-488, or the description of the **parm=3** parameter on page 3-489 for the valid values of the **pvalue** parameter. For this example, enter this command.

chg-uaps:set=3:timer=2:tvalue=2000:parm=2:pvalue=1

The value of the **pvalue** parameter can be entered as either a decimal value or a hexadecimal value. This example shows the **pvalue** parameter value of the **chg-uaps** command being entered as a decimal value. To specify the value of the **pvalue** parameter in the example used in this step as a hexadecimal value, specify the **pvalue=h'1** parameter.

chg-uaps:set=3:timer=2:tvalue=2000:parm=2:pvalue=h'1

If the values from one UA parameter set are being copied to another UA parameter set, only the **set** and **scrset** parameters can be specified with the **chg-uaps** command. For example, to copy the values from UA parameter set 10 to UA parameter set 5, enter this command.

chg-uaps:set=5:scrset=10

When this command has successfully completed, this message should appear.

```
rlghncxa03w 06-10-28 09:12:36 GMT EAGLE5 36.0.0
CHG-UAPS: MASP A - COMPLTD
```

3. Verify the changes using the **rtrv-uaps** command with the UA parameter set name used in step 2. For this example, enter this command.

rtrv-uaps:set=3

This is an example of possible output.

```
rlghncxa03w 06-10-28 09:12:36 GMT EAGLE5 36.0.0
SET  TIMER      TVALUE  PARM      PVALUE
3     1           0        1          3
3     2          2000     2          1
3     3          10000    3          1
3     4           5000     4          0
3     5            0        5          0
3     6            0        6          0
3     7            0        7          0
3     8            0        8          0
3     9            0        9          0
```

3 10 0 10 0

TIMER 2: False IP Connection Congestion Timer, max time an association can be congested before failing due to false congestion. SS7IPGW and IPGWI applications enforce 0-30000(ms).

TVALUE : Valid range = 32-bits

TIMER 3: UA Heartbeat Period Timer T(beat), time (ms) between sending of BEAT msgs by NE, SS7IPGW and IPGWI applications enforce 100(ms)-60000(ms).

TVALUE : Valid range = 32-bits

TIMER 4: UA Heartbeat Received Timer T(beat ack), timeout period for response BEAT ACK msgs by NE, SS7IPGW and IPGWI applications enforce 100(ms)-10000(ms).

TVALUE : Valid range = 32-bits

PARM 1: ASP SNM options. Each bit is used as an enabled/disabled flag for a particular ASP SNM option.

PVALUE : Valid range = 32-bits

| BIT | BIT VALUE |
|--------------------------------------|------------------------|
| 0=Broadcast | 0=Disabled , 1=Enabled |
| 1=Response Method | 0=Disabled , 1=Enabled |
| 2-5=Reserved | |
| 6=Broadcast Congestion Status Change | 0=Disabled , 1=Enabled |
| 7-31=Reserved | |

PARM 2: ASP/AS Notification options. Each bit is used an enabled/disabled flag for a particular ASP/AS Notification option.

PVALUE : Valid range = 32-bits

| BIT | BIT VALUE |
|------------------------------|------------------------|
| 0=ASP Active Notifications | 0=Disabled , 1=Enabled |
| 1=ASP Inactive Notifications | 0=Disabled , 1=Enabled |
| 2=ASP AS State Query | 0=Disabled , 1=Enabled |
| 3-31=Reserved | |

PARM 3: UA Serviceability Options. Each bit is used as an enabled/disabled flag for a particular UA serviceability option.

PVALUE : Valid range = 32-bits

| BIT | BIT VALUE |
|-----------------|------------------------|
| 0=UA Heartbeats | 0=Disabled , 1=Enabled |
| 1-31=Reserved | |

4. Back up the new changes, using the **chg-db:action=backup:dest=fixed** command. These messages should appear; the active Maintenance and Administration Subsystem Processor (MASP) appears first.

```
BACKUP (FIXED) : MASP A - Backup starts on active MASP.
BACKUP (FIXED) : MASP A - Backup on active MASP to fixed disk complete.
BACKUP (FIXED) : MASP A - Backup starts on standby MASP.
BACKUP (FIXED) : MASP A - Backup on standby MASP to fixed disk complete.
```

Flowchart 3-43. Changing a UA Parameter Set

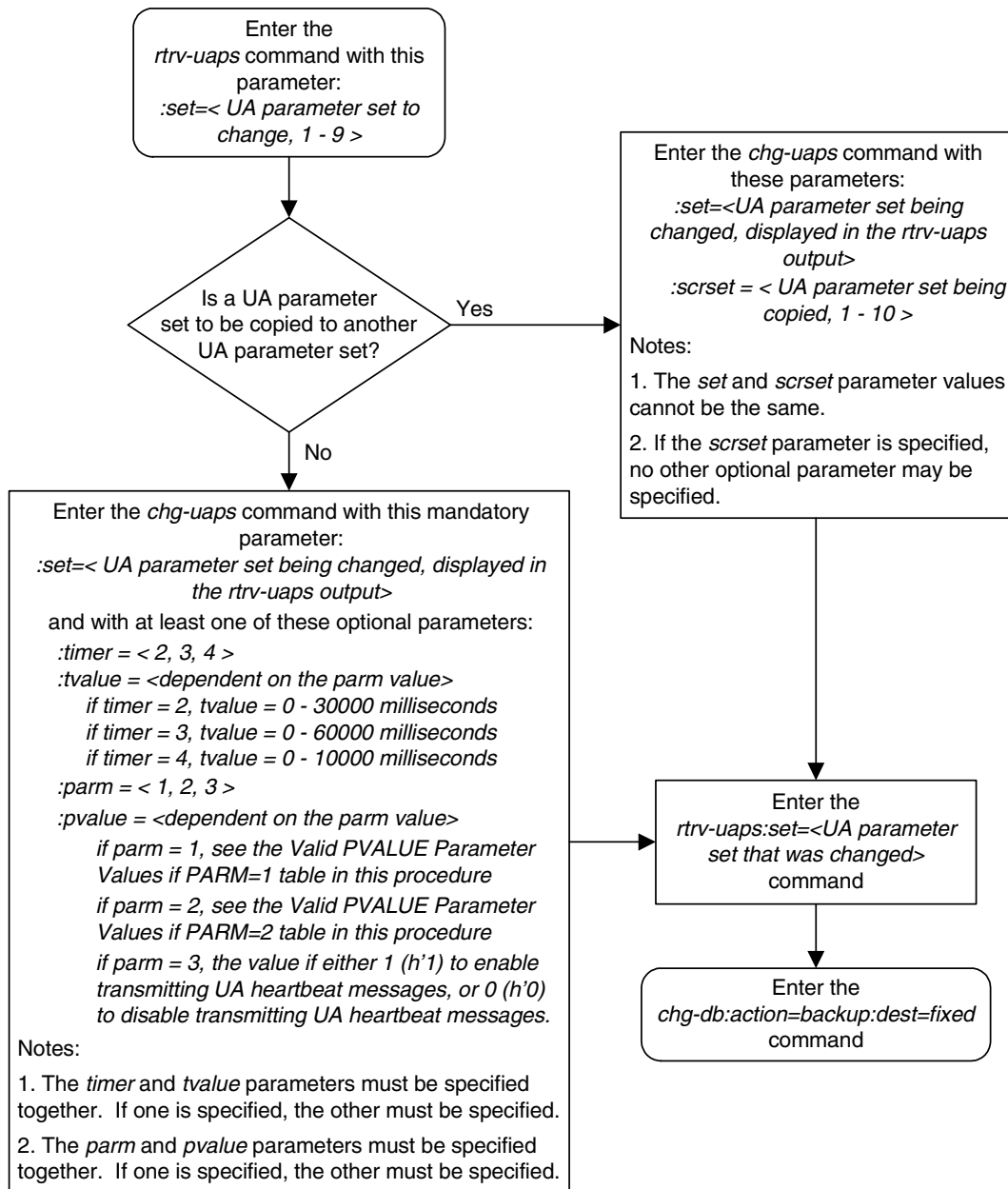

4

ISUP Variant Table Provisioning

| | |
|---|------|
| Overview | 4-2 |
| Adding New ISUP PSTN Presentation Values..... | 4-6 |
| Changing ISUP Presentation Values..... | 4-11 |
| Removing ISUP Presentation Values | 4-13 |
| Changing ISUP Variant Table Entries..... | 4-17 |
| Copying ISUP Variant Table Entries | 4-26 |

Overview

ISUP Normalization is Tekelec's process of converting/translating different customized versions of the ISUP protocol into one standard protocol (Normalized ISUP) for transmission to an IP device. This process also includes the reverse scenario, receiving Normalized ISUP messages from an IP device and denormalizing the message into customized versions.

The EAGLE 5 ISS supports end-user ISUP Normalization Administration. It is now possible to use the EAGLE 5 ISS's commands to achieve the following:

- Define and display new PSTN Presentation values for user-defined variants
- Provision a variant database starting from scratch
- Provision a variant database by copying another variants database
- Define the ISUP message types for a variant
- Define the ISUP parameters for a variant and the minimum length that is valid for each parameter
- Define the optional ISUP parameters supported for each ISUP message type
- Define the mandatory-fixed and mandatory-variable parameters that are supported for each ISUP message type and the order they appear in the message
- Assign a "conversion action" to ISUP messages and message/parameter combinations within a specific variant that require special software treatment
- Display the variant database

Prior implementations of the ISUP Normalization feature kept the ISUP data in hard-coded software tables. Changing ISUP parameters could only be achieved by means of a software revision. The disk-resident ISUP variant table eliminates this problem and increases flexibility and maintainability. This table include an entry in the variant's ISUP database table for each variant. When the **ent-pstn-pres** command is used to define a PSTN value, the first available entry in the ISUP variant database table is automatically allocated. The table entry is initialized to default values.

The ETSI V3 variant database is treated differently from other variants. It is automatically configured by the EAGLE 5 ISS during an upgrade or new installation. You will not have to enter the **ent-pstn-pres** command to define it. You cannot modify or delete the table entry for this variant, except to change the descriptive text.

The ISUP variant table supports a maximum of 21 entries, one of which is always the ETSI V3 variant. This allows for 20 entries for Tekelec-defined or user-defined ISUP variants.

ISUP Variant Table Provisioning

The normalization process occurs in the following steps:

1. The EAGLE 5 ISS receives a variant ISUP message from a PSTN.
2. The routing key variant database tables are accessed and provide the following information:
 - Indicates the message is to be routed to an IP device
 - Contains the PSTN Presentation value identifying the variant
 - Contains a “normalization flag” indicating the message is to be normalized
3. The software accesses database tables for the variant. The software performs some minor syntax validation on the received message and then constructs a normalized ISUP message.
4. The normalized message is sent in a TALI packet across an IPGWI connection to a far-end IP device.

The normalization function is performed entirely on the IPGWI card in the EAGLE 5 ISS. Everything presented to the MGCs that are using this feature is in normalized ISUP format. Everything that is presented to the MTP3 portion of the IPGWI card (to be routed back to a DS0 link towards the PSTN) is in the format for a specific ISUP variant. Each DS0 LIM (or any LIM in the EAGLE 5 ISS other than the IPGWI) receives MSUs from the PSTN wire and from the IMT in the same ISUP variant format. The DS0 LIMS do not know how to perform ISUP Normalization, and do not even know that it is occurring on the IPGWI cards.

The ISUP Normalization feature supports the normalization of the ISUP variants shown in Table 4-1.

Table 4-1. ISUP Variants Supported by this Feature

| ISUP Variant | Part No. | PSTN Category | PSTN ID |
|--------------------------------|-------------|---------------|---------|
| ISUP Normalization | 893000201 | 1 | * |
| ITU Q.767 Normalization | 893000501 | 1 | 1 |
| ESTI V3 Normalization | 893000601 | 1 | 2 |
| UK PNO-ISC7 Normalization | 893000401 | 1 | 3 |
| German ISUP Normalization | 893000301 | 1 | 4 |
| French ISUP Normalization | 893-0007-01 | 1 | 5 |
| Sweden ISUP Normalization | 893-0008-01 | 1 | 6 |
| Belgium ISUP Normalization | 893-0009-01 | 1 | 7 |
| Netherlands ISUP Normalization | 893-0010-01 | 1 | 8 |

Table 4-1. ISUP Variants Supported by this Feature (Continued)

| ISUP Variant | Part No. | PSTN Category | PSTN ID |
|---|-----------------|----------------------|----------------|
| Switzerland ISUP Normalization | 893-0011-01 | 1 | 9 |
| Austria ISUP Normalization | 893-0012-01 | 1 | 10 |
| Italy ISUP Normalization | 893-0013-01 | 1 | 11 |
| Ireland ISUP Normalization | 893-0014-01 | 1 | 12 |
| India ISUP Normalization | 893-0015-01 | 1 | 13 |
| Malaysia ISUP Normalization | 893-0016-01 | 1 | 14 |
| Vietnam ISUP Normalization | 893-0017-01 | 1 | 15 |
| South Africa ISUP Normalization | 893-0018-01 | 1 | 16 |
| Argentina ISUP Normalization | 893-0019-01 | 1 | 17 |
| Chile ISUP Normalization | 893-0020-01 | 1 | 18 |
| Venezuela ISUP Normalization | 893-0021-01 | 1 | 19 |
| Mexico ISUP Normalization | 893-0022-01 | 1 | 20 |
| Brazil ISUP Normalization | 893-0023-01 | 1 | 21 |
| Spain ISUP Normalization | 893-0024-01 | 1 | 22 |
| Colombia ISUP Normalization | 893-0025-01 | 1 | 23 |
| Peru ISUP Normalization | 893-0026-01 | 1 | 24 |
| Hong Kong ISUP Normalization | 893-0027-01 | 1 | 25 |
| China ISUP Normalization | 893-0028-01 | 1 | 26 |
| Japan ISUP Normalization | 893-0029-01 | 1 | 27 |
| Korea ISUP Normalization | 893-0030-01 | 1 | 28 |
| Taiwan ISUP Normalization | 893-0031-01 | 1 | 29 |
| Philippines ISUP Normalization | 893-0032-01 | 1 | 30 |
| Singapore ISUP Normalization | 893-0033-01 | 1 | 31 |
| Australia ISUP Normalization | 893-0034-01 | 1 | 32 |
| Reserved for future definition by Tekelec | | 2 through 4095 | |
| Available for user-defined categories | | 4095 through 65535 | |

ISUP Variant Table Provisioning

The Quantity Control feature allows a customer to provision a specified quantity of user-defined variants within the PSTN categories 4096 - 65535. Each Quantity Control Feature is associated with a specific quantity of variants. To provision user-defined variants, it is necessary to purchase the appropriate Feature Access Keys from Tekelec. Variants enabled using the Quantity Control feature do not have associated PSTN Presentation values.

The part number for user-defined variants is 893-0100-nn, where nn is a number ranging from 01 to 20. Use part number 893-0100-01 to order one new variant, 893-0100-05 to order five new variants, and so on.

Adding New ISUP PSTN Presentation Values

This procedure is used to add a new ISUP presentation value to the ISUP variant table, using the **ent-pstn-pres** command.

The PSTN Presentation value, consisting of a PSTN Category and PSTN ID, is used by the EAGLE 5 ISS to uniquely define an ISUP variant. The assignment of a new PSTN value also creates a new entry in the ISUP variant table. The new PSTN value must be unique.

This procedure may be used to define values within the Tekelec-defined range (PSTN Category 0-4095) as long as these control features are enabled:

- the controlled feature for the new PSTN category
- ISUP Normalization control feature

This command may be used to define values within the user-defined range (PSTN Category 4096-65535) as long as these control features are enabled:

- the controlled feature for the new PSTN category
- ISUP Normalization control feature
- ISUP Normalization Quantity control feature, to make sure that the quantity of user-defined PSTN categories is not exceeded.

The **ent-pstn-pres** command uses these parameters:

:pstncat - The PSTN Category identifying the new variant being defined is mandatory. Valid values for this parameter range from 0 to 65535.

:pstnid - The PSTN ID identifying the new variant being defined is mandatory. Valid values for this parameter range from 0 to 65535.

:pstndesc - The PSTN Description, a text description of the PSTN Presentation value, is optional. It should be used to describe the variant associated with the PSTN. This field is displayed by the **rtrv-pstn-pres** command and it has no other purpose. This alphanumeric string 0-31 characters in length is delimited with quotation marks.

Valid **pstncat** and **pstnid** parameter values are listed in Table 4-1 on page 4-3.

Procedure

1. Display the current value of the ISUP PSTNs using the `rtrv-pstn-pres` command. This is an example of possible output:

```
rlghncxa03w 06-10-28 21:17:37 GMT EAGLE5 36.0.0
PSTNCAT PSTNID PSTNDESC
00001 00001 ITU Q.767
00001 00002 ETSI V3
00001 00003 UK PNO-ISC7
00001 00004 GERMAN ISUP
00001* 00020 Mexico
04096 01000 User Defined 4096/1000
```

ISUP Variant table is (6 of 21) 29% full

NOTE: An * will be displayed next to the PSTN Category for entries that are no longer usable. These are entries that are disabled because their temporary feature key expired.

2. Display enabled controlled feature information in the database by entering the `rtrv-ctrl-feat` command. The following is an example of the possible output.

```
rlghncxa03w 06-10-28 21:15:37 GMT EAGLE5 36.0.0
The following features have been permanently enabled:
```

| Feature Name | Partnum | Status | Quantity |
|-----------------------|-----------|--------|----------|
| IPGWx Signaling TPS | 893012814 | on | 20000 |
| ISUP Normalization | 893000201 | on | ---- |
| ETSI v3 Normalization | 893000601 | on | ---- |
| HC-MIM SLK Capacity | 893012707 | on | 64 |

The following features have been temporarily enabled:

| Feature Name | Partnum | Status | Quantity | Trial Period Left |
|---------------------|---------|--------|----------|-------------------|
| Zero entries found. | | | | |

The following features have expired temporary keys:

| Feature Name | Partnum |
|---------------------|---------|
| Zero entries found. | |

If the ISUP Normalization control feature, the controlled feature for the new PSTN category, and if a user-defined PSTN category is being changed, or the ISUP Normalization Quantity control feature have not been enabled and turned on, go to the “Enabling Controlled Features” procedure on page 6-2 and to “Turning On and Off Controlled Features” procedure on page 6-10 to enable and turn on these controlled features.

3. Enter the desired new ISUP PSTN using the `ent-pstn-pres` command. For this example, enter this command.

```
ent-pstn-pres:pstncat=5000:pstnid=1
:pstndesc="Mexican ISUP v1.8"
```

When this command has successfully completed, the following message should appear.

```
rlghncxa03w 06-10-10 11:43:04 GMT EAGLE5 36.0.0
ENT-PSTN-PRES: MASP A - COMPLTD
```

4. Verify that the new ISUP PSTN has been added to the database using the `rtrv-pstn-pres` command. This is an example of possible output:

```
rlghncxa03w 06-10-28 21:17:37 GMT EAGLE5 36.0.0
PSTNCAT PSTNID PSTNDESC
00001 00001 ITU Q.767
00001 00002 ETSI V3
00001 00003 UK PNO-ISC7
00001 00004 GERMAN ISUP
00001* 00020 Mexico
04096 01000 User Defined 4096/1000
05000 00001 Mexican ISUP v1.8
```

ISUP Variant table is (7 of 21) 33% full

NOTE: An * will be displayed next to the PSTN Category for entries that are no longer usable. These are entries that are disabled because their temporary feature key expired.

5. Back up the new changes, using the `chg-db:action=backup:dest=fixed` command. These messages should appear; the active Maintenance and Administration Subsystem Processor (MASP) appears first.

```
BACKUP (FIXED) : MASP A - Backup starts on active MASP.
BACKUP (FIXED) : MASP A - Backup on active MASP to fixed disk complete.
BACKUP (FIXED) : MASP A - Backup starts on standby MASP.
BACKUP (FIXED) : MASP A - Backup on standby MASP to fixed disk complete.
```

ISUP Variant Table Provisioning

Flowchart 4-1. Adding ISUP PSTN Presentation Value (Sheet 1 of 2)

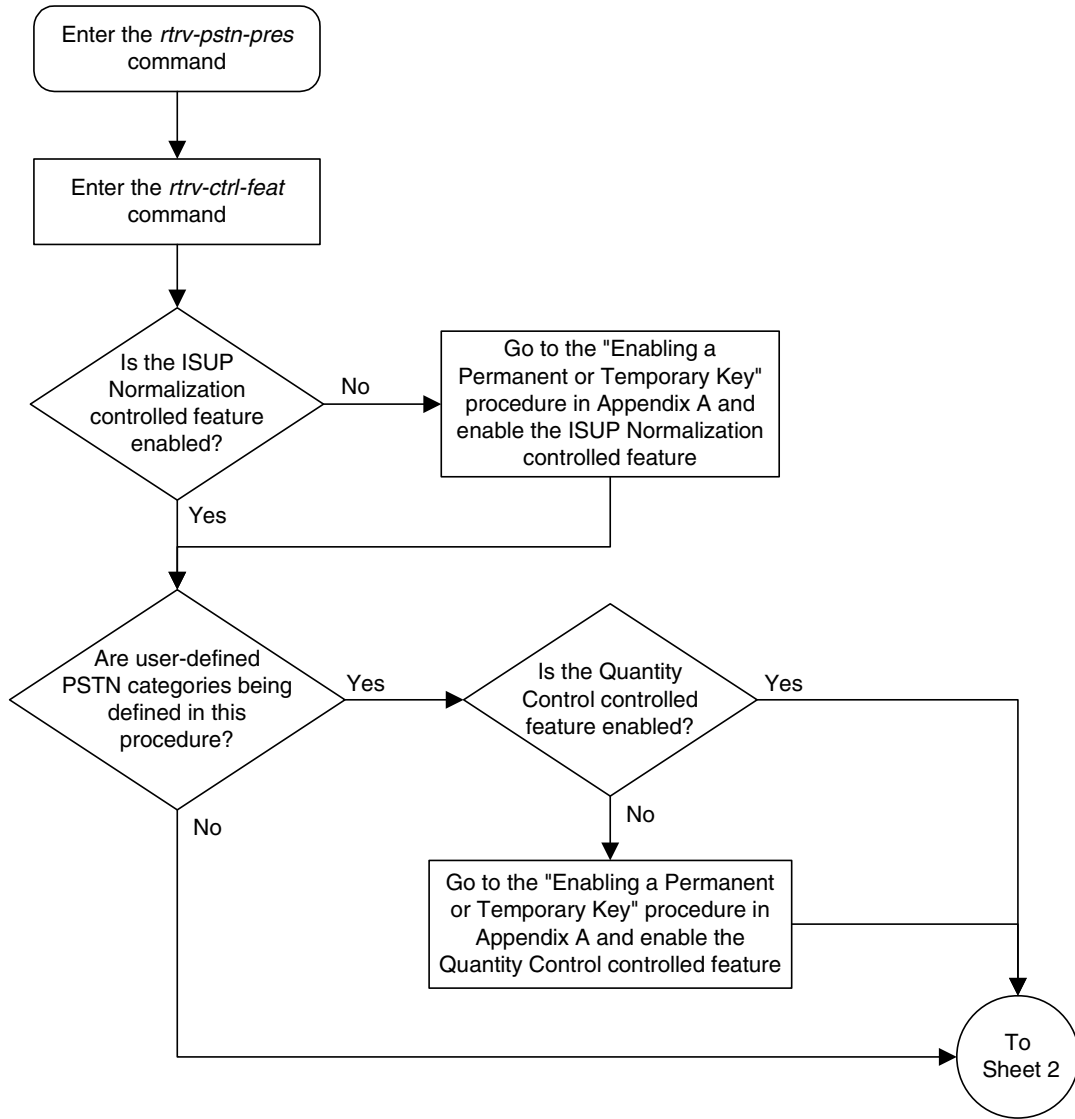

Flowchart 4-1. Adding ISUP PSTN Presentation Value (Sheet 2 of 2)

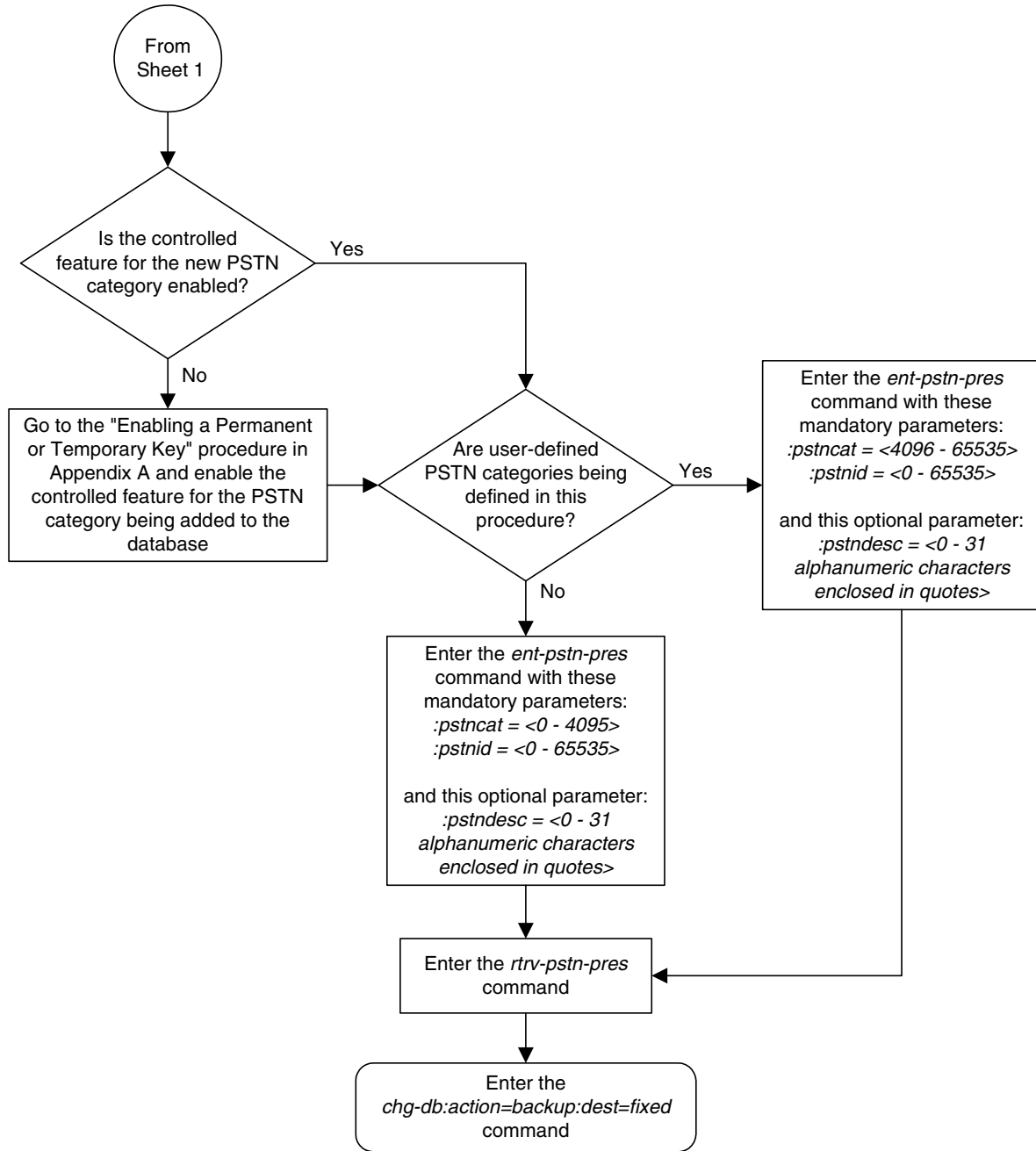

Changing ISUP Presentation Values

This procedure is used to change the description for a previously defined PSTN presentation value in the ISUP Variant Table, using the **chg-pstn-pres** command. The description of the PSTN presentation value is shown in the **PSTNDESC** column in the **rtrv-pstn-pres** output.

The **chg-pstn-pres** command uses these parameters:

- :pstncat** - The PSTN Category identifying the variant being changed is mandatory. Valid values for this parameter range from 0 to 65535.
- :pstnid** - The PSTN ID identifying the variant being changed is mandatory. Valid values for this parameter range from 0 to 65535.
- :pstndesc** - The PSTN Description, a text description of the PSTN Presentation value, is mandatory. It should be used to describe the variant associated with the PSTN. This field is displayed by the **rtrv-pstn-pres** command and it has no other purpose. This alphanumeric string 0 -31 characters in length is delimited with quotation marks.

Procedure

1. Display the current value of the ISUP PSTNs using the **rtrv-pstn-pres** command. This is an example of possible output:

```
rlghncxa03w 06-10-28 21:17:37 GMT EAGLE5 36.0.0
PSTNCAT PSTNID PSTNDESC
00001 00001 ITU Q.767
00001 00002 ETSI V3
00001 00003 UK PNO-ISC7
00001 00004 GERMAN ISUP
00001* 00020 Mexico
04096 01000 User Defined 4096/1000
05000 00001 Mexican ISUP v1.8
```

ISUP Variant table is (7 of 21) 33% full

NOTE: An * will be displayed next to the PSTN Category for entries that are no longer usable. These are entries that are disabled because their temporary feature key expired.

2. Change the PSTN descriptive text using the **chg-pstn-pres** command. For this example, enter this command.

```
chg-pstn-pres:pstncat=4096:pstnid=1000
:pstndesc="French ISUP v5.7"
```

When this command has successfully completed, the following message should appear.

```
rlghncxa03w 06-10-10 11:43:04 GMT EAGLE5 36.0.0
CHG-PSTN-PRES: MASP A - COMPLTD
```

3. Verify the changes using the `rtrv-pstn-pres` command. This is an example of possible output:

```
rlghncxa03w 06-10-28 21:17:37 GMT EAGLE5 36.0.0
PSTNCAT PSTNID PSTNDESC
00001 00001 ITU Q.767
00001 00002 ETSI V3
00001 00003 UK PNO-ISC7
00001 00004 GERMAN ISUP
00001* 00020 Mexico
04096 01000 French ISUP v5.7
05000 00001 Mexican ISUP v1.8
```

ISUP Variant table is (7 of 21) 33% full

NOTE: An * will be displayed next to the PSTN Category for entries that are no longer usable. These are entries that are disabled because their temporary feature key expired.

4. Back up the new changes, using the `chg-db:action=backup:dest=fixed` command. These messages should appear; the active Maintenance and Administration Subsystem Processor (MASP) appears first.

```
BACKUP (FIXED) : MASP A - Backup starts on active MASP.
BACKUP (FIXED) : MASP A - Backup on active MASP to fixed disk complete.
BACKUP (FIXED) : MASP A - Backup starts on standby MASP.
BACKUP (FIXED) : MASP A - Backup on standby MASP to fixed disk complete.
```

Flowchart 4-2. Changing ISUP PSTN Presentation Value

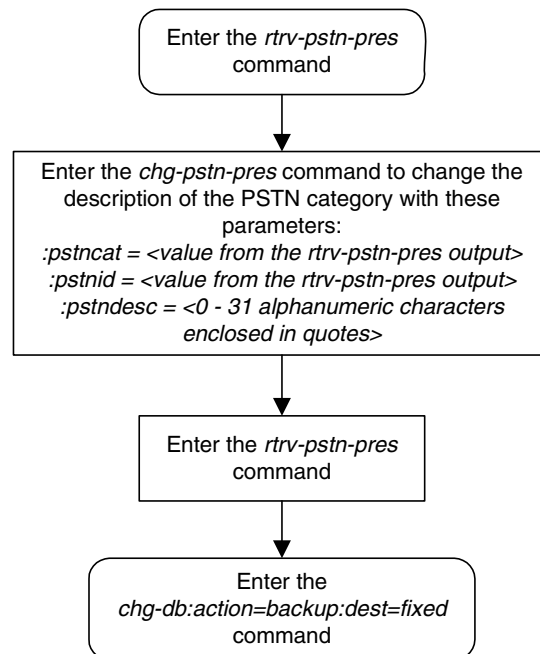

Removing ISUP Presentation Values

This procedure is used to remove a previously defined ISUP presentation value from the ISUP variant table, using the `dlt-pstn-pres` command.

The PSTN Presentation value, consisting of a PSTN Category and PSTN ID, is used by the EAGLE 5 ISS to uniquely define an ISUP variant.

This command will also cause all the ISUP parameters provisioned for the variant with the `chg-isupvar-attrib` command to be deleted.

NOTE: Deleting the PSTN Presentation value may cause a loss of traffic if any routing keys are using that PSTN value. Use caution when performing this action. To display the routing keys that are using the PSTN value being removed from the database, enter the `rtrv-appl-rtkey` command with the `pstncat` and `pstnid` parameters.

NOTE: You cannot delete the PSTN Present value with Category=1, ID=2 (the ETSI V3 ISUP variant).

The `dlt-pstn-pres` command uses these parameters:

:pstncat - The PSTN Category identifying the variant being deleted is mandatory. Valid values for this parameter range from 0 to 65535.

:pstnid - The PSTN ID identifying the variant being deleted is mandatory. Valid values for this parameter range from 0 to 65535.

:force - You will need to set `force=yes` when deleting the PSTN presentation value.

Procedure

1. Display the current value of the ISUP PSTNs using the `rtrv-pstn-pres` command. This is an example of possible output:

```
rlghncxa03w 06-10-10 11:43:04 GMT EAGLE5 36.0.0
PSTNCAT PSTNID PSTNDESC
00001 00001 ITU Q.767
00001 00002 ETSI V3
00001 00003 UK PNO-ISC7
00001 00004 GERMAN ISUP
00001* 00020 Mexico
04096 01000 French ISUP v5.7
05000 00001 Mexican ISUP v1.8
```

ISUP Variant table is (7 of 21) 33% full

NOTE: An * will be displayed next to the PSTN Category for entries that are no longer usable. These are entries that are disabled because their temporary feature key expired.

2. Display any routing keys that are using the PSTN value being removed from the database using the `rtrv-appl-rtkey` command with the `pstncat` and `pstnid` parameter values associated with the PSTN value being removed from the database, and the `display=all` parameter. For this example, enter this command.

```
rtrv-appl-rtkey:pstncat=04096:pstnid=01000:display=all
```

This is an example of the possible output.

```
rlghncxa03w 06-10-28 21:16:37 GMT EAGLE5 36.0.0
```

```
KEY:LOC      DPC          SI SSN OPCA          CICS      CICE
      STATIC 12323-DE    5 --- 12212-DE    1          1000
      ATTR:PSTNCAT PSTNID NORM DUP
              4096  1000 Y    -
      SNAMEs:socket6
```

```
STATIC Route Key table is (2 of 2000) 1% full
1105  Route Key table is (2 of 500) 1% full
1107  Route Key table is (2 of 500) 1% full
```

```
STATIC Route Key Socket Association table is (2 of 32000) 1% full
1105  Route Key Socket Association table is (2 of 8000) 1% full
1107  Route Key Socket Association table is (2 of 8000) 1% full
```

If there is a routing key using the PSTN information being removed from the database, go to the “Changing the PSTN Presentation and Normalization Attributes in a Routing Key” procedure on page 3-303 and change the routing keys so that they do not reference the PSTN value.

3. Remove the ISUP PSTN value from the database using the `dlc-pstn-pres` command with the `pstncat`, `pstnid`, and `force=yes` parameters. For this example, enter this command.

```
dlc-pstn-pres:pstncat=04096:pstnid=01000:force=yes
```

NOTE: The ISUP variant ETSI V3 (PSTNCAT=1, PSTNID=2) cannot be removed from the database.

When this command has successfully completed, the following message should appear.

```
rlghncxa03w 06-10-10 11:43:04 GMT EAGLE5 36.0.0
DLT-PSTN-PRES: MASP A - COMPLTD
```

ISUP Variant Table Provisioning

4. Verify the changes using the `rtrv-pstn-pres` command. This is an example of possible output:

```
rlghncxa03w 06-10-28 21:17:37 GMT EAGLE5 36.0.0
PSTNCAT PSTNID PSTNDESC
00001 00001 ITU Q.767
00001 00002 ETSI V3
00001 00003 UK PNO-ISC7
00001 00004 GERMAN ISUP
00001* 00020 Mexico
05000 00001 Mexican ISUP v1.8
```

ISUP Variant table is (7 of 21) 33% full

NOTE: An * will be displayed next to the PSTN Category for entries that are no longer usable. These are entries that are disabled because their temporary feature key expired.

5. Back up the new changes, using the `chg-db:action=backup:dest=fixed` command. These messages should appear; the active Maintenance and Administration Subsystem Processor (MASP) appears first.

```
BACKUP (FIXED) : MASP A - Backup starts on active MASP.
BACKUP (FIXED) : MASP A - Backup on active MASP to fixed disk complete.
BACKUP (FIXED) : MASP A - Backup starts on standby MASP.
BACKUP (FIXED) : MASP A - Backup on standby MASP to fixed disk complete.
```

Flowchart 4-3. Removing ISUP PSTN Presentation Value

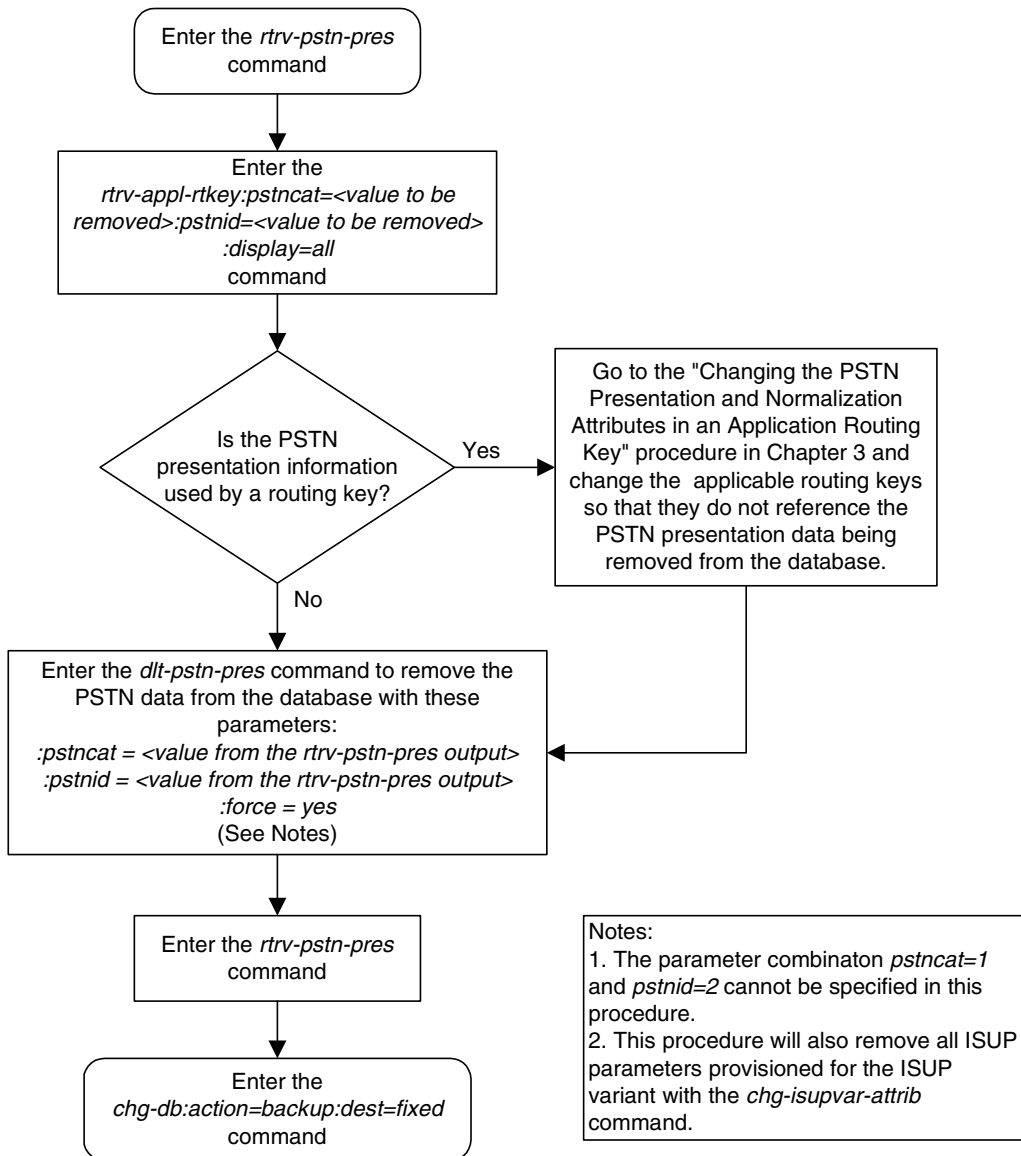

Changing ISUP Variant Table Entries

This procedure is used to add a new ISUP presentation value to the ISUP variant table, using the `chg-isupvar-attr` command.

An ISUP variant table entry exists for each variant defined in the EAGLE 5 ISS. Each entry contains ISUP message and parameter data specific to the ISUP protocol used by that variant. A variant is uniquely defined by its PSTN Presentation value, consisting of a PSTN Category and PSTN ID.

The `pstncat` and `pstnid` parameters identify the ISUP variant table entry to be changed. Use the `rtrv-pstn-pres` command to display the only allowed values for the PSTN Category and ID. This procedure may be used to change any Tekelec-defined or user-defined variants that are displayed by `rtrv-pstn-pres`.

You can make the following changes to ISUP variant table entries.

- All the ISUP messages and parameters for the variant can be provisioned as defined or not defined. All the ISUP messages and parameters default to not defined until set to defined by this command.
- All the ISUP parameters for specific messages in the variant can be provisioned as supported or not supported. All the ISUP parameters default to not supported until set to supported by this command.
- The minimum valid parameter length can be specified for each defined ISUP parameter.
- All the ISUP messages that are provisioned as defined can also have a message conversion action assigned.
- All the ISUP parameters that are provisioned as supported can also have a parameter conversion action assigned.
- All the ISUP parameters that are provisioned as supported, can also be assigned as optional, mandatory-fixed (MF), or mandatory-variable (MV).
- If assigned as MF or MV, the numerical order the parameter appears in the message must be specified.

NOTE: You cannot change the attributes for the ETSI V3 ISUP variant (PSTN Category=1, PSTN ID=2).

The PSTN presentation value, consisting of a PSTN category and PSTN ID, is used by the EAGLE 5 ISS to uniquely define an ISUP variant. The assignment of a new PSTN value also creates a new entry in the ISUP variant table. The new PSTN value must be unique.

This procedure may be used to change values within the Tekelec-defined range (PSTN Category 0-4095) as long as these control features are enabled:

- the controlled feature for the new PSTN category
- ISUP Normalization control feature

This procedure may be used to change values within the user-defined range (PSTN Category 4096-65535) as long as these control features are enabled:

- the controlled feature for the new PSTN category
- ISUP Normalization control feature
- ISUP Normalization Quantity control feature, to make sure that the quantity of user-defined PSTN categories is not exceeded.

The `chg-isupvar-attrib` command uses these parameters:

:pstncat - The PSTN category identifying the new variant being defined. Valid values for this parameter range from 0 to 65535.

:pstnid - The PSTN ID identifying the new variant being defined. Valid values for this parameter range from 0 to 65535.

:msgcode - The ISUP message type code. This parameter is used to identify a specific ISUP message that is going to have its attributes changed. Valid values are 0-255 (h'00 - h'FF).

:parmcode - The ISUP parameter code. This parameter is used to identify a specific ISUP parameter that is going to have its attributes changed. When specified with the `msgcode` parameter, the `parmcode` parameter identifies a parameter within the `msgcode` parameter that is going to have its attributes changed. Valid values are 0-255 (h'00 - h'FF).

:attrib - The attribute being assigned to a message or parameter. This parameter can have values of `defined`, `notdefined`, `supp`, or `notsupp`.

- `defined` – the message or parameter is defined in the variant.
- `notdefined` – the message or parameter is not defined in the variant.
- `supp` – the parameter is supported in the specified message in the variant.
- `notsupp` – the parameter is not supported in the specified message in the variant.

:minlen - The minimum parameter length. This parameter has valid values of 0-255 (h'00 - h'FF). It is used for validating that the length of the received parameter is at least as long as the `minlen` parameter value.

:parmtyp - The type of ISUP parameter, and has valid values of `opt`, `mf`, or `mv`.

- `opt` – The parameter may appear in the Optional part of the ISUP message. This is the default and it does not have to be specified unless the parameter needs to be changed from either `mf` or `mv` to optional.
- `mf` – The parameter must appear in the Mandatory Fixed part of the ISUP message.
- `mv` – The parameter must appear in the Mandatory Variable part of the ISUP message.

ISUP Variant Table Provisioning

:order - The order in which the mandatory parameters appear in the message. Valid values are from 1 to 7.

:action - The message or parameter conversion action the software will follow when a message is received with the specified **msgcode** parameter value or the **msgcode/parmcode** parameter combination. Valid values are **none**, **convert**, and **passthru**.

- **none** – The software will follow its normal conversion rules. No special conversions will occur. This is the default.
- **convert** – The software will invoke a special conversion routine that is available in the EAGLE 5 ISS for the specified **msgcode** parameter value or **msgcode/parmcode** parameter combination.
- **passthru**, for the **msgcode** parameter, – The specified message code should be passed through unconverted using the raw MTP3 transfer method.
- **passthru**, for the **msgcode/parmcode** parameter combination, – The parameter code, when encountered in message code, should be passed through to the normalized section of the message (ignoring the **defined** or **supp** attributes of the normalized specification).

:force – Used to allow the ISUP Message Type Code to be changed to **notdefined**. This parameter has values of **yes** and **no**.

Table 4-2 on page 4-20 shows the parameter combinations that can be used with the **chg-isupvar-attrib** command.

Table 4-2. CHG-ISUPVAR-ATTRIB Parameter Combinations

| Parameter Combination 1 | Parameter Combination 2 | Parameter Combination 3 | Parameter Combination 4 | Parameter Combination 5 |
|---|---|---|--|---|
| pstncat = 0-65535 ¹ pstnid = 0-65535 ¹ msgcode = 0-255 attrib = defined action = none, convert, passthru ^{6,7} | pstncat = 0-65535 ¹ pstnid = 0-65535 ¹ msgcode = 0-255 attrib = notdefined force ³ | pstncat = 0-65535 ¹ pstnid = 0-65535 ¹ parmcode = 0-255 attrib = defined minlen = 0-255 ² | pstncat = 0-65535 ¹ pstnid = 0-65535 ¹ parmcode = 0-255 attrib = notdefined | pstncat = 0-65535 ¹ pstnid = 0-65535 ¹ msgcode = 0-255 parmcode = 0-255 attrib = supp action = none, convert, passthru ^{6,7} |
| Parameter Combination 6 | Parameter Combination 7 | Parameter Combination 8 | Parameter Combination 9 | |
| pstncat = 0-65535 ¹ pstnid = 0-65535 ¹ msgcode = 0-255 parmcode = 0-255 attrib = supp parmtyp = opt ⁴ action = none, convert, passthru ^{6,7} | pstncat = 0-65535 ¹ pstnid = 0-65535 ¹ msgcode = 0-255 parmcode = 0-255 attrib = supp parmtyp = mf ⁵ order = 1-7 action = none, convert, passthru ^{6,7} | pstncat = 0-65535 ¹ pstnid = 0-65535 ¹ msgcode = 0-255 parmcode = 0-255 attrib = supp parmtyp = mv ⁵ order = 1-7 action = none, convert, passthru ^{6,7} | pstncat = 0-65535 ¹ pstnid = 0-65535 ¹ msgcode = 0-255 parmcode = 0-255 attrib = notsupp | |
| <p>Notes:</p> <ol style="list-style-type: none"> The parameter combination pstncat=1 and pstnid=2 cannot be specified with the chg-isupvar-attrib command. The minlen=0 parameter is valid only for the parmcode=0 (EOP) parameter. Otherwise, the values for this parameter are from 1 to 255. Changing an ISUP Message Type Code to notdefined will clear all the associated parameter data. In this case, the force=yes parameter is required. Changing an ISUP Message Type Code to notdefined is destructive and will clear all the associated parameter data for that ISUP Message Type Code. The opt value is the default value for the parmtyp parameter and it does not have to be specified unless the parameter value needs to be changed from mf or mv to opt. The parmtyp parameter may be changed as long as the change does not violate the rules of the order parameter. The mf parameters must be specified in an ordered list starting with 1. The mv parameters must be specified in a different ordered list starting with 1. There can be no gaps in order number. A mf or mv parameter cannot be removed from a list (that is, changing parmtyp parameter value, or changing the attrib parameter value to notsupp) unless all parameters with a higher order number are deleted first. The none value is the only valid value for the action parameter when the parmcode=0 parameter is specified. The action parameter can be specified for user-defined variants, however the EAGLE 5 ISS will ignore the convert value. There will be no supported conversion action. | | | | |

Procedure

1. Display the current value of the ISUP supported parameters for all the variants using the `rtv-isupvar-attr` command. This is an example of possible output.

```
rlghncxa03w 06-10-10 11:43:04 GMT EAGLE5 36.0.0
```

```
PSTNCAT PSTNID
```

```
00001 00001
```

| MSGCODE | PARMCODE | TYPE | ORDER | ACTION |
|---------|----------|------|-------|--------|
| 01h | --- | --- | - | NONE |
| | 45h | MF | 1 | NONE |
| | 00h | OPT | - | NONE |
| | 40h | OPT | - | NONE |

| MSGCODE | PARMCODE | TYPE | ORDER | ACTION |
|---------|----------|------|-------|----------|
| 0Ah | --- | --- | - | CONVERT |
| | 45h | MF | 1 | NONE |
| | 4Ch | MV | 1 | NONE |
| | 00h | OPT | - | NONE |
| | 56h | OPT | - | PASSTHRU |

| MSGCODE | PARMCODE | TYPE | ORDER | ACTION |
|---------|----------|------|-------|---------|
| 0Bh | --- | --- | - | NONE |
| | 45h | MF | 1 | NONE |
| | 71h | MF | 2 | NONE |
| | 00h | OPT | - | NONE |
| | 72h | OPT | - | CONVERT |

```
PSTNCAT PSTNID
```

```
00001 00002
```

| MSGCODE | PARMCODE | TYPE | ORDER | ACTION |
|---------|----------|------|-------|--------|
| 01h | --- | --- | - | NONE |
| | 45h | MF | 1 | NONE |
| | 00h | OPT | - | NONE |
| | 40h | OPT | - | NONE |

| MSGCODE | PARMCODE | TYPE | ORDER | ACTION |
|---------|----------|------|-------|--------|
| 0Ah | --- | --- | - | NONE |
| | 45h | MF | 1 | NONE |
| | 4Ch | MV | 1 | NONE |
| | 00h | OPT | - | NONE |
| | 10h | OPT | - | NONE |
| | 56h | OPT | - | NONE |

```
PSTNCAT PSTNID
```

```
04097 00001
```

| MSGCODE | PARMCODE | TYPE | ORDER | ACTION |
|---------|----------|------|-------|----------|
| 01h | --- | --- | - | NONE |
| | 45h | MF | 1 | NONE |
| | 00h | OPT | - | NONE |
| | 40h | OPT | - | PASSTHRU |

| MSGCODE | PARMCODE | TYPE | ORDER | ACTION |
|---------|----------|------|-------|---------|
| 0Ah | --- | --- | - | CONVERT |
| | 45h | MF | 1 | NONE |
| | 4Ch | MV | 1 | NONE |
| | 00h | OPT | - | NONE |
| | 56h | OPT | - | CONVERT |

```
ISUP Variant table is (5 of 20) 25% full
```

2. Display enabled controlled feature information in the database by entering the `rtrv-ctrl-feat` command. The following is an example of the possible output.

```
rlghncxa03w 06-10-28 21:15:37 GMT EAGLE5 36.0.0
The following features have been permanently enabled:
```

| Feature Name | Partnum | Status | Quantity |
|-----------------------|-----------|--------|----------|
| IPGWx Signaling TPS | 893012814 | on | 20000 |
| ISUP Normalization | 893000201 | on | ---- |
| ETSI v3 Normalization | 893000601 | on | ---- |
| HC-MIM SLK Capacity | 893012707 | on | 64 |

```
The following features have been temporarily enabled:
```

| Feature Name | Partnum | Status | Quantity | Trial Period Left |
|---------------------|---------|--------|----------|-------------------|
| Zero entries found. | | | | |

```
The following features have expired temporary keys:
```

| Feature Name | Partnum |
|---------------------|---------|
| Zero entries found. | |

If the ISUP Normalization control feature, the controlled feature for the new PSTN category, and if a user-defined PSTN category is being changed, or the ISUP Normalization Quantity control feature have not been enabled and turned on, go to the “Enabling Controlled Features” procedure on page 6-2 and to “Turning On and Off Controlled Features” procedure on page 6-10 to enable and turn on these controlled features.

3. Enter the desired new values of the ISUP supported parameters using the `chg-isupvar-attrib` command and using one of the parameter combinations shown in Table 4-2 on page 4-20. For this example, enter this command.

```
chg-isupvar-attrib:pstncat=4097:pstnid=1:msgcode=10
:parmcode=100:attrib=supp:parmtyp=mv:order=1:action=passthru
```

When this command has successfully completed, the following message should appear.

```
rlghncxa03w 06-10-10 11:43:04 GMT EAGLE5 36.0.0
CHG-ISUPVAR-ATTRIB: MASP A - COMPLTD
```

ISUP Variant Table Provisioning

4. Verify the changes using the `rtrv-isupvar-attrib` command with the `pstncat` and `pstnid` values used in step 3. For this example, enter this command.

```
rtrv-isupvar-attrib:pstncat=4097:pstnid=1
```

```
rlghncxa03w 06-10-10 11:43:04 GMT EAGLE5 36.0.0
PSTNCAT PSTNID
04097 00001
```

| MSGCODE | PARMCODE | TYPE | ORDER | ACTION |
|---------|----------|------|-------|----------|
| 01h | --- | --- | - | NONE |
| | 45h | MF | 1 | NONE |
| | 00h | OPT | - | NONE |
| | 40h | OPT | - | PASSTHRU |

| MSGCODE | PARMCODE | TYPE | ORDER | ACTION |
|---------|----------|------|-------|----------|
| 0Ah | --- | --- | - | CONVERT |
| | 45h | MF | 1 | NONE |
| | 4Ch | MV | 1 | NONE |
| | 00h | OPT | - | NONE |
| | 56h | OPT | - | CONVERT |
| | 64h | MV | 1 | PASSTHRU |

```
ISUP Variant table is (5 of 20) 25% full
```

5. Back up the new changes, using the `chg-db:action=backup:dest=fixed` command. These messages should appear; the active Maintenance and Administration Subsystem Processor (MASP) appears first.

```
BACKUP (FIXED) : MASP A - Backup starts on active MASP.
BACKUP (FIXED) : MASP A - Backup on active MASP to fixed disk complete.
BACKUP (FIXED) : MASP A - Backup starts on standby MASP.
BACKUP (FIXED) : MASP A - Backup on standby MASP to fixed disk complete.
```

Flowchart 4-4. Changing ISUP Attribute Values (Sheet 1 of 2)

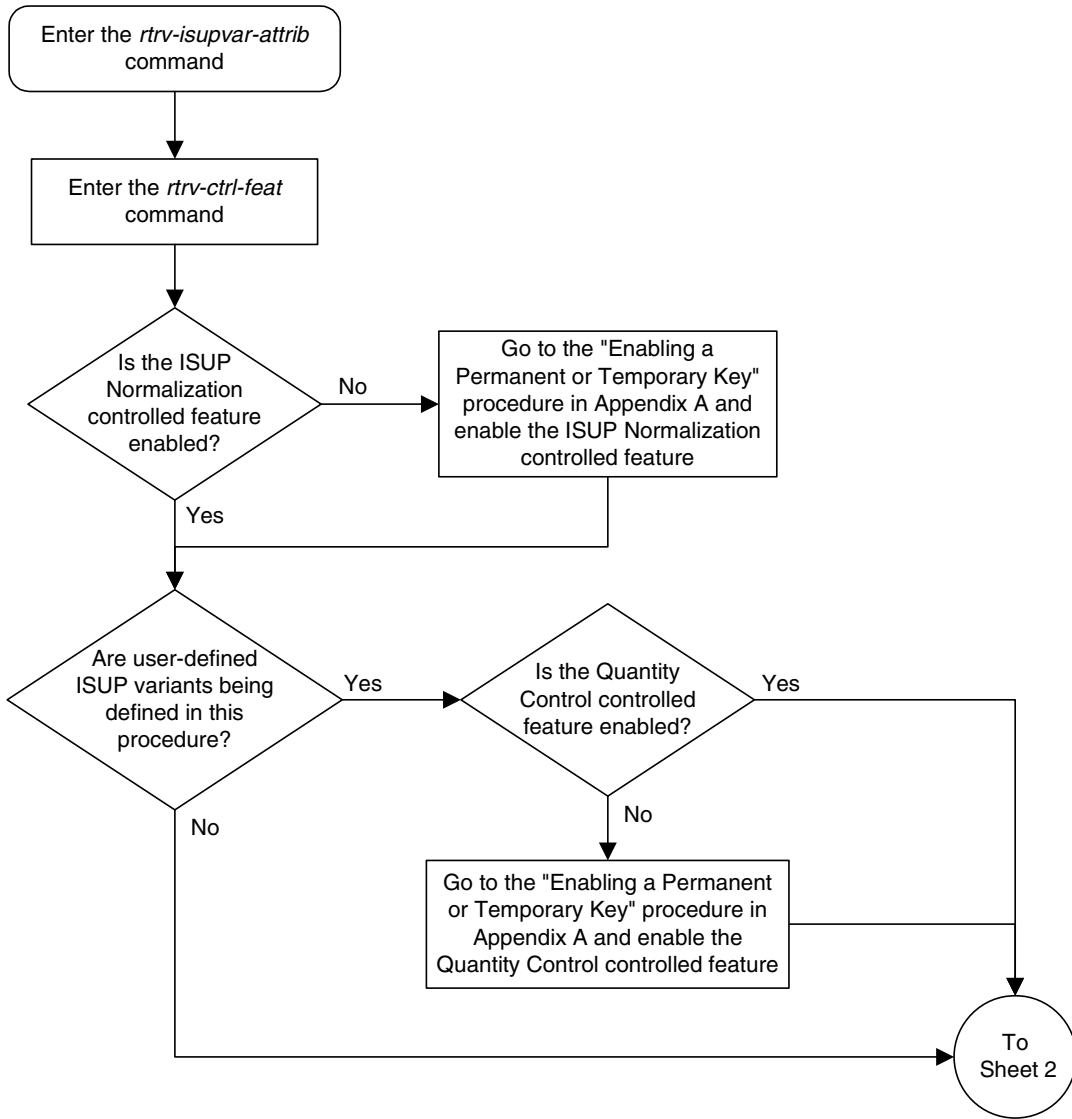

ISUP Variant Table Provisioning

Flowchart 4-4. Changing ISUP Attribute Values (Sheet 2 of 2)

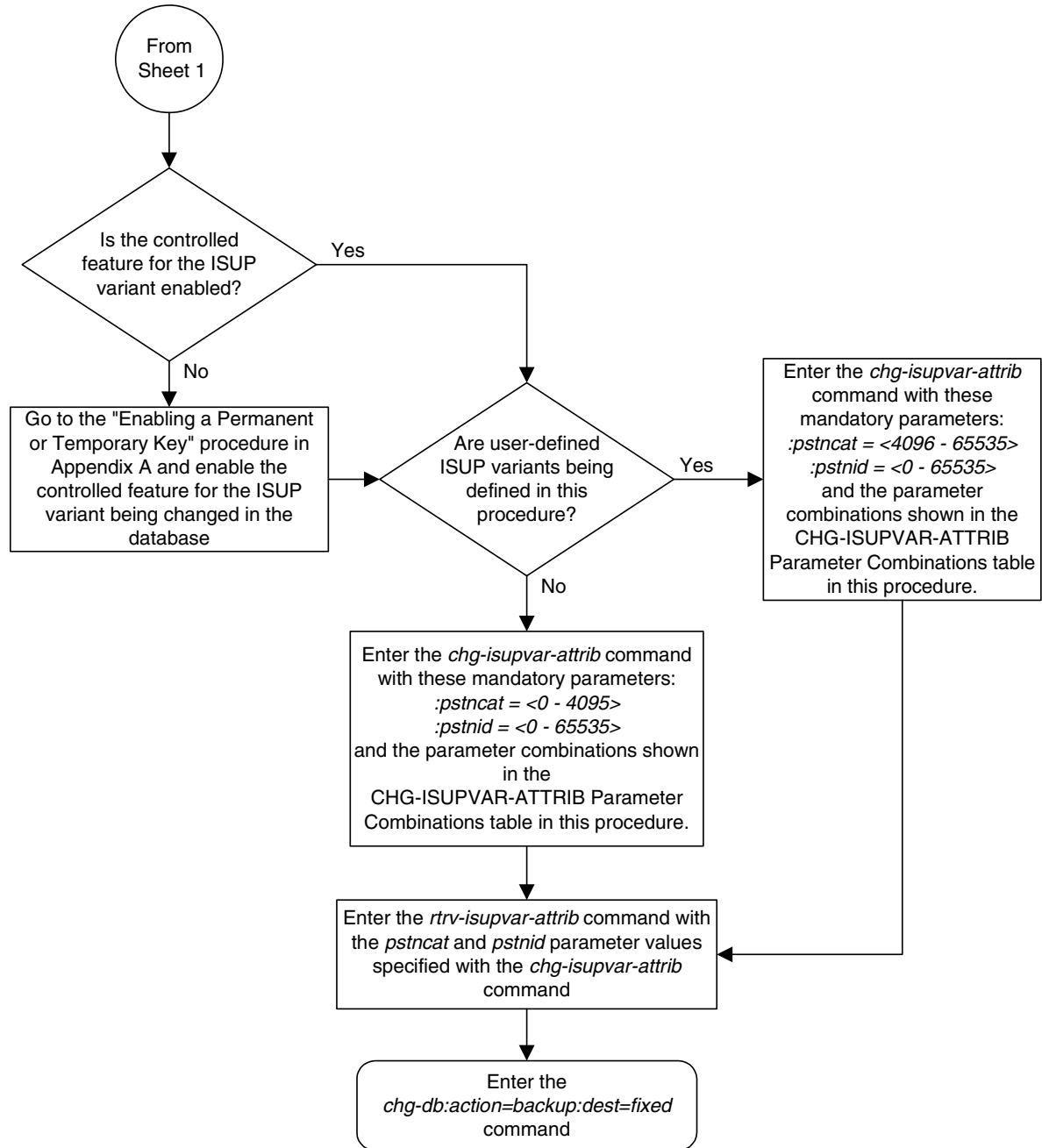

Copying ISUP Variant Table Entries

The `copy-isupvar-attr` command is used to copy one ISUP variant table entry to another ISUP variant table entry.

This command provides you with an easy way to provision a new ISUP variant table entry by copying all the data from another entry. You can then change the entry with the `chg-isupvar-attr` command.

An ISUP variant table entry exists for each variant defined in the EAGLE 5 ISS. Each entry contains ISUP message and parameter data specific to the ISUP protocol used by that variant. A variant is uniquely defined by its PSTN presentation value, consisting of a PSTN category and PSTN ID.

The PSTN presentation is used to identify both the source and destination table entries. Both entries must be previously defined PSTN presentation values, that is, either a Tekelec-defined PSTN or a user-defined PSTN entered into the database by the `ent-pstn-pres` commands. Use the `rtrv-pstn-pres` command to display the only allowed values for the source and destination PSTNs.

Tekelec-defined PSTNs (PSTN Category 0-4095) require that these control features are enabled:

- The controlled feature for the PSTN category
- ISUP Normalization control feature

User-defined PSTNs (PSTN Category 4096-65535) require that these control features are enabled:

- The controlled feature for the PSTN category
- ISUP Normalization control feature
- ISUP Normalization Quantity control feature, to make sure that the quantity of user-defined PSTN categories is not exceeded.

NOTE: The destination PSTN cannot be the ETSI V3 ISUP variant (PSTNCAT=1, PSTNID=2).

The `copy-isupvar-attr` command uses these parameters:

:pstncat – The source variant table entry being copied. Valid values for this parameter range from 0 to 65535.

:pstnid – The source variant table entry being copied. Valid values for this parameter range from 0 to 65535.

:dpstncat – The destination variant table entry where the source variant table is being copied. Valid values for this parameter range from 0 to 65535.

:dpstnid – The destination variant table entry where the source variant table is being copied. Valid values for this parameter range from 0 to 65535.

ISUP Variant Table Provisioning

Procedure

1. Display the current value of the ISUP supported parameters for all the variants using the `rtrv-isupvar-attr` command. This is an example of possible output:

```
rlghncxa03w 06-10-28 21:17:37 GMT EAGLE5 36.0.0
```

```
PSTNCAT PSTNID
```

```
00001 00001
```

| MSGCODE | PARMCODE | TYPE | ORDER | ACTION |
|---------|----------|------|-------|--------|
| 01h | --- | --- | - | NONE |
| | 45h | MF | 1 | NONE |
| | 00h | OPT | - | NONE |
| | 40h | OPT | - | NONE |

| MSGCODE | PARMCODE | TYPE | ORDER | ACTION |
|---------|----------|------|-------|----------|
| 0Ah | --- | --- | - | CONVERT |
| | 45h | MF | 1 | NONE |
| | 4Ch | MV | 1 | NONE |
| | 00h | - | - | NONE |
| | 56h | - | - | PASSTHRU |

| MSGCODE | PARMCODE | TYPE | ORDER | ACTION |
|---------|----------|------|-------|---------|
| 0Bh | --- | --- | - | NONE |
| | 45h | MF | 1 | NONE |
| | 71h | MF | 2 | NONE |
| | 00h | OPT | - | NONE |
| | 72h | OPT | - | CONVERT |

```
PSTNCAT PSTNID
```

```
00001 00002
```

| MSGCODE | PARMCODE | TYPE | ORDER | ACTION |
|---------|----------|------|-------|--------|
| 01h | --- | --- | - | NONE |
| | 45h | MF | 1 | NONE |
| | 00h | OPT | - | NONE |
| | 40h | OPT | - | NONE |

| MSGCODE | PARMCODE | TYPE | ORDER | ACTION |
|---------|----------|------|-------|--------|
| 0Ah | --- | --- | - | NONE |
| | 45h | MF | 1 | NONE |
| | 4Ch | MV | 1 | NONE |
| | 00h | OPT | - | NONE |
| | 10h | OPT | - | NONE |
| | 56h | OPT | - | NONE |

```
PSTNCAT PSTNID
```

```
04097 00001
```

| MSGCODE | PARMCODE | TYPE | ORDER | ACTION |
|---------|----------|------|-------|----------|
| 01h | --- | --- | - | NONE |
| | 45h | MF | 1 | NONE |
| | 00h | OPT | - | NONE |
| | 40h | OPT | - | PASSTHRU |

| MSGCODE | PARMCODE | TYPE | ORDER | ACTION |
|---------|----------|------|-------|---------|
| 0Ah | --- | --- | - | CONVERT |
| | 45h | MF | 1 | NONE |
| | 4Ch | MV | 1 | NONE |
| | 00h | OPT | - | NONE |
| | 56h | OPT | - | CONVERT |

```
ISUP Variant table is (5 of 20) 25% full
```

2. Display enabled controlled feature information in the database by entering the `rtrv-ctrl-feat` command. The following is an example of the possible output.

```
rlghncxa03w 06-10-28 21:15:37 GMT EAGLE5 36.0.0
The following features have been permanently enabled:
```

| Feature Name | Partnum | Status | Quantity |
|-----------------------|-----------|--------|----------|
| IPGWx Signaling TPS | 893012814 | on | 20000 |
| ISUP Normalization | 893000201 | on | ---- |
| ETSI v3 Normalization | 893000601 | on | ---- |
| HC-MIM SLK Capacity | 893012707 | on | 64 |

The following features have been temporarily enabled:

| Feature Name | Partnum | Status | Quantity | Trial Period Left |
|---------------------|---------|--------|----------|-------------------|
| Zero entries found. | | | | |

The following features have expired temporary keys:

| Feature Name | Partnum |
|---------------------|---------|
| Zero entries found. | |

If the ISUP Normalization control feature, the controlled feature for the new PSTN category, and if a user-defined PSTN category is being changed, or the ISUP Normalization Quantity control feature have not been enabled and turned on, go to the “Enabling Controlled Features” procedure on page 6-2 and to “Turning On and Off Controlled Features” procedure on page 6-10 to enable and turn on these controlled features.

3. Copy an ISUP PSTN value using the `copy-isupvar-attrib` command. For this example, enter this command.

```
copy-isupvar-attrib:pstncat=1:pstnid=2:dpstncat=1:dpstnid=20
```

When this command has successfully completed, the following message should appear.

```
rlghncxa03w 06-10-10 11:43:04 GMT EAGLE5 36.0.0
COPY-ISUPVAR-ATTRIB: MASP A - COMPLTD
```

ISUP Variant Table Provisioning

4. Verify the changes using the `rtrv-isupvar-attrib` command with the `pstncat` and `pstnid` parameters. Use the `dpstncat` and `dpstnid` parameter values used in step 3 for the values of the `pstncat` and `pstnid` parameters. For this example, enter this command.

```
rtrv-isupvar-attrib:pstncat=1:pstnid=20
```

This is an example of the possible output.

```
PSTNCAT  PSTNID
00001    00020

  MSGCODE  PARMCODE  TYPE  ORDER  ACTION
    01h     ---      ---    -      NONE
          45h      MF     1      NONE
          00h      OPT    -      NONE
          40h      OPT    -      NONE
  MSGCODE  PARMCODE  TYPE  ORDER  ACTION
  0Ah      ---      ---    -      NONE
          45h      MF     1      NONE
          4Ch      MV     1      NONE
          00h      OPT    -      NONE
          10h      OPT    -      NONE
          56h      OPT    -      NONE
```

5. Back up the new changes using the `chg-db:action=backup:dest=fixed` command. These messages should appear; the active Maintenance and Administration Subsystem Processor (MASP) appears first.

```
BACKUP (FIXED) : MASP A - Backup starts on active MASP.
BACKUP (FIXED) : MASP A - Backup on active MASP to fixed disk complete.
BACKUP (FIXED) : MASP A - Backup starts on standby MASP.
BACKUP (FIXED) : MASP A - Backup on standby MASP to fixed disk complete.
```

Flowchart 4-5. Copying ISUP Attribute Values (Sheet 1 of 2)

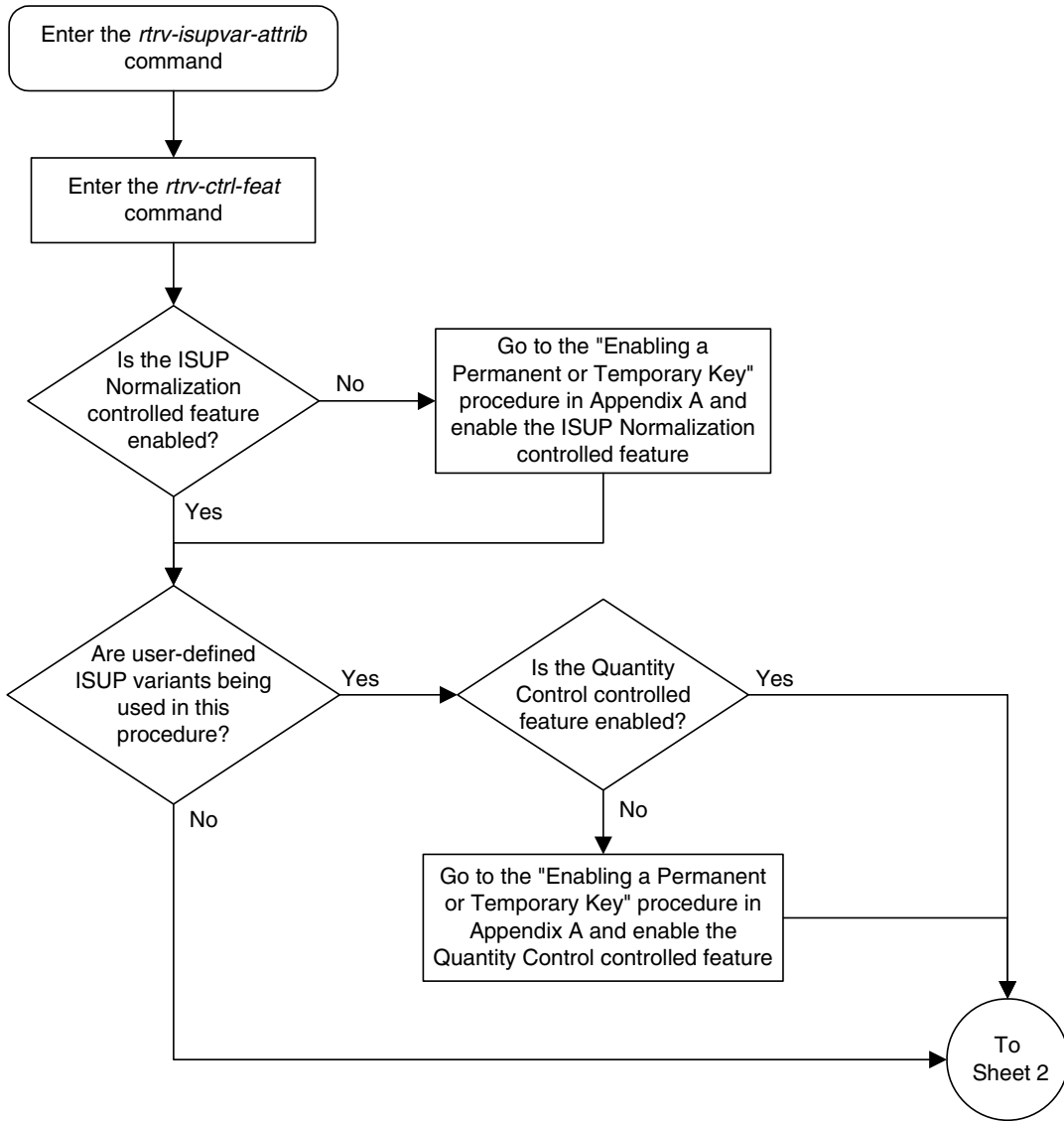

Flowchart 4-5. Copying ISUP Attribute Values (Sheet 2 of 2)

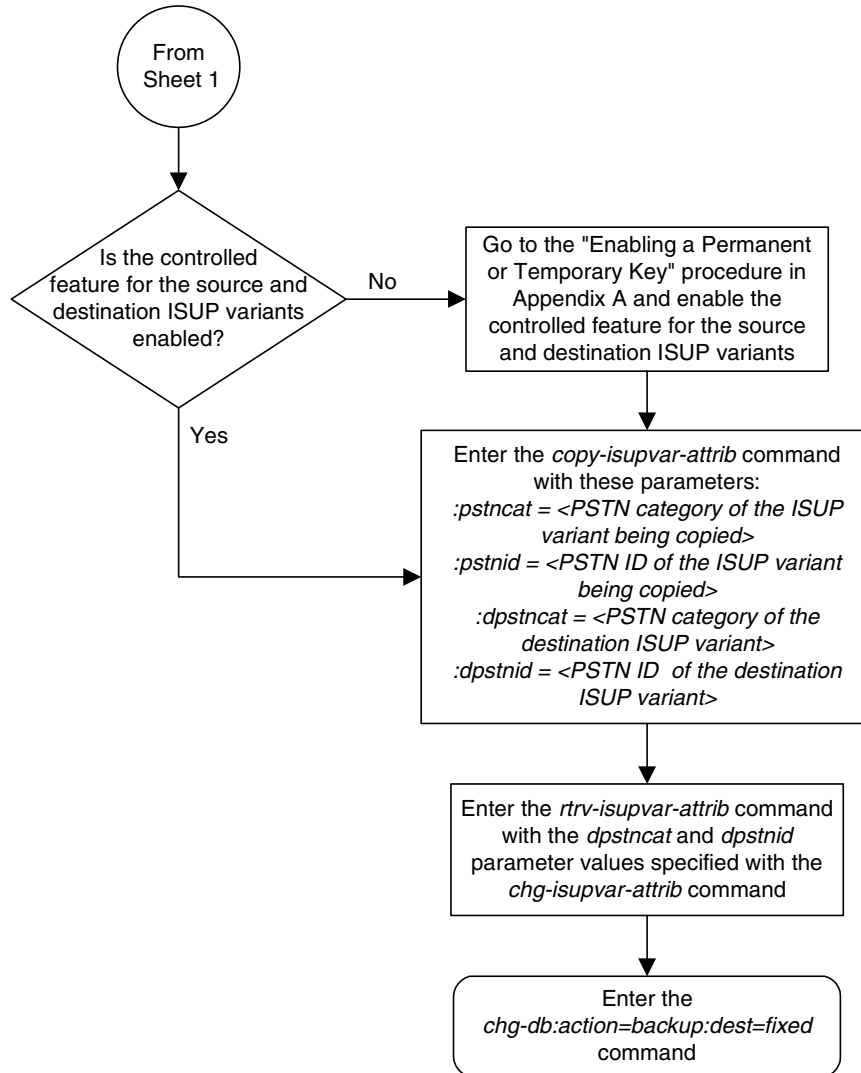

5

End Office Support

| | |
|---|------|
| Overview | 5-2 |
| Internal Point Code | 5-4 |
| Adding an End Node Internal Point Code | 5-14 |
| Removing an End Node Internal Point Code..... | 5-18 |

Overview

End Office Support enables the EAGLE 5 ISS to share its true point code (TPC) with an IP-based node without the need for a separate point code for the IP node. When the End Office Support feature is in use, the EAGLE 5 ISS shares a point code for up to three network types with attached IP network elements.

The EAGLE 5 ISS lets you take advantage of next generation network technology by migrating existing signaling end points from the PSTN to the IP network. The fact that the EAGLE 5 ISS is a signaling transfer point and has its own point code, however, can present a significant network management issue. This feature provides the means to perform the migration without obtaining a new point code or reconfiguring the network to interface with both the EAGLE 5 ISS and an IP end office node.

Characteristics of this feature include:

- The EAGLE 5 ISS allows a set of IP network elements to share its true point code.
- The EAGLE 5 ISS allows messages destined to its true point code and having $SI \geq 3$ to be forwarded to an IP network element.
- The EAGLE 5 ISS enables IP networks elements sharing its true point code to participate in network management.
- The EAGLE 5 ISS supports ANSI, ITU national and international end office nodes.
- The EAGLE 5 ISS implements the MTP procedures required for an end office node.
- The End Office Support feature does not reduce the rated TPS of any EAGLE 5 ISS application.

The Remote Application Table contains fields for assigning each user part to an end office node. The default value is 'not assigned'.

New Remote Application Table commands provide for adding, deleting, and retrieving user-part assignments:

- `ent-rmt-appl`
- `dlt-rmt-appl`
- `rtrv-rmt-appl`

The user parts $SI=0$, $SI=1$, and $SI=2$ cannot be assigned to an end office node. The SNM case is a special case in that UPU's may be forwarded, even though $SI=0$ cannot be assigned to a remote application. All other SNMs are processed as destined to the EAGLE 5 ISS rather than the end office node. This often results in a multicast throughout the EAGLE 5 ISS that updates the routing tables on all cards. An end office node can receive these messages via replication performed by MTPP.

End Office Support

Each SS7-based application that receives a message destined to a TSPC checks the user-part assignment within the Remote Application Table. If the user-part is assigned and the SI is greater than or equal to 3, then the message is forwarded to the appropriate application, otherwise it is processed as though destined to the EAGLE 5 ISS.

To assign a remote application for the SCCP (SI=3) user part, you must also specify a subsystem number. The Remote Application Table maintains a record of assignments for all possible subsystems (256). Subsystems are either assigned or not assigned.

NOTE: SSN=0 is normally an invalid value. This feature makes use of SSN=0 for the purpose of forwarding certain MSUs to the end office node.

- Received SCCP Messages that indicate route-on-global-title are treated as having SSN=0 for remote application assignment. If a remote application is assigned to SSN=0, then the message is forwarded, otherwise it is distributed to the local SCCP application. In previous releases, this would occur only for mis-configured networks. Messages indicating route-on-global-title and intended for the EAGLE 5 ISS, not the end office node, should be sent to the EAGLE 5 ISS's capability point code.
- Received SCCP Messages that lack a Called Party SS are treated as having SSN=0 for remote application assignment. If a remote application is assigned to SSN=0, then the message is forwarded, otherwise it is distributed to the local SCCP application.
- Received SCCP Messages having a Called Party SS equal to SCMG (SSN=1) are processed and terminated by the EAGLE 5 ISS, and if SSN=1 has a remote application assigned, the MSU is also replicated and forwarded to the end office node.
- Received SSCP Messages having a Called Party SSN not equal to 0 or SCMG (1) and for which a remote application is assigned are forwarded to the end office node. Messages received for unassigned subsystems are distributed to the local SCCP application.
- The end office node cannot share SCCP subsystems (other than SCMG) with the EAGLE 5 ISS. If the end office node assigns a given subsystem, such as LNP, then the subsystem local to the EAGLE 5 ISS cannot receive messages. Remote applications take priority over local applications.

Internal Point Code

To route SS7 messages to the IP address without adding another external point code, the End Office feature uses an internal point code (IPC). This point code is private to the EAGLE 5 ISS, and the PSTN has no awareness of it. Its sole purpose is to allow messages destined to the End Office Node to be routed from the inbound LIM to the IPGWx card (a card running either the SS7IPGW or IPGWI applications). An IPC must be entered as a destination and must be assigned for each network type having an end office node. This point code is also used internally by the EAGLE 5 ISS in order to route inbound messages to the outbound IPGWx card. The EAGLE 5 ISS can have up to three IPCs, one for ANSI, one for ITU International, and one for ITU National networks.

Table 5-1 displays a sample Remote Application Table. The Network Type and SI are used to index into the table, rather than being stored in the table.

Table 5-1. Sample IPC Values

| IPC | Assigned to End Office Node | Assigned SSNs | Network Type | User-Part (SI) | Action taken when MSU is received for the TPC |
|---------|-----------------------------|---------------|--------------|----------------|---|
| p-0-1-0 | FALSE | n/a | ANSI | 0 | No application can be assigned for SI=0. Note that TFCs are processed, replicated and sent to an end office node, if an application is assigned to any other user part. UPUs are forwarded if the application specified by the affected SI is assigned. |
| | FALSE | n/a | | 1 | No application can be assigned for SI=1. |
| | FALSE | n/a | | 2 | No application can be assigned for SI=2. |
| | TRUE | 3, 7, 100 | | 3 | SCCP messages destined to the TSPC and with SSN assigned are forwarded to an end office node. SCCP messages destined to a TSPC and SSN not assigned are distributed to subsystems local to the EAGLE 5 ISS (e.g. LNP). |
| | FALSE | n/a | | 4 | Terminate with UPU. |
| | TRUE | n/a | | 5 | ISUP messages destined to a TSPC are forwarded to the end office node. |
| | FALSE | n/a | | 6 - 15 | Terminate with UPU. |
| 110 | FALSE | n/a | ITU-N | 0 | No application can be assigned for SI=0. TFCs are processed, replicated and sent to an end office node, if an application is assigned to any other user part. UPUs are forwarded if the application specified by the affected SI is assigned. |

End Office Support

Table 5-1. Sample IPC Values (Continued)

| IPC | Assigned to End Office Node | Assigned SSNs | Network Type | User-Part (SI) | Action taken when MSU is received for the TPC |
|--------|-----------------------------|---------------|--------------|----------------|---|
| | FALSE | n/a | | 1 | No application can be assigned for SI=1. |
| | FALSE | n/a | | 2 | No application can be assigned for SI=2. |
| | FALSE | NULL | | 3 | Distribute to local SCCP. |
| | TRUE | n/a | | 4 | TUP messages destined to the TSPC are forwarded to the end office node. |
| | FALSE | n/a | | 5 - 12 | Terminate with UPU. |
| | TRUE | n/a | | 13 | QBICC messages destined to the TSPC are forwarded to the end office node. |
| | FALSE | n/a | | 14, 15 | Terminate with UPU. |
| 0-10-1 | FALSE | n/a | ITU-I | 0 | No application can be assigned for SI=0. TFCs are processed, replicated and sent to an end office node, if an application is assigned to any other user part. UPUs are forwarded if the application specified by the affected SI is assigned. |
| | FALSE | n/a | | 1 | No application can be assigned for SI=1. |
| | FALSE | n/a | | 2 | No application can be assigned for SI=2. |
| | FALSE | NULL | | 3 | Distribute to local SCCP. |
| | TRUE | n/a | | 4 | TUP messages destined to the TSPC are forwarded to the end office node. |
| | FALSE | n/a | | 5 - 15 | Terminate with UPU. |

New Installation of VXI Behind a EAGLE 5 ISS with End Office Support

Figure 5-1 depicts a network in which a VXI node is deployed behind a EAGLE 5 ISS with End Office Support. Note that the VXI node resides in the IP network and shares the EAGLE 5 ISS's true point code. The PSTN views the EAGLE 5 ISS and VXI as one network element (one point code).

Figure 5-1. A EAGLE 5 ISS with End Office Support and VXI Node

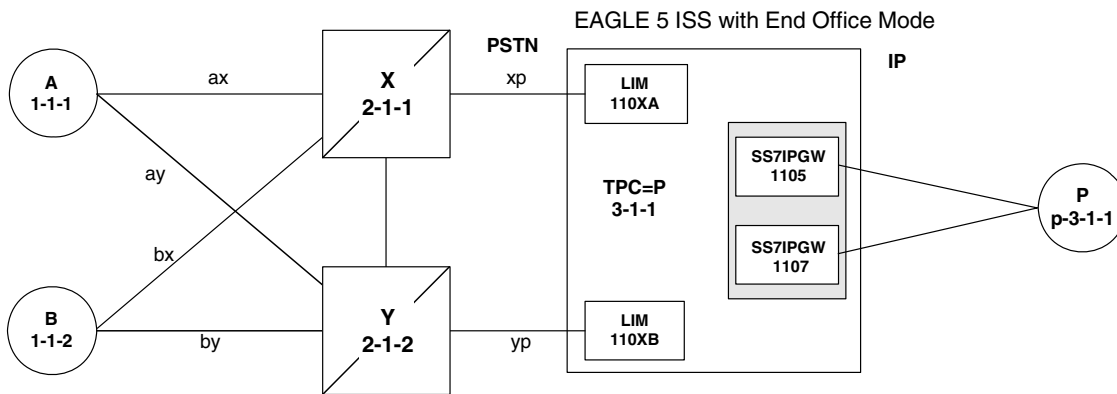

One Node Migrates from PSTN to IP

Figure 5-2 and Figure 5-3 depict the migration of a signaling end point from the PSTN to an IP network using the EAGLE 5 ISS with the End Office Support feature.

Figure 5-2. Network Before a EAGLE 5 ISS with End Office, Node P is to Migrate

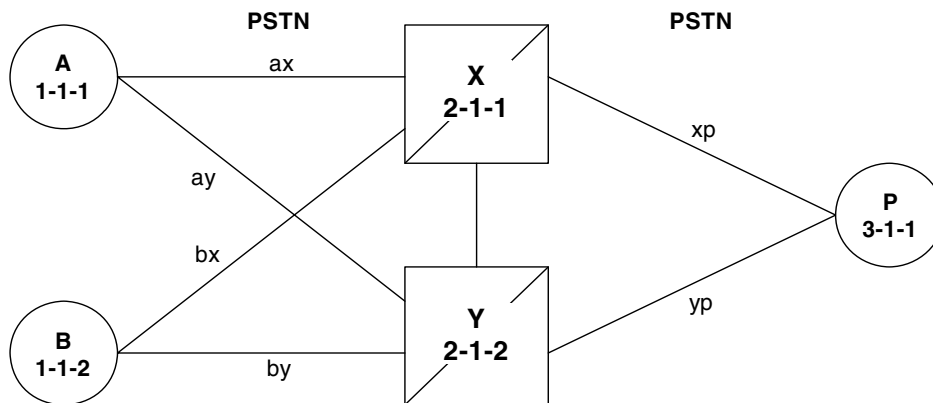
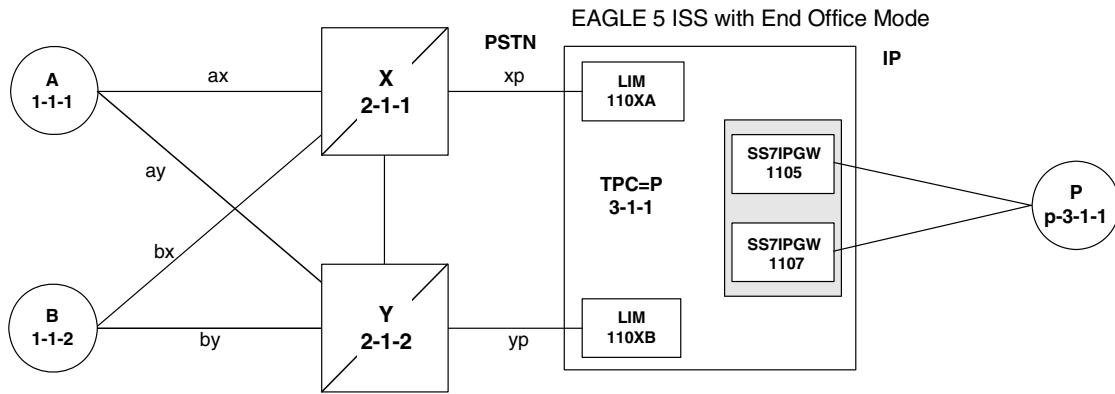

Figure 5-3. Network After a EAGLE 5 ISS with End Office, Node P has Migrated



In Figure 5-3 the EAGLE 5 ISS no longer acts like a signaling transfer point, but rather acts like a signaling end point that has an IP-attached application user-part. The EAGLE 5 ISS and the IP network element share the point code P. All messages received by the EAGLE 5 ISS should be destined to P and all messages sent to the PSTN from the EAGLE 5 ISS have an OPC of P.

A Signaling End Point is Added to a Deployed EAGLE 5 ISS Using End Office

Another possible scenario for the End Office feature is that a customer has a deployed EAGLE 5 ISS with attached IP nodes, and wants to make use of the End Office feature to add a new IP node. Consider the following network diagrams, Figure 5-4 and Figure 5-5.

Figure 5-4. Original Network with Deployed EAGLE 5 ISS

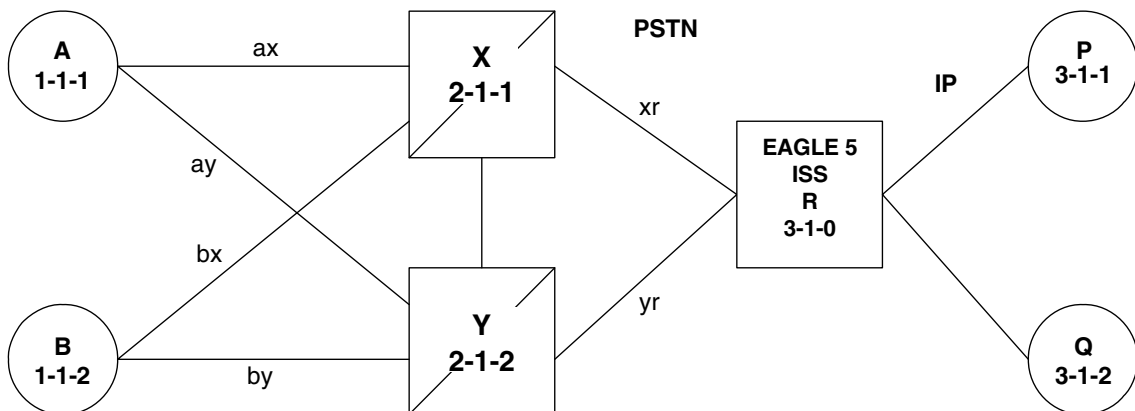
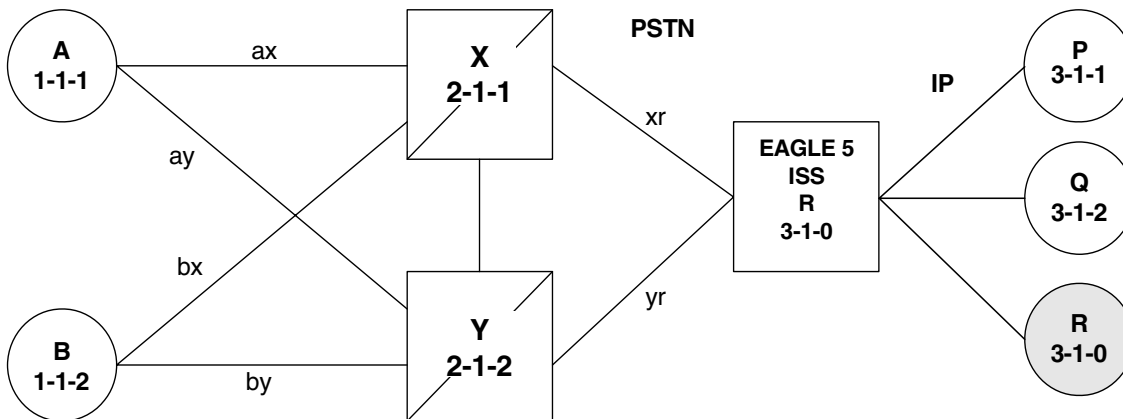

Figure 5-5. New Network with a EAGLE 5 ISS Using End Office and End Node R



In Figure 5-5 the customer saves a point code by using the End Office feature and making the new IP network element an end office node. No change is required in the PSTN or at P or Q. Non-network-management and non-test messages destined to R are now forwarded to an IP network element, rather than terminated by the EAGLE 5 ISS.

Two Signaling End Points Move from PSTN to IP Using End Office

A more complex scenario arises when multiple signaling end points are to migrate from the PSTN to an IP network using the End Office feature. Consider Figure 5-6 and Figure 5-7.

Figure 5-6. Network before Two Signaling End Points Migrate from PSTN to IP

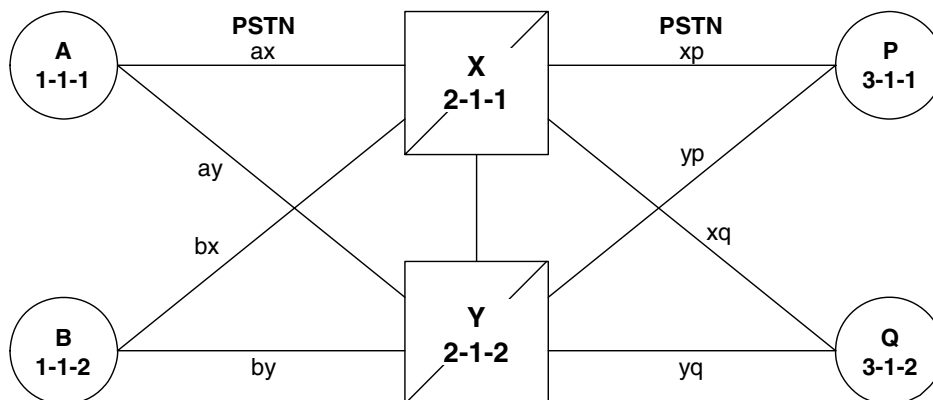
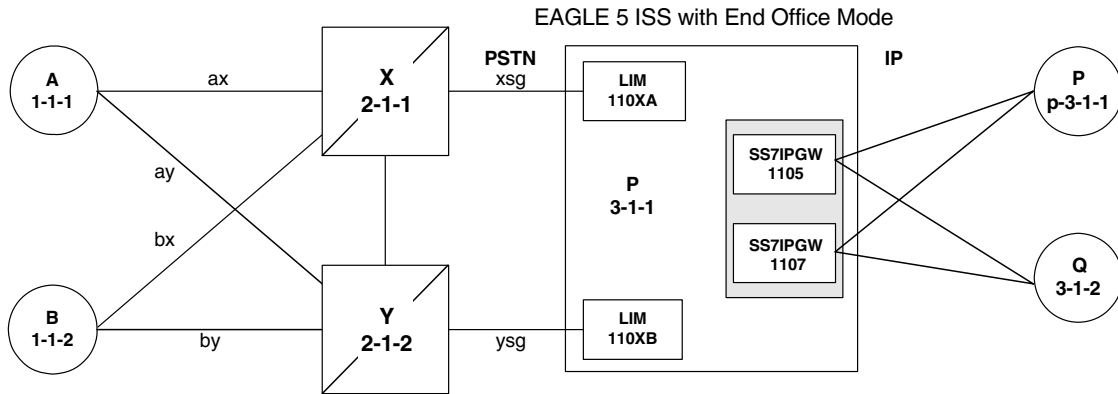

Figure 5-7. Network after Two Signaling End Points Migrate from PSTN to IP



In Figure 5-7, P is an end office node, and so P serves as the adjacent point code for nodes X and Y. The following are key points about this figure:

- Q is not an end office node, and so the EAGLE 5 ISS behaves as an STP for messages originated by and destined to Q.
- Reprovisioning is required in the PSTN, since the Q is now behind P. One example of this is that the linksets between X and Q and between Y and Q must change.
- Traffic between P and Q are no longer routed through X/Y, but are routed within the EAGLE 5 ISS.

The EAGLE 5 ISS Simultaneously Acts as STP and End Office

Figure 5-8 on page 5-10 depicts the EAGLE 5 ISS supporting three IP network elements, only one of which use the End Office feature, and two PSTN network elements. In addition, a capability point code is provisioned on the EAGLE 5 ISS, thereby allowing the use of GTT.

Figure 5-8. The EAGLE 5 ISS Simultaneously Acts as STP and End Office

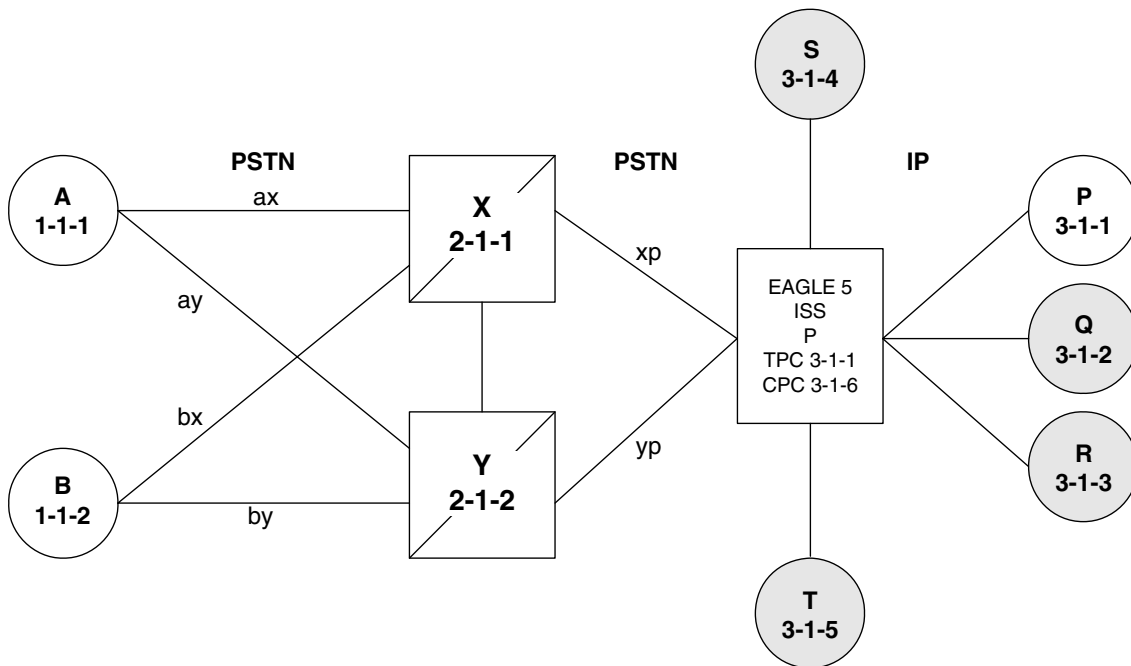

Notes regarding Figure 5-8:

- P is the end office node, and so the EAGLE 5 ISS TPC=P.
- Assume that end node P has an application assignment for SCCP.
- SCCP traffic destined to P is forwarded to the IP node via the SS7IPGW application.
- SCCP traffic destined to the CPC is distributed to the EAGLE 5 ISS's local SCCP application (e.g. GTT).
- Network elements Q, R, S, and T are not end office nodes, and so the EAGLE 5 ISS generates TFX network management concerning them.
- IP Network element P is an end office node, and so the EAGLE 5 ISS generates only UPU/SSP concerning it.

The EAGLE 5 ISS Supports Multiple Network Types and Multiple Hosts as an End Node

In Figure 5-9 on page 5-11 the EAGLE 5 ISS supports an end office node for each of the three network types. Each end office node comprises multiple IP network elements. The IP network elements are distinguished by the remote host and remote port values of the IP network elements (IP address parameters).

Figure 5-9. Three Multiple-Element End Office Nodes

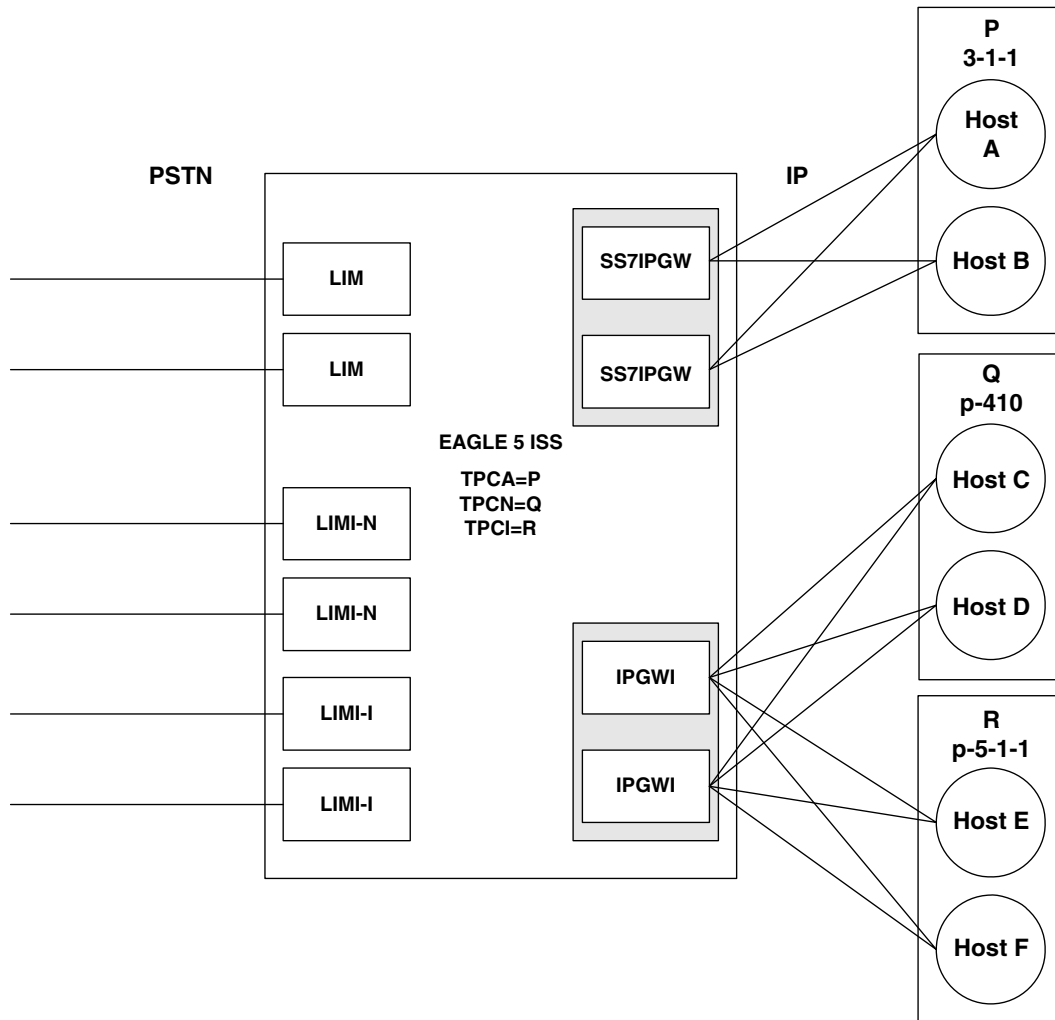

Mated Pair Supports Two End Office Nodes

Figure 5-10 depicts a mated pair of EAGLE 5 ISSs with each EAGLE 5 ISS supporting an End Office Node. Note that EAGLE 5 ISS P lacks IP links to IPNE-Q and EAGLE 5 ISS Q lacks IP links to IPNE-P, since such links would conflict with the C-links of linkset pq.

Figure 5-10. Mated Pair Supports Two End Office Nodes

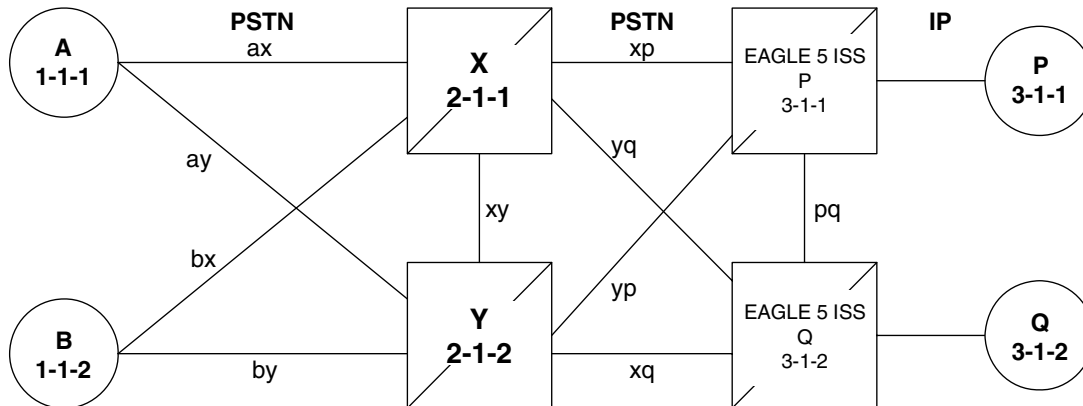

Figure 5-10 shows that a mated pair of EAGLE 5 ISSs cannot share an End Office Node. Each EAGLE 5 ISS requires its own unique point code and so any attached End Office Nodes share those point codes. It would be possible for a single IP network element to act as both P and Q (have IP connections to both EAGLE 5 ISS P and EAGLE 5 ISS Q). This configuration, however, would not provide true redundancy. Messages destined to P are terminated either at EAGLE 5 ISS P or IPNE-P, and message destined to Q are terminated either at EAGLE 5 ISS Q or IPNE-Q. Should the IP link between EAGLE 5 ISS P and IPNE-P fail, this feature provides no way for EAGLE 5 ISS P to forward messages to the End Office Node using the linkset **pq** (the linkset between systems P and Q).

End Office Support Configuration

In addition to the internal point code provisioned in the database with the “Adding an End Node Internal Point Code” procedure on page 5-14, these entities must be configured in the database to support the End Office feature.

- The internal point code must be in the destination point code table - go to the “Adding a Destination Point Code” procedure in the *Database Administration Manual - SS7*.
- An SS7 route to the internal point code - go to either the “Adding a Route containing an SS7 DPC” or “Adding a Route Containing an IPGWx Linkset” procedure in the *Database Administration Manual - SS7*.
- Signaling links assigned to the cards running either the SS7IPGW or IPGWI applications - “Adding an IP Signaling Link” procedure on page 3-84.
- Sockets or associations (with the corresponding ASPs and application servers):
 - “Adding an Application Socket” procedure on page 3-181
 - “Adding an Association” procedure on page 3-327
 - “Removing an Association from an Application Server” procedure on page 3-441
- Routing key matching the user part specified in the “Adding an End Node Internal Point Code” procedure and with the DPC of the routing key equal to the true point code of the EAGLE 5 ISS (shown in the `rtrv-sid` output) - See either the “Adding a Routing Key Containing a Socket” procedure on page 3-233 or the “Adding a Routing Key Containing an Application Server” procedure on page 3-250.

Adding an End Node Internal Point Code

This procedure is used to assign user parts to an internal point code (IPC), and thereby to an end office node using the `ent-rmt-app1` command. An internal point code is assigned to remote applications.

Only one IPC value for each network type can be configured. If you are adding an IPC value of the same network type as an existing IPC (for example, adding an ANSI IPC when the `rtrv-rmt-app1` output contains an ANSI IPC), the IPC value must be the same as the existing IPC value.

The `ent-rmt-app1` command uses these parameters:

`:ipc/ipca/ipci/ipcn/ipcn24` – The end node's internal point code can be an ANSI (`ipc/ipca`), ITU-I or ITU-I spare (`ipci`), 14-bit ITU-N or 14-bit ITU-N spare (`ipcn`), or 24-bit ITU-N (`ipcn24`) point code.

NOTE: The point code value can also be either a private (`p-`) or a private spare (`ps-`) point code, but does not have to be a private or private spare point code. Any point code can be a private point code. Only ITU-I or 14-bit ITU-N point codes can be private spare point codes. The point code value must be shown in the `rtrv-dstn` command output.

NOTE: The EAGLE 5 ISS can contain 14-bit ITU-N point codes or 24-bit ITU-N point codes, but not both at the same time.

`:si` – The service indicator value designates which MSU user part is being assigned to a remote application. Valid values range from 3 to 15.

`:ssn` – The SCCP subsystem number parameter. This parameter is required if the `si=3` parameter is specified and is not valid for any other `si` value. If the `ssne` parameter is also specified, then the `ssn` parameter serves as the starting value of a range. Valid values range from 0 to 255.

`:ssne` – The SCCP subsystem number range end parameter. The `ssne` value can be specified only if the `si=3` parameter is specified and is not valid for any other `si` value. This parameter serves as an end of a range, and so must be greater than the `ssn` parameter value. Valid values range from 1 to 255.

The specified assignment cannot be an existing assignment, including SSN subsets.

Procedure

1. Display a report listing the remote application assignments using the `rtrv-rmt-app1` command. This is an example of possible output:

```
rlghncxa03w 06-10-28 09:12:36 GMT EAGLE5 36.0.0
  IPCA          SI  SSN
  003-003-003   3  100, 110-119, 200
                5
```

End Office Support

```

IPCI                SI SSN
p-3-003-3          3 5, 50-100, 250
                    5

```

```

IPCN                SI SSN

```

```

IPCN24             SI SSN

```

2. Display the current destination point codes, using the `rtrv-dstn` command. This is an example of the possible output.

```

rlghncxa03w 06-10-17 16:02:05 GMT EAGLE5 36.0.0
DPCA          CLLI          BEI  ELEI  ALIASI          ALIASN          DOMAIN
003-003-003  -----          yes  ---  -----          -----          SS7
030-045-*    rlghncbb010  yes  yes  -----          -----          SS7
111-011-*    rlghncbb000  yes  yes  -----          -----          SS7
240-012-004  rlghncbb001  yes  ---  1-111-1          2500             SS7
240-012-005  rlghncbb002  yes  ---  1-112-2          1357             SS7
240-012-006  rlghncbb003  yes  ---  1-112-3          4257             SS7
240-012-008  -----          yes  ---  1-113-5          6939             SS7
244-020-004  ls06ccli     yes  ---  -----          -----          X25
244-020-005  ls07ccli     yes  ---  -----          -----          X25
244-020-006  ls08ccli     yes  ---  -----          -----          X25
244-020-007  -----          yes  ---  -----          -----          X25
244-020-008  -----          yes  ---  -----          -----          X25
p-003-003-003 -----          yes  ---  -----          -----          SS7

DPCI          CLLI          BEI  ELEI  ALIASA          ALIASN/N24      DOMAIN
2-131-1      rlghncbb023  no   ---  222-210-000    10789           SS7
2-131-2      -----          no   ---  222-211-001    1138            SS7
2-131-3      -----          no   ---  222-211-002    1298            SS7
p-3-003-3    -----          no   ---  -----          -----          SS7

DPCN          CLLI          BEI  ELEI  ALIASA          ALIASI          DOMAIN
7701         rlghncbb013  no   ---  222-200-200    2-121-1         SS7
11038       rlghncbb013  no   ---  222-200-201    2-121-2         SS7
p-16380     -----          no   ---  -----          -----          SS7

DPCN24       CLLI          BEI  ELEI  ALIASA          ALIASI          DOMAIN

DESTINATION ENTRIES ALLOCATED:  2000
FULL DPC(s) :                   17
EXCEPTION DPC(s) :               0
NETWORK DPC(s) :                 0
CLUSTER DPC(s) :                 2
TOTAL DPC(s) :                   19
CAPACITY (% FULL) :              1%
ALIASES ALLOCATED:              12000
ALIASES USED:                   18
CAPACITY (% FULL) :              1%
X-LIST ENTRIES ALLOCATED:       500

```

If the IPC being added to the database is not shown in the `rtrv-dstn` output, go to the “Adding a Destination Point Code” procedure in the *Database Administration Manual - SS7* and add the IPC to the DPC table.

3. Add the remote application assignments using the `ent-rmt-appl` command. For this example, enter these commands.

```
ent-rmt-appl:ipcn=p-16380:si=3:ssn=250
ent-rmt-appl:ipcn=p-16380:si=5
ent-rmt-appl:ipca=003-003-003:si=13
ent-rmt-appl:ipca=003-003-003:si=3:ssn=50:ssne=75
```

When each of these commands have successfully completed, the following message should appear.

```
rlghncxa03w 06-10-28 09:12:36 GMT EAGLE5 36.0.0
ENT-RMT-APPL: MASP A - COMPLTD;
```

4. Verify the changes using the `rtrv-rmt-appl` command. This is an example of possible output:

```
rlghncxa03w 06-10-28 09:12:36 GMT EAGLE5 36.0.0
  IPCA                SI SSN
  003-003-003        3 50-75, 100, 110-119, 200
                    5
                    13

  IPCI                SI SSN
  p-3-003-3          3 5, 50-100, 250
                    5

  IPCN                SI SSN
  p-16380            3 250
                    5

  IPCN24             SI SSN
```

5. Back up the new changes, using the `chg-db:action=backup:dest=fixed` command. These messages should appear; the active Maintenance and Administration Subsystem Processor (MASP) appears first.

```
BACKUP (FIXED) : MASP A - Backup starts on active MASP.
BACKUP (FIXED) : MASP A - Backup on active MASP to fixed disk complete.
BACKUP (FIXED) : MASP A - Backup starts on standby MASP.
BACKUP (FIXED) : MASP A - Backup on standby MASP to fixed disk complete.
```

Flowchart 5-1. Adding an End Node Internal Point Code

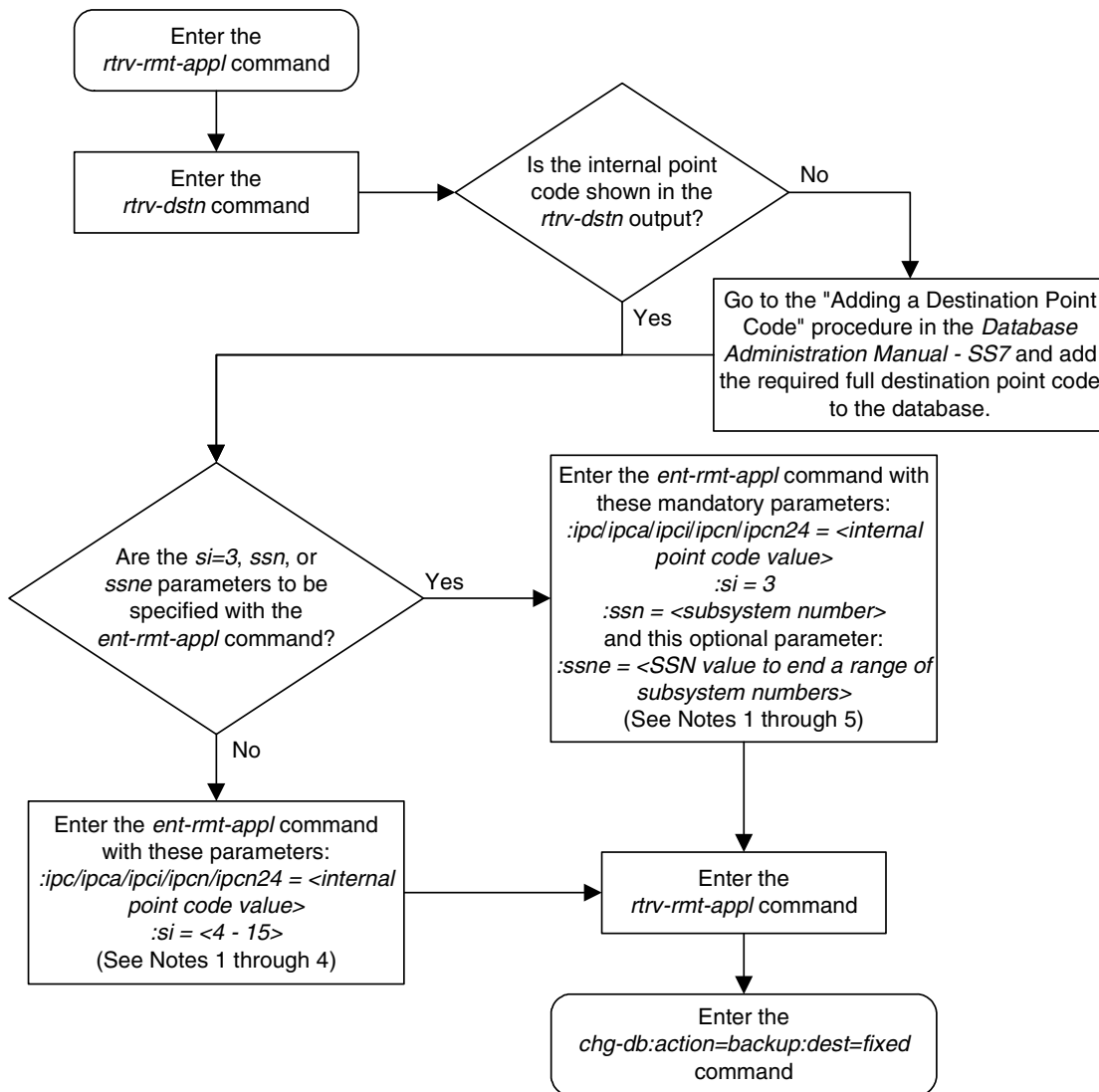

- Notes:
1. If the *ipc* or *ipca* parameter is specified, only a full point code value can be specified.
 2. The EAGLE 5 ISS can contain 14-bit ITU-N point codes or 24-bit ITU-N point codes, but not both at the same time.
 3. The point code value can be a non-spare, non-private, spare (s-), private (p-) or a private spare (ps-) point code, but does not have to be a spare, private, or private spare point code. Any point code can be a private point code. Only ITU-I or 14-bit ITU-N point codes can be private spare point codes or spare point codes. The point code value must be shown in the *rtrv-dstn* command output.
 4. Only one IPC value for each network type can be configured. If you are adding an IPC value of the same network type as an existing IPC (for example, adding an ANSI IPC when the *rtrv-rmt-appl* output contains an ANSI IPC), the IPC value must be the same as the existing IPC value.
 5. The *ssn* parameter value cannot be greater than the *ssne* parameter value.

Removing an End Node Internal Point Code

The `dlt-rmt-app1` command is used to remove remote application assignments from the database.

The `dlt-rmt-app1` command uses these parameters:

:ipc/ipca/ipci/ipcn/ipcn24 – The end node's internal point code can be an ANSI, ANSI private (**ipc/ipca**), ITU-I, ITU-I spare, ITU-I private spare (**ipci**), 14-bit ITU-N, 14-bit ITU-N spare, 14-bit ITU-N private spare (**ipcn**), or 24-bit ITU-N, or 24-bit ITU-N private (**ipcn24**) point code.

:si – The service indicator value designates which MSU user part is being assigned to a remote application. Valid values range from 3 to 15.

:ssn – The SCCP subsystem number parameter. This parameter is required if the **si=3** parameter is specified and is not valid for any other **si** value. If the **ssne** parameter is also specified, then the **ssn** parameter serves as the starting value of a range. Valid values range from 0 to 255.

:ssne – The SCCP subsystem number range end parameter. The **ssne** value can be specified only if the **si=3** parameter is specified and is not valid for any other **si** value. This parameter serves as an end of a range, and so must be greater than the **ssn** parameter value. Valid values range from 1 to 255.

Procedure

1. Display a report listing the remote application assignments using the `rtrv-rmt-app1` command. This is an example of possible output:

```
rlghncxa03w 06-10-28 09:12:36 GMT EAGLE5 36.0.0
  IPCA          SI  SSN
  003-003-003   3  50-75, 100, 110-119, 200
                5
                13

  IPCI          SI  SSN
  p-3-003-3     3  5, 50-100, 250
                5

  IPCN          SI  SSN
  p-16380       3  250
                5

  IPCN24        SI  SSN
```

2. Delete remote application assignments using the `dlt-rmt-app1` command. For this example, enter these commands.

```
dlt-rmt-app1:ipca=003-003-003:si=3:ssn=100
```

```
dlt-rmt-app1:ipca=003-003-003:si=13
```

When each of these commands have successfully completed, the following message should appear.

```
rlghncxa03w 06-10-28 09:12:36 GMT EAGLE5 36.0.0  
DLT-RMT-APPL: MASP A - COMPLTD;
```

3. Verify the changes using the `rtrv-rmt-app1` command. This is an example of possible output:

```
rlghncxa03w 06-10-28 09:12:36 GMT EAGLE5 36.0.0  
  IPCA          SI  SSN  
  003-003-003   3  50-75, 110-119, 200  
                5  
  
  IPCI          SI  SSN  
  p-3-003-3     3  5, 50-100, 250  
                5  
  
  IPCN          SI  SSN  
  p-16380       3  250  
                5  
  
  IPCN24        SI  SSN
```

4. Back up the new changes, using the `chg-db:action=backup:dest=fixed` command. These messages should appear; the active Maintenance and Administration Subsystem Processor (MASP) appears first.

```
BACKUP (FIXED) : MASP A - Backup starts on active MASP.  
BACKUP (FIXED) : MASP A - Backup on active MASP to fixed disk complete.  
BACKUP (FIXED) : MASP A - Backup starts on standby MASP.  
BACKUP (FIXED) : MASP A - Backup on standby MASP to fixed disk complete.
```

Flowchart 5-2. Removing an End Node Internal Point Code

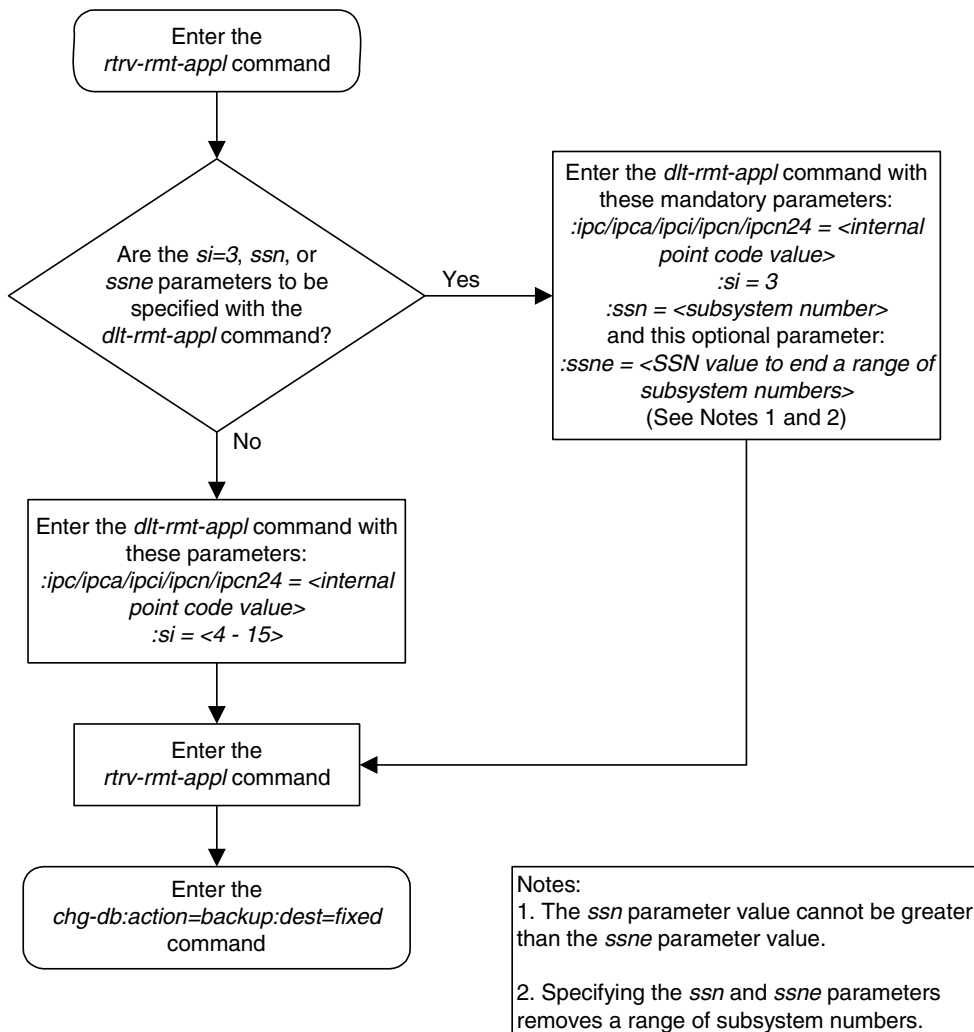

6

Activating Controlled Features

| | |
|---|------|
| Introduction..... | 6-2 |
| Enabling Controlled Features | 6-2 |
| Enabling a Permanent or Temporary Key..... | 6-3 |
| Temporary Feature Keys..... | 6-7 |
| Turning On and Off Controlled Features..... | 6-10 |
| Turning On an Enabled Controlled Feature | 6-10 |
| Turning Off an Enabled Controlled Feature | 6-12 |

Introduction

Controlled features are features that are activated using a feature access key. These features can be either features that can be turned on or off, or features that operate at a particular performance level.

Enabling Controlled Features

The `enable-ctrl-feat` command is used to enable a controlled feature by entering the controlled feature's access key and the controlled feature's part number with these parameters:

- : fak** – The feature access key generated by Tekelec's feature access key generator, and supplied to you when you purchase or temporarily try a controlled feature. The feature access key contains 13 alphanumeric characters and is not case sensitive.
- : partnum** – The Tekelec-issued part number associated with the controlled feature. The part number is a 9-digit number, not including dashes; the first three digits must be 893 (that is, 893xxxxxx, where x is a numeric value).

The `enable-ctrl-feat` command requires that the database contain a valid serial number for the EAGLE 5 ISS, and that this serial number is locked. This can be verified with the `rtrv-serial-num` command. The EAGLE 5 ISS is shipped with a serial number in the database, but the serial number is not locked. The serial number can be changed, if necessary, and locked once the EAGLE 5 ISS is on-site, by using the `ent-serial-num` command. The `ent-serial-num` command uses these parameters.

- : serial** – The serial number assigned to the EAGLE 5 ISS. The serial number is not case sensitive.
- : lock** – Specifies whether or not the serial number is locked. This parameter has only one value, `yes`, which locks the serial number. Once the serial number is locked, it cannot be changed.

NOTE: To enter and lock the EAGLE 5 ISS's serial number, the `ent-serial-num` command must be entered twice, once to add the correct serial number to the database with the `serial` parameter, then again with the `serial` and the `lock=yes` parameters to lock the serial number. You should verify that the serial number in the database is correct before locking the serial number. The serial number can be found on a label affixed to the control shelf (shelf 1100).

Features can be enabled by entering a permanent feature access key. Some features can be tried or tested by entering a temporary feature access key. By requiring a feature access key to enable and activate a controlled feature, unauthorized enabling and activation of a controlled feature can be prevented.

Activating Controlled Features

Features enabled with a permanent feature access key remain enabled for as long as the EAGLE 5 ISS remains in service. Once features are permanently enabled, they cannot be disabled.

Enabling a Permanent or Temporary Key

This procedure explains how to enable controlled features in the EAGLE 5 ISS by entering either a permanent feature access key or a temporary feature access key for the controlled features. This procedure uses the `enable-ctrl-feat`, and `ent-serial-num` commands.

If the temporary key is being enabled, it must not be in the *in-use*, *expired*, or *unavailable* state.

The examples in this procedure are used to enable the controlled features in Table 6-1.

Table 6-1. Sample Controlled Feature Part Numbers

| Feature Name | Part Number |
|-----------------------|-------------|
| ISUP Normalization | 893000201 |
| ETSI v3 Normalization | 893000601 |

Procedure

1. Display the serial number in the database with the `rtrv-serial-num` command. This is an example of the possible output.

```
rlghncxa03w 06-10-28 21:15:37 GMT EAGLE5 36.0.0
System serial number = nt00001231
```

```
System serial number is not locked.
```

```
rlghncxa03w 06-10-28 21:15:37 GMT EAGLE5 36.0.0
Command Completed
```

NOTE: If the serial number is correct and locked, skip steps 2, 3, and 4, and go to step 5. If the serial number is correct but not locked, skip steps 2 and 3, and go to step 4. If the serial number is not correct, but is locked, this feature cannot be enabled and the remainder of this procedure cannot be performed. Contact the Customer Care Center to get an incorrect and locked serial number changed. Refer to "Customer Care Center" on page 1-9 for the contact information. The serial number can be found on a label affixed to the control shelf (shelf 1100).

2. Enter the correct serial number into the database using the **ent-serial-num** command with the **serial** parameter.

For this example, enter this command.

```
ent-serial-num:serial=<EAGLE 5 ISS's correct serial number>
```

When this command has successfully completed, the following message should appear.

```
rlghncxa03w 06-10-28 21:15:37 GMT EAGLE5 36.0.0
ENT-SERIAL-NUM: MASP A - COMPLTD
```

3. Verify that the serial number entered into step 2 was entered correctly using the **rtrv-serial-num** command. This is an example of the possible output.

```
rlghncxa03w 06-10-28 21:15:37 GMT EAGLE5 36.0.0
System serial number = nt00001231
```

System serial number is not locked.

```
rlghncxa03w 06-10-28 21:15:37 GMT EAGLE5 36.0.0
Command Completed
```

If the serial number was not entered correctly, repeat steps 3 and 4 and re-enter the correct serial number.

4. Lock the serial number in the database by entering the **ent-serial-num** command with the serial number shown in step 1, if the serial number shown in step 1 is correct, or with the serial number shown in step 3, if the serial number was changed in step 2, and with the **lock=yes** parameter.

For this example, enter this command.

```
ent-serial-num:serial=<EAGLE 5 ISS's serial number>:lock=yes
```

When this command has successfully completed, the following message should appear.

```
rlghncxa03w 06-10-28 21:15:37 GMT EAGLE5 36.0.0
ENT-SERIAL-NUM: MASP A - COMPLTD
```

5. Display an update of all of the controlled features that have been purchased and all of the temporary keys that have been issued by entering the **rtrv-ctrl-feat** command. The following is an example of the possible output.

```
rlghncxa03w 06-10-28 21:15:37 GMT EAGLE5 36.0.0
The following features have been permanently enabled:
```

| Feature Name | Partnum | Status | Quantity |
|---------------------|-----------|--------|----------|
| IPGWx Signaling TPS | 893012814 | on | 20000 |
| HC-MIM SLK Capacity | 893012707 | on | 64 |

The following features have been temporarily enabled:

| Feature Name | Partnum | Status | Quantity | Trial Period Left |
|---------------------|---------|--------|----------|-------------------|
| Zero entries found. | | | | |

The following features have expired temporary keys:

| Feature Name | Partnum |
|---------------------|---------|
| Zero entries found. | |

Activating Controlled Features

6. Enable the purchased permanent key or temporary key for controlled features being enabled by entering the **enable-ctrl-feat** command. For this example, enter this command using the part numbers shown in Table 6-1 on page 6-3.

```
enable-ctrl-feat:partnum=893000201:fak=<feature access key>
```

```
enable-ctrl-feat:partnum=893000601:fak=<feature access key>
```

NOTE: The values for the feature access key (the **fak** parameter) are provided by Tekelec. If you do not have the controlled feature part number or the feature access key for the feature you wish to enable, contact your Tekelec Sales Representative or Account Representative.

When the **enable-ctrl-feat** command has successfully completed, this message should appear.

```
rlghncxa03w 06-10-28 21:15:37 GMT EAGLE5 36.0.0
ENABLE-CTRL-FEAT: MASP B - COMPLTD
```

7. Verify the changes by entering the **rtrv-ctrl-feat** command. The following is an example of the possible output.

```
rlghncxa03w 06-10-28 21:15:37 GMT EAGLE5 36.0.0
The following features have been permanently enabled:
```

| Feature Name | Partnum | Status | Quantity |
|-----------------------|-----------|--------|----------|
| IPGWx Signaling TPS | 893012814 | on | 20000 |
| ISUP Normalization | 893000201 | off | ---- |
| ETSI v3 Normalization | 893000601 | off | ---- |
| HC-MIM SLK Capacity | 893012707 | on | 64 |

The following features have been temporarily enabled:

| Feature Name | Partnum | Status | Quantity | Trial Period Left |
|---------------------|---------|--------|----------|-------------------|
| Zero entries found. | | | | |

The following features have expired temporary keys:

| Feature Name | Partnum |
|---------------------|---------|
| Zero entries found. | |

8. Back up the new changes using the **chg-db:action=backup:dest=fixed** command. These messages should appear, the active Maintenance and Administration Subsystem Processor (MASP) appears first.

```
BACKUP (FIXED) : MASP A - Backup starts on active MASP.
BACKUP (FIXED) : MASP A - Backup on active MASP to fixed disk complete.
BACKUP (FIXED) : MASP A - Backup starts on standby MASP.
BACKUP (FIXED) : MASP A - Backup on standby MASP to fixed disk complete.
```

9. If the controlled features enabled in step 4 are On/Off features, the features must be turned on using the **chg-ctrl-feat** command. Specify the controlled feature part number used in step 4 and the **status=on** parameter. For this example, enter these commands. Go to the procedure in "Turning On and Off Controlled Features" on page 6-10 to turn each feature on.
-

Flowchart 6-1. Enabling a Permanent or Temporary Key

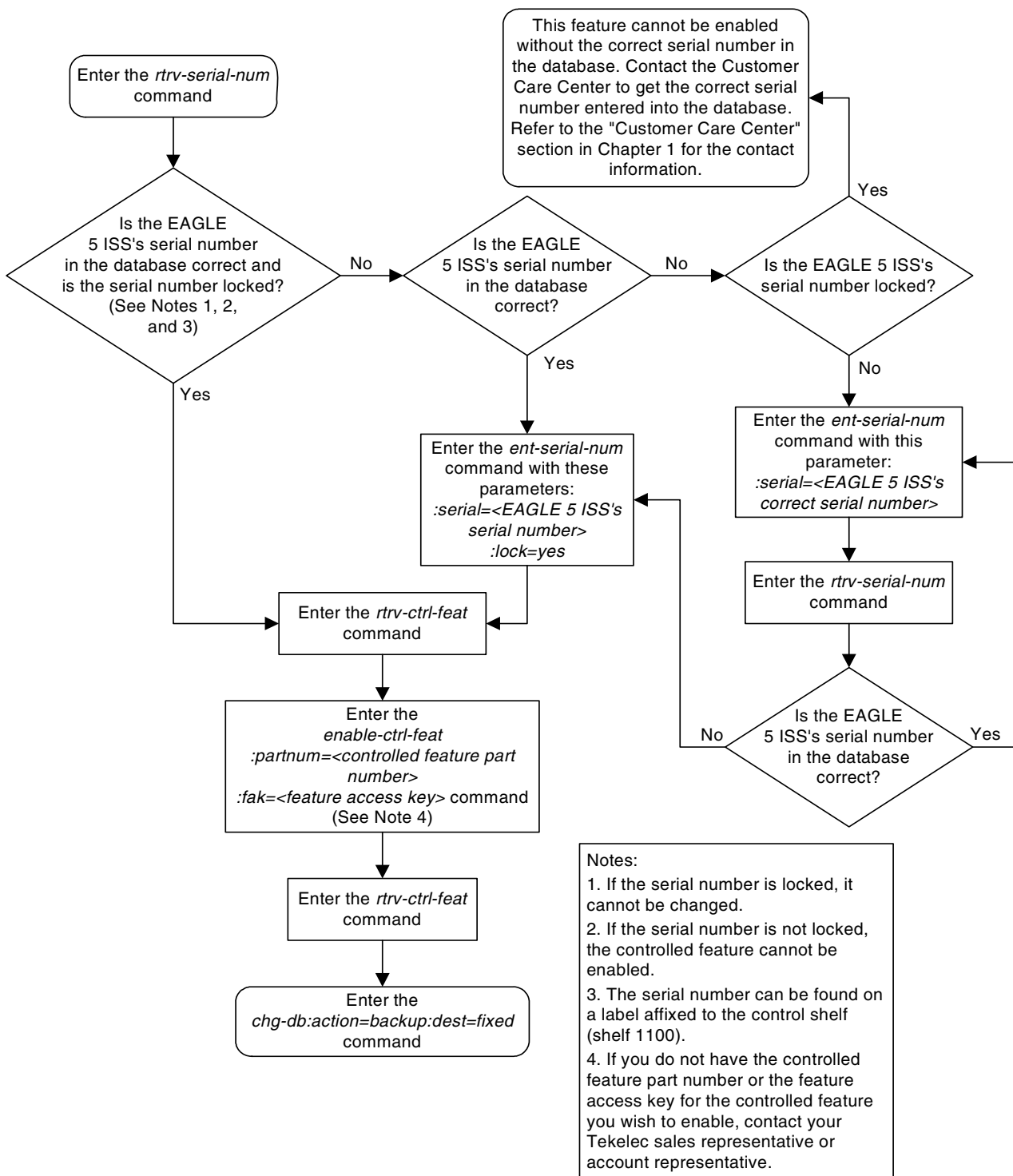

Activating Controlled Features

Temporary Feature Keys

Features enabled with a temporary feature access key are enabled for only 30 days. On the twenty-third day, seven days before the temporary key expires, a major alarm (UAM 0367) is generated to inform the user that the one or more temporary feature access keys will expire soon.

```
0367.0181 ** SYSTEM      Temp Key(s) expiring soon.
```

If a temporary feature access key expires, the controlled feature is disabled and a critical alarm (UAM 0368) is generated.

```
0368.0181 *C SYSTEM      Temp Key(s) have expired.
```

Any attempts to enable the controlled feature with the temporary feature access key are rejected. The controlled feature can be enabled only by entering the permanent feature access key for the controlled feature.

To clear the critical alarm (UAM 0368), the user can either enter the **chg-ctrl-feat** command with the **alarm=clear** parameter, or permanently enable the controlled feature by entering the permanent feature access key for the controlled feature.

If the critical alarm is cleared with the **chg-ctrl-feat** command, the controlled feature is disabled and cannot be enabled with the temporary feature access key. The feature can be enabled only by entering the permanent feature access key for the controlled feature.

Clearing a Temporary Feature Access Key Alarm

This procedure is used to clear the EAGLE 5 ISS alarms using the **chg-ctrl-feat** command after a temporary feature access key has expired.

NOTE: The alarm is cleared when no temporary feature access keys are in danger of expiration or in an *expired* state.

The **chg-ctrl-feat** command uses the following parameters:

:partnum - The part number of the controlled feature that was temporarily enabled and is causing the alarm.

:alarm - Clear. Specifying **clear** for this parameter clears the alarm.

The following dependencies apply to this procedure:

The controlled feature part number must be valid. It must match the part number of the temporary controlled feature that is causing the alarm.

The controlled feature must have been temporarily enabled and is now in danger of expiration or in an *expired* state.

Procedure

1. Display enabled controlled feature information that is causing the EAGLE 5 ISS alarm in the database by entering the **rtrv-ctrl-feat:expired=yes** command. The following is an example of the possible output.

```
rlghncxa03w 06-10-28 21:17:37 GMT EAGLE5 36.0.0
The following features have expired temporary keys:
Feature Name          Partnum
ISUP Normalization    893000201
```

2. Clear the EAGLE 5 ISS alarm in the database by entering the **chg-ctrl-feat** command. For example, enter this command.

chg-ctrl-feat:partnum=893000201:alarm=clear

When this command has successfully completed, the following message should appear.

```
rlghncxa03w 06-10-30 21:16:37 GMT EAGLE5 36.0.0
CHG-CTRL-FEAT: MASP A - COMPLTD
```

3. Verify that the alarm has cleared in the database by using the **rtrv-ctrl-feat:expired=yes** command. The following is an example of the possible output.

```
rlghncxa03w 06-10-28 21:16:37 GMT EAGLE5 36.0.0
0367.0181 * SYSTEM      Temp Key(s) expiration alarm cleared.
```

4. Back up the changes using the **chg-db:action=backup:dest=fixed** command. These messages should appear, the active Maintenance and Administration Subsystem Processor (MASP) appears first.

```
BACKUP (FIXED) : MASP A - Backup starts on active MASP.
BACKUP (FIXED) : MASP A - Backup on active MASP to fixed disk complete.
BACKUP (FIXED) : MASP A - Backup starts on standby MASP.
BACKUP (FIXED) : MASP A - Backup on standby MASP to fixed disk complete.
```

Activating Controlled Features

Flowchart 6-2. Clearing a Temporary Feature Access Key Alarm

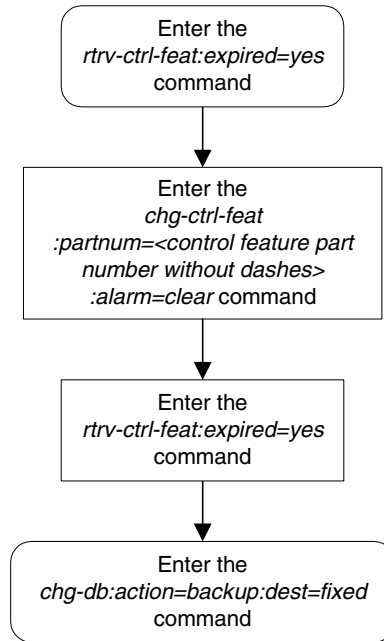

Turning On and Off Controlled Features

Some controlled features must be turned on after they are enabled, and can be turned off without disabling them in the EAGLE 5 ISS. The **chg-ctrl-feat** command is used to turn the features on and off, and to clear the critical alarm that occurs when a temporary feature key expires (see “Temporary Feature Keys” on page 6-7).

The **chg-ctrl-feat** command uses the following parameters:

- :partnum** – The Tekelec-issued part number associated with the controlled feature. The part number is a 9-digit number, not including dashes; the first three digits must be 893 (that is, 893xxxxxx, where x is a numeric value).
- :status** – Changes the activation status of the feature (On or Off).
- :alarm=clear** – Use only to clear the critical alarm that is generated when a temporary feature key expires.

The part number that you enter must be for an On/Off feature that has already been enabled with the **enable-ctrl-feat** command (see “Enabling Controlled Features” on page 6-2).

Turning On an Enabled Controlled Feature

This procedure allows the user to turn on enabled controlled features in the EAGLE 5 ISS, by using the **chg-ctrl-feat** command.

The **chg-ctrl-feat** command uses these parameters:

- :partnum** – The Tekelec-issued part number associated with the controlled feature. The part number is a 9-digit number, not including dashes. The first three digits must be 893 (that is, 893xxxxxx, where x is a numeric value).
- :status** – used to activate the controlled features that customer has purchased and enabled.

The examples in this procedure are used to enable and activate the controlled features in Table 6-2.

Table 6-2. Sample Controlled Feature Part Numbers

| Feature Name | Part Number |
|-----------------------|-------------|
| ISUP Normalization | 893000201 |
| ETSI v3 Normalization | 893000601 |

Procedure

1. Enter the **rtrv-ctrl-feat** command to display the status of the controlled features in the EAGLE 5 ISS. The following is an example of the possible output.

```
rlghncxa03w 06-10-28 21:15:37 GMT EAGLE5 36.0.0
The following features have been permanently enabled:
```

| Feature Name | Partnum | Status | Quantity |
|-----------------------|-----------|--------|----------|
| IPGWx Signaling TPS | 893012814 | on | 20000 |
| ISUP Normalization | 893000201 | off | ---- |
| ETSI v3 Normalization | 893000601 | off | ---- |
| HC-MIM SLK Capacity | 893012707 | on | 64 |

The following features have been temporarily enabled:

| Feature Name | Partnum | Status | Quantity | Trial Period Left |
|---------------------|---------|--------|----------|-------------------|
| Zero entries found. | | | | |

The following features have expired temporary keys:

| Feature Name | Partnum |
|---------------------|---------|
| Zero entries found. | |

2. The controlled features listed in Table 6-2 on page 6-10 must be turned on using the **chg-ctrl-feat** command, specifying the controlled feature part number used to enable the feature and the **status=on** parameter. For this example, enter these commands.

```
chg-ctrl-feat:partnum=893000201:status=on
```

```
chg-ctrl-feat:partnum=893000601:status=on
```

When this command has successfully completed, the following message should appear.

```
rlghncxa03w 06-10-28 21:15:37 GMT EAGLE5 36.0.0
CHG-CTRL-FEAT: MASP B - COMPLTD
```

3. Verify the changes by entering the **rtrv-ctrl-feat** command. The following is an example of the possible output.

```
rlghncxa03w 06-10-28 21:15:37 GMT EAGLE5 36.0.0
The following features have been permanently enabled:
```

| Feature Name | Partnum | Status | Quantity |
|-----------------------|-----------|--------|----------|
| IPGWx Signaling TPS | 893012814 | on | 20000 |
| ISUP Normalization | 893000201 | on | ---- |
| ETSI v3 Normalization | 893000601 | on | ---- |
| HC-MIM SLK Capacity | 893012707 | on | 64 |

The following features have been temporarily enabled:

| Feature Name | Partnum | Status | Quantity | Trial Period Left |
|---------------------|---------|--------|----------|-------------------|
| Zero entries found. | | | | |

The following features have expired temporary keys:

| Feature Name | Partnum |
|---------------------|---------|
| Zero entries found. | |

- Back up the new changes using the `chg-db:action=backup:dest=fixed` command. These messages should appear, the active Maintenance and Administration Subsystem Processor (MASP) appears first.

```

BACKUP (FIXED) : MASP A - Backup starts on active MASP.
BACKUP (FIXED) : MASP A - Backup on active MASP to fixed disk complete.
BACKUP (FIXED) : MASP A - Backup starts on standby MASP.
BACKUP (FIXED) : MASP A - Backup on standby MASP to fixed disk complete.
    
```

Flowchart 6-3. Turning On an Enabled Controlled Feature

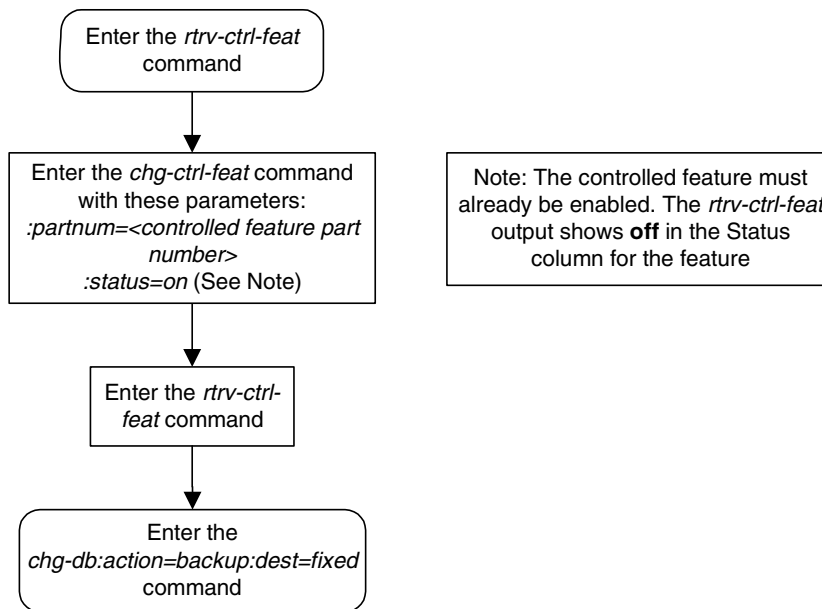

Turning Off an Enabled Controlled Feature

Some controlled features that have been enabled and turned on can be turned off without disabling them in the EAGLE 5 ISS. This procedure allows the user to turn off enabled controlled features in the EAGLE 5 ISS, by using the `chg-ctrl-feat` command.



CAUTION: Refer to the Feature Notice or the appropriate feature manual to determine the results of turning a feature off. For example, you might use a feature to add entries to a database table. When the feature is turned off after entries have been added to the table, the commands to delete and retrieve the entries might still function, but the commands to enter or change entries no longer function.

Activating Controlled Features

The **chg-ctrl-feat** command uses these parameters:

:partnum – The Tekelec-issued part number associated with the controlled feature. The part number is a 9-digit number, not including dashes. The first three digits must be 893 (that is, 893xxxxxx, where x is a numeric value).

:status – used to activate the controlled features that customer has purchased and enabled.

The examples in this procedure are used to enable and activate the controlled features in Table 6-3.

Table 6-3. Sample Controlled Feature Part Numbers

| Feature Name | Part Number |
|-----------------------|-------------|
| ISUP Normalization | 893000201 |
| ETSI v3 Normalization | 893000601 |

Procedure

1. Enter the **rtrv-ctrl-feat** command to display the status of the controlled features in the EAGLE 5 ISS. The following is an example of the possible output.

```
rlghncxa03w 06-10-28 21:15:37 GMT EAGLE5 36.0.0
The following features have been permanently enabled:
```

| Feature Name | Partnum | Status | Quantity |
|-----------------------|-----------|--------|----------|
| IPGWx Signaling TPS | 893012814 | on | 20000 |
| ISUP Normalization | 893000201 | on | ---- |
| ETSI v3 Normalization | 893000601 | on | ---- |
| HC-MIM SLK Capacity | 893012707 | on | 64 |

```
The following features have been temporarily enabled:
```

| Feature Name | Partnum | Status | Quantity | Trial Period Left |
|---------------------|---------|--------|----------|-------------------|
| Zero entries found. | | | | |

```
The following features have expired temporary keys:
```

| Feature Name | Partnum |
|---------------------|---------|
| Zero entries found. | |

2. The controlled features listed in Table 6-2 on page 6-10 are turned on using the **chg-ctrl-feat** command, specifying the controlled feature part number used to enable the feature and the **status=off** parameter. For this example, enter these commands.

```
chg-ctrl-feat:partnum=893000201:status=off
```

```
chg-ctrl-feat:partnum=893000601:status=off
```

When this command has successfully completed, the following message should appear.

```
rlghncxa03w 06-10-28 21:15:37 GMT EAGLE5 36.0.0
CHG-CTRL-FEAT: MASP B - COMPLTD
```

- Verify the changes by entering the `rtrv-ctrl-feat` command. The following is an example of the possible output.

```
rlghncxa03w 06-10-28 21:15:37 GMT EAGLE5 36.0.0
The following features have been permanently enabled:
```

| Feature Name | Partnum | Status | Quantity |
|-----------------------|-----------|--------|----------|
| IPGWx Signaling TPS | 893012814 | on | 20000 |
| ISUP Normalization | 893000201 | off | ---- |
| ETSI v3 Normalization | 893000601 | off | ---- |
| HC-MIM SLK Capacity | 893012707 | on | 64 |

The following features have been temporarily enabled:

| Feature Name | Partnum | Status | Quantity | Trial Period Left |
|---------------------|---------|--------|----------|-------------------|
| Zero entries found. | | | | |

The following features have expired temporary keys:

| Feature Name | Partnum |
|---------------------|---------|
| Zero entries found. | |

- Back up the new changes using the `chg-db:action=backup:dest=fixed` command. These messages should appear, the active Maintenance and Administration Subsystem Processor (MASP) appears first.

```
BACKUP (FIXED) : MASP A - Backup starts on active MASP.
BACKUP (FIXED) : MASP A - Backup on active MASP to fixed disk complete.
BACKUP (FIXED) : MASP A - Backup starts on standby MASP.
BACKUP (FIXED) : MASP A - Backup on standby MASP to fixed disk complete.
```

Flowchart 6-4. Turning Off an Enabled Controlled Feature

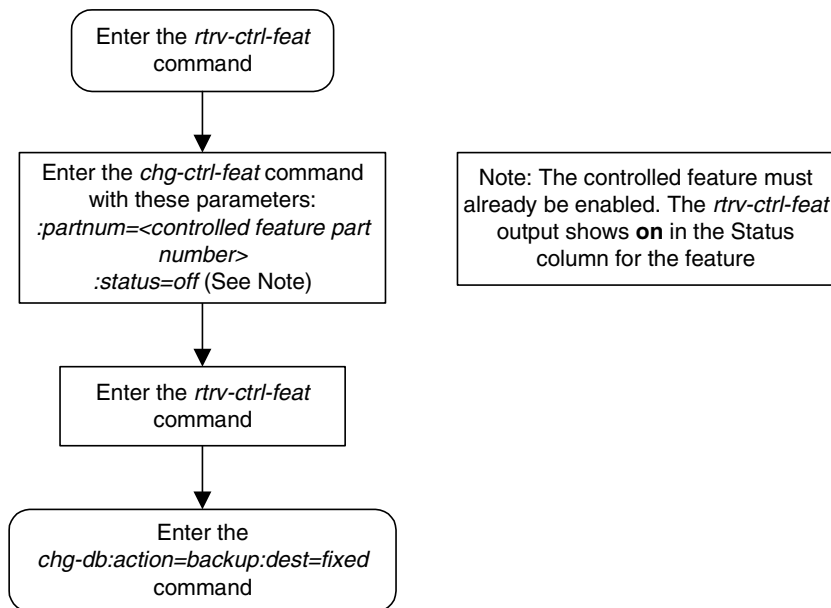

Index

Numerics

- 1500 Signaling Links, 3-104
- 2000 Signaling Links, 3-104

A

- acronyms, 1-14
- activate signaling link, act-slk
 - IPGWI, 3-75, 3-127, 3-144, 3-167, 3-189, 3-190, 3-211, 3-212, 3-333, 3-337, 3-362, 3-368
 - IPLIM, 3-75, 3-127, 3-144
 - SS7IPGW, 3-75, 3-127, 3-144, 3-167, 3-189, 3-190, 3-211, 3-212, 3-333, 3-337, 3-362, 3-368
- Adding an Application Socket, 3-181
- Adding an IP Host, 3-153
- alw, 3-202
- appl, 3-4
- Applications, 2-3, 2-4

C

- cancel
 - rtrv-dstn, 3-41
 - rtrv-ls, 3-41
- Changing a DCM Parameter Set, 3-226
- Changing an Application Socket, 3-202
- Changing an IP Card, 3-37, 3-161
- Changing an IP Link, 3-135
- Changing an IP7 Secure Gateway Option, 3-37
- cice, 3-234, 3-251, 3-273, 3-283, 3-284, 3-296, 3-304
- cics, 3-234, 3-251, 3-272, 3-273, 3-283, 3-296, 3-304
- Clearing a Temporary FAK alarm, 6-7
- C-link linkset, 3-7
- Configuring a Mate IPGWx Linkset, 3-63
- Configuring an IPGWx Linkset, 3-37
- Configuring IP Retransmission Parameters, 3-220
- Connectivity, 2-21, 2-22

Controlled Feature

- Large System # Links - Enabling, 3-104
- Customer Care Center, 1-9

D

- database partitions
 - overview, 1-11
- dcm, 3-4
- DCM parameter set, 3-3
- dcmps, 3-202
- Default Routing Keys, 2-27
- Display, 3-165
- display card status, rept-stat-card
 - IPGWI, 3-125, 3-140, 3-165
 - IPLIM, 3-140, 3-165
 - SS7IPGW, 3-125, 3-140, 3-165
- display signaling link status, rept-stat-slk
 - IPGWI, 3-124, 3-127, 3-139, 3-144, 3-163, 3-167, 3-188, 3-210, 3-332, 3-362, 3-466, 3-473
 - IPLIM, 3-127, 3-139, 3-144, 3-163, 3-466, 3-473
 - SS7IPGW, 3-124, 3-127, 3-139, 3-144, 3-163, 3-167, 3-189, 3-190, 3-211, 3-212, 3-333, 3-337, 3-363, 3-368, 3-466, 3-473
- documentation set, 1-8
- dpc, 3-272
- drkq, 3-130

E

- Emergency response, 1-10
- Enabling a Permanent or Temporary Key, 6-3
- Enabling the Large System # Links Controlled Feature, 3-104
- End node internal point codes, 3-4
- Errors - contacting the Customer Care Center, 1-9

F

fixed disk drive
 overview, 1-12
 Full Routing Keys, 2-26

G

getcomm, 3-130

I

in, 3-127, 3-167, 3-466, 3-473
 inhfepalm, 3-130
 internal point codes, 3-4
 IP application routing key, 3-3
 IP application servers, 3-4
 IP application socket, 3-3
 IP associations, 3-3
 IP card, 3-3
 IP host, 3-3
 IP link, 3-3
 IP options
 drkq, 3-130
 getcomm, 3-130
 inhfepalm, 3-130
 ipgwabate, 3-130
 iplimabate, 3-130
 sctpcsum, 3-130, 3-462, 3-486
 setcomm, 3-130
 snmpcont, 3-130
 srkq, 3-130
 sync, 3-123, 3-130
 trapcomm, 3-130
 IP protocol option, 3-123
 IP routes, 3-3
 IP7 Secure Gateway Options, 3-3
 ipgwabate, 3-130
 IPGWI
 activate signaling link, act-slk, 3-75,
 3-127, 3-144, 3-167, 3-189, 3-190,
 3-211, 3-212, 3-333, 3-337, 3-362, 3-368
 display card status,
 rept-stat-card, 3-125, 3-140, 3-165
 display signaling link status,
 rept-stat-slk, 3-124, 3-127, 3-139,
 3-144, 3-163, 3-167, 3-188, 3-210,
 3-332, 3-362, 3-466, 3-473

ipgwi, 2-4, 2-22

IPGWx Linkset
 Configuring, 3-37
 Mate - Configuring, 3-63

IPLIM

activate signaling link, act-slk, 3-75,
 3-127, 3-144
 display card status,
 rept-stat-card, 3-140, 3-165
 display signaling link status,
 rept-stat-slk, 3-127, 3-139, 3-144,
 3-163, 3-466, 3-473

iplim, 2-3

iplimabate, 3-130

iplimi, 2-3

ISUP Normalization, 2-40

ISUP variant provisioning, 3-4

L

Large System # Links Controlled Feature
 Enabling, 3-104

Linkset

IPGWx
 Configuring, 3-37
 Mate IPGWx - Configuring, 3-63

M

maintenance and administration subsystem
 overview, 1-10

manual

admonishments, 1-8
 organization, 1-2
 related publications, 1-3

Mate IPGWx Linkset - Configuring, 3-63

mated gateways, 3-7

N

Nagle's Algorithm, 2-39

ncice, 3-283, 3-296, 3-305

ncics, 3-283, 3-296, 3-305

Network appearances, 3-4

Index

O

opc/opca, 3-233, 3-234, 3-250, 3-272, 3-283,
3-295, 3-304
open, 3-202
overview
 database partitions, 1-11
 fixed disk drive, 1-12
 maintenance and administration
 subsystem, 1-10
 removable cartridge, 1-13

P

Partial Routing Keys, 2-27
Point-to-Multipoint, 2-22
Point-to-Point, 2-21
Problems - contacting the Customer Care
 Center, 1-9
PSTN presentation data, 3-4

R

removable cartridge
 overview, 1-13
removing
 signaling link, 3-113
Removing an Application Socket, 3-198
Removing an DCM, 3-28, 3-177
Removing an IP Card, 3-28, 3-177
Routing Key Lookup Hierarchy, 2-29
Routing Key Tables, 2-27

S

SCTP checksum algorithm option, 3-462,
3-486
sctpcsum, 3-130, 3-462, 3-486
server, 3-202
setcomm, 3-130
si, 3-272
signaling link
 removing, 3-113
signaling links, 1500, 3-104
signaling links, 2000, 3-104
sname, 3-272
snmpcont, 3-130
split, 3-283, 3-296, 3-305
srkq, 3-130

SS7IPGW

activate signaling link, act-slk, 3-75,
3-127, 3-144, 3-167, 3-189, 3-190,
3-211, 3-212, 3-333, 3-337, 3-362, 3-368
display card status,
 rept-stat-card, 3-125, 3-140, 3-165
display signaling link status,
 rept-stat-slk, 3-124, 3-127, 3-139,
3-144, 3-163, 3-167, 3-189, 3-190,
3-211, 3-212, 3-333, 3-337, 3-363,
3-368, 3-466, 3-473
ss7ipgw, 2-4, 2-22
ssn, 3-272
Support - contacting the Customer Care
 Center, 1-9
sync, 3-123, 3-130

T

Technical Assistance - contacting the
 Customer Care Center, 1-9
trapcomm, 3-130
turning On and Off Controlled
 Features, 6-10
Type of Service, 2-39

